

**APPENDIX C: PROBE AND DIPOLE CALIBRATION CERTIFICATES**



Accredited by the Swiss Accreditation Service (SAS)  
The Swiss Accreditation Service is one of the signatories to the EA  
Multilateral Agreement for the recognition of calibration certificates

Client **Element**  
**Morgan Hill, USA**

Certificate No. **CLA13-1004\_Nov24**

**CALIBRATION CERTIFICATE**

Object **CLA13 - SN: 1004** ✓ yw 11/19/24

Calibration procedure(s) **QA CAL-15.v11**  
**Calibration Procedure for SAR Validation Sources below 700 MHz**

Calibration date: **November 11, 2024**

This calibration certificate documents the traceability to national standards, which realize the physical units of measurements (SI).  
The measurements and the uncertainties with confidence probability are given on the following pages and are part of the certificate.

All calibrations have been conducted in the closed laboratory facility: environment temperature (22 ± 3)°C and humidity < 70%.

Calibration Equipment used (M&TE critical for calibration)

Primary Standards	ID #	Cal Date (Certificate No.)	Scheduled Calibration
Power meter NRP2	SN: 104778	26-Mar-24 (No. 217-04036/04037)	Mar-25
Power sensor NRP-Z91	SN: 103244	26-Mar-24 (No. 217-04036)	Mar-25
Power sensor NRP-Z91	SN: 103245	26-Mar-24 (No. 217-04037)	Mar-25
Reference 20 dB Attenuator	SN: CC2552 (20x)	26-Mar-24 (No. 217-04046)	Mar-25
Type-N mismatch combination	SN: 310982 / 06327	26-Mar-24 (No. 217-04047)	Mar-25
Reference Probe EX3DV4	SN: 3877	10-Jan-24 (No. EX3-3877_Jan24)	Jan-25
DAE4	SN: 654	18-Oct-24 (No. DAE4-654_Oct24)	Oct-25
Secondary Standards	ID #	Check Date (in house)	Scheduled Check
Power meter NRP2	SN: 107193	08-Nov-21 (in house check Dec-22)	In house check: Dec-24
Power sensor NRP-Z91	SN: 100922	15-Dec-09 (in house check Dec-22)	In house check: Dec-24
Power sensor NRP-Z91	SN: 100418	01-Jan-04 (in house check Dec-22)	In house check: Dec-24
RF generator HP 8648C	SN: US3642U01700	04-Aug-99 (in house check Jun-24)	In house check: Jun-26
Network Analyzer Agilent E8358A	SN: US41080477	31-Mar-14 (in house check Sep-24)	In house check: Sep-26

Calibrated by: **Krešimir Franjlić** Name: **Krešimir Franjlić** Function: **Laboratory Technician**

Approved by: **Sven Kühn** Name: **Sven Kühn** Function: **Technical Manager**

Signature

Issued: November 11, 2024

This calibration certificate shall not be reproduced except in full without written approval of the laboratory.



Accredited by the Swiss Accreditation Service (SAS)  
The Swiss Accreditation Service is one of the signatories to the EA  
Multilateral Agreement for the recognition of calibration certificates

**Glossary:**

TSL	tissue simulating liquid
ConvF	sensitivity in TSL / NORM x,y,z
N/A	not applicable or not measured

**Calibration is Performed According to the Following Standards:**

- a) IEC/IEEE 62209-1528, "Measurement Procedure For The Assessment Of Specific Absorption Rate Of Human Exposure To Radio Frequency Fields From Hand-Held And Body-Worn Wireless Communication Devices - Part 1528: Human Models, Instrumentation And Procedures (Frequency Range of 4 MHz to 10 GHz)", October 2020.
- b) KDB 865664, "SAR Measurement Requirements for 100 MHz to 6 GHz"

**Additional Documentation:**

- c) DASY System Handbook

**Methods Applied and Interpretation of Parameters:**

- *Measurement Conditions:* Further details are available from the Validation Report at the end of the certificate. All figures stated in the certificate are valid at the frequency indicated.
- *Antenna Parameters with TSL:* The source is mounted in a touch configuration below the center marking of the flat phantom.
- *Return Loss:* This parameter is measured with the source positioned under the liquid filled phantom (as described in the measurement condition clause). The Return Loss ensures low reflected power. No uncertainty required.
- *SAR measured:* SAR measured at the stated antenna input power.
- *SAR normalized:* SAR as measured, normalized to an input power of 1 W at the antenna connector.
- *SAR for nominal TSL parameters:* The measured TSL parameters are used to calculate the nominal SAR result.

The reported uncertainty of measurement is stated as the standard uncertainty of measurement multiplied by the coverage factor  $k=2$ , which for a normal distribution corresponds to a coverage probability of approximately 95%.

## Measurement Conditions

DASY system configuration, as far as not given on page 1.

DASY Version	DASY5	V52.10.4
Extrapolation	Advanced Extrapolation	
Phantom	ELI4 Flat Phantom	Shell thickness: $2 \pm 0.2$ mm
EUT Positioning	Touch Position	
Zoom Scan Resolution	$dx, dy = 4.0$ mm, $dz = 1.4$ mm	Graded Ratio = 1.4 (Z direction)
Frequency	$13$ MHz $\pm 1$ MHz	

## Head TSL parameters

The following parameters and calculations were applied.

	Temperature	Permittivity	Conductivity
Nominal Head TSL parameters	$22.0$ °C	55.0	0.75 mho/m
Measured Head TSL parameters	$(22.0 \pm 0.2)$ °C	$53.1 \pm 6$ %	$0.72$ mho/m $\pm 6$ %
Head TSL temperature change during test	$< 0.5$ °C	----	----

## SAR result with Head TSL

SAR averaged over $1$ cm <sup>3</sup> (1 g) of Head TSL	Condition	
SAR measured	1 W input power	0.561 W/kg
SAR for nominal Head TSL parameters	normalized to 1W	<b>0.575 W/kg <math>\pm 18.4</math> % (k=2)</b>

SAR averaged over $10$ cm <sup>3</sup> (10 g) of Head TSL	condition	
SAR measured	1 W input power	0.346 W/kg
SAR for nominal Head TSL parameters	normalized to 1W	<b>0.355 W/kg <math>\pm 18.0</math> % (k=2)</b>

**Appendix (Additional assessments outside the scope of SCS 0108)**

**Antenna Parameters with Head TSL**

Impedance, transformed to feed point	56.5 $\Omega$ - 0.6 j $\Omega$
Return Loss	- 24.3 dB

**Additional EUT Data**

Manufactured by	SPEAG
-----------------	-------

# DASY5 Validation Report for Head TSL

Date: 11.11.2024

Test Laboratory: SPEAG, Zurich, Switzerland

**DUT: CLA13; Type: CLA13; Serial: CLA13 - SN: 1004**

Communication System: UID 0 - CW; Frequency: 13 MHz

Medium parameters used:  $f = 13 \text{ MHz}$ ;  $\sigma = 0.72 \text{ S/m}$ ;  $\epsilon_r = 53.1$ ;  $\rho = 1000 \text{ kg/m}^3$

Phantom section: Flat Section

Measurement Standard: DASY5 (IEEE/IEC/ANSI C63.19-2007)

DASY52 Configuration:

- Probe: EX3DV4 - SN3877; ConvF(15.33, 15.33, 15.33) @ 13 MHz; Calibrated: 10.01.2024
- Sensor-Surface: 1.4mm (Mechanical Surface Detection)
- Electronics: DAE4 Sn654; Calibrated: 18.10.2024
- Phantom: ELI v6.0; Type: QDOVA003AA; Serial: TP:2034
- DASY52 52.10.4(1535); SEMCAD X 14.6.14(7501)

**CLA Calibration for HSL-LF Tissue/CLA-13, touch configuration, Pin=1W/Zoom Scan, dist=1.4mm (8x10x8)/Cube 0:** Measurement grid: dx=4mm, dy=4mm, dz=1.4mm

Reference Value = 31.58 V/m; Power Drift = 0.00 dB

Peak SAR (extrapolated) = 1.18 W/kg

**SAR(1 g) = 0.561 W/kg; SAR(10 g) = 0.346 W/kg**

Smallest distance from peaks to all points 3 dB below = 16.5 mm

Ratio of SAR at M2 to SAR at M1 = 77.3%

Maximum value of SAR (measured) = 0.835 W/kg

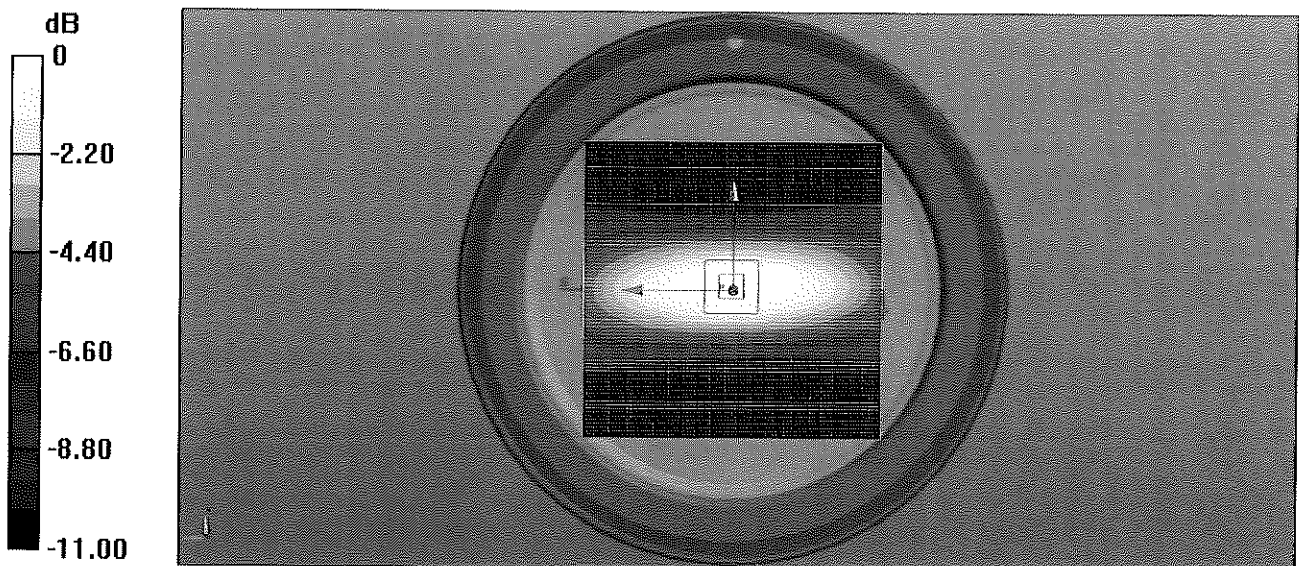

0 dB = 0.835 W/kg = -0.78 dBW/kg

# Impedance Measurement Plot for Head TSL

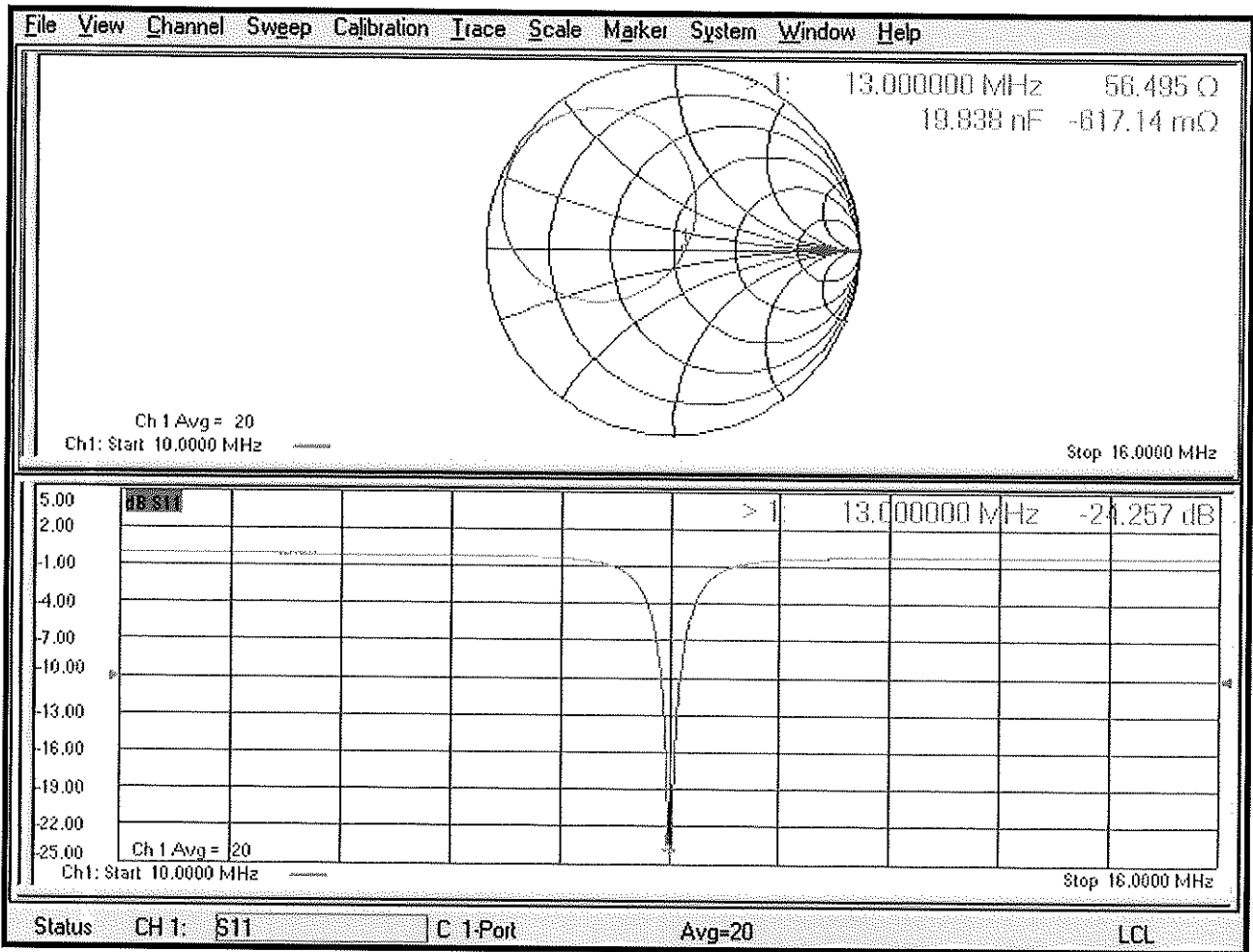



Accredited by the Swiss Accreditation Service (SAS)  
The Swiss Accreditation Service is one of the signatories to the EA  
Multilateral Agreement for the recognition of calibration certificates

Accreditation No.: **SCS 0108**

Client

**Element**  
Morgan Hill, USA

Certificate No.

**D750V3-1057\_May25**

**CALIBRATION CERTIFICATE**

Object **D750V3 - SN: 1057**

Calibration procedure(s) **QA CAL-05.v12**  
**Calibration Procedure for SAR Validation Sources between 0.7 - 3 GHz**

Calibration date **May 9, 2025**

*ATM*  
*05/30/2025*

This calibration certificate documents the traceability to national standards, which realize the physical units of measurements (SI).  
The measurements and the uncertainties with confidence probability are given on the following pages and are part of the certificate.  
All calibrations have been conducted in the closed laboratory facility: environment temperature (22 ± 3)°C and humidity < 70%.  
Calibration Equipment used (M&TE critical for calibration)

Primary Standards	ID	Cal Date (Certificate No.)	Scheduled Cal
Power Sensor R&S NRP-33T	SN: 100967	26-Mar-25 (No. 217-04290)	Mar-26
Power Sensor R&S NRP18A	SN: 101859	06-Feb-25 (No. 4030A315009541)	Feb-26
Spectrum Analyzer R&S FSV40	SN: 101832	29-Jan-25 (No. 4030A315009658)	Jan-26
3.5mm mismatch combination	SN: 1152	24-Mar-25 (No. 217-04293)	Mar-26
OCP DAK-12	SN: 1016	24-Sept-24 (No. OCP-DAK12-1016_Sep24)	Sep-25
OCP DAK-3.5	SN: 1249	23-Sept-24 (No. OCP-DAK3.5-1249_Sep24)	Sep-25
Reference Probe EX3DV4	SN: 7349	10-Jan-25 (No. EX3-7349_Jan25)	Jan-26
DAE4ip	SN: 1836	17-Apr-25 (No. DAE4ip-1836_Apr25)	Apr-26

Secondary Standards	ID	Check Date (in house)	Scheduled Check
ACAD Setup 1	SN: 1000	28-May-24 (No. 675-ACAD_Source_Box-240528)	May-25
Signal Generator R&S SMB100A	SN: 182081	28-May-24 (No. 675-CAL16-S4588-240528)	May-25
Mismatch; SMA	SN: 1102	22-May-24 (No. 675-Mismatch_SMA-240522)	May-25

	Name	Function	Signature
Calibrated by	Paulo Pina	Laboratory Technician	
Approved by	Sven Kühn	Technical Manager	
			Issued: May 9, 2025
This calibration certificate shall not be reproduced except in full without written approval of the laboratory.			





Accredited by the Swiss Accreditation Service (SAS)  
The Swiss Accreditation Service is one of the signatories to the EA  
Multilateral Agreement for the recognition of calibration certificates

Accreditation No.: **SCS 0108**

## Glossary

TSL tissue simulating liquid  
ConvF sensitivity in TSL / NORM x,y,z  
N/A not applicable or not measured

## Calibration is Performed According to the Following Standards

- IEC/IEEE 62209-1528, "Measurement Procedure For The Assessment Of Specific Absorption Rate Of Human Exposure To Radio Frequency Fields From Hand-Held And Body-Worn Wireless Communication Devices - Part 1528: Human Models, Instrumentation And Procedures (Frequency Range of 4 MHz to 10 GHz)", October 2020.
- KDB 865664, "SAR Measurement Requirements for 100 MHz to 6 GHz"

## Additional Documentation

- DASY System Handbook

## Methods Applied and Interpretation of Parameters

- *Measurement Conditions*: Further details are available from the Validation Report at the end of the certificate. All figures stated in the certificate are valid at the frequency indicated.
- *Antenna Parameters with TSL*: The dipole is mounted with the spacer to position its feed point exactly below the center marking of the flat phantom section, with the arms oriented parallel to the body axis.
- *Feed Point Impedance and Return Loss*: These parameters are measured with the dipole positioned under the liquid filled phantom. The impedance stated is transformed from the measurement at the SMA connector to the feed point. The Return Loss ensures low reflected power. No uncertainty required.
- *Electrical Delay*: One-way delay between the SMA connector and the antenna feed point. No uncertainty required.
- *SAR measured*: SAR measured at the stated antenna input power.
- *SAR normalized*: SAR as measured, normalized to an input power of 1 W at the antenna connector.
- *SAR for nominal TSL parameters*: The measured TSL parameters are used to calculate the nominal SAR result.

The reported uncertainty of measurement is stated as the standard uncertainty of measurement multiplied by the coverage factor  $k=2$ , which for a normal distribution corresponds to a coverage probability of approximately 95%.

## Measurement Conditions

DASY system configuration, as far as not given on page 1.

DASY Version	DASY8 Module SAR	16.4.0
Extrapolation	Advanced Extrapolation	
Phantom	Modular Flat Phantom	
Distance Dipole Center - TSL	15 mm	with spacer
Zoom Scan Resolution	dx, dy = 6mm, dz = 1.5mm	Graded Ratio = 1.5 mm (Z direction)
Frequency	750MHz $\pm$ 1MHz	

## HSL parameters at 750 MHz

The following parameters and calculations were applied.

	Temperature	Permittivity	Conductivity
Nominal HSL parameters	22.0 °C	41.9	0.890 mho/m
Measured HSL parameters	(22.0 $\pm$ 0.2)°C	42.7 $\pm$ 6%	0.910 mho/m $\pm$ 6%
HSL temperature change during test	< 0.5 °C		

## SAR result with HSL at 750 MHz

SAR averaged over 1 cm <sup>3</sup> (1 g) of HSL	Condition	
SAR for nominal HSL parameters	24 dBm input power	2.21 W/kg
SAR for nominal HSL parameters	normalized to 1W	8.80 W/kg $\pm$ 17.0% (k = 2)

SAR averaged over 10 cm <sup>3</sup> (10 g) of HSL	Condition	
SAR for nominal HSL parameters	24 dBm input power	1.44 W/kg
SAR for nominal HSL parameters	normalized to 1W	5.73 W/kg $\pm$ 16.5% (k = 2)

**MSL parameters at 750 MHz**

The following parameters and calculations were applied.

	Temperature	Permittivity	Conductivity
Nominal MSL parameters	22.0 °C	55.5	0.960 mho/m
Measured MSL parameters	(22.0 ±0.2)°C	55.5 ±6%	0.970 mho/m ±6%
MSL temperature change during test	< 0.5 °C		

**SAR result with MSL at 750 MHz**

SAR averaged over 1 cm <sup>3</sup> (1 g) of MSL	Condition	
SAR for nominal MSL parameters	24 dBm input power	2.24 W/kg
SAR for nominal MSL parameters	normalized to 1W	8.92 W/kg ±17.0% (k = 2)

SAR averaged over 10 cm <sup>3</sup> (10 g) of MSL	Condition	
SAR for nominal MSL parameters	24 dBm input power	1.47 W/kg
SAR for nominal MSL parameters	normalized to 1W	5.85 W/kg ±16.5% (k = 2)

**Appendix (Additional assessments outside the scope of SCS 0108)****Antenna Parameters with HSL at 750 MHz**

Impedance	52.6 $\Omega$ – 0.8 j $\Omega$
Return Loss	-31.4 dB

**Antenna Parameters with MSL at 750 MHz**

Impedance	48.2 $\Omega$ – 3.3 j $\Omega$
Return Loss	-28.3 dB

**General Antenna Parameters and Design**

Electrical Delay (one direction)	1.038 ns
----------------------------------	----------

After long term use with 100W radiated power, only a slight warming of the dipole near the feedpoint can be measured. The dipole is made of standard semirigid coaxial cable. The center conductor of the feeding line is directly connected to the second arm of the dipole. The antenna is therefore short-circuited for DC-signals. On some of the dipoles, small end caps are added to the dipole arms in order to improve matching when loaded according to the position as explained in the "Measurement Conditions" paragraph. The SAR data are not affected by this change. The overall dipole length is still according to the Standard. No excessive force must be applied to the dipole arms, because they might bend or the soldered connections near the feedpoint may be damaged.

**Additional EUT Data**

Manufactured by	SPEAG
-----------------	-------

**System Performance Check Report**

**Summary**

Dipole	Frequency [MHz]	TSL	Power [dBm]
D750V3 - SN1057	750	HSL	24

**Exposure Conditions**

Phantom Section, TSL	Test Distance [mm]	Band	Group, UID	Frequency [MHz], Channel Number	Conversion Factor	TSL Conductivity [S/m]	TSL Permittivity
Flat	15	CW, 0--		750, 0	9.55	0.91	42.7

**Hardware Setup**

Phantom	TSL, Measured Date	Probe, Calibration Date	DAE, Calibration Date
Flat V4.9 mod	HSL, 2025-05-09	EX3DV4 - SN7349, 2025-01-10	DAE4lp Sn1836, 2025-04-17

**Scans Setup**

	Zoom Scan
Grid Extents [mm]	30 x 30 x 30
Grid Steps [mm]	6.0 x 6.0 x 1.5
Sensor Surface [mm]	1.4
Graded Grid	Yes
Grading Ratio	1.5
MAIA	N/A
Surface Detection	VMS + 6p
Scan Method	Measured

**Measurement Results**

	Zoom Scan
Date	2025-05-09
psSAR1g [W/Kg]	2.21
psSAR10g [W/Kg]	1.44
Power Drift [dB]	-0.01
Power Scaling	Disabled
Scaling Factor [dB]	
TSL Correction	Positive / Negative

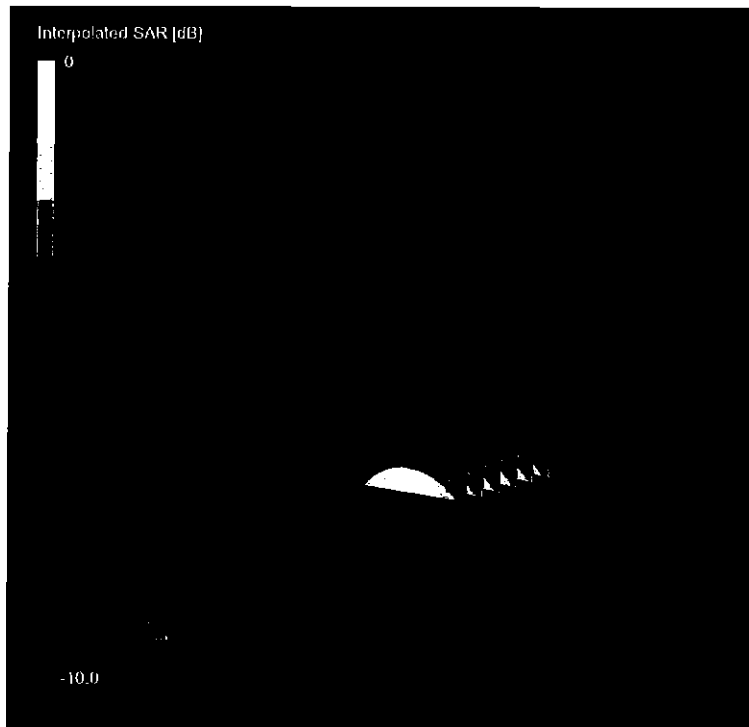

### Impedance Measurement Plot for HSL

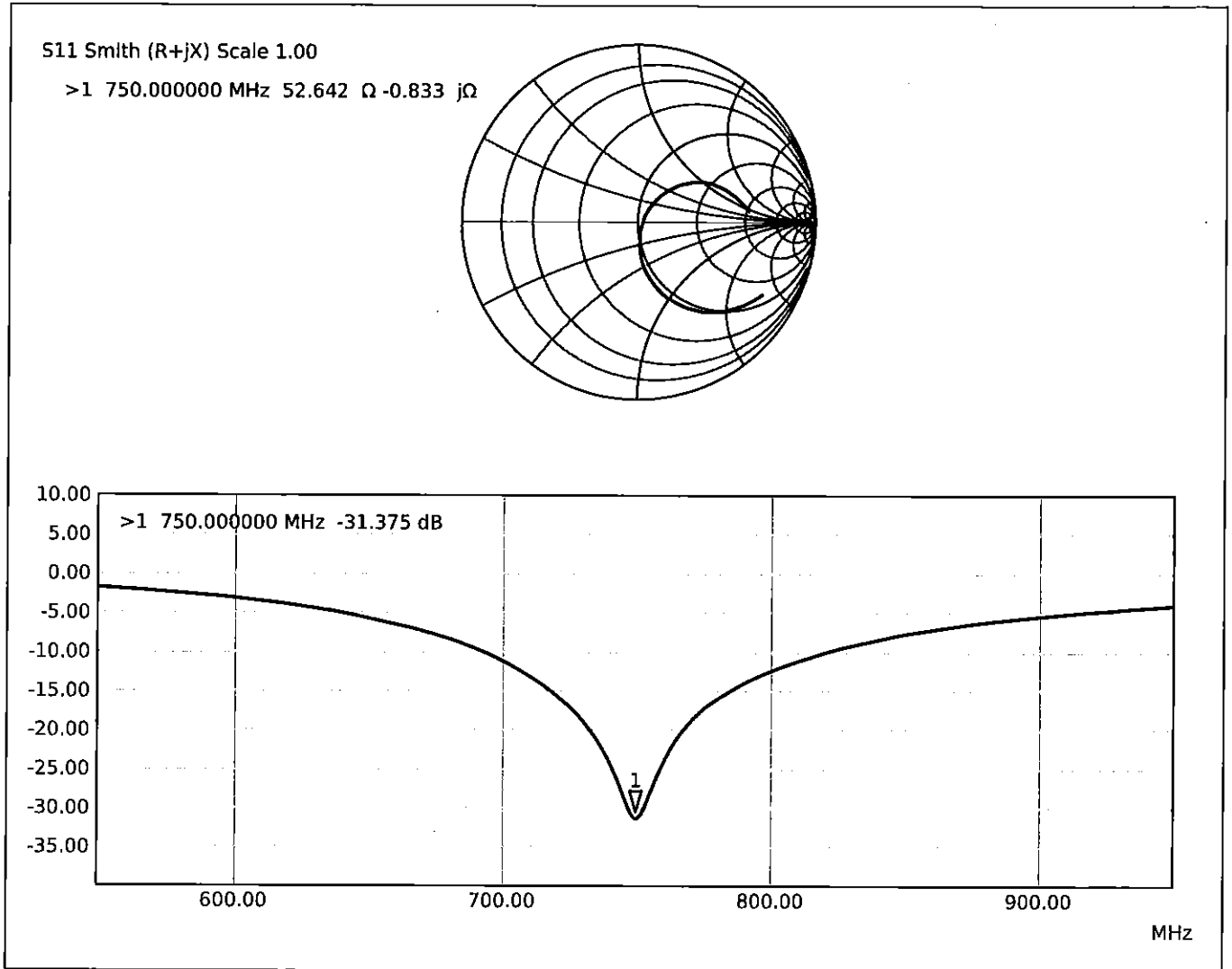

**System Performance Check Report**

**Summary**

Dipole	Frequency [MHz]	TSL	Power [dBm]
D750V3 - SN1057	750	MSL	24

**Exposure Conditions**

Phantom Section, TSL	Test Distance [mm]	Band	Group, UID	Frequency [MHz], Channel Number	Conversion Factor	TSL Conductivity [S/m]	TSL Permittivity
Flat	15	CW, 0--		750, 0	9.7	0.97	55.5

**Hardware Setup**

Phantom	TSL, Measured Date	Probe, Calibration Date	DAE, Calibration Date
Flat V4.9 mod	MSL, 2025-05-07	EX3DV4 - SN7349, 2025-01-10	DAE4lp 5n1 836, 2025-04-17

**Scans Setup**

	Zoom Scan
Grid Extents [mm]	30 x 30 x 30
Grid Steps [mm]	6.0 x 6.0 x 1.5
Sensor Surface [mm]	1.4
Graded Grid	Yes
Grading Ratio	1.5
MAIA	N/A
Surface Detection	VMS + 6p
Scan Method	Measured

**Measurement Results**

	Zoom Scan
Date	2025-05-07
psSAR1g [W/Kg]	2.24
psSAR10g [W/Kg]	1.47
Power Drift [dB]	0.00
Power Scaling	Disabled
Scaling Factor [dB]	
TSL Correction	Positive / Negative



0 dB = 3.44 W/Kg

### Impedance Measurement Plot for MSL

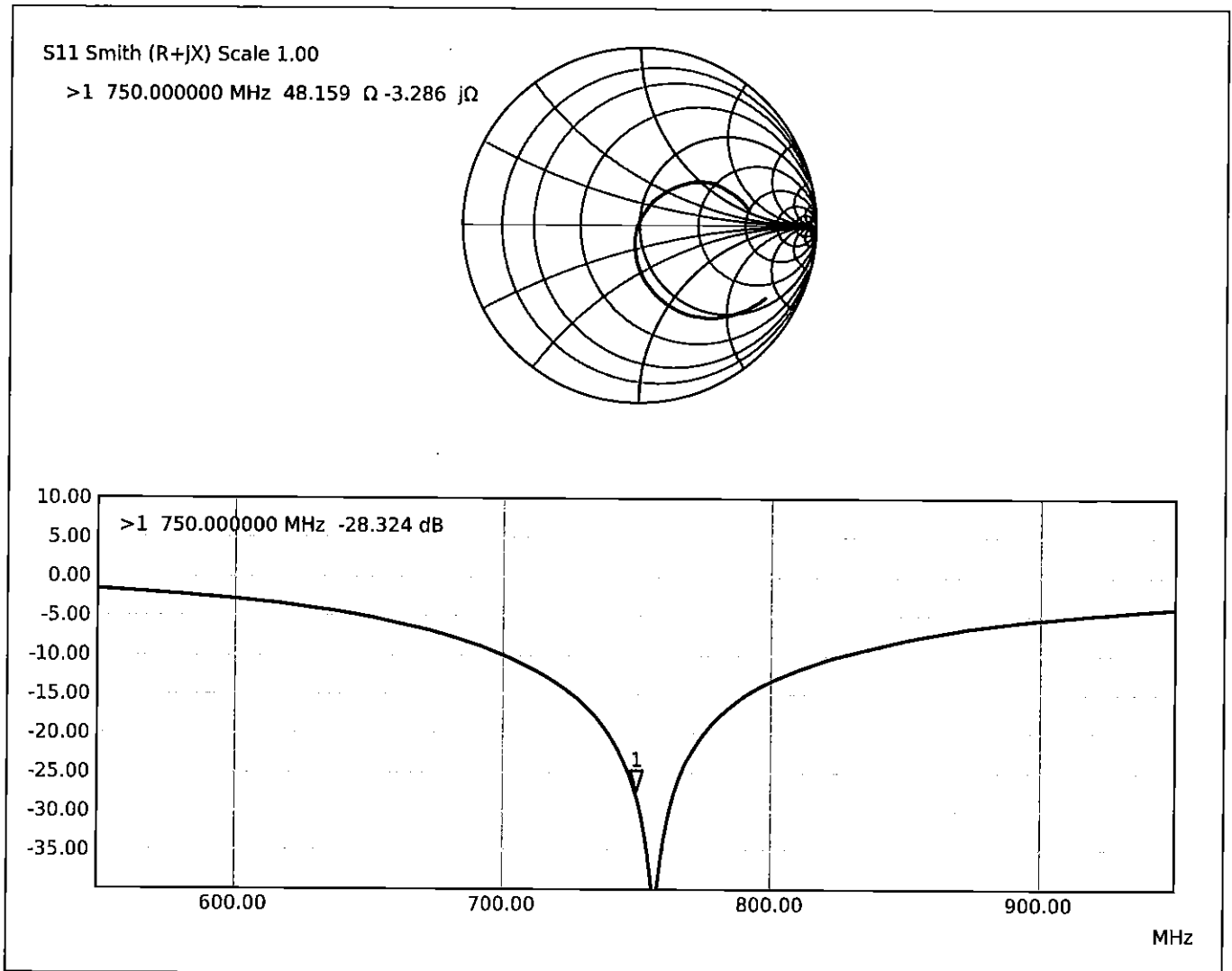





Accredited by the Swiss Accreditation Service (SAS)  
The Swiss Accreditation Service is one of the signatories to the EA  
Multilateral Agreement for the recognition of calibration certificates

Client **Element**  
**Morgan Hill, USA**

Certificate No. **D750V3-1097\_Sep23**

## CALIBRATION CERTIFICATE

Object **D750V3 - SN:1097**

VATM

Calibration procedure(s) **QA CAL-05.v12**  
**Calibration Procedure for SAR Validation Sources between 0.7-3 GHz**

9/28/2023

✓ YW 10/11/2024

Calibration date: **September 13, 2023**

This calibration certificate documents the traceability to national standards, which realize the physical units of measurements (SI).  
The measurements and the uncertainties with confidence probability are given on the following pages and are part of the certificate.

All calibrations have been conducted in the closed laboratory facility: environment temperature (22 ± 3)°C and humidity < 70%.

Calibration Equipment used (M&TE critical for calibration)

Primary Standards	ID #	Cal Date (Certificate No.)	Scheduled Calibration
Power meter NRP2	SN: 104778	30-Mar-23 (No. 217-03804/03805)	Mar-24
Power sensor NRP-Z91	SN: 103244	30-Mar-23 (No. 217-03804)	Mar-24
Power sensor NRP-Z91	SN: 103245	30-Mar-23 (No. 217-03805)	Mar-24
Reference 20 dB Attenuator	SN: BH9394 (20k)	30-Mar-23 (No. 217-03809)	Mar-24
Type-N mismatch combination	SN: 310982 / 06327	30-Mar-23 (No. 217-03810)	Mar-24
Reference Probe EX3DV4	SN: 7349	10-Jan-23 (No. EX3-7349_Jan23)	Jan-24
DAE4	SN: 601	19-Dec-22 (No. DAE4-601_Dec22)	Dec-23

Secondary Standards	ID #	Check Date (in house)	Scheduled Check
Power meter E4419B	SN: GB39512475	30-Oct-14 (in house check Oct-22)	In house check: Oct-24
Power sensor HP 8481A	SN: US37292783	07-Oct-15 (in house check Oct-22)	In house check: Oct-24
Power sensor HP 8481A	SN: MY41093315	07-Oct-15 (in house check Oct-22)	In house check: Oct-24
RF generator R&S SMT-06	SN: 100972	15-Jun-15 (in house check Oct-22)	In house check: Oct-24
Network Analyzer Agilent E8358A	SN: US41080477	31-Mar-14 (in house check Oct-22)	In house check: Oct-24

Calibrated by: **Paulo Pina**      Name: Paulo Pina      Function: Laboratory Technician

Approved by: **Sven Kühn**      Name: Sven Kühn      Function: Technical Manager

Issued: September 14, 2023

This calibration certificate shall not be reproduced except in full without written approval of the laboratory.



Accredited by the Swiss Accreditation Service (SAS)

The Swiss Accreditation Service is one of the signatories to the EA  
Multilateral Agreement for the recognition of calibration certificates

Accreditation No.: **SCS 0108**

### Glossary:

TSL	tissue simulating liquid
ConvF	sensitivity in TSL / NORM x,y,z
N/A	not applicable or not measured

### Calibration is Performed According to the Following Standards:

- a) IEC/IEEE 62209-1528, "Measurement Procedure For The Assessment Of Specific Absorption Rate Of Human Exposure To Radio Frequency Fields From Hand-Held And Body-Worn Wireless Communication Devices - Part 1528: Human Models, Instrumentation And Procedures (Frequency Range of 4 MHz to 10 GHz)", October 2020.
- b) KDB 865664, "SAR Measurement Requirements for 100 MHz to 6 GHz"

### Additional Documentation:

- c) DASY System Handbook

### Methods Applied and Interpretation of Parameters:

- *Measurement Conditions:* Further details are available from the Validation Report at the end of the certificate. All figures stated in the certificate are valid at the frequency indicated.
- *Antenna Parameters with TSL:* The source is mounted in a touch configuration below the center marking of the flat phantom.
- *Return Loss:* This parameter is measured with the source positioned under the liquid filled phantom (as described in the measurement condition clause). The Return Loss ensures low reflected power. No uncertainty required.
- *SAR measured:* SAR measured at the stated antenna input power.
- *SAR normalized:* SAR as measured, normalized to an input power of 1 W at the antenna connector.
- *SAR for nominal TSL parameters:* The measured TSL parameters are used to calculate the nominal SAR result.

The reported uncertainty of measurement is stated as the standard uncertainty of measurement multiplied by the coverage factor  $k=2$ , which for a normal distribution corresponds to a coverage probability of approximately 95%.

## Measurement Conditions

DASY system configuration, as far as not given on page 1.

<b>DASY Version</b>	DASY52	V52.10.4
<b>Extrapolation</b>	Advanced Extrapolation	
<b>Phantom</b>	Modular Flat Phantom	
<b>Distance Dipole Center - TSL</b>	15 mm	with Spacer
<b>Zoom Scan Resolution</b>	dx, dy, dz = 5 mm	
<b>Frequency</b>	750 MHz $\pm$ 1 MHz	

## Head TSL parameters

The following parameters and calculations were applied.

	Temperature	Permittivity	Conductivity
<b>Nominal Head TSL parameters</b>	22.0 °C	41.9	0.89 mho/m
<b>Measured Head TSL parameters</b>	(22.0 $\pm$ 0.2) °C	42.4 $\pm$ 6 %	0.90 mho/m $\pm$ 6 %
<b>Head TSL temperature change during test</b>	< 0.5 °C	----	----

## SAR result with Head TSL

<b>SAR averaged over 1 cm<sup>3</sup> (1 g) of Head TSL</b>	Condition	
SAR measured	250 mW input power	2.08 W/kg
SAR for nominal Head TSL parameters	normalized to 1W	<b>8.27 W/kg <math>\pm</math> 17.0 % (k=2)</b>

<b>SAR averaged over 10 cm<sup>3</sup> (10 g) of Head TSL</b>	condition	
SAR measured	250 mW input power	1.35 W/kg
SAR for nominal Head TSL parameters	normalized to 1W	<b>5.38 W/kg <math>\pm</math> 16.5 % (k=2)</b>

## Body TSL parameters

The following parameters and calculations were applied.

	Temperature	Permittivity	Conductivity
<b>Nominal Body TSL parameters</b>	22.0 °C	55.5	0.96 mho/m
<b>Measured Body TSL parameters</b>	(22.0 $\pm$ 0.2) °C	55.8 $\pm$ 6 %	0.96 mho/m $\pm$ 6 %
<b>Body TSL temperature change during test</b>	< 0.5 °C	----	----

## SAR result with Body TSL

<b>SAR averaged over 1 cm<sup>3</sup> (1 g) of Body TSL</b>	Condition	
SAR measured	250 mW input power	2.16 W/kg
SAR for nominal Body TSL parameters	normalized to 1W	<b>8.67 W/kg <math>\pm</math> 17.0 % (k=2)</b>

<b>SAR averaged over 10 cm<sup>3</sup> (10 g) of Body TSL</b>	condition	
SAR measured	250 mW input power	1.43 W/kg
SAR for nominal Body TSL parameters	normalized to 1W	<b>5.71 W/kg <math>\pm</math> 16.5 % (k=2)</b>

## Appendix (Additional assessments outside the scope of SCS 0108)

### Antenna Parameters with Head TSL

Impedance, transformed to feed point	$55.2 \Omega + 2.5 j\Omega$
Return Loss	- 25.2 dB

### Antenna Parameters with Body TSL

Impedance, transformed to feed point	$48.9 \Omega - 3.2 j\Omega$
Return Loss	- 29.2 dB

### General Antenna Parameters and Design

Electrical Delay (one direction)	1.038 ns
----------------------------------	----------

After long term use with 100W radiated power, only a slight warming of the dipole near the feedpoint can be measured.

The dipole is made of standard semirigid coaxial cable. The center conductor of the feeding line is directly connected to the second arm of the dipole. The antenna is therefore short-circuited for DC-signals. On some of the dipoles, small end caps are added to the dipole arms in order to improve matching when loaded according to the position as explained in the "Measurement Conditions" paragraph. The SAR data are not affected by this change. The overall dipole length is still according to the Standard.

No excessive force must be applied to the dipole arms, because they might bend or the soldered connections near the feedpoint may be damaged.

### Additional EUT Data

Manufactured by	SPEAG
-----------------	-------

## DASY5 Validation Report for Head TSL

Date: 13.09.2023

Test Laboratory: SPEAG, Zurich, Switzerland

**DUT: Dipole 750 MHz; Type: D750V3; Serial: D750V3 - SN:1097**

Communication System: UID 0 - CW; Frequency: 750 MHz

Medium parameters used:  $f = 750$  MHz;  $\sigma = 0.9$  S/m;  $\epsilon_r = 42.4$ ;  $\rho = 1000$  kg/m<sup>3</sup>

Phantom section: Flat Section

Measurement Standard: DASY5 (IEEE/IEC/ANSI C63.19-2011)

DASY52 Configuration:

- Probe: EX3DV4 - SN7349; ConvF(10.11, 10.11, 10.11) @ 750 MHz; Calibrated: 10.01.2023
- Sensor-Surface: 1.4mm (Mechanical Surface Detection)
- Electronics: DAE4 Sn601; Calibrated: 19.12.2022
- Phantom: Flat Phantom 4.9 (front); Type: QD 00L P49 AA; Serial: 1001
- DASY52 52.10.4(1535); SEMCAD X 14.6.14(7501)

**Dipole Calibration for Head Tissue/Pin=250 mW, d=15mm/Zoom Scan (7x7x7)/Cube 0:**

Measurement grid: dx=5mm, dy=5mm, dz=5mm

Reference Value = 59.61 V/m; Power Drift = -0.03 dB

Peak SAR (extrapolated) = 3.17 W/kg

**SAR(1 g) = 2.08 W/kg; SAR(10 g) = 1.35 W/kg**

Smallest distance from peaks to all points 3 dB below = 16.8 mm

Ratio of SAR at M2 to SAR at M1 = 65.4%

Maximum value of SAR (measured) = 2.78 W/kg

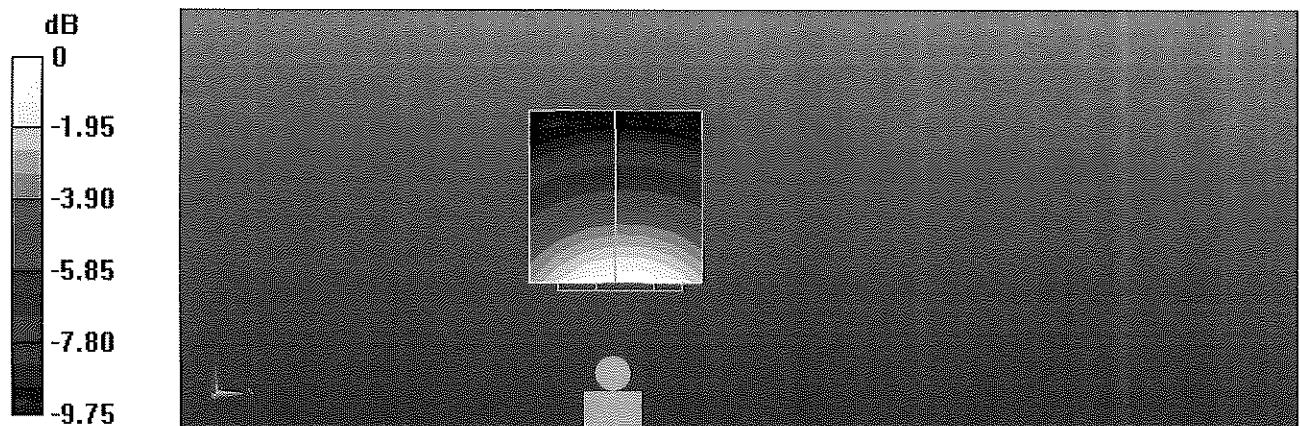

0 dB = 2.78 W/kg = 4.44 dBW/kg

# Impedance Measurement Plot for Head TSL

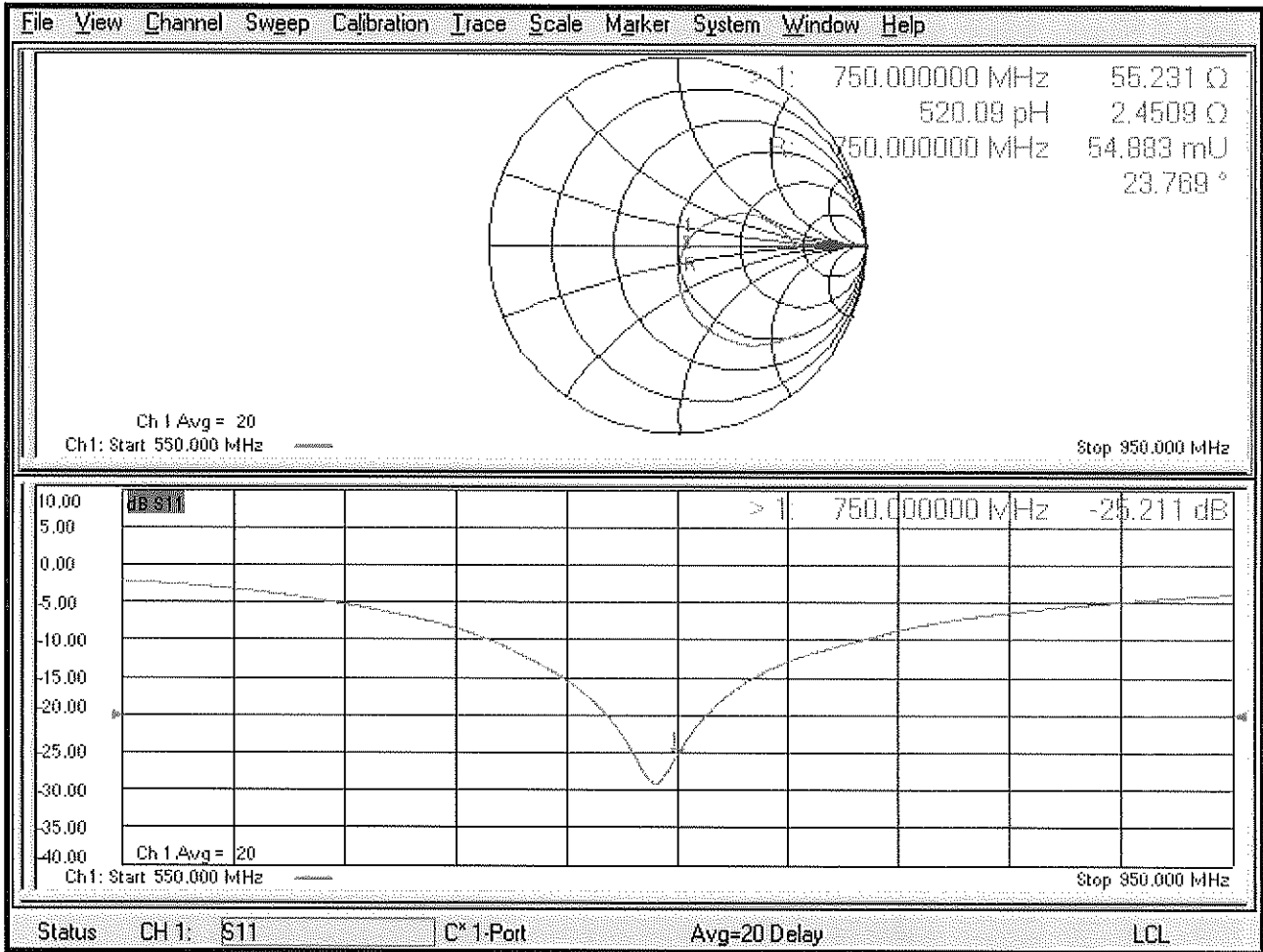

# DASY5 Validation Report for Body TSL

Date: 05.09.2023

Test Laboratory: SPEAG, Zurich, Switzerland

**DUT: Dipole 750 MHz; Type: D750V3; Serial: D750V3 - SN:1097**

Communication System: UID 0 - CW; Frequency: 750 MHz

Medium parameters used:  $f = 750 \text{ MHz}$ ;  $\sigma = 0.96 \text{ S/m}$ ;  $\epsilon_r = 55.8$ ;  $\rho = 1000 \text{ kg/m}^3$

Phantom section: Flat Section

Measurement Standard: DASY5 (IEEE/IEC/ANSI C63.19-2011)

DASY52 Configuration:

- Probe: EX3DV4 - SN7349; ConvF(10.23, 10.23, 10.23) @ 750 MHz; Calibrated: 10.01.2023
- Sensor-Surface: 1.4mm (Mechanical Surface Detection)
- Electronics: DAE4 Sn601; Calibrated: 19.12.2022
- Phantom: Flat Phantom 4.9 (Back); Type: QD 00R P49 AA; Serial: 1005
- DASY52 52.10.4(1535); SEMCAD X 14.6.14(7501)

## Dipole Calibration for Body Tissue/Pin=250 mW, d=15mm/Zoom Scan (7x7x7)/Cube 0:

Measurement grid:  $dx=5\text{mm}$ ,  $dy=5\text{mm}$ ,  $dz=5\text{mm}$

Reference Value = 58.05 V/m; Power Drift = 0.03 dB

Peak SAR (extrapolated) = 3.25 W/kg

**SAR(1 g) = 2.16 W/kg; SAR(10 g) = 1.43 W/kg**

Smallest distance from peaks to all points 3 dB below = 20.5 mm

Ratio of SAR at M2 to SAR at M1 = 66.6%

Maximum value of SAR (measured) = 2.88 W/kg

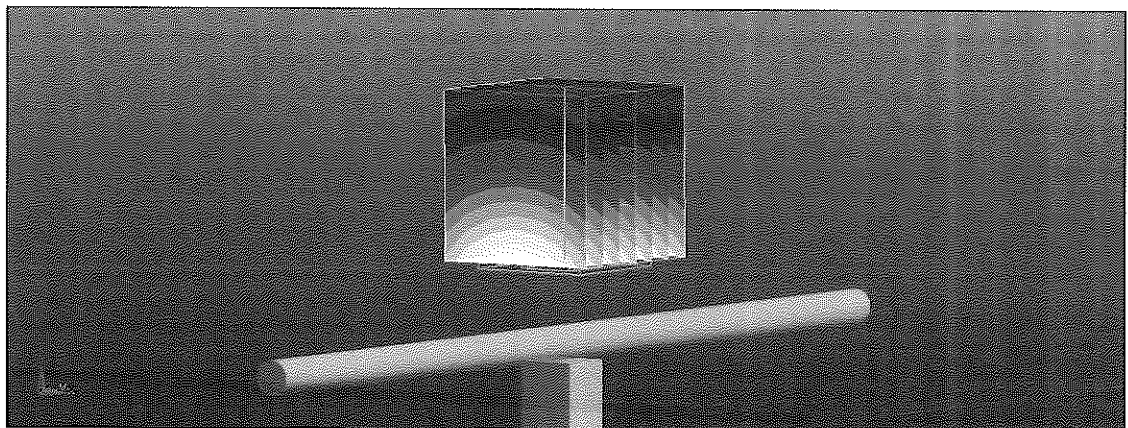
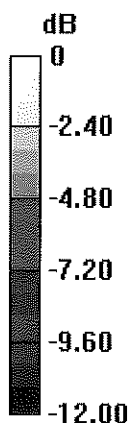

0 dB = 2.88 W/kg = 4.60 dBW/kg

# Impedance Measurement Plot for Body TSL

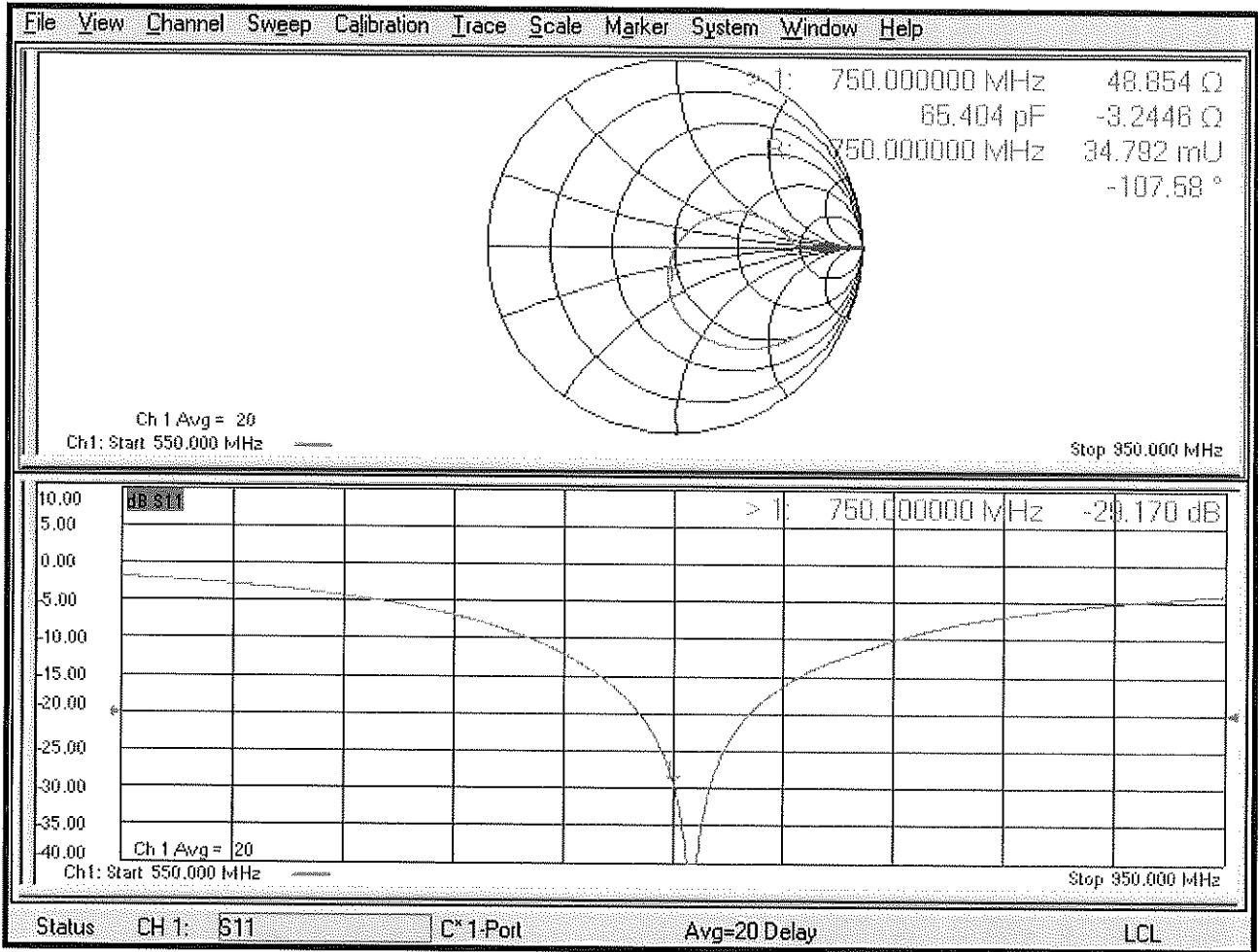



# Certification of Calibration

Object: D750V3 – SN: 1097  
 Calibration procedure(s): Procedure for Calibration Extension for SAR Dipoles.  
 Extension Calibration date: September 13, 2024  
 Description: SAR Validation Dipole at 750 MHz.

Calibration Equipment used:

Manufacturer	Model	Description	Cal Date	Cal Interval	Cal Due	Serial Number
Hewlett Packard	8753E	RF Vector Network Analyzer	5/21/2024	Annual	5/21/2025	US38161081
Agilent	E4438C	ESG Vector Signal Generator	5/19/2024	Annual	5/19/2025	US41460739
Amplifier Research	15S1G6	Amplifier	CBT	N/A	CBT	343972
Anritsu	ML2496A	Power Meter	7/15/2024	Annual	7/15/2025	1138001
Anritsu	MA2411B	Pulse Power Sensor	7/10/2024	Annual	7/10/2025	1126066
Anritsu	MA2411B	Pulse Power Sensor	7/1/2024	Annual	7/1/2025	1911105
Traceable	4040 90080-06	Therm./ Clock/ Humidity Monitor	1/15/2024	Annual	1/15/2025	160574418
Control Company	4352	Ultra Long Stem Thermometer	1/15/2024	Annual	1/15/2025	160508097
Agilent	85033E	3.5mm Standard Calibration Kit	7/31/2024	Annual	7/31/2025	MY53402352
Mini-Circuits	VLF-6000+	Low Pass Filter DC to 6000 MHz	CBT	N/A	CBT	N/A
Narda	4772-3	Attenuator (3dB)	CBT	N/A	CBT	9406
Mini-Circuits	ZHDC-16-63-S+	50-6000MHz Bidirectional Coupler	CBT	N/A	CBT	N/A
Pasternack	NC-100	Torque Wrench	12/5/2022	Biennial	12/5/2024	N/A
SPEAG	DAK-3.5	Dielectric Assessment Kit	5/14/2024	Annual	5/14/2025	1070
SPEAG	EX3DV4	SAR Probe	2/9/2024	Annual	2/9/2025	7427
SPEAG	DAE4	Dasy Data Acquisition Electronics	2/9/2024	Annual	2/9/2025	467

Measurement Uncertainty = ±23% (k=2)

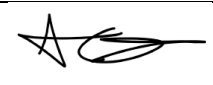
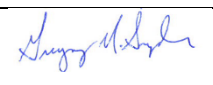
	Name	Function	Signature
Calibrated By:	Arturo Oliveros	Compliance Engineer	
Approved By:	Greg Snyder	Executive VP of Operations	

# DIPOLE CALIBRATION EXTENSION

Per KDB 865664 D01, calibration intervals of up to three years may be considered for reference dipoles when it is demonstrated that the SAR target, impedance and return loss of a dipole have remained stable according to the following requirements:

1. The measured SAR does not deviate more than 10% from the target on the calibration certificate.
2. The return-loss does not deviate more than 20% from the previous measurement and meets the required 20dB minimum return-loss requirement.
3. The measurement of real or imaginary parts of impedance does not deviate more than 5Ω from the previous measurement.

The following dipole was checked to pass the above 3 requirements to have 2-year calibration period from the calibration date:

Calibration Date	Extension Date	Certificate Electrical Delay (ns)	Certificate SAR Target Head (1g) W/kg @ 23.0 dBm	Measured Head SAR (1g) W/kg @ 23.0 dBm	Deviation 1g (%)	Certificate SAR Target Head (10g) W/kg @ 23.0 dBm	Measured Head SAR (10g) W/kg @ 23.0 dBm	Deviation 10g (%)	Certificate Impedance Head (Ohm) Real	Measured Impedance Head (Ohm) Real	Difference (Ohm) Real	Certificate Impedance Head (Ohm) Imaginary	Measured Impedance Head (Ohm) Imaginary	Difference (Ohm) Imaginary	Certificate Return Loss Head (dB)	Measured Return Loss Head (dB)	Deviation (%)
9/13/2023	9/13/2024	1.038	1.65	1.72	3.99%	1.08	1.14	5.95%	55.2	59.7	4.5	2.5	0.1	2.4	25.2	29.9	-18.60%

### Impedance & Return-Loss Measurement Plot for Head TSL

CH1 S11 1 U FS 1: 50.695  $\Omega$  0.1250  $\Omega$  26.525 pF 750.000 000 MHz

\*  
De1  
Cor

↑

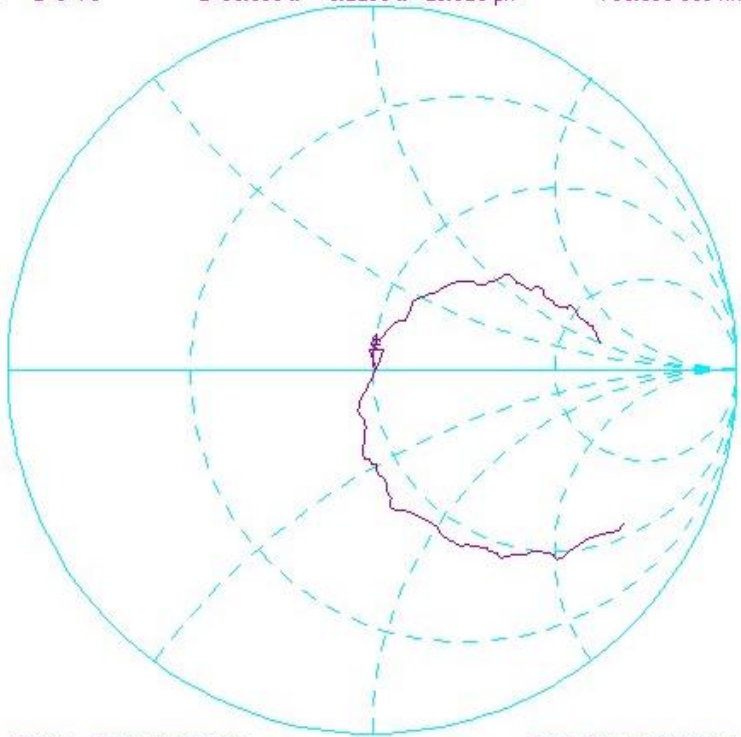

CH1 S11 CENTER 750.000 000 MHz SPAN 400.000 000 MHz  
L06 5 dB/REF -20 dB 1: -29.875 dB 750.000 000 MHz

\*  
De1  
Cor

↑

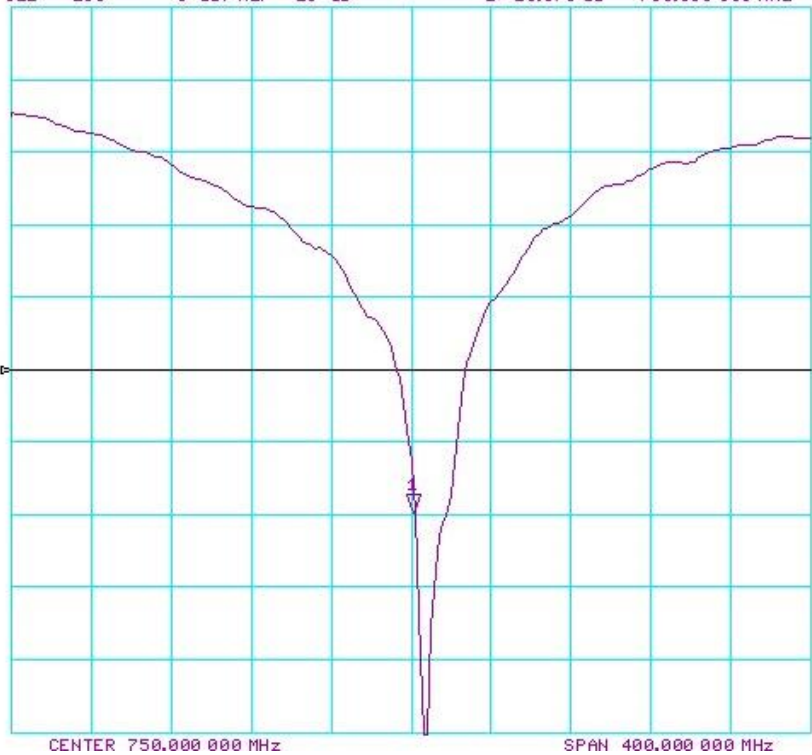



Accredited by the Swiss Accreditation Service (SAS)  
The Swiss Accreditation Service is one of the signatories to the EA  
Multilateral Agreement for the recognition of calibration certificates

Accreditation No.: **SCS 0108**

Client **Element**

Certificate No: **D835V2-4d108\_Nov22**

**CALIBRATION CERTIFICATE**

Object **D835V2 - SN:4d108** ✓ ATM

Calibration procedure(s) **QA CAL-05.v11**  
**Calibration Procedure for SAR Validation Sources between 0.7-3 GHz** 12/6/22

Calibration date: **November 18, 2022** ✓ YW 12/13/2023  
✓ YW 11/21/2024

This calibration certificate documents the traceability to national standards, which realize the physical units of measurements (SI).  
The measurements and the uncertainties with confidence probability are given on the following pages and are part of the certificate.

All calibrations have been conducted in the closed laboratory facility: environment temperature (22 ± 3)°C and humidity < 70%.

Calibration Equipment used (M&TE critical for calibration)

Primary Standards	ID #	Cal Date (Certificate No.)	Scheduled Calibration
Power meter NRP	SN: 104778	04-Apr-22 (No. 217-03525/03524)	Apr-23
Power sensor NRP-Z91	SN: 103244	04-Apr-22 (No. 217-03524)	Apr-23
Power sensor NRP-Z91	SN: 103245	04-Apr-22 (No. 217-03525)	Apr-23
Reference 20 dB Attenuator	SN: BH9394 (20k)	04-Apr-22 (No. 217-03527)	Apr-23
Type-N mismatch combination	SN: 310982 / 06327	04-Apr-22 (No. 217-03528)	Apr-23
Reference Probe EX3DV4	SN: 7349	31-Dec-21 (No. EX3-7349_Dec21)	Dec-22
DAE4	SN: 601	31-Aug-22 (No. DAE4-601_Aug22)	Aug-23
Secondary Standards	ID #	Check Date (in house)	Scheduled Check
Power meter E4419B	SN: GB39512475	30-Oct-14 (in house check Oct-22)	In house check: Oct-24
Power sensor HP 8481A	SN: US37292783	07-Oct-15 (in house check Oct-22)	In house check: Oct-24
Power sensor HP 8481A	SN: MY41093315	07-Oct-15 (in house check Oct-22)	In house check: Oct-24
RF generator R&S SMT-06	SN: 100972	15-Jun-15 (in house check Oct-22)	In house check: Oct-24
Network Analyzer Agilent E8358A	SN: US41080477	31-Mar-14 (in house check Oct-22)	In house check: Oct-24

Calibrated by: **Jeton Kastrati** (Name) **Laboratory Technician** (Function) Signature

Approved by: **Sven Kühn** (Name) **Technical Manager** (Function) Signature

Issued: November 18, 2022

This calibration certificate shall not be reproduced except in full without written approval of the laboratory.



Accredited by the Swiss Accreditation Service (SAS)

Accreditation No.: **SCS 0108**

The Swiss Accreditation Service is one of the signatories to the EA Multilateral Agreement for the recognition of calibration certificates

**Glossary:**

TSL	tissue simulating liquid
ConvF	sensitivity in TSL / NORM x,y,z
N/A	not applicable or not measured

**Calibration is Performed According to the Following Standards:**

- a) IEC/IEEE 62209-1528, "Measurement Procedure For The Assessment Of Specific Absorption Rate Of Human Exposure To Radio Frequency Fields From Hand-Held And Body-Worn Wireless Communication Devices - Part 1528: Human Models, Instrumentation And Procedures (Frequency Range of 4 MHz to 10 GHz)", October 2020.
- b) KDB 865664, "SAR Measurement Requirements for 100 MHz to 6 GHz"

**Additional Documentation:**

- c) DASYS System Handbook

**Methods Applied and Interpretation of Parameters:**

- *Measurement Conditions:* Further details are available from the Validation Report at the end of the certificate. All figures stated in the certificate are valid at the frequency indicated.
- *Antenna Parameters with TSL:* The source is mounted in a touch configuration below the center marking of the flat phantom.
- *Return Loss:* This parameter is measured with the source positioned under the liquid filled phantom (as described in the measurement condition clause). The Return Loss ensures low reflected power. No uncertainty required.
- *SAR measured:* SAR measured at the stated antenna input power.
- *SAR normalized:* SAR as measured, normalized to an input power of 1 W at the antenna connector.
- *SAR for nominal TSL parameters:* The measured TSL parameters are used to calculate the nominal SAR result.

The reported uncertainty of measurement is stated as the standard uncertainty of measurement multiplied by the coverage factor  $k=2$ , which for a normal distribution corresponds to a coverage probability of approximately 95%.

## Measurement Conditions

DASY system configuration, as far as not given on page 1.

DASY Version	DASY52	V52.10.4
Extrapolation	Advanced Extrapolation	
Phantom	Modular Flat Phantom	
Distance Dipole Center - TSL	15 mm	with Spacer
Zoom Scan Resolution	dx, dy, dz = 5 mm	
Frequency	835 MHz $\pm$ 1 MHz	

## Head TSL parameters

The following parameters and calculations were applied.

	Temperature	Permittivity	Conductivity
Nominal Head TSL parameters	22.0 °C	41.5	0.90 mho/m
Measured Head TSL parameters	(22.0 $\pm$ 0.2) °C	40.7 $\pm$ 6 %	0.91 mho/m $\pm$ 6 %
Head TSL temperature change during test	< 0.5 °C	----	----

## SAR result with Head TSL

SAR averaged over 1 cm <sup>3</sup> (1 g) of Head TSL	Condition	
SAR measured	250 mW input power	2.48 W/kg
SAR for nominal Head TSL parameters	normalized to 1W	<b>9.80 W/kg <math>\pm</math> 17.0 % (k=2)</b>

SAR averaged over 10 cm <sup>3</sup> (10 g) of Head TSL	condition	
SAR measured	250 mW input power	1.60 W/kg
SAR for nominal Head TSL parameters	normalized to 1W	<b>6.34 W/kg <math>\pm</math> 16.5 % (k=2)</b>

## Body TSL parameters

The following parameters and calculations were applied.

	Temperature	Permittivity	Conductivity
Nominal Body TSL parameters	22.0 °C	55.2	0.97 mho/m
Measured Body TSL parameters	(22.0 $\pm$ 0.2) °C	55.2 $\pm$ 6 %	0.98 mho/m $\pm$ 6 %
Body TSL temperature change during test	< 0.5 °C	----	----

## SAR result with Body TSL

SAR averaged over 1 cm <sup>3</sup> (1 g) of Body TSL	Condition	
SAR measured	250 mW input power	2.46 W/kg
SAR for nominal Body TSL parameters	normalized to 1W	<b>9.76 W/kg <math>\pm</math> 17.0 % (k=2)</b>

SAR averaged over 10 cm <sup>3</sup> (10 g) of Body TSL	condition	
SAR measured	250 mW input power	1.61 W/kg
SAR for nominal Body TSL parameters	normalized to 1W	<b>6.41 W/kg <math>\pm</math> 16.5 % (k=2)</b>

## Appendix (Additional assessments outside the scope of SCS 0108)

### Antenna Parameters with Head TSL

Impedance, transformed to feed point	51.5 $\Omega$ - 2.1 j $\Omega$
Return Loss	- 31.8 dB

### Antenna Parameters with Body TSL

Impedance, transformed to feed point	47.1 $\Omega$ - 6.7 j $\Omega$
Return Loss	- 22.5 dB

### General Antenna Parameters and Design

Electrical Delay (one direction)	1.394 ns
----------------------------------	----------

After long term use with 100W radiated power, only a slight warming of the dipole near the feedpoint can be measured.

The dipole is made of standard semirigid coaxial cable. The center conductor of the feeding line is directly connected to the second arm of the dipole. The antenna is therefore short-circuited for DC-signals. On some of the dipoles, small end caps are added to the dipole arms in order to improve matching when loaded according to the position as explained in the "Measurement Conditions" paragraph. The SAR data are not affected by this change. The overall dipole length is still according to the Standard.

No excessive force must be applied to the dipole arms, because they might bend or the soldered connections near the feedpoint may be damaged.

### Additional EUT Data

Manufactured by	SPEAG
-----------------	-------

## DASY5 Validation Report for Head TSL

Date: 18.11.2022

Test Laboratory: SPEAG, Zurich, Switzerland

**DUT: Dipole 835 MHz; Type: D835V2; Serial: D835V2 - SN:4d108**

Communication System: UID 0 - CW; Frequency: 835 MHz

Medium parameters used:  $f = 835$  MHz;  $\sigma = 0.91$  S/m;  $\epsilon_r = 40.7$ ;  $\rho = 1000$  kg/m<sup>3</sup>

Phantom section: Flat Section

Measurement Standard: DASY5 (IEEE/IEC/ANSI C63.19-2011)

DASY52 Configuration:

- Probe: EX3DV4 - SN7349; ConvF(9.69, 9.69, 9.69) @ 835 MHz; Calibrated: 31.12.2021
- Sensor-Surface: 1.4mm (Mechanical Surface Detection)
- Electronics: DAE4 Sn601; Calibrated: 31.08.2022
- Phantom: Flat Phantom 4.9 (front); Type: QD 00L P49 AA; Serial: 1001
- DASY52 52.10.4(1535); SEMCAD X 14.6.14(7501)

### Dipole Calibration for Head Tissue/Pin=250 mW, d=15mm/Zoom Scan (7x7x7)/Cube 0:

Measurement grid: dx=5mm, dy=5mm, dz=5mm

Reference Value = 64.17 V/m; Power Drift = 0.01 dB

Peak SAR (extrapolated) = 3.75 W/kg

**SAR(1 g) = 2.48 W/kg; SAR(10 g) = 1.6 W/kg**

Smallest distance from peaks to all points 3 dB below = 16 mm

Ratio of SAR at M2 to SAR at M1 = 66%

Maximum value of SAR (measured) = 3.31 W/kg

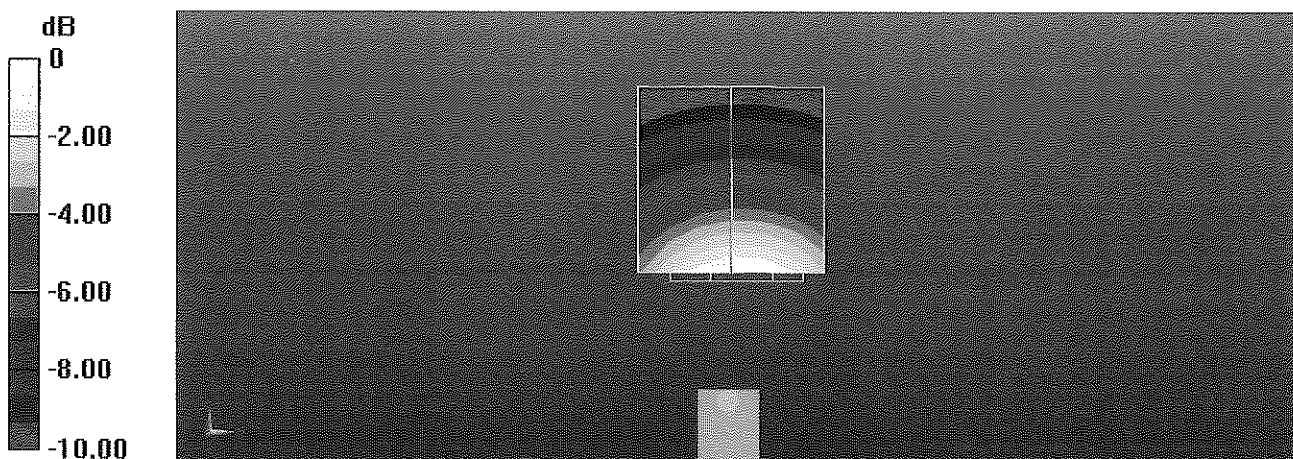

0 dB = 3.31 W/kg = 5.20 dBW/kg



# Impedance Measurement Plot for Head TSL

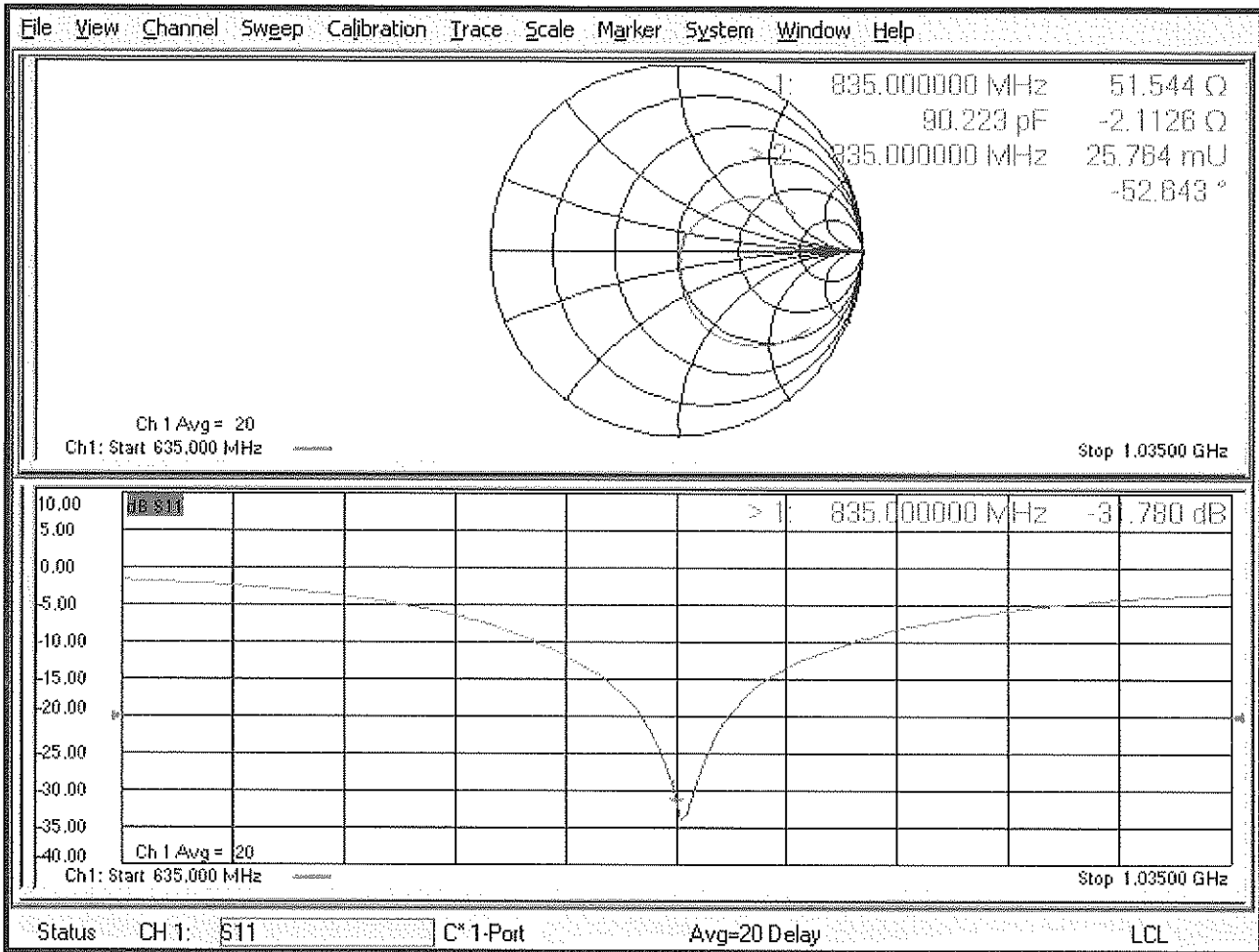

# DASY5 Validation Report for Body TSL

Date: 18.11.2022

Test Laboratory: SPEAG, Zurich, Switzerland

**DUT: Dipole 835 MHz; Type: D835V2; Serial: D835V2 - SN:4d108**

Communication System: UID 0 - CW; Frequency: 835 MHz

Medium parameters used:  $f = 835$  MHz;  $\sigma = 0.98$  S/m;  $\epsilon_r = 55.2$ ;  $\rho = 1000$  kg/m<sup>3</sup>

Phantom section: Flat Section

Measurement Standard: DASY5 (IEEE/IEC/ANSI C63.19-2011)

DASY52 Configuration:

- Probe: EX3DV4 - SN7349; ConvF(9.85, 9.85, 9.85) @ 835 MHz; Calibrated: 31.12.2021
- Sensor-Surface: 1.4mm (Mechanical Surface Detection)
- Electronics: DAE4 Sn601; Calibrated: 31.08.2022
- Phantom: Flat Phantom 4.9 (Back); Type: QD 00R P49 AA; Serial: 1005
- DASY52 52.10.4(1535); SEMCAD X 14.6.14(7501)

## Dipole Calibration for Body Tissue/Pin=250 mW, d=15mm/Zoom Scan (7x7x7)/Cube 0:

Measurement grid: dx=5mm, dy=5mm, dz=5mm

Reference Value = 58.04 V/m; Power Drift = 0.00 dB

Peak SAR (extrapolated) = 3.61 W/kg

**SAR(1 g) = 2.46 W/kg; SAR(10 g) = 1.61 W/kg**

Smallest distance from peaks to all points 3 dB below = 16 mm

Ratio of SAR at M2 to SAR at M1 = 68.2%

Maximum value of SAR (measured) = 3.25 W/kg

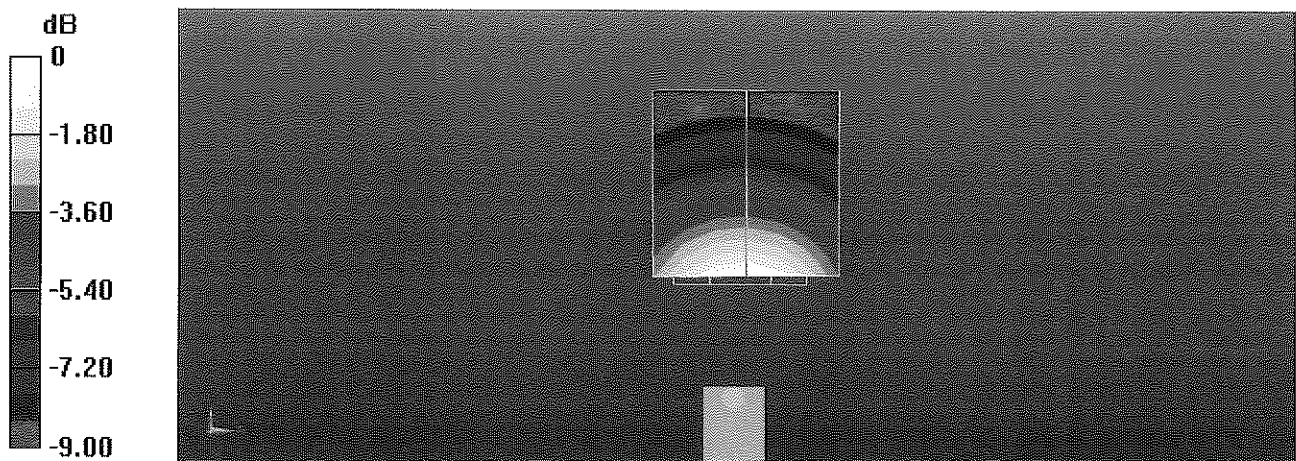

0 dB = 3.25 W/kg = 5.11 dBW/kg

# Impedance Measurement Plot for Body TSL

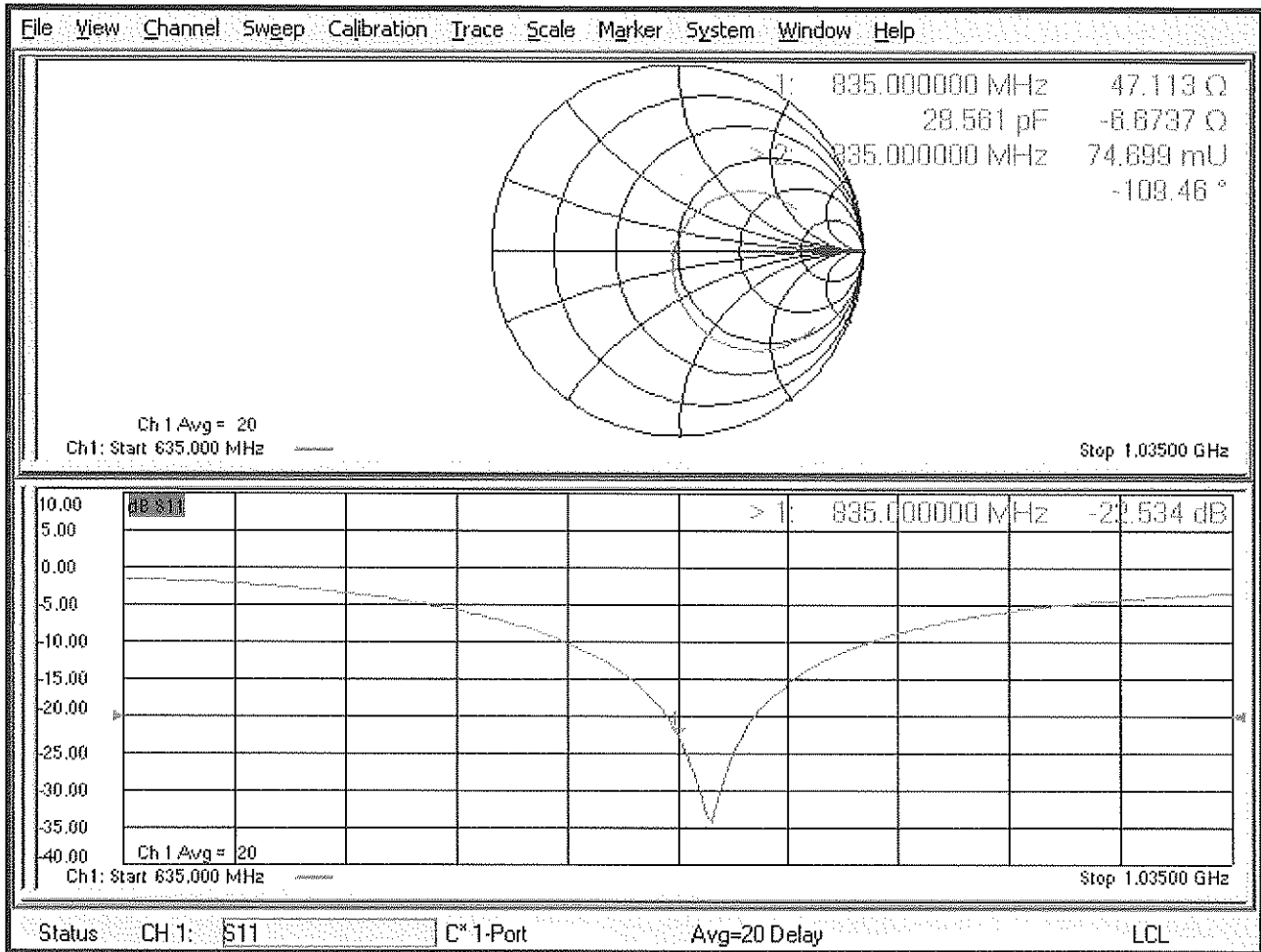

# Certification of Calibration

Object: D835V2 – SN: 4d108  
 Calibration procedure(s): Procedure for Calibration Extension for SAR Dipoles.  
 Extension Calibration date: November 18, 2023  
 Description: SAR Validation Dipole at 835 MHz.

Calibration Equipment used:

Manufacturer	Model	Description	Cal Date	Cal Interval	Cal Due	Serial Number
Agilent	8753ES	S-Parameter Vector Network Analyzer	6/2/2023	Annual	6/12/2024	MY40003841
Agilent	E4438C	ESG Vector Signal Generator	4/25/2023	Annual	4/25/2024	US41460739
Amplifier Research	15S1G6	Amplifier	CBT	N/A	CBT	343972
Rohde & Schwarz	NRX	Power Meter	1/11/2023	Annual	1/11/2024	102583
Rohde & Schwarz	NRP-Z81	Wide Band Power Sensor	1/19/2023	Annual	1/19/2024	106563
Rohde & Schwarz	NRP-Z81	Wide Band Power Sensor	1/11/2023	Annual	1/11/2024	106564
Traceable	4040 90080-06	Therm./ Clock/ Humidity Monitor	5/11/2022	Biennial	5/11/2024	221514974
Control Company	4353	Ultra Long Stem Thermometer	10/24/2023	Annual	10/24/2024	200645916
Agilent	85033E	3.5mm Standard Calibration Kit	7/18/2023	Annual	7/18/2024	MY53402352
Mini-Circuits	VLF-6000+	Low Pass Filter DC to 6000 MHz	CBT	N/A	CBT	N/A
Narda	4772-3	Attenuator (3dB)	CBT	N/A	CBT	9406
Mini-Circuits	ZHDC-16-63-S+	50-6000MHz Bidirectional Coupler	CBT	N/A	CBT	N/A
Pasternack	NC-100	Torque Wrench	12/5/2022	Biennial	12/5/2024	N/A
SPEAG	DAK-3.5	Dielectric Assessment Kit	5/9/2023	Annual	5/9/2024	1070
SPEAG	EX3DV4	SAR Probe	11/9/2023	Annual	11/9/2024	7639
SPEAG	DAE4	Dasy Data Acquisition Electronics	11/14/2023	Annual	11/14/2024	1403

Measurement Uncertainty = ±23% (k=2)

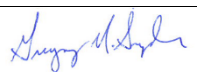
	Name	Function	Signature
Calibrated By:	Arturo Oliveros	Compliance Engineer	
Approved By:	Greg Snyder	Executive VP of Operations	

# DIPOLE CALIBRATION EXTENSION

Per KDB 865664 D01, calibration intervals of up to three years may be considered for reference dipoles when it is demonstrated that the SAR target, impedance and return loss of a dipole have remained stable according to the following requirements:

1. The measured SAR does not deviate more than 10% from the target on the calibration certificate.
2. The return-loss does not deviate more than 20% from the previous measurement and meets the required 20dB minimum return-loss requirement.
3. The measurement of real or imaginary parts of impedance does not deviate more than 5Ω from the previous measurement.

The following dipole was checked to pass the above 3 requirements to have 2-year calibration period from the calibration date:

Calibration Date	Extension Date	Certificate Electrical Delay (ns)	Certificate SAR Target Head (1g) W/kg @ 23.0 dBm	Measured Head SAR (1g) W/kg @ 23.0 dBm	Deviation 1g (%)	Certificate SAR Target Head (10g) W/kg @ 23.0 dBm	Measured Head SAR (10g) W/kg @ 23.0 dBm	Deviation 10g (%)	Certificate Impedance Head (Ohm) Real	Measured Impedance Head (Ohm) Real	Difference (Ohm) Real	Certificate Impedance Head (Ohm) Imaginary	Measured Impedance Head (Ohm) Imaginary	Difference (Ohm) Imaginary	Certificate Return Loss Head (dB)	Measured Return Loss Head (dB)	Deviation (%)
11/18/2022	11/18/2023	1.394	1.96	1.85	-5.61%	1.268	1.22	-3.79%	51.5	53.1	1.6	-2.1	0.3	2.4	-31.8	-30.6	3.80%

### Impedance & Return-Loss Measurement Plot for Head TSL

CH1 S11 1 U FS 1: 53.059  $\Omega$  0.3047  $\Omega$  57.050 pF 835.000 000 MHz

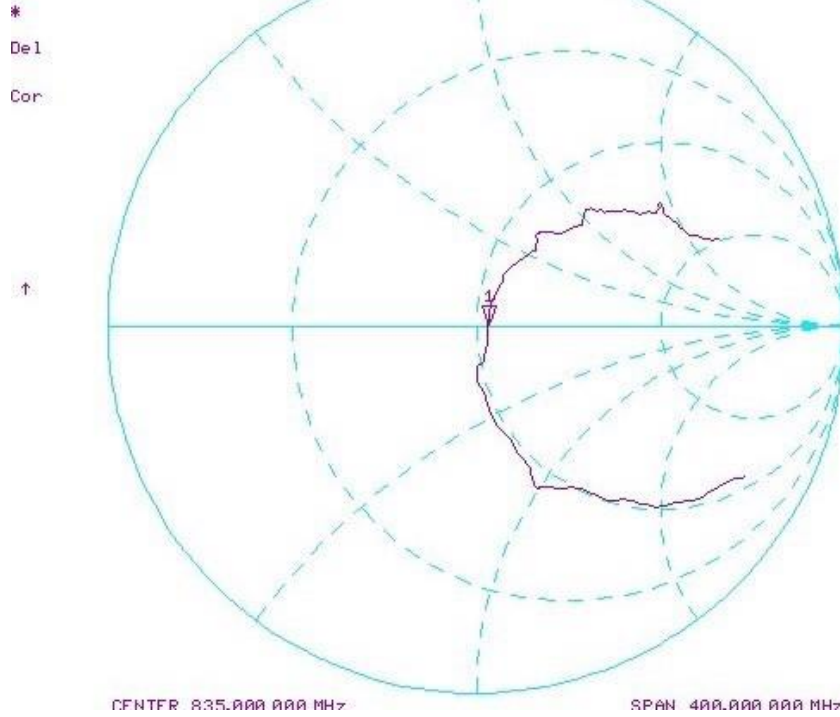

CH1 S11 LOG 5 dB/REF -20 dB 1: -30.591 dB 835.000 000 MHz

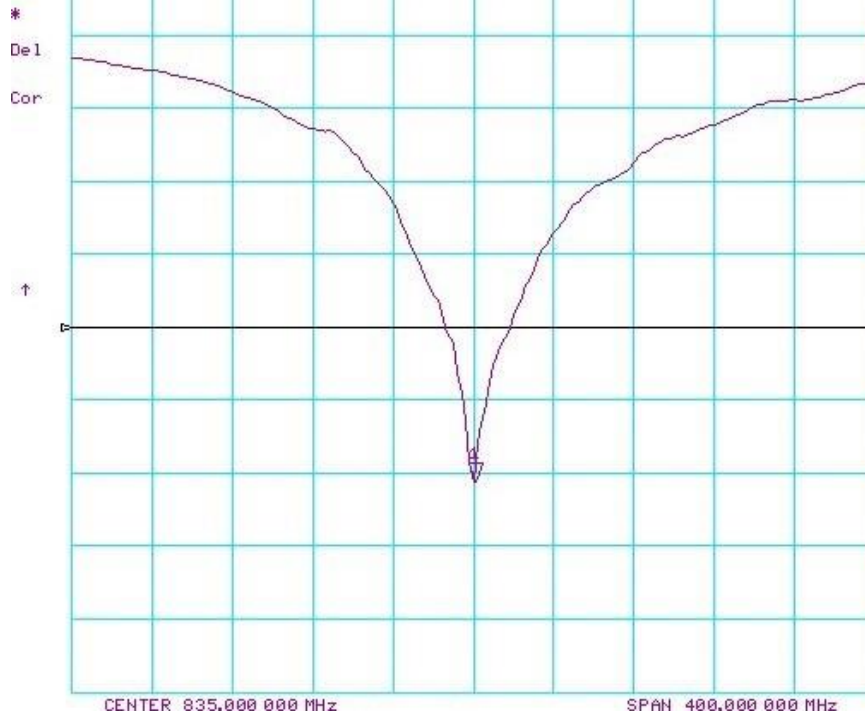

# Certification of Calibration

Object: D835V2 – SN: 4d108  
 Calibration procedure(s): Procedure for Calibration Extension for SAR Dipoles.  
 Extension Calibration date: November 18, 2024  
 Description: SAR Validation Dipole at 835 MHz.

Calibration Equipment used:

Manufacturer	Model	Description	Cal Date	Cal Interval	Cal Due	Serial Number
Hewlett Packard	8753E	RF Vector Network Analyzer	5/21/2024	Annual	5/21/2025	US38161081
Agilent	E4438C	ESG Vector Signal Generator	5/19/2024	Annual	5/19/2025	US41460739
Amplifier Research	15S1G6	Amplifier	CBT	N/A	CBT	343972
Anritsu	ML2496A	Power Meter	7/15/2024	Annual	7/15/2025	1138001
Anritsu	MA2411B	Pulse Power Sensor	7/10/2024	Annual	7/10/2025	1126066
Anritsu	MA2411B	Pulse Power Sensor	7/1/2024	Annual	7/1/2025	1911105
Traceable	4040 90080-06	Therm./ Clock/ Humidity Monitor	1/15/2024	Annual	1/15/2025	160574418
Control Company	4352	Ultra Long Stem Thermometer	1/15/2024	Annual	1/15/2025	160508097
Agilent	85033E	3.5mm Standard Calibration Kit	7/31/2024	Annual	7/31/2025	MY53402352
Mini-Circuits	VLF-6000+	Low Pass Filter DC to 6000 MHz	CBT	N/A	CBT	N/A
Narda	4772-3	Attenuator (3dB)	CBT	N/A	CBT	9406
Mini-Circuits	ZHDC-16-63-S+	50-6000MHz Bidirectional Coupler	CBT	N/A	CBT	N/A
Pasternack	NC-100	Torque Wrench	12/5/2022	Biennial	12/5/2024	N/A
SPEAG	DAK-3.5	Dielectric Assessment Kit	5/14/2024	Annual	5/14/2025	1070
SPEAG	EX3DV4	SAR Probe	5/13/2024	Annual	5/13/2025	7682
SPEAG	DAE4	Dasy Data Acquisition Electronics	5/8/2024	Annual	5/8/2025	1683

Measurement Uncertainty = ±23% (k=2)

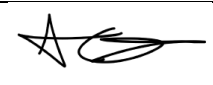
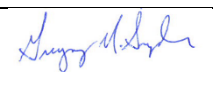
	Name	Function	Signature
Calibrated By:	Arturo Oliveros	Compliance Engineer	
Approved By:	Greg Snyder	Executive VP of Operations	

# DIPOLE CALIBRATION EXTENSION

Per KDB 865664 D01, calibration intervals of up to three years may be considered for reference dipoles when it is demonstrated that the SAR target, impedance and return loss of a dipole have remained stable according to the following requirements:

1. The measured SAR does not deviate more than 10% from the target on the calibration certificate.
2. The return-loss does not deviate more than 20% from the previous measurement and meets the required 20dB minimum return-loss requirement.
3. The measurement of real or imaginary parts of impedance does not deviate more than 5Ω from the previous measurement.

The following dipole was checked to pass the above 3 requirements to have 3-year calibration period from the calibration date:

Calibration Date	Extension Date	Certificate Electrical Delay (ns)	Certificate SAR Target Head (1g) W/kg @ 23.0 dBm	Measured Head SAR (1g) W/kg @ 23.0 dBm	Deviation 1g (%)	Certificate SAR Target Head (10g) W/kg @ 23.0 dBm	Measured Head SAR (10g) W/kg @ 23.0 dBm	Deviation 10g (%)	Certificate Impedance Head (Ohm) Real	Measured Impedance Head (Ohm) Real	Difference (Ohm) Real	Certificate Impedance Head (Ohm) Imaginary	Measured Impedance Head (Ohm) Imaginary	Difference (Ohm) Imaginary	Certificate Return Loss Head (dB)	Measured Return Loss Head (dB)	Deviation (%)
11/18/2022	11/18/2024	1.394	1.96	2.03	3.57%	1.268	1.34	5.68%	51.5	52	0.5	-2.1	0.9	3	-31.8	-33.2	-4.40%



### Impedance & Return-Loss Measurement Plot for Head TSL

CH1 S11 1 U FS 1: 52.035  $\Omega$  0.9492  $\Omega$  180.93 pF 835.000 000 MHz

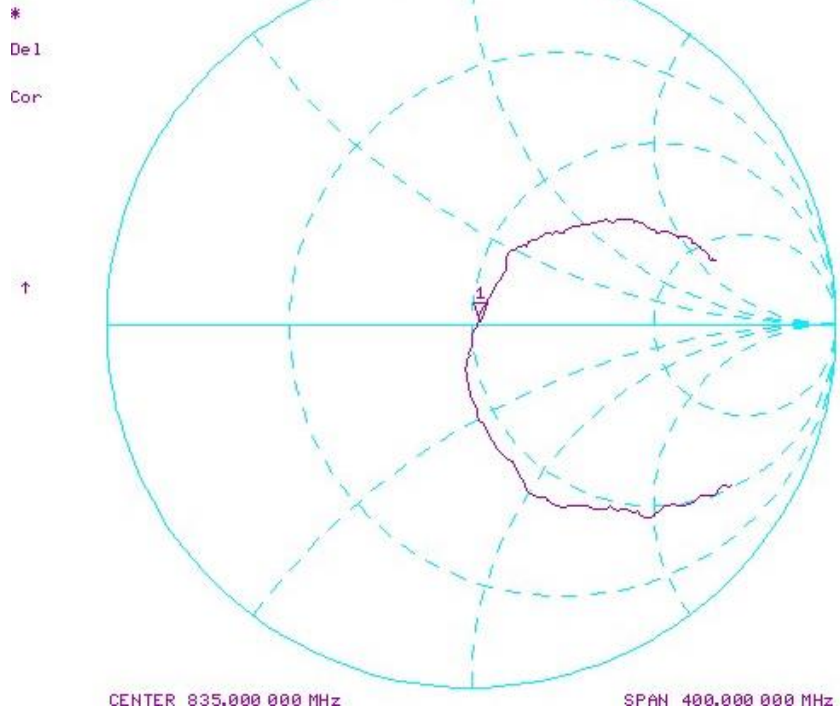

CH1 S11 LOG 5 dB/REF -20 dB 1: -33.186 dB 835.000 000 MHz

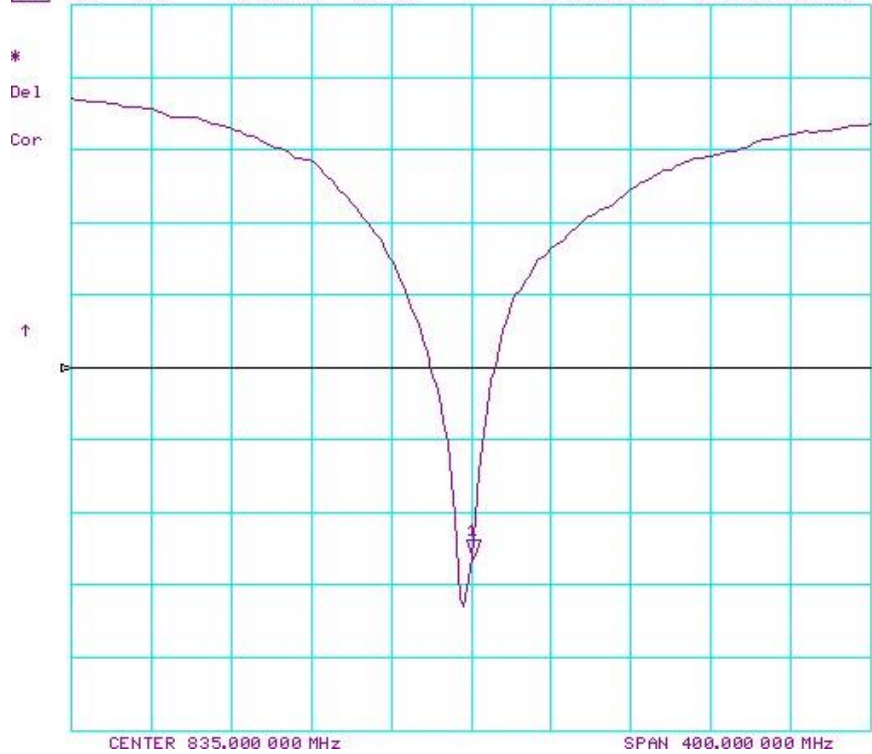



Accredited by the Swiss Accreditation Service (SAS)  
The Swiss Accreditation Service is one of the signatories to the EA  
Multilateral Agreement for the recognition of calibration certificates

Accreditation No.: **SCS 0108**

Client **Element**

Certificate No: **D1640V2-321\_Dec22**

## CALIBRATION CERTIFICATE

Object: **D1640V2 - SN:321**

Calibration procedure(s): **QA CAL-05.v12**  
**Calibration Procedure for SAR Validation Sources between 0.7-3 GHz**

Calibration date: **December 13, 2022**

*✓ PM*  
*12/21/22*  
**SRS 10/09/24**

This calibration certificate documents the traceability to national standards, which realize the physical units of measurements (SI).  
The measurements and the uncertainties with confidence probability are given on the following pages and are part of the certificate.

All calibrations have been conducted in the closed laboratory facility: environment temperature (22 ± 3)°C and humidity < 70%.

Calibration Equipment used (M&TE critical for calibration)

Primary Standards	ID #	Cal Date (Certificate No.)	Scheduled Calibration
Power meter NRP	SN: 104778	04-Apr-22 (No. 217-03525/03524)	Apr-23
Power sensor NRP-Z91	SN: 103244	04-Apr-22 (No. 217-03524)	Apr-23
Power sensor NRP-Z91	SN: 103245	04-Apr-22 (No. 217-03525)	Apr-23
Reference 20 dB Attenuator	SN: BH9394 (20k)	04-Apr-22 (No. 217-03527)	Apr-23
Type-N mismatch combination	SN: 310982 / 06327	04-Apr-22 (No. 217-03528)	Apr-23
Reference Probe EX3DV4	SN: 7349	31-Dec-21 (No. EX3-7349_Dec21)	Dec-22
DAE4	SN: 601	31-Aug-22 (No. DAE4-601_Aug22)	Aug-23

Secondary Standards	ID #	Check Date (in house)	Scheduled Check
Power meter E4419B	SN: GB39512475	30-Oct-14 (in house check Oct-22)	In house check: Oct-24
Power sensor HP 8481A	SN: US37292783	07-Oct-15 (in house check Oct-22)	In house check: Oct-24
Power sensor HP 8481A	SN: MY41093315	07-Oct-15 (in house check Oct-22)	In house check: Oct-24
RF generator R&S SMT-06	SN: 100972	15-Jun-15 (in house check Oct-22)	In house check: Oct-24
Network Analyzer Agilent E8358A	SN: US41080477	31-Mar-14 (in house check Oct-22)	In house check: Oct-24

Calibrated by: **Paulo Pina** (Name), **Laboratory Technician** (Function), *[Signature]* (Signature)

Approved by: **Sven Kühn** (Name), **Technical Manager** (Function), *[Signature]* (Signature)

Issued: December 13, 2022

This calibration certificate shall not be reproduced except in full without written approval of the laboratory.



Accredited by the Swiss Accreditation Service (SAS)  
The Swiss Accreditation Service is one of the signatories to the EA  
Multilateral Agreement for the recognition of calibration certificates

Accreditation No.: **SCS 0108**

**Glossary:**

TSL	tissue simulating liquid
ConvF	sensitivity in TSL / NORM x,y,z
N/A	not applicable or not measured

**Calibration is Performed According to the Following Standards:**

- a) IEC/IEEE 62209-1528, "Measurement Procedure For The Assessment Of Specific Absorption Rate Of Human Exposure To Radio Frequency Fields From Hand-Held And Body-Worn Wireless Communication Devices - Part 1528: Human Models, Instrumentation And Procedures (Frequency Range of 4 MHz to 10 GHz)", October 2020.
- b) KDB 865664, "SAR Measurement Requirements for 100 MHz to 6 GHz"

**Additional Documentation:**

- c) DASY System Handbook

**Methods Applied and Interpretation of Parameters:**

- *Measurement Conditions:* Further details are available from the Validation Report at the end of the certificate. All figures stated in the certificate are valid at the frequency indicated.
- *Antenna Parameters with TSL:* The source is mounted in a touch configuration below the center marking of the flat phantom.
- *Return Loss:* This parameter is measured with the source positioned under the liquid filled phantom (as described in the measurement condition clause). The Return Loss ensures low reflected power. No uncertainty required.
- *SAR measured:* SAR measured at the stated antenna input power.
- *SAR normalized:* SAR as measured, normalized to an input power of 1 W at the antenna connector.
- *SAR for nominal TSL parameters:* The measured TSL parameters are used to calculate the nominal SAR result.

The reported uncertainty of measurement is stated as the standard uncertainty of measurement multiplied by the coverage factor  $k=2$ , which for a normal distribution corresponds to a coverage probability of approximately 95%.

## Measurement Conditions

DASY system configuration, as far as not given on page 1.

<b>DASY Version</b>	DASY52	V52.10.4
<b>Extrapolation</b>	Advanced Extrapolation	
<b>Phantom</b>	Modular Flat Phantom	
<b>Distance Dipole Center - TSL</b>	10 mm	with Spacer
<b>Zoom Scan Resolution</b>	dx, dy, dz = 5 mm	
<b>Frequency</b>	1640 MHz $\pm$ 1 MHz	

## Head TSL parameters

The following parameters and calculations were applied.

	Temperature	Permittivity	Conductivity
<b>Nominal Head TSL parameters</b>	22.0 °C	40.2	1.31 mho/m
<b>Measured Head TSL parameters</b>	(22.0 $\pm$ 0.2) °C	40.7 $\pm$ 6 %	1.29 mho/m $\pm$ 6 %
<b>Head TSL temperature change during test</b>	< 0.5 °C	----	----

## SAR result with Head TSL

<b>SAR averaged over 1 cm<sup>3</sup> (1 g) of Head TSL</b>	Condition	
SAR measured	250 mW input power	8.51 W/kg
SAR for nominal Head TSL parameters	normalized to 1W	<b>34.5 W/kg <math>\pm</math> 17.0 % (k=2)</b>

<b>SAR averaged over 10 cm<sup>3</sup> (10 g) of Head TSL</b>	condition	
SAR measured	250 mW input power	4.60 W/kg
SAR for nominal Head TSL parameters	normalized to 1W	<b>18.5 W/kg <math>\pm</math> 16.5 % (k=2)</b>

## Body TSL parameters

The following parameters and calculations were applied.

	Temperature	Permittivity	Conductivity
<b>Nominal Body TSL parameters</b>	22.0 °C	53.7	1.42 mho/m
<b>Measured Body TSL parameters</b>	(22.0 $\pm$ 0.2) °C	53.4 $\pm$ 6 %	1.41 mho/m $\pm$ 6 %
<b>Body TSL temperature change during test</b>	< 0.5 °C	----	----

## SAR result with Body TSL

<b>SAR averaged over 1 cm<sup>3</sup> (1 g) of Body TSL</b>	Condition	
SAR measured	250 mW input power	8.59 W/kg
SAR for nominal Body TSL parameters	normalized to 1W	<b>34.5 W/kg <math>\pm</math> 17.0 % (k=2)</b>

<b>SAR averaged over 10 cm<sup>3</sup> (10 g) of Body TSL</b>	condition	
SAR measured	250 mW input power	4.69 W/kg
SAR for nominal Body TSL parameters	normalized to 1W	<b>18.8 W/kg <math>\pm</math> 16.5 % (k=2)</b>

## Appendix (Additional assessments outside the scope of SCS 0108)

### Antenna Parameters with Head TSL

Impedance, transformed to feed point	52.1 $\Omega$ + 2.9 j $\Omega$
Return Loss	- 29.1 dB

### Antenna Parameters with Body TSL

Impedance, transformed to feed point	47.9 $\Omega$ + 3.4 j $\Omega$
Return Loss	- 27.8 dB

### General Antenna Parameters and Design

Electrical Delay (one direction)	1.229 ns
----------------------------------	----------

After long term use with 100W radiated power, only a slight warming of the dipole near the feedpoint can be measured.

The dipole is made of standard semirigid coaxial cable. The center conductor of the feeding line is directly connected to the second arm of the dipole. The antenna is therefore short-circuited for DC-signals. On some of the dipoles, small end caps are added to the dipole arms in order to improve matching when loaded according to the position as explained in the "Measurement Conditions" paragraph. The SAR data are not affected by this change. The overall dipole length is still according to the Standard.

No excessive force must be applied to the dipole arms, because they might bend or the soldered connections near the feedpoint may be damaged.

### Additional EUT Data

Manufactured by	SPEAG
-----------------	-------

# DASY5 Validation Report for Head TSL

Date: 13.12.2022

Test Laboratory: SPEAG, Zurich, Switzerland

**DUT: Dipole 1640 MHz; Type: D1640V2; Serial: D1640V2 - SN:321**

Communication System: UID 0 - CW; Frequency: 1640 MHz

Medium parameters used:  $f = 1640$  MHz;  $\sigma = 1.29$  S/m;  $\epsilon_r = 40.7$ ;  $\rho = 1000$  kg/m<sup>3</sup>

Phantom section: Flat Section

Measurement Standard: DASY5 (IEEE/IEC/ANSI C63.19-2011)

DASY52 Configuration:

- Probe: EX3DV4 - SN7349; ConvF(8.68, 8.68, 8.68) @ 1640 MHz; Calibrated: 31.12.2021
- Sensor-Surface: 1.4mm (Mechanical Surface Detection)
- Electronics: DAE4 Sn601; Calibrated: 31.08.2022
- Phantom: Flat Phantom 5.0 (front); Type: QD 000 P50 AA; Serial: 1001
- DASY52 52.10.4(1535); SEMCAD X 14.6.14(7501)

## Dipole Calibration for Head Tissue/Pin=250 mW, d=10mm/Zoom Scan (7x7x7)/Cube 0:

Measurement grid: dx=5mm, dy=5mm, dz=5mm

Reference Value = 103.9 V/m; Power Drift = 0.05 dB

Peak SAR (extrapolated) = 15.4 W/kg

**SAR(1 g) = 8.51 W/kg; SAR(10 g) = 4.60 W/kg**

Smallest distance from peaks to all points 3 dB below = 10 mm

Ratio of SAR at M2 to SAR at M1 = 55.8%

Maximum value of SAR (measured) = 12.9 W/kg

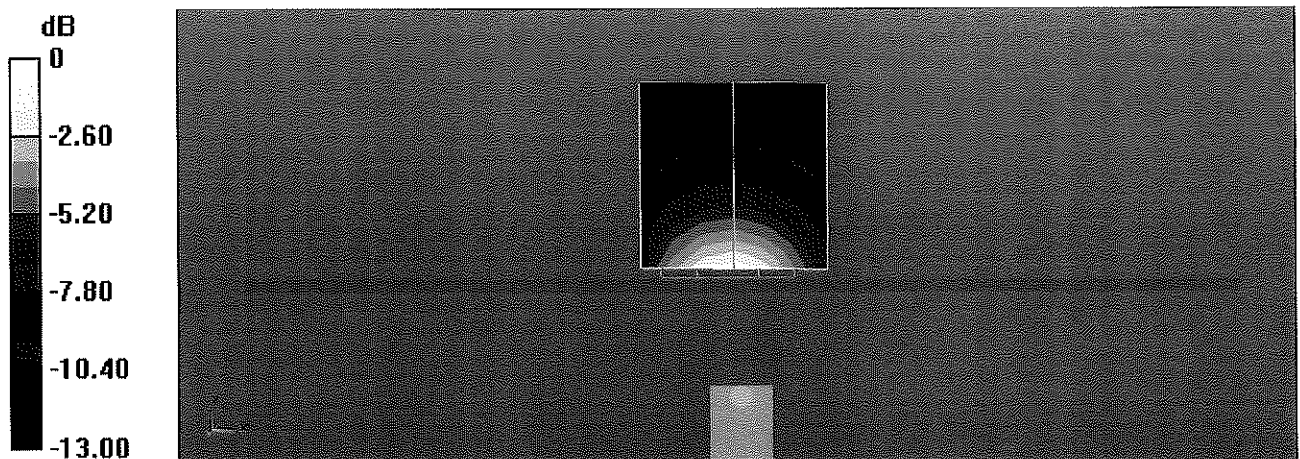

0 dB = 12.9 W/kg = 11.11 dBW/kg

# Impedance Measurement Plot for Head TSL

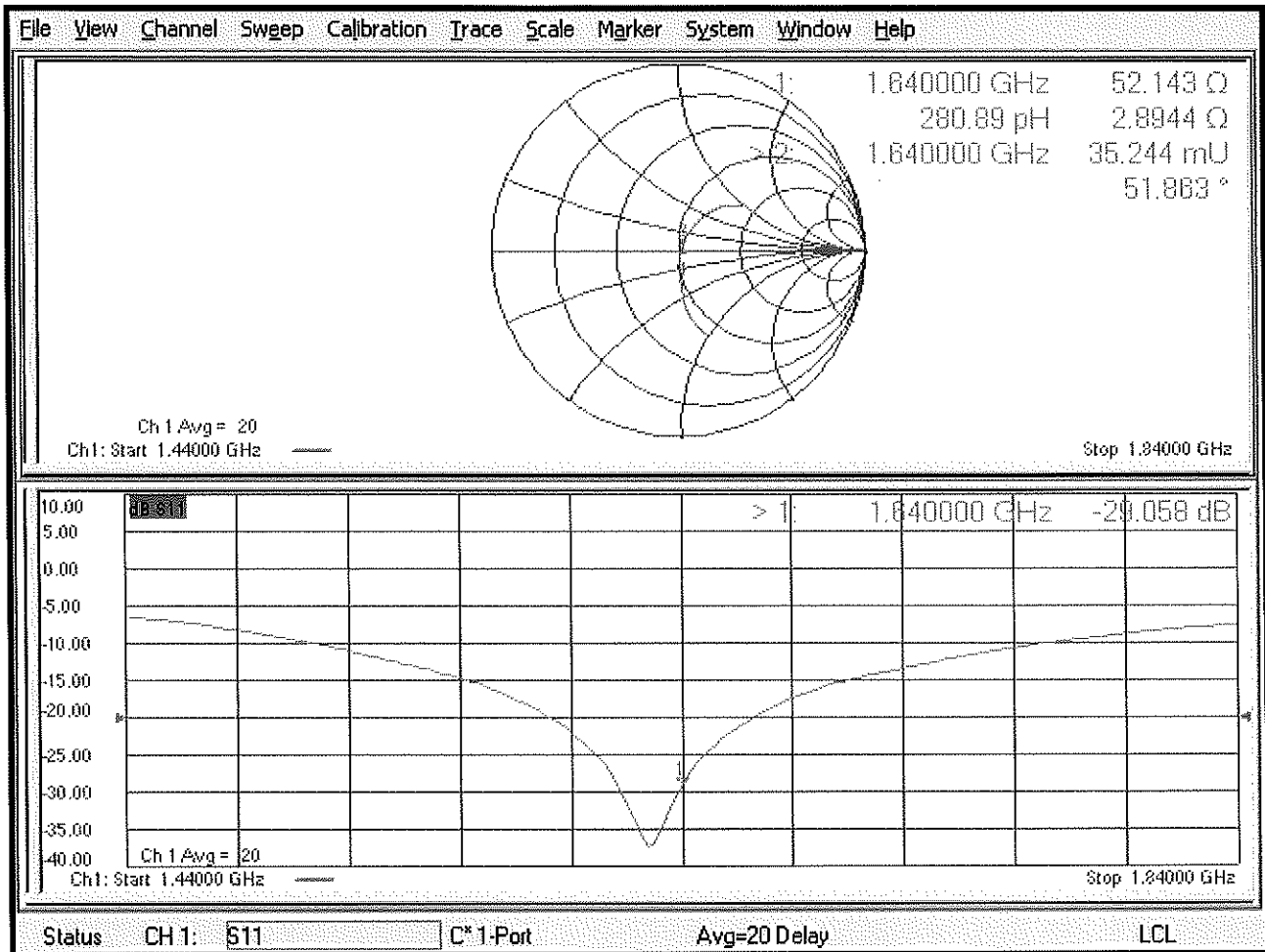

# DASY5 Validation Report for Body TSL

Date: 13.12.2022

Test Laboratory: SPEAG, Zurich, Switzerland

**DUT: Dipole 1640 MHz; Type: D1640V2; Serial: D1640V2 - SN:321**

Communication System: UID 0 - CW; Frequency: 1640 MHz

Medium parameters used:  $f = 1640$  MHz;  $\sigma = 1.41$  S/m;  $\epsilon_r = 53.4$ ;  $\rho = 1000$  kg/m<sup>3</sup>

Phantom section: Flat Section

Measurement Standard: DASY5 (IEEE/IEC/ANSI C63.19-2011)

DASY52 Configuration:

- Probe: EX3DV4 - SN7349; ConvF(8.63, 8.63, 8.63) @ 1640 MHz; Calibrated: 31.12.2021
- Sensor-Surface: 1.4mm (Mechanical Surface Detection)
- Electronics: DAE4 Sn601; Calibrated: 31.08.2022
- Phantom: Flat Phantom 5.0 (back); Type: QD 000 P50 AA; Serial: 1002
- DASY52 52.10.4(1535); SEMCAD X 14.6.14(7501)

## Dipole Calibration for Body Tissue/ $P_{in}=250$ mW, $d=10$ mm/Zoom Scan (7x7x7)/Cube 0:

Measurement grid:  $dx=5$ mm,  $dy=5$ mm,  $dz=5$ mm

Reference Value = 101.1 V/m; Power Drift = -0.04 dB

Peak SAR (extrapolated) = 14.9 W/kg

**SAR(1 g) = 8.59 W/kg; SAR(10 g) = 4.69 W/kg**

Smallest distance from peaks to all points 3 dB below = 10 mm

Ratio of SAR at M2 to SAR at M1 = 58.3%

Maximum value of SAR (measured) = 12.8 W/kg

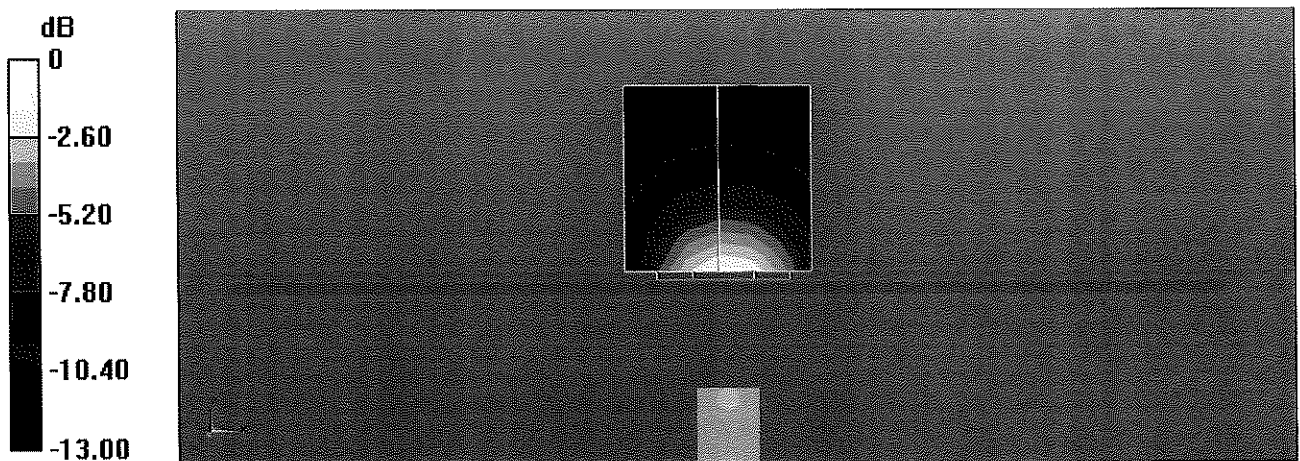

0 dB = 12.8 W/kg = 11.07 dBW/kg



# Impedance Measurement Plot for Body TSL

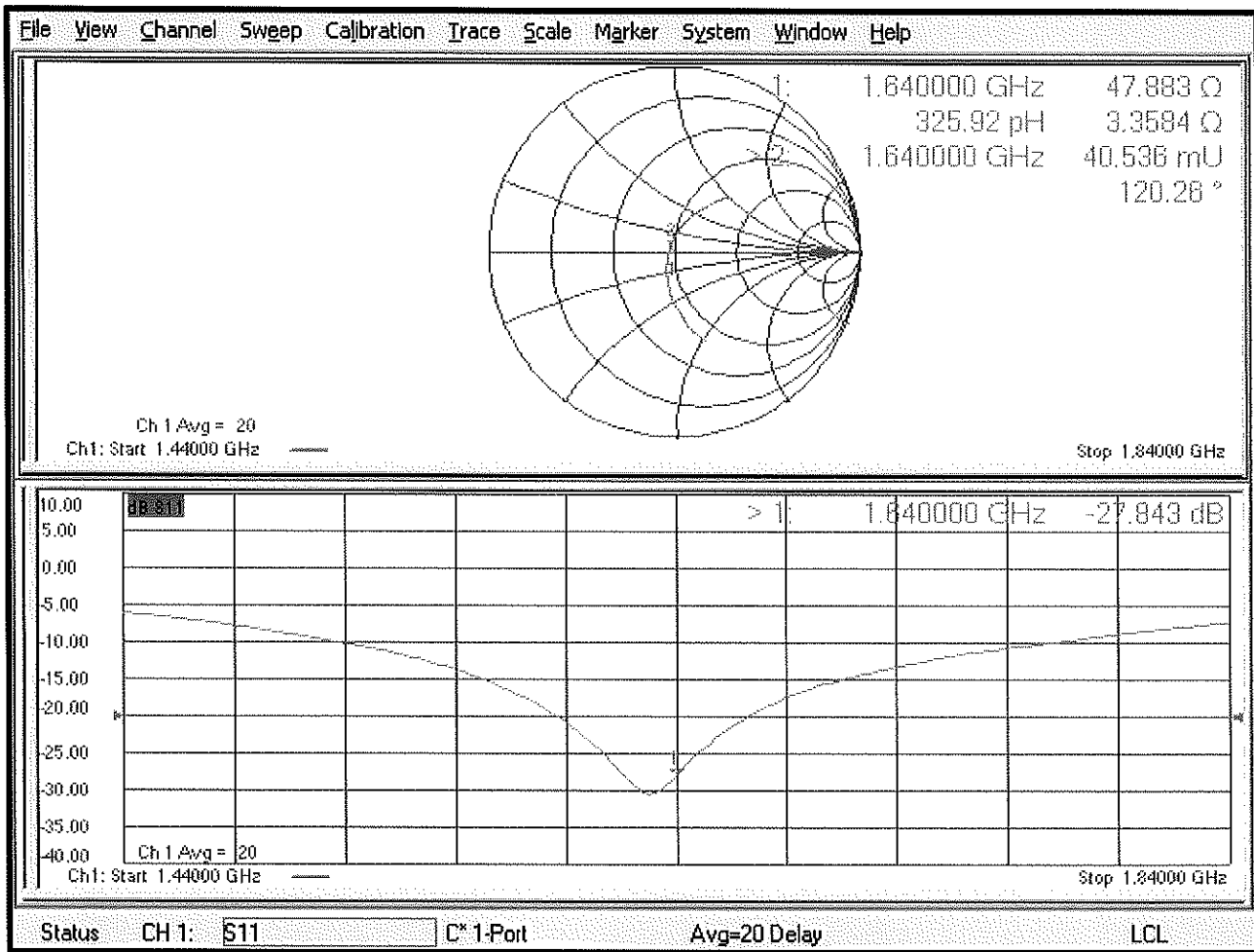

# Certification of Calibration

Object: D1640V2 – SN: 321

Calibration procedure(s): Procedure for Calibration Extension for SAR



Extension Calibration date: Dipoles. 10/06/2024

Description: SAR Validation Dipole at 1640 MHz.

**Calibration Equipment used:**

Manufacturer	Model	Description	Cal Date	Cal Interval	Cal Due	Serial Number
Agilent	N5182A	MXG Vector Signal Generator	3/7/2024	Annual	3/7/2025	MY47420603
Amplifier Research	15S1G6	Amplifier	CBT	N/A	CBT	343971
Anritsu	MA24106A	USB Power Sensor	3/14/2024	Annual	3/14/2025	1349513
Control Company	4040	Digital Thermometer	3/27/2023	Biennial	3/27/2025	230208311
Control Company	4052	Long Stem Thermometer	2/27/2024	Annual	2/27/2025	240171059
Mini-Circuits	BW-N20W5+	DC to 18 GHz Precision Fixed 20 dB Attenuator	CBT	N/A	CBT	N/A
Mini-Circuits	NLP-2950+	Low Pass Filter DC to 2700 MHz	CBT	N/A	CBT	N/A
Narda	4772-3	Attenuator (3dB)	CBT	N/A	CBT	9406
Pasternack	NC-100	Torque Wrench	12/5/2022	Biennial	12/5/2024	1240
Mini-Circuits	ZHDC-16-63-S+	Coupler	CBT	N/A	CBT	N/A
Rohde & Schwarz	ZNLE6	Vector Network Analyzer	3/8/2024	Annual	3/8/2025	1204153
SPEAG	DAK-3.5	Dielectric Assessment Kit	11/13/2023	Annual	11/13/2024	1277
Keysight Technologies	85033E	Standard Mechanical Calibration Kit (DC to 9GHz, 3.5mm)	2/12/2024	Annual	2/12/2025	MY53401181
SPEAG	EX3DV4	SAR Probe	1/15/2024	Annual	1/15/2025	7570
SPEAG	DAE4	Dasy Data Acquisition Electronics	1/16/2024	Annual	1/16/2025	1530

Measurement Uncertainty =  $\pm 23\%$  (k=2)

	Name	Function	Signature
Calibrated By:	Bizunesh Baldinazzo	Test Engineer	
Approved By:	Greg Snyder	Executive VP of Operations, Regulatory	

# DIPOLE CALIBRATION EXTENSION

Per KDB 865664 D01, calibration intervals of up to three years may be considered for reference dipoles when it is demonstrated that the SAR target, impedance and return loss of a dipole have remained stable according to the following requirements:

1. The measured SAR does not deviate more than 10% from the target on the calibration certificate.
2. The return-loss does not deviate more than 20% from the previous measurement and meets the required 20dB minimum return-loss requirement.
3. The measurement of real or imaginary parts of impedance does not deviate more than 5Ω from the previous measurement.

The following dipole was checked to pass the above 3 requirements to have 2-year calibration period from the calibration date:

Calibration Date	Extension Date	Certificate Electrical Delay (ns)	Certificate SAR Target Head (1g) W/kg @ 20.0	Measured Head SAR (1g) W/kg @ 20.0 dBm	Deviation 1g (%)	Certificate SAR Target Head (10g) W/kg @ 20.0	Measured Head SAR (10g) W/kg @ 20.0 dBm	Deviation 10g (%)	Certificate Impedance Head (Ohm) Real	Measured Impedance Head (Ohm) Real	Difference (Ohm) Real	Certificate Impedance Head (Ohm) Imaginary	Measured Impedance Head (Ohm) Imaginary	Difference (Ohm) Imaginary	Certificate Return Loss Head (dB)	Measured Return Loss Head (dB)	Deviation (%)	PASS/FAIL
12/13/2022	10/6/2024	1.229	3.450	3.65	5.80%	1.850	2.01	8.65%	52.1	47.4	4.7	2.9	1.0	1.9	-29.1	-31.7	-8.90%	PASS

# Impedance & Return-Loss Measurement Plot for Head TSL

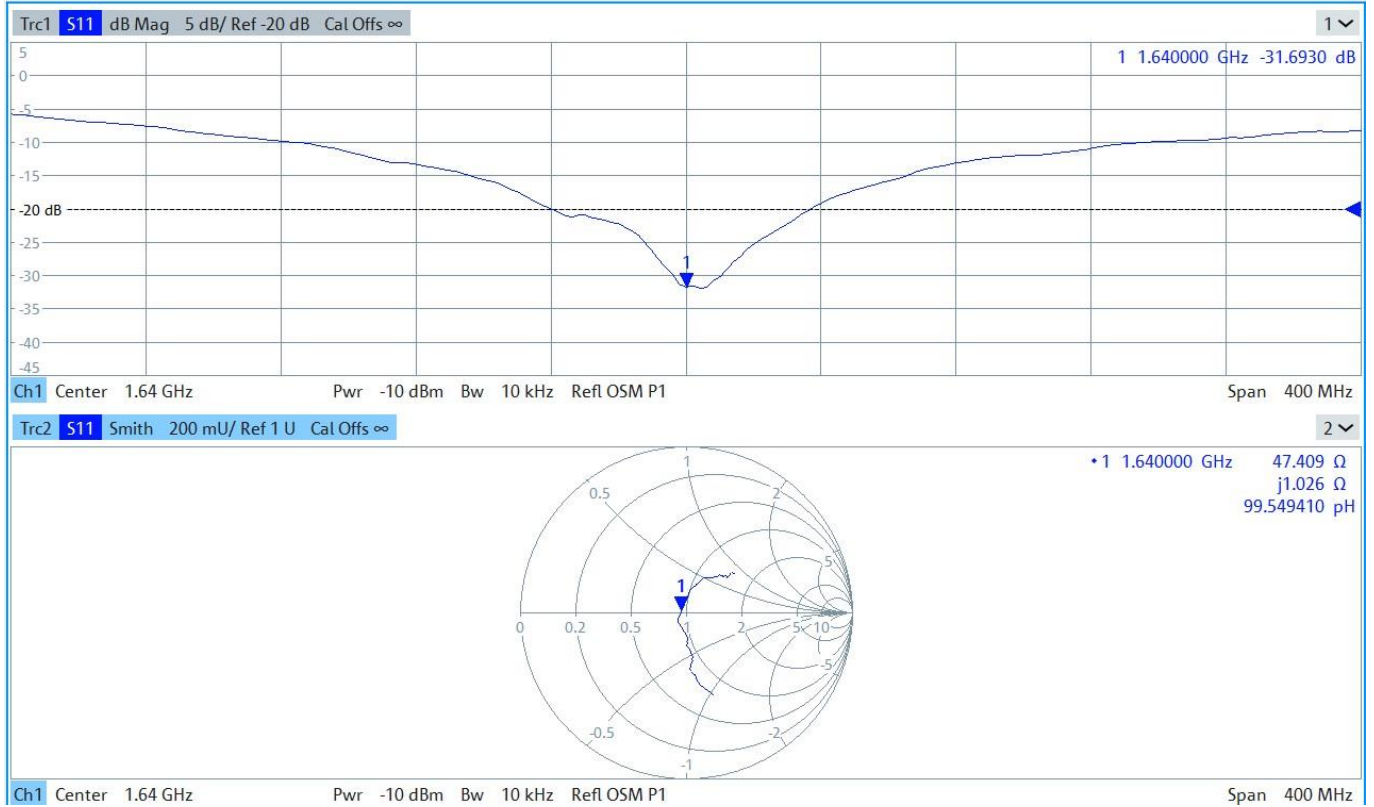



Accredited by the Swiss Accreditation Service (SAS)  
The Swiss Accreditation Service is one of the signatories to the EA  
Multilateral Agreement for the recognition of calibration certificates

Accreditation No.: **SCS 0108**

Client **Element**

Certificate No: **D1750V2-1040\_Nov22**

## CALIBRATION CERTIFICATE

Object **D1750V2 - SN:1040** ✓ *ATM*

Calibration procedure(s) **QA CAL-05.v11  
Calibration Procedure for SAR Validation Sources between 0.7-3 GHz**

Calibration date: **November 17, 2022**

✓ **YW 12/13/2023**

✓ **YW 11/19/2024**

This calibration certificate documents the traceability to national standards, which realize the physical units of measurements (SI).  
The measurements and the uncertainties with confidence probability are given on the following pages and are part of the certificate.

All calibrations have been conducted in the closed laboratory facility: environment temperature (22 ± 3)°C and humidity < 70%.

Calibration Equipment used (M&TE critical for calibration)

Primary Standards	ID #	Cal Date (Certificate No.)	Scheduled Calibration
Power meter NRP	SN: 104778	04-Apr-22 (No. 217-03525/03524)	Apr-23
Power sensor NRP-Z91	SN: 103244	04-Apr-22 (No. 217-03524)	Apr-23
Power sensor NRP-Z91	SN: 103245	04-Apr-22 (No. 217-03525)	Apr-23
Reference 20 dB Attenuator	SN: BH9394 (20k)	04-Apr-22 (No. 217-03527)	Apr-23
Type-N mismatch combination	SN: 310982 / 06327	04-Apr-22 (No. 217-03528)	Apr-23
Reference Probe EX3DV4	SN: 7349	31-Dec-21 (No. EX3-7349_Dec21)	Dec-22
DAE4	SN: 601	31-Aug-22 (No. DAE4-601_Aug22)	Aug-23

Secondary Standards	ID #	Check Date (in house)	Scheduled Check
Power meter E4419B	SN: GB39512475	30-Oct-14 (in house check Oct-22)	In house check: Oct-24
Power sensor HP 8481A	SN: US37292783	07-Oct-15 (in house check Oct-22)	In house check: Oct-24
Power sensor HP 8481A	SN: MY41093315	07-Oct-15 (in house check Oct-22)	In house check: Oct-24
RF generator R&S SMT-06	SN: 100972	15-Jun-15 (in house check Oct-22)	In house check: Oct-24
Network Analyzer Agilent E8358A	SN: US41080477	31-Mar-14 (in house check Oct-22)	In house check: Oct-24

Calibrated by: **Jeton Kastrati** (Name) **Laboratory Technician** (Function) *[Signature]* (Signature)

Approved by: **Sven Kühn** (Name) **Technical Manager** (Function) *[Signature]* (Signature)

Issued: November 17, 2022

This calibration certificate shall not be reproduced except in full without written approval of the laboratory.



Accredited by the Swiss Accreditation Service (SAS)

The Swiss Accreditation Service is one of the signatories to the EA Multilateral Agreement for the recognition of calibration certificates

### Glossary:

TSL	tissue simulating liquid
ConvF	sensitivity in TSL / NORM x,y,z
N/A	not applicable or not measured

### Calibration is Performed According to the Following Standards:

- a) IEC/IEEE 62209-1528, "Measurement Procedure For The Assessment Of Specific Absorption Rate Of Human Exposure To Radio Frequency Fields From Hand-Held And Body-Worn Wireless Communication Devices - Part 1528: Human Models, Instrumentation And Procedures (Frequency Range of 4 MHz to 10 GHz)", October 2020.
- b) KDB 865664, "SAR Measurement Requirements for 100 MHz to 6 GHz"

### Additional Documentation:

- c) DASY System Handbook

### Methods Applied and Interpretation of Parameters:

- *Measurement Conditions:* Further details are available from the Validation Report at the end of the certificate. All figures stated in the certificate are valid at the frequency indicated.
- *Antenna Parameters with TSL:* The source is mounted in a touch configuration below the center marking of the flat phantom.
- *Return Loss:* This parameter is measured with the source positioned under the liquid filled phantom (as described in the measurement condition clause). The Return Loss ensures low reflected power. No uncertainty required.
- *SAR measured:* SAR measured at the stated antenna input power.
- *SAR normalized:* SAR as measured, normalized to an input power of 1 W at the antenna connector.
- *SAR for nominal TSL parameters:* The measured TSL parameters are used to calculate the nominal SAR result.

The reported uncertainty of measurement is stated as the standard uncertainty of measurement multiplied by the coverage factor  $k=2$ , which for a normal distribution corresponds to a coverage probability of approximately 95%.

## Measurement Conditions

DASY system configuration, as far as not given on page 1.

DASY Version	DASY52	V52.10.4
Extrapolation	Advanced Extrapolation	
Phantom	Modular Flat Phantom	
Distance Dipole Center - TSL	10 mm	with Spacer
Zoom Scan Resolution	dx, dy, dz = 5 mm	
Frequency	1750 MHz $\pm$ 1 MHz	

## Head TSL parameters

The following parameters and calculations were applied.

	Temperature	Permittivity	Conductivity
Nominal Head TSL parameters	22.0 °C	40.1	1.37 mho/m
Measured Head TSL parameters	(22.0 $\pm$ 0.2) °C	38.9 $\pm$ 6 %	1.34 mho/m $\pm$ 6 %
Head TSL temperature change during test	< 0.5 °C	----	----

## SAR result with Head TSL

SAR averaged over 1 cm <sup>3</sup> (1 g) of Head TSL	Condition	
SAR measured	250 mW input power	9.04 W/kg
SAR for nominal Head TSL parameters	normalized to 1W	<b>36.4 W/kg <math>\pm</math> 17.0 % (k=2)</b>

SAR averaged over 10 cm <sup>3</sup> (10 g) of Head TSL	condition	
SAR measured	250 mW input power	4.77 W/kg
SAR for nominal Head TSL parameters	normalized to 1W	<b>19.1 W/kg <math>\pm</math> 16.5 % (k=2)</b>

## Body TSL parameters

The following parameters and calculations were applied.

	Temperature	Permittivity	Conductivity
Nominal Body TSL parameters	22.0 °C	53.4	1.49 mho/m
Measured Body TSL parameters	(22.0 $\pm$ 0.2) °C	53.7 $\pm$ 6 %	1.46 mho/m $\pm$ 6 %
Body TSL temperature change during test	< 0.5 °C	----	----

## SAR result with Body TSL

SAR averaged over 1 cm <sup>3</sup> (1 g) of Body TSL	Condition	
SAR measured	250 mW input power	9.26 W/kg
SAR for nominal Body TSL parameters	normalized to 1W	<b>37.6 W/kg <math>\pm</math> 17.0 % (k=2)</b>

SAR averaged over 10 cm <sup>3</sup> (10 g) of Body TSL	condition	
SAR measured	250 mW input power	4.92 W/kg
SAR for nominal Body TSL parameters	normalized to 1W	<b>19.8 W/kg <math>\pm</math> 16.5 % (k=2)</b>

## Appendix (Additional assessments outside the scope of SCS 0108)

### Antenna Parameters with Head TSL

Impedance, transformed to feed point	50.7 $\Omega$ - 0.4 j $\Omega$
Return Loss	- 42.1 dB

### Antenna Parameters with Body TSL

Impedance, transformed to feed point	46.6 $\Omega$ - 0.7 j $\Omega$
Return Loss	- 28.9 dB

### General Antenna Parameters and Design

Electrical Delay (one direction)	1.220 ns
----------------------------------	----------

After long term use with 100W radiated power, only a slight warming of the dipole near the feedpoint can be measured.

The dipole is made of standard semirigid coaxial cable. The center conductor of the feeding line is directly connected to the second arm of the dipole. The antenna is therefore short-circuited for DC-signals. On some of the dipoles, small end caps are added to the dipole arms in order to improve matching when loaded according to the position as explained in the "Measurement Conditions" paragraph. The SAR data are not affected by this change. The overall dipole length is still according to the Standard.

No excessive force must be applied to the dipole arms, because they might bend or the soldered connections near the feedpoint may be damaged.

### Additional EUT Data

Manufactured by	SPEAG
-----------------	-------



# DASY5 Validation Report for Head TSL

Date: 16.11.2022

Test Laboratory: SPEAG, Zurich, Switzerland

**DUT: Dipole 1750 MHz; Type: D1750V2; Serial: D1750V2 - SN:1040**

Communication System: UID 0 - CW; Frequency: 1750 MHz

Medium parameters used:  $f = 1750$  MHz;  $\sigma = 1.34$  S/m;  $\epsilon_r = 38.9$ ;  $\rho = 1000$  kg/m<sup>3</sup>

Phantom section: Flat Section

Measurement Standard: DASY5 (IEEE/IEC/ANSI C63.19-2011)

DASY52 Configuration:

- Probe: EX3DV4 - SN7349; ConvF(8.67, 8.67, 8.67) @ 1750 MHz; Calibrated: 31.12.2021
- Sensor-Surface: 1.4mm (Mechanical Surface Detection)
- Electronics: DAE4 Sn601; Calibrated: 31.08.2022
- Phantom: Flat Phantom 5.0 (front); Type: QD 000 P50 AA; Serial: 1001
- DASY52 52.10.4(1535); SEMCAD X 14.6.14(7501)

## Dipole Calibration for Head Tissue/ $P_{in}=250$ mW, $d=10$ mm/Zoom Scan (7x7x7)/Cube 0:

Measurement grid:  $dx=5$ mm,  $dy=5$ mm,  $dz=5$ mm

Reference Value = 108.6 V/m; Power Drift = -0.09 dB

Peak SAR (extrapolated) = 16.9 W/kg

**SAR(1 g) = 9.04 W/kg; SAR(10 g) = 4.77 W/kg**

Smallest distance from peaks to all points 3 dB below = 10 mm

Ratio of SAR at M2 to SAR at M1 = 53.7%

Maximum value of SAR (measured) = 14.1 W/kg

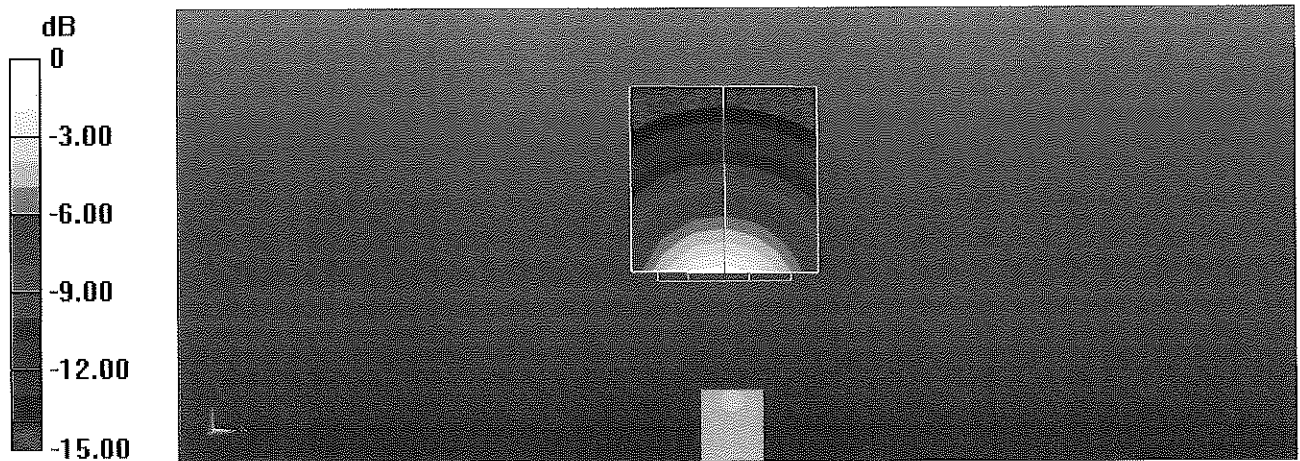

0 dB = 14.1 W/kg = 11.50 dBW/kg

# Impedance Measurement Plot for Head TSL

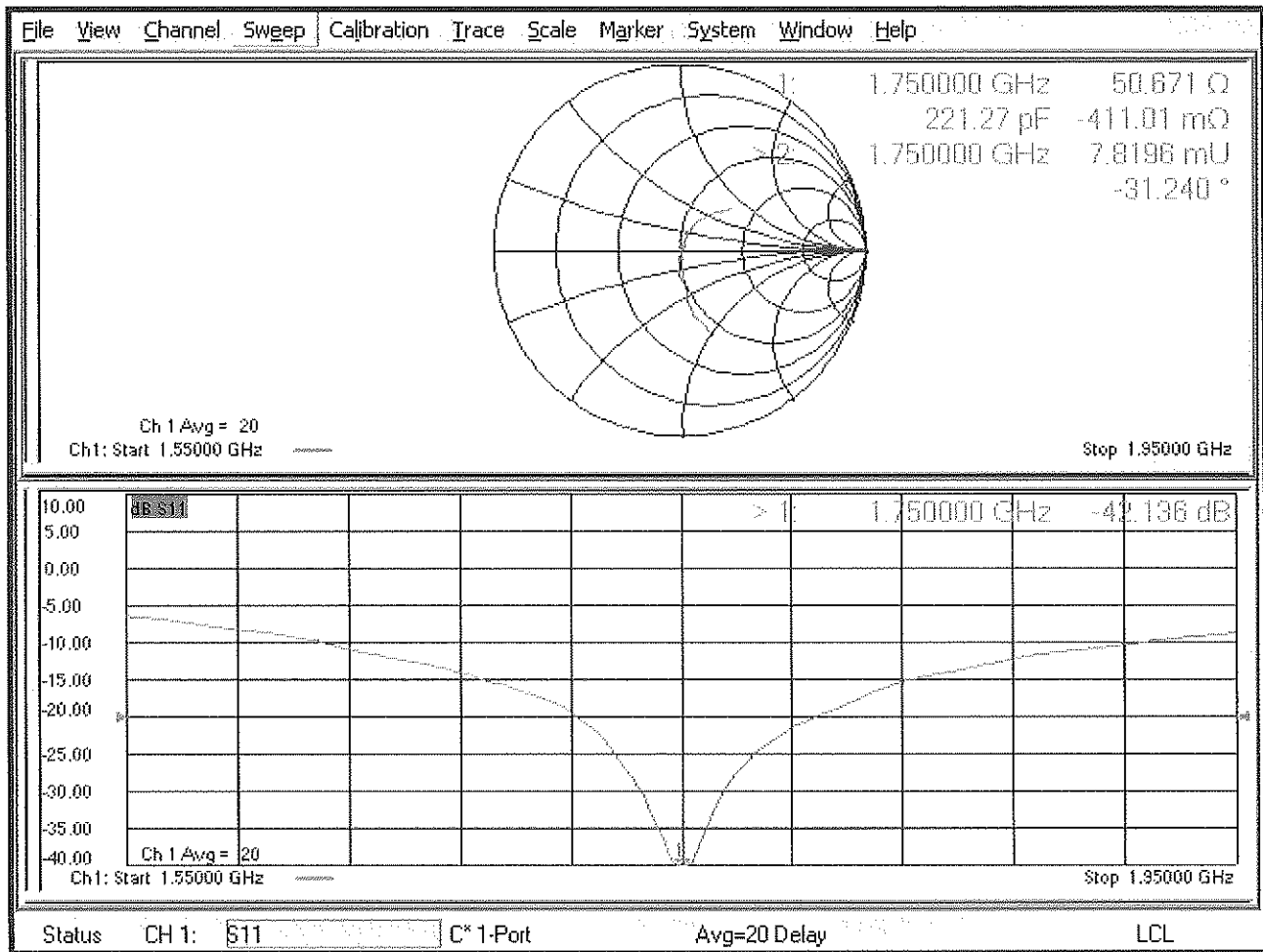

## DASY5 Validation Report for Body TSL

Date: 17.11.2022

Test Laboratory: SPEAG, Zurich, Switzerland

**DUT: Dipole 1750 MHz; Type: D1750V2; Serial: D1750V2 - SN:1040**

Communication System: UID 0 - CW; Frequency: 1750 MHz

Medium parameters used:  $f = 1750$  MHz;  $\sigma = 1.46$  S/m;  $\epsilon_r = 53.7$ ;  $\rho = 1000$  kg/m<sup>3</sup>

Phantom section: Flat Section

Measurement Standard: DASY5 (IEEE/IEC/ANSI C63.19-2011)

DASY52 Configuration:

- Probe: EX3DV4 - SN7349; ConvF(8.48, 8.48, 8.48) @ 1750 MHz; Calibrated: 31.12.2021
- Sensor-Surface: 1.4mm (Mechanical Surface Detection)
- Electronics: DAE4 Sn601; Calibrated: 31.08.2022
- Phantom: Flat Phantom 5.0 (back); Type: QD 000 P50 AA; Serial: 1002
- DASY52 52.10.4(1535); SEMCAD X 14.6.14(7501)

### Dipole Calibration for Body Tissue/Pin=250 mW, d=10mm/Zoom Scan (7x7x7)/Cube 0:

Measurement grid: dx=5mm, dy=5mm, dz=5mm

Reference Value = 101.6 V/m; Power Drift = -0.06 dB

Peak SAR (extrapolated) = 16.7 W/kg

**SAR(1 g) = 9.26 W/kg; SAR(10 g) = 4.92 W/kg**

Smallest distance from peaks to all points 3 dB below = 10 mm

Ratio of SAR at M2 to SAR at M1 = 56.5%

Maximum value of SAR (measured) = 14.0 W/kg

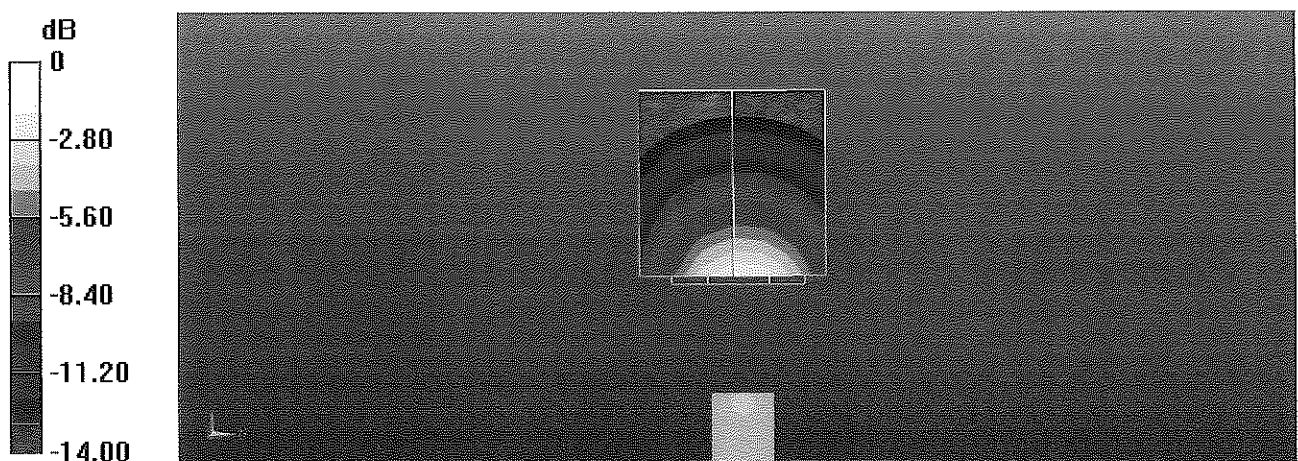

0 dB = 14.0 W/kg = 11.45 dBW/kg

# Impedance Measurement Plot for Body TSL

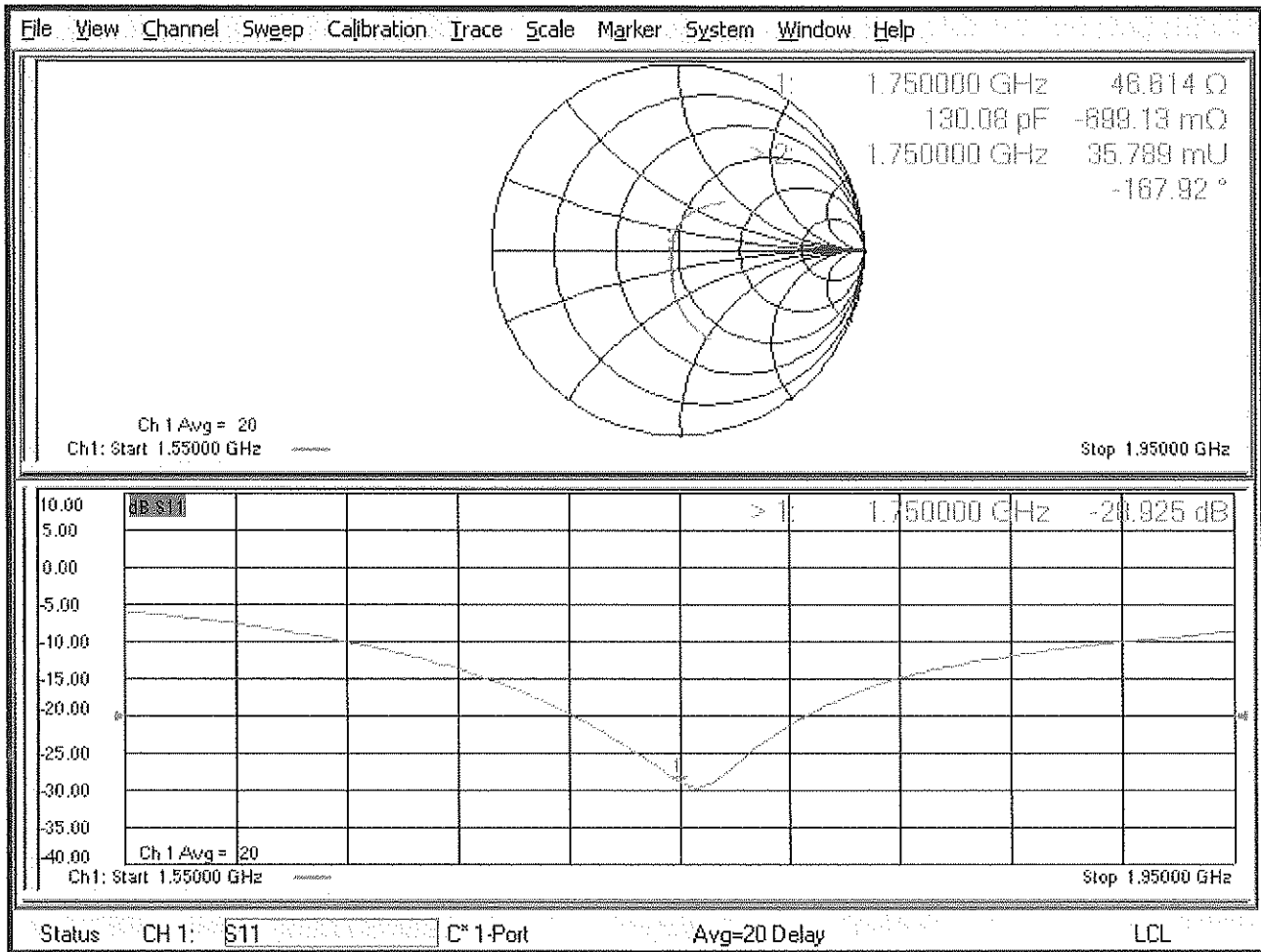



# Certification of Calibration

Object: D1750V2 – SN: 1040  
 Calibration procedure(s): Procedure for Calibration Extension for SAR Dipoles.  
 Extension Calibration date: November 17, 2023  
 Description: SAR Validation Dipole at 1750 MHz.

Calibration Equipment used:

Manufacturer	Model	Description	Cal Date	Cal Interval	Cal Due	Serial Number
Agilent	8753ES	S-Parameter Vector Network Analyzer	6/2/2023	Annual	6/12/2024	MY40003841
Agilent	E4438C	ESG Vector Signal Generator	4/25/2023	Annual	4/25/2024	US41460739
Amplifier Research	15S1G6	Amplifier	CBT	N/A	CBT	343972
Rohde & Schwarz	NRX	Power Meter	1/11/2023	Annual	1/11/2024	102583
Rohde & Schwarz	NRP-Z81	Wide Band Power Sensor	1/19/2023	Annual	1/19/2024	106563
Rohde & Schwarz	NRP-Z81	Wide Band Power Sensor	1/11/2023	Annual	1/11/2024	106564
Traceable	4040 90080-06	Therm./ Clock/ Humidity Monitor	5/11/2022	Biennial	5/11/2024	221514974
Control Company	4353	Ultra Long Stem Thermometer	10/24/2023	Annual	10/24/2024	200645916
Agilent	85033E	3.5mm Standard Calibration Kit	7/18/2023	Annual	7/18/2024	MY53402352
Mini-Circuits	VLf-6000+	Low Pass Filter DC to 6000 MHz	CBT	N/A	CBT	N/A
Narda	4772-3	Attenuator (3dB)	CBT	N/A	CBT	9406
Mini-Circuits	ZHDC-16-63-S+	50-6000MHz Bidirectional Coupler	CBT	N/A	CBT	N/A
Pasternack	NC-100	Torque Wrench	12/5/2022	Biennial	12/5/2024	N/A
SPEAG	DAK-3.5	Dielectric Assessment Kit	5/9/2023	Annual	5/9/2024	1070
SPEAG	EX3DV4	SAR Probe	11/9/2023	Annual	11/9/2024	7639
SPEAG	DAE4	Dasy Data Acquisition Electronics	11/14/2023	Annual	11/14/2024	1403

Measurement Uncertainty = ±23% (k=2)

	Name	Function	Signature
Calibrated By:	Arturo Oliveros	Compliance Engineer	
Approved By:	Greg Snyder	Executive VP of Operations	

# DIPOLE CALIBRATION EXTENSION

Per KDB 865664 D01, calibration intervals of up to three years may be considered for reference dipoles when it is demonstrated that the SAR target, impedance and return loss of a dipole have remained stable according to the following requirements:

1. The measured SAR does not deviate more than 10% from the target on the calibration certificate.
2. The return-loss does not deviate more than 20% from the previous measurement and meets the required 20dB minimum return-loss requirement.
3. The measurement of real or imaginary parts of impedance does not deviate more than 5Ω from the previous measurement.

The following dipole was checked to pass the above 3 requirements to have 2-year calibration period from the calibration date:

Calibration Date	Extension Date	Certificate Electrical Delay (ns)	Certificate SAR Target Head (1g) W/kg @ 20.0 dBm	Measured Head SAR (1g) W/kg @ 20.0 dBm	Deviation 1g (%)	Certificate SAR Target Head (10g) W/kg @ 20.0 dBm	Measured Head SAR (10g) W/kg @ 20.0 dBm	Deviation 10g (%)	Certificate Impedance Head (Ohm) Real	Measured Impedance Head (Ohm) Real	Difference (Ohm) Real	Certificate Impedance Head (Ohm) Imaginary	Measured Impedance Head (Ohm) Imaginary	Difference (Ohm) Imaginary	Certificate Return Loss Head (dB)	Measured Return Loss Head (dB)	Deviation (%)
11/17/2022	11/17/2023	1.22	3.64	3.58	-1.65%	1.91	1.93	1.05%	50.7	49.7	1	-0.4	-1.3	0.9	-42.1	-40	5.00%

# Impedance & Return-Loss Measurement Plot for Head TSL

[CH1] S11 1 U FS 1: 49.693  $\Omega$  -1.2520  $\Omega$  72.643 pF 1 750.000 000 MHz

\*  
De1  
Cor  
  
↑

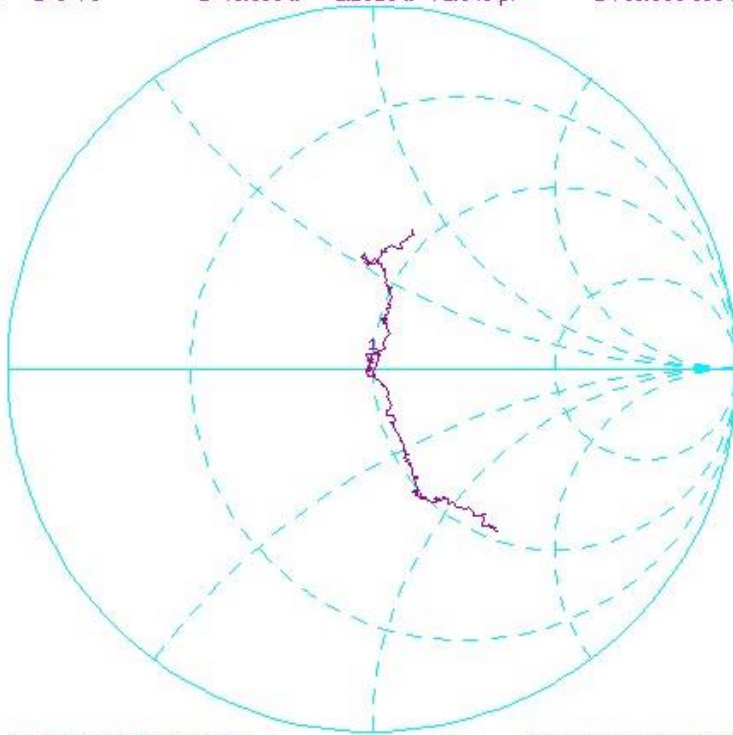

CENTER 1 750.000 000 MHz SPAN 400.000 000 MHz

[CH1] S11 LOG 5 dB/REF -20 dB 1:-39.993 dB 1 750.000 000 MHz

\*  
De1  
Cor  
  
↑

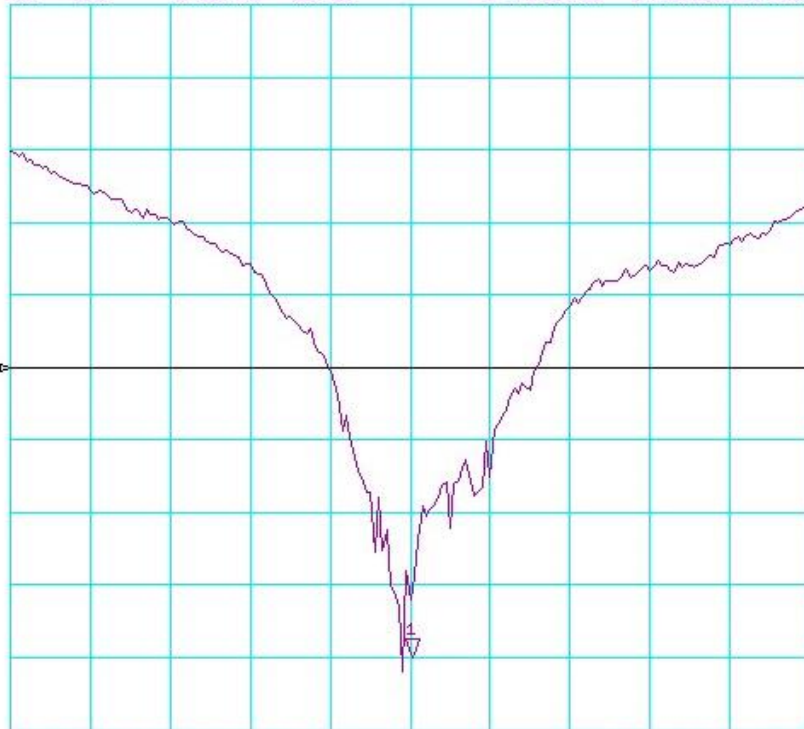

CENTER 1 750.000 000 MHz SPAN 400.000 000 MHz

# Certification of Calibration

Object: D1750V2 – SN: 1040  
 Calibration procedure(s): Procedure for Calibration Extension for SAR Dipoles.  
 Extension Calibration date: November 17, 2024  
 Description: SAR Validation Dipole at 1750 MHz.

Calibration Equipment used:

Manufacturer	Model	Description	Cal Date	Cal Interval	Cal Due	Serial Number
Hewlett Packard	8753E	RF Vector Network Analyzer	5/21/2024	Annual	5/21/2025	US38161081
Agilent	E4438C	ESG Vector Signal Generator	5/19/2024	Annual	5/19/2025	US41460739
Amplifier Research	15S1G6	Amplifier	CBT	N/A	CBT	343972
Anritsu	ML2496A	Power Meter	7/15/2024	Annual	7/15/2025	1138001
Anritsu	MA2411B	Pulse Power Sensor	7/10/2024	Annual	7/10/2025	1126066
Anritsu	MA2411B	Pulse Power Sensor	7/1/2024	Annual	7/1/2025	1911105
Traceable	4040 90080-06	Therm./ Clock/ Humidity Monitor	1/15/2024	Annual	1/15/2025	160574418
Control Company	4352	Ultra Long Stem Thermometer	1/15/2024	Annual	1/15/2025	160508097
Agilent	85033E	3.5mm Standard Calibration Kit	7/31/2024	Annual	7/31/2025	MY53402352
Mini-Circuits	VLF-6000+	Low Pass Filter DC to 6000 MHz	CBT	N/A	CBT	N/A
Narda	4772-3	Attenuator (3dB)	CBT	N/A	CBT	9406
Mini-Circuits	ZHDC-16-63-S+	50-6000MHz Bidirectional Coupler	CBT	N/A	CBT	N/A
Pasternack	NC-100	Torque Wrench	12/5/2022	Biennial	12/5/2024	N/A
SPEAG	DAK-3.5	Dielectric Assessment Kit	5/14/2024	Annual	5/14/2025	1070
SPEAG	EX3DV4	SAR Probe	4/16/2024	Annual	4/16/2025	7532
SPEAG	DAE4	Dasy Data Acquisition Electronics	4/9/2024	Annual	4/9/2025	501

Measurement Uncertainty = ±23% (k=2)

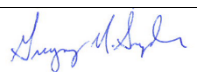
	Name	Function	Signature
Calibrated By:	Arturo Oliveros	Compliance Engineer	
Approved By:	Greg Snyder	Executive VP of Operations	



# DIPOLE CALIBRATION EXTENSION

Per KDB 865664 D01, calibration intervals of up to three years may be considered for reference dipoles when it is demonstrated that the SAR target, impedance and return loss of a dipole have remained stable according to the following requirements:

1. The measured SAR does not deviate more than 10% from the target on the calibration certificate.
2. The return-loss does not deviate more than 20% from the previous measurement and meets the required 20dB minimum return-loss requirement.
3. The measurement of real or imaginary parts of impedance does not deviate more than 5Ω from the previous measurement.

The following dipole was checked to pass the above 3 requirements to have 3-year calibration period from the calibration date:

Calibration Date	Extension Date	Certificate Electrical Delay (ns)	Certificate SAR Target Head (1g) W/kg @ 20.0 dBm	Measured Head SAR (1g) W/kg @ 20.0 dBm	Deviation 1g (%)	Certificate SAR Target Head (10g) W/kg @ 20.0 dBm	Measured Head SAR (10g) W/kg @ 20.0 dBm	Deviation 10g (%)	Certificate Impedance Head (Ohm) Real	Measured Impedance Head (Ohm) Real	Difference (Ohm) Real	Certificate Impedance Head (Ohm) Imaginary	Measured Impedance Head (Ohm) Imaginary	Difference (Ohm) Imaginary	Certificate Return Loss Head (dB)	Measured Return Loss Head (dB)	Deviation (%)
11/17/2022	11/17/2024	1.22	3.64	3.7	1.66%	1.91	1.98	3.66%	50.7	51.2	0.5	-0.4	1	1.4	-42.1	-38.1	9.60%

### Impedance & Return-Loss Measurement Plot for Head TSL

CH1 S11 1 U FS 1: 51.232  $\Omega$  0.9609  $\Omega$  87.393 pF 1 750.000 000 MHz

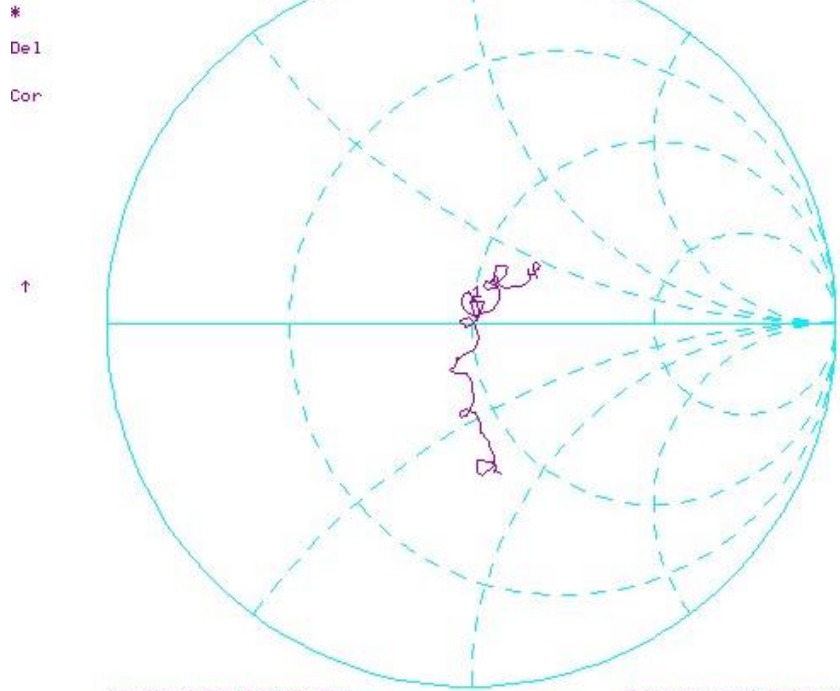

CENTER 1 750.000 000 MHz . SPAN 400.000 000 MHz  
 CH1 S11 LOG 5 dB/REF -20 dB 1:-38.078 dB 1 750.000 000 MHz

