



# Element Materials Technology

(formerly PCTEST)

18855 Adams Court, Morgan Hill, CA 95037 USA

Tel. 408.538.5600

<http://www.element.com>

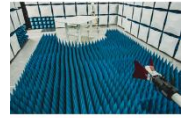

## MEASUREMENT REPORT FCC Part 15.255 / ISED RSS-210 Annex J (DXX)

**Applicant Name:**

Apple Inc.  
One Apple Park Way  
Cupertino, CA 95014  
United States

**Date of Testing:**

5/2/2023 – 8/11/2023

**Test Report Issue Date:**

8/11/2023

**Test Site/Location:**

Element Materials Technology, Morgan Hill, CA, USA

**Test Report Serial No.:**

1C2305020013-17.BCG

<b>FCC ID:</b>	<b>BCG-A2984</b>
<b>ICC:</b>	<b>579C-A2984</b>
<b>APPLICANT:</b>	<b>Apple Inc.</b>

**Application Type:**

Certification

**Model/HVIN:**

A2984, A2985

**EUT Type:**

Watch

**Max. RF EIRP:**

3.741 mW (5.73 dBm) Peak EIRP

**Max. RF Output Power:**

1.489 mW (1.73 dBm) Peak Conducted

**Operating Frequency:**

60.5 GHz

**FCC Classification:**

Low Power Communication Device Transmitter (DXX)

**FCC Rule Part(s):**

Part 15 Subpart C (15.255)

**ISED Specification:**

RSS-210 Annex J

**Test Procedure(s):**

ANSI C63.10-2013

This equipment has been shown to be capable of compliance with the applicable technical standards as indicated in the measurement report and was tested in accordance with the measurement procedures specified in §2.947. Test results reported herein relate only to the item(s) tested.

I attest to the accuracy of data. All measurements reported herein were performed by me or were made under my supervision and are correct to the best of my knowledge and belief. I assume full responsibility for the completeness of these measurements and vouch for the qualifications of all persons taking them.

RJ Ortanez  
Executive Vice President



CERT #2041.02

<b>FCC ID:</b> BCG-A2984 <b>IC:</b> 579C-A2984		<b>MEASUREMENT REPORT (CERTIFICATION)</b>	<b>Approved by:</b> Technical Manager
<b>Test Report S/N:</b> 1C2305020013-17.BCG	<b>Test Dates:</b> 5/2/2023 – 8/11/2023	<b>EUT Type:</b> Watch	Page 1 of 46

Version 1.1, 7/29/2022

Unless otherwise specified, no part of this report may be reproduced or utilized in any part, form or by any means, electronic or mechanical, including photocopying and microfilm, without permission in writing from Element Materials Technology Morgan Hill. If you have any questions about this or have an enquiry about obtaining additional rights to this report or assembly of contents thereof, please contact [ct.info@element.com](mailto:ct.info@element.com).

## TABLE OF CONTENTS

1.0	INTRODUCTION .....	3
1.1	Scope .....	3
1.2	Element Materials Technology Test Location.....	3
1.3	Test Facility / Accreditations.....	3
2.0	PRODUCT INFORMATION.....	4
2.1	Equipment Description .....	4
2.2	Device Capabilities.....	4
2.3	Antenna Description .....	5
2.4	Test Support Equipment.....	5
2.5	Test Configuration .....	5
2.6	Software and Firmware .....	6
2.7	EMI Suppression Device(s)/Modifications .....	6
3.0	DESCRIPTION OF TESTS .....	7
3.1	Measurement Procedure.....	7
3.2	AC Line Conducted Emissions .....	7
3.3	Radiated Emissions.....	8
4.0	MEASUREMENT UNCERTAINTY .....	10
5.0	TEST EQUIPMENT CALIBRATION DATA .....	11
6.0	TEST RESULTS .....	12
6.1	Summary .....	12
6.2	6dB Emission Bandwidth.....	13
6.3	99% Occupied Bandwidth .....	16
6.4	Equivalent Isotropic Radiated Power (EIRP).....	18
6.5	Peak Conducted Output Power .....	22
6.6	Radiated Spurious Emissions (Above 40GHz).....	24
6.7	Radiated Spurious Emissions (1GHz – 40GHz).....	30
6.8	Radiated Spurious Emissions (Below 1GHz) .....	35
6.9	Frequency Stability.....	39
6.10	AC Line Conducted Emissions Measurements .....	42
7.0	CONCLUSION.....	46

<b>FCC ID:</b> BCG-A2984 <b>IC:</b> 579C-A2984		<b>MEASUREMENT REPORT (CERTIFICATION)</b>	<b>Approved by:</b> Technical Manager
<b>Test Report S/N:</b> 1C2305020013-17.BCG	<b>Test Dates:</b> 5/2/2023 – 8/11/2023	<b>EUT Type:</b> Watch	Page 2 of 46

## 1.0 INTRODUCTION

### 1.1 Scope

Measurement and determination of electromagnetic emissions (EMC) of radio frequency devices including intentional and/or unintentional radiators for compliance with the technical rules and regulations of the Federal Communications Commission and the Innovation, Science and Economic Development Canada.

### 1.2 Element Materials Technology Test Location

These measurement tests were conducted at the Element Materials Technology facility located at 18855 Adams Court, Morgan Hill, CA 95037. The measurement facility is compliant with the test site requirements specified in ANSI C63.4-2014 and KDB 414788 D01 v01r01.

### 1.3 Test Facility / Accreditations

**Measurements were performed at Element Materials Technology located in Morgan Hill, CA 95037, U.S.A.**

- Element Materials Technology is an ISO 17025-2017 accredited test facility under the American Association for Laboratory Accreditation (A2LA) with Certificate number 2041.02 for Specific Absorption Rate (SAR), Hearing Aid Compatibility (HAC) testing, where applicable, and Electromagnetic Compatibility (EMC) testing for FCC and Innovation, Science, and Economic Development Canada rules.
- Element Washington DC LLC TCB is a Telecommunication Certification Body (TCB) accredited to ISO/IEC 17065-2012 by A2LA (Certificate number 2041.03) in all scopes of FCC Rules and ISED Standards (RSS).
- Element Materials Technology facility is a registered (22831) test laboratory with the site description on file with ISED.
- Element Washington DC LLC is a Recognized U.S. Certification Assessment Body (CAB # US0110) for ISED Canada as designated by NIST under the U.S. and Canada Mutual Recognition Agreements (MRAs)

FCC ID: BCG-A2984 IC: 579C-A2984		MEASUREMENT REPORT (CERTIFICATION)	Approved by: Technical Manager
Test Report S/N: 1C2305020013-17.BCG	Test Dates: 5/2/2023 – 8/11/2023	EUT Type: Watch	Page 3 of 46

Version 1.1, 7/29/2022

## 2.0 PRODUCT INFORMATION

### 2.1 Equipment Description

The Equipment Under Test (EUT) is the **Apple Watch FCC ID: BCG-A2984** and **IC: 579C-A2984**. The test data contained in this report pertains only to the emissions due to the EUT's DXX (60.5GHz) transmitter function.

EUT consists of a Apple Watch handheld device containing a 60.5GHz unlicensed/license-exempt data communications transmitter module. A proprietary Wireless Serial Dock with a corresponding 60.5GHz module is needed to activate transmission on the Apple Watch. A magnetic alignment fixture locks the Apple Watch in place on top of the Wireless Serial Dock, thus allowing communication between the Dock and Apple Watch. The Wireless Serial Dock is powered by a USB-C port.

**Test Device Serial No.** GXTXF2TMHK, KXV60YFXCJ, JX69IN6M7P, P909JLVCGX

### 2.2 Device Capabilities

This device contains the following capabilities:

850/1700/1900 WCDMA/HSPA, Multi-band LTE, 802.11b/g/n WLAN, 802.11a/n UNII, 802.15.4 ab-NB, Bluetooth (1x, EDR, HDR4, HDR8, LE1M, LE2M), NFC, UWB, 60.5GHz Transmitter.

Frequency [GHz]
60.5

**Table 2-1. EUT Operational Frequency**

Transmission Mode	Modulation Type	Data Rate	Duty Cycle [%]
Mode 1	Amplitude-Shift Keying (ASK)	480 Mbps	30.36
Mode 2	Amplitude-Shift Keying (ASK)	100 Kbps	< 1.0
Mode 3	Amplitude-Shift Keying (ASK)	12 Mbps	2.81

**Table 2-2. EUT Transmission Modes**

<b>FCC ID:</b> BCG-A2984 <b>IC:</b> 579C-A2984		<b>MEASUREMENT REPORT (CERTIFICATION)</b>	<b>Approved by:</b> Technical Manager
<b>Test Report S/N:</b> 1C2305020013-17.BCG	<b>Test Dates:</b> 5/2/2023 – 8/11/2023	<b>EUT Type:</b> Watch	Page 4 of 46

## 2.3 Antenna Description

The EUT contains one Tx antenna for 60.5GHz transmission. Following antenna gain provided by manufacturer was used for the testing.

Frequency [GHz]	Gain [dBi]
60.5	4.0

Table 2-3. Highest Antenna Gain

## 2.4 Test Support Equipment

1	Apple Macbook	Model:	A2141	S/N:	C02DV7VGMD6T
	w/AC/DC Adapter	Model:	A1718	S/N:	C4H702407ZBH674A5
2	Apple USB-C cable	Model:	N/A	S/N:	N/A
3	Apple Wireless Serial Dock	Model:	A2921	S/N:	DQ81376030E08V22S
	Apple Wireless Serial Dock	Model:	A2921	S/N:	DQ8137601EW08V22A
	Apple Watch Cradle	Model:	X241	S/N:	CHE294-15-ENG-C
	Apple Magnetic Charger	Model:	N/A	S/N:	DLC14640FZE0KWTA0
4	Targus USB Hub	Model:	PA055	S/N:	0405009065

Table 2-4. Test Support Equipment List

## 2.5 Test Configuration

The EUT was tested per the guidance of ANSI C63.10-2013. ANSI C63.10-2013 was also used to reference the appropriate EUT setup for radiated emissions testing and AC line conducted testing. See Sections 3.2 for AC line conducted emissions test setups and 3.3 for radiated emissions test setups. Only the worst case emissions were reported in this test report.

The EUT was also investigated with and without magnetic charger. The worst case configuration found was used for all testing.

For AC line conducted emissions and radiated emissions, the following configuration was used and reported:  
 - EUT powered by host Laptop via USB-C cable

All data rates and modulations were investigated for different test cases and the worst case data is reported in section 6.0.

FCC ID: BCG-A2984 IC: 579C-A2984		MEASUREMENT REPORT (CERTIFICATION)	Approved by: Technical Manager
Test Report S/N: 1C2305020013-17.BCG	Test Dates: 5/2/2023 – 8/11/2023	EUT Type: Watch	Page 5 of 46



## 2.6 Software and Firmware

The test was conducted with firmware version watchOS 10.0 installed on the EUT.

## 2.7 EMI Suppression Device(s)/Modifications

No EMI suppression device(s) were added and no modifications were made during testing.

<b>FCC ID:</b> BCG-A2984 <b>IC:</b> 579C-A2984		<b>MEASUREMENT REPORT (CERTIFICATION)</b>	<b>Approved by:</b> Technical Manager
<b>Test Report S/N:</b> 1C2305020013-17.BCG	<b>Test Dates:</b> 5/2/2023 – 8/11/2023	<b>EUT Type:</b> Watch	Page 6 of 46

Version 1.1, 7/29/2022

Unless otherwise specified, no part of this report may be reproduced or utilized in any part, form or by any means, electronic or mechanical, including photocopying and microfilm, without permission in writing from Element Materials Technology Morgan Hill. If you have any questions about this or have an enquiry about obtaining additional rights to this report or assembly of contents thereof, please contact [ct.info@element.com](mailto:ct.info@element.com).

## 3.0 DESCRIPTION OF TESTS

### 3.1 Measurement Procedure

The measurement procedures described in the "American National Standard of Procedures for Compliance Testing of Unlicensed Wireless Devices" (ANSI C63.10-2013) were used in the measurement of the EUT.

Deviation from measurement procedure.....None

### 3.2 AC Line Conducted Emissions

The line-conducted facility is located inside a 7m x 3.66m x 2.7m shielded enclosure. The shielded enclosure is manufactured by AP Americas. The shielding effectiveness of the shielded room is in accordance with MIL-Std-285 or NSA 65-6. A 1m x 1.5m wooden table 80cm high is placed 40cm away from the vertical wall and 80cm away from the sidewall of the shielded room. Two 10kHz-30MHz, 50Ω/50μH Line-Impedance Stabilization Networks (LISNs) are bonded to the shielded room floor. Power to the LISNs is filtered by external high-current high-insertion loss power line filters. The external power line filter is an ETS Lindgren Model LPRX-4X30 (100dB Attenuation, 14kHz-18GHz) and the two EMC/RFI filters are EPCOs 2X60A Power Line Filter (100dB Minimum Insertion Loss, 14kHz - 10GHz). These filters attenuate ambient signal noise from entering the measurement lines. These filters are also bonded to the shielded enclosure.

The EUT is powered from one LISN and the support equipment is powered from the second LISN. If the EUT is a DC-powered device, power will be derived from the source power supply it normally will be powered from and this supply line(s) will be connected to the second LISN. All interconnecting cables more than 1 meter were shortened to a 1 meter length by non-inductive bundling (serpentine fashion) and draped over the back edge of the test table. All cables were at least 40cm above the horizontal reference groundplane. Power cables for support equipment were routed down to the second LISN while ensuring that that cables were not draped over the second LISN.

Sufficient time for the EUT, support equipment, and test equipment was allowed in order for them to warm up to their normal operating condition. The RF output of the LISN was connected to the spectrum analyzer and exploratory measurements were made to determine the frequencies producing the maximum emission from the EUT. The spectrum was scanned from 150kHz to 30MHz with a spectrum analyzer. The detector function was set to peak mode for exploratory measurements while the bandwidth of the analyzer was set to 10kHz. The EUT, support equipment, and interconnecting cables were arranged and manipulated to maximize each emission. Once the worst case emissions have been identified, the one EUT cable configuration/arrangement and mode of operation that produced these emissions is used for final measurements on the same test site. The analyzer is set to CISPR quasi-peak and average detectors with a 9kHz resolution bandwidth for final measurements.

Line conducted emissions test results are shown in Section 6.10. Automated test software was used to perform the AC line conducted emissions testing. Automated measurement software utilized is Rohde & Schwarz EMC32, Version 10.50.40.

FCC ID: BCG-A2984 IC: 579C-A2984		MEASUREMENT REPORT (CERTIFICATION)	Approved by: Technical Manager
Test Report S/N: 1C2305020013-17.BCG	Test Dates: 5/2/2023 – 8/11/2023	EUT Type: Watch	Page 7 of 46

### 3.3 Radiated Emissions

The radiated test facilities consisted of an indoor 3 meter semi-anechoic chamber used for final measurements and exploratory measurements from 30MHz - 18GHz, when necessary for radiated emissions measurements in the spurious domain. The measurement area is contained within the semi-anechoic chamber which is shielded from any ambient interference. The test site inside the chamber is a 6m x 5.2m elliptical, obstruction-free area in accordance with Figure 5.7 of Clause 5 in ANSI C63.4-2014. Absorbers are arranged on the floor between the turn table and the antenna mast in such a way so as to maximize the reduction of reflections for measurements above 1GHz. For measurements below 1GHz, the absorbers are removed. A raised turntable is used for radiated measurement. The turn table is a continuously rotatable, remote-controlled, metallic turntable and 2 meters (6.56 ft.) in diameter. The turn table is flush with the raised floor of the chamber in order to maintain its function as a ground plane. An 80cm tall test table made of Styrodur is placed on top of the turn table. A Styrodur pedestal is placed on top of the test table to bring the total table height to 1.5m for measurements above 1GHz.

Radiated power (EIRP) measurements and radiated spurious emissions above 18GHz were performed in a Shielded Anechoic Chamber conforming to the site validation requirements of CISPR 16-1-4. Radiated spurious emission measurements from 9kHz - 18GHz were performed in a semi anechoic chamber (SAC) conforming to the site validation requirements of CISPR 16-1-4. A positioner was used to manipulate the EUT through several positions in space by rotating about the roll axis as shown in the figure below. The positioner was mounted on top of a turntable bringing the total EUT height to 1.5m.

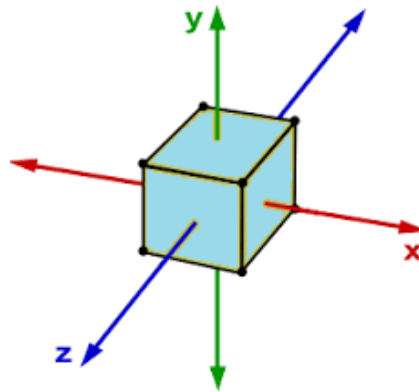

**Figure 3-1. Rotation of the EUT Through Three Orthogonal Planes**

Per KDB 414788 D01 v01r01, radiated emission test sites other than open-field test sites (e.g., shielded anechoic chambers), may be employed for emission measurements below 30MHz if characterized so that the measurements correspond to those obtained at an open-field test site. To determine test site equivalency, a reference sample transmitting at 149kHz was measured on an open field test site (asphalt with no ground plane) and then measured in the 3m semi-anechoic chamber. A calibrated 60cm loop antenna was used while the reference device was rotated through the X, Y and Z axis in order to capture the worst case level. A maximum deviation of 2.77dB at 149kHz was measured when comparing the 3 meter semi-anechoic chamber to the open field site.

<b>FCC ID:</b> BCG-A2984 <b>IC:</b> 579C-A2984		<b>MEASUREMENT REPORT (CERTIFICATION)</b>	<b>Approved by:</b> Technical Manager
<b>Test Report S/N:</b> 1C2305020013-17.BCG	<b>Test Dates:</b> 5/2/2023 – 8/11/2023	<b>EUT Type:</b> Watch	Page 8 of 46



### 3.3.1 Radiated Emissions Measurement Distance

The measurement antenna is in the far field of the EUT per formula  $2D^2/\lambda$  where D is the larger between the dimension of the measurement antenna and the transmitting antenna of the EUT. In this case, "D" is the largest dimension of the measurement antenna. The EUT is manipulated through all orthogonal planes representative of its typical use and for both polarities of the measurement antenna in order to achieve the highest signal level. The worst case position found was used for all radiated testing.

Frequency Range [GHz]	Wavelength [centimeters]	Farfield Distance [meters]	Measurement Distance [meters]
18-40	0.750	0.65	1.00
40-57	0.526	0.99	1.00
71-90	0.333	0.71	1.00
90-140	0.214	0.54	1.00
140-200	0.150	0.32	1.00

**Table 3-1. Far-Field Distance & Measurement Distance per Frequency Range (Out-of-Band Testing)**

Frequency Range [GHz]	Wavelength [centimeters]	Farfield Distance [meters]	Measurement Distance [meters]
57-71	0.422	0.60	0.60

**Table 3-2. Far-Field Distance & Measurement Distance per Frequency Range (In-Band Testing)**

FCC ID: BCG-A2984 IC: 579C-A2984		MEASUREMENT REPORT (CERTIFICATION)	Approved by: Technical Manager
Test Report S/N: 1C2305020013-17.BCG	Test Dates: 5/2/2023 – 8/11/2023	EUT Type: Watch	Page 9 of 46

## 4.0 MEASUREMENT UNCERTAINTY

The measurement uncertainties shown below were calculated in accordance with the requirements of ANSI C63.23-2012. All measurement uncertainty values are shown with a coverage factor of  $k = 2$  to indicate a 95% level of confidence. The measurement uncertainty shown below meets or exceeds the  $U_{CISPR}$  measurement uncertainty values specified in CISPR 16-4-2 and, thus, can be compared directly to specified limits to determine compliance.

Contribution	Expanded Uncertainty ( $\pm$ dB)
Lince Conducted Disturbance	2.70
Radiated Disturbance (<30MHz)	4.38
Radiated Disturbance (30MHz-1GHz)	4.75
Radiated Disturbance (1GHz-18GHz)	5.20
Radiated Disturbance (>18GHz)	5.71

FCC ID: BCG-A2984 IC: 579C-A2984		MEASUREMENT REPORT (CERTIFICATION)	Approved by: Technical Manager
Test Report S/N: 1C2305020013-17.BCG	Test Dates: 5/2/2023 – 8/11/2023	EUT Type: Watch	Page 10 of 46

Version 1.1, 7/29/2022

## 5.0 TEST EQUIPMENT CALIBRATION DATA

Test Equipment Calibration is traceable to an accredited ISO/IEC 17025 calibration facility. Measurements antennas used during testing were calibrated in accordance to the requirements of ANSI C63.5-2017.

Manufacturer	Model	Description	Cal Date	Cal Interval	Cal Due	Serial #
Agilent	MSO9404A	Mixed Signal Oscilloscope	3/18/2023	Annual	3/18/2024	MY57220110
Agilent Technologies	N9030A	3Hz-44GHz PXA Signal Analyzer	6/21/2023	Annual	6/21/2024	MY49430244
ATM	180-442A-KF	20dB Nominal Gain Horn Antenna	11/1/2022	Annual	11/1/2023	T058701-01
Com-Power	LI-220A	Line Impedance Stabilization Network	6/8/2023	Annual	6/8/2024	192052
ERAVANT	SAR-2309-19-S2	Rectangular Gain Horn U Band	3/9/2022	Biennial	3/9/2024	17314-01
ERAVANT	SAR-2309-12-S2	Rectangular Gain Horn E Band	3/9/2022	Biennial	3/9/2024	17315-01, QA
ERAVANT	SAR-2309-08-S2	Rectangular Gain Horn F Band	3/9/2022	Biennial	3/9/2024	01719-07, 1010A-AA36
ERAVANT	SAR-2309-05-S2	Rectangular Gain Horn WR-5 Band	3/9/2022	Biennial	3/9/2024	01672-15
ESPEC	SU-241	Table Top Temperature Chamber	11/10/2022	Annual	11/10/2023	92009574
ETS-Lindgren	3117	Double Ridged Guide Antenna (1-18 GHz)	3/30/2023	Annual	3/30/2024	00218555
MIWV	950V/385	MI-Wave Products Inc. RF detector V-Band (50-75GHz)	N/A	N/A	N/A	FSKY8L
Rohde & Schwarz	TS-PR18	Pre-Amplifier (1GHz - 18GHz)	6/2/2023	Annual	6/2/2024	100050
Rohde & Schwarz	FSW67	Signal and Spectrum Analyzer (2Hz - 67GHz)	4/4/2023	Annual	4/4/2024	101366
Rohde & Schwarz	SMB100A	RF and Microwave Signal Generator	3/13/2023	Annual	3/13/2024	113896
Rohde & Schwarz	ZNB40	Vector Network Analyzer 2 Port	10/12/2022	Annual	10/12/2023	101412
Rohde & Schwarz	TS-PR8	Pre-Amplifier (30MHz - 8GHz)	6/22/2023	Annual	6/22/2024	102356
Rohde & Schwarz	TS-PR1840	Pre-Amplifier (18GHz - 40GHz)	6/2/2023	Annual	6/2/2024	100050
Rohde & Schwarz	HFH2-Z2	Loop Antenna	5/1/2023	Annual	5/1/2024	100519
Schwarzbeck	VULB 9162	Bilog Antenna (30MHz - 6GHz)	4/17/2023	Annual	4/17/2024	00304
Virginia Diodes, Inc.	WR19SAX	SAX Module (40-60GHz)	3/17/2023	Biennial	3/17/2025	SAX459
Virginia Diodes, Inc.	WR12SAX	SAX Module (60-90GHz)	3/17/2023	Biennial	3/17/2025	SAX 461
Virginia Diodes, Inc.	WR8.0SAX	SAX Module (90-140GHz)	3/17/2023	Biennial	3/17/2025	SAX 462
Virginia Diodes, Inc.	WR5.1SAX	SAX Module (140-220GHz)	3/17/2023	Biennial	3/17/2025	SAX 463

**Table 5-1. Test Equipment List**

### Notes:

For equipment listed above that has a calibration date or calibration due date that falls within the test date range, care was taken to ensure that this equipment was used after the calibration date and before the calibration due date.

FCC ID: BCG-A2984 IC: 579C-A2984		MEASUREMENT REPORT (CERTIFICATION)	Approved by: Technical Manager
Test Report S/N: 1C2305020013-17.BCG	Test Dates: 5/2/2023 – 8/11/2023	EUT Type: Watch	Page 11 of 46

## 6.0 TEST RESULTS

### 6.1 Summary

Company Name: Apple Inc.  
 FCC ID: BCG-A2984  
 IC: 579C-A2984  
 FCC Classification: Part 15C Low Power Communications Device Transmitter (DXX)

FCC Part Section(s)	RSS Part Section(s)	Test Description	Test Limit	Test Condition	Test Result	Reference
15.255(e)(1)	RSS-210 Annex J.4.c	6dB Emission Bandwidth	N/A	RADIATED	N/A	Section 6.2
2.1049	RSS-Gen [6.7]	99% Occupied Bandwidth	N/A		N/A	Section 6.3
15.255(c)(1)(i)	RSS-210 Annex J.2.2.b	Equivalent Isotropic Radiated Power	43dBm (Peak) & 40dBm (Avg)		PASS	Section 6.4
15.255(e)	RSS-210 Annex J.4.a	Peak Conducted Output Power	(EBW x 500 mW) / 100 MHz if EBW < 100MHz ; 500 mW if EBW > 100MHz		PASS	Section 6.5
15.255(d)	RSS-210 Annex J.3.c	Radiated Spurious Emissions (Above 40GHz)	90 pW/cm <sup>2</sup> at a distance of 3 meters		PASS	Section 6.6
15.205 15.209	RSS-Gen [8.9]	Radiated Spurious Emissions (Below 40GHz)	Emissions in restricted bands must meet the radiated limits detailed in 15.209 (RSS-Gen [8.9])		PASS	Section 6.7; Section 6.8
15.255(f)	RSS-210 Annex J.6	Frequency Stability	Fundamental emissions stay within authorized frequency block over the temperature and voltage ranges tested		PASS	Section 6.9
15.207	RSS-Gen [8.8]	AC Line Conducted Emissions 150kHz – 30MHz	< FCC 15.207 limits (RSS-Gen [8.8])	AC LINE CONDUCTED	PASS	Section 6.10

**Table 6-1. Summary of Test Results**

#### Notes:

- 1) All modes of operation and modulations were investigated. The test results shown in the following sections represent the worst case results.
- 2) Analyzer plots are taken with the appropriate correction factors to account for system losses, antenna factor, and/or distance corrections.

FCC ID: BCG-A2984 IC: 579C-A2984		MEASUREMENT REPORT (CERTIFICATION)	Approved by: Technical Manager
Test Report S/N: 1C2305020013-17.BCG	Test Dates: 5/2/2023 – 8/11/2023	EUT Type: Watch	Page 12 of 46



## 6.2 6dB Emission Bandwidth

§15.255(e)(1); RSS-210 Annex J.4.c

### Test Overview

The emission bandwidth (EBW) is defined as the width of the signal between two points, one below the carrier center frequency and one above the carrier center frequency, outside of which all emissions are attenuated at least the specified amount below the maximum level of the modulated carrier.

Specifically in CFR 15.255 and RSS-210 Annex J.4.c, emission bandwidth is defined as the instantaneous frequency range occupied by a steady state radiated signal with modulation, outside which the radiated power spectral density never exceeds 6 dB below the maximum radiated power spectral density in the band, as measured with a 100 kHz resolution bandwidth spectrum analyzer.

### Test Procedure Used

ANSI C63.10-2013 Subclause 9.3

### Test Settings

1. The signal analyzer's automatic "X dB bandwidth" measurement capability was used to perform EBW measurements (where X = 6 dB). The bandwidth measurement was not influenced by any intermediate power nulls in the fundamental emission
2. Span = 2 to 3 x EBW (centered on the carrier frequency)
3. RBW = 100 kHz
4. VBW ≥ 3 x RBW
5. Detector = Peak
6. Trace Mode = Max Hold
7. Sweep = No faster than coupled (auto) time
8. The trace was allowed to stabilize
9. If necessary, steps 2 – 7 were repeated after changing the measurement span such that it would be 2 to 3 x EBW observed in Step 8

FCC ID: BCG-A2984 IC: 579C-A2984		MEASUREMENT REPORT (CERTIFICATION)	Approved by: Technical Manager
Test Report S/N: 1C2305020013-17.BCG	Test Dates: 5/2/2023 – 8/11/2023	EUT Type: Watch	Page 13 of 46

Version 1.1, 7/29/2022

**Test Setup**

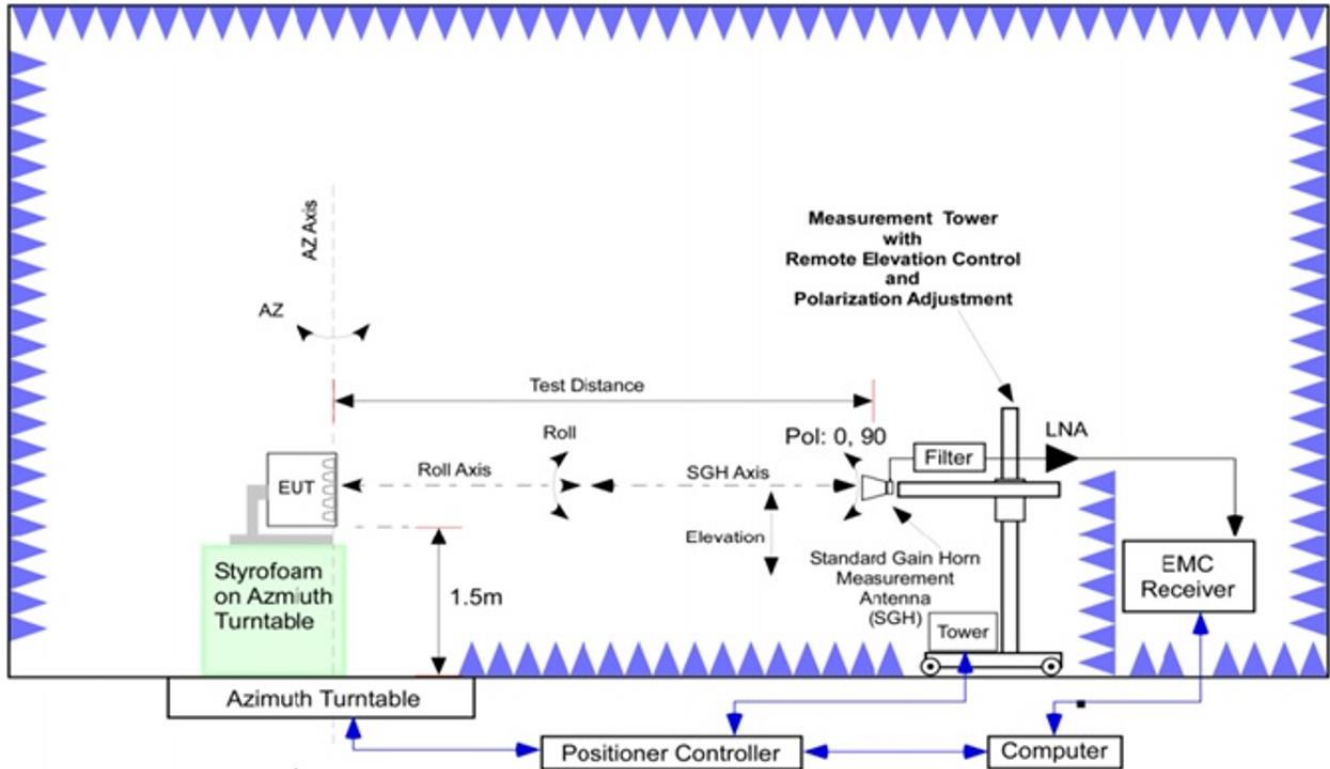
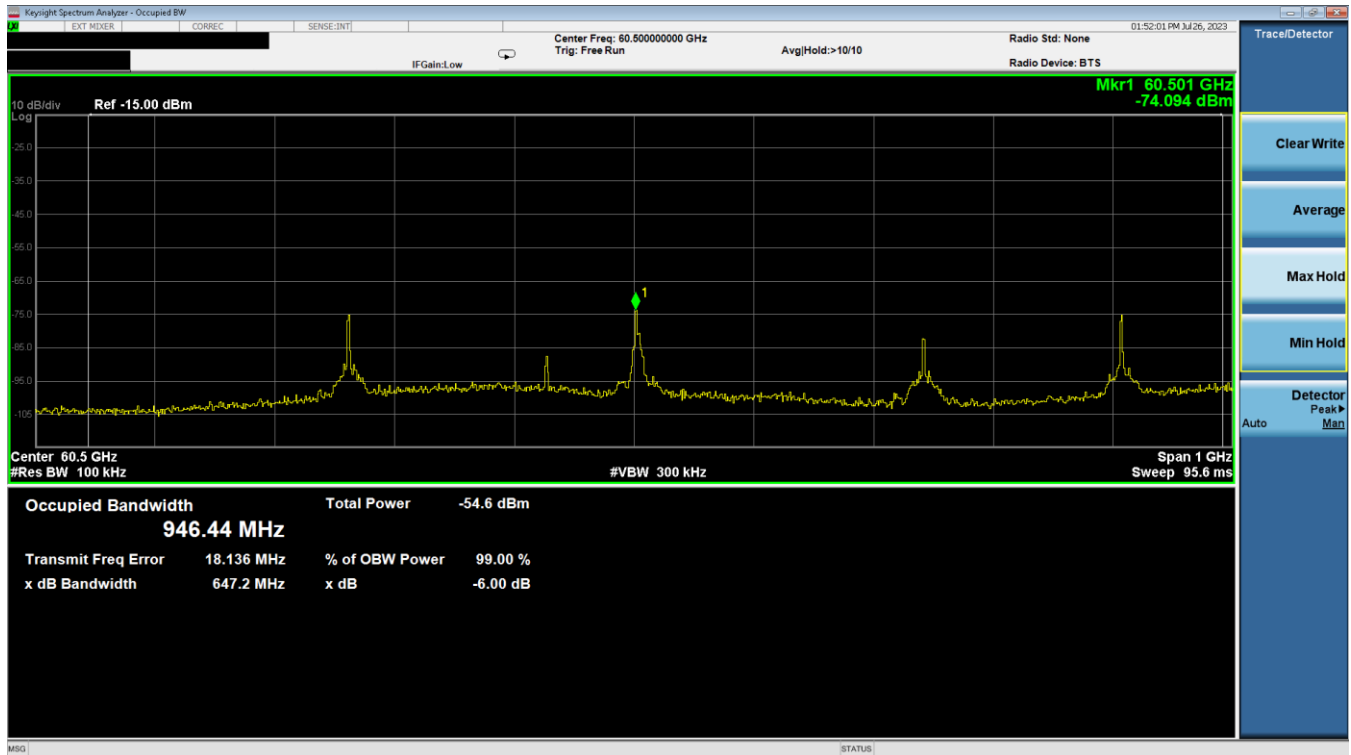

**Figure 6-1. Bandwidth Measurement Test Setup**

**Test Notes**

1. All modes of operation were investigated and the worst case configuration results are reported in this section
2. Radiated measurements were ensured to be taken in the Far-Field. Far-Field test distances are shown in Section 3.3.1

<b>FCC ID:</b> BCG-A2984 <b>IC:</b> 579C-A2984		<b>MEASUREMENT REPORT (CERTIFICATION)</b>	<b>Approved by:</b> Technical Manager
<b>Test Report S/N:</b> 1C2305020013-17.BCG	<b>Test Dates:</b> 5/2/2023 – 8/11/2023	<b>EUT Type:</b> Watch	Page 14 of 46



Plot 6-1. 6dB Bandwidth Measurement (Mode 1)

### Test Result

Mode 1, Measured 6dB Bandwidth = 647.2 MHz

FCC ID: BCG-A2984 IC: 579C-A2984		MEASUREMENT REPORT (CERTIFICATION)	Approved by: Technical Manager
Test Report S/N: 1C2305020013-17.BCG	Test Dates: 5/2/2023 – 8/11/2023	EUT Type: Watch	Page 15 of 46

### 6.3 99% Occupied Bandwidth

§2.1049; RSS-Gen [6.7]

#### Test Overview

The occupied bandwidth or the “99% emission bandwidth” is defined as the frequency range between two points, one above and the other below the carrier frequency, within which 99% of the total transmitted power of the fundamental transmitted emission is contained.

#### Test Procedure Used

ANSI C63.10-2013 Subclause 6.9.3  
RSS-Gen [6.7]

#### Test Settings

1. The signal analyzer’s automatic “99% bandwidth” measurement capability was used to perform OBW measurements. The bandwidth measurement was not influenced by any intermediate power nulls in the fundamental emission
2. Span = Approximately 1.5 – 5 x OBW (centered on the carrier frequency)
3. RBW = 1 MHz
4. VBW ≥ 3 x RBW
5. Detector = Peak
6. Trace Mode = Max Hold
7. Sweep = No faster than coupled (auto) time
8. The trace was allowed to stabilize
9. If necessary, steps 2 – 7 were repeated after changing the measurement span such that it would be approximately 1.5 – 5 x OBW (centered on the carrier frequency) observed in Step 8

#### Test Setup

Test setup is same as shown in **Figure 6-1**.

#### Test Notes

1. All modes of operation were investigated and the worst case configuration results are reported in this section
2. Radiated measurements were ensured to be taken in the Far-Field. Far-Field test distances are shown in Section 3.3.1

FCC ID: BCG-A2984 IC: 579C-A2984		MEASUREMENT REPORT (CERTIFICATION)	Approved by: Technical Manager
Test Report S/N: 1C2305020013-17.BCG	Test Dates: 5/2/2023 – 8/11/2023	EUT Type: Watch	Page 16 of 46



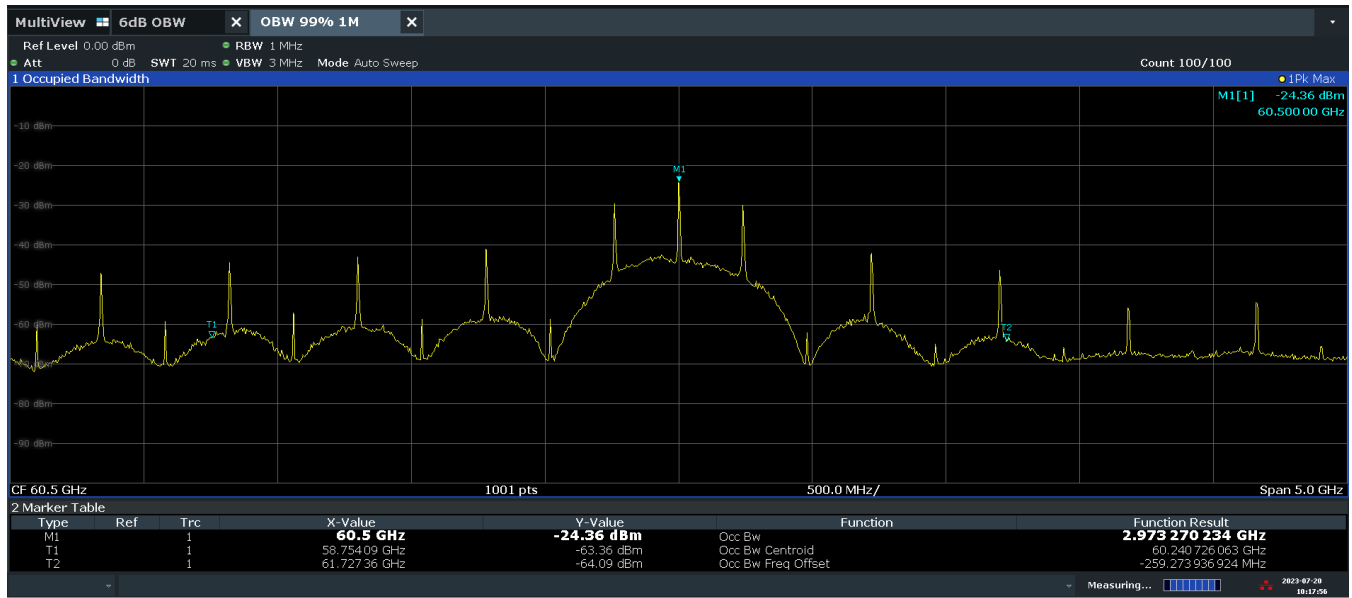

Plot 6-2. 99% Occupied Bandwidth Measurement (Mode 1)

### Test Result

Mode 1, Measured 99% Occupied Bandwidth = 2.973 GHz

FCC ID: BCG-A2984 IC: 579C-A2984		MEASUREMENT REPORT (CERTIFICATION)	Approved by: Technical Manager
Test Report S/N: 1C2305020013-17.BCG	Test Dates: 5/2/2023 – 8/11/2023	EUT Type: Watch	Page 17 of 46



**6.4 Equivalent Isotropic Radiated Power (EIRP)**  
§15.255(c)(1)(i); RSS-210 Annex J.2.2.b

**Test Overview**

Equivalent Isotropic Radiated Power (EIRP) measurements are performed with an RF detector that has a detection bandwidth that encompasses the 57-71GHz band and has a video bandwidth of at least 10MHz. Average emission levels shall be measured over the actual time period during which transmission occurs.

***Within the 57-71 GHz band, the average power of any emission shall not exceed +40 dBm and the peak power of any emission shall not exceed +43 dBm.***

**Test Procedures Used**

ANSI C63.10-2013 Subclause 9.11

**Test Settings**

1. Fundamental emission levels are measured using a radiated test setup and substitution procedure as outlined in ANSI C63.10-2013 Subclause 9.11.
2. The measurement equipment is a mm-Wave RF detector that has a RF bandwidth encompassing the entire authorized frequency range, connected to the 50 Ohm input of a digital storage oscilloscope (DSO).
3. The sampling rate of the DSO is set to atleast twice the signal bandwidth. Memory depth, triggering, and sweep speed of the DSO are adjusted to obtain a display that is representative of the signal considering the type of modulation.
4. All radiated measurements are made in the far-field. The far-field boundary distance of the EUT antenna or measurement antenna (whichever is largest) is used for testing. Maximization is completed to ensure highest signal level is recorded.
5. The EUT is set to transmit, and the resulting Peak voltage measurement from the DSO is recorded. DSO measurements are ensured to be made during the highest amplitude RF Burst interval.
6. The EUT is then replaced by an unmodulated mm-Wave source.
7. The amplitude of the mm-Wave source is incrementally increased until the same Peak voltage measured from the DSO in Step 5 is re-created.
8. Once the equivalent voltage reading from the DSO is re-created, a wideband mm-Wave measurement instrument is then used to measure the power from the mm-Wave source. This is the substitution power level.
9. Repeat steps 1-5 for the Average voltage measurement. Average measurements are ensured to be taken during the ON time of the EUT transmission.
10. Calculate Peak and Average EIRP from the Peak and Average Substitution Power (respectively) at the output of the measurement antenna. See sample calculations.

FCC ID: BCG-A2984 IC: 579C-A2984		MEASUREMENT REPORT (CERTIFICATION)	Approved by: Technical Manager
Test Report S/N: 1C2305020013-17.BCG	Test Dates: 5/2/2023 – 8/11/2023	EUT Type: Watch	Page 18 of 46

Version 1.1, 7/29/2022

## Test Setup

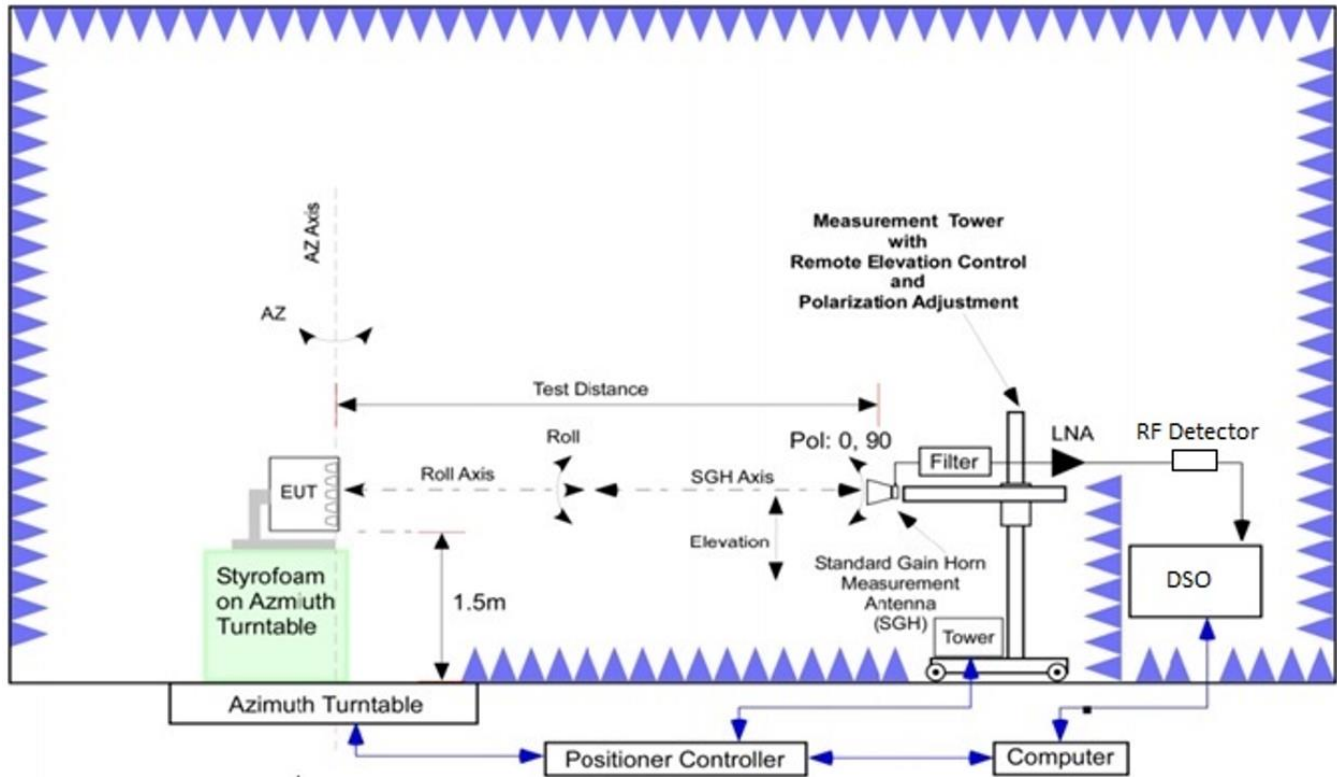

Figure 6-2. EIRP Measurement Test Setup

## Test Notes

- 1) All modes of operation were investigated and the worst case configuration results are reported in this section
- 2) EIRP measurements were ensured to be taken in the Far-Field. Far-field test distances are shown in Section 3.3.1

FCC ID: BCG-A2984 IC: 579C-A2984		MEASUREMENT REPORT (CERTIFICATION)	Approved by: Technical Manager
Test Report S/N: 1C2305020013-17.BCG	Test Dates: 5/2/2023 – 8/11/2023	EUT Type: Watch	Page 19 of 46

## Sample Calculations

Calculating Field Strength from substitution power:

$$E_{[\text{dB}\mu\text{V}/\text{m}]} = 126.8 - 20\log(\lambda) + P - G$$

Where:

E is the field strength of the emission at the measurement distance, in dB $\mu$ V/m  
 P is the power measured at the output of the test antenna, in dBm ; where P includes all applicable instrument correction factors up to the connection to the test antenna  
 $\lambda$  is the wavelength of the emission under investigation [300 / f<sub>MHz</sub>], in m  
 G is the gain of the test antenna, in dBi

Calculating EIRP from Field Strength:

$$\text{EIRP}_{[\text{dBm}]} = E_{\text{measured}} + 20\log(D_{\text{measured}}) - 104.7$$

Where:

EIRP is the equivalent isotropic radiated power in dBm  
 E<sub>measured</sub> is the field strength of the emission at the measurement distance, in dB $\mu$ V/m  
 D<sub>measured</sub> is the measurement distance in meters

### Note:

1. In the EIRP tables below, “substitution system loss” represents all the applicable instrument correction factors up to the connection to the “substitution R<sub>x</sub> antenna”

FCC ID: BCG-A2984 IC: 579C-A2984		MEASUREMENT REPORT (CERTIFICATION)	Approved by: Technical Manager
Test Report S/N: 1C2305020013-17.BCG	Test Dates: 5/2/2023 – 8/11/2023	EUT Type: Watch	Page 20 of 46

Version 1.1, 7/29/2022



**Average Voltage Within RF Burst:**

$$\begin{aligned}
 &= (\text{Measured Average Voltage over Entire Sweep}) \times ((\text{Sweep Time}) / (\text{Burst Width})) \\
 &= 24.33 \text{ mV} \times (402.11 \text{ ms} / 391.22 \text{ ms}) \\
 &= 25.01 \text{ mV}
 \end{aligned}$$

Frequency [GHz]	Test Distance [meters]	EUT Peak Voltage from DSO [mV]	Equivalent Substitution Power [dBm]	Substitution Rx Antenna Gain [dBi]	Substitution System Loss [dB]	Calculated Peak EIRP [dBm]	Peak EIRP Limit [dBm]	Margin [dB]	Pass/Fail
60.50	0.60	90.10	-19.35	15.00	-23.68	5.73	43.00	-37.27	Pass

**Table 6-2. Peak EIRP Calculation via Substitution (Mode 1)**

Frequency [GHz]	Test Distance [meters]	EUT Average Voltage from DSO [mV]	Equivalent Substitution Power [dBm]	Substitution Rx Antenna Gain [dBi]	Substitution System Loss [dB]	Calculated Average EIRP [dBm]	Average EIRP Limit [dBm]	Margin [dB]	Pass/Fail
60.50	0.60	25.01	-25.51	15.00	-23.68	-0.43	40.00	-40.43	Pass

**Table 6-3. Average EIRP Calculation via Substitution (Mode 1)**

FCC ID: BCG-A2984 IC: 579C-A2984		<b>MEASUREMENT REPORT (CERTIFICATION)</b>		Approved by: Technical Manager
Test Report S/N: 1C2305020013-17.BCG	Test Dates: 5/2/2023 – 8/11/2023	EUT Type: Watch		Page 21 of 46

Version 1.1, 7/29/2022



## 6.5 Peak Conducted Output Power §15.255(e); RSS-210 Annex J.4.a

### Test Overview

EUT peak conducted output power must be calculated to compare to the according limits.

***For devices with an emission bandwidth greater than or equal to 100MHz, the peak transmitter output power shall not exceed 500mW. For devices with an emission bandwidth less than 100 MHz, the peak transmitter output power shall be less than the product of 500 mW and their emission bandwidth divided by 100MHz.***

### Test Procedure Used

ANSI C63.10-2013 Subclause 9.5

### Test Settings

1. EBW (6dB BW) is measured using the procedure outlined in Section 6.2 of this test report
2. Peak EIRP is measured using the procedure outlined in Section 6.4 of this test report
3. Peak Conducted Output Power is calculated from Peak EIRP
4. Peak Conducted Output Power is compared to the according limit

### Test Notes

1. All modes of operation were investigated and the worst case configuration results are reported in this section

### Sample Calculations

*Calculating Conducted Output Power from EIRP:*

$$EIRP = P_{cond} + G_{EUT}$$

Where:

EIRP is the equivalent isotropically radiated power, in dBm  
 $P_{cond}$  is the measured power at feedpoint of the EUT antenna, in dBm  
 $G_{EUT}$  is the gain of the EUT radiating element (antenna), in dBi

FCC ID: BCG-A2984 IC: 579C-A2984		MEASUREMENT REPORT (CERTIFICATION)	Approved by: Technical Manager
Test Report S/N: 1C2305020013-17.BCG	Test Dates: 5/2/2023 – 8/11/2023	EUT Type: Watch	Page 22 of 46

Version 1.1, 7/29/2022

Transmission Mode	Frequency [GHz]	Peak EIRP [dBm]	EUT Antenna Gain [dBi]	Peak Conducted Output Power [dBm]	Peak Conducted Output Power [mW]	Measured 6dB BW [MHz]	Peak Conducted Output Power Limit [mW]	Margin [mW]	Pass/Fail
1	60.50	5.73	4.00	1.73	1.49	647.20	500.00	-498.51	Pass

**Table 6-4. Peak Conducted Output Power Calculation**

FCC ID: BCG-A2984 IC: 579C-A2984		<b>MEASUREMENT REPORT (CERTIFICATION)</b>		<b>Approved by:</b> Technical Manager
<b>Test Report S/N:</b> 1C2305020013-17.BCG	<b>Test Dates:</b> 5/2/2023 – 8/11/2023	<b>EUT Type:</b> Watch		Page 23 of 46

## 6.6 Radiated Spurious Emissions (Above 40GHz)

§15.255(d); RSS-210 Annex J.3.c

### Test Overview

The spectrum is scanned from 40 GHz to 200 GHz for spurious and harmonic emissions. All out of band emissions are measured in a radiated test setup while the EUT is operating at its maximum duty cycle, at maximum power, and at the appropriate frequencies. All modes of operation were investigated and the worst case configuration results are reported in this section.

Frequency Range [GHz]	Emission Limit [pW/cm <sup>2</sup> ]	Emission Limit Distance [Meters]
40 - 200	90	3

**Table 6-5. Emission Limits for 40GHz to 200GHz**

### Test Procedure Used

ANSI C63.10-2013 Subclauses 9.8 and 9.9

### Test Settings

1. Start frequency was set to 40GHz and stop frequency was set to 200GHz. Several plots are used to show investigations over this entire frequency span.
2. RBW = 1MHz
3. VBW = 3MHz
4. Detector = Peak
5. Trace mode = Max Hold
6. Sweep time = auto couple
7. Number of sweep points  $\geq 2 \times \text{Span/RBW}$
8. The trace was allowed to stabilize

FCC ID: BCG-A2984 IC: 579C-A2984		MEASUREMENT REPORT (CERTIFICATION)	Approved by: Technical Manager
Test Report S/N: 1C2305020013-17.BCG	Test Dates: 5/2/2023 – 8/11/2023	EUT Type: Watch	Page 24 of 46

Version 1.1, 7/29/2022



## Test Setup

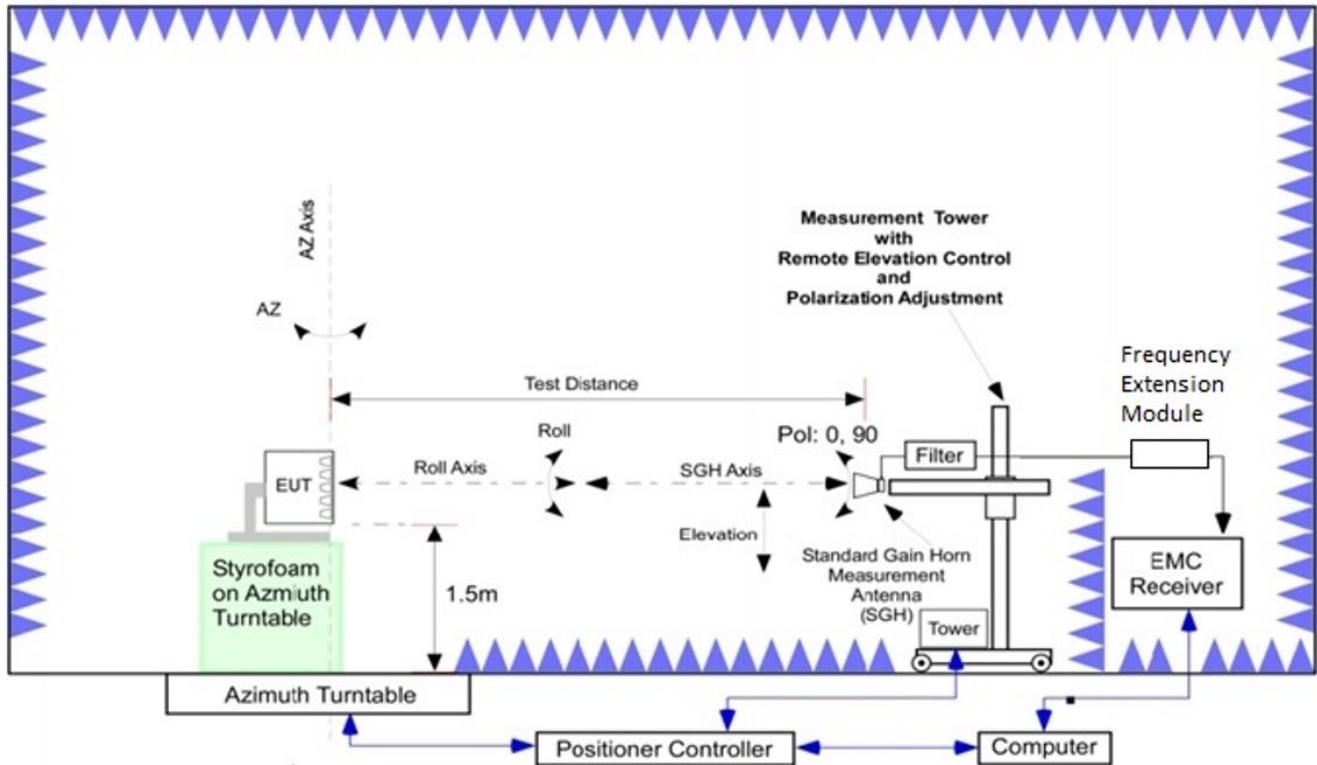

Figure 6-3. Radiated Spurious Emissions Measurement Test Setup (Above 40GHz)

## Test Notes

- 1) All modes of operation were investigated and the worst case configuration results are reported in this section.
- 2) To be conservative, Peak Detector was used for testing to yield worst case emission results. Any marginal emissions were evaluated with Average Detector for final measurement.
- 3) Emissions above 40GHz were measured using horn antennas, harmonic mixers, and a spectrum analyzer supporting external mixer configurations.
- 4) Radiated Spurious Emissions Above 40GHz were measured as RSE EIRP (in dBm) and afterwards converted to Power Density (PD) to compare with the according §15.255 emission limits. The RSE EIRP level is taken directly from the spectrum analyzer which includes the appropriate antenna factors, distance corrections, cable losses, and harmonic mixer conversion losses.
- 5) Emissions above 40GHz were measured in the far field. The far field distance is based on the formula:  $R > 2D^2/\text{wavelength}$ , where D is the larger between the dimension of the measurement antenna and the transmitting antenna of the EUT. In this case, D is the largest dimension of the measurement antenna.

FCC ID: BCG-A2984 IC: 579C-A2984		MEASUREMENT REPORT (CERTIFICATION)	Approved by: Technical Manager
Test Report S/N: 1C2305020013-17.BCG	Test Dates: 5/2/2023 – 8/11/2023	EUT Type: Watch	Page 25 of 46

Version 1.1, 7/29/2022

Frequency Range [GHz]	Wavelength [centimeters]	Farfield Distance [meters]	Measurement Distance [meters]
40 - 57	0.526	0.99	1.00
71 - 90	0.333	0.71	1.00
90 - 140	0.214	0.54	1.00
140 - 200	0.150	0.32	1.00

**Table 6-6. Far-Field Distance & Measurement Distance Per Frequency Range**

6) The "-" shown in the following RSE tables are used to denote a noise floor measurement.

**Sample Calculations:**

*Calculating Field Strength from analyzer level:*

$$E_{[dB\mu V/m]} = 126.8 - 20\log(\lambda) + P - G$$

*Where:*

- E is the field strength of the emission at the measurement distance, in dB $\mu$ V/m
- P is the power measured at the output of the test antenna, in dBm; where P includes all applicable instrument correction factors up to the connection to the test antenna
- $\lambda$  is the wavelength of the emission under investigation [300 / f<sub>MHz</sub>], in m
- G is the gain of the test antenna, in dBi

*Calculating EIRP from Field Strength:*

$$RSE\ EIRP_{[dBm]} = E_{measured} + 20\log(D_{measured}) - 104.7$$

*Where:*

- EIRP is the equivalent isotropic radiated power in dBm
- E<sub>measured</sub> is the field strength of the emission at the measurement distance, in dB $\mu$ V/m
- D<sub>measured</sub> is the measurement distance in meters

*Calculating Power Density from EIRP:*

$$PD = EIRP_{linear} / (4\pi D^2)$$

*Where:*

- PD is the power density at the distance specified by the limit, in W/m<sup>2</sup>
- EIRP<sub>linear</sub> is the equivalent isotropic radiated power, in Watts
- D is the distance at which the power density limit is specified, in meters

FCC ID: BCG-A2984 IC: 579C-A2984		MEASUREMENT REPORT (CERTIFICATION)	Approved by: Technical Manager
Test Report S/N: 1C2305020013-17.BCG	Test Dates: 5/2/2023 – 8/11/2023	EUT Type: Watch	Page 26 of 46

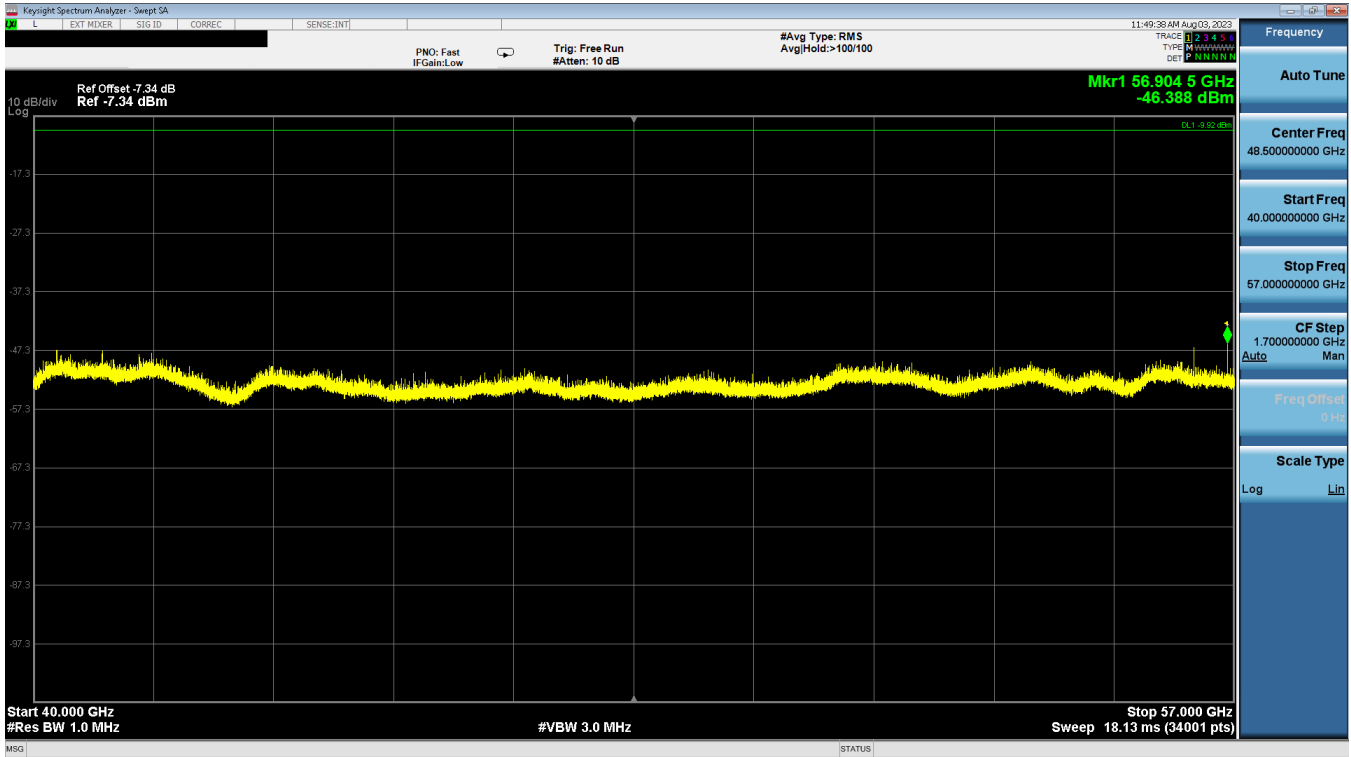

Plot 6-5. Radiated Spurious Emissions 40GHz – 57GHz (Mode 1)

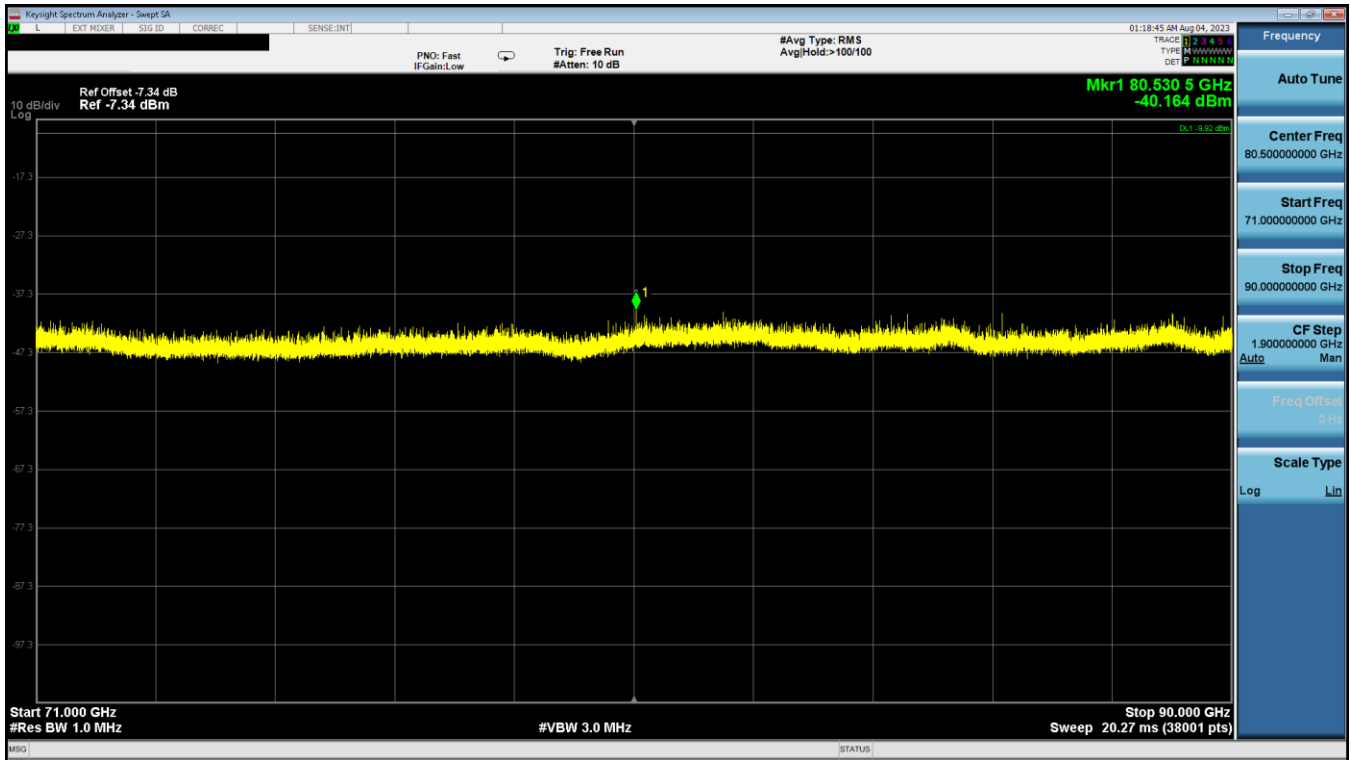

Plot 6-6. Radiated Spurious Emissions 71GHz – 90GHz (Mode 1)

FCC ID: BCG-A2984 IC: 579C-A2984		MEASUREMENT REPORT (CERTIFICATION)	Approved by: Technical Manager
Test Report S/N: 1C2305020013-17.BCG	Test Dates: 5/2/2023 – 8/11/2023	EUT Type: Watch	Page 27 of 46

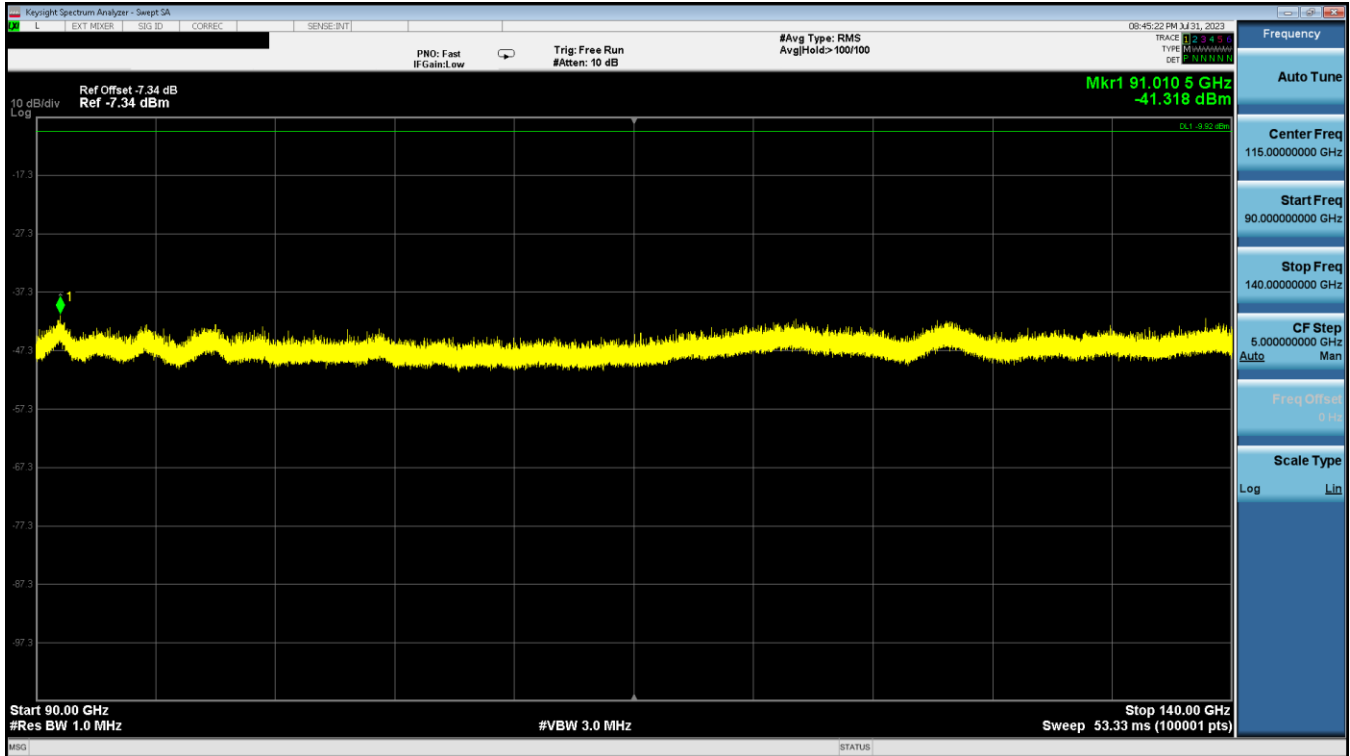

Plot 6-7. Radiated Spurious Emissions 90GHz – 140GHz (Mode 1)

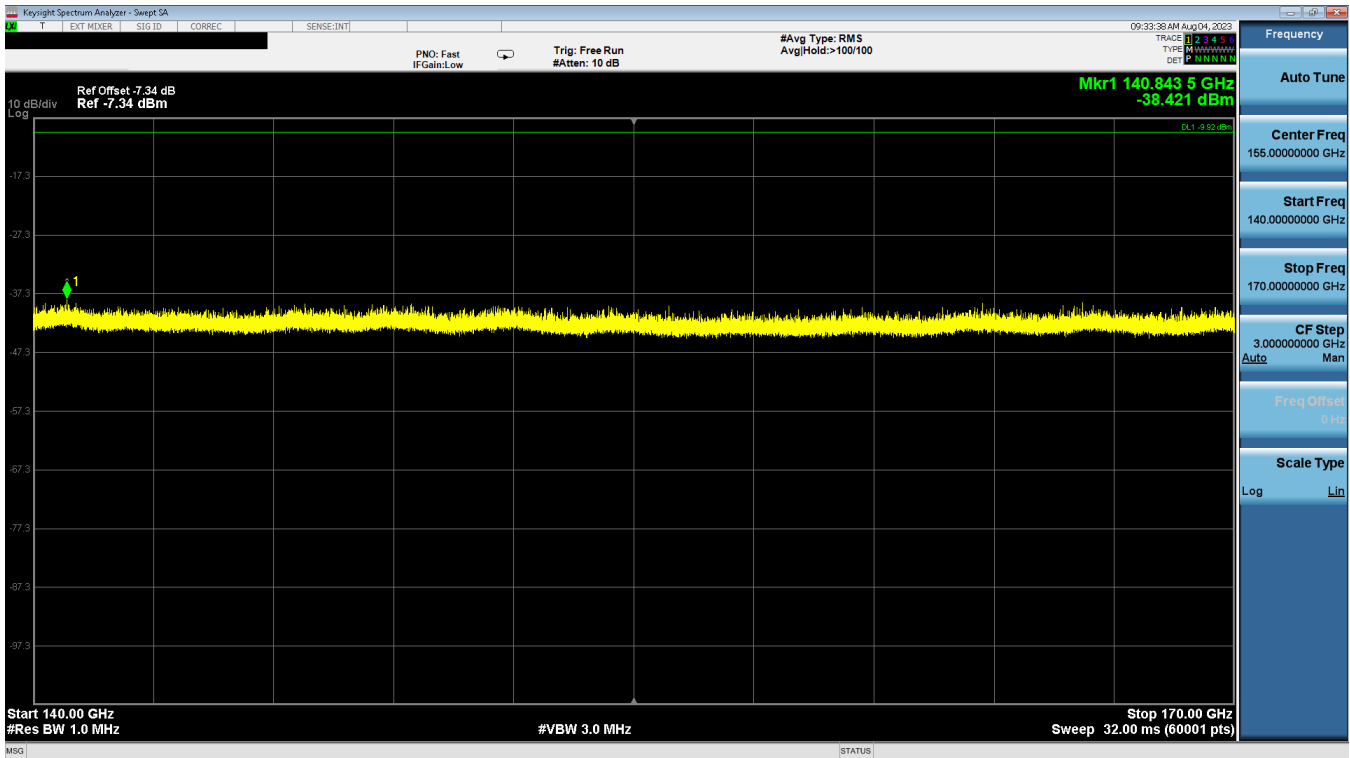

Plot 6-8. Radiated Spurious Emissions 140GHz – 170GHz (Mode1)

FCC ID: BCG-A2984 IC: 579C-A2984		MEASUREMENT REPORT (CERTIFICATION)	Approved by: Technical Manager
Test Report S/N: 1C2305020013-17.BCG	Test Dates: 5/2/2023 – 8/11/2023	EUT Type: Watch	Page 28 of 46

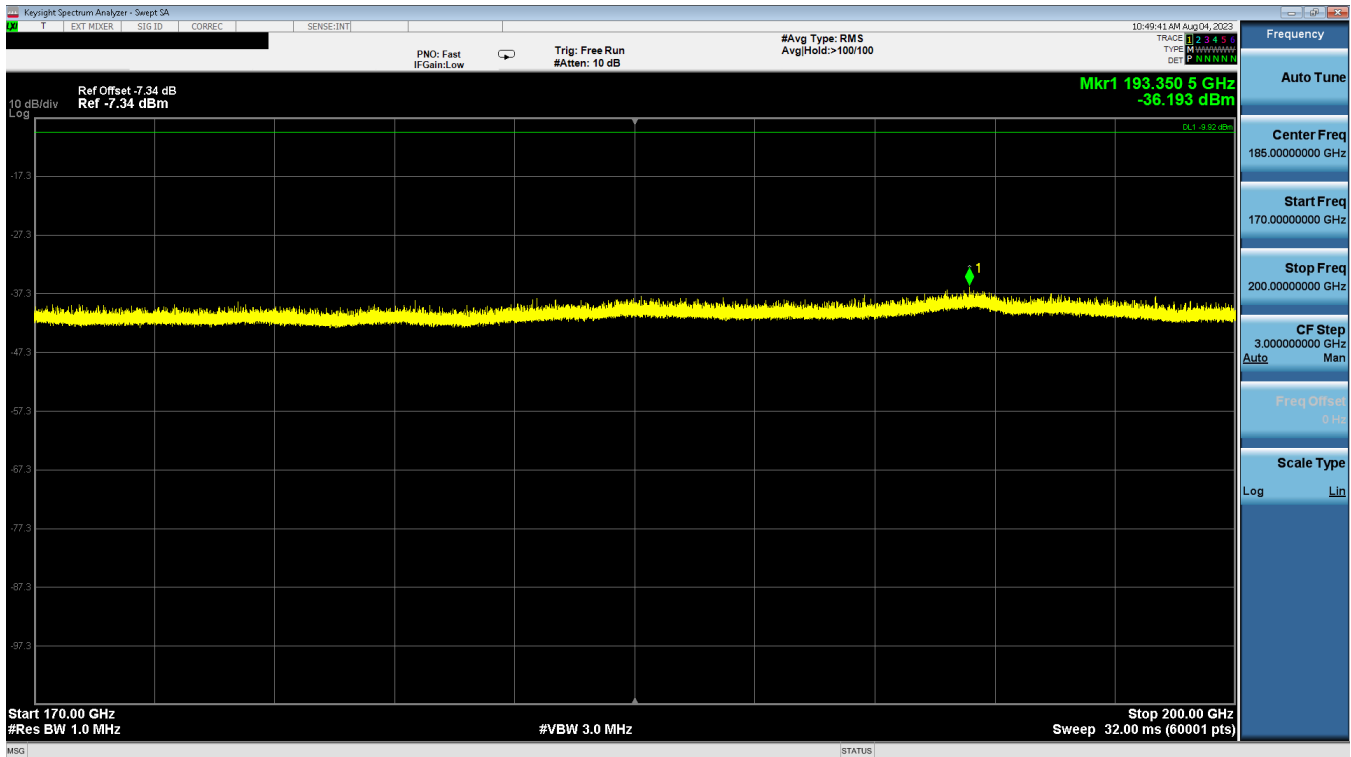

**Plot 6-9. Radiated Spurious Emissions 170GHz – 200GHz (Mode 1)**

Transmission Mode	Frequency [GHz]	Polarity [H/V]	Positioner Azimuth [degrees]	Turntable Azimuth [degrees]	EIRP Emission Level at 3 meters [dBm]	Power Density Level at 3 meters [pW/cm <sup>2</sup> ]	Power Density Limit at 3 meters [pW/cm <sup>2</sup> ]	Margin [pW/cm <sup>2</sup> ]
1	40.333	H	272	66	-44.69	0.030	90.000	-89.970
1	56.904	H	103	131	-45.93	0.023	90.000	-89.977
1	80.665	H	356	115	-39.91	0.090	90.000	-89.910
1	121.026	V	-	-	-41.11	0.069	90.000	-89.931
1	140.844	V	-	-	-38.42	0.127	90.000	-89.873
1	193.351	H	-	-	-36.19	0.212	90.000	-89.788

**Table 6-7. Radiated Spurious Emissions Measurements (40GHz – 200GHz)**

FCC ID: BCG-A2984 IC: 579C-A2984		MEASUREMENT REPORT (CERTIFICATION)	Approved by: Technical Manager
Test Report S/N: 1C2305020013-17.BCG	Test Dates: 5/2/2023 – 8/11/2023	EUT Type: Watch	Page 29 of 46

## 6.7 Radiated Spurious Emissions (1GHz – 40GHz)

§15.247(d) §15.205 & §15.209; RSS-Gen [8.9]

### Test Overview and Limit

All out of band radiated spurious emissions are measured with a spectrum analyzer connected to a receive antenna while the EUT is operating at its maximum duty cycle, at maximum power, and at the appropriate frequencies. All data rates and modes were investigated for radiated spurious emissions. Only the radiated emissions of the configuration that produced the worst case emissions are reported in this section.

***All out of band emissions appearing in a restricted band as specified in Section 15.205 of the Title 47 CFR and Table 7 of RSS-Gen (8.10) must not exceed the limits shown in Table 6-8 per Section 15.209 and RSS-Gen (8.9).***

Frequency [MHz]	Field Strength [ $\mu\text{V/m}$ ]	Measured Distance [Meters]
960 – 40,000	500	3

**Table 6-8. Radiated Limits**

### Test Procedures Used

ANSI C63.10-2013 Subclause 9.13

### Test Settings

#### Average Field Strength Measurements

1. Analyzer center frequency was set to the frequency of the radiated spurious emission of interest
2. RBW = 1MHz
3. VBW = 3MHz
4. Detector = power average (RMS)
5. Number of measurement points must be  $\geq 2 \times \text{span/RBW}$
6. Sweep time = auto
7. Trace (RMS) averaging was performed over at least 100 traces

#### Peak Field Strength Measurements

1. Analyzer center frequency was set to the frequency of the radiated spurious emission of interest
2. RBW = 1MHz
3. VBW = 3MHz
4. Detector = peak
5. Number of measurement points must be  $\geq 2 \times \text{span/RBW}$
6. Sweep time = auto couple
7. Trace mode = max hold
8. Trace was allowed to stabilize over at least 100 traces

FCC ID: BCG-A2984 IC: 579C-A2984		MEASUREMENT REPORT (CERTIFICATION)	Approved by: Technical Manager
Test Report S/N: 1C2305020013-17.BCG	Test Dates: 5/2/2023 – 8/11/2023	EUT Type: Watch	Page 30 of 46

**Test Setup**

The EUT and measurement equipment were set up as shown in the diagram below.

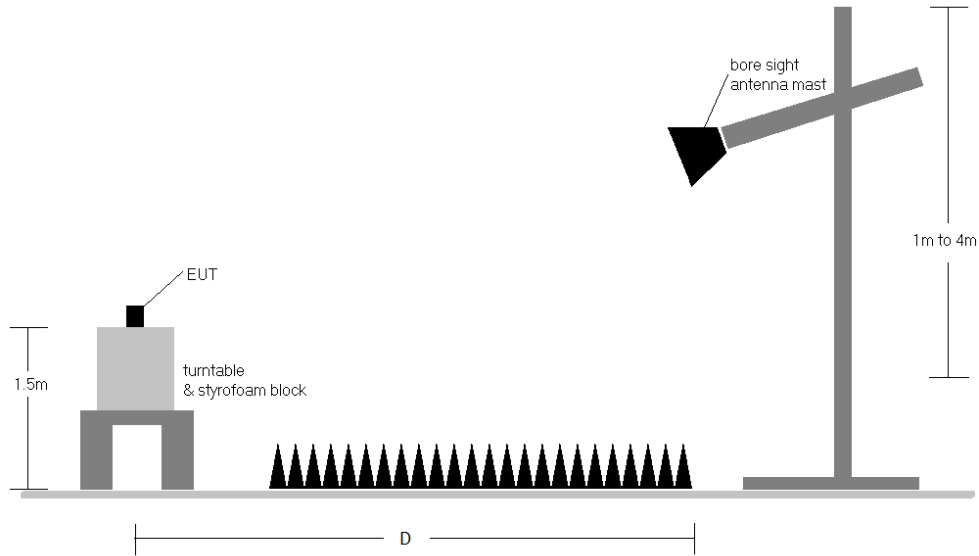

**Figure 6-4. Radiated Spurious Emissions Measurement Test Setup (1GHz - 18GHz)**

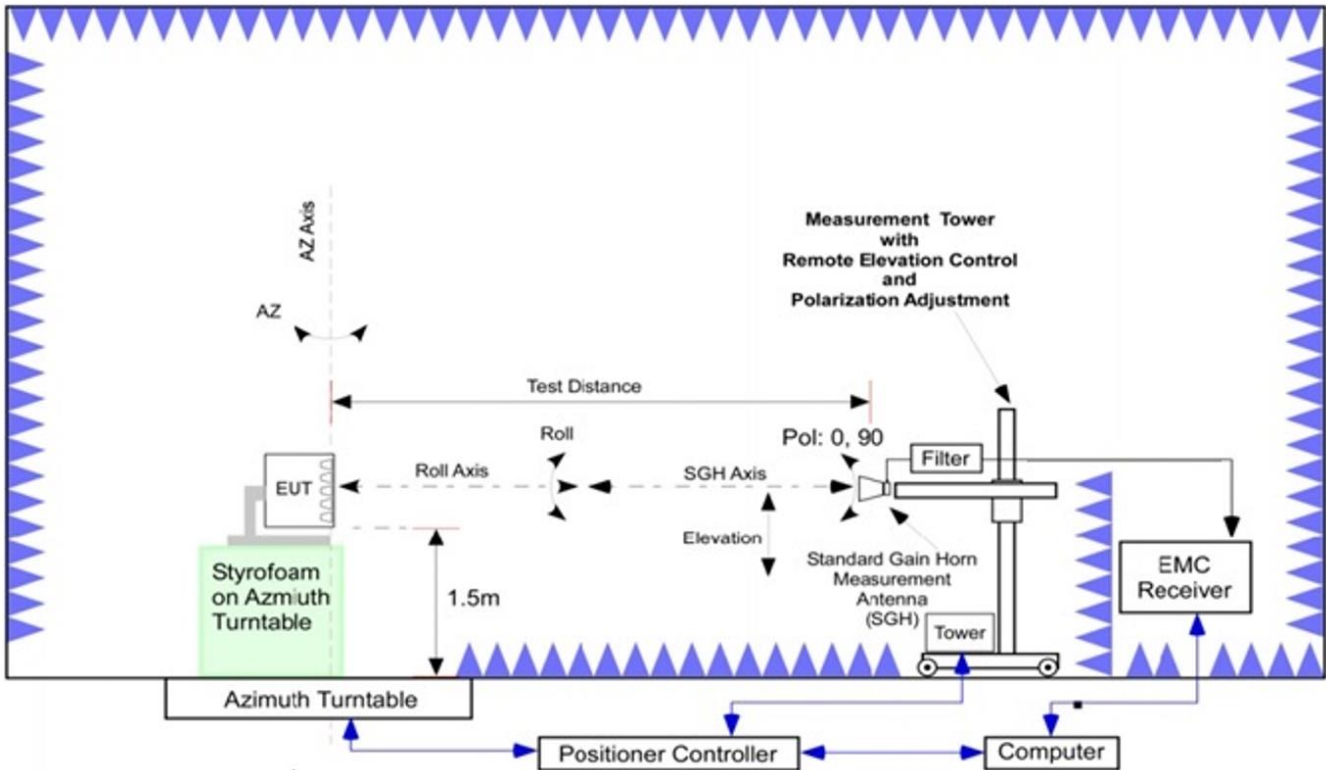

**Figure 6-5. Radiated Spurious Emissions Measurement Test Setup (18GHz - 40GHz)**

FCC ID: BCG-A2984 IC: 579C-A2984		MEASUREMENT REPORT (CERTIFICATION)	Approved by: Technical Manager
Test Report S/N: 1C2305020013-17.BCG	Test Dates: 5/2/2023 – 8/11/2023	EUT Type: Watch	Page 31 of 46

**Test Notes**

1. All emissions lying in restricted bands specified in Section 15.205 and Section 8.10 of RSS-Gen are below the limit shown in Table 6-8.
2. The antenna is manipulated through typical positions, polarity and height during the tests. The EUT is manipulated through three orthogonal planes.
3. Emissions 1GHz - 18GHz were measured at a 3 meter test distance (D = 3m) while emissions 18GHz – 40GHz were measured at a 1 meter test distance (D = 1m) with the application of a distance correction factor.
4. The wide spectrum spurious emissions plots shown on the following pages are used only for the purpose of emission identification. Any emissions found to be within 20dB of the limit are fully investigated and the results are shown in this section.
5. The "-" shown in the following RSE tables are used to denote a noise floor measurement.
6. The unit was tested with all possible modes and only the highest emission is reported.

**Sample Calculations**

**Determining Spurious Emissions Levels**

- Field Strength Level  $_{[dB_{\mu V/m}]} = \text{Analyzer Level }_{[dBm]} + 107 + \text{AFCL }_{[dB/m]}$
- AFCL  $_{[dB/m]} = \text{Antenna Factor }_{[dB/m]} + \text{Cable Loss }_{[dB]} - \text{Preamplifier Gain }_{[dB]}$
- Margin  $_{[dB]} = \text{Field Strength Level }_{[dB_{\mu V/m}]} - \text{Limit }_{[dB_{\mu V/m}]}$

<b>FCC ID:</b> BCG-A2984 <b>IC:</b> 579C-A2984	 <b>MEASUREMENT REPORT (CERTIFICATION)</b>	<b>Approved by:</b> Technical Manager
<b>Test Report S/N:</b> 1C2305020013-17.BCG	<b>Test Dates:</b> 5/2/2023 – 8/11/2023	<b>EUT Type:</b> Watch
		Page 32 of 46



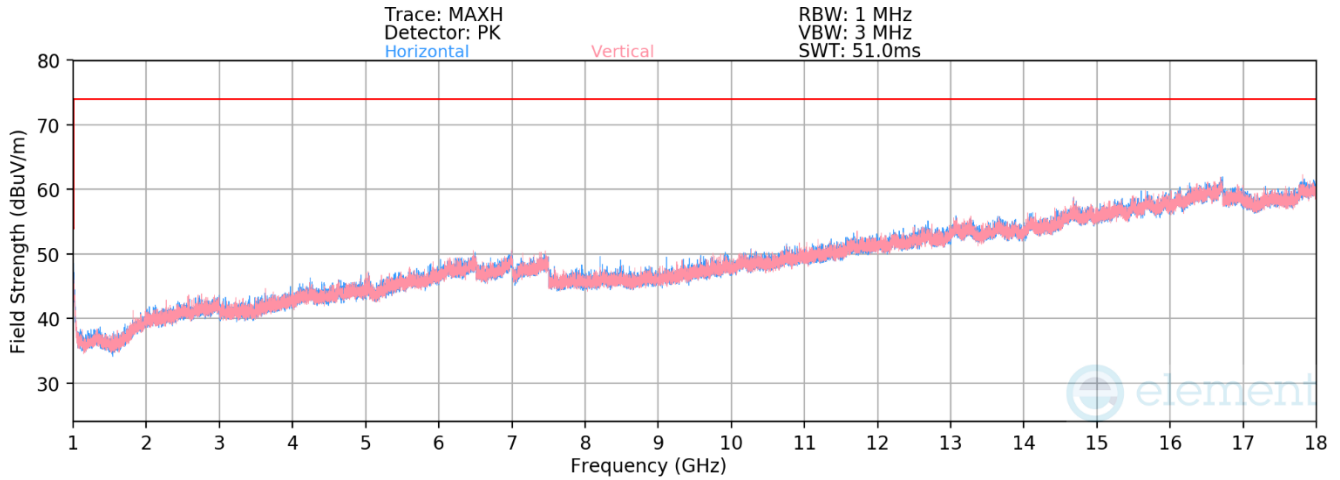

**Plot 6-10. Radiated Spurious Emissions 1GHz – 18GHz (Mode 1)**

<b>FCC ID:</b> BCG-A2984 <b>IC:</b> 579C-A2984	 <b>MEASUREMENT REPORT (CERTIFICATION)</b>	<b>Approved by:</b> Technical Manager
<b>Test Report S/N:</b> 1C2305020013-17.BCG		<b>Test Dates:</b> 5/2/2023 – 8/11/2023

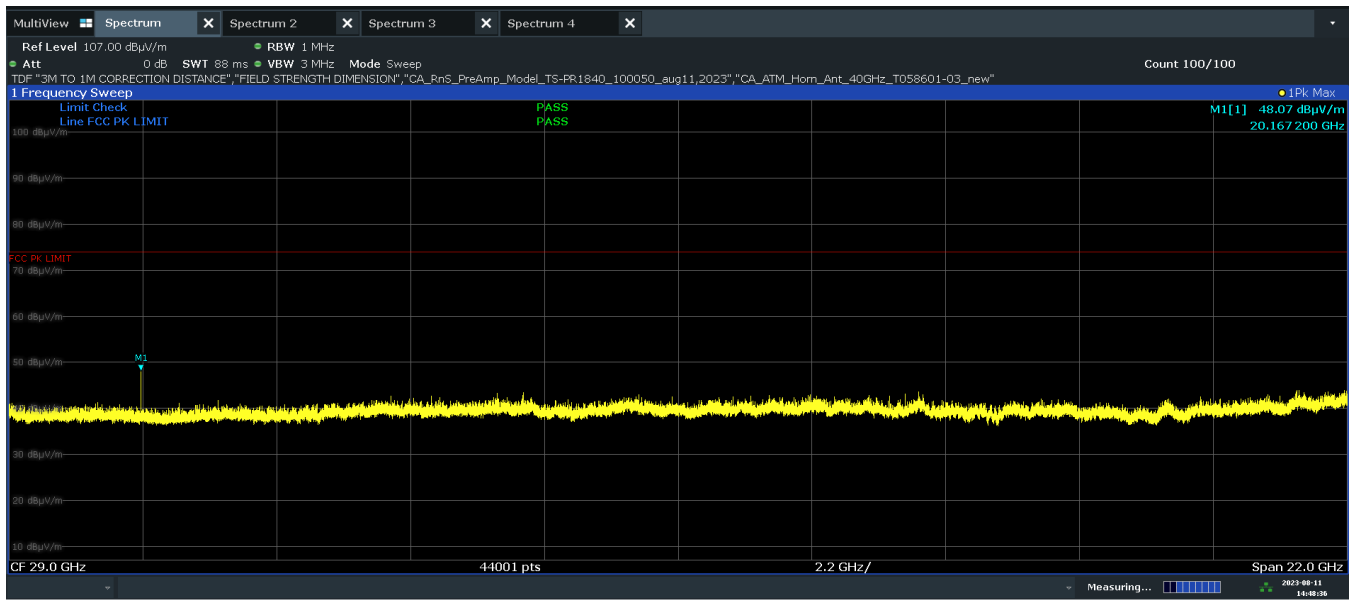

Plot 6-11. Radiated Spurious Emissions 18GHz – 40GHz (Mode 1)

Transmission Mode	Frequency [GHz]	Detector	Polarity [H/V]	Positioner Azimuth [degrees]	Turntable Azimuth [degrees]	Analyzer Level [dBm]	AFCL [dB]	Field Strength Level at 3 meters [dBµV/m]	Limit [dBµV/m]	Margin [dB]
1	20.167	Avg	H	228	303	-53.76	-7.37	45.87	53.98	-8.11
1	20.167	Peak	H	228	303	-51.07	-7.37	48.56	73.98	-25.42

Table 6-10. Radiated Spurious Emission Measurements (18GHz – 40GHz)

FCC ID: BCG-A2984 IC: 579C-A2984		MEASUREMENT REPORT (CERTIFICATION)	Approved by: Technical Manager
Test Report S/N: 1C2305020013-17.BCG	Test Dates: 5/2/2023 – 8/11/2023	EUT Type: Watch	Page 34 of 46

## 6.8 Radiated Spurious Emissions (Below 1GHz)

§15.209; RSS-Gen [8.9]

### Test Overview and Limit

All out of band radiated spurious emissions are measured with a spectrum analyzer connected to a receive antenna while the EUT is operating at its maximum duty cycle, at maximum power, and at the appropriate frequencies. All data rates and modes were investigated for radiated spurious emissions. Only the radiated emissions of the configuration that produced the worst case emissions are reported in this section.

**All out of band emissions appearing in a restricted band as specified in Section 15.205 of the Title 47 CFR and Table 7 of RSS-Gen (8.10) must not exceed the limits shown in Table 6-11 per Section 15.209 and RSS-Gen (8.9).**

Frequency	Field Strength [ $\mu$ V/m]	Measured Distance [Meters]
0.009 – 0.490 MHz	2400/F (kHz)	300
0.490 – 1.705 MHz	24000/F (kHz)	30
1.705 – 30.00 MHz	30	30
30.00 – 88.00 MHz	100	3
88.00 – 216.0 MHz	150	3
216.0 – 960.0 MHz	200	3
Above 960.0 MHz	500	3

**Table 6-11. Radiated Limits**

### Test Procedures Used

ANSI C63.10-2013

### Test Settings

#### Quasi-Peak Field Strength Measurements

1. Analyzer center frequency was set to the frequency of the radiated spurious emission of interest
2. RBW = 120kHz (for emissions from 30MHz – 1GHz)
3. Detector = quasi-peak
4. Sweep time = auto couple
5. Trace mode = max hold
6. Trace was allowed to stabilize

#### Peak Field Strength Measurements

1. Analyzer center frequency was set to the frequency of the radiated spurious emission of interest
2. RBW = 120kHz (for emissions from 30MHz – 1GHz)
3. VBW = 300kHz
4. Detector = peak
5. Sweep time = auto couple
6. Trace mode = max hold

FCC ID: BCG-A2984 IC: 579C-A2984		MEASUREMENT REPORT (CERTIFICATION)	Approved by: Technical Manager
Test Report S/N: 1C2305020013-17.BCG	Test Dates: 5/2/2023 – 8/11/2023	EUT Type: Watch	Page 35 of 46

Version 1.1, 7/29/2022

**Test Setup**

The EUT and measurement equipment were set up as shown in the diagrams below.

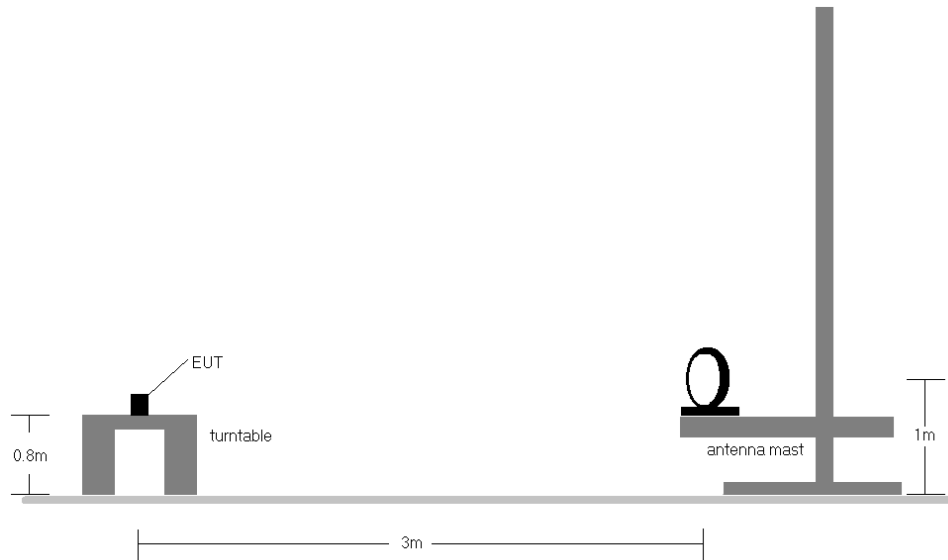

**Figure 6-6. Radiated Test Setup (9kHz – 30MHz)**

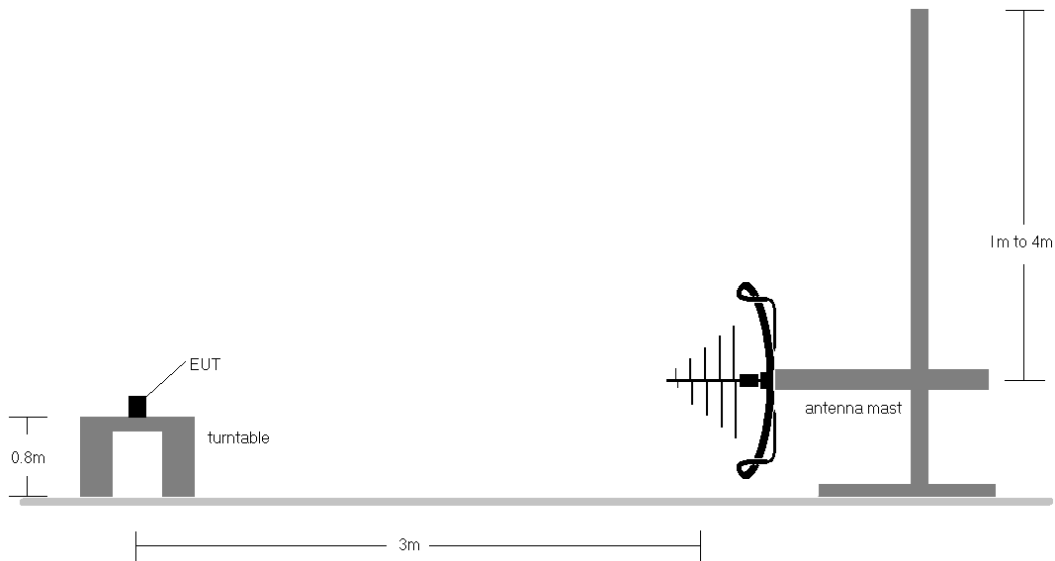

**Figure 6-7. Radiated Test Setup (30MHz – 1GHz)**

<b>FCC ID:</b> BCG-A2984 <b>IC:</b> 579C-A2984	 <b>MEASUREMENT REPORT (CERTIFICATION)</b>	<b>Approved by:</b> Technical Manager
<b>Test Report S/N:</b> 1C2305020013-17.BCG	<b>Test Dates:</b> 5/2/2023 – 8/11/2023	<b>EUT Type:</b> Watch
		Page 36 of 46

**Test Notes**

1. All emissions lying in restricted bands specified in §15.205 and RSS-Gen(8.10) are below the limit shown in Table 6-11.
2. The broadband receive antenna is manipulated through vertical and horizontal polarizations during the tests. The EUT is manipulated through three orthogonal planes. For below 30MHz measurements, the loop antenna was positioned in three orthogonal planes (X front, Y side, and Z top) to determine the orientation resulting in the worst case emissions.
3. The spectrum is investigated using a peak detector and final measurements are recorded using CISPR quasi peak detector for emissions within 6dB of the limit.
4. Emissions were measured at a 3 meter test distance.
5. Emissions are investigated while operating on the modulation and data rate that produced the worst case results during the transmitter spurious emissions testing.
6. No spurious emissions were detected within 20dB of the limit below 30MHz.
7. The results recorded using the broadband antenna is known to correlate with the results obtained by using a tuned dipole with an acceptable degree of accuracy. The VSWR for the measurement antenna was found to be less than 2:1.
8. The unit was tested with all possible modes and only the highest emission is reported.
9. The following configuration below was used for testing:
  - a. EUT powered by host Laptop via USB-C cable

<b>FCC ID:</b> BCG-A2984 <b>IC:</b> 579C-A2984	 <b>MEASUREMENT REPORT (CERTIFICATION)</b>	<b>Approved by:</b> Technical Manager
<b>Test Report S/N:</b> 1C2305020013-17.BCG	<b>Test Dates:</b> 5/2/2023 – 8/11/2023	<b>EUT Type:</b> Watch
		Page 37 of 46

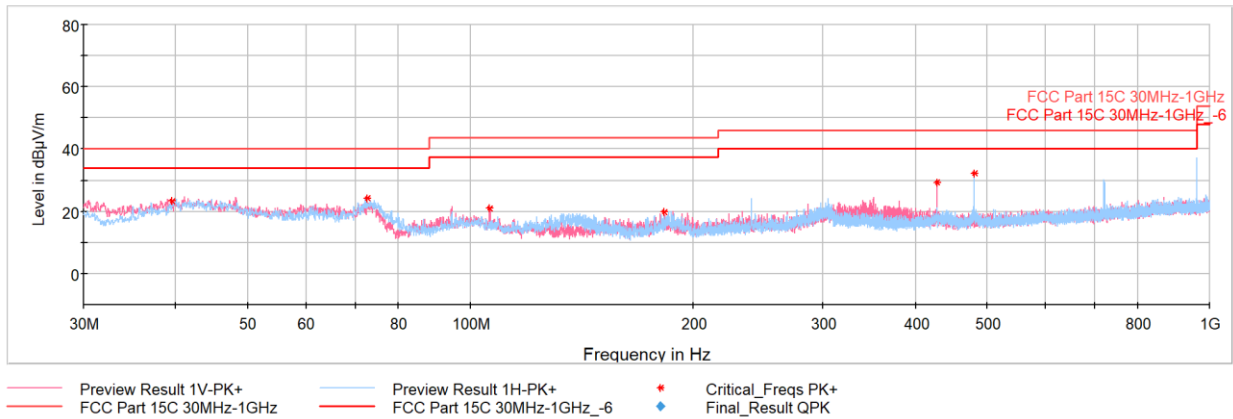

**Plot 6-12. Radiated Spurious Emissions 30MHz – 1GHz (Mode 1, with Magnetic Charger & Laptop)**

Frequency [MHz]	Detector	Ant. Pol. [H/V]	Antenna Height [cm]	Turntable Azimuth [degree]	Analyzer Level [dBm]	AFCL [dB/m]	Field Strength [dBµV/m]	Limit [dBµV/m]	Margin [dB]
39.51	Max Peak	V	200	155	-66.52	-17.18	23.30	40.00	-16.70
72.54	Max Peak	H	300	317	-61.37	-21.28	24.35	40.00	-15.65
106.39	Max Peak	V	200	14	-67.51	-18.53	20.96	43.52	-22.56
182.68	Max Peak	V	100	294	-67.74	-19.34	19.92	43.52	-23.60
427.80	Max Peak	V	100	269	-65.54	-12.05	29.41	46.02	-16.61
479.98	Max Peak	H	200	96	-63.58	-11.08	32.34	46.02	-13.68

**Table 6-12. Radiated Spurious Emissions 30MHz – 1GHz (Mode 1, with Magnetic Charger & Laptop)**

FCC ID: BCG-A2984 IC: 579C-A2984		MEASUREMENT REPORT (CERTIFICATION)	Approved by: Technical Manager
Test Report S/N: 1C2305020013-17.BCG	Test Dates: 5/2/2023 – 8/11/2023	EUT Type: Watch	Page 38 of 46

## 6.9 Frequency Stability

§15.255(f); RSS-210 Annex J.6

### Test Overview and Limit

Frequency stability testing is performed in accordance with the guidelines of ANSI C63.10-2013 Subclause 9.14. The frequency stability of the transmitter is measured whilst varying the following operating conditions:

- a) **Temperature:** The temperature is varied from -20°C to +50°C in 10°C increments using an environmental temperature chamber at nominal supply voltage.
- b) **Primary Supply Voltage:** The primary supply voltage is varied from 85% to 115% of the rated input voltage for non hand-carried battery and AC powered equipment. For hand-carried, battery-powered equipment, primary supply voltage is reduced to the battery operating end point which shall be specified by the manufacturer.

***Fundamental emissions must be contained within the frequency bands specified in the according rule parts (57 – 71 GHz) during all conditions of operation.***

### Test Procedure Used

ANSI C63.10-2013 Subclause 9.14

### Test Settings

1. The spectrum mask of the EUT emission is measured at ambient room temperature and nominal operating voltage (100%) to provide a reference. The spectrum mask of the EUT emission is defined by frequency measurements taken at the lower and upper regions of the fundamental emission ( $F_{low}$  and  $F_{high}$ ).
2. EUT primary supply voltage is varied between 85% and 115% of the nominal supply voltage (at room temperature). Frequency excursion of the EUT emission mask is recorded at each of these conditions.
3. With primary supply voltage set to the nominal value, EUT operating temperature is increased to +50°C using an environmental chamber. Frequency excursion of the EUT emission mask is recorded.
4. EUT operating temperature is decreased by 10°C intervals until reaching -20°C. Frequency excursion of the EUT emission mask is recorded at each temperature condition.

FCC ID: BCG-A2984 IC: 579C-A2984		MEASUREMENT REPORT (CERTIFICATION)	Approved by: Technical Manager
Test Report S/N: 1C2305020013-17.BCG	Test Dates: 5/2/2023 – 8/11/2023	EUT Type: Watch	Page 39 of 46

Version 1.1, 7/29/2022

**Test Setup**

The EUT was measured using horn antenna connected to a spectrum analyzer. The EUT was placed inside an environmental chamber. Using a foam plug, the horn antenna measured the frequency of the fundamental signal.

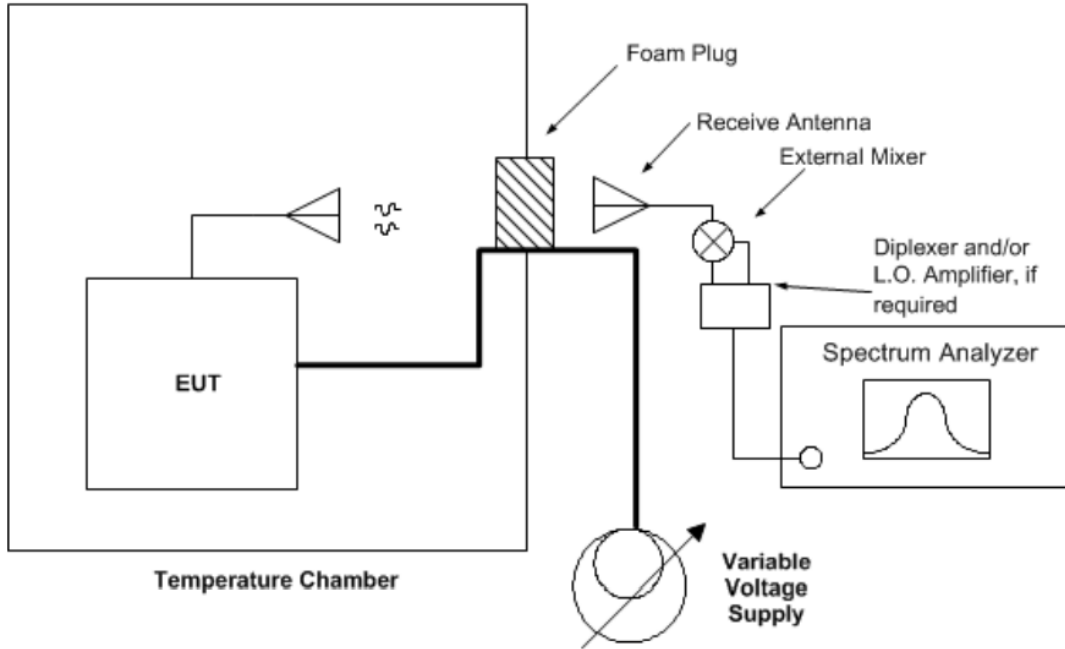

**Figure 6-8. Frequency Stability Test Instrument & Measurement Setup**

**Test Notes**

1. All modes of operation were investigated and only worst case results are reported.

<b>FCC ID:</b> BCG-A2984 <b>IC:</b> 579C-A2984		<b>MEASUREMENT REPORT (CERTIFICATION)</b>	<b>Approved by:</b> Technical Manager
<b>Test Report S/N:</b> 1C2305020013-17.BCG	<b>Test Dates:</b> 5/2/2023 – 8/11/2023	<b>EUT Type:</b> Watch	Page 40 of 46



Test Conditions	Transmitter Frequency Range [GHz]		Pass/Fail
	$f_{Low}$	$f_{High}$	
-20 deg C / $V_{nom}$	59.1103	61.6379	Pass
-10 deg C / $V_{nom}$	58.8521	62.0141	Pass
0 deg C / $V_{nom}$	57.0710	63.8836	Pass
+10 deg C / $V_{nom}$	57.0684	63.8706	Pass
+20 deg C / $V_{nom}$	57.3684	63.6422	Pass
+30 deg C / $V_{nom}$	59.5495	62.0833	Pass
+40 deg C / $V_{nom}$	58.8317	61.3963	Pass
+50 deg C / $V_{nom}$	58.4549	62.1927	Pass
+20 deg C / 85% voltage	59.4040	61.5780	Pass
+20 deg C / 115% voltage	59.5898	61.8048	Pass

**Table 6-13. Frequency Stability Measurements (Mode 1)**

FCC ID: BCG-A2984 IC: 579C-A2984		MEASUREMENT REPORT (CERTIFICATION)	Approved by: Technical Manager
Test Report S/N: 1C2305020013-17.BCG	Test Dates: 5/2/2023 – 8/11/2023	EUT Type: Watch	Page 41 of 46

## 6.10 AC Line Conducted Emissions Measurements

§15.207; RSS-Gen [8.8]

### Test Overview and Limit

All AC line conducted spurious emissions are measured with a receiver connected to a grounded LISN while the EUT is operating at its maximum duty cycle, at maximum power, and at the appropriate frequencies. All data rates and modes were investigated for AC Line conducted spurious emissions. Only the conducted emissions of the configuration that produced the worst case emissions are reported in this section.

**All conducted emissions must not exceed the limits shown in the table below, per Section 15.207 and RSS-Gen (8.8).**

Frequency of emission (MHz)	Conducted Limit (dB $\mu$ V)	
	Quasi-peak	Average
0.15 – 0.5	66 to 56*	56 to 46*
0.5 – 5	56	46
5 – 30	60	50

**Table 6-14. Conducted Limits**

\*Decreases with the logarithm of the frequency.

### Test Procedures Used

ANSI C63.10-2013, Subclause 6.2

### Test Settings

#### Quasi-Peak Measurements

1. Analyzer center frequency was set to the frequency of the spurious emission of interest
2. RBW = 9kHz (for emissions from 150kHz – 30MHz)
3. Detector = quasi-peak
4. Sweep time = auto couple
5. Trace mode = max hold
6. Trace was allowed to stabilize

#### Average Measurements

1. Analyzer center frequency was set to the frequency of the spurious emission of interest
2. RBW = 9kHz (for emissions from 150kHz – 30MHz)
3. Detector = RMS
4. Sweep time = auto couple
5. Trace mode = max hold
6. Trace was allowed to stabilize

FCC ID: BCG-A2984 IC: 579C-A2984		MEASUREMENT REPORT (CERTIFICATION)	Approved by: Technical Manager
Test Report S/N: 1C2305020013-17.BCG	Test Dates: 5/2/2023 – 8/11/2023	EUT Type: Watch	Page 42 of 46

### Test Setup

The EUT and measurement equipment were set up as shown in the diagram below.

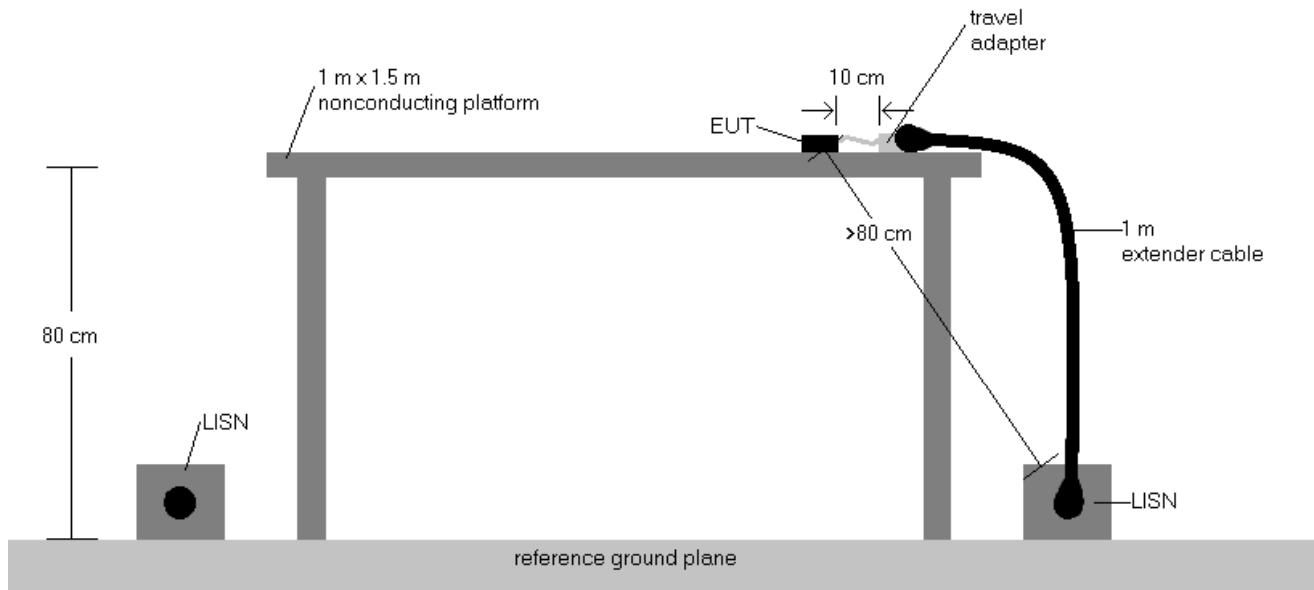

Figure 6-9. AC Line Conducted Test Instrument & Measurement Setup

### Test Notes

1. All modes of operation were investigated for AC line conducted spurious emissions and the worst-case emissions are reported.
2. The limit for an intentional radiator from 150kHz to 30MHz are specified in Part 15.207 and RSS-Gen(8.8).
3.  $\text{Corr. (dB)} = \text{Cable loss (dB)} + \text{LISN insertion factor (dB)}$
4.  $\text{QP/AV Level (dB}\mu\text{V)} = \text{QP/AV Analyzer/Receiver Level (dB}\mu\text{V)} + \text{Corr. (dB)}$
5.  $\text{Margin (dB)} = \text{QP/AV Level (dB}\mu\text{V)} - \text{QP/AV Limit (dB}\mu\text{V)}$
6. Traces shown in plot are made using quasi-peak and average detectors.
7. Deviations to the Specifications: None.
8. The following configuration below was used for testing:
  - a. EUT powered by host Laptop via USB-C cable

FCC ID: BCG-A2984 IC: 579C-A2984		MEASUREMENT REPORT (CERTIFICATION)	Approved by: Technical Manager
Test Report S/N: 1C2305020013-17.BCG	Test Dates: 5/2/2023 – 8/11/2023	EUT Type: Watch	Page 43 of 46

Version 1.1, 7/29/2022

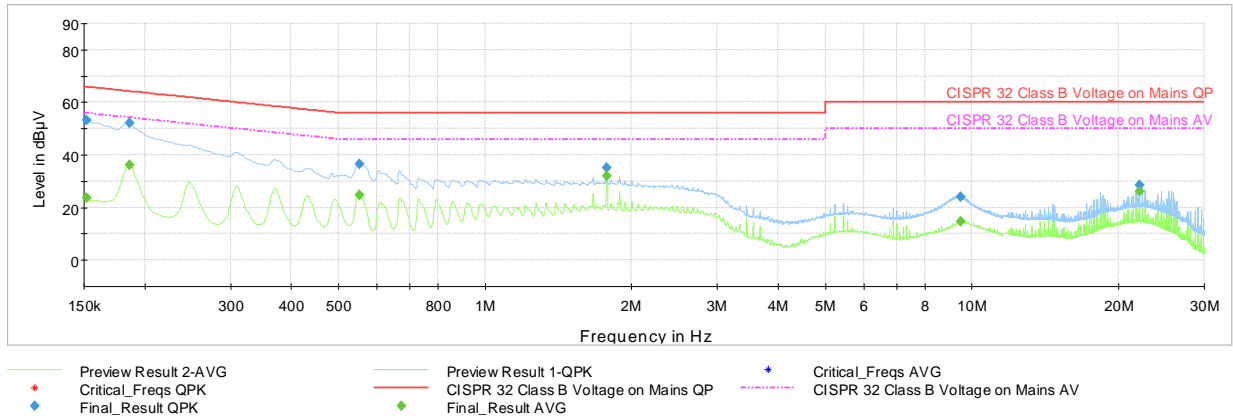

**Plot 6-13. AC Line Conducted Plot (L1 - Mode 1, with Magnetic Charger & Laptop)**

Frequency [MHz]	Process State	QuasiPeak [dBµV]	Average [dBµV]	Limit [dBµV]	Margin [dB]	Line	PE
0.152	FINAL	—	23.63	55.88	-32.25	L1	GND
0.152	FINAL	53.2	—	65.88	-12.66	L1	GND
0.186	FINAL	—	36.06	54.21	-18.16	L1	GND
0.186	FINAL	52.1	—	64.21	-12.13	L1	GND
0.553	FINAL	36.4	—	56.00	-19.57	L1	GND
0.553	FINAL	—	24.73	46.00	-21.27	L1	GND
1.777	FINAL	35.0	—	56.00	-20.99	L1	GND
1.777	FINAL	—	32.00	46.00	-14.00	L1	GND
9.485	FINAL	—	14.54	50.00	-35.46	L1	GND
9.488	FINAL	24.0	—	60.00	-35.99	L1	GND
22.110	FINAL	—	26.21	50.00	-23.79	L1	GND
22.110	FINAL	28.6	—	60.00	-31.39	L1	GND

**Table 6-15. AC Line Conducted Data (L1 - Mode 1, with Magnetic Charger & Laptop)**

FCC ID: BCG-A2984 IC: 579C-A2984		MEASUREMENT REPORT (CERTIFICATION)	Approved by: Technical Manager
Test Report S/N: 1C2305020013-17.BCG	Test Dates: 5/2/2023 – 8/11/2023	EUT Type: Watch	Page 44 of 46

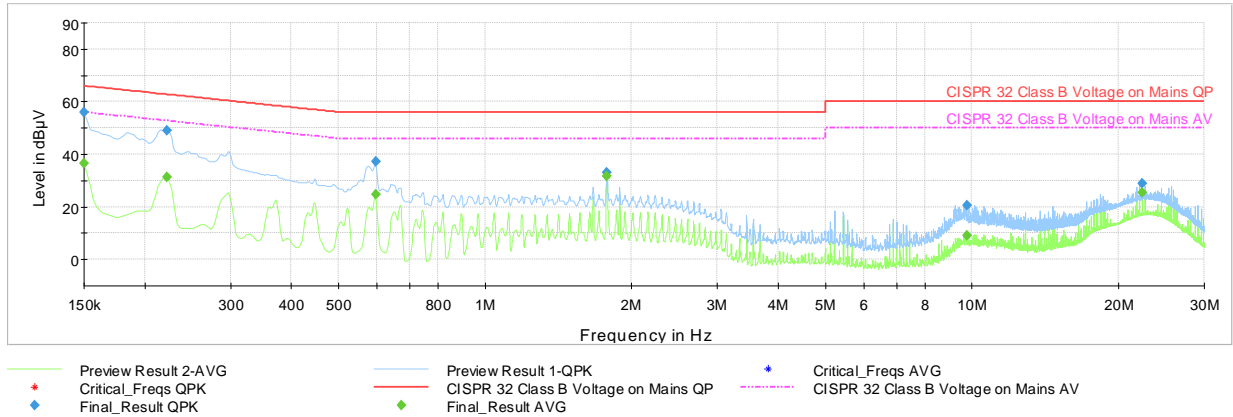

**Plot 6-14. AC Line Conducted Plot (N - Mode 1, with Magnetic Charger & Laptop)**

Frequency [MHz]	Process State	QuasiPeak [dBµV]	Average [dBµV]	Limit [dBµV]	Margin [dB]	Line	PE
0.150	FINAL	—	36.45	56.00	-19.55	N	GND
0.150	FINAL	55.9	—	66.00	-10.10	N	GND
0.222	FINAL	—	31.18	52.74	-21.56	N	GND
0.222	FINAL	49.2	—	62.74	-13.56	N	GND
0.596	FINAL	37.2	—	56.00	-18.83	N	GND
0.596	FINAL	—	24.74	46.00	-21.26	N	GND
1.777	FINAL	33.0	—	56.00	-23.02	N	GND
1.777	FINAL	—	31.58	46.00	-14.42	N	GND
9.762	FINAL	—	9.22	50.00	-40.78	N	GND
9.767	FINAL	20.4	—	60.00	-39.60	N	GND
22.333	FINAL	—	25.27	50.00	-24.73	N	GND
22.333	FINAL	28.8	—	60.00	-31.21	N	GND

**Table 6-16. AC Line Conducted Data (N - Mode 1, with Magnetic Charger & Laptop)**

FCC ID: BCG-A2984 IC: 579C-A2984		<b>MEASUREMENT REPORT (CERTIFICATION)</b>		Approved by: Technical Manager
Test Report S/N: 1C2305020013-17.BCG	Test Dates: 5/2/2023 – 8/11/2023	EUT Type: Watch		Page 45 of 46

## 7.0 CONCLUSION

The data collected relate only to the item(s) tested and show that the **Apple Watch FCC ID: BCG-A2984** and **IC: 579C-A2984** is in compliance with Part 15 Subpart C (15.255) of the FCC Rules and RSS-210 Annex J of the Innovation, Science, and Economic Development of Canada Rules.

<b>FCC ID:</b> BCG-A2984 <b>IC:</b> 579C-A2984	 <b>MEASUREMENT REPORT (CERTIFICATION)</b>		<b>Approved by:</b> Technical Manager
<b>Test Report S/N:</b> 1C2305020013-17.BCG	<b>Test Dates:</b> 5/2/2023 – 8/11/2023	<b>EUT Type:</b> Watch	Page 46 of 46

Version 1.1, 7/29/2022