



# REPORT

issued by an FCC listed Laboratory Reg. no. 93866.  
The test site complies with RSS Gen, file no: IC 3482A

Date  
2010-08-16

Reference  
FX009340-4

Page  
1 (2)



Handled by, department  
**Reinhold Reul**  
Electronics  
+46 10 516 55 84, reinhold.reul@sp.se

Ericsson (China) Communications Company Ltd  
Att. Hua Yang  
Ericsson Tower  
No. 5 Lize East Street  
Chaoyang District, Beijing 100102  
P. R. China

## Permissible change measurements on GSM Base station Transceiver unit with FCC ID: B5KDKRC1311005-2

(8 appendices)

### Test object

Transceiver Unit dTRU 8 Edge, KRC 131 1005/2, Rev. R4A, SN AE53038594

See appendix 1 for general information. Appendix 7 lists hardware and software.  
Appendix 8 shows photos of the test object.

### Summary

Standard	Compliant	Appendix	Remarks
<b>FCC CFR 47</b>			
2.1046 RF Power output	Yes	2	-
2.1049 Occupied bandwidth	Yes	3	-
2.1051 Band Edge	Yes	4	Note 1
2.1051 Spurious emission at antenna port	Yes	5	-
2.1053 Field strength of spurious radiation	Yes	6	-

Note 1: The maximum output power that can be used on the channels adjacent to the frequency band edges (channel 128 and 251) with CDU-G 8 is with the RBS master 2E control software configured with a value of 39, resulting in a maximum measured RMS output power of 38.3 dBm for 16QAM and 37.8 dBm for 32QAM modulation.

### SP Technical Research Institute of Sweden

Electronics – EMC

Christer Karlsson  
Technical Manager

Reinhold Reul  
Technical Officer

### SP Technical Research Institute of Sweden

Postal address  
SP  
Box 857  
SE-501 15 Borås  
SWEDEN

Office location  
Västeråsen  
Brinellgatan 4  
SE-504 62 Borås  
SWEDEN

Phone / Fax / E-mail  
+46 10 516 50 00  
+46 33 13 55 02  
info@sp.se

Laboratories are accredited by the Swedish Board for Accreditation and Conformity Assessment (SWEDAC) under the terms of Swedish legislation. This report may not be reproduced other than in full, except with the prior written approval of the issuing laboratory.



FCC ID: B5KDKRC1311005-2

**Table of contents**

Description of the test object	Appendix 1
Operation mode during measurements	Appendix 1
Purpose of test	Appendix 1
Test setups	Appendix 1
RF power output	Appendix 2
Occupied bandwidth	Appendix 3
Band edge	Appendix 4
Spurious emission at antenna terminals	Appendix 5
Field strength of spurious radiation	Appendix 6
Hardware list and software	Appendix 7
Photos of the test object	Appendix 8

**Description - Equipment Under Test (EUT)**

Equipment: GSM Base station transceiver unit (dTRU) 850 MHz

TX frequency range: 869.2 – 893.8 MHz

Modulations: GMSK, 8PSK, 16QAM and 32QAM

Nominal maximum output power, RMS value in [dBm]	Modulation			
	GMSK	8PSK	16QAM	32QAM
In uncombined (UC) mode	46.3	43.0	41.6	41.2
In combined (HC) mode	43.0	39.7	38.3	37.9
In TCC mode	49.0	45.7	44.3	43.9

Supply voltage to test object 27.2 V DC  
supplied internally from backplane in the RBS 2206 V2.  
The RBS backplane was powered by the PSU output.  
The PSU was supplied from the AC mains.

**Purpose of test**

The purpose of this test is to justify a Class II permissive change of the test object to include the use of 16QAM and 32QAM modulation. This report verifies maintained performance characteristics of affected items according FCC CFR47 by re-testing the updated equipment with GMSK, 16QAM and 32QAM modulation.

**Summary of results**

Measurement results are near identical for all modulations, apart from RMS output power, where GMSK modulation results in the highest RMS output power. GMSK modulation can be considered a worst case set-up.

**Tested configuration**

All measurements were performed with the test object installed in a RBS 2206 V2 rack. The hardware lists for radiated and conducted measurements are shown in appendix 7. The test object was activated at maximum power, configured for TCC mode with RBS master 2E setting 51, resulting in the highest output power achievable. Random data was transmitted in all time slots with the various modulations being tested, one at a time. This set-up was considered a worst-case configuration.

An additional band edge measurement was done on the channels 128 and 251 adjacent to the band edge with the test object configured for uncombined (UC) mode and the output power reduced as far as necessary to meet band edge requirements on channels 128 and 251. In this configuration only TX 1 was active with RBS master 2E software setting 39. Random data was transmitted in all time slots with various modulations being tested, one at a time.

**Conducted measurements**

Conducted measurements were done at the output connector of the CDU-G 8, product number BFL 119 155/1, revision R3A, serial number A40004WCLZ.

**Radiated measurements**

During radiated emission measurements the CDU-G 8 output TX(/RX) 0 was via a 50 ohm attenuator connected to a spectrum analyser to monitor the transmitted signal. For the scope of this test it was deemed sufficient to measure and compare radiated spurious emission at the TX band center frequency for GMSK, 16QAM and 32QAM modulation. GMSK modulation with approximately 3.5 dB higher RMS output power than 8PSK modulation was chosen as worst case reference modulation to compare the new 16QAM and 32QAM modulations with.

**Frequencies used**

ARFCN	Frequency	Comment
128	869.2 MHz	Low TX frequency used in uncombined (UC) mode
129	869.4 MHz	Low TX frequency used in TCC mode
190	881.6 MHz	TX band center frequency, used in TCC mode
250	893.6 MHz	High TX frequency used in TCC mode
251	893.8 MHz	High TX frequency used in uncombined (UC) mode

**Manufacturer's representative**

Hua Yang, Ericsson (China) Communications Company Ltd

**References**

Measurements were done according to relevant parts of the following standards:  
ANSI/TIA/EIA-603-C-2004  
ANSI/TIA/EIA 136-280-D-2002

**Reservation**

The test results in this report apply only to the particular Equipment Under Test (EUT) as declared in the report.

**Delivery of test object**

The test object was delivered: 2010-05-07

**Test equipment**

Measurement equipment	Calibration Due	SP number
Anechoic chamber, Hertz	2010-10	15:116
Boonton RF Peak power meter/analyzer	2010-09	503 144
Boonton Power sensor 56518-S/4	2012-02	503 146
Rohde & Schwarz FSQ40	2010-07	504 143
Rohde & Schwarz FSIQ40	2010-10	503 738
Rohde & Schwarz ESI40	2010-07	503 125
Rohde & Schwarz Vector Network Analyser	2010-07	503 687
Chase bilog antenna CBL 6121A	2011-10	502 460
Schaffner Reference Dipole BSRD6500	2012-03	502 181
EMCO Horn Antenna 3115	2011-01	502 175
EMCO Horn Antenna 3115	2011-02	501 548
MITEQ Low Noise Amplifier	2010-06	503 277
Attenuator 40 dB	2010-06	504 159
Attenuator 30 dB	2010-08	900 229
Wainright high pass filter	2011-03	504 199
RLC Electronics high pass filter F-16149	2010-06	503 739
Multimeter Fluke 87	2011-01	502 190
Testo 615 temperature and humidity meter	2012-03	503 498

**Uncertainties**

Measurement and test instrument uncertainties are described in the quality assurance documentation "SP-QD 10885". The uncertainties are calculated with a coverage factor  $k=2$  (95% level of confidence).

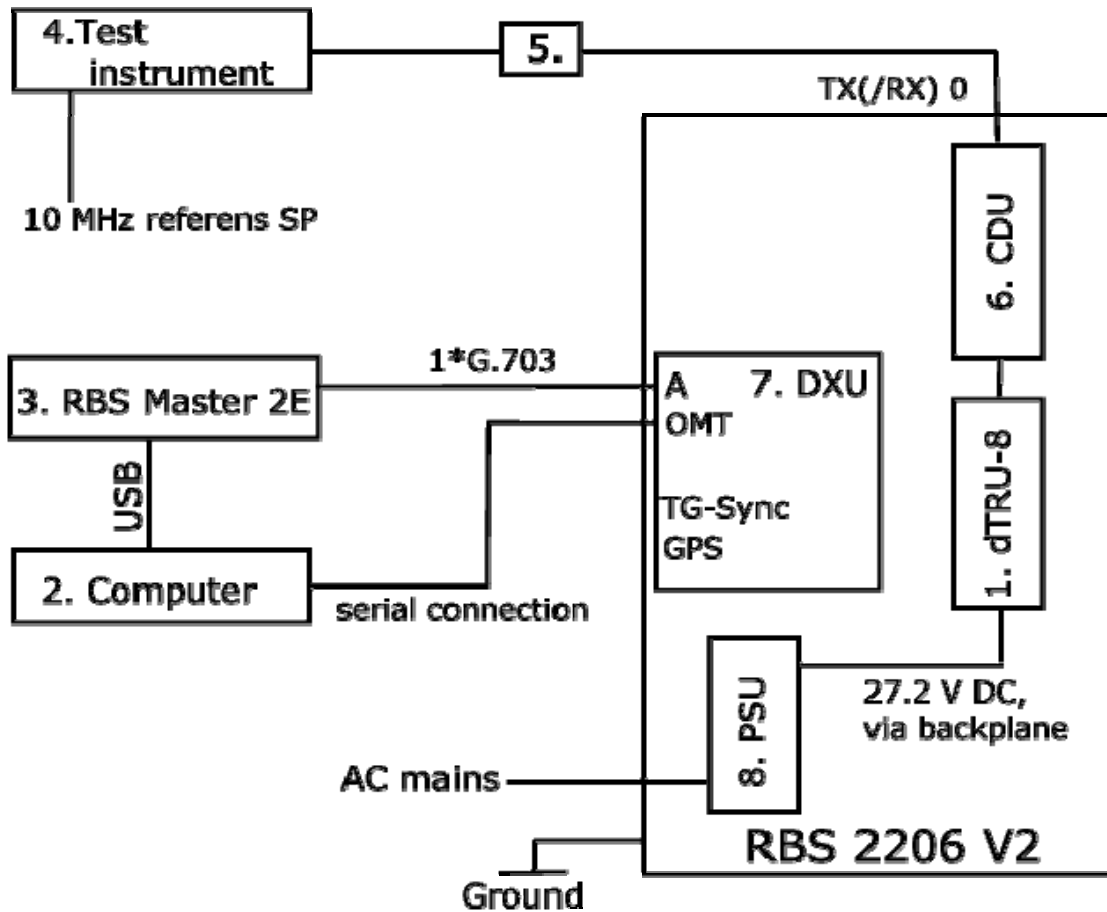
**Test engineers**

Fredrik Isaksson and Reinhold Reul

**Test witnesses**

Bo Zhao and Kevin Sun, Ericsson (China) Communications Company Ltd.

**Test set-up, conducted measurements**



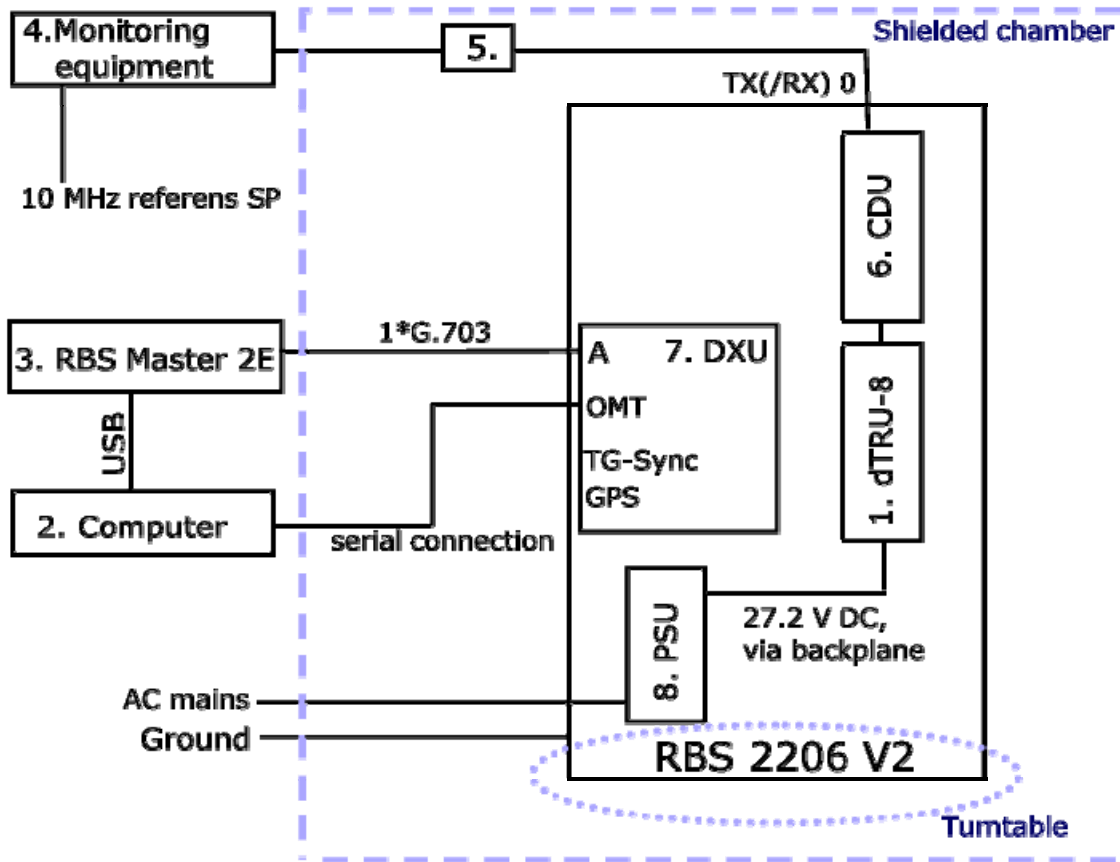
**Test object**

1. Transceiver Unit dTRU-8 Edge,  
product number KRC 131 1005/2, revision R4A, SN AE53038594  
with FCC ID: B5KDKRC1311005-2

**Functional test equipment**

2. HP laptop computer model Compaq NC6400,SN CND70310FD  
With software RBS Master2 control software, revision R7D02
3. Ericsson RBS Master 2E hardware, product number LBY 107 1007/3, revision R1C  
BAMS 1000735209
4. Measurement equipment specified in respective appendix  
The modulation type was verified using client-supplied Agilent MXA Signal Analyser  
model N9020A 20 Hz – 26.5 GHz, BAMS 1000737857
5. Attenuator / filter listed under test equipment in respective appendix
6. CDU-G 8, product BFL 119 155/1, revision R3A, serial number A40004WCLZ
7. DXU according RBS hardware list in appendix 7
8. PSU according RBS hardware list in appendix 7

**Test set-up, radiated emission**



**Test object**

1. Transceiver Unit dTRU-8 Edge,  
product number KRC 131 1005/2, revision R4A, SN AE53038594  
with FCC ID: B5KDKRC1311005-2

**Functional test equipment**

2. HP laptop computer model Compaq NC6400 SN CND72717JP  
With software RBS Master2 control software, revision R7D02
3. Ericsson RBS Master 2E hardware, product number LBY 107 1007/3, revision R1C,  
BAMS 1000735211
4. Rohde & Schwarz FSIQ40 for signal monitoring, SP 503738
5. Attenuator 30 dB, SP 900229
6. CDU-G 8, product BFL 119 155/1, revision R3A, serial number A40004WCLZ
7. DXU according RBS hardware list in appendix 7
8. PSU according RBS hardware list in appendix 7



FCC ID: B5KDKRC1311005-2

Appendix 1

**Test object dTRU-8 connections**

**Interface**

27.2 V DC via PSU & RBS backplane  
TX 1 + TX 2, interconnection to CDU in TCC mode  
Interconnection TX 1 + HC 1 in TCC mode  
Interconnection TX 2 + HC 2 in TCC mode  
RX 1 to CXU10  
RX 2 to CXU10  
RX 3 not connected  
RX 4 not connected

**Type of port**

DC power  
RF/Antenna  
RF interconnect in  
TCC mode  
RF/Antenna  
RF/Antenna  
RF/Antenna  
RF/Antenna

**External RBS rack connections**

**Interface**

AC mains  
Used CDU TX(/RX) 0, used for measurement / monitoring  
Used CDU TX(/RX) 1 and other CDU's outputs were unconnected  
G.703, shielded multi-wire with RJ-45connector, mode E1  
External alarm not connected  
ESB not connected  
GPS not connected  
OMT interface (only configuration, not connected in normal use)

**Type of port:**

AC power  
RF/Antenna  
RF/Antenna  
Telecom  
Signal  
Signal  
Signal  
O/M





**RF Power output measurements according to CFR 47 2.1046**

Date 2010-05-20	Temperature 22 °C ± 3 °C	Humidity 60 % ± 5 %
--------------------	-----------------------------	------------------------

**Test set-up and procedure**

Measurements were made at the CDU-G output connector. The output was connected to a Peak power analyser via a 50 ohm attenuator.

Measurement equipment	SP number
Boonton RF Peak power meter/analyzer	503 144
Boonton Power sensor 56518-S/4	503 146
Multimeter Fluke 87	502 190
Testo 615 temperature and humidity meter	503 498

**Measurement uncertainty:** 0.7 dB

**Results**

Configuration: TCC mode, RBS master 2E setting 51

The measurement was performed at ARFCN 190 (881.6 MHz).

Test conditions Modulation		Transmitter power (dBm)		
		Peak / RMS		
		GMSK	16QAM	32QAM
T <sub>nom</sub> 22 °C	V <sub>nom</sub> 27.2 V DC	49.6 / 48.8	49.7 / 44.9	49.8 / 44.1

**Limits**

CFR 47 § 22.913: 500 W ERP shall not be exceeded.

Complies?	Yes
-----------	-----



**Occupied bandwidth measurements according to 47CFR 2.1049**

Date 2010-05-20	Temperature 22 °C ± 3 °C	Humidity 60 % ± 5 %
--------------------	-----------------------------	------------------------

**Test set-up and procedure**

Measurements were made at CDU-G 8 output connector. The output was connected to a spectrum analyser with the RMS detector activated. The spectrum analyser was connected to an external 10 MHz reference standard during the measurements.

Measurement equipment	SP number
Rohde & Schwarz FSQ40	504 143
Attenuator	504 159
Testo 615 temperature and humidity meter	503 498

**Measurement uncertainty:** 3.7 dB, 1.33 kHz

**Results**

The results are shown in appendix 3.1

Configuration: TCC mode, RBS master 2E setting 51

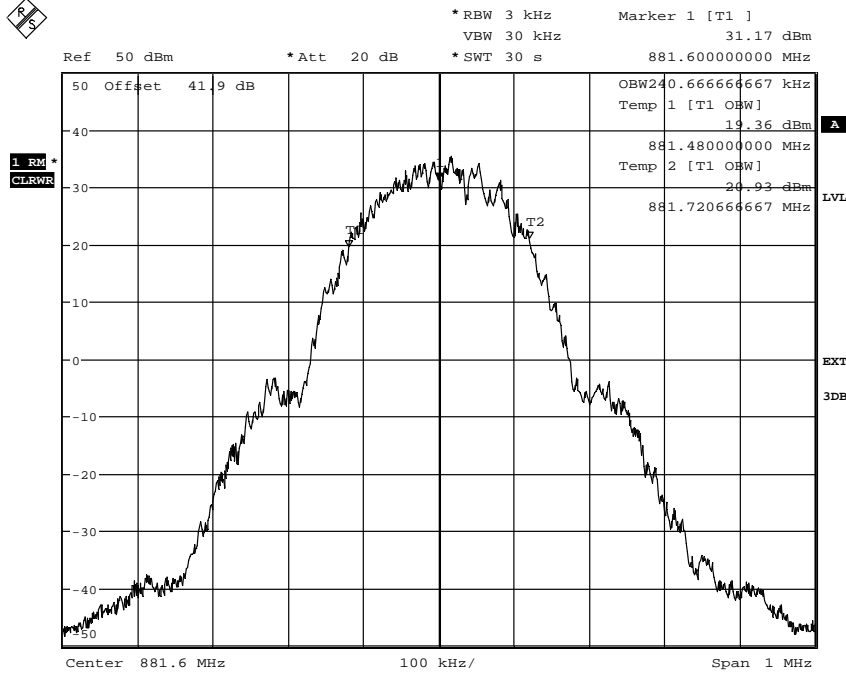
The measurement was performed at ARFCN 190 (881.6 MHz).

	<b>Modulation</b>	<b>OBW</b>	
Diagram 1:	GMSK	240.7	kHz
Diagram 2:	16QAM	240.0	kHz
Diagram 3:	32QAM	241.3	kHz

Complies?	Yes
-----------	-----

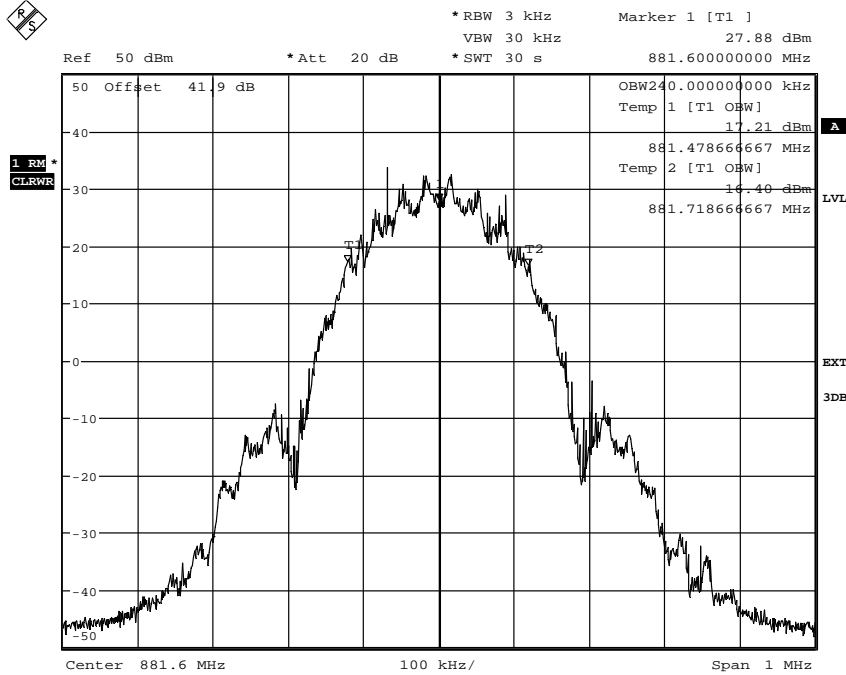


Diagram 1



Date: 20.MAY.2010 13:03:41

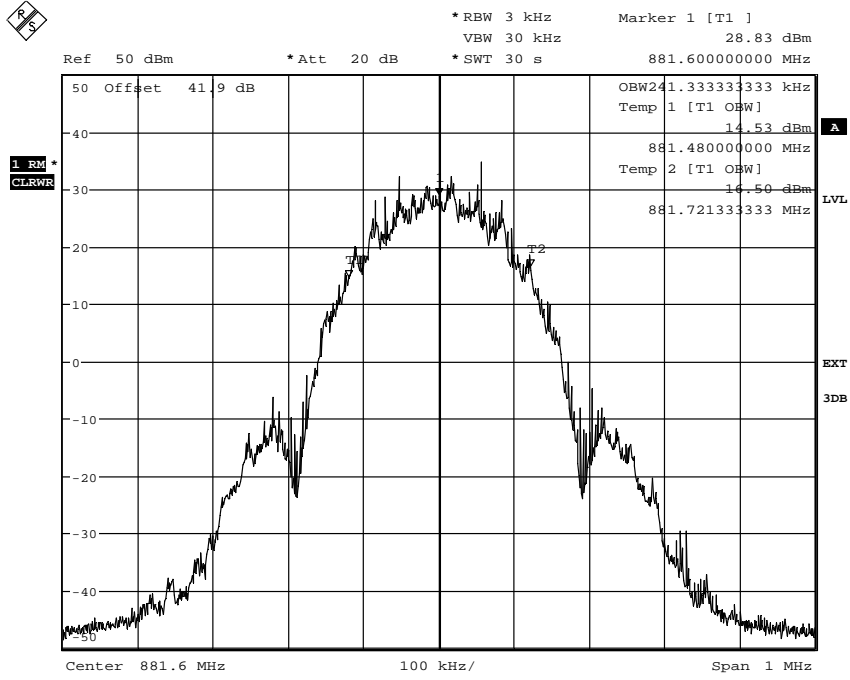
Diagram 2



Date: 20.MAY.2010 13:17:19



Diagram 3



Date: 20.MAY.2010 13:29:40



**Band edge measurements according to 47CFR 2.1051**

Date 2010-05-20	Temperature 22 °C ± 3 °C	Humidity 60 % ± 5 %
--------------------	-----------------------------	------------------------

**Test set-up and procedure**

The measurements were made per definition in §22.917, with the CDU-G 8 output connector connected to a spectrum analyzer with the RMS detector activated. The spectrum analyzer was connected to an external 10 MHz reference standard during the measurements.

FCC rules specify a RBW of 100 KHz for measurements of emissions >1 MHz away from the band edges. For the measurement close to the band edges a resolution bandwidth of 3 kHz was used. The limit line was adapted to the reduced RBW by -15.2 dB (10\*log(3/100)) to -28.2 dBm for frequencies >1 MHz away from the band edges.

Measurement equipment	SP number
Rohde & Schwarz FSQ40	504 143
Attenuator	504 159
Testo 615 temperature and humidity meter	503 498

**Measurement uncertainty:** 3.7 dB

**Results**

The results are shown in appendix 4.1

Configuration: Uncombined (UC) mode, RBS master 2E setting 39

- Diagram 1 16QAM, ARFCN 128 (869.2 MHz)
- Diagram 2 16QAM, ARFCN 251 (893.8 MHz)
- Diagram 3 32QAM, ARFCN 128 (869.2 MHz)
- Diagram 4 32QAM, ARFCN 251 (893.8 MHz)

Configuration: TCC mode, RBS master 2E setting 51

- Diagram 5 16QAM, ARFCN 129 (869.4 MHz)
- Diagram 6 16QAM, ARFCN 250 (893.6 MHz)
- Diagram 7 32QAM, ARFCN 129 (869.4 MHz)
- Diagram 8 32QAM, ARFCN 250 (893.6 MHz)

**Remark**

The maximum output power that can be used on the channels adjacent to the frequency band edges (channel 128 and 251) with CDU-G 8 is with the RBS master 2E control software configured with a value of 39, resulting in a maximum measured RMS output power of 38.3 dBm for 16QAM and 37.8 dBm for 32QAM modulation.

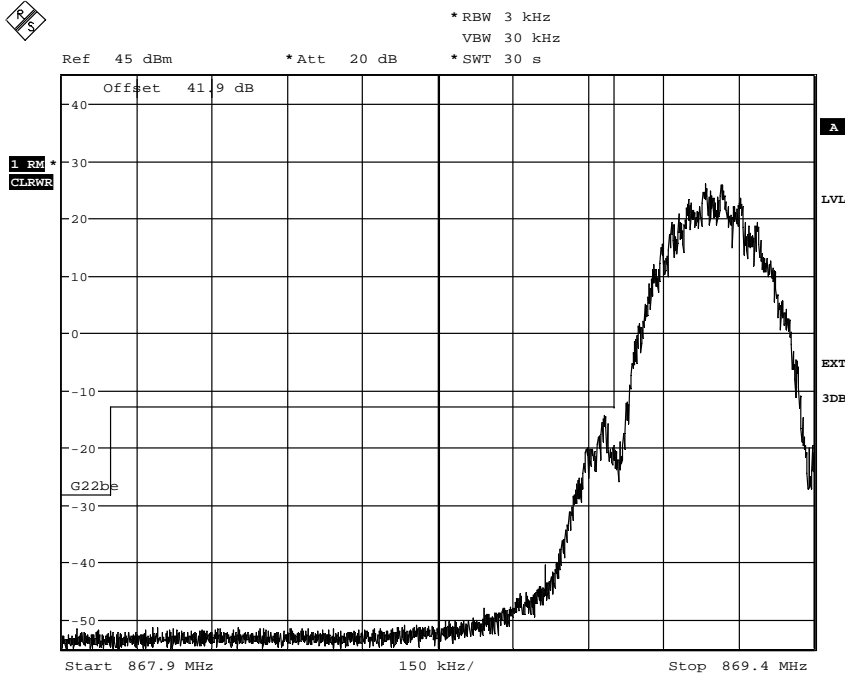
**Limits**

The power of any emission outside the frequency band shall be attenuated below the transmitter power (P) by at least 43 + 10 log P dB.

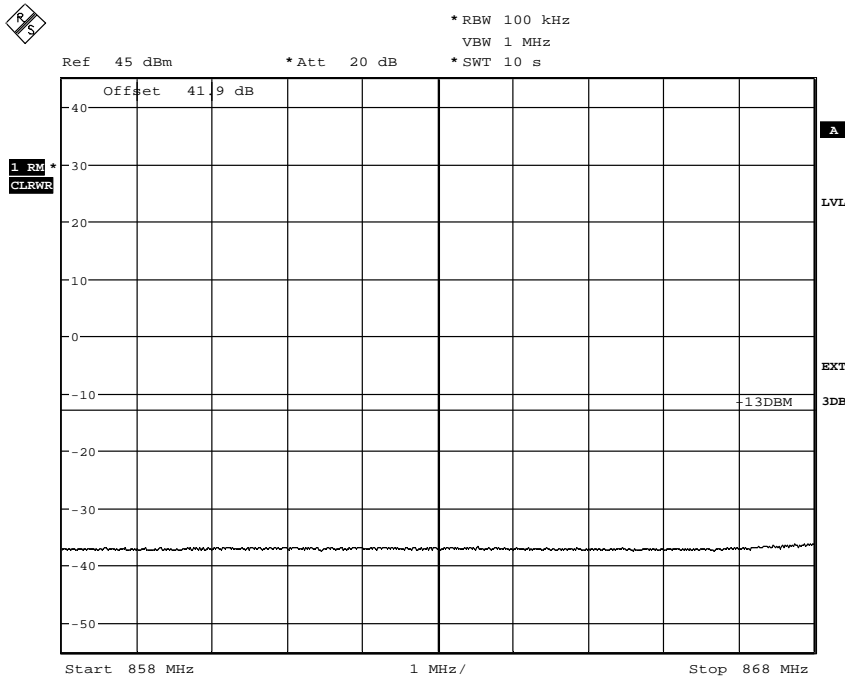
Complies?	Yes
-----------	-----



Diagram 1



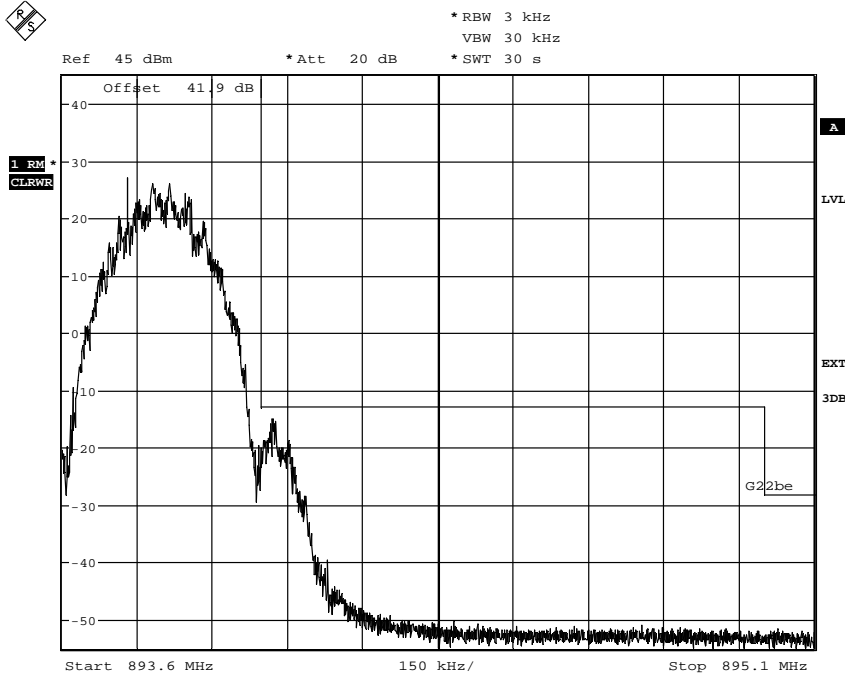
Date: 20.MAY.2010 14:06:05



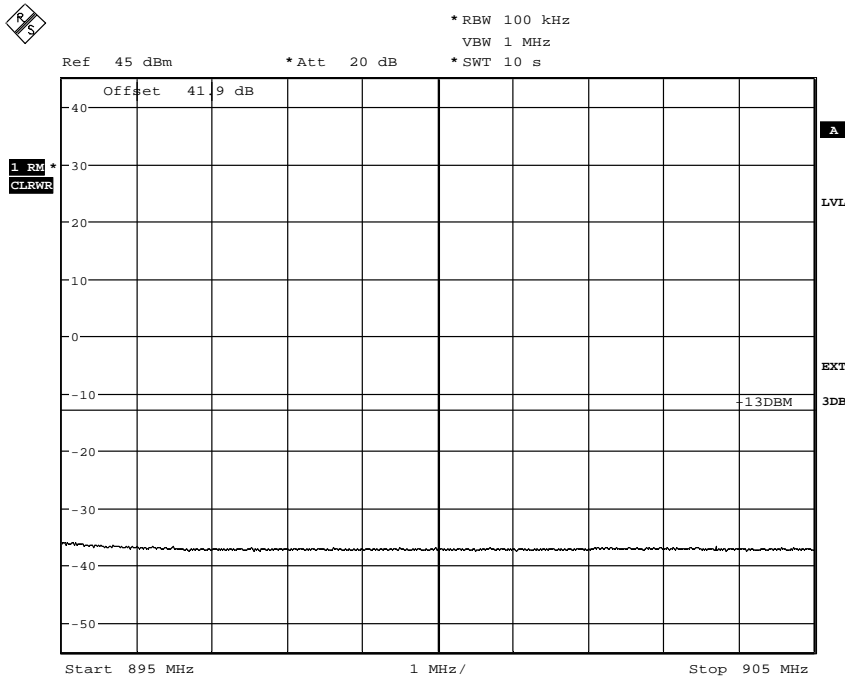
Date: 20.MAY.2010 14:09:03



Diagram 2



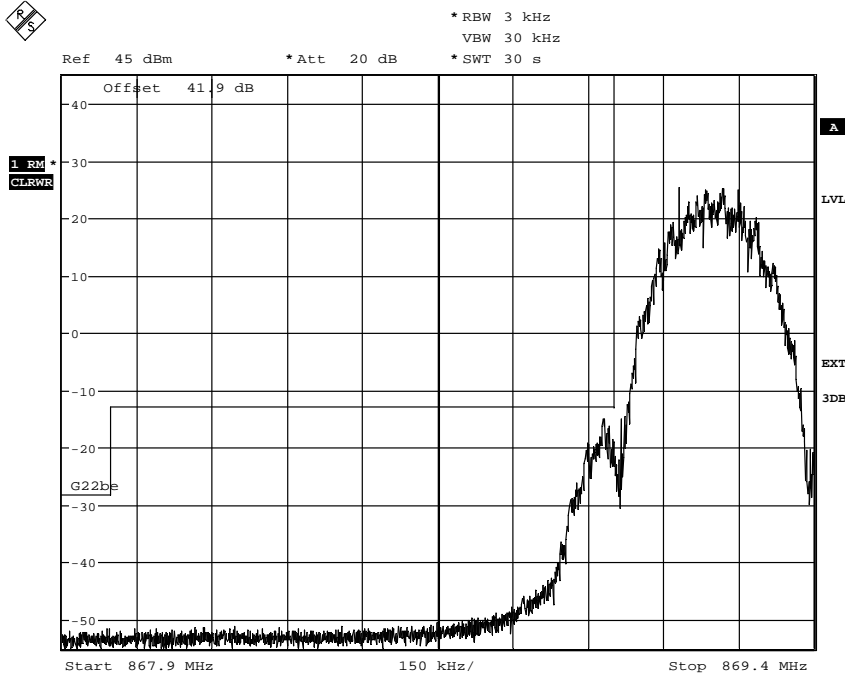
Date: 20.MAY.2010 14:33:19



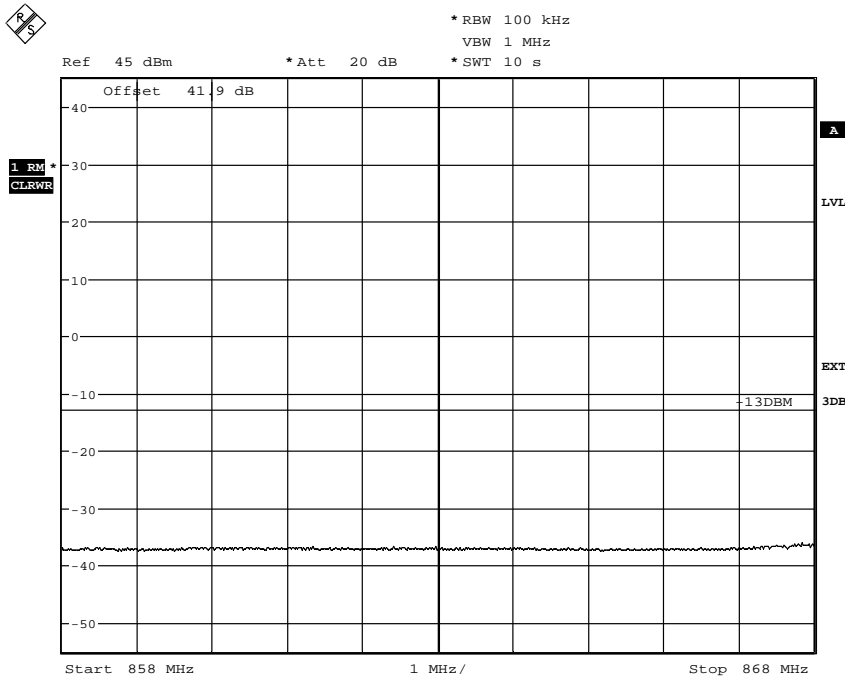
Date: 20.MAY.2010 14:34:48



Diagram 3



Date: 20.MAY.2010 14:11:37

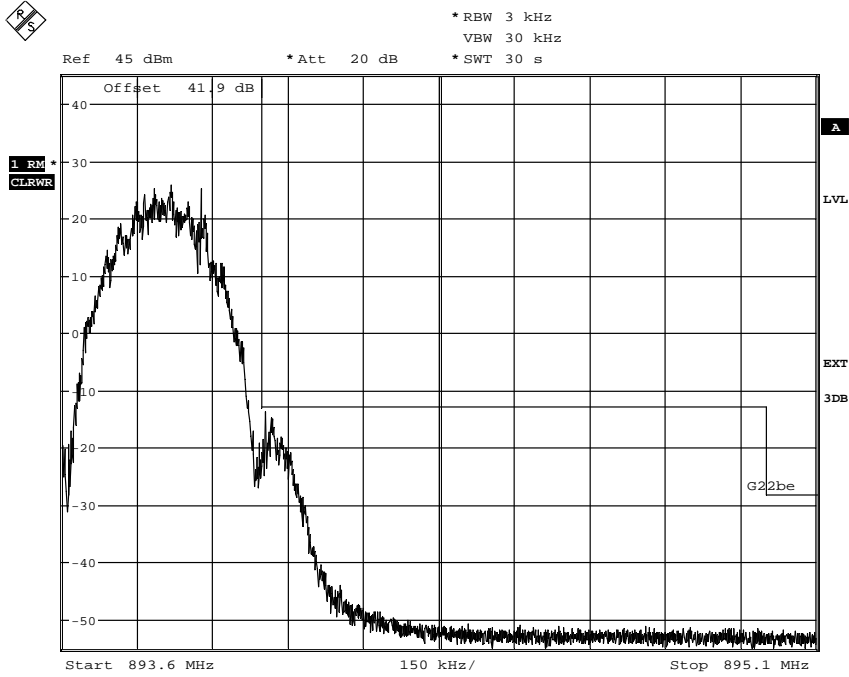


Date: 20.MAY.2010 14:12:45

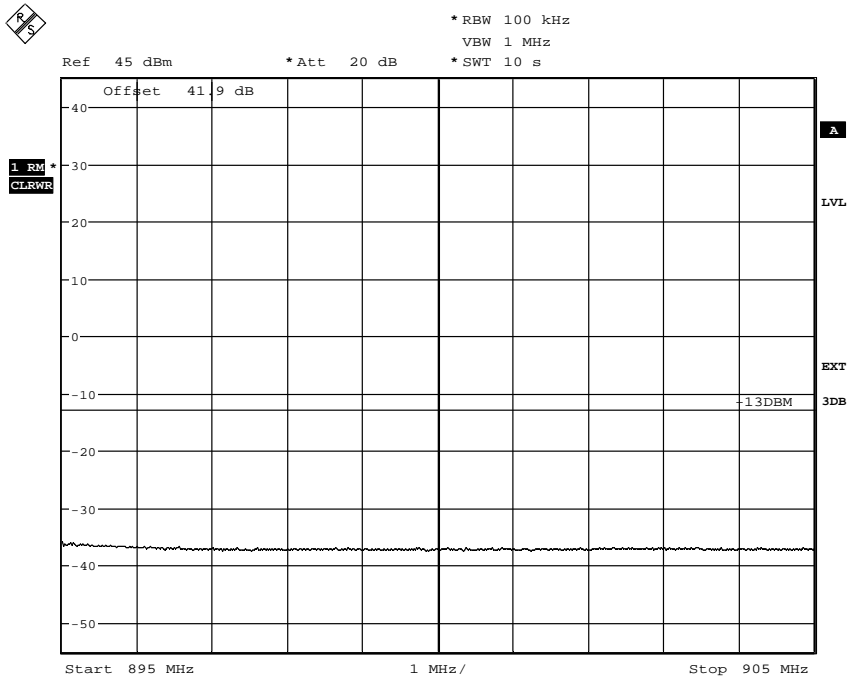




Diagram 4



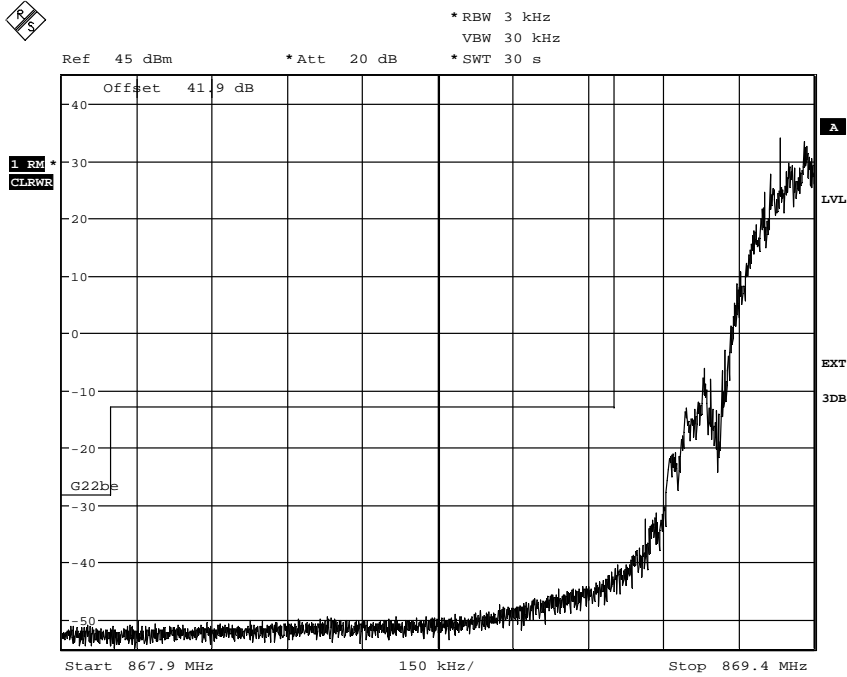
Date: 20.MAY.2010 14:38:36



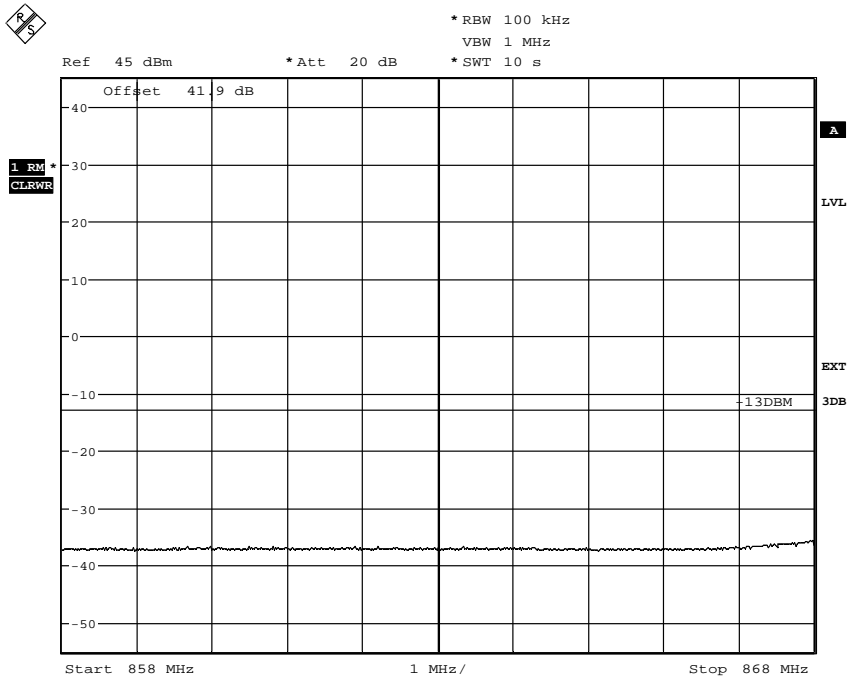
Date: 20.MAY.2010 14:41:05



Diagram 5



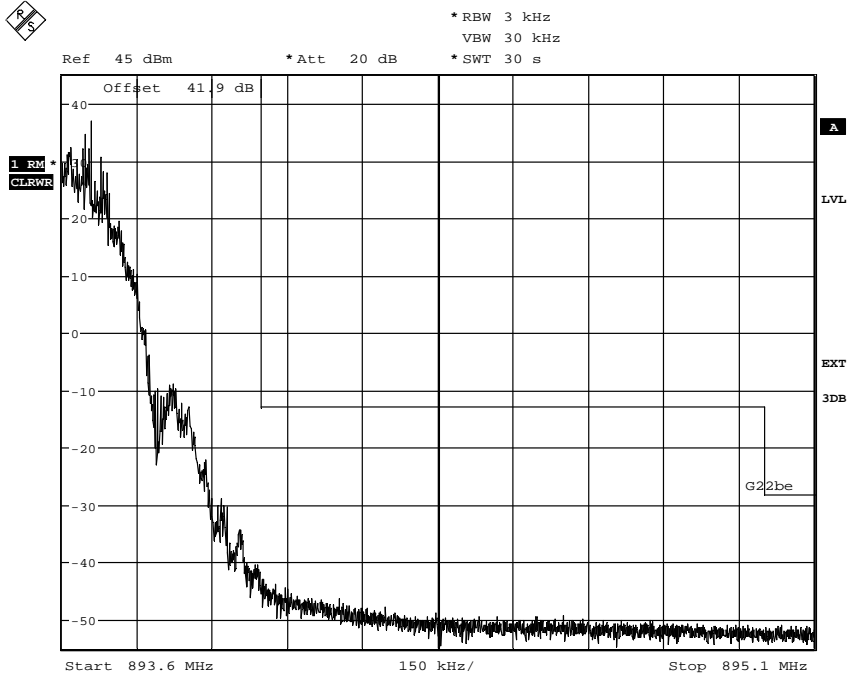
Date: 20.MAY.2010 13:39:06



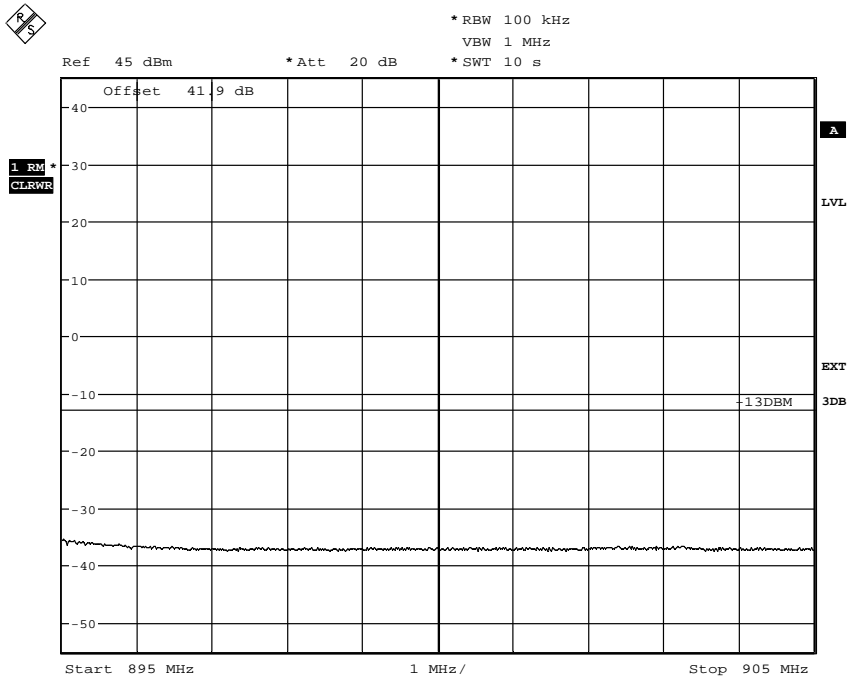
Date: 20.MAY.2010 13:40:06



Diagram 6



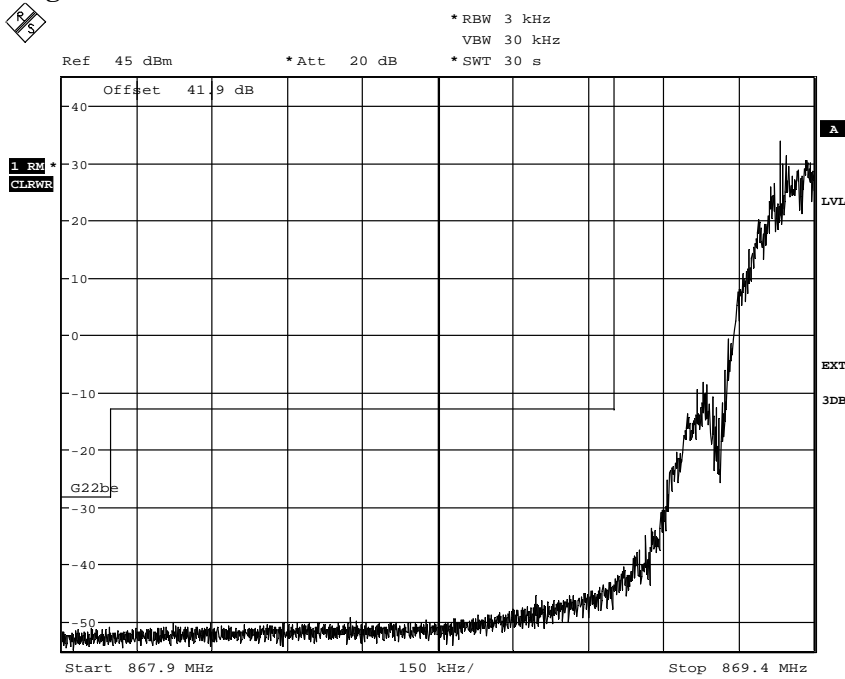
Date: 20.MAY.2010 13:47:42



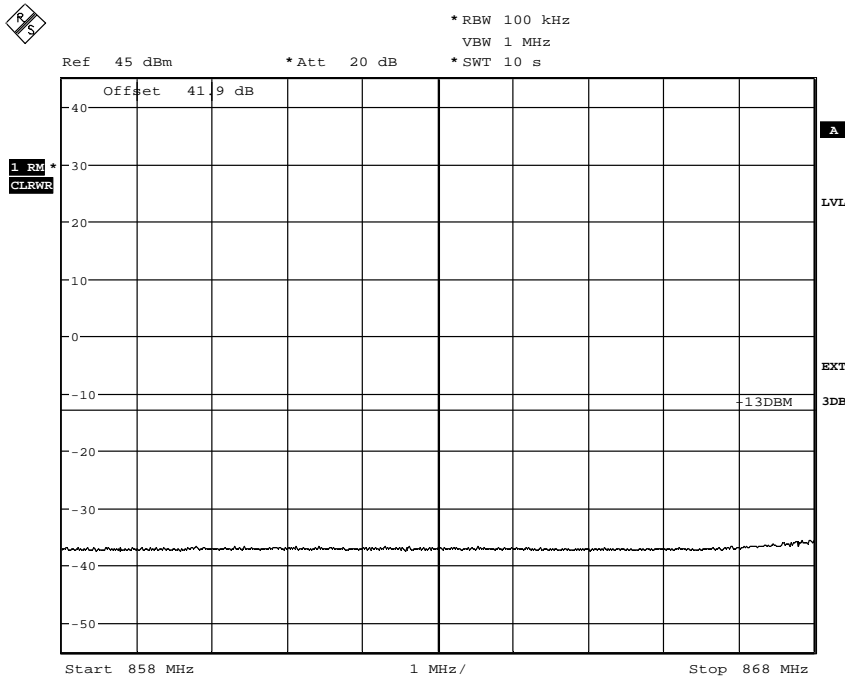
Date: 20.MAY.2010 13:48:36



Diagram 7



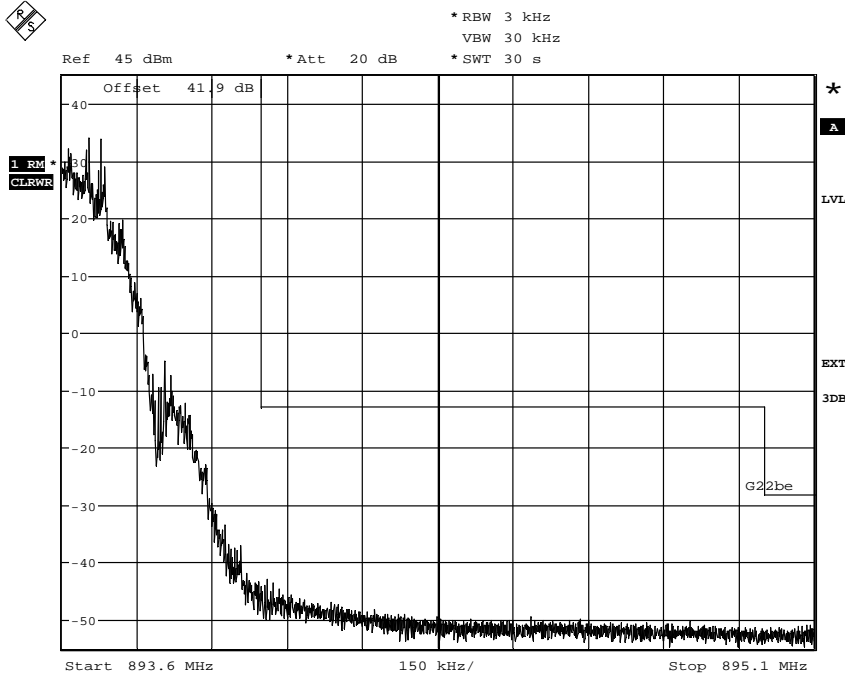
Date: 20.MAY.2010 13:43:45



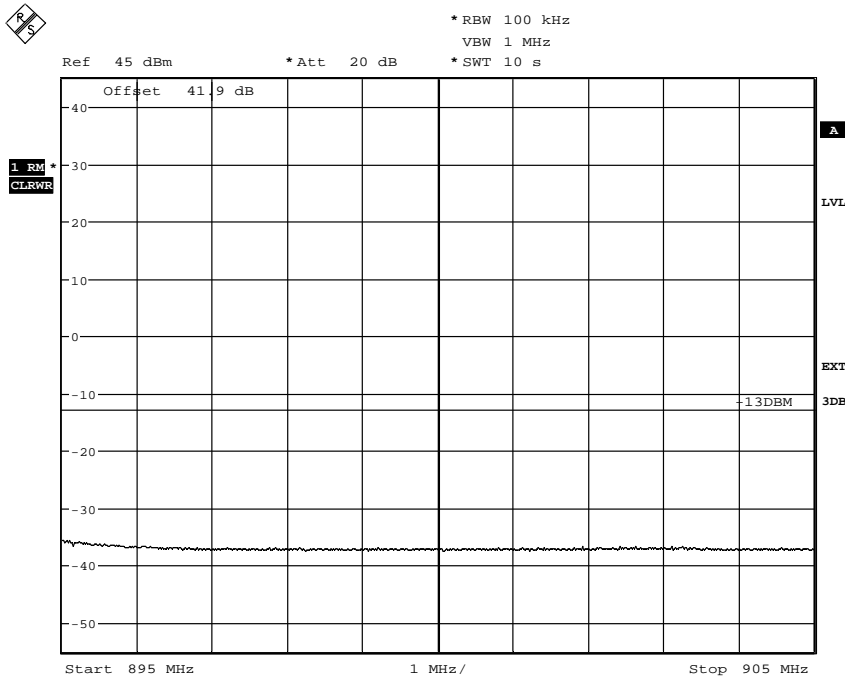
Date: 20.MAY.2010 13:44:37



**Diagram 8**



Date: 20.MAY.2010 13:51:47



Date: 20.MAY.2010 13:52:46



**Conducted spurious emission measurements according to 47CFR 2.1051**

Date 2010-05-20	Temperature 22 °C ± 3 °C	Humidity 60 % ± 5 %
--------------------	-----------------------------	------------------------

**Test set-up and procedure**

The measurements were made at the CDU-G 8 output connector. The output was connected to a spectrum analyser. A pre-measurement was performed with the PEAK detector activated. Emission above the limit with the PEAK detector is measured with the RMS detector activated. The spectrum analyser was connected to an external 10 MHz reference standard during the measurements.

Measurement equipment	SP number
Rohde &Schwarz FSQ40	504 143
Attenuator	504 159
Wainright high pass filter	504 199
Testo 615 temperature and humidity meter	503 498

**Measurement uncertainty:** 3.7 dB

**Results**

The results are shown in appendix 5.1

Configuration: TCC mode, RBS master 2E setting 51, TX ARFCN 190 (881.6 MHz)

Diagram 1: GMSK, 9 KHz – 1 GHz

Diagram 2: GMSK, 1 GHz – 10 GHz

Diagram 3: 16QAM, 9 KHz – 1 GHz

Diagram 4: 16QAM, 1 GHz – 10 GHz

Diagram 5: 32QAM, 9 KHz – 1 GHz

Diagram 6: 32QAM, 1 GHz – 10 GHz

**Remarks**

The emission at 9 kHz on some plots was not generated by the test object. A complementary measurement with a smaller RBW showed that it was related to the LO feed-through.

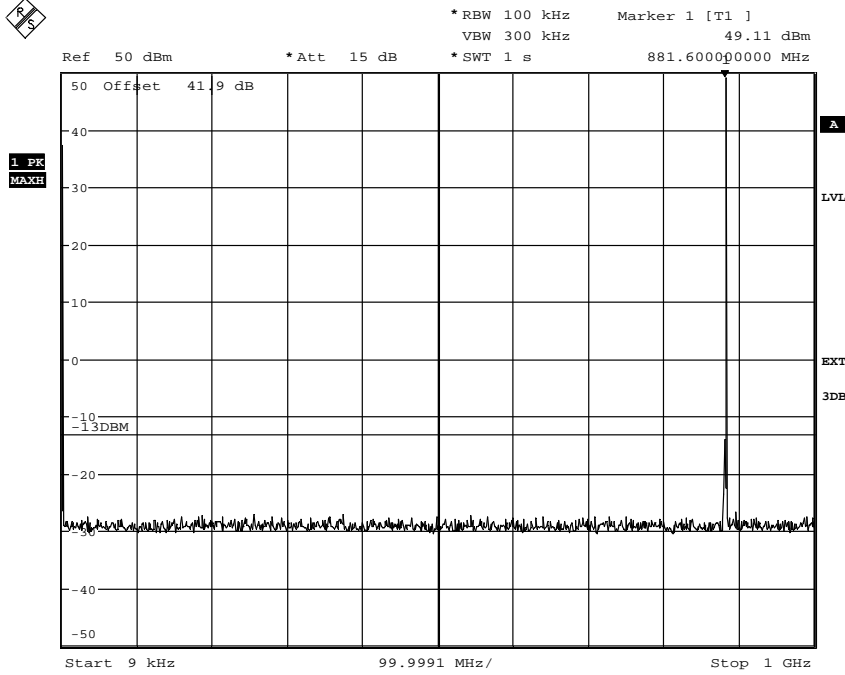
**Limits**

The power of any emission outside the frequency band shall be attenuated below the transmitter power (P) by at least 43 + 10 log P dB.

Complies?	Yes
-----------	-----

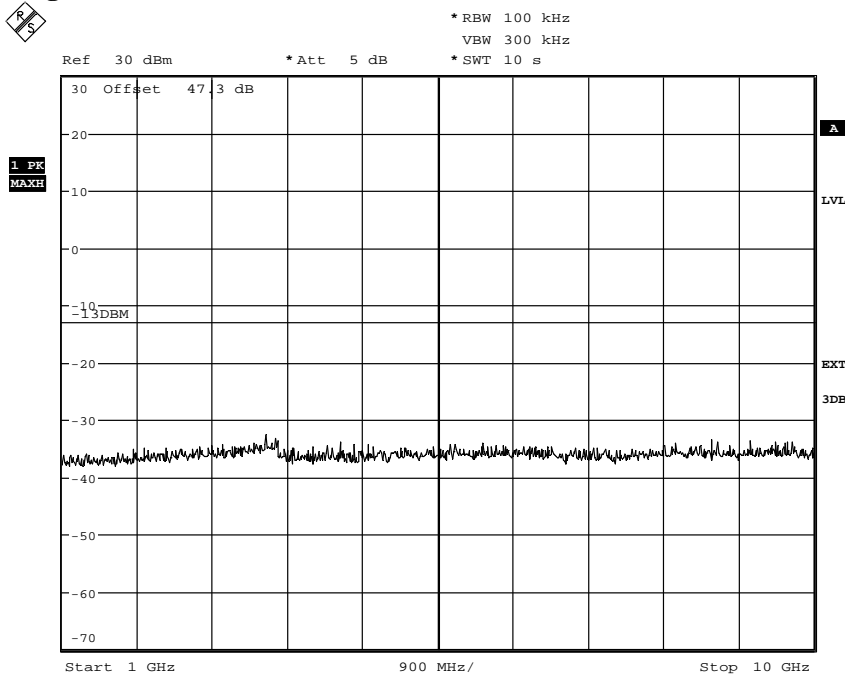


Diagram 1



Date: 20.MAY.2010 13:09:43

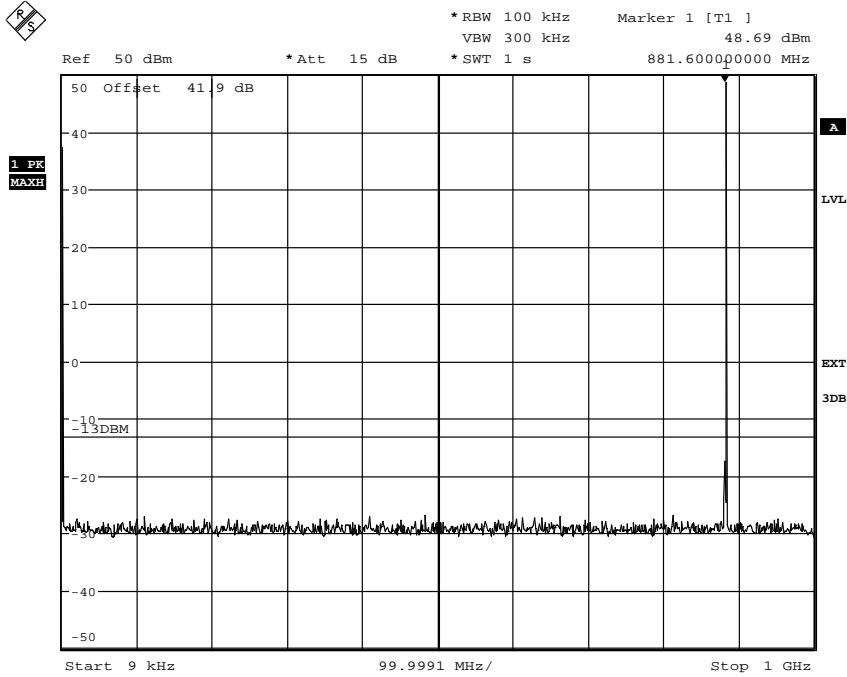
Diagram 2



Date: 20.MAY.2010 13:12:35

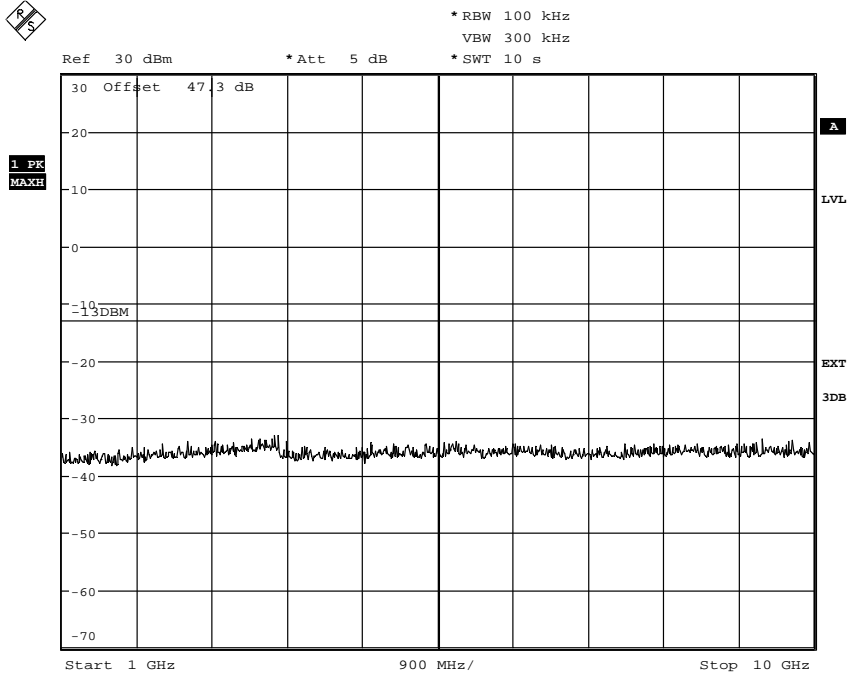


Diagram 3



Date: 20.MAY.2010 13:18:23

Diagram 4

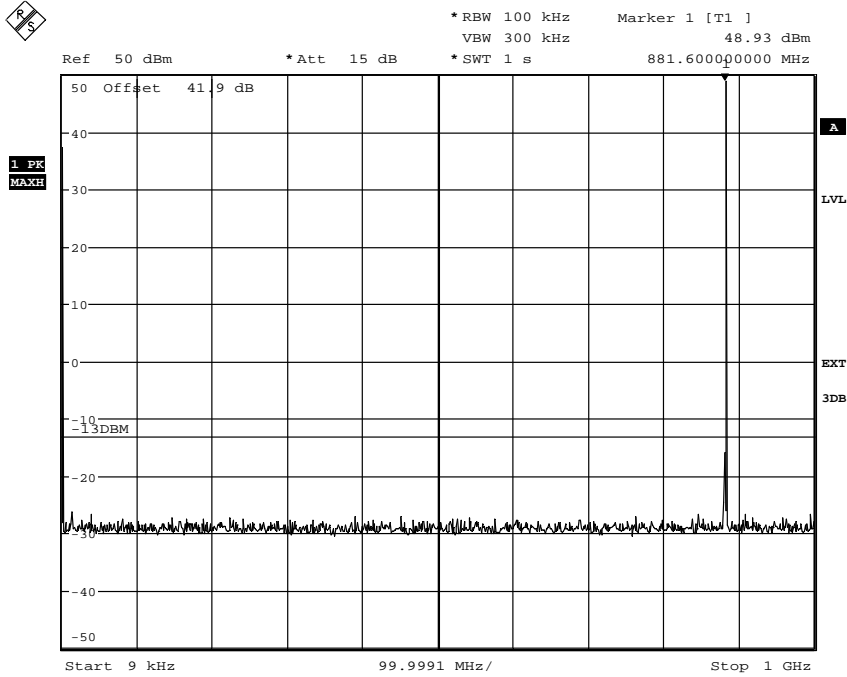


Date: 20.MAY.2010 13:21:09



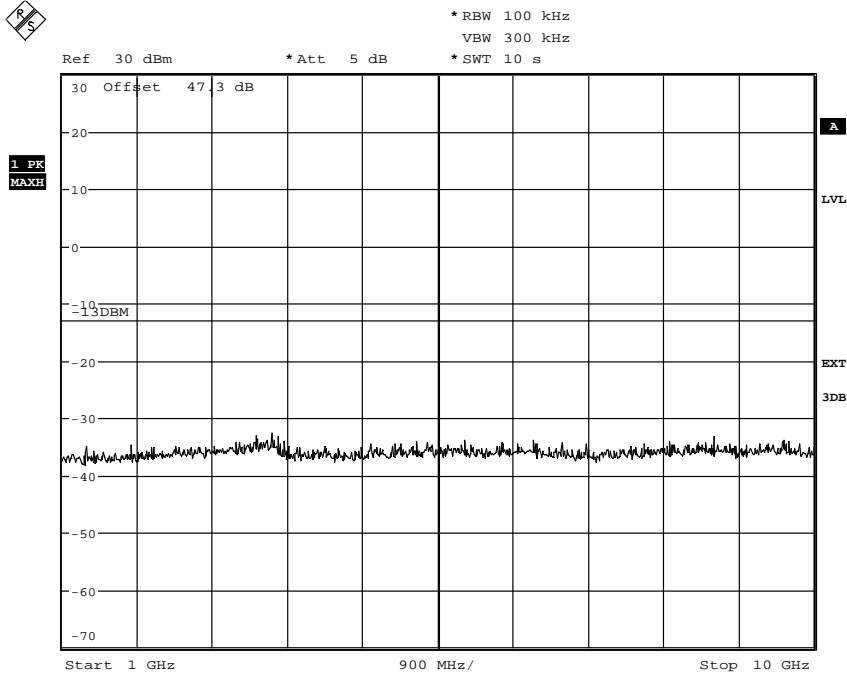


Diagram 5



Date: 20.MAY.2010 13:31:06

Diagram 6



Date: 20.MAY.2010 13:33:09

**Field strength of spurious radiation measurements according to 47CFR 2.1053**

Date 2010-05-27	Temperature 22 °C ± 3 °C	Humidity 28 % ± 5 %
--------------------	-----------------------------	------------------------

**Test set-up and procedure**

The measurements were performed with both horizontal and vertical polarisation of the antenna. The antenna distance was 3 m in the frequency range 30 MHz – 10 GHz. The measurements were performed in Effective Radiated Power (ERP). A fully anechoic chamber was used during the measurements. The chamber is regularly calibrated with the substitution method and from that calibration an ERP correction factor is derived. The correction factor was used as a transducer to get the readings in ERP.

The measurement procedure was as the following:

1. A pre-measurement was first performed with peak detector. The EUT was continuously measured in 360 degrees.
2. Spurious radiation on frequencies closer than 6 dB to the limit was re-measured with RMS detector and with the substitution method according to the standard.

EUT configuration: TCC mode, RBS master 2E setting 51, TX ARFCN 190 (881.6 MHz)

Measurement equipment	SP number
Anechoic chamber, Hertz	15:116
ROHDE & SCHWARZ FSIQ40 Signal Analyser	503 738
ROHDE & SCHWARZ EMI Test Receiver ESI40	503 125
Chase bilog antenna CBL 6121A	502 460
Schaffner Reference Dipole BSRD6500	503 649
EMCO Horn Antenna 3115	502 175
EMCO Horn Antenna 3115	501 548
MITEQ Low Noise Amplifier	503 277
ROHDE & SCHWARZ Vector Network Analyser	503 687
Wainwright high pass filter WHKY1.0/15G-12SS	504 199
Testo 615 temperature and humidity meter	503 498

The test set-up is shown in the picture below:





**Results**

**Modulation GMSK**

Frequency (MHz)	Spurious emission level (dBm)	
	Vertical	Horizontal
30-10 000	All emission > 20 dB below limit	All emission > 20 dB below limit

**Modulation 16QAM**

Frequency (MHz)	Spurious emission level (dBm)	
	Vertical	Horizontal
30-10 000	All emission > 20 dB below limit	All emission > 20 dB below limit

**Modulation 32QAM**

Frequency (MHz)	Spurious emission level (dBm)	
	Vertical	Horizontal
30-10 000	All emission > 20 dB below limit	All emission > 20 dB below limit

**Measurement uncertainty:** 3.2 dB

**Limits**

The power of any emission outside the frequency band shall be attenuated below the transmitter power (P) by at least  $43 + 10 \log P$  dB.

Complies?	Yes
-----------	-----



FCC ID: B5KDKRC1311005-2

Appendix 7

**Hardware list RBS 2206 V2, conducted measurements**

Unit	Product Number	Revision	Serial Number
Cabinet RBS2206 V2	SEB 112 1154/1	R3A	AB20131929
Door	SXK 109 7157/1	R1B	
ACCU-11	BMG 980 07/09	R1C	(S)BH41057584
Subrack	BFL 119 424/1	R2C	-
CDU-G8	BFL 119 155/1	R3A	A40004WCL5
CDU-G8	BFL 119 155/1	R3A	A40004WCLZ
CDU-G8	BFL 119 155/1	R3A	A40004WCL9
Dummy	SXK 107 5031/2	R1B	-
CXU-10	KRY 101 1856/1	R3A	A40003DCGF
Dummy	SXK 107 5031/1	R1B	-
TRU shelf	BFL 119 425/1	R1C	-
Backplane	BFX 101 107/3	R1B	-
Empty slot	-	-	-
Empty slot	-	-	-
dTRU-8	KRC 131 1005/2	R4A	AE53038594
Empty slot	-	-	-
Empty slot	-	-	-
Empty slot	-	-	-
IDM-11	BMG 980 327/2	R1C	X181204836
PSU-shelf	BFL 119 453/1	R1A	(S)BK41073469
Backplane	BFX 101 109/3	R1B	-
PSU-AC-32	BML 353 206/2	R1C	(S)BR8029553
PSU-AC-32	BML 353 206/2	R1C	(S)BR80299544
PSU-AC-32	BML 353 206/2	R1C	(S)BR80397740
Dummy	SXK 107 9314/1	R1C	-
Cover plate	-	-	-
(Empty gap)	-	-	-
DXU-23	BOE 602 21/1	R1B	AE53415783



FCC ID: B5KDKRC1311005-2

Appendix 7

**Hardware list RBS 2206 V2, radiated measurements**

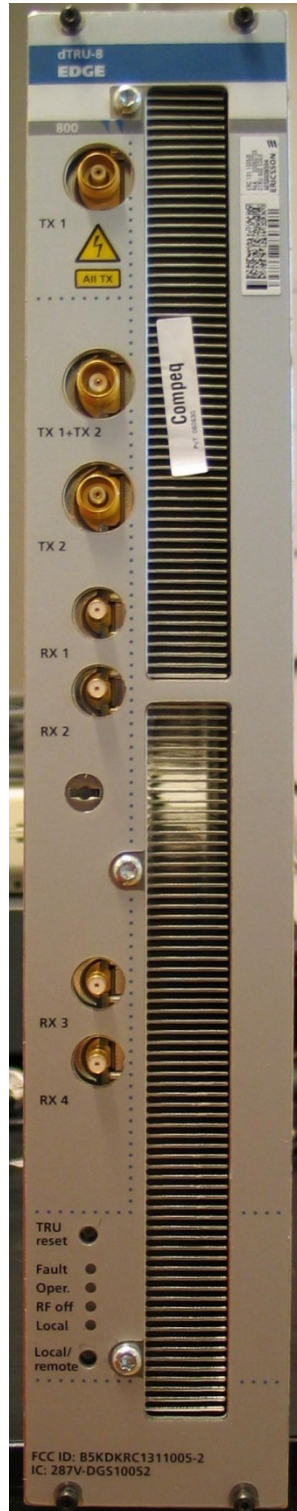
Unit	Product Number	Revision	Serial Number
Cabinet RBS2206 V2	SEB 112 1154/1	R3A	AB20131929
Door	SXK 109 7157/1	R1B	
ACCU-11	BMG 980 07/09	R1C	(S)BH41057584
Subrack	BFL 119 424/1	R2C	-
CDU-G8	BFL 119 155/1	R3A	A40004WCL5
CDU-G8	BFL 119 155/1	R3A	A40004WCLZ
CDU-G8	BFL 119 155/1	R3A	A40004WCL9
Dummy	SXK 107 5031/2	R1B	-
CXU-10	KRY 101 1856/1	R3A	A40003DCGF
Dummy	SXK 107 5031/1	R1B	-
TRU shelf	BFL 119 425/1	R1C	-
Backplane	BFX 101 107/3	R1B	-
Empty slot	-	-	-
Empty slot	-	-	-
dTRU-8	KRC 131 1005/2	R4A	AE53038594
Empty slot	-	-	-
Empty slot	-	-	-
Empty slot	-	-	-
IDM-11	BMG 980 327/2	R1C	X181204836
PSU-shelf	BFL 119 453/1	R1A	(S)BK41073469
Backplane	BFX 101 109/3	R1B	-
Empty slot			
Empty slot			
PSU-AC-32	BML 353 206/2	R1C	(S)BR80299544
Dummy	SXK 107 9314/1	R1C	-
Cover plate	-	-	-
(Empty gap)	-	-	-
DXU-23	BOE 602 21/1	R1B	AE53415783

**Test object software during both radiated and conducted measurements**

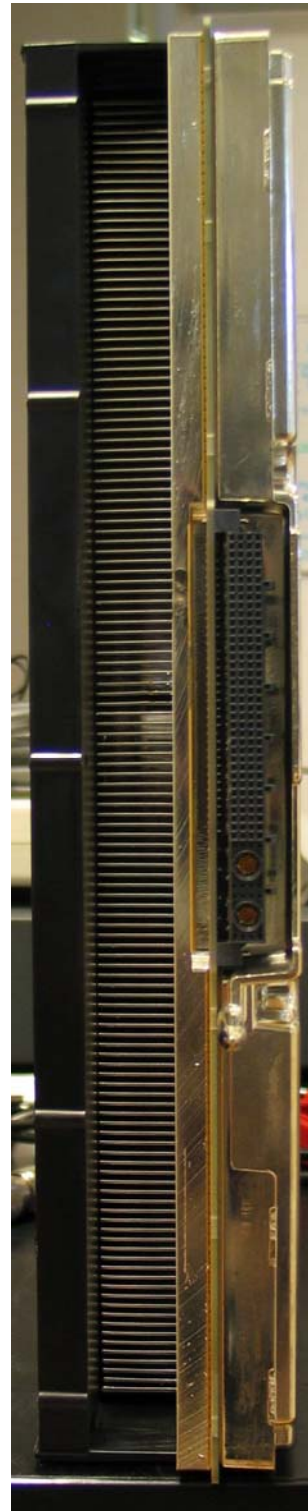
Software	Revision
CXP 104 0007/05	G11B

**Photos of the test object**

Front side



Rear side





Left side



Right side

