



REPORT

issued by an Accredited Testing Laboratory, FCC listed with Reg. no. 93866 and IC recognized pursuant IC file no. 3482A.

Contact person
Reinhold Reul
Electronics
+46 10 516 55 84
Reinhold.Reul@sp.se

Date
2012-02-29

Reference
FX108941-4 Rev 1

Page
1 (2)



Ericsson (China) Communications Company Ltd
Att. Hua Yang
Ericsson Tower
No. 5 Lize East Street
Chaoyang District, Beijing 100102
P. R. China

Class II Permissive Change measurements on GSM Base station Transceiver Unit with FCC ID: B5KCKRC1311005-2

(8 appendices)

Revision 1 uses updated client information in appendix 1 regarding the declared nominal output power.

Test object

Transceiver Unit dTRU-8, product KRC 131 1005/2, revision R3A

Summary

Standard	Compliant	Appendix	Remarks
FCC CFR 47			
2.1046 RF Power output	Yes	2	-
2.1049 Occupied bandwidth	Yes	3	-
2.1051 Band Edge	Yes	4	-
2.1051 Spurious emission at antenna port	Yes	5	-
2.1053 Field strength of spurious radiation	Yes	6	-

SP Technical Research Institute of Sweden Electronics - EMC

Performed by

Reinhold Reul

Examined by

Christer Karlsson

SP Technical Research Institute of Sweden

Postal address

SP
Box 857
SE-501 15 BORÅS
Sweden

Office location

Västerås
Brinellgatan 4
SE-504 62 BORÅS
Sweden

Phone / Fax / E-mail

+46 10 516 50 00
+46 33 13 55 02
info@sp.se

Laboratories are accredited by the Swedish Board for Accreditation and Conformity Assessment (SWEDAC) under the terms of Swedish legislation. This report may not be reproduced other than in full, except with the prior written approval of the issuing laboratory. This document may not be reproduced other than in full, except with the prior written approval of SP.



Table of contents

Description of the test object	Appendix 1
Operation mode during measurements	Appendix 1
Purpose of test	Appendix 1
Test setups	Appendix 1
RF power output	Appendix 2
Occupied bandwidth	Appendix 3
Band edge	Appendix 4
Spurious emission at antenna terminals	Appendix 5
Field strength of spurious radiation	Appendix 6
Hardware list and software	Appendix 7
Photos of the test object	Appendix 8

Appendix 1

Description - Equipment Under Test (EUT)

Equipment: GSM Base station transceiver unit (dTRU) 850 MHz

TX frequency band: 869 – 894 MHz

Modulations: GMSK, 8PSK, 16QAM, 32QAM, AQPSK

Declared maximum output power, RMS value in [dBm]	Modulations				
	GMSK	8PSK	16QAM	32QAM	AQPSK
Hybrid combined (HC) mode	43.7	40.4	39.0	38.6	40.3
Uncombined (UC) mode	47.0	43.7	42.3	41.9	43.6
TCC mode	50.0	46.7	45.3	44.9	46.6

Supply voltage 24 V DC

Purpose of test

The purpose of this test is to justify a Class II Permissive Change of the test object to include the use of AQPSK modulation with SCPIR 0 dB. This report verifies maintained performance characteristics of affected items according FCC CFR47 by re-testing the updated equipment and comparing results for AQPSK modulation using SCPIR 0 dB with GMSK reference modulation. For band-edge performance the acceptable settings for the new implemented AQPSK modulation were determined.

Summary of results

Measurement results are similar for all tested modulations, apart from output power, where GMSK modulation results in the highest RMS output power, and for band-edge performance, where restrictions apply as described in appendix 4. Where several modulations were compared, GMSK modulation shall be considered a worst case set-up.

Tested configuration

All measurements were performed with the test object installed in a RBS 2206 V2 cabinet. The hardware list for radiated and conducted measurements is shown in appendix 7. Unless noted otherwise the test object was activated at maximum power, configured for TCC mode with RBS master 2E setting 51, resulting in the highest achievable output power. For band-edge performance verification UC and TCC configurations were used as described in appendix 4. In all used configurations random data was transmitted by the activated TX in all time slots with the various tested modulations being activated one at a time.

Appendix 1

Conducted measurements

Conducted measurements were done at the output TX/RX 1 of the CDU-G8.

Radiated measurements

During radiated emission measurements the TX/RX 1 output of CDU-G8 was via a 50 ohm attenuator connected to a spectrum analyser to monitor the transmitted signal level. For the scope of this test it was deemed sufficient to measure radiated spurious emission at the TX band centre frequency for GMSK modulation as worst case reference modulation with the highest RMS power and compare it with results for the AQPSK modulation with SCPIR 0 dB.

Test frequencies used

Channel	ARFCN	Frequency	Comment
B	128	869.2 MHz	TX frequency adjacent to lower frequency band edge
B+1	129	869.4 MHz	TX low alternate frequency, 1 channel inside band
M	190	881.6 MHz	TX band centre frequency
T-1	250	893.6 MHz	TX high alternate frequency, 1 channel inside band
T	251	893.8 MHz	TX frequency adjacent to higher frequency band edge

Manufacturer's representative

Hua Yang, Ericsson (China) Communications Company Ltd

References

Measurements were done according to relevant parts of the following standards:

ANSI C63.4-2009
ANSI/TIA/EIA-603-C-2004
ANSI/TIA/EIA 136-280-D-2002
CFR 47 part 2, October 1st, 2010
CFR 47 part 22, October 1st, 2010

Reservation

The test results in this report apply only to the particular Equipment Under Test (EUT) as declared in the report.

Delivery of test object

The test object was delivered on 23rd May 2011.

Appendix 1

Test equipment

Measurement equipment	Calibration Due	SP number
Anechoic chamber, Hertz	2013-10	15:116
Boonton 4500A RF Peak power meter/analyser	2012-11	503 144
Boonton Power sensor 56518-S/4	2012-11	503 146
Rohde & Schwarz FSIQ40	2012-07	503 738
Rohde & Schwarz ESI40	2012-07	503 125
Rohde & Schwarz Vector Network Analyser	2012-07	503 687
Chase bilog antenna CBL 6121A	2014-10	502 460
Schaffner Reference Dipole BSRD6500	2012-03	502 181
EMCO Horn Antenna 3115	2014-01	502 175
EMCO Horn Antenna 3115	2014-01	501 548
MITEQ Low Noise Amplifier	2012-08	503 277
Flann Std gain horn 20240-20	2014-03	503 674
Attenuator 40 dB	2012-08	504 159
High pass filter	2012-08	504 199
High pass filter	2012-08	502 758
Multimeter Fluke 87	2012-05	502 190
Testo 615 temperature and humidity meter	2012-03	503 498
Testo 635 temperature and humidity meter	2013-05	504 203

Uncertainties

Measurement and test instrument uncertainties are described in the quality assurance documentation "SP-QD 10885". The uncertainties are calculated with a coverage factor $k=2$ (95% level of confidence).

Test engineers

Jörgen Wassholm, Fredrik Isaksson, Martin Nilsson, Martin Forsberg, and Reinhold Reul, SP

Test witness

-

Appendix 1

Test set-up, conducted measurements

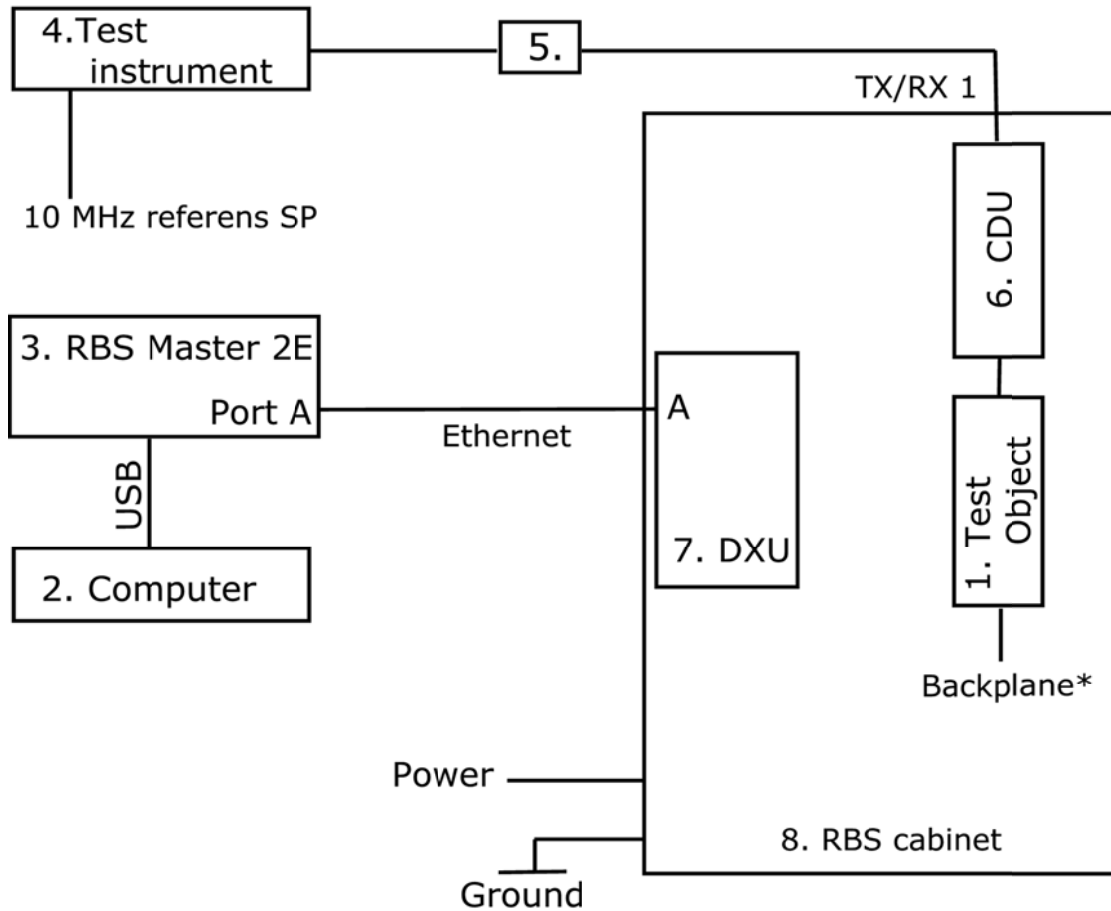

*) Power and data communication via backplane

Test object

1. Transceiver Unit dTRU-8, product KRC 131 1005/2, revision R3A, SN AE51304512 with FCC ID: B5KCKRC1311005-2

Functional test equipment

2. HP laptop computer Compaq nc6000, product PM307ES#AB2, SN CNU51206GT, with RBS Master2 control software
3. Ericsson RBS Master 2E hardware, product LBY 107 1007/3, revision R1C BAMS 1000878365
4. Agilent MXA Signal Analyser model N9020A 20 Hz – 3.6 GHz, BAMS 1000785533, used to verify the modulation schemes
5. Attenuator / filter listed as test equipment in respective appendix
6. CDU-G8, product BFL 119 155/1, revision R3A, serial number A40004WCLV
- 7./8. DXU and remaining RBS cabinet according hardware list in appendix 7

Appendix 1

Test set-up, radiated emission

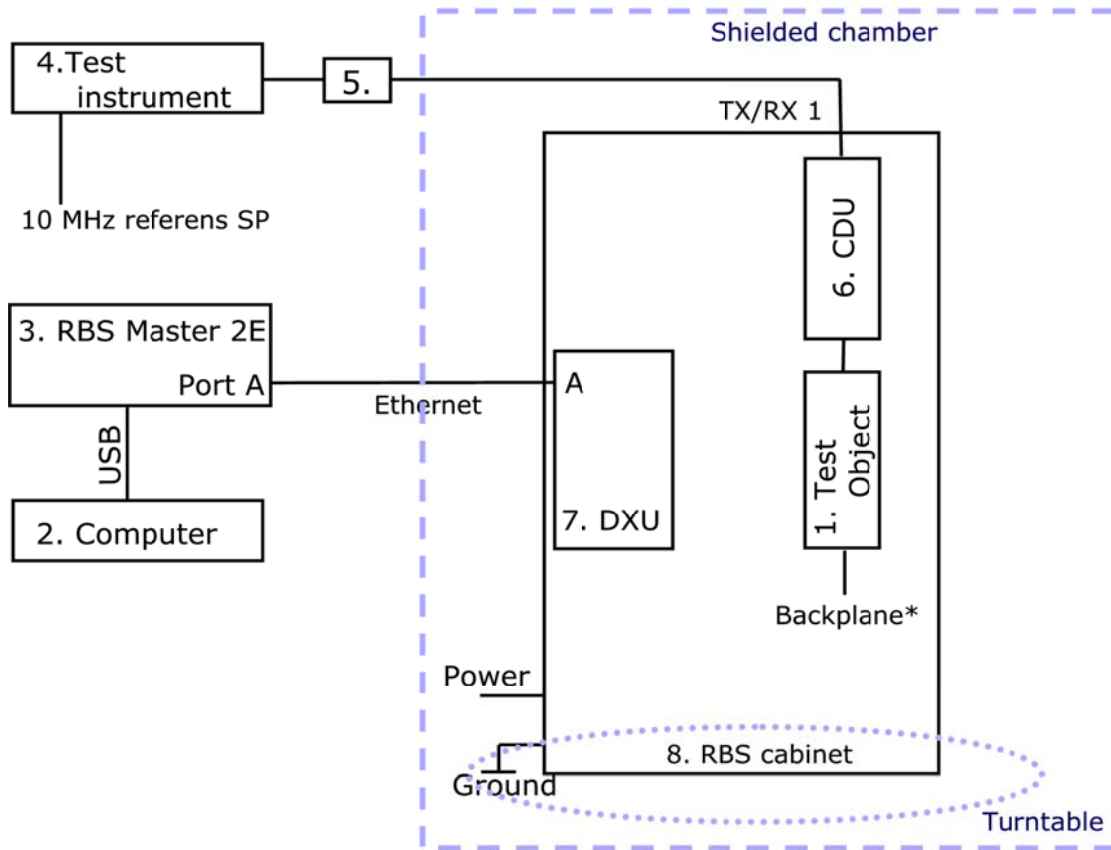

*) Power and data communication via backplane

Test object

1. Transceiver Unit dTRU-8, product KRC 131 1005/2, revision R3A, SN AE51304512 with FCC ID: B5KCKRC1311005-2

Functional test equipment

2. HP laptop computer model Compaq NC6400 SN CND72717JP with RBS Master2 control software
3. Ericsson RBS Master 2E hardware, product LBY 107 1007/3, revision R1C, BAMS 1000735211
4. Rohde & Schwarz FSIQ40 for signal monitoring, SP 503738
5. Attenuator 40 dB, SP 504 159
6. CDU-G8, product BFL 119 155/1, revision R3A, serial number A40004WCLV
- 7./8. DXU and remaining RBS cabinet according hardware list in appendix 7

Appendix 1

Test object connections

Interface

Power via RBS backplane
 TX 1 + TX 2, interconnection to CDU in TCC/HC mode
 Interconnection TX 1 to CDU in UC mode
 Interconnection TX 2 to CDU in UC mode
 RX 1 to CXU10
 RX 2 to CXU10
 RX 3 not connected
 RX 4 not connected

Type of port

DC power
 RF interconnect
 RF interconnect
 RF interconnect
 RF interconnect
 RF interconnect
 RF interconnect
 RF interconnect

RBS cabinet external connections

Interface

External supply 24 V DC
 Active CDU TX/RX 1, used for measurement and monitoring
 Active CDU TX/RX 2 and inactive CDU's outputs unconnected
 Ethernet shielded multi-wire with RJ-45connector to RBS master
 2E, port A, mode E1
 External alarm not connected
 ESB not connected
 GPS not connected
 OMT interface for configuration not connected

Type of port:

DC power
 RF/Antenna
 RF/Antenna
 Telecom
 Signal
 Signal
 Signal
 O/M

Appendix 2

RF Power output measurements according to CFR 47 2.1046

Date 2011-12-06	Temperature 23 °C ± 3 °C	Humidity 27 % ± 5 %
--------------------	-----------------------------	------------------------

Test set-up and procedure

Measurements were made with the CDU output connected to a peak power analyser via a 50 ohm attenuator.

Measurement equipment	SP number
Boonton 4500A RF Peak power meter/analyser	503 144
Boonton Power sensor 56518-S/4	503 146
Attenuator	504 159
Multimeter Fluke 87	502 190
Testo 635 temperature and humidity meter	504 203

Measurement uncertainty: 0.7 dB

Results

Configuration: TCC mode, RBS master 2E setting 51

Transmitter power (dBm)			
Channel	Modulation	Peak	RMS
M	GMSK	49.4	48.7
M	AQPSK	49.4	45.6

The maximum measured PAR was 3.8 dB.

Limit

CFR 47 § 22.913: 500 W ERP shall not be exceeded.

Complies?	Yes
-----------	-----

Appendix 3

Occupied bandwidth measurements according to 47CFR 2.1049

Date	Temperature	Humidity
2011-12-06	23 °C ± 3 °C	27 % ± 5 %

Test set-up and procedure

Measurements were made with the CDU output via an attenuator connected to a spectrum analyser. The spectrum analyser had the RMS detector activated and was connected to an external 10 MHz reference standard during the measurements.

Measurement equipment	SP number
R&S FSIQ	503 738
Attenuator	504 159
Multimeter Fluke 87	502 190
Testo 635 temperature and humidity meter	504 203

Measurement uncertainty: 3.7 dB, 1.33 kHz

Results

Configuration: TCC mode, RBS master 2E setting 51

Diagram	Channel	Modulation	OBW
1	M	GMSK	241 kHz
2	M	AQPSK	238 kHz

The diagrams are shown on the following page.

Appendix 3

Diagram 1:

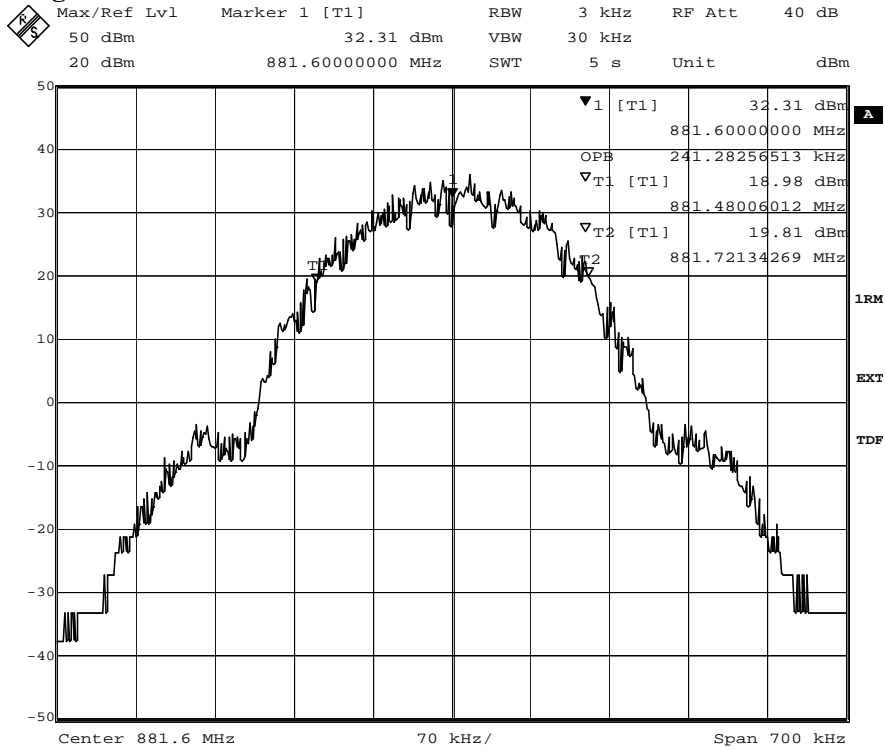

Date: 6.DEC.2011 10:08:32

Diagram 2:

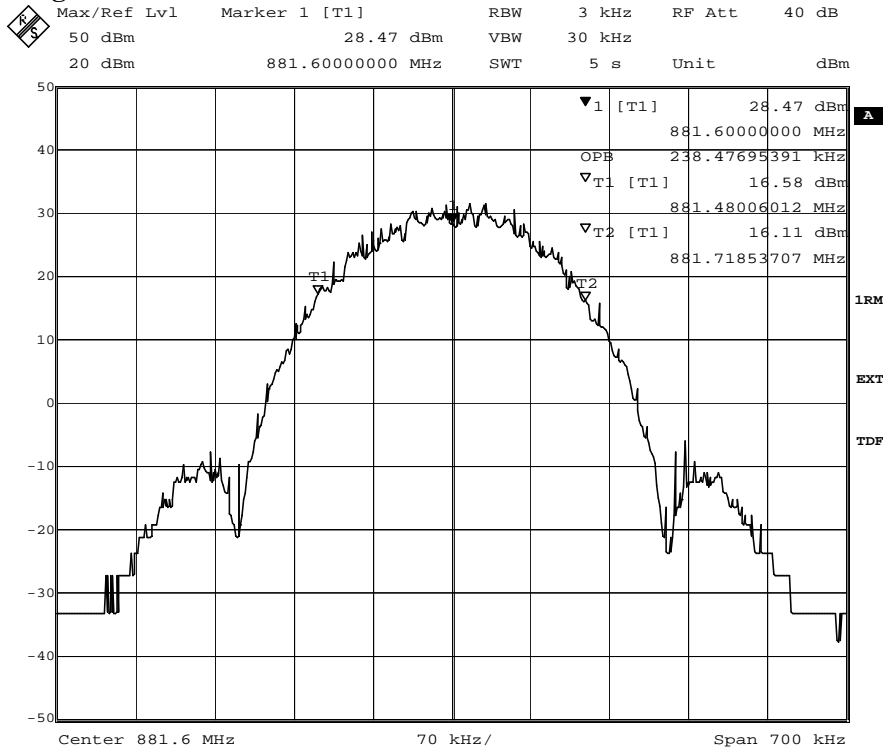

Date: 6.DEC.2011 10:10:40

Appendix 4

Band edge measurements according to 47CFR 2.1051

Date 2011-12-06	Temperature 23 °C ± 3 °C	Humidity 27 % ± 5 %
--------------------	-----------------------------	------------------------

Test set-up and procedure

The measurements were made per definition in §22.917, with the CDU output connected to a spectrum analyzer. The spectrum analyser had the RMS detector activated and was connected to an external 10 MHz reference standard during the measurements.

FCC rules allow a resolution bandwidth of one percent of the emission bandwidth of the fundamental emission within the first 1 MHz off the band edge. FCC rules require a resolution bandwidth of 100 kHz for measurements of emissions for offsets from the band edges exceeding 1 MHz.

Measurement equipment	SP number
R&S FSIQ	503 738
Attenuator	504 159
Multimeter Fluke 87	502 190
Testo 635 temperature and humidity meter	504 203

Measurement uncertainty: 3.7 dB

Results

Diagram	Channel	Combiner configuration	RBS master 2E setting	Measured RMS power / [dBm]
1 a, b, c	B	UC mode	41	39.1
2 a, b, c	T	UC mode	43	42.1
3 a, b, c	B+1	TCC mode	51	45.2
4 a, b, c	T-1	TCC mode	51	45.3

The diagrams are shown on the following pages.

Remark

For channels B and T the above documented RMS powers were found to represent the maximum acceptable RF output power with AQPSK modulation using SCPIR 0 dB to meet band-edge requirements.

Limit

The power of any emission outside the frequency band shall be attenuated below the transmitter power (P) by at least 43 + 10 log P dB.

Complies?	Yes
-----------	-----

Appendix 4

Diagram 1 a:

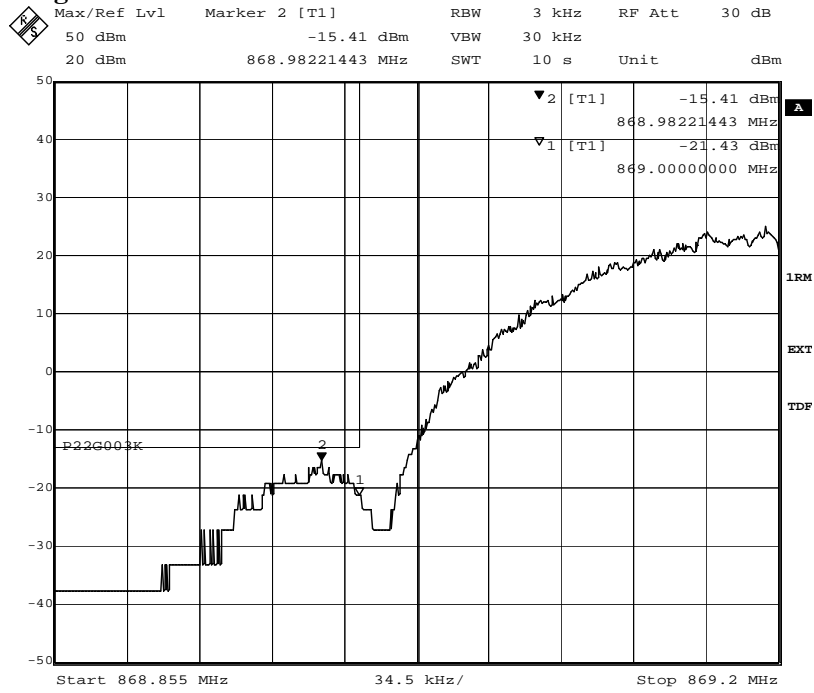

Date: 6.DEC.2011 09:38:20

Diagram 1 b:

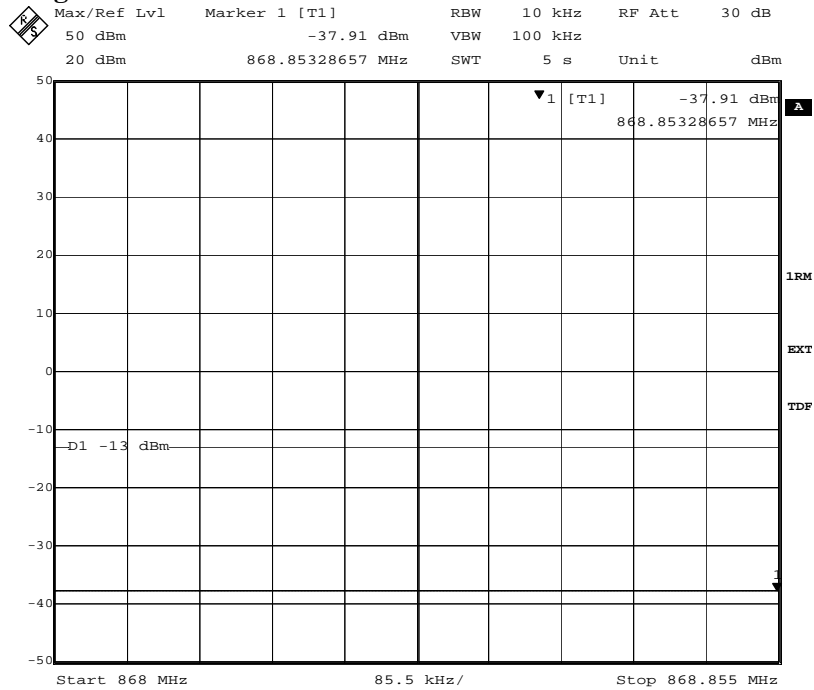

Date: 6.DEC.2011 09:37:35



Appendix 4

Diagram 1 c:

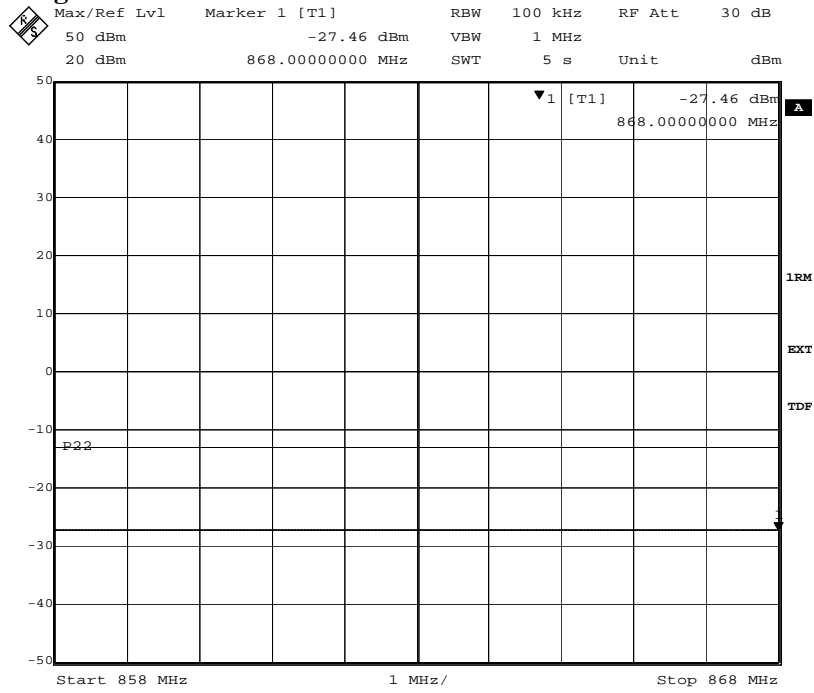

Appendix 4

Diagram 2 a:

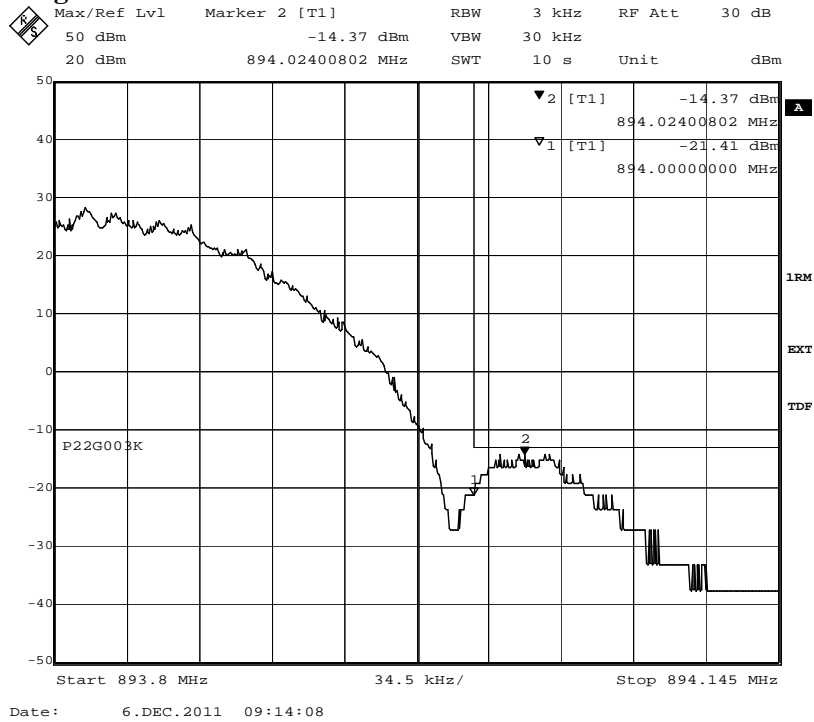
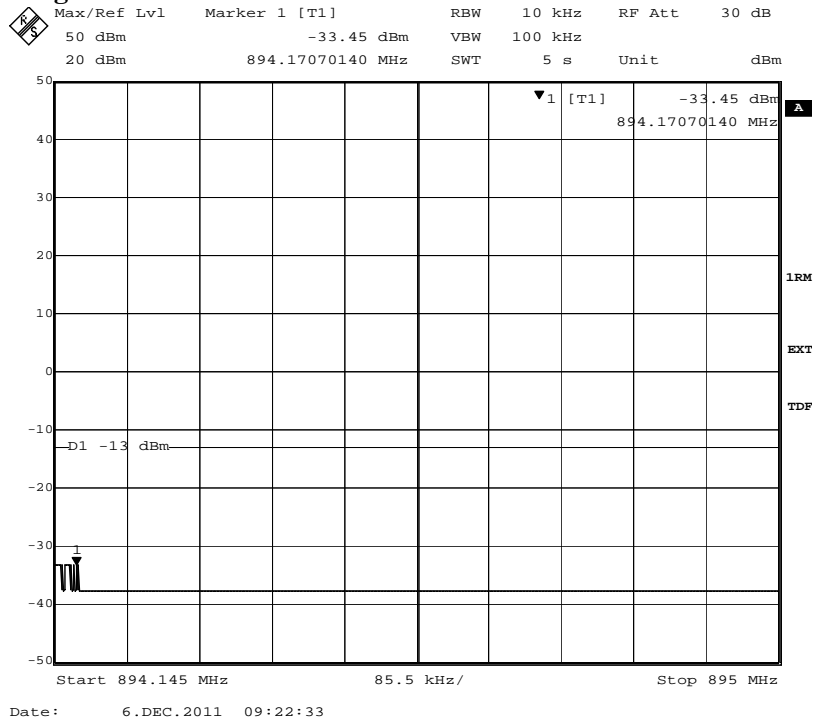

Diagram 2 b:





Appendix 4

Diagram 2 c:

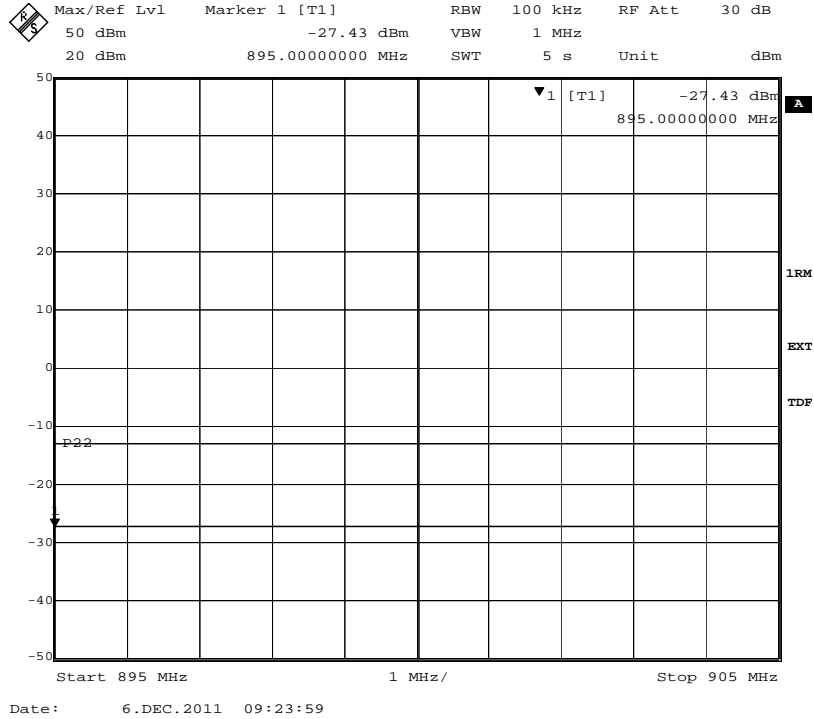

Appendix 4

Diagram 3 a:

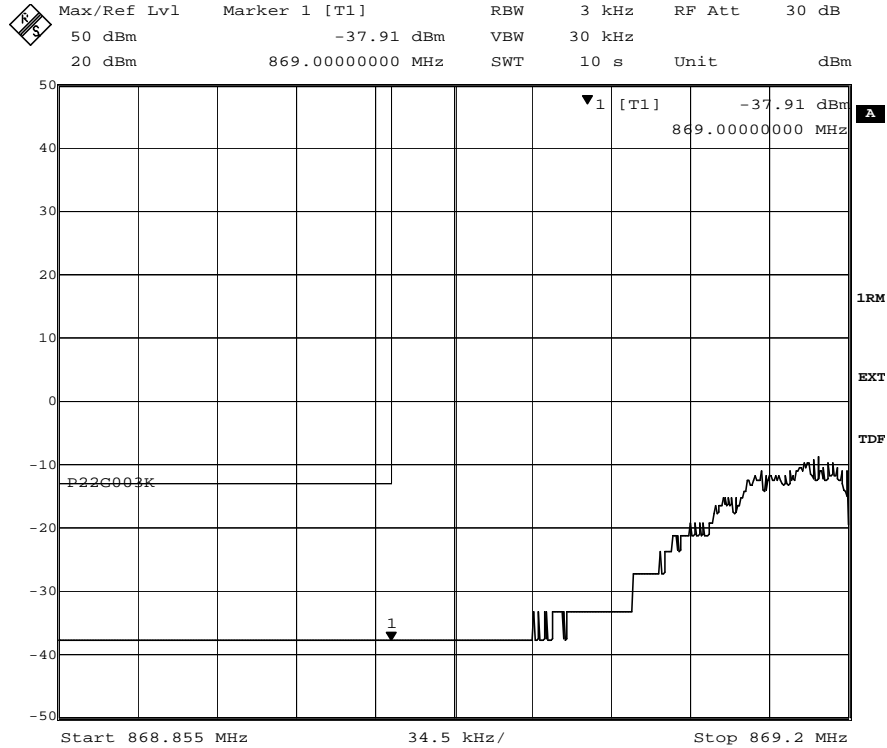

Date: 6.DEC.2011 09:48:32

Diagram 3 b:

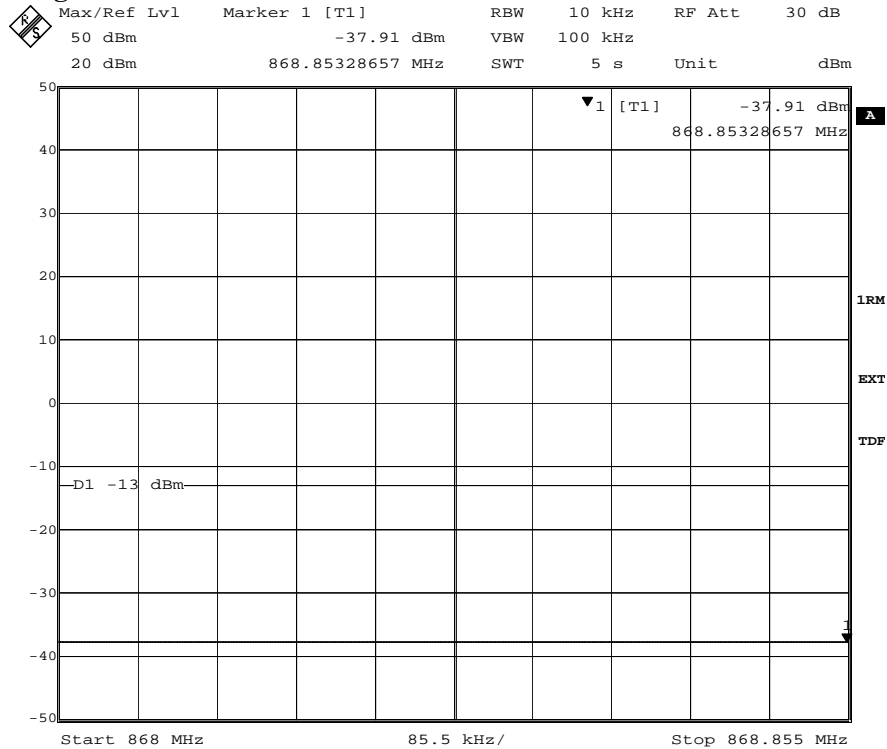

Date: 6.DEC.2011 09:49:36



Appendix 4

Diagram 3 c:

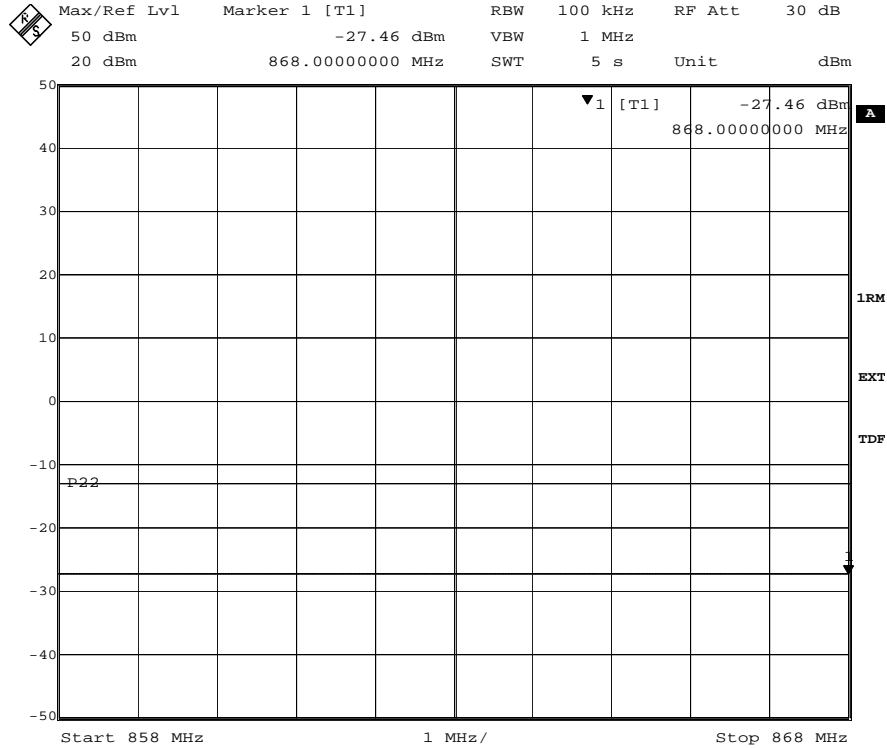

Date: 6.DEC.2011 09:50:08

Appendix 4

Diagram 4 a:

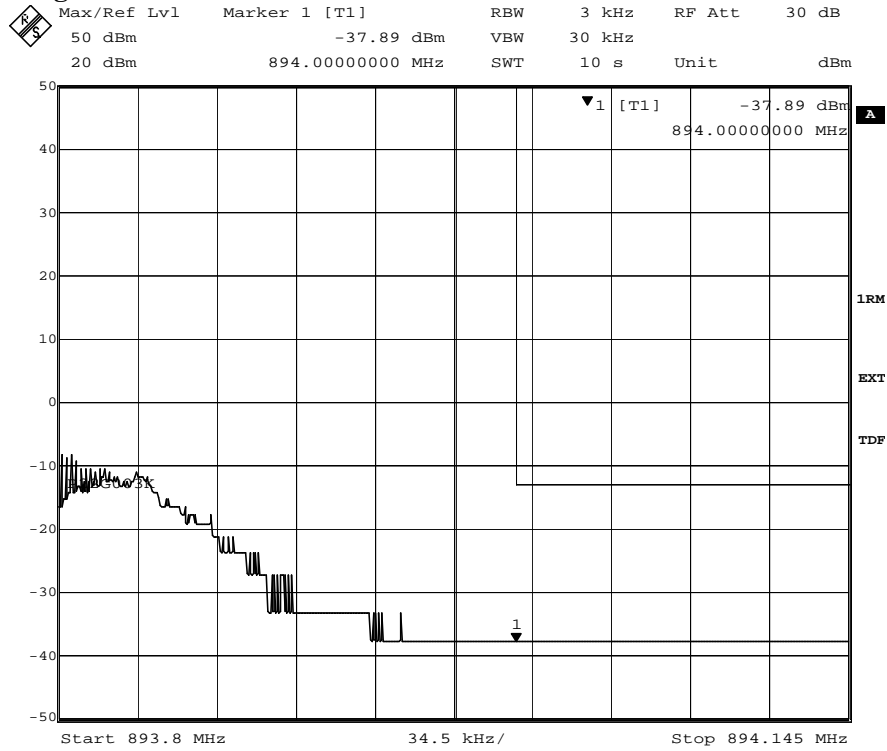

Date: 6.DEC.2011 09:57:55

Diagram 4 b:

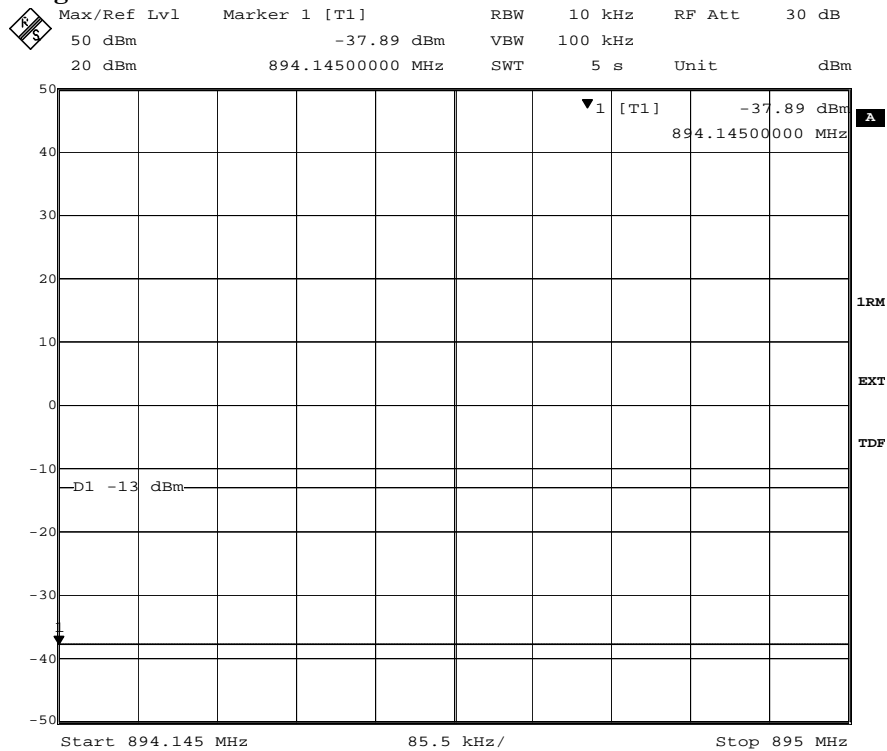

Date: 6.DEC.2011 09:59:37



Appendix 4

Diagram 4 c:

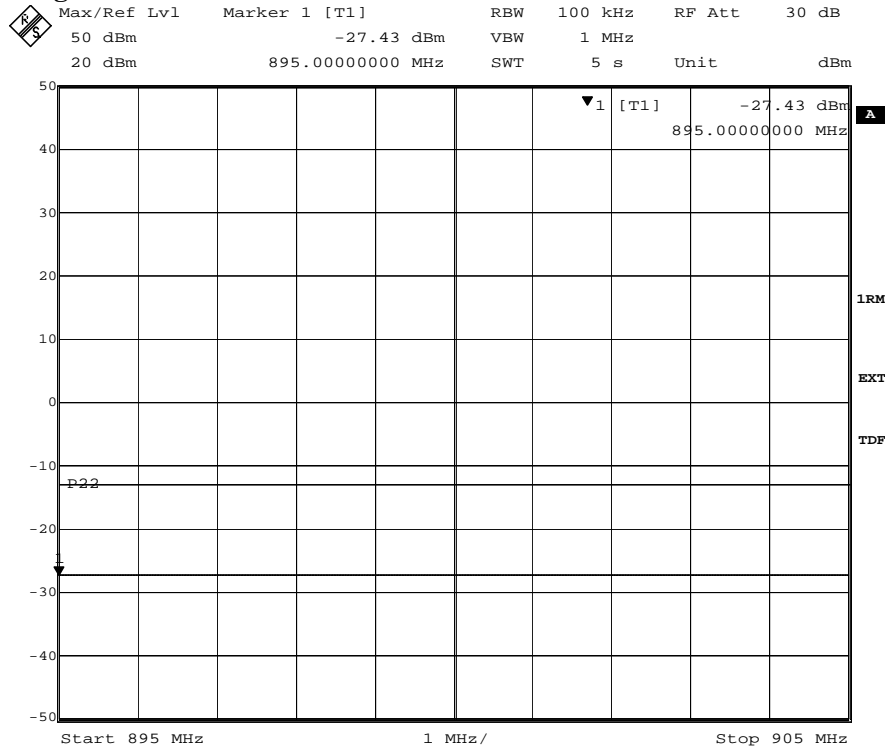

Date: 6.DEC.2011 10:00:31

Appendix 5

Conducted spurious emission measurements according to 47CFR 2.1051

Date 2011-12-06	Temperature 23 °C ± 3 °C	Humidity 27 % ± 5 %
--------------------	-----------------------------	------------------------

Test set-up and procedure

The measurements were made with the CDU output connected to a spectrum analyser. A pre-measurement was performed with the PEAK detector activated. Emission close or above the limit with the PEAK detector is measured with the RMS detector activated. The spectrum analyser was connected to an external 10 MHz reference standard during the measurements.

Measurement equipment	SP number
R&S FSIQ	503 738
Attenuator	504 159
High pass filter	502 758
Testo 635 temperature and humidity meter	504 203

Measurement uncertainty: 3.7 dB

Results

Configuration: TCC mode, RBS master 2E setting 51, TX ARFCN 190 (881.6 MHz)

Diagram 1 a: GMSK, 9 KHz – 1 GHz

Diagram 1 b: GMSK, 1 GHz – 10 GHz

Diagram 2 a: AQPSK, 9 KHz – 1 GHz

Diagram 2 b: AQPSK, 1 GHz – 10 GHz

The diagrams are shown on the following pages.

Limit

The power of any emission outside the frequency band shall be attenuated below the transmitter power (P) by at least $43 + 10 \log P$ dB.

Complies?	Yes
-----------	-----

Appendix 5

Diagram 1 a:

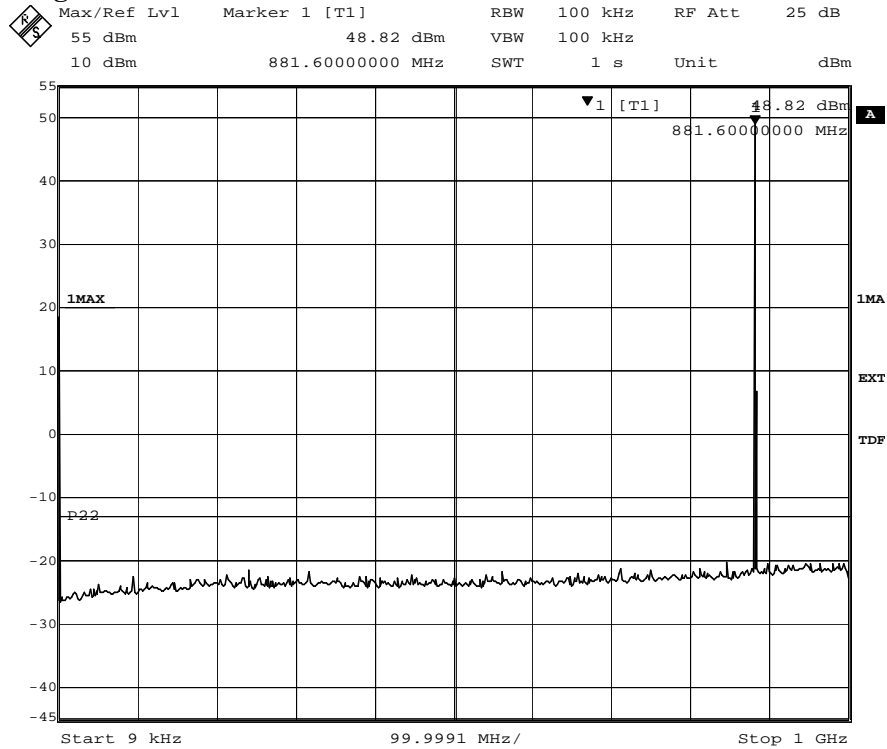

Date: 6.DEC.2011 10:13:26

Diagram 1 b:

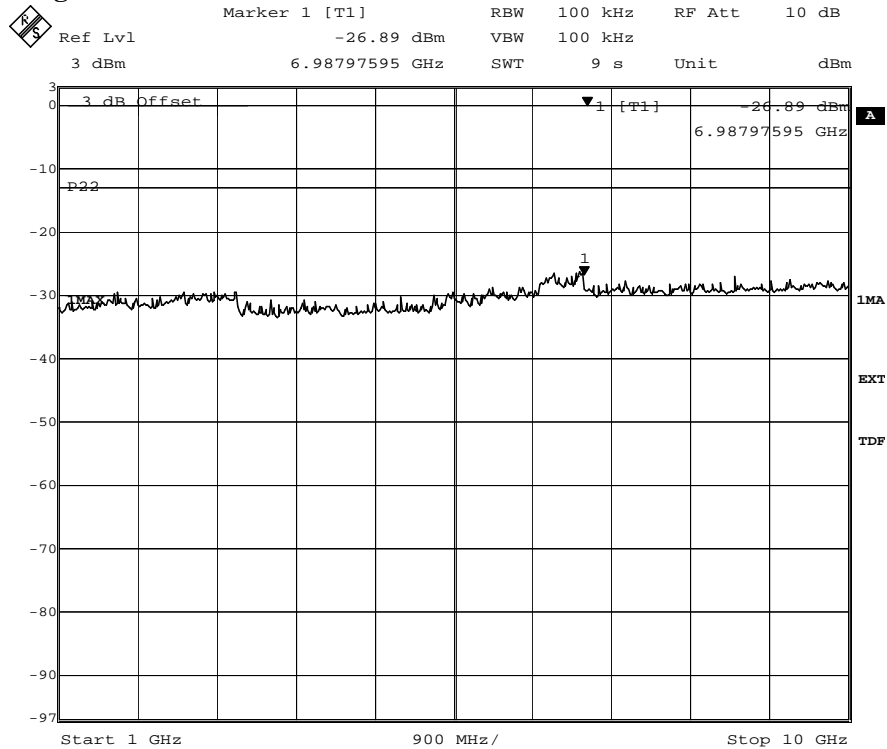

Date: 6.DEC.2011 10:15:48

Appendix 5

Diagram 2 a:

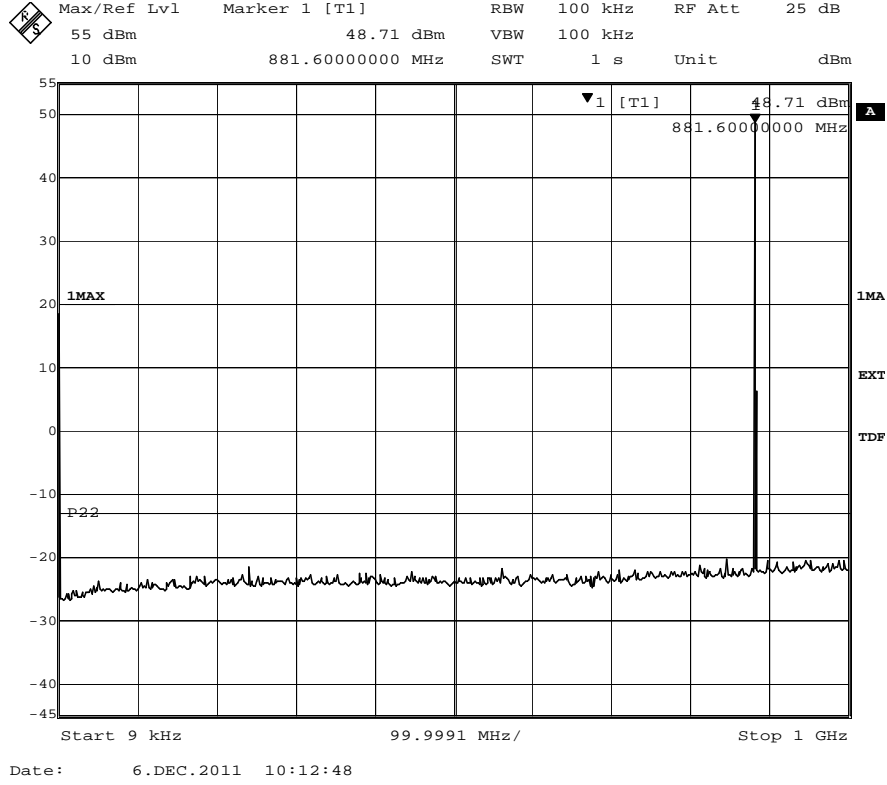
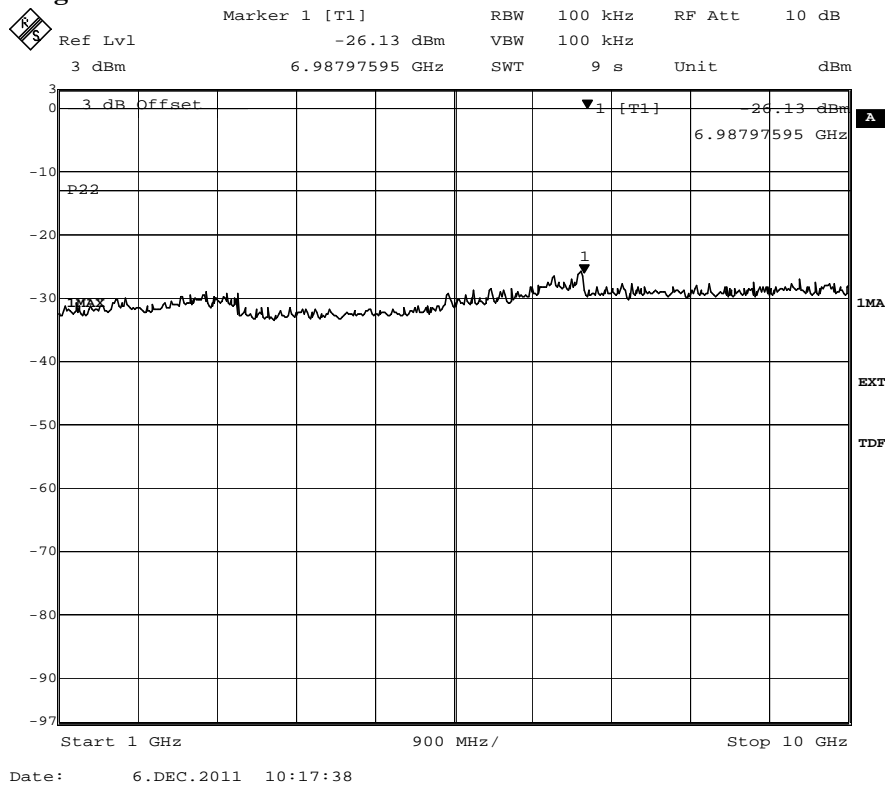

Diagram 2 b:



Appendix 6

Field strength of spurious radiation measurements according to 47CFR 2.1053

Date	Temperature	Humidity
2011-06-22	22 °C ± 3 °C	28 % ± 5 %

Test set-up and procedure

The measurements were performed with both horizontal and vertical polarisation of the antenna. The antenna distance was 3 m in the frequency range 30 MHz – 10 GHz. The measurements were performed in Effective Radiated Power (ERP). A fully anechoic chamber was used during the measurements. The chamber is regularly calibrated with the substitution method and from that calibration an ERP correction factor is derived. The correction factor was used as a transducer to get the readings in ERP.

The measurement procedure was as the following:

1. A pre-measurement was first performed with peak detector. The EUT was continuously measured in 360 degrees.
2. Spurious radiation on frequencies closer than 6 dB to the limit was re-measured with RMS detector and with the substitution method according to the standard.

EUT configuration: TCC mode, RBS master 2E setting 51, TX ARFCN 190 (881.6 MHz)

Measurement equipment	SP number
Anechoic chamber, Hertz	15:116
R&S FSIQ40 Signal Analyser for signal monitoring	503 738
R&S EMI Test Receiver ESI40	503 125
Chase bilog antenna CBL 6121A	502 460
Schaffner Reference Dipole BSRD6500	503 649
EMCO Horn Antenna 3115	502 175
EMCO Horn Antenna 3115	501 548
MITEQ Low Noise Amplifier	503 277
R&S Vector Network Analyser	503 687
High pass filter	502 758
Attenuator	540 159
Testo 615 temperature and humidity meter	503 498

Appendix 6

The test set-up is shown in the picture below:

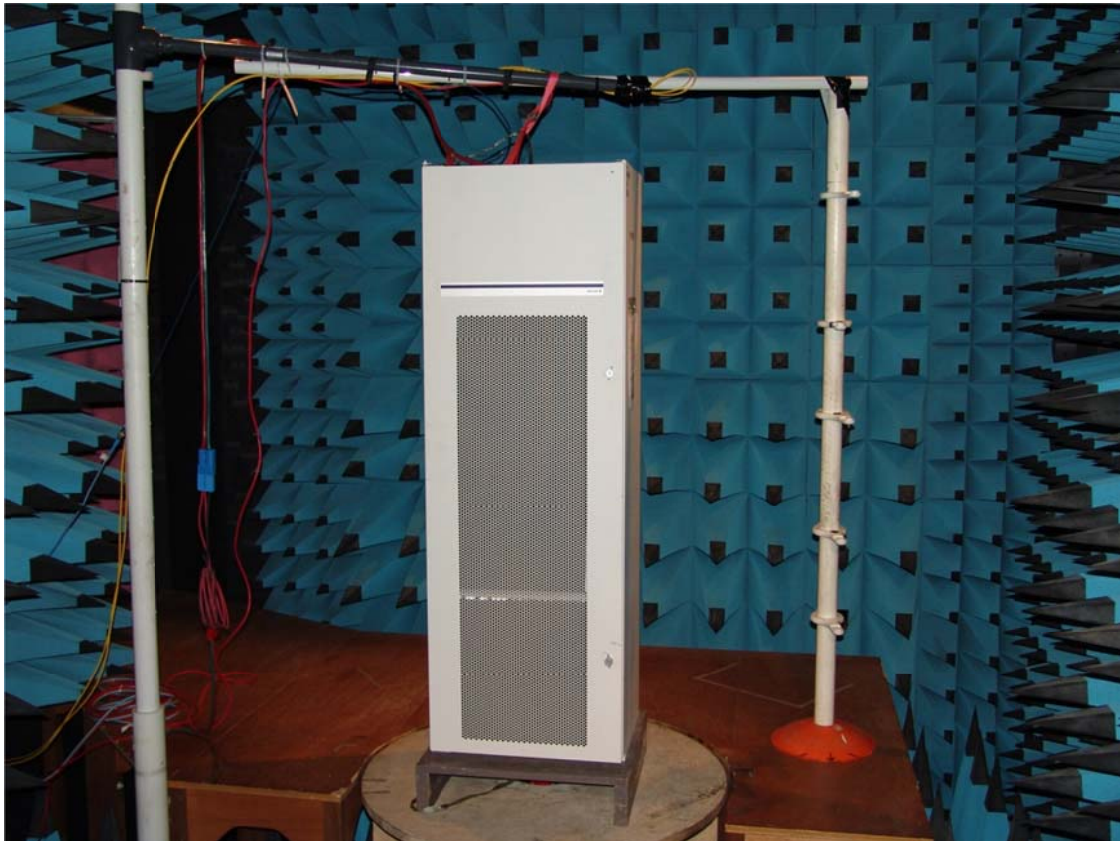

Appendix 6

Results

Modulation GMSK

Frequency (MHz)	Spurious emission level (dBm)	
	Vertical	Horizontal
30-10 000	All emission > 20 dB below limit	All emission > 20 dB below limit

Modulation AQPSK

Frequency (MHz)	Spurious emission level (dBm)	
	Vertical	Horizontal
30-10 000	All emission > 20 dB below limit	All emission > 20 dB below limit

Measurement uncertainty: 3.1 dB

Limit

The power of any emission outside the frequency band shall be attenuated below the transmitter power (P) by at least $43 + 10 \log P$ dB.

Complies?	Yes
-----------	-----

Appendix 7

Hardware list RBS 2206 V2 used for conducted and radiated measurements

Pos.	Unit	Product Number	Revision	Serial Number
	Cabinet RBS 2206 V2	SEB 112 1154/1	R2A	AB20110385
	Door	SXK 109 7157/1	R1A	-
	DCCU-13	BMG 980 07/11	R1D	BH41057606
	ACCU-11	BMG 980 07/09	R1A	BH41037398
	Subrack	BFL 119 424/1	R2A	-
1	CDU-G8	BFL 119 155/1	R3A	A40004WCLA
2	CDU-G8	BFL 119 155/1	R3A	A40004WCLV
3	CDU-G8	BFL 119 155/1	R3A	A40004WCL8
	Dummy	SXK 107 5031/2	R1B	-
	CXU-10	KRY 101 1856/1	R3D	TR44252258
	CXU-10	KRY 101 1856/1	R3D	TR45062312
	TRU subrack	BFL 119 425/1	R1C	-
	Backplane	BFX 101 107/3	R1A	-
1	dTRU-8	KRC 131 1005/2	R4A	AE53038582
2	dTRU-8	KRC 131 1005/2	R5A	AE55540317
3	dTRU-8	KRC 131 1005/2	R3A	AE51304512
4	dTRU-8	KRC 131 1005/2	R5A	AE55540324
5	dTRU-8	KRC 131 1005/2	R4A	AE53038668
6	dTRU-8	KRC 131 1005/2	R2C	AE50308770
	IDM-11	BMG 980 327/2	R1A	X181175714
	PSU/DXU subrack	BFL 119 453/1	R1A	BK41067514
	Backplane	BFX 101 109/1	R1A	-
1	PSU-AC-32	BML 353 206/2	R1C	BR80397724
2	PSU-AC-32	BML 353 206/2	R1C	BR80299548
3	PSU-AC-32	BML 353 206/2	R1C	BR80303083
4	Dummy	SXK 107 9314/1	R1D	-
5	Metal cover plate 1 slot	-	-	-
6a	TMA-CM-02	SDK 107 881/1	R3A	BG800000QP
6b	Metal cover plate ½ slot	-	-	-
7	DXU-23	BOE 602 21/1	R1D	TU8D552374

Test object software during both radiated and conducted measurements

Software	Revision
CXP 104 0007/05	R31E

Appendix 8

Photos of the test object

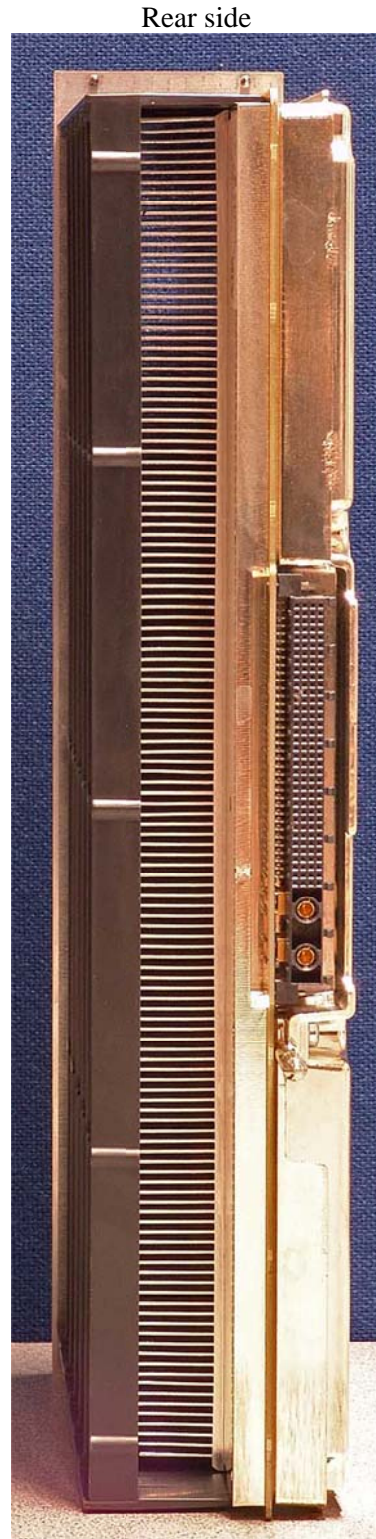

Appendix 8

Left side



Right side

