



FCC RF Test Report

APPLICANT : VeriFone, Inc.
EQUIPMENT : Point of Sale Terminal
BRAND NAME : Verifone or VERIFONE or verifone
MODEL NAME : UX700-ML-A
FCC ID : B32UX700MLA
STANDARD : FCC Part 15 Subpart C §15.247
CLASSIFICATION : (DSS) Spread Spectrum Transmitter
TEST DATE(S) : Mar. 10, 2025 ~ Apr. 23, 2025

We, Sporton International Inc. (Kunshan), would like to declare that the tested sample has been evaluated in accordance with the test procedures and has been in compliance with the applicable technical standards.

The test results in this report apply exclusively to the tested model / sample. Without written approval of Sporton International Inc. (Kunshan), the test report shall not be reproduced except in full.

Jason Jia



Approved by: Jason Jia

Sporton International Inc. (Kunshan)

No. 1098, Pengxi North Road, Kunshan Economic Development Zone Jiangsu Province 215300
People's Republic of China



TABLE OF CONTENTS

REVISION HISTORY..... 3

SUMMARY OF TEST RESULT 4

1 GENERAL DESCRIPTION..... 5

 1.1 Applicant 5

 1.2 Manufacturer 5

 1.3 Product Feature of Equipment Under Test..... 5

 1.4 Product Specification of Equipment Under Test..... 5

 1.5 Modification of EUT 5

 1.6 Testing Location 6

 1.7 Test Software..... 6

 1.8 Applicable Standards..... 6

2 TEST CONFIGURATION OF EQUIPMENT UNDER TEST..... 7

 2.1 Carrier Frequency Channel 7

 2.2 Test Mode..... 8

 2.3 Connection Diagram of Test System..... 9

 2.4 Support Unit used in test configuration and system 10

 2.5 EUT Operation Test Setup 10

 2.6 Measurement Results Explanation Example..... 10

3 TEST RESULT 11

 3.1 Number of Channel Measurement 11

 3.2 Hopping Channel Separation Measurement 12

 3.3 Dwell Time Measurement..... 13

 3.4 20dB and 99% Bandwidth Measurement 14

 3.5 Output Power Measurement..... 15

 3.6 Conducted Band Edges Measurement..... 16

 3.7 Conducted Spurious Emission Measurement 17

 3.8 Radiated Band Edges and Spurious Emission Measurement 18

 3.9 AC Conducted Emission Measurement..... 22

 3.10 Antenna Requirements 24

4 LIST OF MEASURING EQUIPMENT..... 25

5 MEASUREMENT UNCERTAINTY 26

APPENDIX A. CONDUCTED TEST RESULTS

APPENDIX B. AC CONDUCTED EMISSION TEST RESULT

APPENDIX C. RADIATED SPURIOUS EMISSION

APPENDIX D. DUTY CYCLE PLOTS

APPENDIX E. SETUP PHOTOGRAPHS



SUMMARY OF TEST RESULT

Report Section	FCC Rule	Description	Limit	Result	Remark
3.1	15.247(a)(1)	Number of Channels	≥ 15Chs	Pass	-
3.2	15.247(a)(1)	Hopping Channel Separation	≥ 2/3 of 20dB BW	Pass	-
3.3	15.247(a)(1)	Dwell Time of Each Channel	≤ 0.4sec in 31.6sec period	Pass	-
3.4	15.247(a)(1)	20dB Bandwidth	-	Report only	-
3.4	-	99% Bandwidth	-	Report only	-
3.5	15.247(b)(1)	Peak Output Power	≤ 125 mW	Pass	-
3.6	15.247(d)	Conducted Band Edges	≤ 20dBc	Pass	-
3.7	15.247(d)	Conducted Spurious Emission	≤ 20dBc	Pass	-
3.8	15.247(d)	Radiated Band Edges and Radiated Spurious Emission	15.209(a) & 15.247(d)	Pass	Under limit 6.70 dB at 53.28 MHz
3.9	15.207	AC Conducted Emission	15.207(a)	Pass	Under limit 15.88 dB at 0.396 MHz
3.10	15.203 & 15.247(b)	Antenna Requirement	15.203 & 15.247(b)	Pass	-

Conformity Assessment Condition:

1. The test results (PASS/FAIL) with all measurement uncertainty excluded are presented against the regulation limits or in accordance with the requirements stipulated by the applicant/manufacturer who shall bear all the risks of non-compliance that may potentially occur if measurement uncertainty is taken into account.
2. The measurement uncertainty please refer to each test result in the section "Measurement Uncertainty"

Disclaimer:

The product specifications of the EUT presented in the test report that may affect the test assessments are declared by the manufacturer who shall take full responsibility for the authenticity.



1 General Description

1.1 Applicant

VeriFone, Inc.
1400 West Stanford Ranch Road Suite 150 Rocklin CA 95765 USA

1.2 Manufacturer

VeriFone, Inc.
1400 West Stanford Ranch Road Suite 150 Rocklin CA 95765 USA

1.3 Product Feature of Equipment Under Test

Product Feature	
Equipment	Point of Sale Terminal
Brand Name	Verifone or VERIFONE or verifone
Model Name	UX700-ML-A
FCC ID	B32UX700MLA
SN Code	Conducted: 552-001-293 Conduction: 552-001-255 Radiation: 552-001-292
EUT Stage	Identical Prototype

Remark: The above EUT's information was declared by manufacturer. Please refer to the specifications or user's manual for more detailed description.

1.4 Product Specification of Equipment Under Test

Standards-related Product Specification	
Tx/Rx Frequency Range	2402 MHz ~ 2480 MHz
Number of Channels	79
Carrier Frequency of Each Channel	2402+n*1 MHz; n=0~78
Maximum Output Power to Antenna	Bluetooth BR(1Mbps) : 8.45 dBm (0.0070 W) Bluetooth EDR (2Mbps) : 9.62 dBm (0.0092 W) Bluetooth EDR (3Mbps) : 9.99 dBm (0.0100 W)
99% Occupied Bandwidth	Bluetooth BR(1Mbps) : 0.869MHz Bluetooth EDR (2Mbps) : 1.172MHz Bluetooth EDR (3Mbps) : 1.160MHz
Antenna Type / Gain	PIFA Antenna type with gain 0.63 dBi
Type of Modulation	Bluetooth BR (1Mbps) : GFSK Bluetooth EDR (2Mbps) : π/4-DQPSK Bluetooth EDR (3Mbps) : 8-DPSK

1.5 Modification of EUT

No modifications are made to the EUT during all test items.



1.6 Testing Location

Sporton International Inc. (Kunshan) is accredited to ISO/IEC 17025:2017 by American Association for Laboratory Accreditation with Certificate Number 5145.02.

Test Firm	Sporton International Inc. (Kunshan)		
Test Site Location	No. 1098, Pengxi North Road, Kunshan Economic Development Zone Jiangsu Province 215300 People’s Republic of China TEL : +86-512-57900158		
Test Site No.	Sporton Site No.	FCC Designation No.	FCC Test Firm Registration No.
	CO01-KS 03CH06-KS TH01-KS	CN1257	314309

1.7 Test Software

Item	Site	Manufacturer	Name	Version
1.	TH01-KS	Tonscend	JS1120-3 test system China_210602	3.3.10
2.	03CH06-KS	AUDIX	E3	210616
3.	CO01-KS	AUDIX	E3	6.2009-8-24

1.8 Applicable Standards

According to the specifications of the manufacturer, the EUT must comply with the requirements of the following standards:

- 47 CFR Part 15 Subpart C §15.247
- FCC KDB 558074 D01 15.247 Meas Guidance v05r02
- ANSI C63.10-2013

Remark:

1. All test items were verified and recorded according to the standards and without any deviation during the test.
2. This EUT has also been tested and complied with the requirements of FCC Part 15, Subpart B, recorded in a separate test report.



2 Test Configuration of Equipment Under Test

2.1 Carrier Frequency Channel

Frequency Band	Channel	Freq. (MHz)	Channel	Freq. (MHz)	Channel	Freq. (MHz)
2400-2483.5 MHz	0	2402	27	2429	54	2456
	1	2403	28	2430	55	2457
	2	2404	29	2431	56	2458
	3	2405	30	2432	57	2459
	4	2406	31	2433	58	2460
	5	2407	32	2434	59	2461
	6	2408	33	2435	60	2462
	7	2409	34	2436	61	2463
	8	2410	35	2437	62	2464
	9	2411	36	2438	63	2465
	10	2412	37	2439	64	2466
	11	2413	38	2440	65	2467
	12	2414	39	2441	66	2468
	13	2415	40	2442	67	2469
	14	2416	41	2443	68	2470
	15	2417	42	2444	69	2471
	16	2418	43	2445	70	2472
	17	2419	44	2446	71	2473
	18	2420	45	2447	72	2474
	19	2421	46	2448	73	2475
	20	2422	47	2449	74	2476
	21	2423	48	2450	75	2477
	22	2424	49	2451	76	2478
	23	2425	50	2452	77	2479
	24	2426	51	2453	78	2480
	25	2427	52	2454	-	-
	26	2428	53	2455	-	-



2.2 Test Mode

- a. The EUT has been associated with peripherals and configuration operated in a manner tended to maximize its emission characteristics in a typical application. Frequency range investigated: conduction emission (150 kHz to 30 MHz), radiation emission (9 kHz to the 10th harmonic of the highest fundamental frequency or to 40 GHz, whichever is lower). For radiated measurement, only the worst cases (Y plane) were recorded in this report, and the worst mode of radiated spurious emissions is Bluetooth 3Mbps mode, and recorded in this report.
- b. AC power line Conducted Emission was tested under maximum output power.

The following summary table is showing all test modes to demonstrate in compliance with the standard.

Summary table of Test Cases			
Test Item	Data Rate / Modulation		
	Bluetooth BR 1Mbps GFSK	Bluetooth EDR 2Mbps π/4-DQPSK	Bluetooth EDR 3Mbps 8-DPSK
Conducted Test Cases	Mode 1: CH00_2402 MHz Mode 2: CH39_2441 MHz Mode 3: CH78_2480 MHz	Mode 4: CH00_2402 MHz Mode 5: CH39_2441 MHz Mode 6: CH78_2480 MHz	Mode 7: CH00_2402 MHz Mode 8: CH39_2441 MHz Mode 9: CH78_2480 MHz
Radiated Test Cases	Bluetooth EDR 3Mbps 8-DPSK		
	Mode 1: CH00_2402 MHz Mode 2: CH39_2441 MHz Mode 3: CH78_2480 MHz		
AC Conducted Emission	Mode 1: Bluetooth Link + WLAN Link (2.4G) + Orange D0 + Orange Cables_U2 + Adapter 1 + Earphone		
Remark: <ol style="list-style-type: none"> For radiated test cases, the worst mode data rate 3Mbps was reported only, because this data rate has the highest RF output power at preliminary tests, and no other significantly frequencies found in conducted spurious emission. For Radiated Test Cases, The tests were performed with Adapter 1. 			

2.3 Connection Diagram of Test System

AC Conducted Emission:

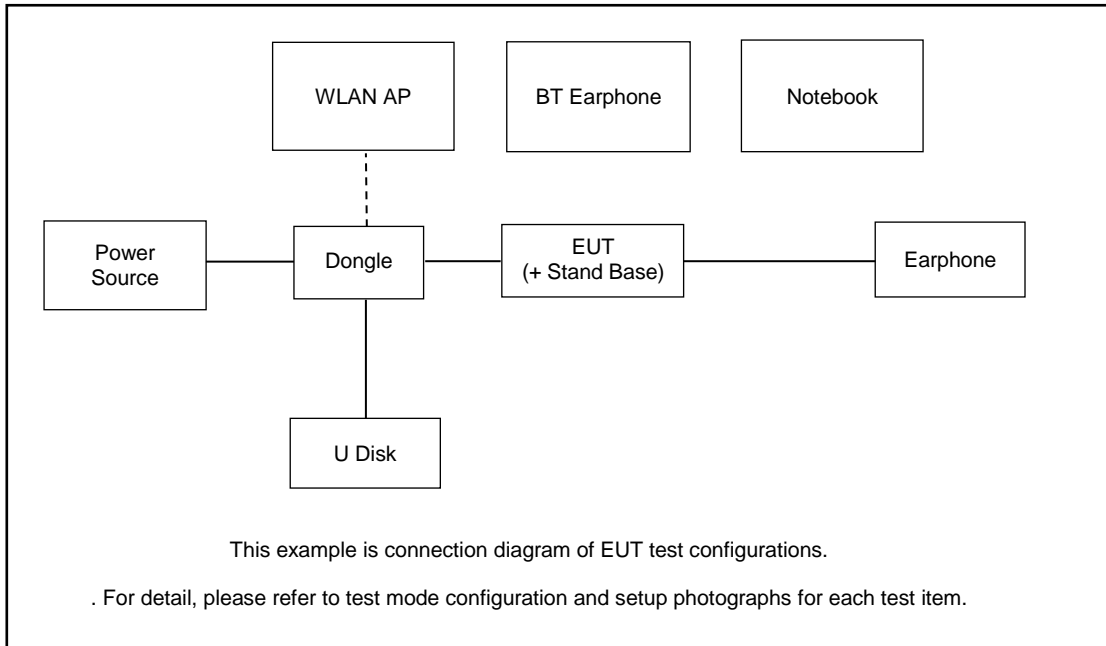

Radiated Emission:

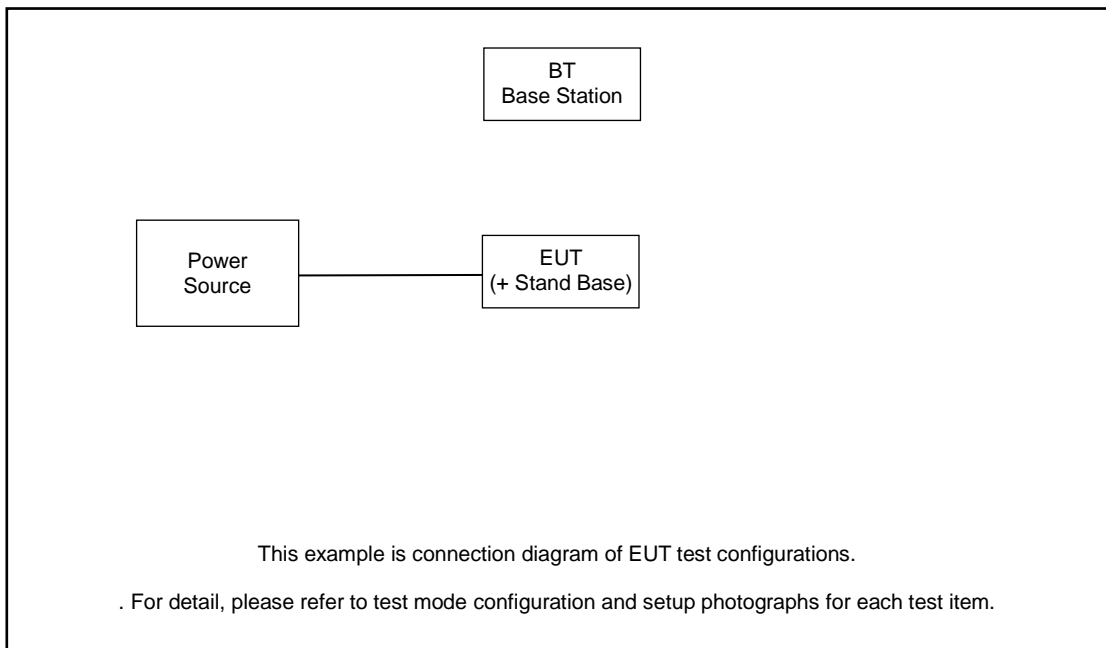

2.4 Support Unit used in test configuration and system

Item	Equipment	Trade Name	Model Name	FCC ID	Data Cable	Power Cord
1.	BT Base Station	R&S	CBT	N/A	N/A	Unshielded, 1.8m
2.	Bluetooth Earphone	Lenovo	thinkplus-BH3	N/A	N/A	N/A
3.	Notebook	Lenovo	V130-15IKB005	N/A	N/A	shielded cable DC O/P 1.8m , Unshielded AC I/P cable 1.8m
4.	WLAN AP	D-link	DIR-655	KA21R655B1	N/A	Unshielded,1.8m
5.	U Disk	SanDisk	SDCZ50-008G	N/A	N/A	N/A
6.	Earphone	Lenovo	P121	N/A	N/A	Unshielded,1.2m

2.5 EUT Operation Test Setup

For Bluetooth function, the engineering test program was provided and enabled to make EUT connect with Bluetooth base station to continuous transmit.

For AC power line conducted emissions, the EUT was set to connect with the BT Earphone under large package sizes transmission.

2.6 Measurement Results Explanation Example

For all conducted test items:

The offset level is set in the spectrum analyzer to compensate the RF cable loss and attenuator factor between EUT conducted output port and spectrum analyzer. With the offset compensation, the spectrum analyzer reading level is exactly the EUT RF output level.

Example :

The spectrum analyzer offset is derived from RF cable loss and attenuator factor.

Offset = RF cable loss + attenuator factor.

Following shows an offset computation example with cable loss 2.19 dB and 20dB attenuator.

Offset(dB) = RF cable loss(dB) + attenuator factor(dB).

$$= 2.19 + 20 = 22.19 \text{ (dB)}$$

3 Test Result

3.1 Number of Channel Measurement

3.1.1 Limits of Number of Hopping Frequency

Frequency hopping systems in the 2400-2483.5 MHz band shall use at least 15 channels.

3.1.2 Measuring Instruments

The measuring equipment is listed in the section 4 of this test report.

3.1.3 Test Procedure

1. The testing follows ANSI C63.10-2013 clause 7.8.3.
2. The RF output of EUT was connected to the spectrum analyzer by RF cable and attenuator. The path loss was compensated to the results for each measurement.
3. Set to the maximum power setting and enable the EUT transmit continuously.
4. Enable the EUT hopping function.
5. Use the following spectrum analyzer settings: Span = the frequency band of operation; RBW = 300kHz; VBW \geq RBW; Sweep = auto; Detector function = peak; Trace = max hold.
6. The number of hopping frequency used is defined as the number of total channel.
7. Record the measurement data derived from spectrum analyzer.

3.1.4 Test Setup



3.1.5 Test Result of Number of Hopping Frequency

Please refer to Appendix A.

3.2 Hopping Channel Separation Measurement

3.2.1 Limit of Hopping Channel Separation

Frequency hopping systems operating in the 2400-2483.5 MHz band may have hopping channel carrier frequencies that are separated by 25 kHz or two-thirds of the 20 dB bandwidth of the hopping channel, whichever is greater.

3.2.2 Measuring Instruments

The measuring equipment is listed in the section 4 of this test report.

3.2.3 Test Procedures

1. The testing follows ANSI C63.10-2013 clause 7.8.2.
2. The RF output of EUT was connected to the spectrum analyzer by RF cable and attenuator. The path loss was compensated to the results for each measurement.
3. Set to the maximum power setting and enable the EUT transmit continuously.
4. Enable the EUT hopping function.
5. Use the following spectrum analyzer settings:
Span = wide enough to capture the peaks of two adjacent channels;
RBW = 300kHz; VBW \geq RBW; Sweep = auto; Detector function = peak; Trace = max hold.
6. Measure and record the results in the test report.

3.2.4 Test Setup

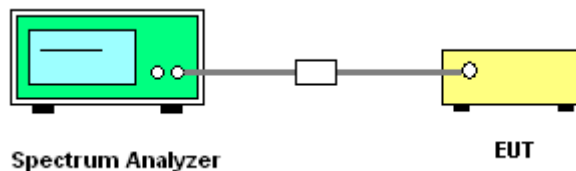

3.2.5 Test Result of Hopping Channel Separation

Please refer to Appendix A.

3.3 Dwell Time Measurement

3.3.1 Limit of Dwell Time

The average time of occupancy on any channel shall not be greater than 0.4 seconds within a period of 0.4 seconds multiplied by the number of hopping channels employed.

3.3.2 Measuring Instruments

The measuring equipment is listed in the section 4 of this test report.

3.3.3 Test Procedures

1. The testing follows ANSI C63.10-2013 clause 7.8.4.
2. The RF output of EUT was connected to the spectrum analyzer by RF cable and attenuator. The path loss was compensated to the results for each measurement.
3. Set to the maximum power setting and enable the EUT transmit continuously.
4. Enable the EUT hopping function.
5. Use the following spectrum analyzer settings: Span = zero span, centered on a hopping channel; RBW = 1 MHz; VBW \geq RBW; Sweep = as necessary to capture the entire dwell time per hopping channel; Detector function = peak; Trace = max hold.
6. Measure and record the results in the test report.

3.3.4 Test Setup



3.3.5 Test Result of Dwell Time

Please refer to Appendix A.

3.4 20dB and 99% Bandwidth Measurement

3.4.1 Limit of 20dB and 99% Bandwidth

Reporting only

3.4.2 Measuring Instruments

The measuring equipment is listed in the section 4 of this test report.

3.4.3 Test Procedures

1. The testing follows ANSI C63.10-2013 clause 6.9.2 and 6.9.3.
2. The RF output of EUT was connected to the spectrum analyzer by RF cable and attenuator. The path loss was compensated to the results for each measurement.
3. Set to the maximum power setting and enable the EUT transmit continuously.
4. Use the following spectrum analyzer settings for 20dB Bandwidth measurement.
Span = approximately 2 to 5 times the 20 dB bandwidth, centered on a hopping channel;
The RBW is set to 1% to 5% of the 99% OBW, the VBW is set to 3 times the RBW;
Sweep = auto; Detector function = peak;
Trace = max hold.
5. Use the following spectrum analyzer settings for 99 % Bandwidth measurement.
Span = approximately 1.5 to 5 times the 99% bandwidth, centered on a hopping channel;
The RBW is set to 1% to 5% of the 99% OBW, the VBW is set to 3 times the RBW;
Sweep = auto; Detector function = peak;
Trace = max hold.
6. Measure and record the results in the test report.

3.4.4 Test Setup

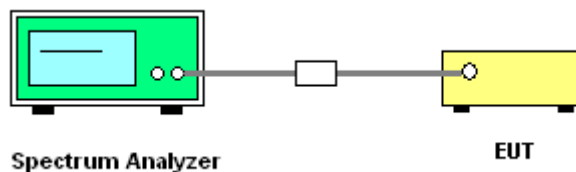

3.4.5 Test Result of 20dB and 99% Bandwidth

Please refer to Appendix A.

3.5 Output Power Measurement

3.5.1 Limit of Output Power

The maximum peak conducted output power of the intentional radiator shall not exceed the following: For frequency hopping systems operating in the 2400-2483.5 MHz band employing at least 75 non-overlapping hopping channels, and all frequency hopping systems in the 5725-5850 MHz band: 1 watt. For all other frequency hopping systems in the 2400-2483.5 MHz band 0.125 watts. The power limit for 1Mbps, 2Mbps, 3Mbps and AFH modes are 0.125 watts.

3.5.2 Measuring Instruments

The measuring equipment is listed in the section 4 of this test report.

3.5.3 Test Procedures

1. The testing follows ANSI C63.10-2013 clause 7.8.5.
2. The RF output of EUT was connected to the power meter by RF cable and attenuator. The path loss was compensated to the results for each measurement.
3. Set to the maximum power setting and enable the EUT transmit continuously.
4. Measure the conducted output power with cable loss and record the results in the test report.
5. Measure and record the results in the test report.

3.5.4 Test Setup

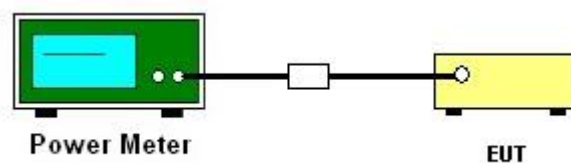

3.5.5 Test Result of Peak Output Power

Please refer to Appendix A.

3.6 Conducted Band Edges Measurement

3.6.1 Limit of Band Edges

In any 100 kHz bandwidth outside the intentional radiation frequency band, the radio frequency power shall be at least 20 dB below the highest level of the radiated power. In addition, radiated emissions which fall in the restricted bands must also comply with the radiated emission limits.

3.6.2 Measuring Instruments

The measuring equipment is listed in the section 4 of this test report.

3.6.3 Test Procedures

1. The testing follows ANSI C63.10-2013 clause 7.8.6.
2. Set to the maximum power setting and enable the EUT transmit continuously.
3. Set RBW = 100kHz, VBW = 300kHz. Band edge emissions must be at least 20 dB down from the highest emission level within the authorized band as measured with a 100kHz RBW. The attenuation shall be 30 dB instead of 20 dB when RMS conducted output power procedure is used.
4. Enable hopping function of the EUT and then repeat step 2. and 3.
5. Measure and record the results in the test report.

3.6.4 Test Setup



3.6.5 Test Result of Conducted Band Edges

Please refer to Appendix A.

3.6.6 Test Result of Conducted Hopping Mode Band Edges

Please refer to Appendix A.

3.7 Conducted Spurious Emission Measurement

3.7.1 Limit of Spurious Emission Measurement

In any 100 kHz bandwidth outside the intentional radiation frequency band, the radio frequency power shall be at least 20 dB below the highest level of the radiated power. In addition, radiated emissions which fall in the restricted bands must also comply with the radiated emission limits.

3.7.2 Measuring Instruments

The measuring equipment is listed in the section 4 of this test report.

3.7.3 Test Procedure

1. The testing follows ANSI C63.10-2013 clause 7.8.8.
2. The RF output of EUT was connected to the spectrum analyzer by RF cable and attenuator. The path loss was compensated to the results for each measurement.
3. Set to the maximum power setting and enable the EUT transmit continuously.
4. Set RBW = 100 kHz, VBW = 300kHz, scan up through 10th harmonic. All harmonics / spurs must be at least 20 dB down from the highest emission level within the authorized band as measured with a 100 kHz RBW.
5. Measure and record the results in the test report.
6. The RF fundamental frequency should be excluded against the limit line in the operating frequency band.

3.7.4 Test Setup



3.7.5 Test Result of Conducted Spurious Emission

Please refer to Appendix A.



3.8 Radiated Band Edges and Spurious Emission Measurement

3.8.1 Limit of Radiated Band Edges and Spurious Emission

In any 100 kHz bandwidth outside the intentional radiator frequency band, all harmonics/spurious must be at least 20 dB below the highest emission level within the authorized band. In addition, radiated emissions which fall in the restricted bands must also comply with the limits as below.

Frequency (MHz)	Field Strength (microvolts/meter)	Measurement Distance (meters)
0.009 – 0.490	2400/F(kHz)	300
0.490 – 1.705	24000/F(kHz)	30
1.705 – 30.0	30	30
30 – 88	100	3
88 – 216	150	3
216 - 960	200	3
Above 960	500	3

3.8.2 Measuring Instruments

The measuring equipment is listed in the section 4 of this test report.



3.8.3 Test Procedures

1. The EUT was placed on a turntable with 0.8 meter for frequency below 1GHz and 1.5 meter for frequency above 1GHz respectively above ground.
2. The EUT was set 3 meters from the interference receiving antenna, which was mounted on the top of a variable height antenna tower.
3. For each suspected emission, the EUT was arranged to its worst case and then tune the Antenna tower (from 1 m to 4 m) and turntable (from 0 degree to 360 degrees) to find the maximum reading. A pre-amp and a high pass filter are used for the test in order to get better signal level to comply with the guidelines.
4. Set to the maximum power setting and enable the EUT transmit continuously.
5. Use the following spectrum analyzer settings:
 - (1) Span shall wide enough to fully capture the emission being measured;
 - (2) Set RBW=100 kHz for $f < 1 \text{ GHz}$, RBW=1MHz for $f > 1\text{GHz}$; VBW \geq RBW; Sweep = auto; Detector function = peak; Trace = max hold for peak
 - (3) For average measurement: use duty cycle correction factor method per 15.35(c).
Duty cycle = On time/100 milliseconds
On time = $N_1 * L_1 + N_2 * L_2 + \dots + N_{n-1} * L_{n-1} + N_n * L_n$
Where N_1 is number of type 1 pulses, L_1 is length of type 1 pulses, etc.
Average Emission Level = Peak Emission Level + $20 * \log(\text{Duty cycle})$
6. Corrected Reading: Antenna Factor + Cable Loss + Read Level - Preamp Factor = Level
7. For testing below 1GHz, if the emission level of the EUT in peak mode was 3 dB lower than the limit specified, then peak values of EUT will be reported, otherwise, the emissions will be repeated one by one using the CISPR quasi-peak method and reported.
8. For testing above 1GHz, the emission level of the EUT in peak mode was 20dB lower than peak limit (that means the emission level in average mode also complies with the limit in average mode), then peak values of EUT will be reported, otherwise, the emissions will be measured in average mode again and reported.

Note: The average levels were calculated from the peak level corrected with duty cycle correction factor (-24.79dB) derived from $20 \log(\text{dwell time}/100\text{ms})$. This correction is only for signals that hop with the fundamental signal, such as band-edge and harmonic. Other spurious signals that are independent of the hopping signal would not use this correction.

3.8.4 Test Setup

For radiated emissions below 30MHz

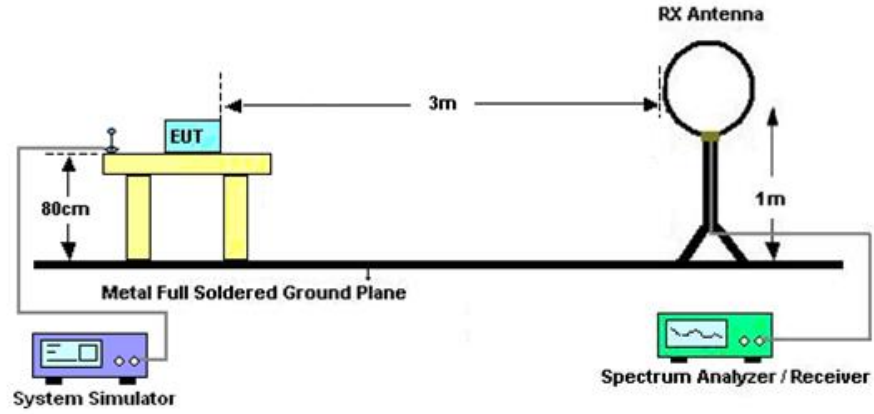

For radiated emissions from 30MHz to 1GHz

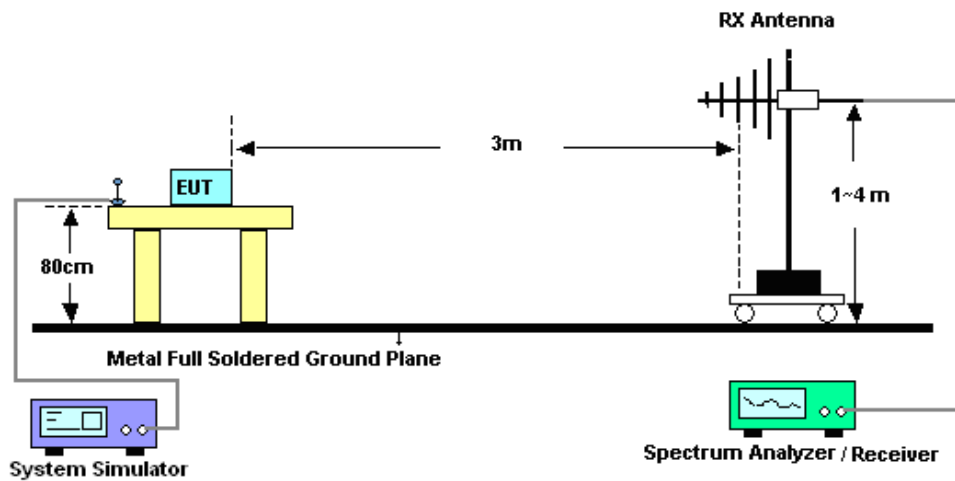

For radiated emissions above 1GHz

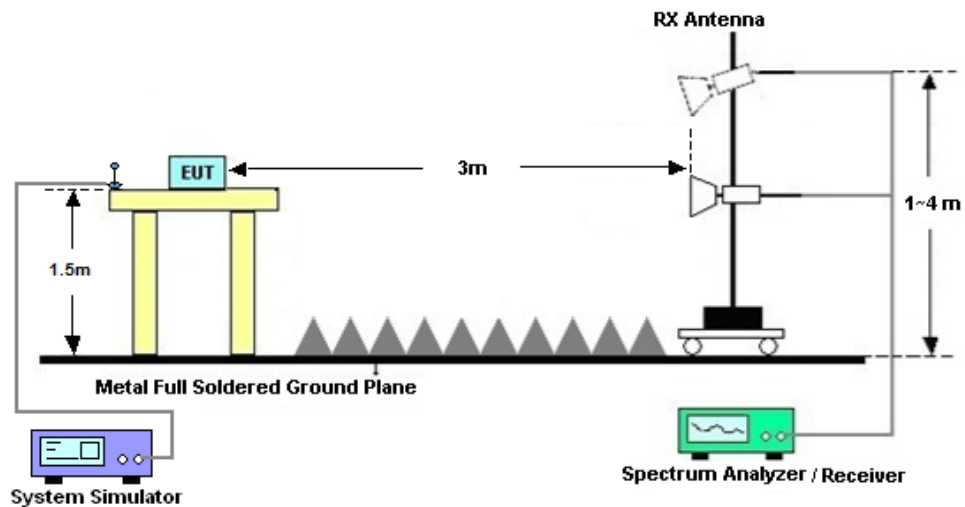



3.8.5 Test Results of Radiated Spurious Emissions (9 kHz ~ 30 MHz)

The low frequency, which started from 9 kHz to 30MHz, was pre-scanned and the result which was 20dB lower than the limit line was not reported.

There is a comparison data of both open-field test site and semi-Anechoic chamber, and the result came out very similar.

3.8.6 Test Result of Radiated Spurious at Band Edges

Please refer to Appendix C.

3.8.7 Test Result of Radiated Spurious Emission (30MHz ~ 10th Harmonic or 40GHz, whichever is lower)

Please refer to Appendix C.

3.8.8 Duty cycle correction factor for average measurement

Please refer to Appendix D.



3.9 AC Conducted Emission Measurement

3.9.1 Limit of AC Conducted Emission

For equipment that is designed to be connected to the public utility (AC) power line, the radio frequency voltage that is conducted back onto the AC power line on any frequency or frequencies within the band 150 kHz to 30 MHz shall not exceed the limits in the following table.

Frequency of emission (MHz)	Conducted limit (dBµV)	
	Quasi-peak	Average
0.15-0.5	66 to 56*	56 to 46*
0.5-5	56	46
5-30	60	50

*Decreases with the logarithm of the frequency.

3.9.2 Measuring Instruments

The measuring equipment is listed in the section 4 of this test report.

3.9.3 Test Procedures

1. The EUT was placed 0.4 meter from the conducting wall of the shielding room was kept at least 80 centimeters from any other grounded conducting surface.
2. Connect EUT to the power mains through a line impedance stabilization network (LISN).
3. All the support units are connecting to the other LISN.
4. The LISN provides 50 ohm coupling impedance for the measuring instrument.
5. The FCC states that a 50 ohm, 50 microhenry LISN should be used.
6. Both sides of AC line were checked for maximum conducted interference.
7. The frequency range from 150 kHz to 30 MHz was searched.
8. Set the test-receiver system to Peak Detect Function and specified bandwidth (IF Bandwidth = 9kHz) with Maximum Hold Mode. Then measurement is also conducted by Average Detector and Quasi-Peak Detector Function respectively.

3.9.4 Test Setup

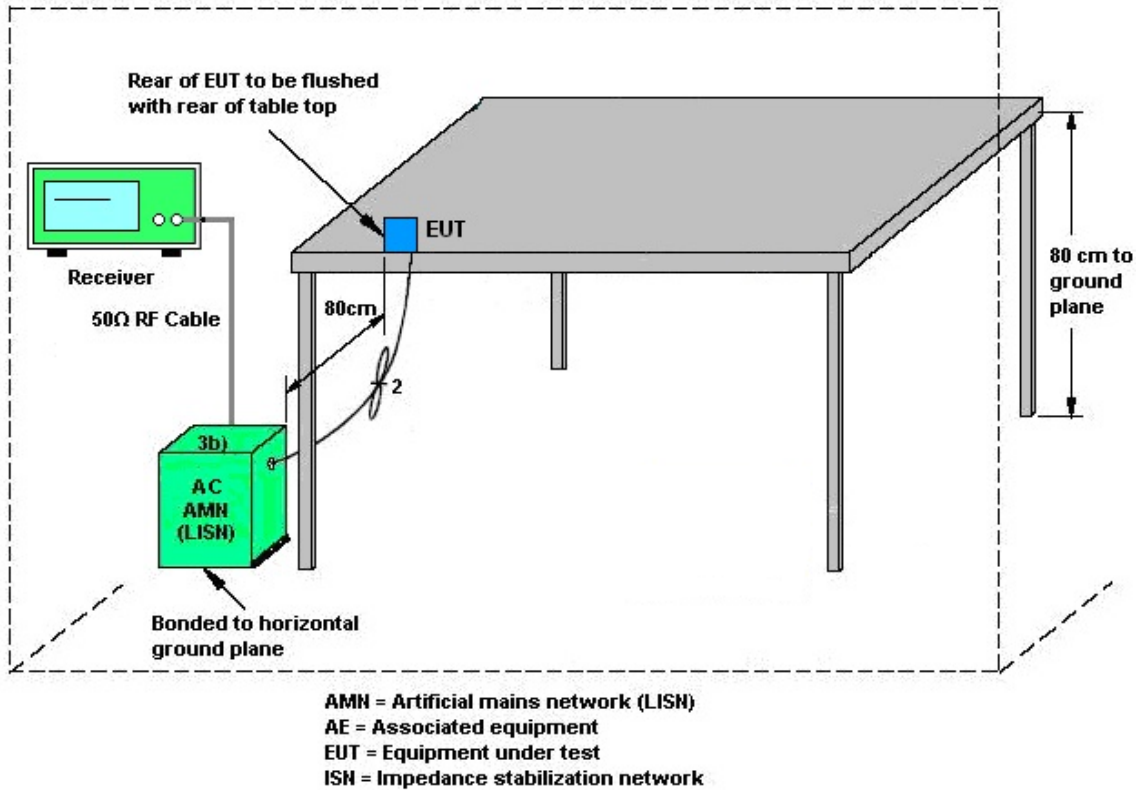

3.9.5 Test Result of AC Conducted Emission

Please refer to Appendix B.



3.10 Antenna Requirements

3.10.1 Standard Applicable

If directional gain of transmitting antennas is greater than 6dBi, the power shall be reduced by the same level in dB comparing to gain minus 6dBi. The use of a permanently attached antenna or of an antenna that uses a unique coupling to the intentional radiator shall be considered sufficient to comply with the rule.

3.10.2 Antenna Anti-Replacement Construction

An embedded-in antenna design is used.

3.10.3 Antenna Gain

The antenna peak gain of EUT is less than 6 dBi. Therefore, it is not necessary to reduce maximum peak output power limit.



4 List of Measuring Equipment

Instrument	Manufacturer	Model No.	Serial No.	Characteristics	Calibration Date	Test Date	Due Date	Remark
EMI Test Receiver	Keysight	N9038A	MY57290157	3Hz~8.5GHz;Max 30dBm	Feb. 22, 2025	Apr. 03, 2025	Feb. 21, 2026	Radiation (03CH06-KS)
EXA Spectrum Analyzer	Keysight	N9010B	MY57471084	10Hz~44GHz	Jul. 04, 2024	Apr. 03, 2025	Jul. 03, 2025	Radiation (03CH06-KS)
Loop Antenna	R&S	HFH2-Z2E	101125	9kHz~30MHz	Sep. 08, 2024	Apr. 03, 2025	Sep. 07, 2025	Radiation (03CH06-KS)
Bilog Antenna	TeseQ	CBL6111D	59913	30MHz~1GHz	Sep. 03, 2024	Apr. 03, 2025	Sep. 02, 2025	Radiation (03CH06-KS)
Double Ridge Horn Antenna	ETS-Lindgren	3117	00218652	1GHz~18GHz	Apr. 11, 2024	Apr. 03, 2025	Apr. 10, 2025	Radiation (03CH06-KS)
SHF-EHF Horn	Com-power	AH-840	101116	18GHz~40GHz	Oct. 22, 2024	Apr. 03, 2025	Oct. 21, 2025	Radiation (03CH06-KS)
Amplifier	SONOMA	310N	380827	9KHz ~1GHZ	Jul. 04, 2024	Apr. 03, 2025	Jul. 03, 2025	Radiation (03CH06-KS)
Amplifier	EM	EM18G40GA	060728	18~40GHz	Jan. 03, 2025	Apr. 03, 2025	Jan. 02, 2026	Radiation (03CH06-KS)
high gain Amplifier	EM	EM01G18GA	060845	1Ghz-18Ghz	Jan. 03, 2025	Apr. 03, 2025	Jan. 02, 2026	Radiation (03CH06-KS)
Amplifier	Keysight	83017A	MY57280119	500MHz~26.5GHz	Oct. 09, 2024	Apr. 03, 2025	Oct. 08, 2025	Radiation (03CH06-KS)
AC Power Source	Chroma	61601	F104090004	N/A	NCR	Apr. 03, 2025	NCR	Radiation (03CH06-KS)
Turn Table	ChamPro	EM 1000-T	060762-T	0~360 degree	NCR	Apr. 03, 2025	NCR	Radiation (03CH06-KS)
Antenna Mast	ChamPro	EM 1000-A	060762-A	1 m~4 m	NCR	Apr. 03, 2025	NCR	Radiation (03CH06-KS)
Spectrum Analyzer	R&S	FSV40	101040	10Hz~40GHz	Oct. 10, 2024	Mar. 10, 2025~Mar. 13, 2025	Oct. 09, 2025	Conducted (TH01-KS)
Pulse Power Sensor	Anritsu	MA2411B	0917070	300MHz~40GHz	Jan. 02, 2025	Mar. 10, 2025~Mar. 13, 2025	Jan. 01, 2026	Conducted (TH01-KS)
Power Meter	Anritsu	ML2495A	1005002	50MHz Bandwidth	Jan. 02, 2025	Mar. 10, 2025~Mar. 13, 2025	Jan. 01, 2026	Conducted (TH01-KS)
EMI Receiver	R&S	ESC17	100768	9kHz~7GHz;	Apr. 18, 2025	Apr. 23, 2025	Apr. 17, 2026	Conduction (CO01-KS)
AC LISN (for auxiliary equipment)	MessTec	AN3016	060103	9kHz~30MHz	Aug. 20, 2025	Apr. 23, 2025	Aug. 19, 2026	Conduction (CO01-KS)
AC LISN	MessTec	AN3016	060105	9kHz~30MHz	Apr. 18, 2025	Apr. 23, 2025	Apr. 17, 2026	Conduction (CO01-KS)
AC Power Source	Chroma	61602	ABP00000811	AC 0V~300V, 45Hz~1000Hz	Oct. 09, 2024	Apr. 23, 2025	Oct. 08, 2025	Conduction (CO01-KS)

NCR: No Calibration Required



5 Measurement Uncertainty

The measurement uncertainties shown below were calculated in accordance with the requirements of ANSI 63.10-2013. All the measurement uncertainty value were shown with a coverage K=2 to indicate 95% level of confidence. The measurement data show herein meets or exceeds the CISPR measurement uncertainty values specified in CISPR 16-4-2 and can be compared directly to specified limit to determine compliance.

Uncertainty of Conducted Measurement

Conducted Spurious Emission & Bandedge	±2.26 dB
Occupied Channel Bandwidth	±0.1%
Conducted Power	±0.50 dB
Frequency	±0.04ppm

Uncertainty of AC Conducted Emission Measurement (0.15 MHz ~ 30 MHz)

Measuring Uncertainty for a Level of Confidence of 95% (U = 2Uc(y))	2.84 dB
---	---------

Uncertainty of Radiated Emission Measurement (9 KHz ~ 30 MHz)

Measuring Uncertainty for a Level of Confidence of 95% (U = 2Uc(y))	3.30 dB
---	---------

Uncertainty of Radiated Emission Measurement (30 MHz ~ 1000 MHz)

Measuring Uncertainty for a Level of Confidence of 95% (U = 2Uc(y))	6.06 dB
---	---------

Uncertainty of Radiated Emission Measurement (1 GHz ~ 18 GHz)

Measuring Uncertainty for a Level of Confidence of 95% (U = 2Uc(y))	5.18 dB
---	---------

Uncertainty of Radiated Emission Measurement (18 GHz ~ 40 GHz)

Measuring Uncertainty for a Level of Confidence of 95% (U = 2Uc(y))	5.38 dB
---	---------

----- THE END -----



Appendix A. Conducted Test Results



Ambient Condition: <u>25 °C, 45 %RH</u>
Test Date: <u>2025.3.10~2025.3.13</u> Test Engineer: <u>Jiang Jun</u>

20dB Emission Bandwidth

Test Result

TestMode	Antenna	Freq(MHz)	20dB EBW[MHz]	FL[MHz]	FH[MHz]	Limit[MHz]	Verdict
DH5	Ant1	2402	0.95	2401.51	2402.46	---	---
		2441	0.95	2440.51	2441.46	---	---
		2480	0.95	2479.51	2480.47	---	---
2DH1	Ant1	2402	1.27	2401.33	2402.61	---	---
		2441	1.27	2440.33	2441.61	---	---
		2480	1.28	2479.32	2480.61	---	---
3DH1	Ant1	2402	1.25	2401.36	2402.61	---	---
		2441	1.24	2440.37	2441.61	---	---
		2480	1.24	2479.38	2480.61	---	---



Test Graphs

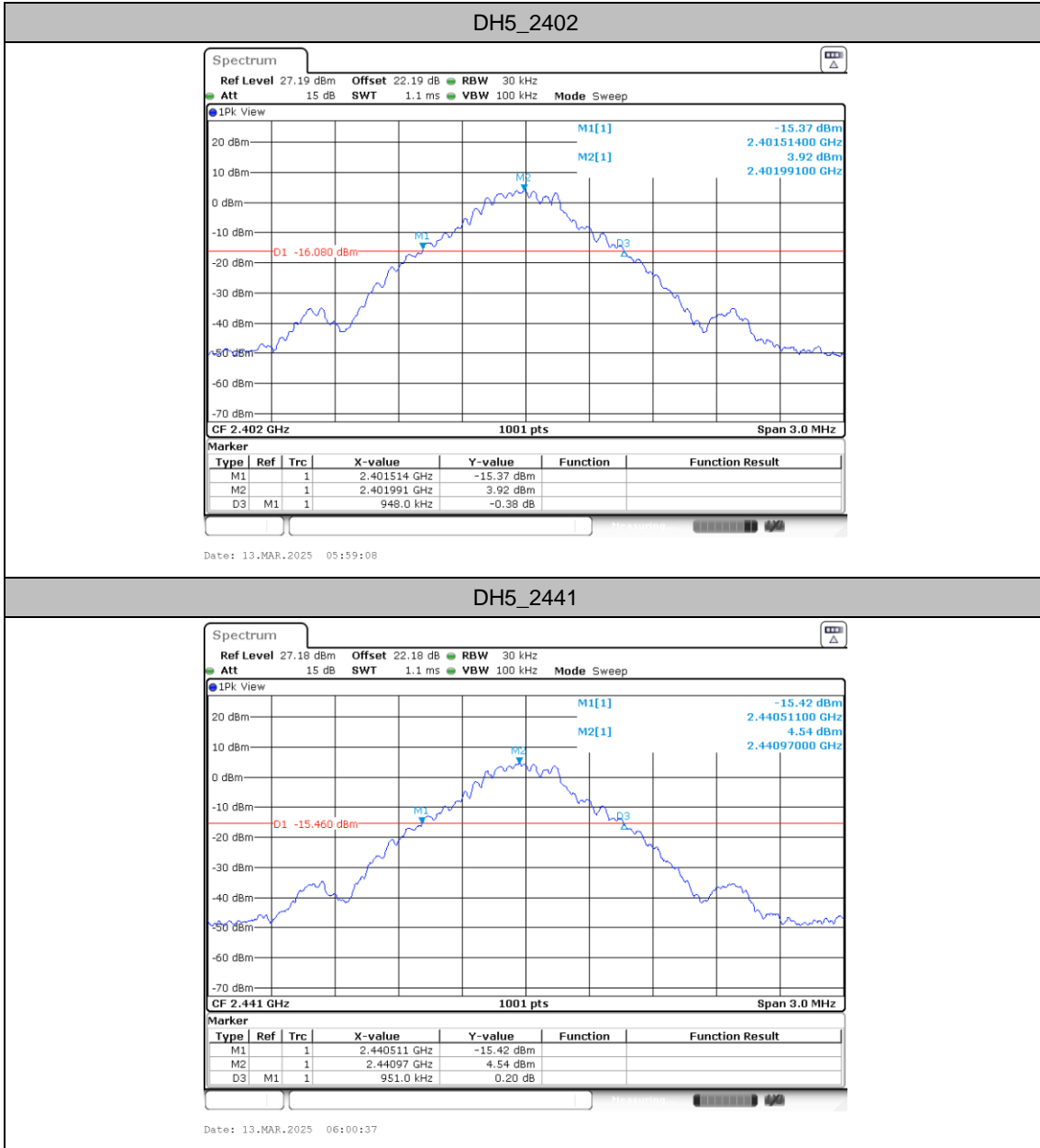

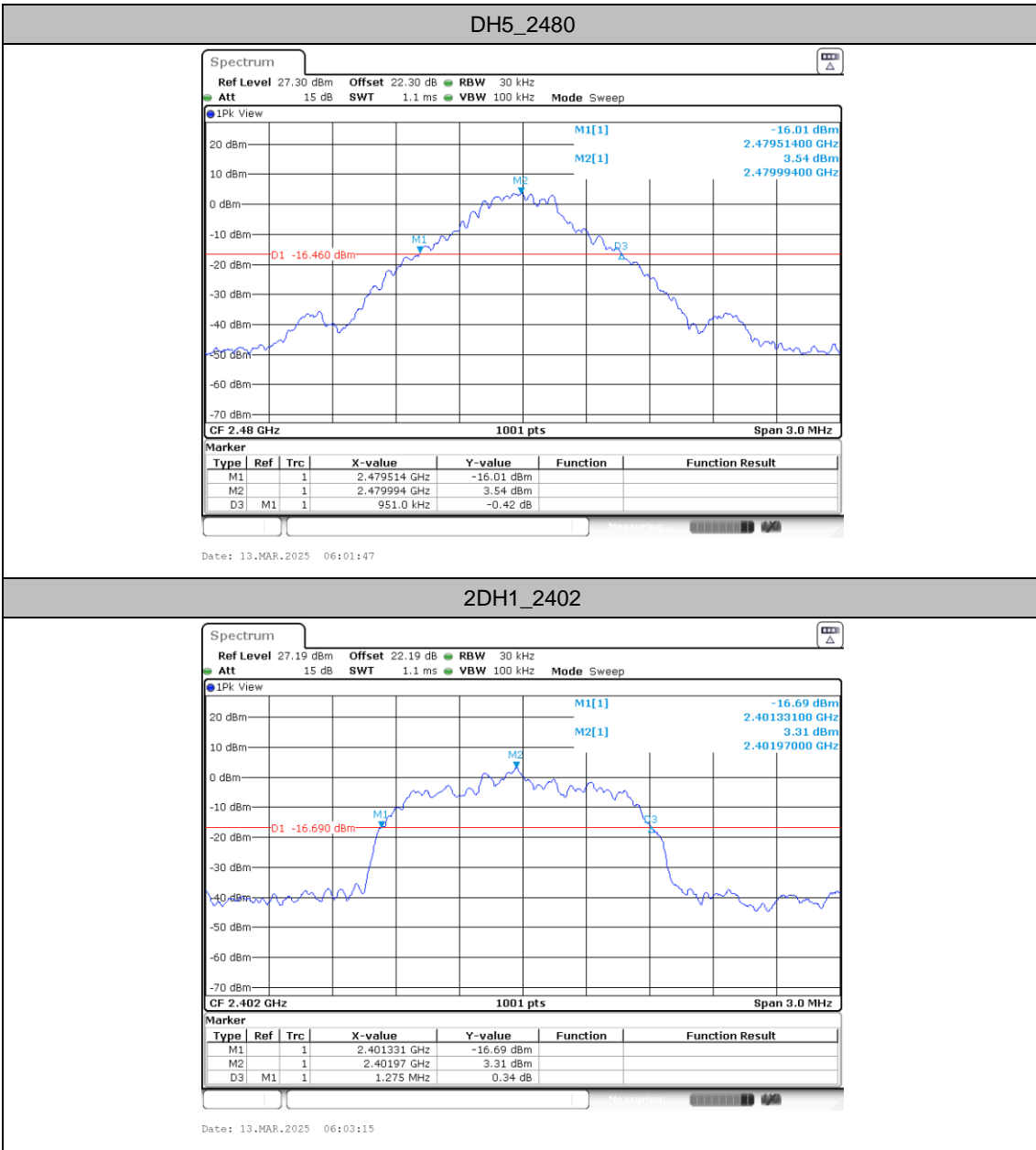

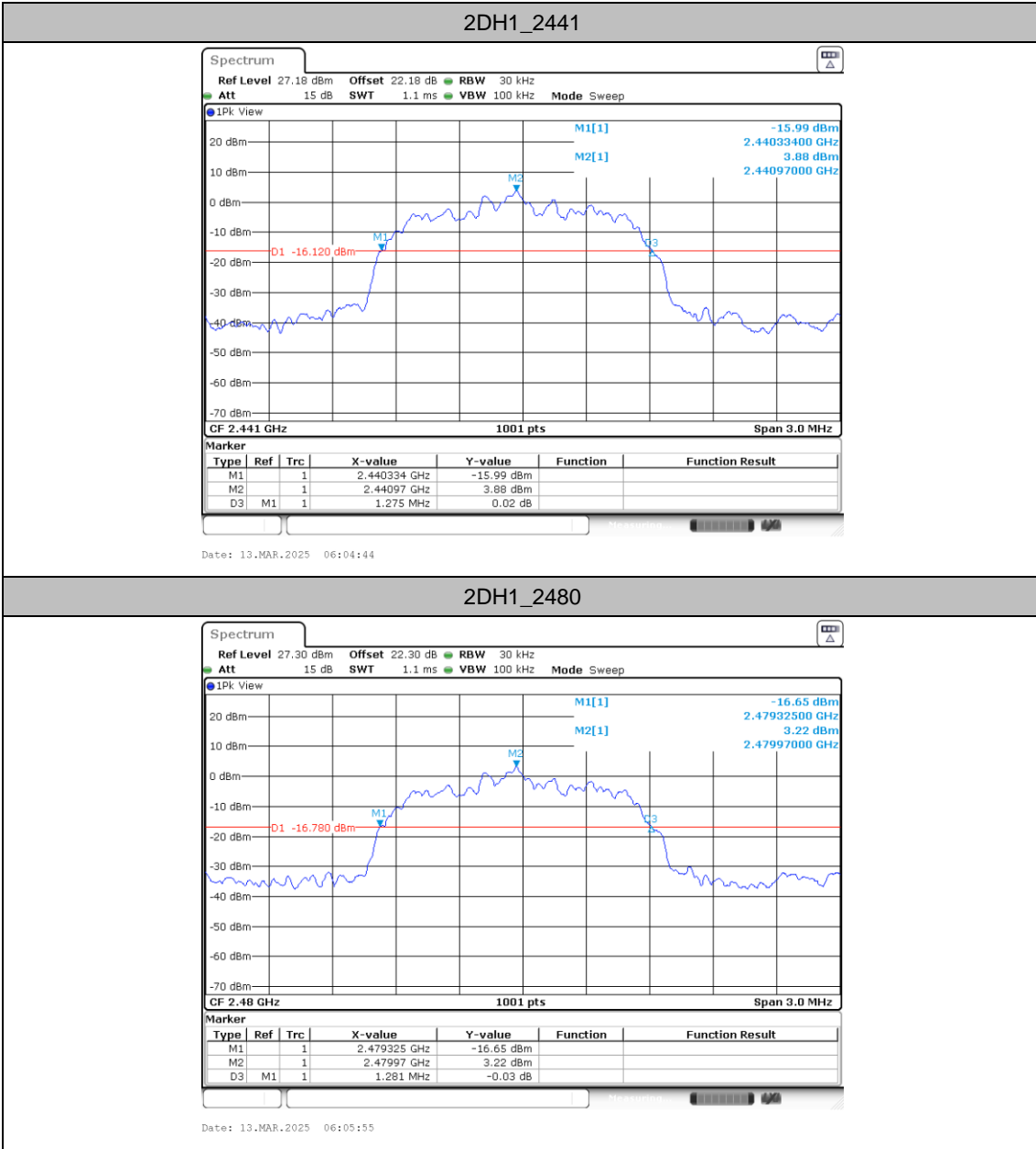

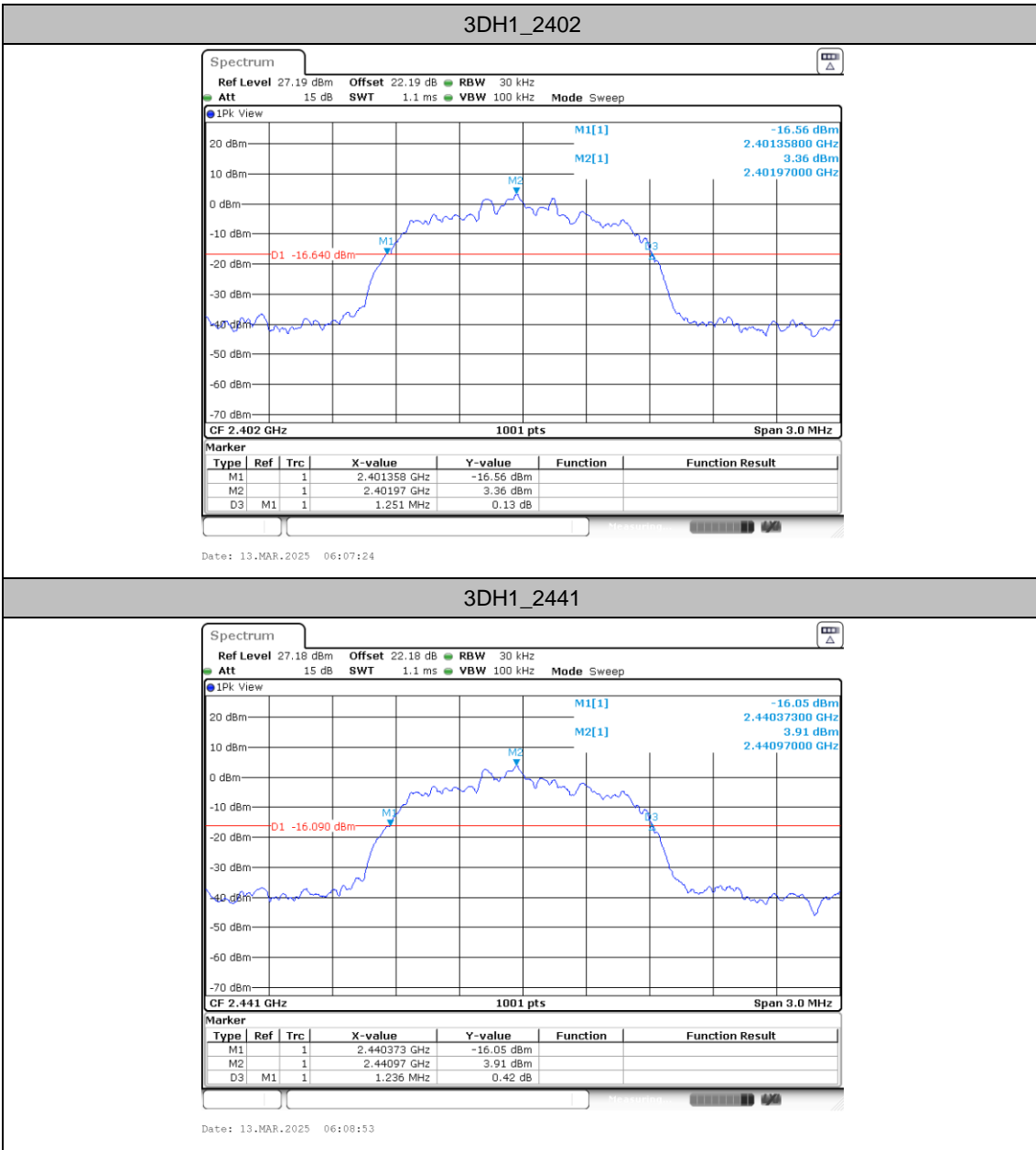

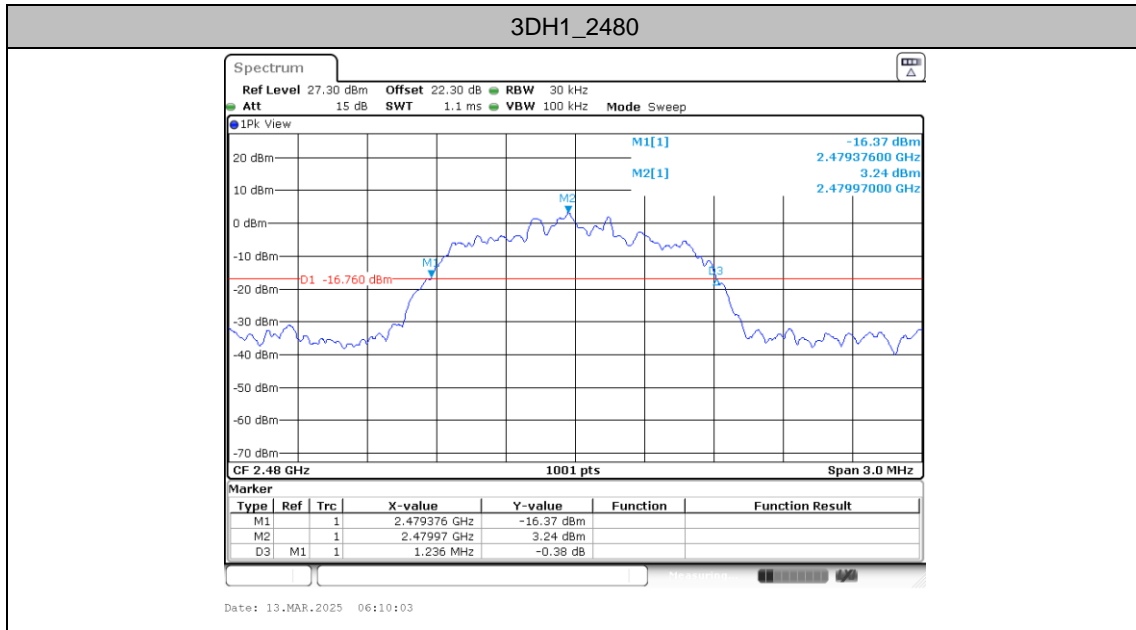



Occupied Channel Bandwidth

Test Result

TestMode	Antenna	Freq(MHz)	OCB [MHz]	FL[MHz]	FH[MHz]	Limit[MHz]	Verdict
DH5	Ant1	2402	0.863	2401.5445	2402.4076	---	---
		2441	0.869	2440.5445	2441.4136	---	---
		2480	0.869	2479.5445	2480.4136	---	---
2DH1	Ant1	2402	1.166	2401.3886	2402.5544	---	---
		2441	1.166	2440.3886	2441.5544	---	---
		2480	1.172	2479.3856	2480.5574	---	---
3DH1	Ant1	2402	1.151	2401.4126	2402.5634	---	---
		2441	1.154	2440.4126	2441.5664	---	---
		2480	1.160	2479.4126	2480.5724	---	---



Test Graphs

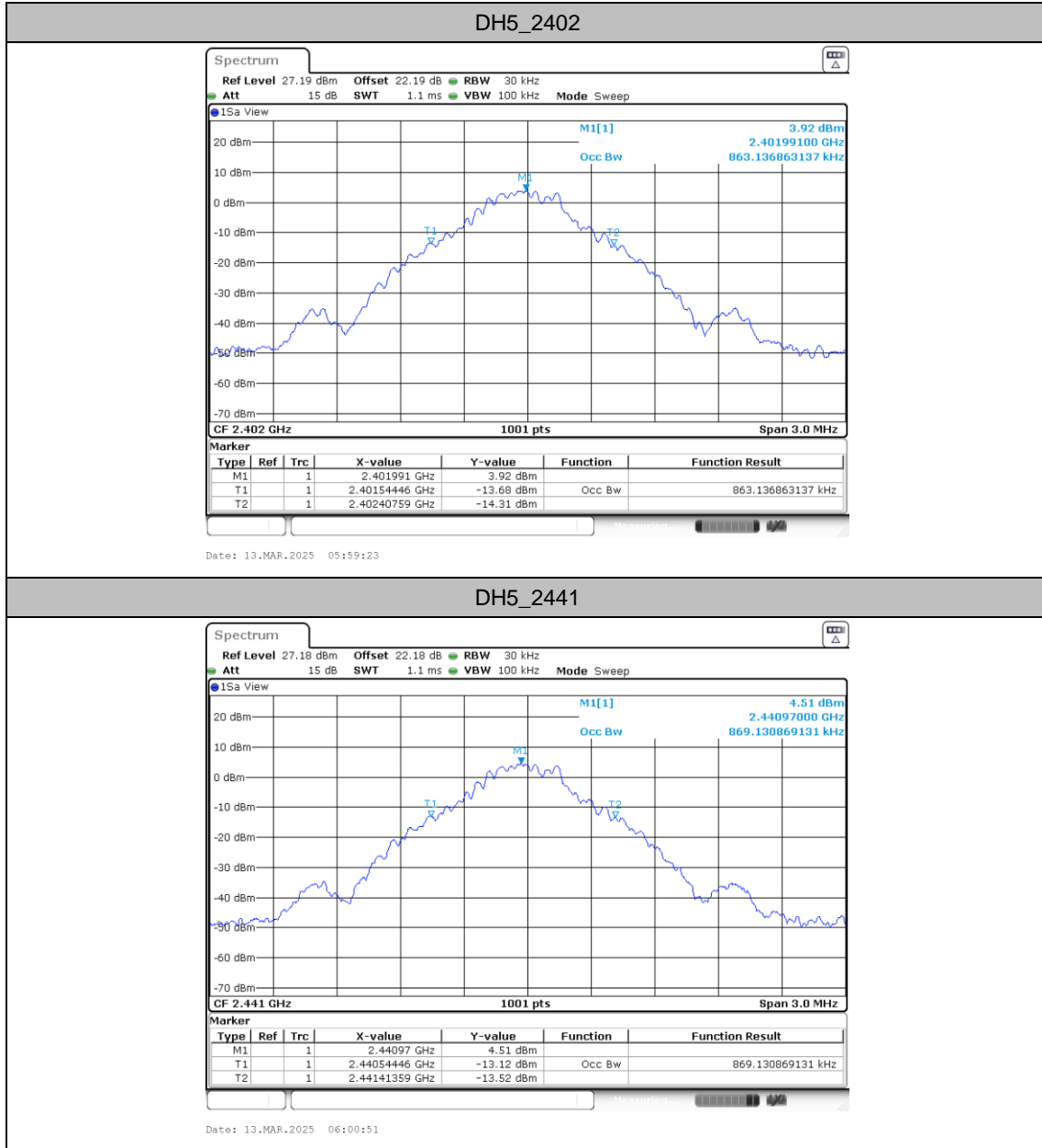

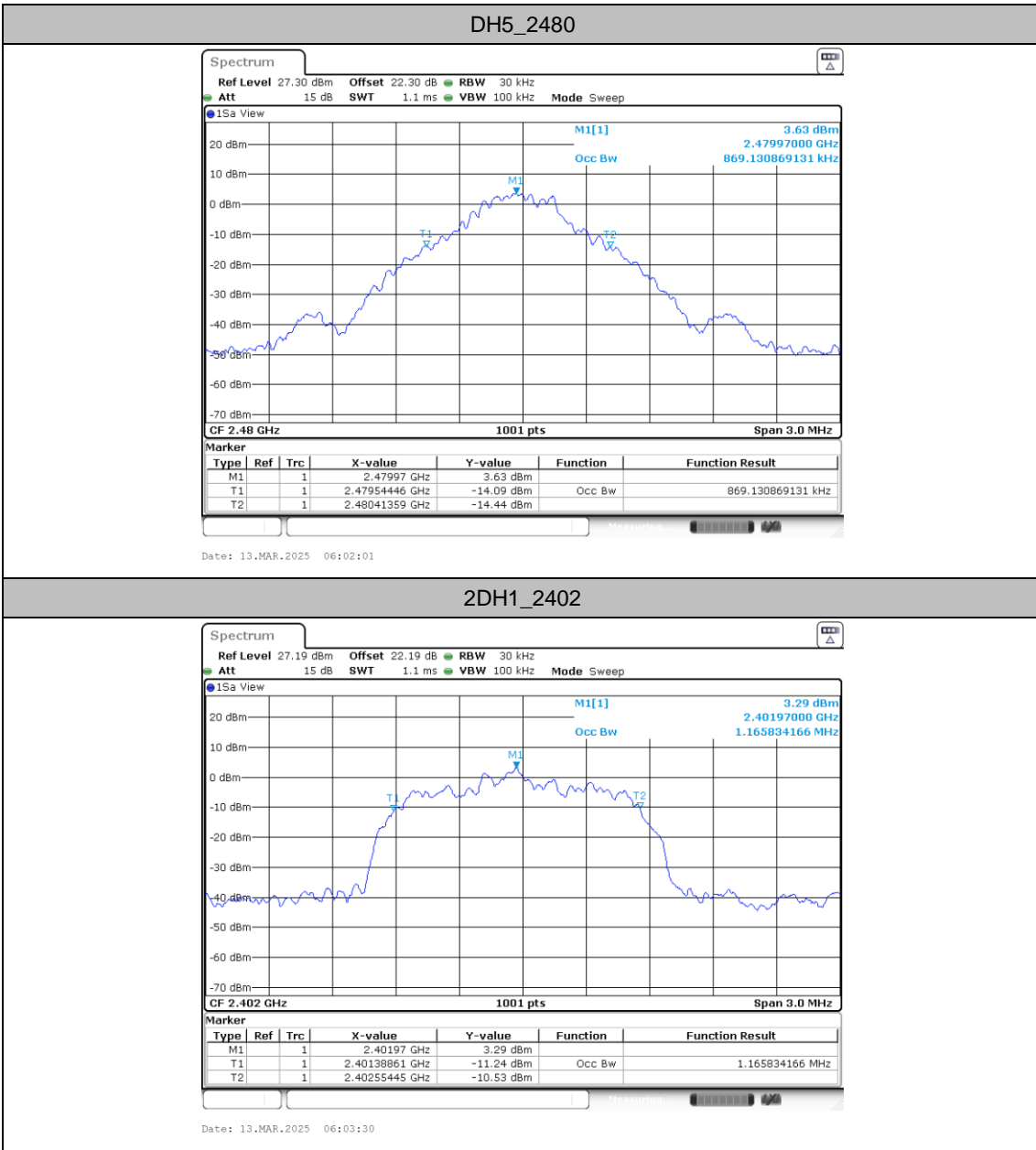

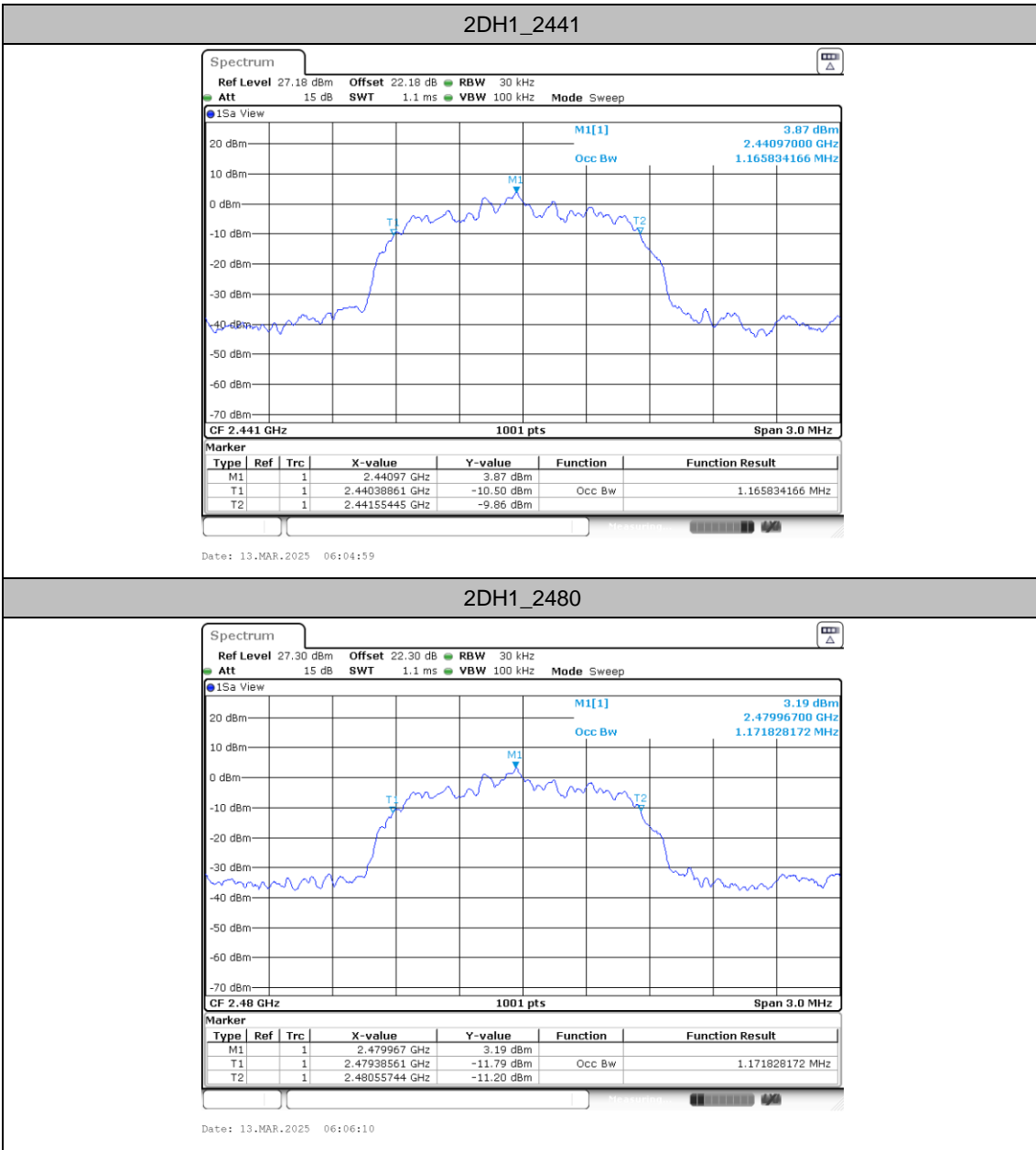

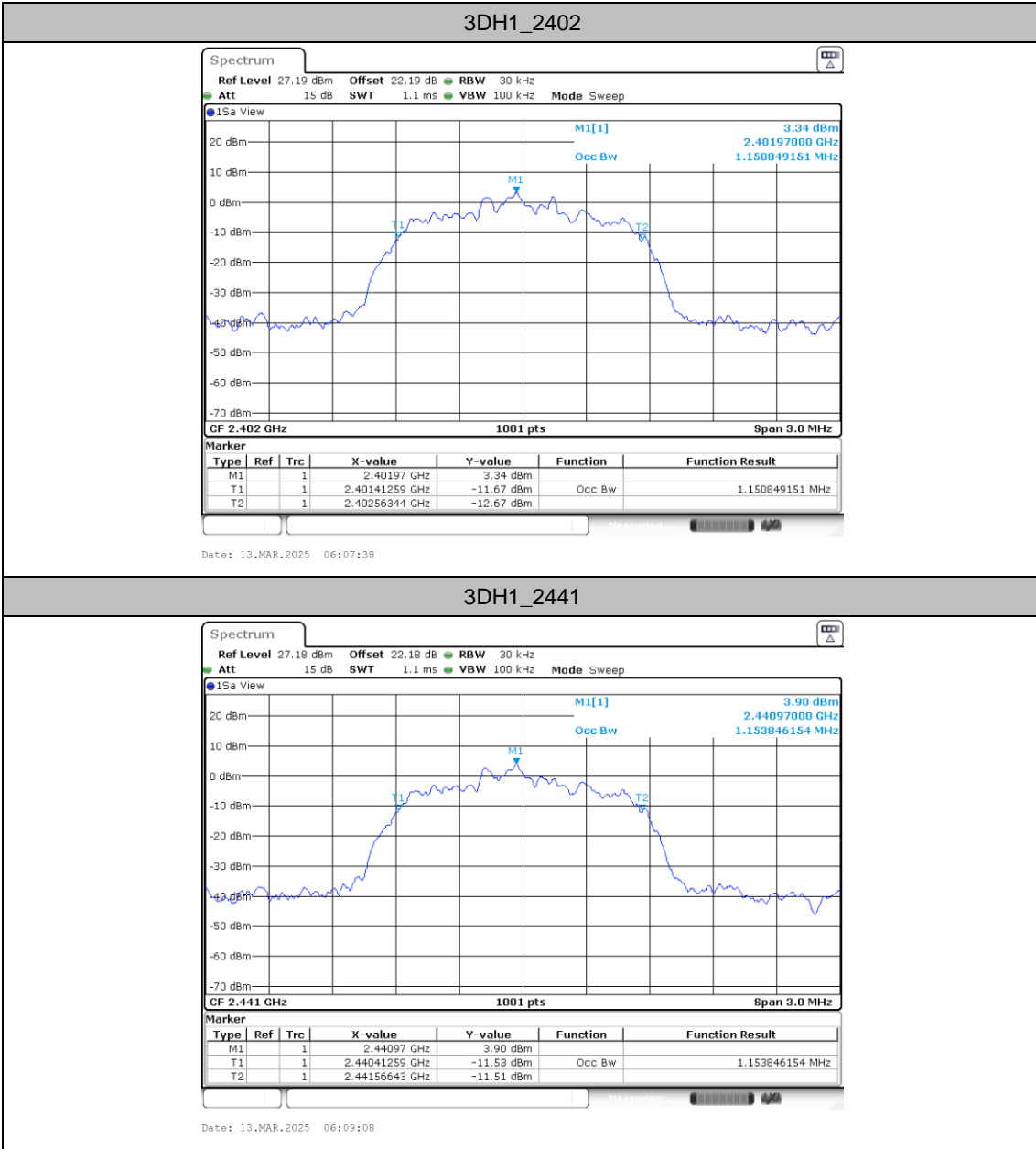

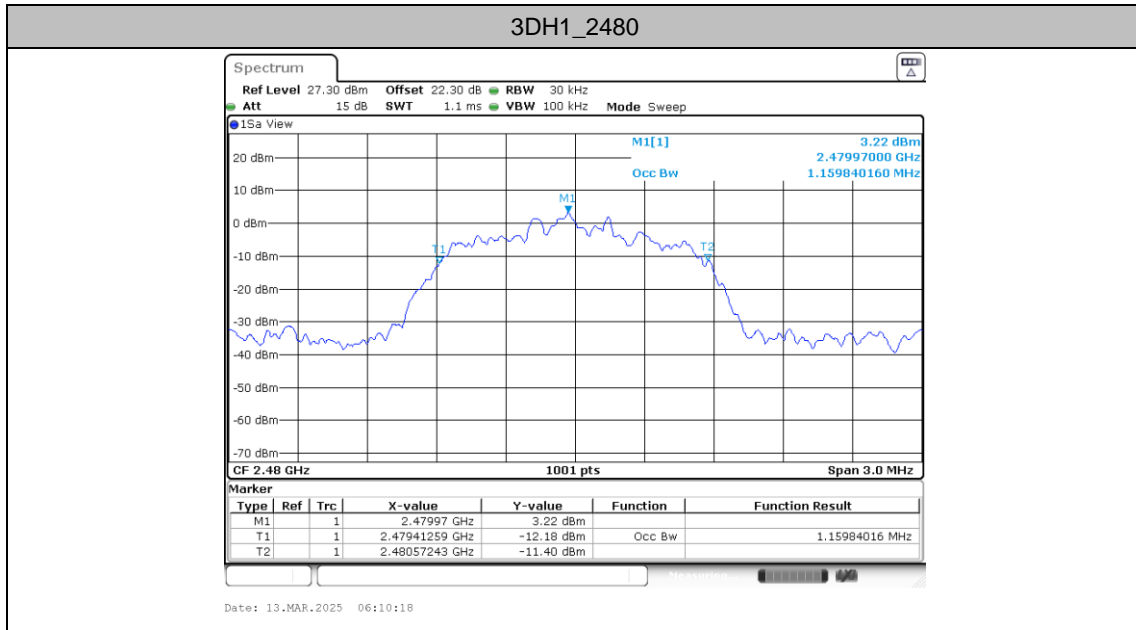



Maximum conducted output power

Test Result Peak

TestMode	Antenna	CH.	Peak Power (dBm)	Power Limit (dBm)	Pass/Fail
DH5	Ant1	0	7.34	20.97	Pass
		39	8.45	20.97	Pass
		78	7.49	20.97	Pass
2DH1	Ant1	0	8.39	20.97	Pass
		39	9.62	20.97	Pass
		78	8.39	20.97	Pass
3DH1	Ant1	0	8.71	20.97	Pass
		39	9.99	20.97	Pass
		78	8.66	20.97	Pass

Note: Power setting is default.

Carrier frequency separation

Test Result

TestMode	Antenna	Freq(MHz)	Result[MHz]	Limit[MHz]	Verdict
DH5	Ant1	2402	1.013	≥0.633	PASS
		2441	1.009	≥0.633	PASS
		2480	1.004	≥0.633	PASS
2DH1	Ant1	2402	1.004	≥0.847	PASS
		2441	1.013	≥0.847	PASS
		2480	1.009	≥0.853	PASS
3DH1	Ant1	2402	0.991	≥0.833	PASS
		2441	1.017	≥0.827	PASS
		2480	1.004	≥0.827	PASS



Test Graphs

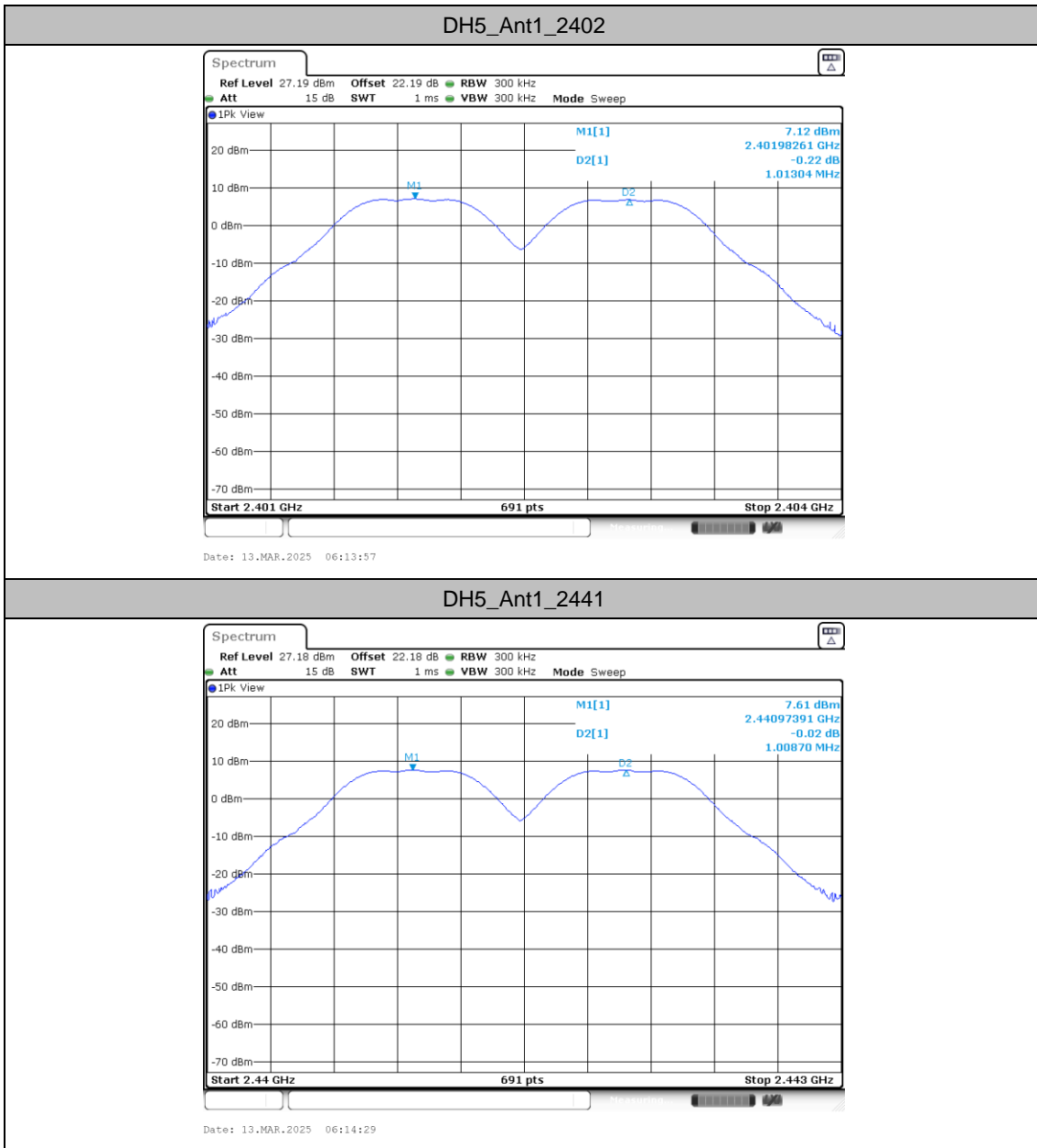



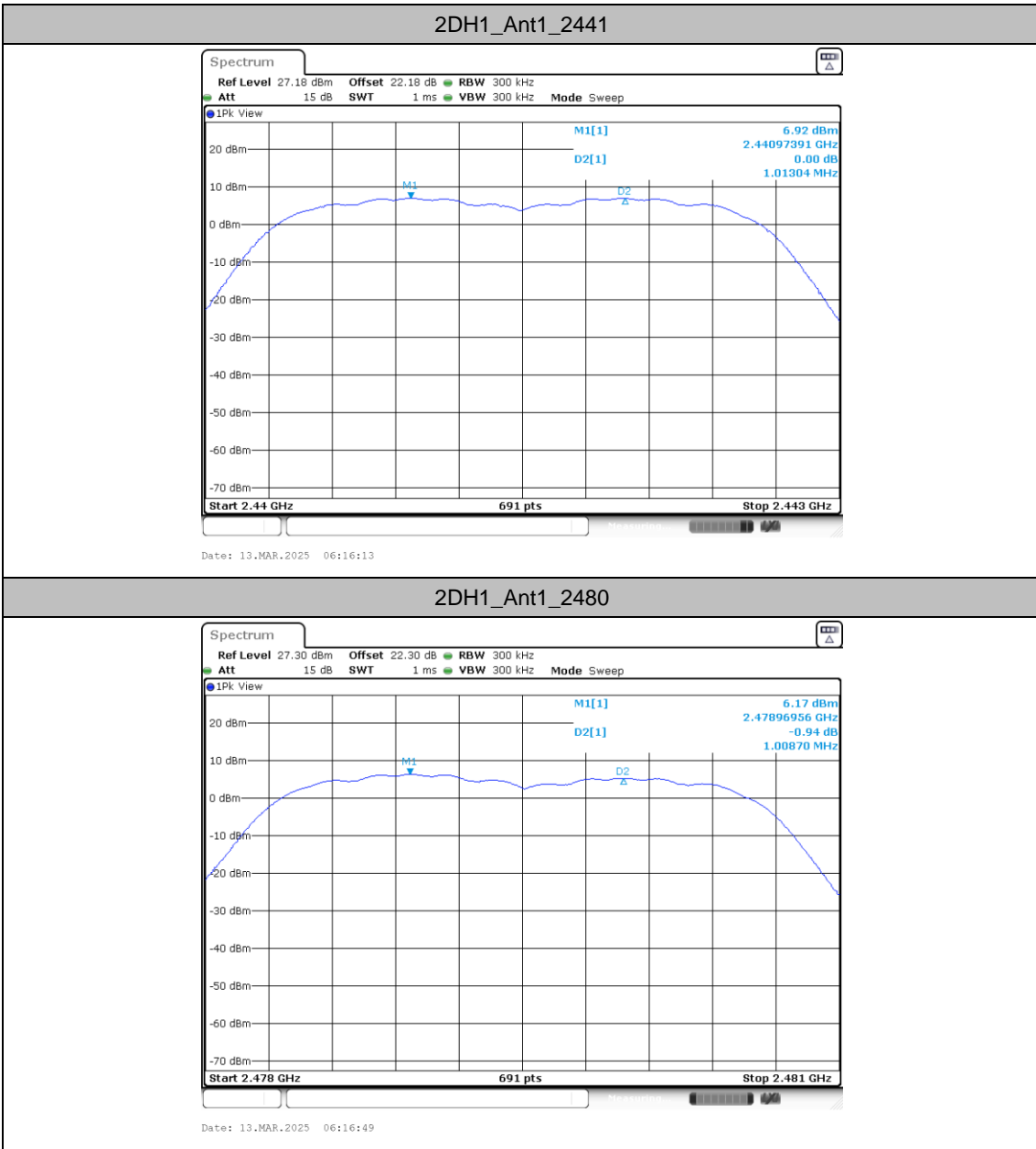

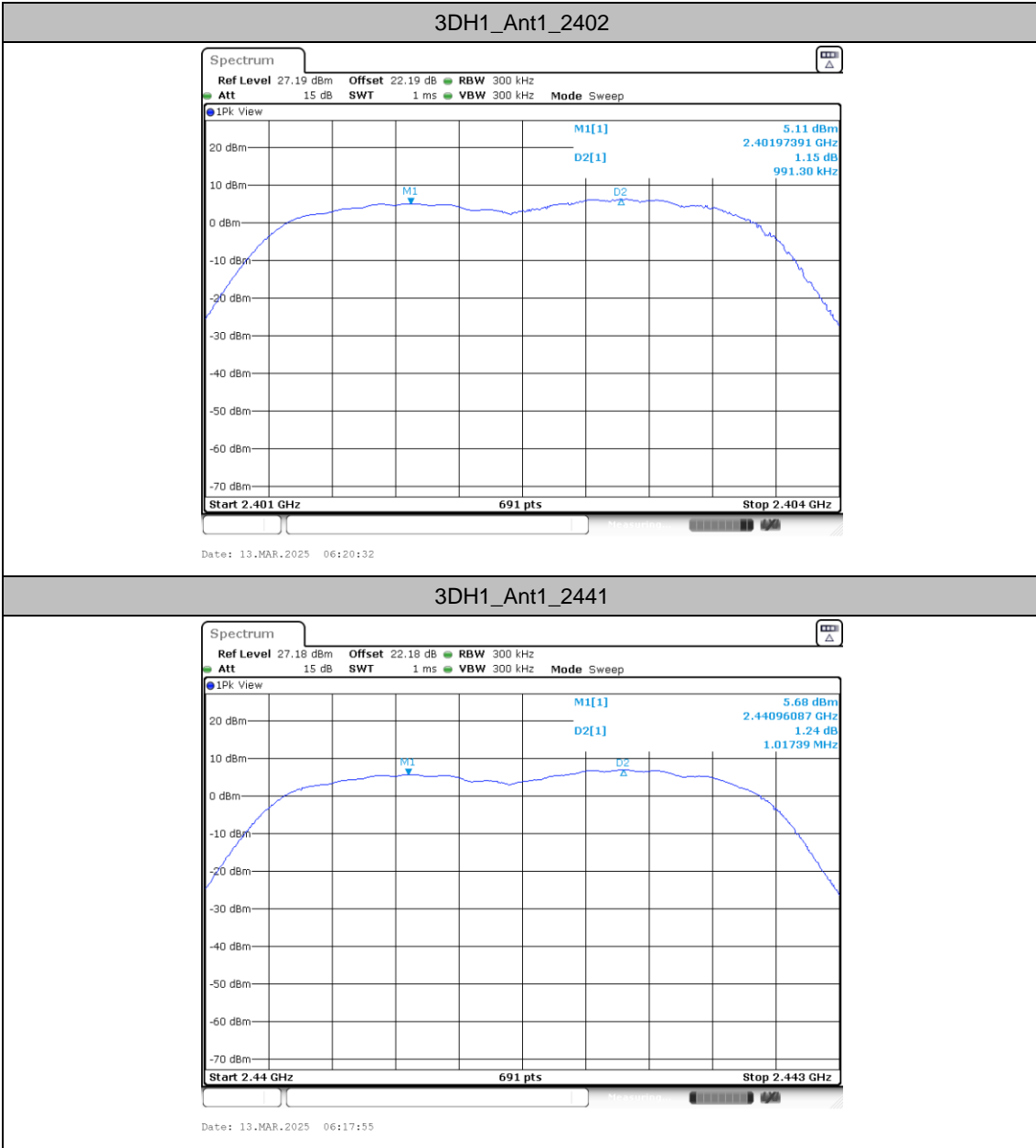

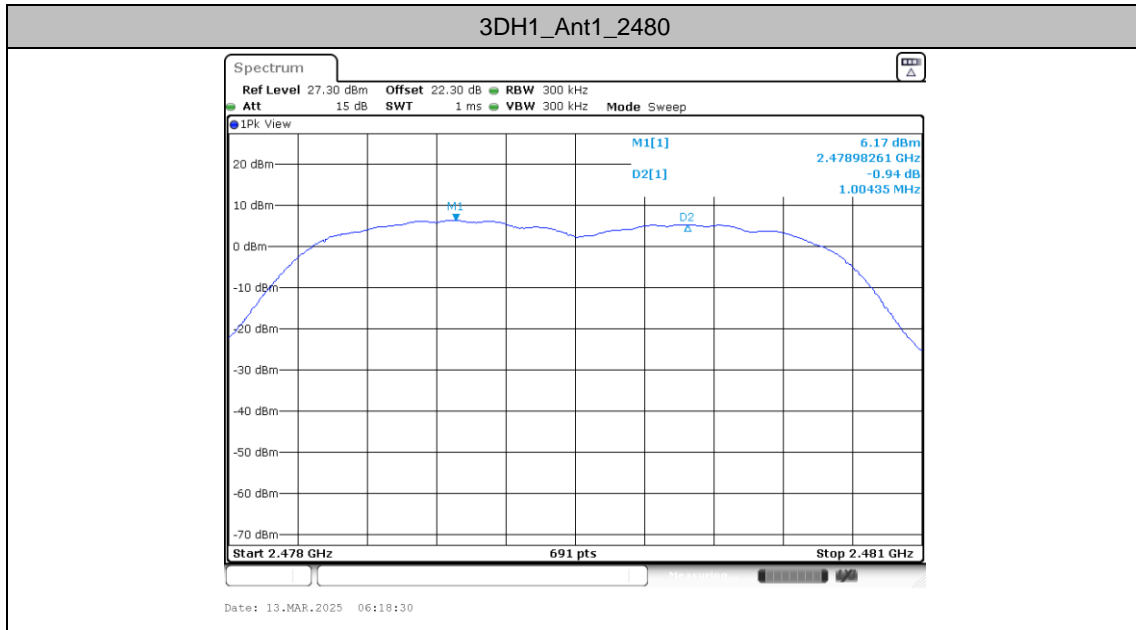



Time of occupancy

Test Result

TestMode	Antenna	Hopping Channel Number Rate	Hops Over Occupancy Time(hops)	Package Transfer Time (msec) (MHz)	Dwell Time (sec)	Limits (sec)	Pass/Fail
Normal	Ant1	79	106.67	2.8986	0.31	0.4	Pass
AFH	Ant1	20	53.33	2.8986	0.15	0.4	Pass

Remark:

1. In normal mode, hopping rate is 1600 hops/s with 6 slots (5 Transmit and 1 Receive slot) in 79 hopping channels.
2. With channel hopping rate (1600 / 6 / 79) in Occupancy Time Limit (0.4 x 79) (s), Hops Over Occupancy Time comes to (1600 / 6 / 79) x (0.4 x 79) = 106.67 hops.
In AFH mode, hopping rate is 800 hops/s with 6 slots in 20 hopping channels.
3. With channel hopping rate (800 / 6 / 20) in Occupancy Time Limit (0.4 x 20) (s), Hops Over Occupancy Time comes to (800 / 6 / 20) x (0.4 x 20) = 53.33 hops.
Dwell Time(s) = Hops Over Occupancy Time (hops) x Package Transfer Time

Test Graphs

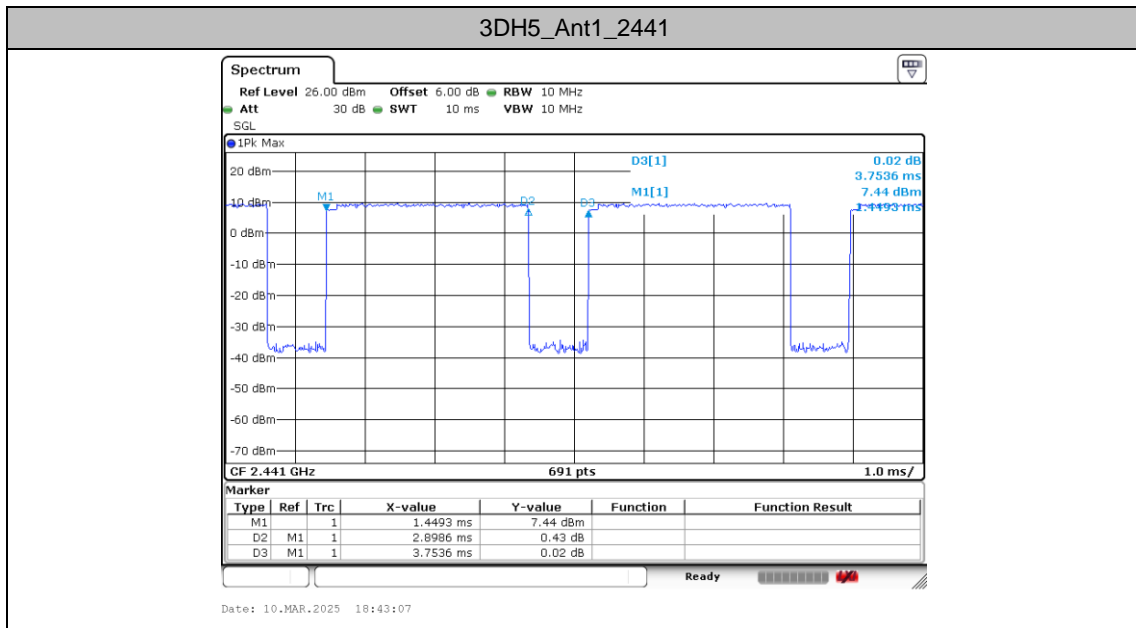



Number of hopping channels

Test Result

TestMode	Antenna	Freq(MHz)	Result[Num]	Limit[Num]	Verdict
DH5	Ant1	Hop	79	≥15	PASS

Test Graphs

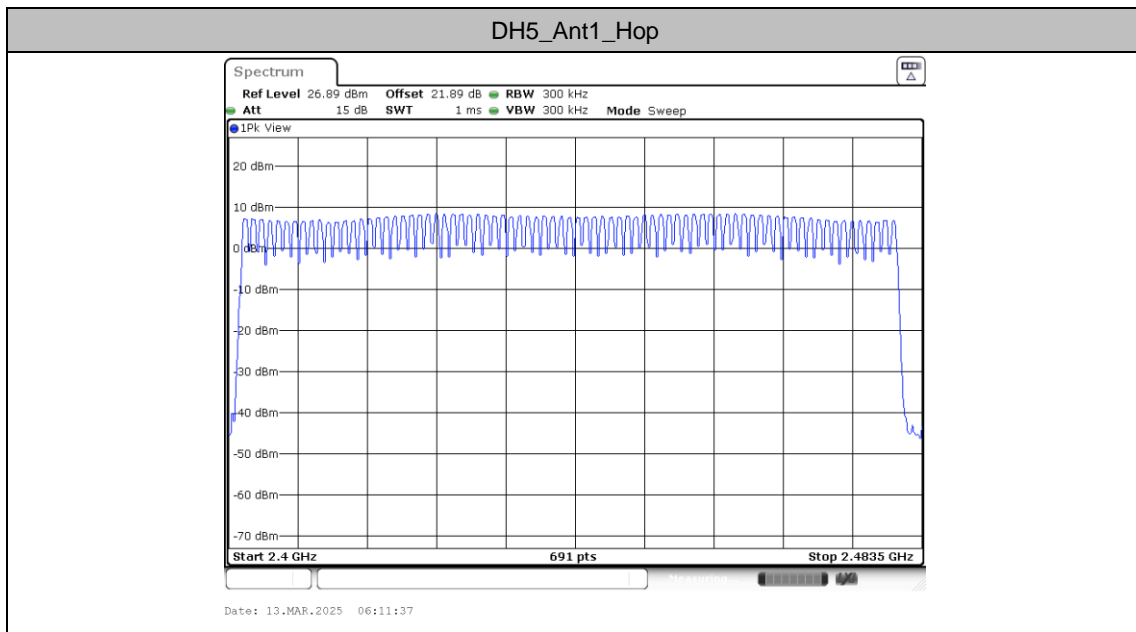



Band edge measurements

Test Result

TestMode	Antenna	ChName	Freq(MHz)	RefLevel [dBm]	Result [dBm]	Limit [dBm]	Verdict
DH5	Ant1	Low	2402	7.00	-46.45	≤-13	PASS
		High	2480	6.60	-47.84	≤-13.4	PASS
		Low	Hop_2402	6.27	-48.47	≤-13.73	PASS
		High	Hop_2480	6.64	-47.55	≤-13.36	PASS
2DH1	Ant1	Low	2402	6.30	-45.73	≤-13.7	PASS
		High	2480	6.17	-48.1	≤-13.83	PASS
		Low	Hop_2402	4.46	-49.05	≤-15.54	PASS
		High	Hop_2480	6.40	-47.84	≤-13.6	PASS
3DH1	Ant1	Low	2402	6.36	-44.2	≤-13.64	PASS
		High	2480	6.20	-47.59	≤-13.8	PASS
		Low	Hop_2402	5.31	-48.73	≤-14.69	PASS
		High	Hop_2480	6.16	-47.99	≤-13.84	PASS



Test Graphs

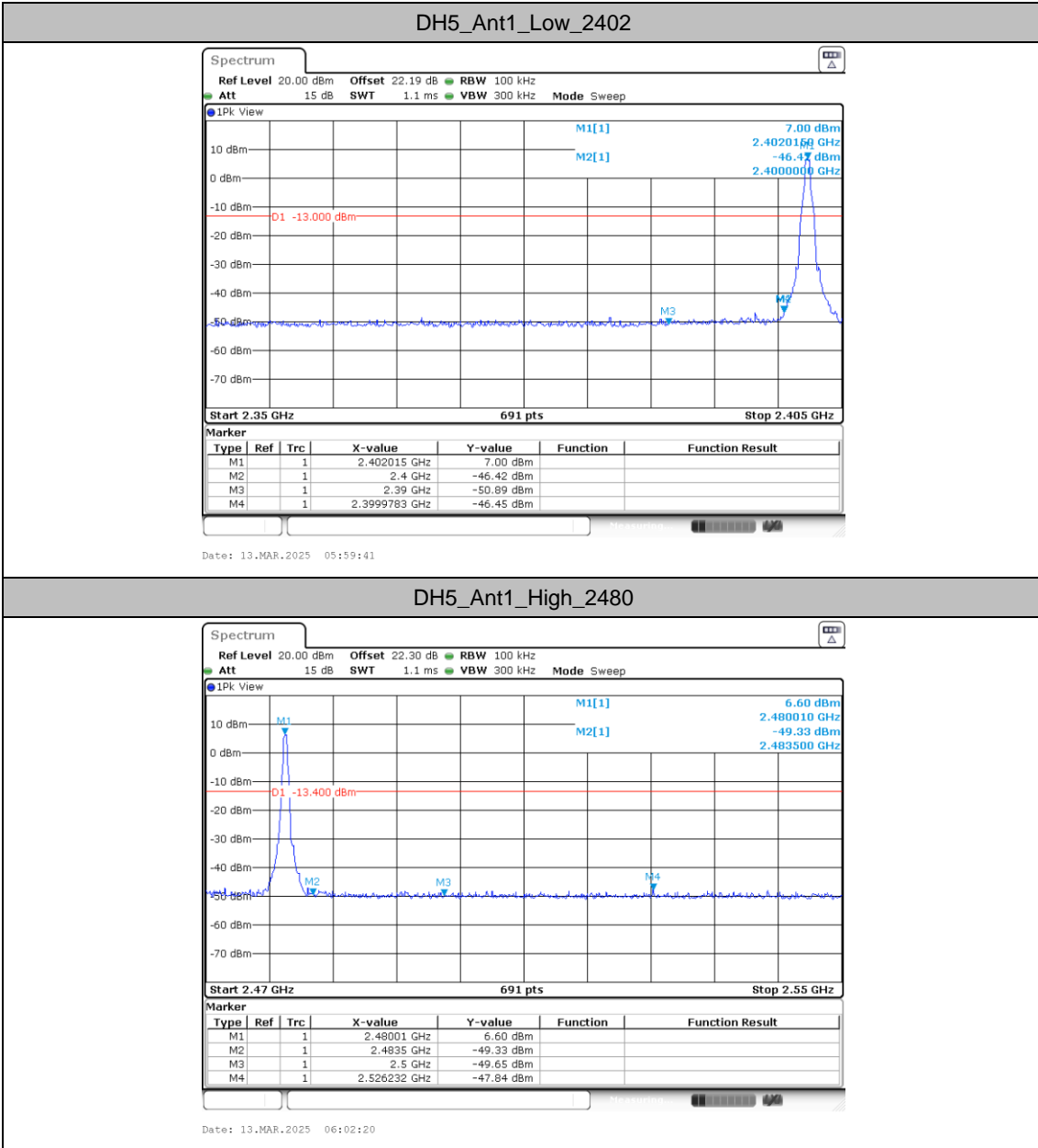

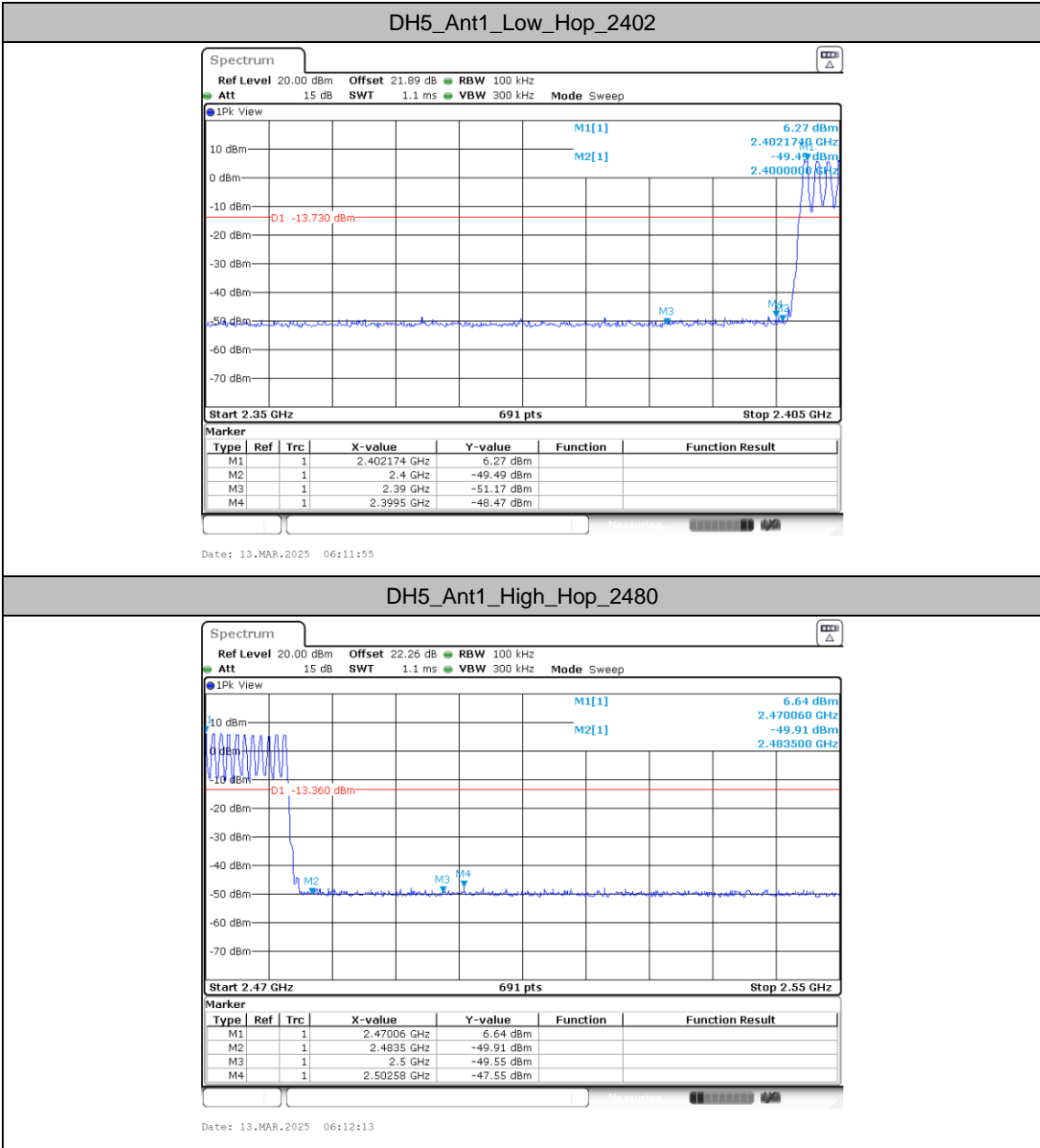

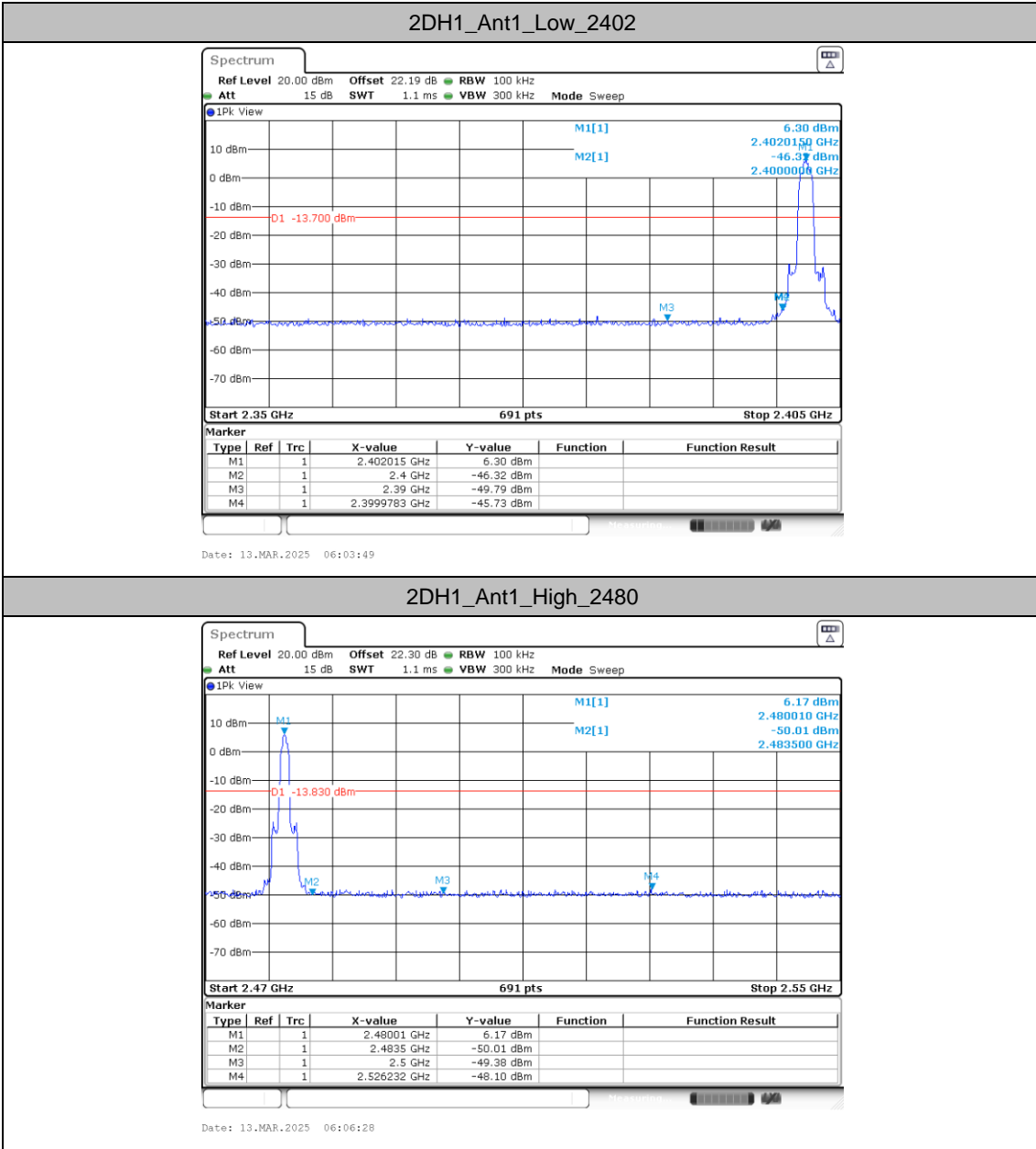

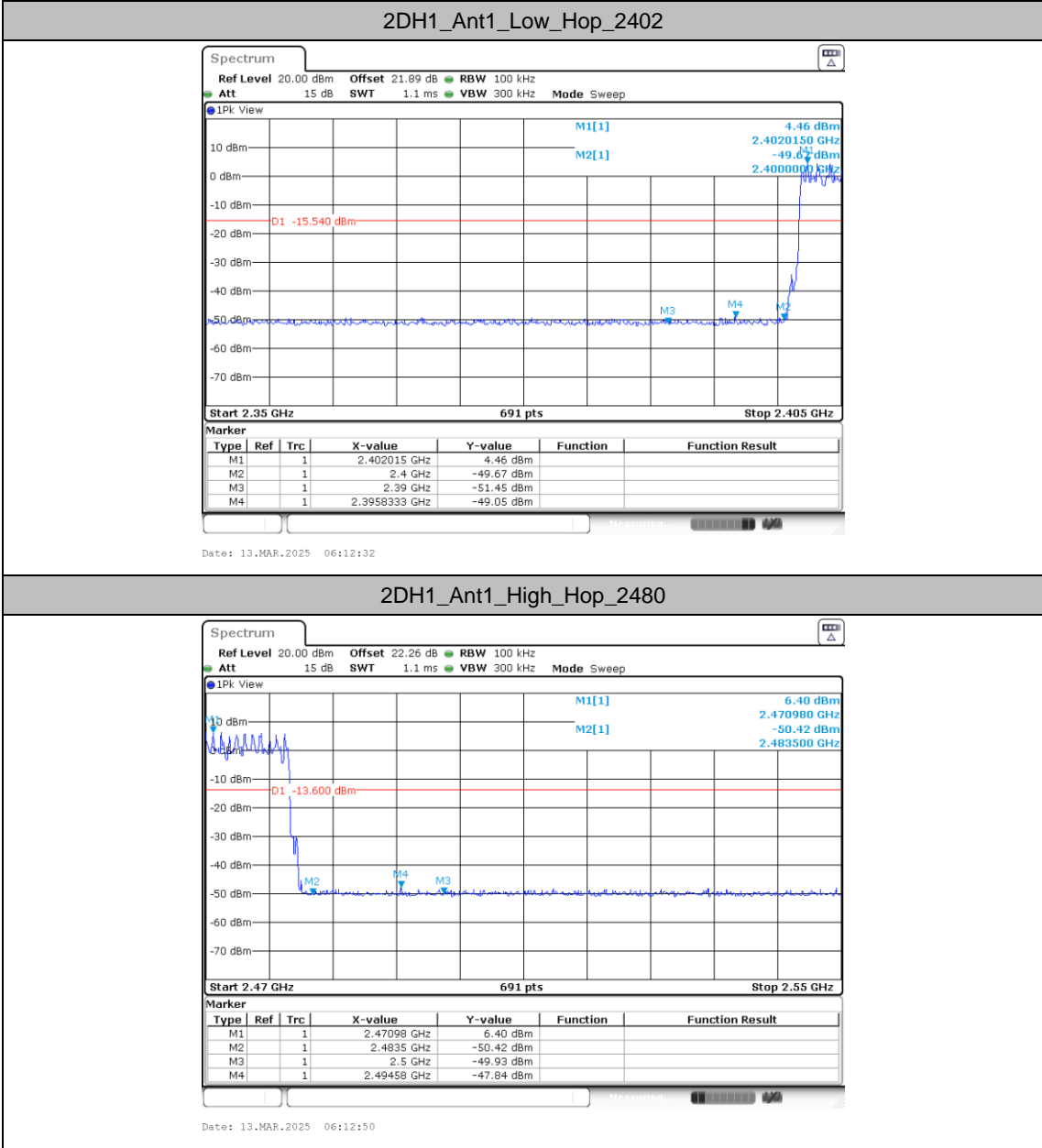

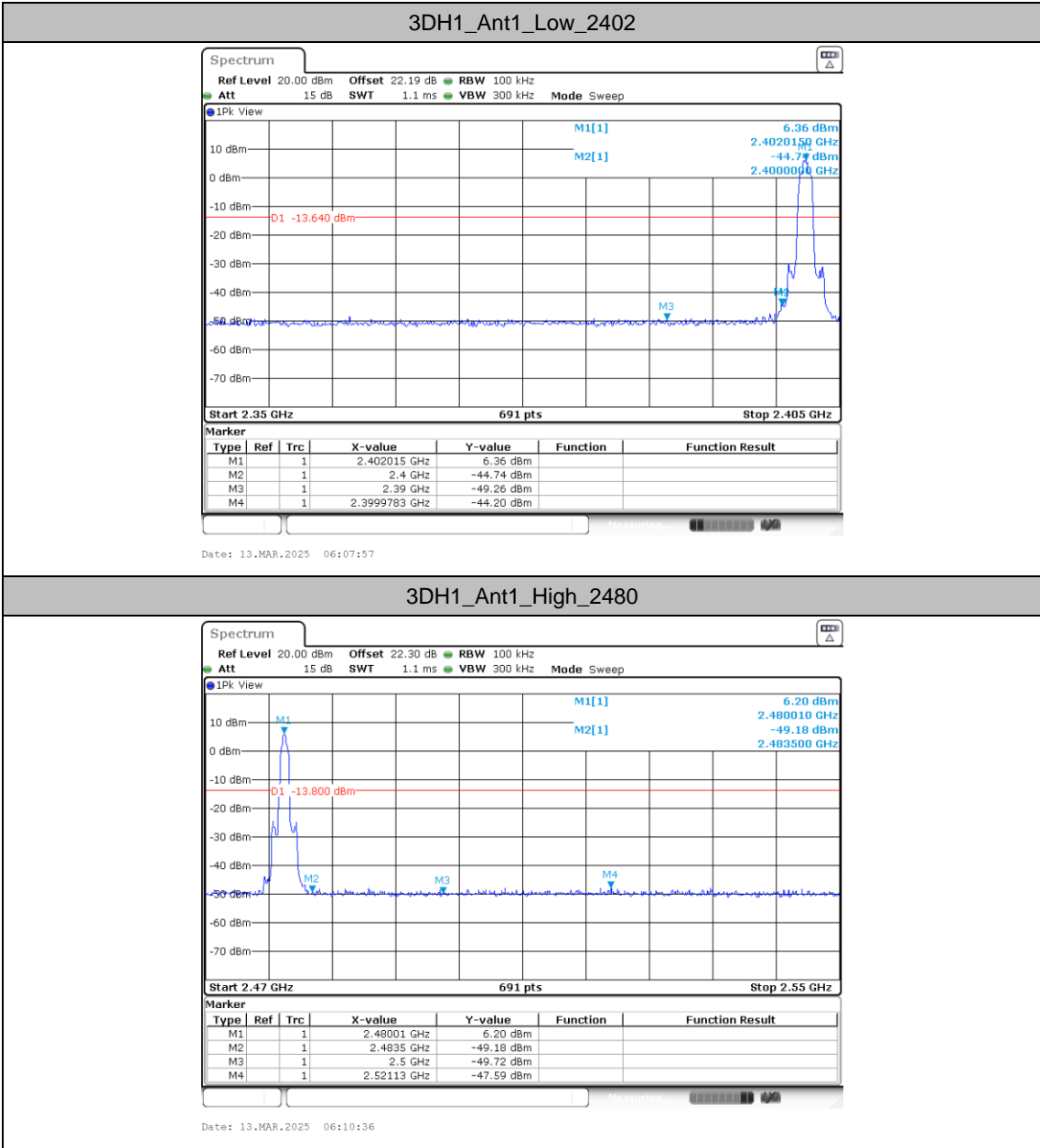

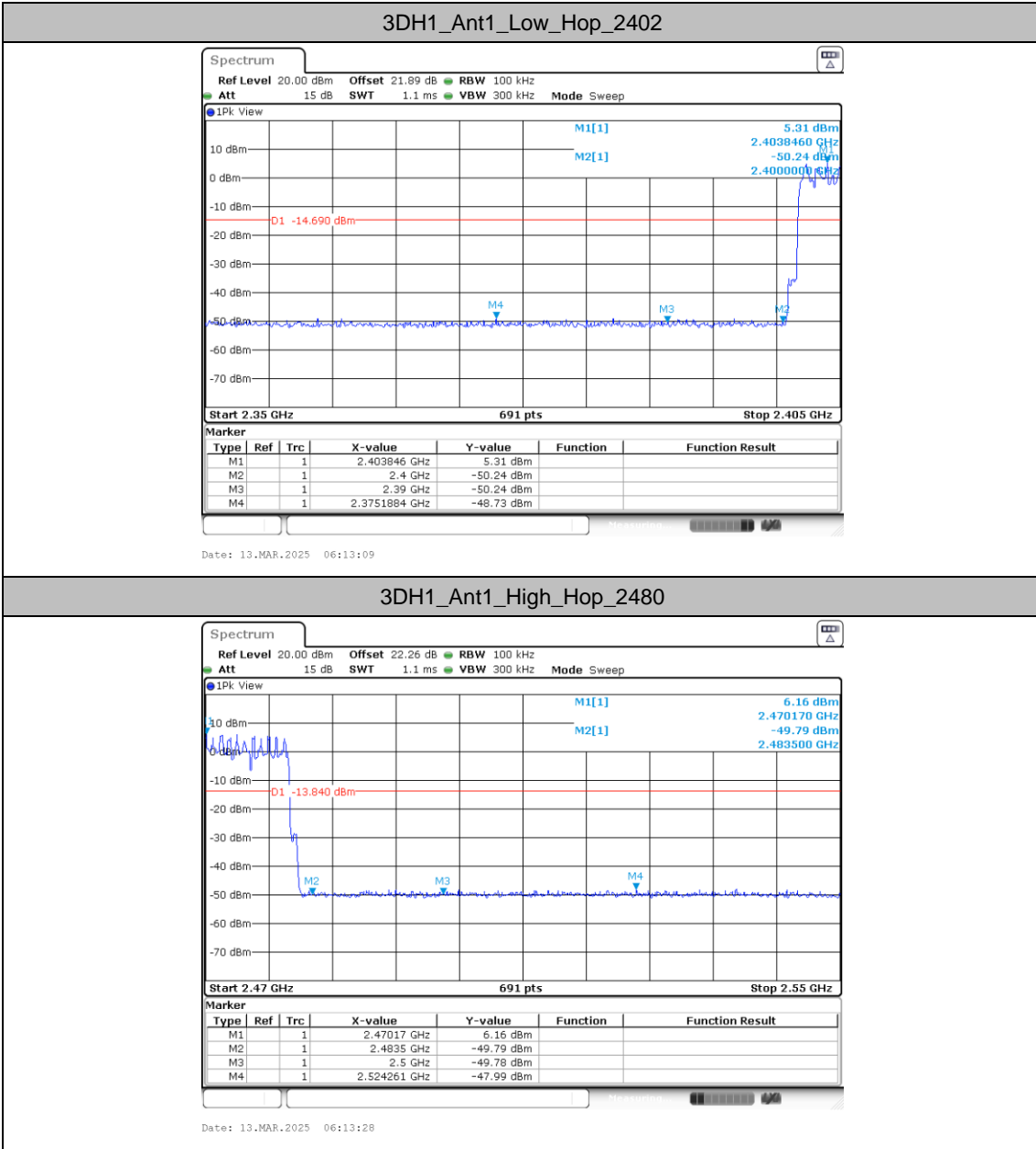



Conducted Spurious Emission

Test Result

TestMode	Antenna	Freq(MHz)	FreqRange [MHz]	RefLevel [dBm]	Result [dBm]	Limit [dBm]	Verdict
DH5	Ant1	2402	Reference	6.83	6.83	---	PASS
			30~1000	6.83	-49.7	≤-13.17	PASS
			1000~26500	6.83	-43.76	≤-13.17	PASS
		2441	Reference	7.47	7.47	---	PASS
			30~1000	7.47	-50.02	≤-12.53	PASS
			1000~26500	7.47	-43.85	≤-12.53	PASS
		2480	Reference	6.63	6.63	---	PASS
			30~1000	6.63	-49.77	≤-13.37	PASS
			1000~26500	6.63	-43.16	≤-13.37	PASS
2DH1	Ant1	2402	Reference	6.18	6.18	---	PASS
			30~1000	6.18	-49.63	≤-13.82	PASS
			1000~26500	6.18	-43.19	≤-13.82	PASS
		2441	Reference	6.84	6.84	---	PASS
			30~1000	6.84	-49.1	≤-13.16	PASS
			1000~26500	6.84	-43.03	≤-13.16	PASS
		2480	Reference	6.23	6.23	---	PASS
			30~1000	6.23	-49.28	≤-13.77	PASS
			1000~26500	6.23	-42.64	≤-13.77	PASS
3DH1	Ant1	2402	Reference	6.23	6.23	---	PASS
			30~1000	6.23	-49.97	≤-13.77	PASS
			1000~26500	6.23	-43.54	≤-13.77	PASS
		2441	Reference	6.89	6.89	---	PASS
			30~1000	6.89	-49.85	≤-13.11	PASS
			1000~26500	6.89	-43.83	≤-13.11	PASS
		2480	Reference	6.25	6.25	---	PASS
			30~1000	6.25	-49.67	≤-13.75	PASS
			1000~26500	6.25	-42.94	≤-13.75	PASS



Test Graphs

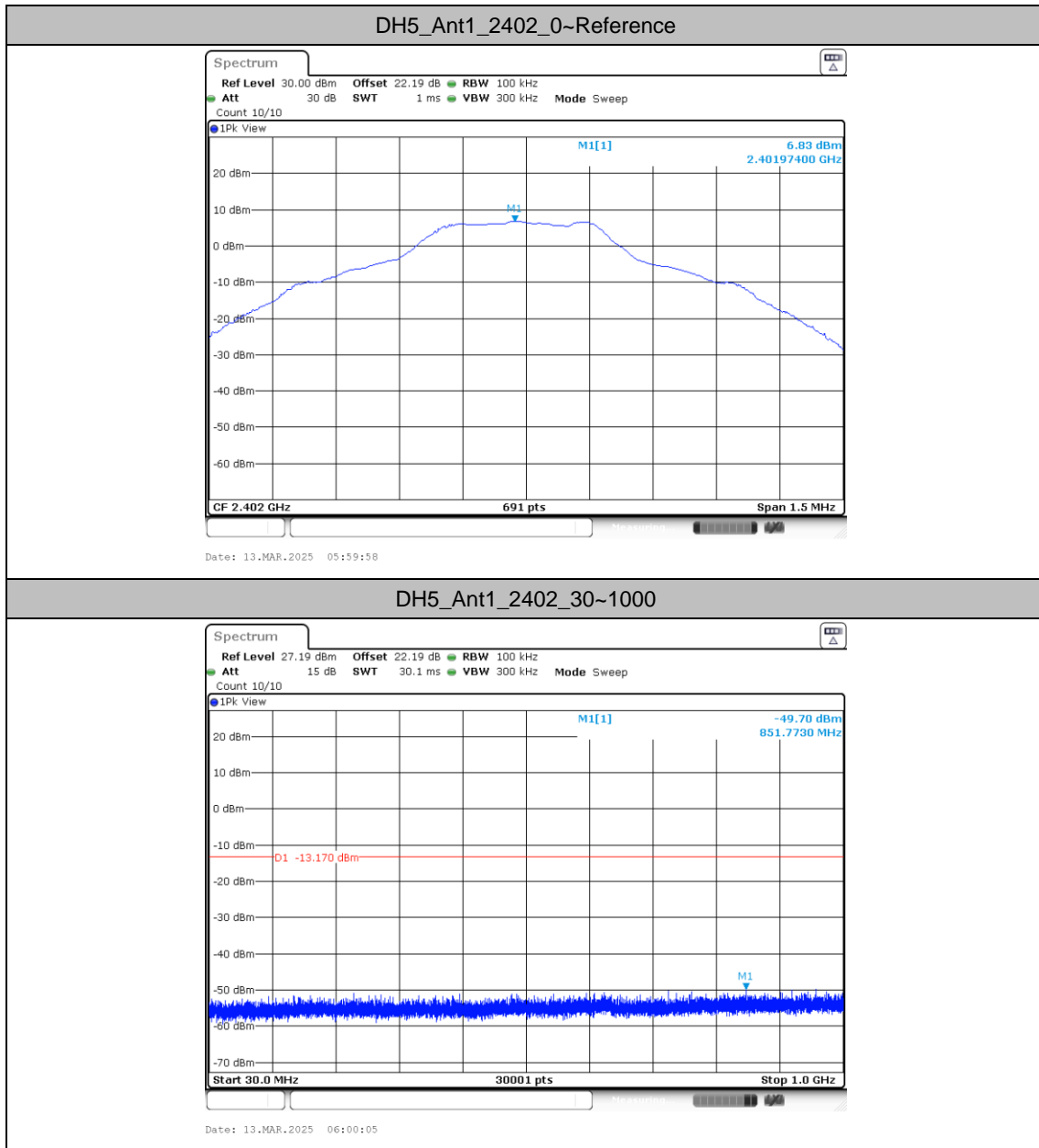

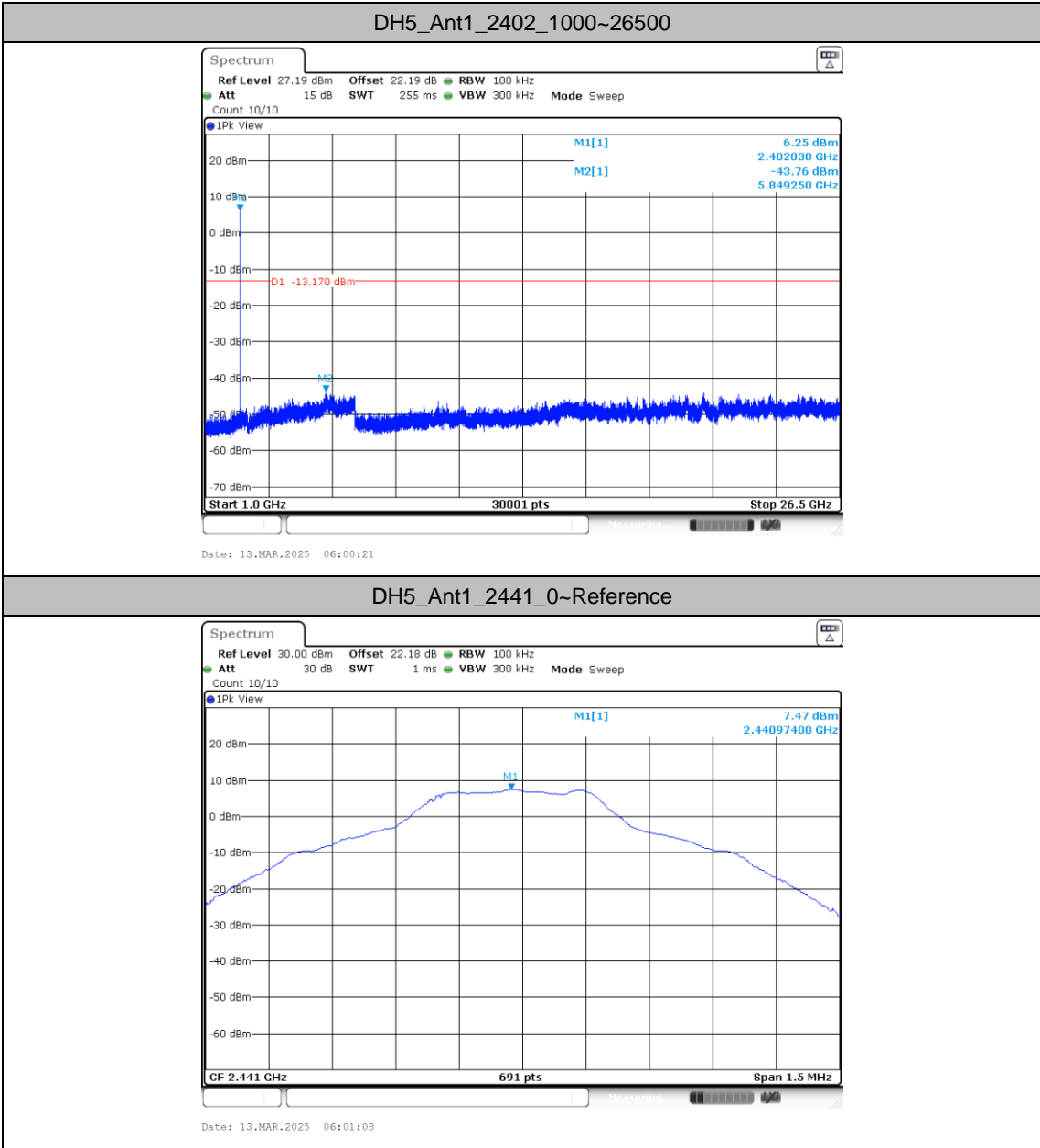

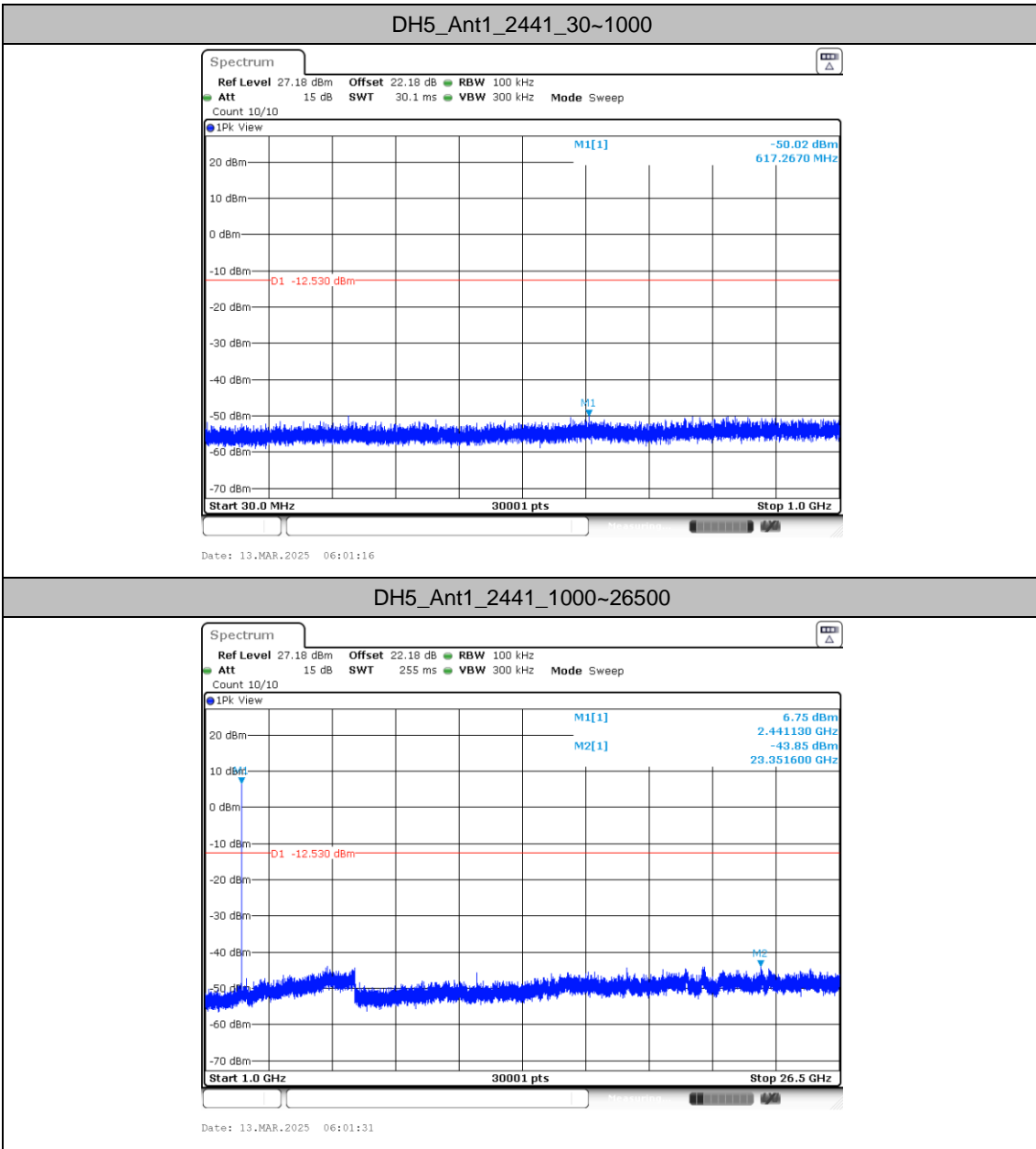

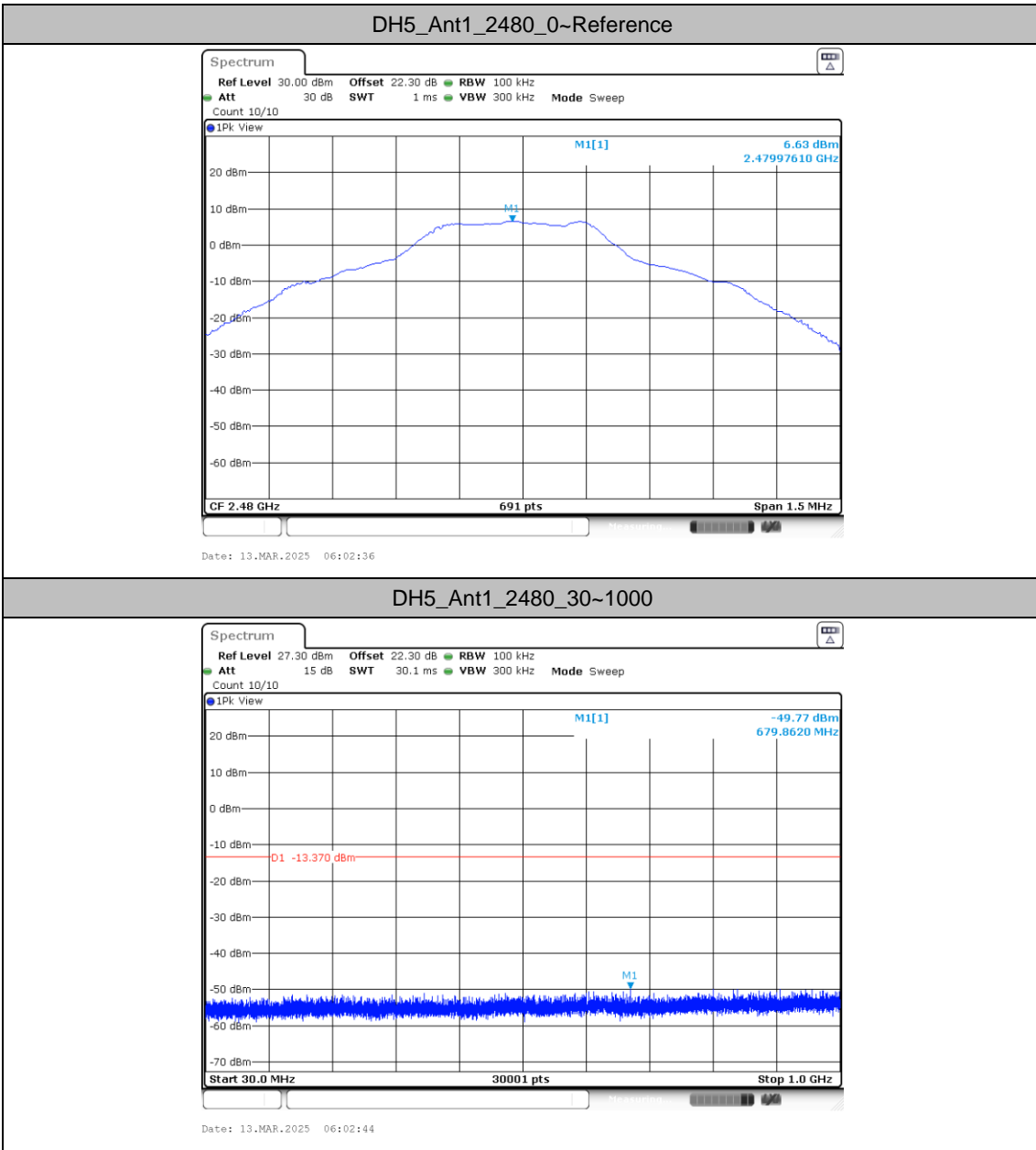

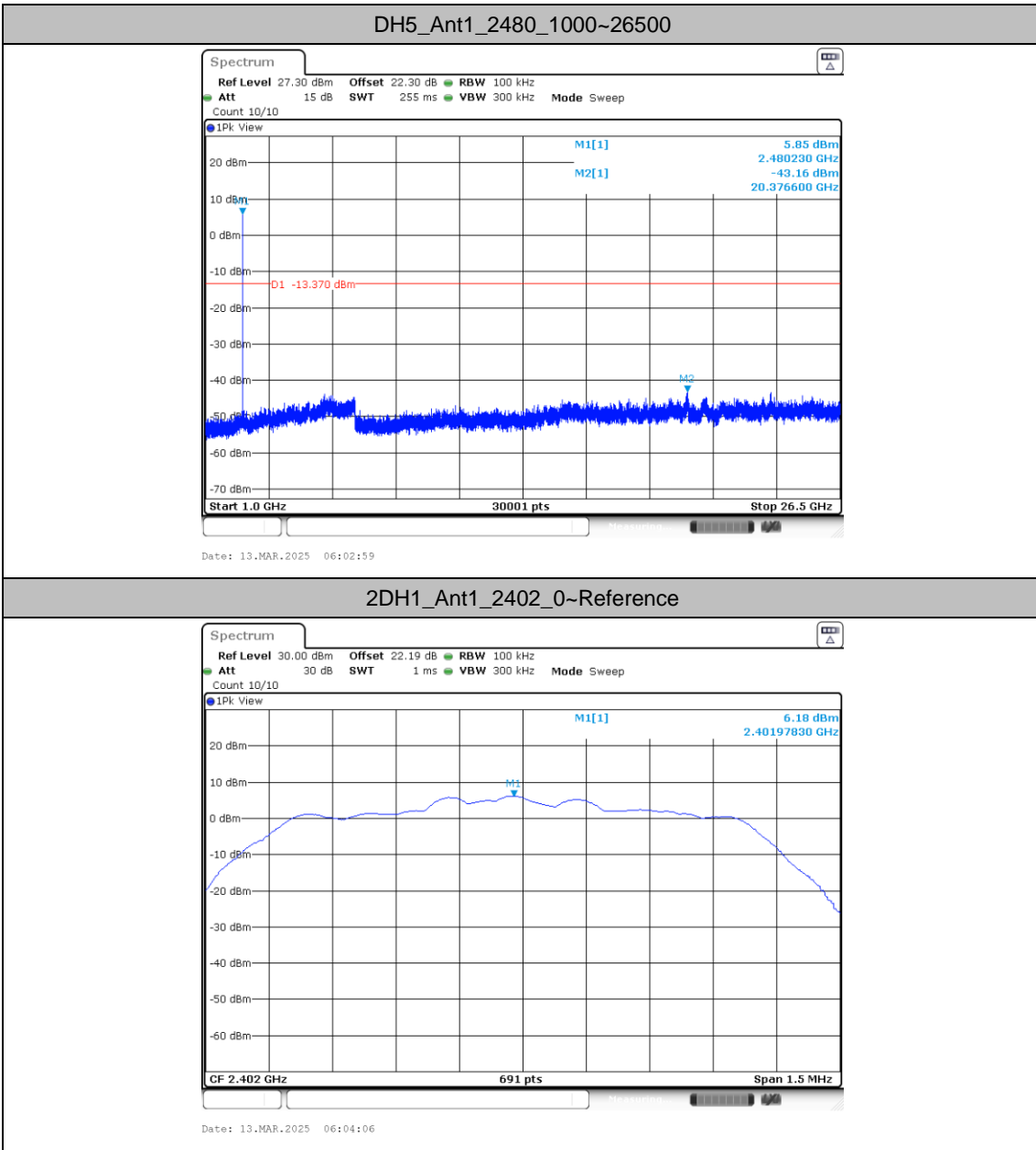

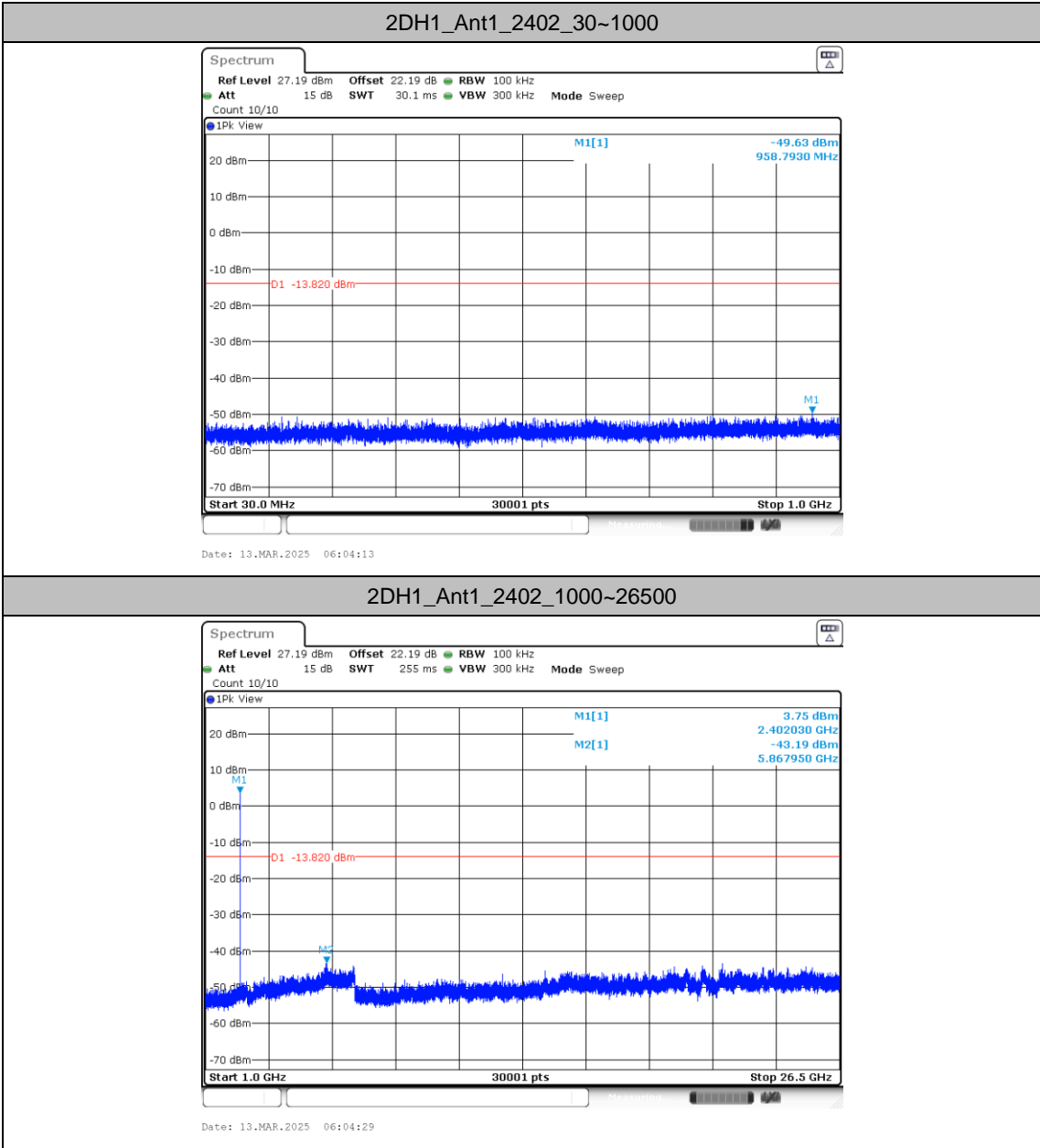

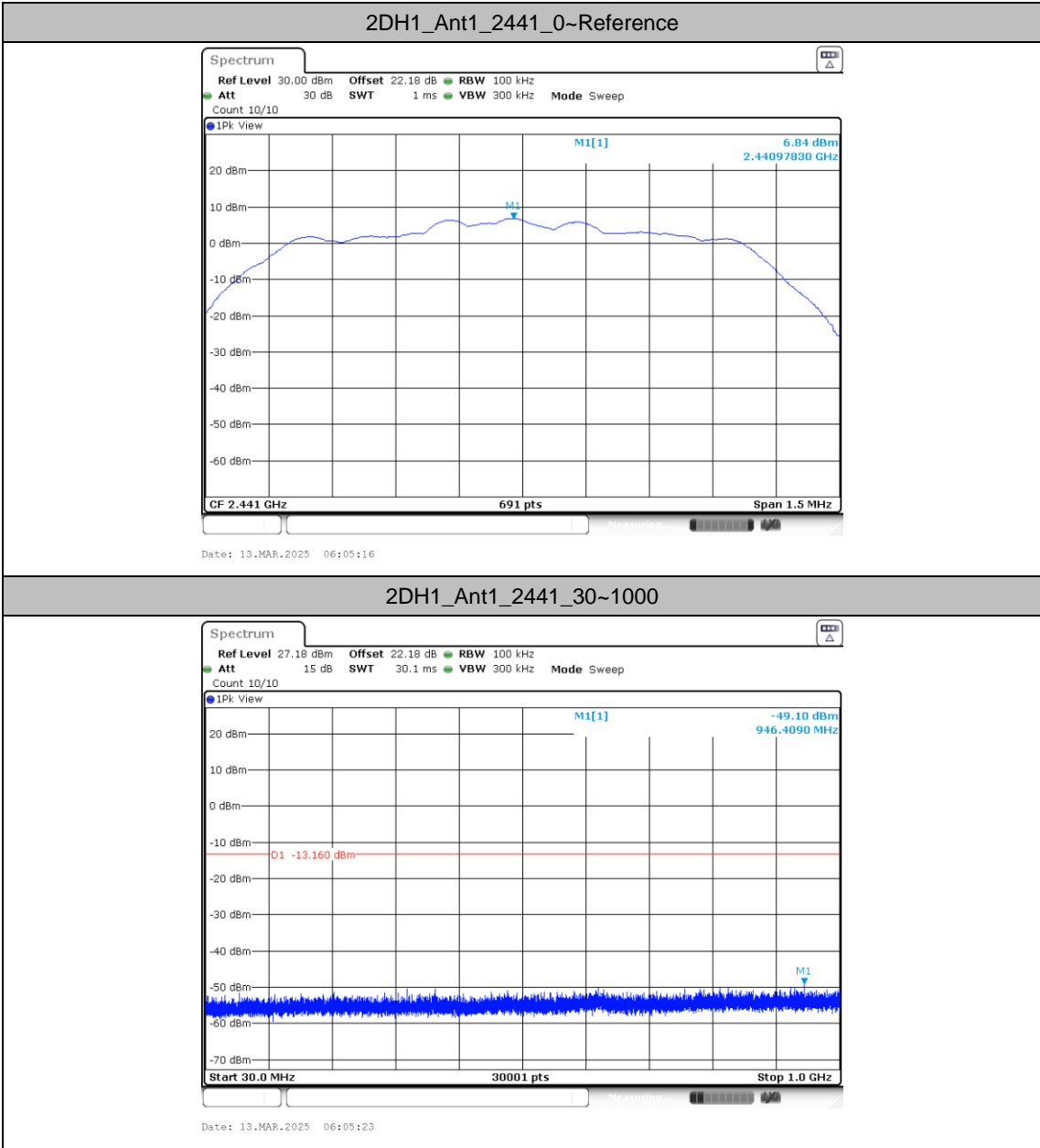

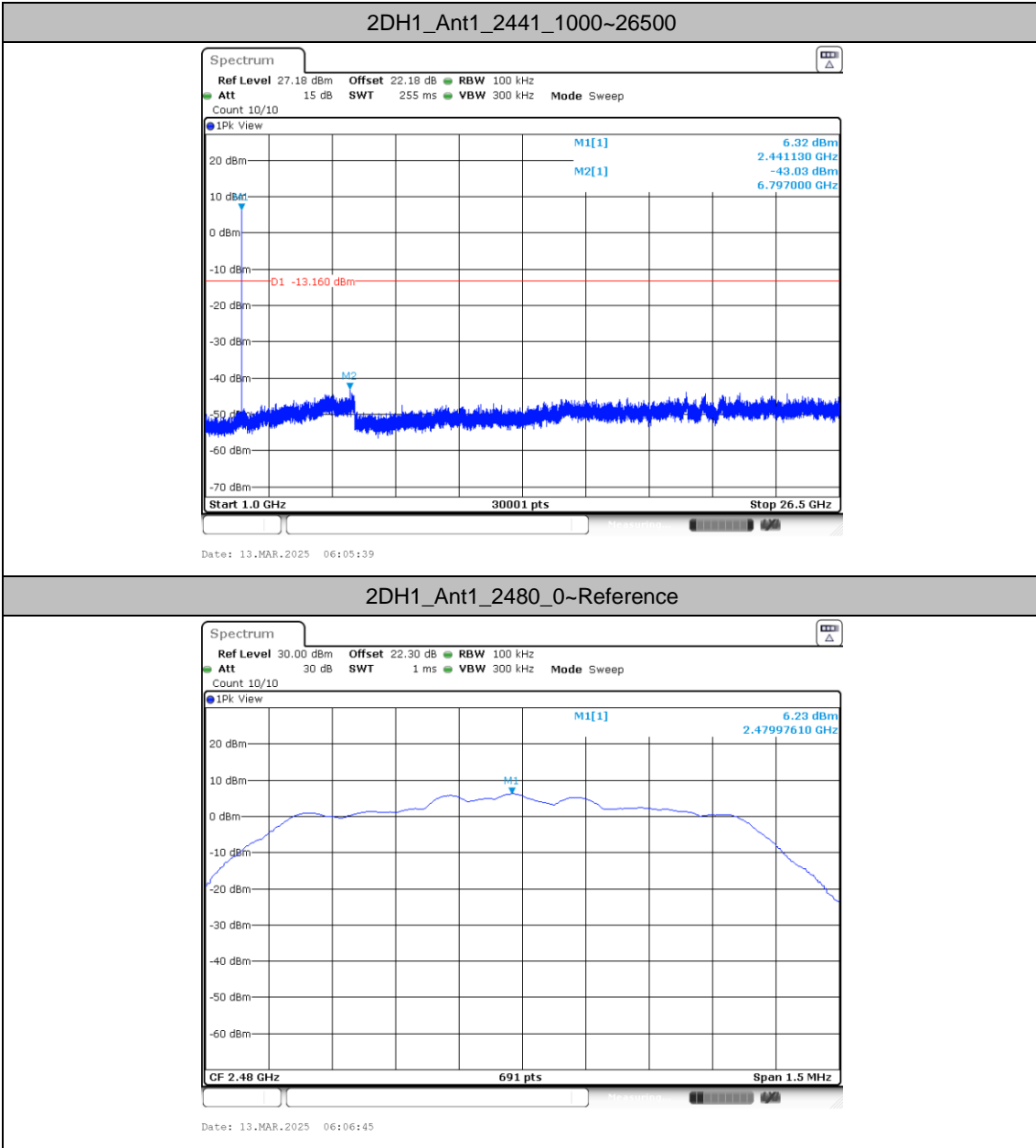

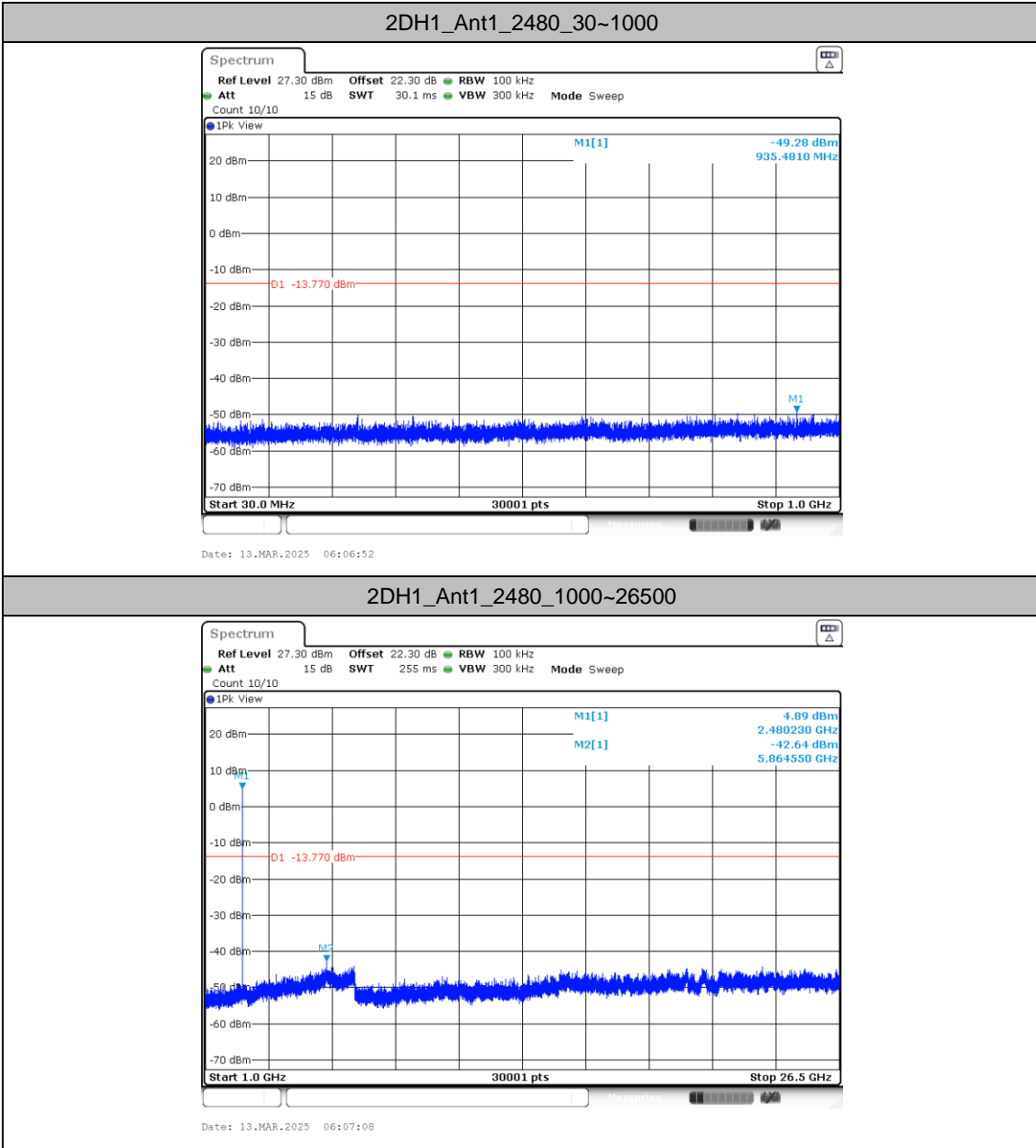

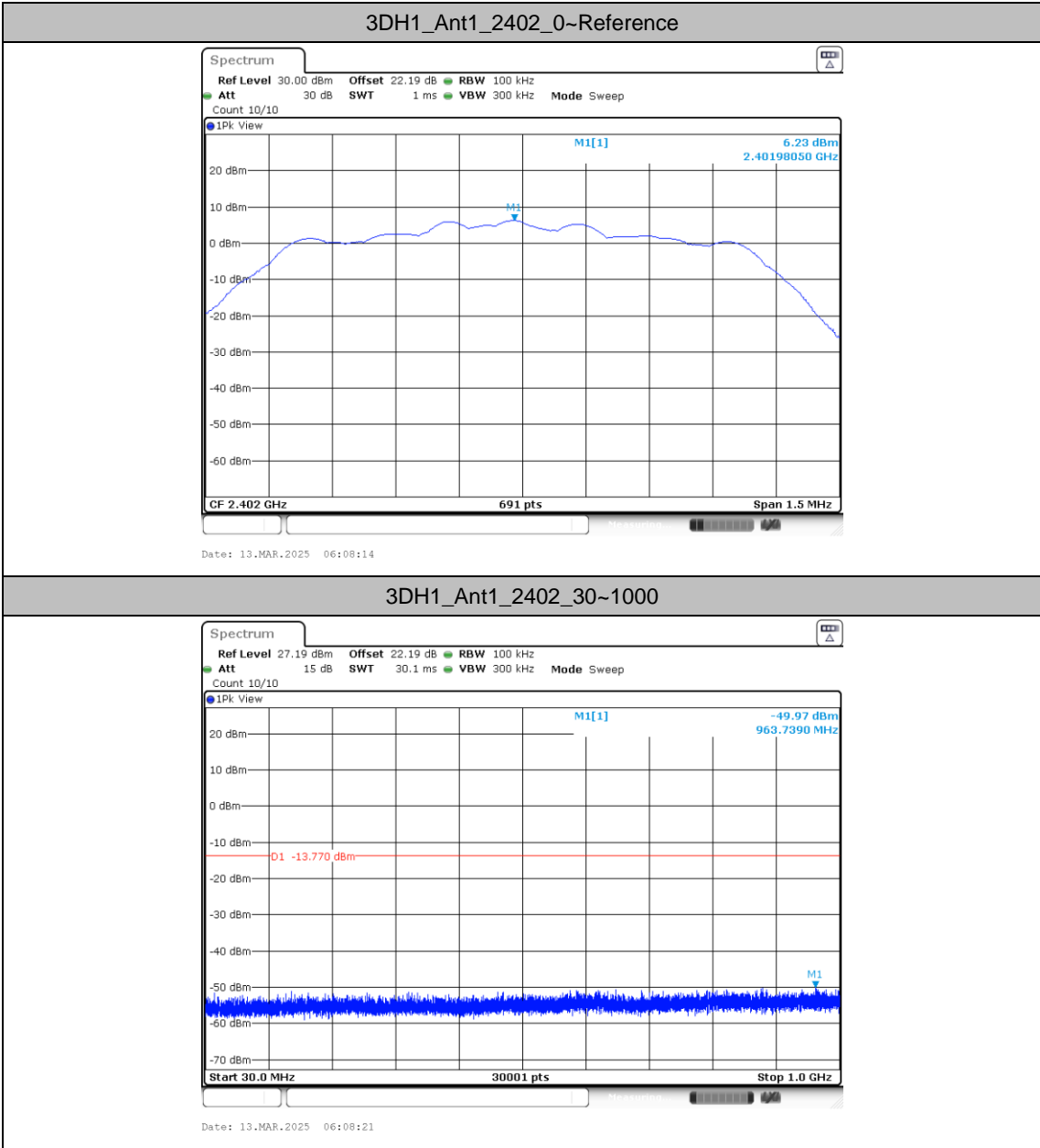

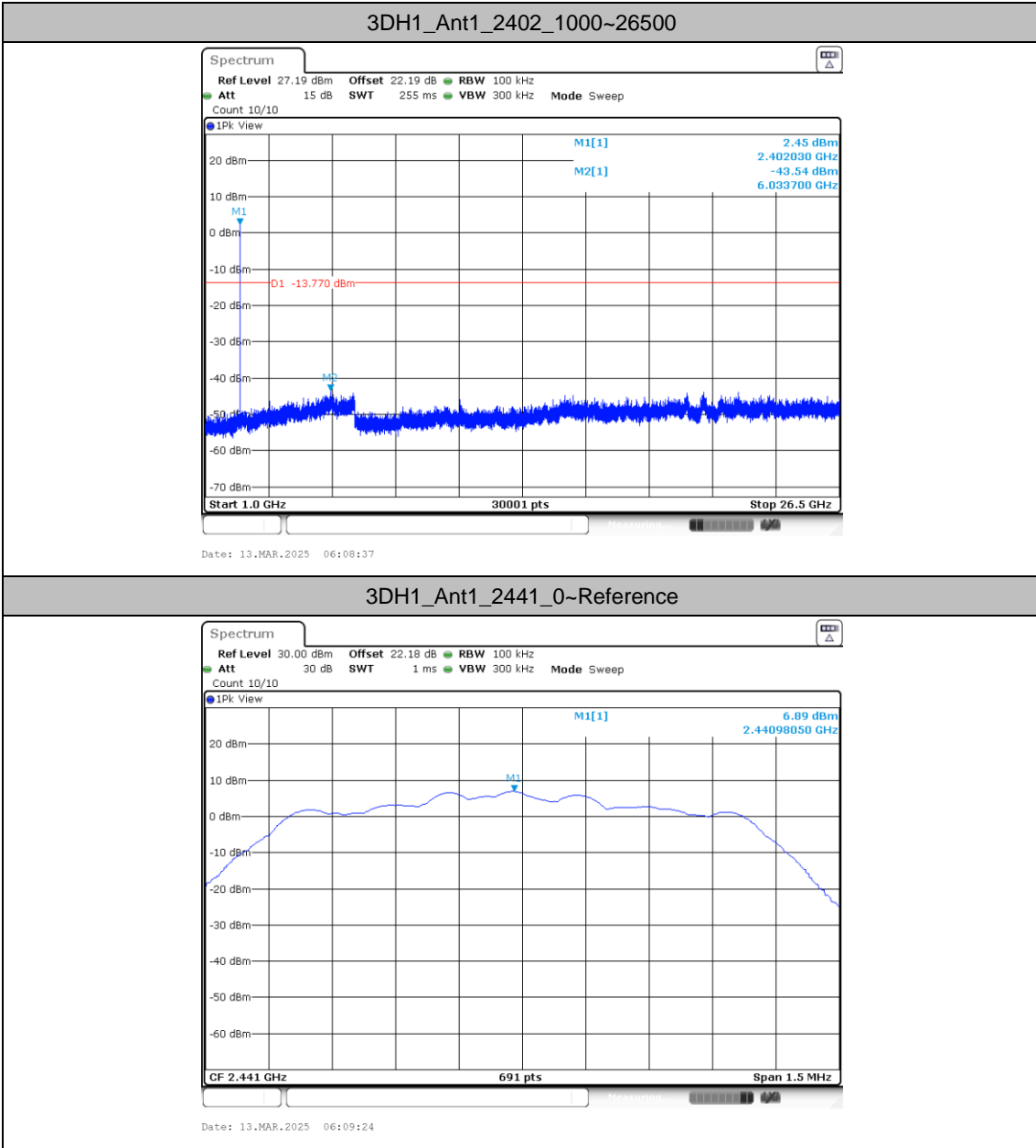

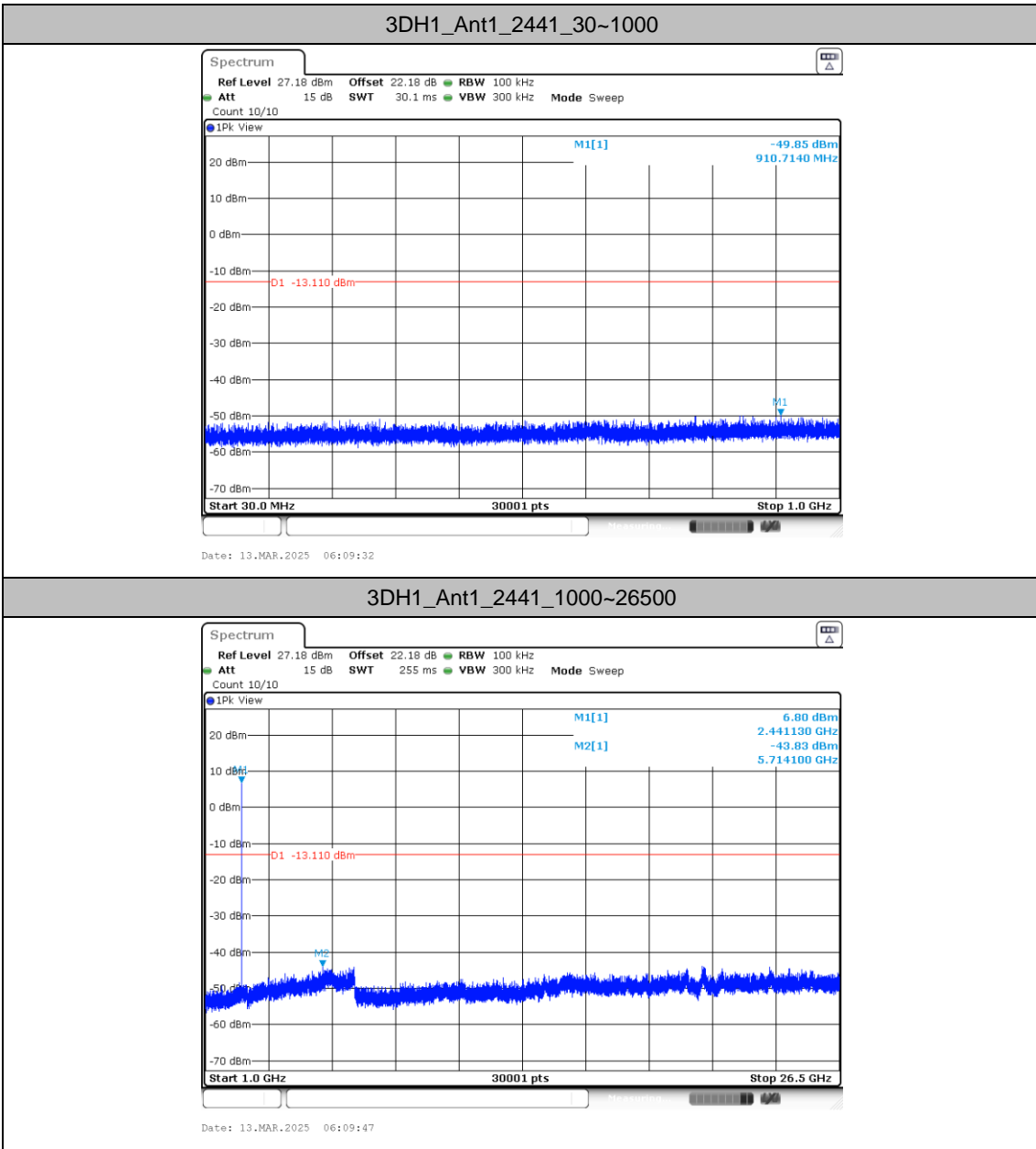

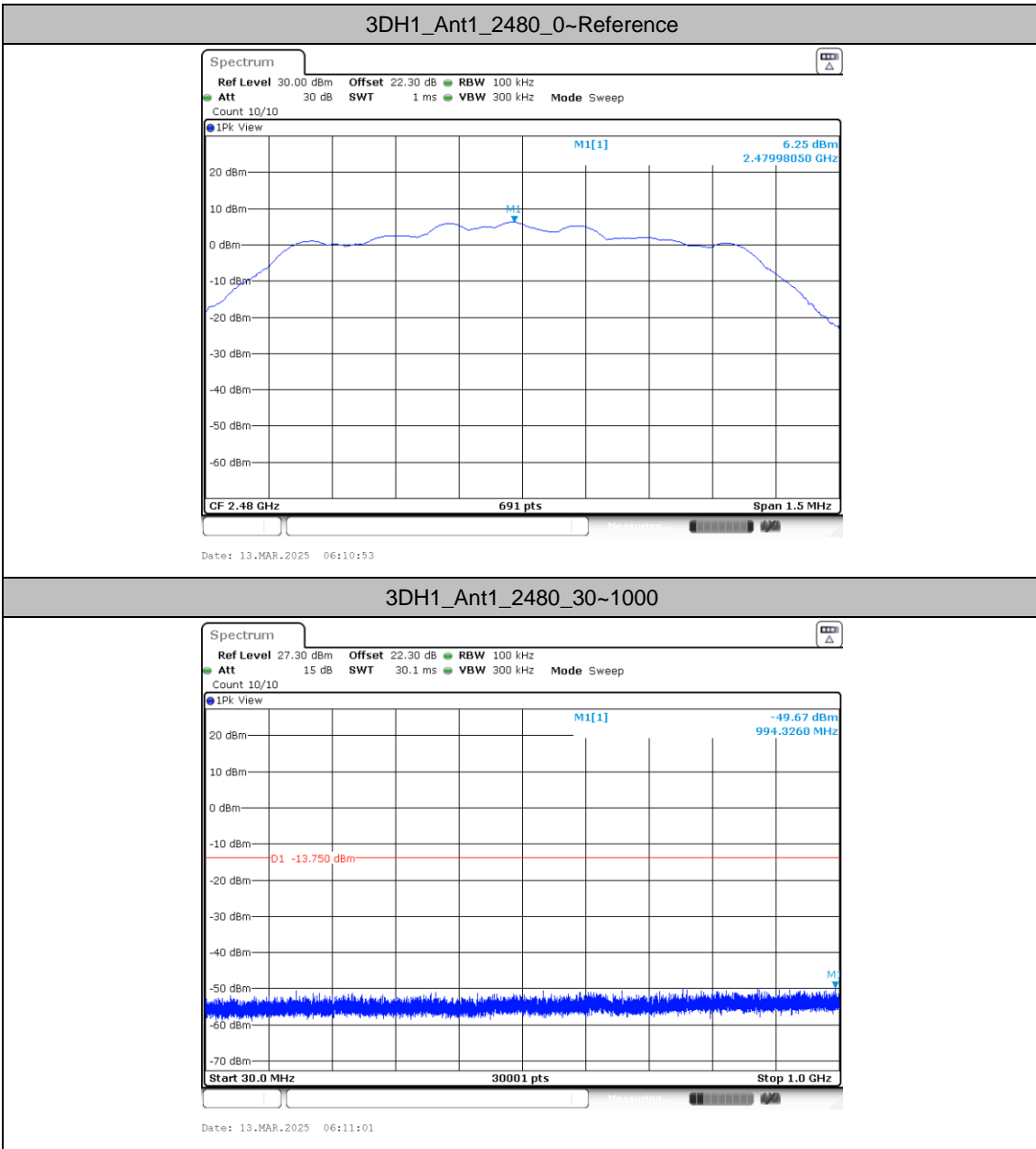

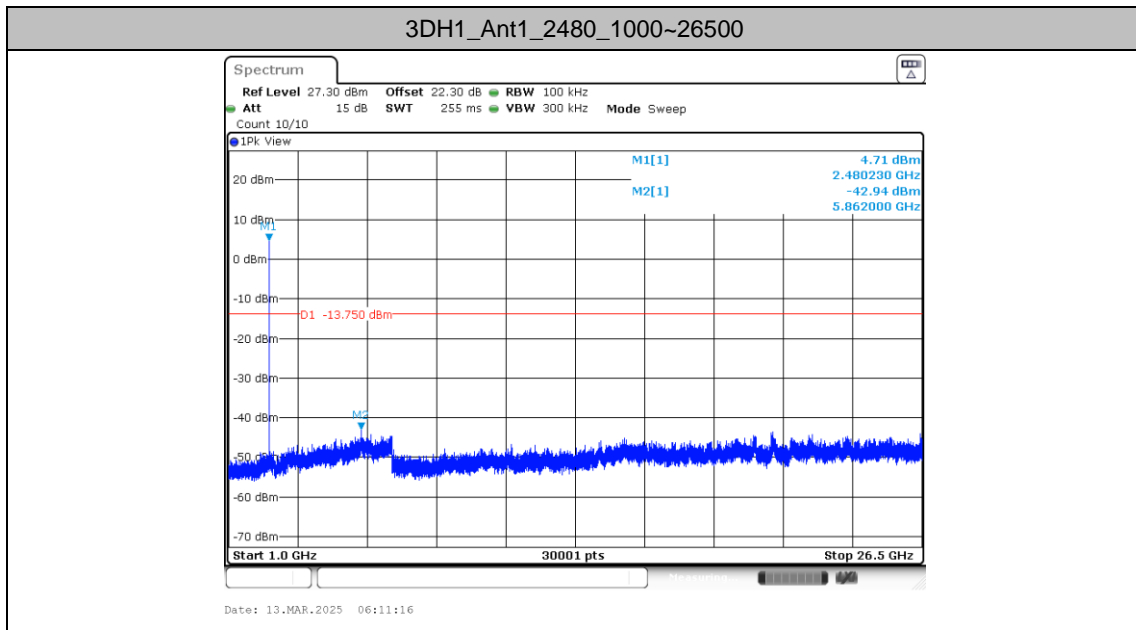



Appendix B. AC Conducted Emission Test Results

Test Engineer :	Amos Zhang	Temperature :	24.2~25.6 °C
		Relative Humidity :	37~39%
Test Voltage :	120Vac / 60Hz	Phase :	Line
Remark :	All emissions not reported here are more than 10 dB below the prescribed limit.		

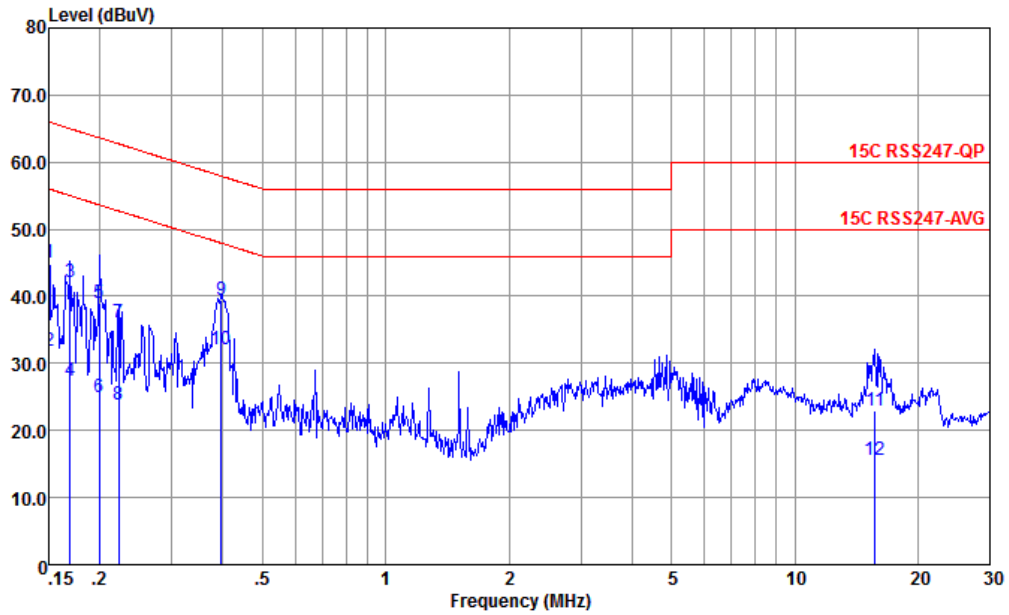

Site : CO01-KS
 Condition : 15C RSS247-QP LISN-060105-L 2024 LINE

	Freq	Level	Over	Limit	Read	LISN	Cable	Remark
	MHz	dBuV	Limit	Line	Level	Factor	Loss	
			dB	dBuV	dBuV	dB	dB	
1	0.150	45.07	-20.93	66.00	34.50	0.12	10.45	QP
2	0.150	31.77	-24.23	56.00	21.20	0.12	10.45	Average
3	0.169	42.06	-22.93	64.99	31.51	0.10	10.45	QP
4	0.169	27.46	-27.53	54.99	16.91	0.10	10.45	Average
5	0.200	39.04	-24.58	63.62	28.50	0.08	10.46	QP
6	0.200	25.04	-28.58	53.62	14.50	0.08	10.46	Average
7	0.222	36.05	-26.69	62.74	25.51	0.08	10.46	QP
8	0.222	23.85	-28.89	52.74	13.31	0.08	10.46	Average
9	0.396	39.37	-18.58	57.95	28.90	-0.02	10.49	QP
10 *	0.396	32.07	-15.88	47.95	21.60	-0.02	10.49	Average
11	15.718	22.86	-37.14	60.00	12.80	-0.22	10.28	QP
12	15.718	15.66	-34.34	50.00	5.60	-0.22	10.28	Average



Test Engineer :	Amos Zhang	Temperature :	24.2~25.6 °C
		Relative Humidity :	37~39%
Test Voltage :	120Vac / 60Hz	Phase :	Neutral
Remark :	All emissions not reported here are more than 10 dB below the prescribed limit.		

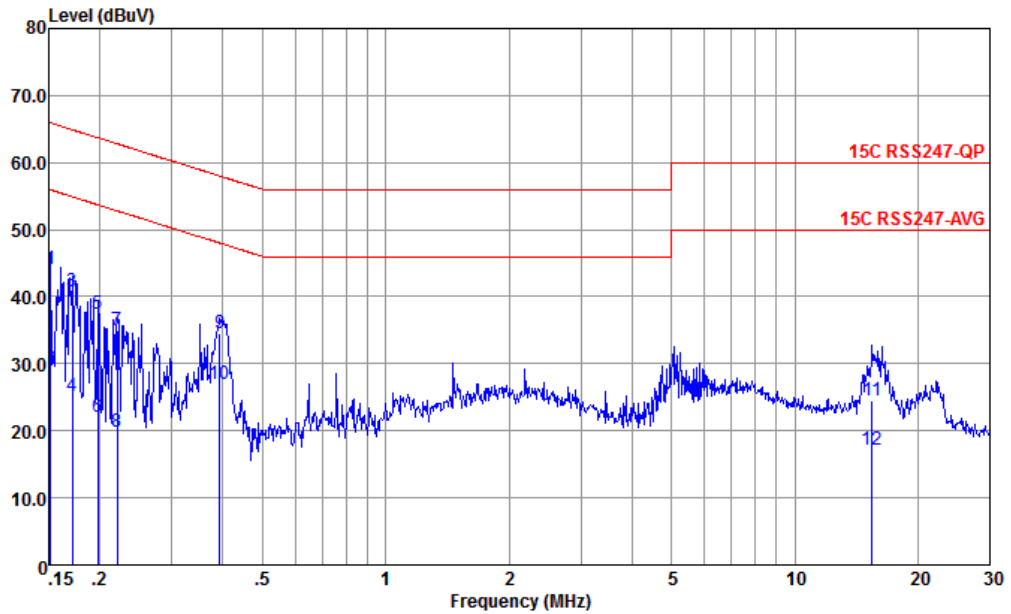

Site : CO01-KS
 Condition : 15C RSS247-QP LISN-060105-N 2024 NEUTRAL

	Freq	Level	Over	Limit	Read	LISN	Cable	Remark
	MHz	dBuV	Limit	Line	Level	Factor	Loss	
			dB	dBuV	dBuV	dB	dB	
1	0.152	44.07	-21.84	65.91	33.50	0.12	10.45	QP
2	0.152	29.17	-26.74	55.91	18.60	0.12	10.45	Average
3	0.171	40.78	-24.12	64.90	30.21	0.12	10.45	QP
4	0.171	25.18	-29.72	54.90	14.61	0.12	10.45	Average
5	0.198	37.39	-26.32	63.71	26.80	0.13	10.46	QP
6	0.198	22.09	-31.62	53.71	11.50	0.13	10.46	Average
7	0.221	35.03	-27.76	62.79	24.51	0.06	10.46	QP
8	0.221	19.73	-33.06	52.79	9.21	0.06	10.46	Average
9	0.393	34.55	-23.44	57.99	24.20	-0.14	10.49	QP
10 *	0.393	26.95	-21.04	47.99	16.60	-0.14	10.49	Average
11	15.470	24.59	-35.41	60.00	14.50	-0.19	10.28	QP
12	15.470	17.19	-32.81	50.00	7.10	-0.19	10.28	Average

Note:

- Level(dBμV) = Read Level(dBμV) + LISN Factor(dB) + Cable Loss(dB)
- Over Limit(dB) = Level(dBμV) – Limit Line(dBμV)



Appendix C. Radiated Spurious Emission

Test Engineer :	Jerry Xu	Relative Humidity :	41 ~ 42%
		Temperature :	22 ~ 23°C

Radiated Spurious Emission Test Modes

Mode	Band (MHz)	Antenna	Modulation	Channel	Frequency	Data Rate	RU	Remark
Mode 1	2400-2483.5	1	Bluetooth EDR_8-DPSK	0	2402	3Mbps	-	-
Mode 2	2400-2483.5	1	Bluetooth EDR_8-DPSK	39	2441	3Mbps	-	-
Mode 3	2400-2483.5	1	Bluetooth EDR_8-DPSK	78	2480	3Mbps	-	-

Summary of each worse mode

Mode	Modulation	Ch.	Freq. (MHz)	Level (dBuV/m)	Limit (dBuV/m)	Margin (dB)	Pol.	Peak Avg.	Result	Remark
1	Bluetooth EDR_8-DPSK	0	2364.99	56.69	74.00	-17.31	H	PEAK	Pass	Band Edge
	Bluetooth EDR_8-DPSK	0	4804.00	40.60	74.00	-33.40	V	PEAK	Pass	Harmonic
2	Bluetooth EDR_8-DPSK	39	-	-	-	-	-	-	-	Band Edge
	Bluetooth EDR_8-DPSK	39	7323.00	42.80	74.00	-31.20	H	PEAK	Pass	Harmonic
3	Bluetooth EDR_8-DPSK	78	2483.72	59.84	74.00	-14.16	H	PEAK	Pass	Band Edge
	Bluetooth EDR_8-DPSK	78	7440.00	42.61	74.00	-31.39	H	PEAK	Pass	Harmonic



Mode	1																																																																																																																			
	Band Edge																																																																																																																			
	2400-2483.5_Bluetooth EDR_8-DPSK_CH0_2402MHz																																																																																																																			
ANT	1																																																																																																																			
Pol.	Horizontal	Fundamental																																																																																																																		
Peak	<table border="1"> <thead> <tr> <th>Limit</th> <th>Over</th> <th>Read</th> <th>Ant</th> <th>Cable</th> <th>Preamp</th> <th>Aux</th> <th>APos</th> <th>TPos</th> <th>Remark</th> </tr> <tr> <th>Freq</th> <th>Level</th> <th>Line</th> <th>Limit</th> <th>Level</th> <th>Factor</th> <th>Loss</th> <th>Factor</th> <th>Factor</th> <th></th> </tr> <tr> <th>MHz</th> <th>dBuV/m</th> <th>dBuV/m</th> <th>dB</th> <th>dBuV</th> <th>dB/m</th> <th>dB</th> <th>dB</th> <th>dB</th> <th>cm</th> <th>deg</th> </tr> </thead> <tbody> <tr> <td>1</td> <td>2364.99</td> <td>56.69</td> <td>74.00</td> <td>-17.31</td> <td>44.46</td> <td>31.99</td> <td>6.67</td> <td>32.43</td> <td>6.00</td> <td>128</td> <td>332</td> <td>PEAK</td> </tr> <tr> <td>2</td> <td>2364.99</td> <td>31.90</td> <td>54.00</td> <td>-22.10</td> <td>19.67</td> <td>31.99</td> <td>6.67</td> <td>32.43</td> <td>6.00</td> <td>128</td> <td>332</td> <td>AVERAGE</td> </tr> </tbody> </table>	Limit	Over	Read	Ant	Cable	Preamp	Aux	APos	TPos	Remark	Freq	Level	Line	Limit	Level	Factor	Loss	Factor	Factor		MHz	dBuV/m	dBuV/m	dB	dBuV	dB/m	dB	dB	dB	cm	deg	1	2364.99	56.69	74.00	-17.31	44.46	31.99	6.67	32.43	6.00	128	332	PEAK	2	2364.99	31.90	54.00	-22.10	19.67	31.99	6.67	32.43	6.00	128	332	AVERAGE	<table border="1"> <thead> <tr> <th>Limit</th> <th>Over</th> <th>Read</th> <th>Ant</th> <th>Cable</th> <th>Preamp</th> <th>Aux</th> <th>APos</th> <th>TPos</th> <th>Remark</th> </tr> <tr> <th>Freq</th> <th>Level</th> <th>Line</th> <th>Limit</th> <th>Level</th> <th>Factor</th> <th>Loss</th> <th>Factor</th> <th>Factor</th> <th></th> </tr> <tr> <th>MHz</th> <th>dBuV/m</th> <th>dBuV/m</th> <th>dB</th> <th>dBuV</th> <th>dB/m</th> <th>dB</th> <th>dB</th> <th>dB</th> <th>cm</th> <th>deg</th> </tr> </thead> <tbody> <tr> <td>1</td> <td>2402.00</td> <td>104.29</td> <td>-----</td> <td>-----</td> <td>91.78</td> <td>32.21</td> <td>6.72</td> <td>32.42</td> <td>6.00</td> <td>128</td> <td>332</td> <td>PEAK</td> </tr> <tr> <td>2</td> <td>2402.00</td> <td>79.50</td> <td>-----</td> <td>-----</td> <td>66.99</td> <td>32.21</td> <td>6.72</td> <td>32.42</td> <td>6.00</td> <td>128</td> <td>332</td> <td>AVERAGE</td> </tr> </tbody> </table>	Limit	Over	Read	Ant	Cable	Preamp	Aux	APos	TPos	Remark	Freq	Level	Line	Limit	Level	Factor	Loss	Factor	Factor		MHz	dBuV/m	dBuV/m	dB	dBuV	dB/m	dB	dB	dB	cm	deg	1	2402.00	104.29	-----	-----	91.78	32.21	6.72	32.42	6.00	128	332	PEAK	2	2402.00	79.50	-----	-----	66.99	32.21	6.72	32.42	6.00	128	332	AVERAGE
Limit	Over	Read	Ant	Cable	Preamp	Aux	APos	TPos	Remark																																																																																																											
Freq	Level	Line	Limit	Level	Factor	Loss	Factor	Factor																																																																																																												
MHz	dBuV/m	dBuV/m	dB	dBuV	dB/m	dB	dB	dB	cm	deg																																																																																																										
1	2364.99	56.69	74.00	-17.31	44.46	31.99	6.67	32.43	6.00	128	332	PEAK																																																																																																								
2	2364.99	31.90	54.00	-22.10	19.67	31.99	6.67	32.43	6.00	128	332	AVERAGE																																																																																																								
Limit	Over	Read	Ant	Cable	Preamp	Aux	APos	TPos	Remark																																																																																																											
Freq	Level	Line	Limit	Level	Factor	Loss	Factor	Factor																																																																																																												
MHz	dBuV/m	dBuV/m	dB	dBuV	dB/m	dB	dB	dB	cm	deg																																																																																																										
1	2402.00	104.29	-----	-----	91.78	32.21	6.72	32.42	6.00	128	332	PEAK																																																																																																								
2	2402.00	79.50	-----	-----	66.99	32.21	6.72	32.42	6.00	128	332	AVERAGE																																																																																																								



Mode	1																																																																																																															
	Band Edge																																																																																																															
	2400-2483.5_Bluetooth EDR_8-DPSK_CH0_2402MHz																																																																																																															
ANT	1																																																																																																															
Pol.	Vertical	Fundamental																																																																																																														
Peak	<table border="1"> <thead> <tr> <th>Limit</th> <th>Over</th> <th>Read</th> <th>Ant</th> <th>Cable</th> <th>Preamp</th> <th>Aux</th> <th>APos</th> <th>TPos</th> <th>Remark</th> </tr> <tr> <th>Freq</th> <th>Level</th> <th>Line</th> <th>Limit</th> <th>Level</th> <th>Factor</th> <th>Loss</th> <th>Factor</th> <th>Factor</th> <th></th> </tr> <tr> <th>MHz</th> <th>dBuV/m</th> <th>dBuV/m</th> <th>dB</th> <th>dBuV</th> <th>dB/m</th> <th>dB</th> <th>dB</th> <th>dB</th> <th>cm</th> <th>deg</th> </tr> </thead> <tbody> <tr> <td>1</td> <td>2350.30</td> <td>55.21</td> <td>74.00</td> <td>-18.79</td> <td>43.10</td> <td>31.90</td> <td>6.65</td> <td>32.44</td> <td>6.00</td> <td>244</td> <td>0 PEAK</td> </tr> <tr> <td>2</td> <td>2350.30</td> <td>30.42</td> <td>54.00</td> <td>-23.58</td> <td>18.31</td> <td>31.90</td> <td>6.65</td> <td>32.44</td> <td>6.00</td> <td>244</td> <td>0 AVERAGE</td> </tr> </tbody> </table>	Limit	Over	Read	Ant	Cable	Preamp	Aux	APos	TPos	Remark	Freq	Level	Line	Limit	Level	Factor	Loss	Factor	Factor		MHz	dBuV/m	dBuV/m	dB	dBuV	dB/m	dB	dB	dB	cm	deg	1	2350.30	55.21	74.00	-18.79	43.10	31.90	6.65	32.44	6.00	244	0 PEAK	2	2350.30	30.42	54.00	-23.58	18.31	31.90	6.65	32.44	6.00	244	0 AVERAGE	<table border="1"> <thead> <tr> <th>Limit</th> <th>Over</th> <th>Read</th> <th>Ant</th> <th>Cable</th> <th>Preamp</th> <th>Aux</th> <th>APos</th> <th>TPos</th> <th>Remark</th> </tr> <tr> <th>Freq</th> <th>Level</th> <th>Line</th> <th>Limit</th> <th>Level</th> <th>Factor</th> <th>Loss</th> <th>Factor</th> <th>Factor</th> <th></th> </tr> <tr> <th>MHz</th> <th>dBuV/m</th> <th>dBuV/m</th> <th>dB</th> <th>dBuV</th> <th>dB/m</th> <th>dB</th> <th>dB</th> <th>dB</th> <th>cm</th> <th>deg</th> </tr> </thead> <tbody> <tr> <td>1</td> <td>2402.00</td> <td>102.83</td> <td>78.04</td> <td>24.79</td> <td>90.32</td> <td>32.21</td> <td>6.72</td> <td>32.42</td> <td>6.00</td> <td>244</td> <td>0 PEAK</td> </tr> <tr> <td>2</td> <td>2402.00</td> <td>78.04</td> <td>78.04</td> <td>0.00</td> <td>65.53</td> <td>32.21</td> <td>6.72</td> <td>32.42</td> <td>6.00</td> <td>244</td> <td>0 AVERAGE</td> </tr> </tbody> </table>	Limit	Over	Read	Ant	Cable	Preamp	Aux	APos	TPos	Remark	Freq	Level	Line	Limit	Level	Factor	Loss	Factor	Factor		MHz	dBuV/m	dBuV/m	dB	dBuV	dB/m	dB	dB	dB	cm	deg	1	2402.00	102.83	78.04	24.79	90.32	32.21	6.72	32.42	6.00	244	0 PEAK	2	2402.00	78.04	78.04	0.00	65.53	32.21	6.72	32.42	6.00	244	0 AVERAGE
Limit	Over	Read	Ant	Cable	Preamp	Aux	APos	TPos	Remark																																																																																																							
Freq	Level	Line	Limit	Level	Factor	Loss	Factor	Factor																																																																																																								
MHz	dBuV/m	dBuV/m	dB	dBuV	dB/m	dB	dB	dB	cm	deg																																																																																																						
1	2350.30	55.21	74.00	-18.79	43.10	31.90	6.65	32.44	6.00	244	0 PEAK																																																																																																					
2	2350.30	30.42	54.00	-23.58	18.31	31.90	6.65	32.44	6.00	244	0 AVERAGE																																																																																																					
Limit	Over	Read	Ant	Cable	Preamp	Aux	APos	TPos	Remark																																																																																																							
Freq	Level	Line	Limit	Level	Factor	Loss	Factor	Factor																																																																																																								
MHz	dBuV/m	dBuV/m	dB	dBuV	dB/m	dB	dB	dB	cm	deg																																																																																																						
1	2402.00	102.83	78.04	24.79	90.32	32.21	6.72	32.42	6.00	244	0 PEAK																																																																																																					
2	2402.00	78.04	78.04	0.00	65.53	32.21	6.72	32.42	6.00	244	0 AVERAGE																																																																																																					



Mode	1																																																																																	
	Harmonic																																																																																	
	2400-2483.5_Bluetooth EDR_8-DPSK_CH0_2402MHz																																																																																	
ANT	1																																																																																	
Pol.	Horizontal	Vertical																																																																																
Peak Avg	<table border="1"> <thead> <tr> <th>Limit</th> <th>Over</th> <th>Read</th> <th>Ant</th> <th>Cable</th> <th>Preamp</th> <th>Aux</th> <th>APos</th> <th>TPos</th> </tr> <tr> <th>Freq</th> <th>Level</th> <th>Line</th> <th>Limit</th> <th>Level</th> <th>Factor</th> <th>Loss</th> <th>Factor</th> <th>Factor</th> </tr> <tr> <th>MHz</th> <th>dBuV/m</th> <th>dBuV/m</th> <th>dB</th> <th>dBuV</th> <th>dB/m</th> <th>dB</th> <th>dB</th> <th>dB</th> </tr> </thead> <tbody> <tr> <td>1</td> <td>4804.00</td> <td>39.58</td> <td>74.00</td> <td>-34.42</td> <td>61.81</td> <td>34.21</td> <td>9.53</td> <td>65.97</td> <td>0.00</td> <td>---</td> <td>---</td> <td>PEAK</td> </tr> </tbody> </table>	Limit	Over	Read	Ant	Cable	Preamp	Aux	APos	TPos	Freq	Level	Line	Limit	Level	Factor	Loss	Factor	Factor	MHz	dBuV/m	dBuV/m	dB	dBuV	dB/m	dB	dB	dB	1	4804.00	39.58	74.00	-34.42	61.81	34.21	9.53	65.97	0.00	---	---	PEAK	<table border="1"> <thead> <tr> <th>Limit</th> <th>Over</th> <th>Read</th> <th>Ant</th> <th>Cable</th> <th>Preamp</th> <th>Aux</th> <th>APos</th> <th>TPos</th> </tr> <tr> <th>Freq</th> <th>Level</th> <th>Line</th> <th>Limit</th> <th>Level</th> <th>Factor</th> <th>Loss</th> <th>Factor</th> <th>Factor</th> </tr> <tr> <th>MHz</th> <th>dBuV/m</th> <th>dBuV/m</th> <th>dB</th> <th>dBuV</th> <th>dB/m</th> <th>dB</th> <th>dB</th> <th>dB</th> </tr> </thead> <tbody> <tr> <td>1</td> <td>4804.00</td> <td>40.60</td> <td>74.00</td> <td>-33.40</td> <td>62.83</td> <td>34.21</td> <td>9.53</td> <td>65.97</td> <td>0.00</td> <td>---</td> <td>---</td> <td>PEAK</td> </tr> </tbody> </table>	Limit	Over	Read	Ant	Cable	Preamp	Aux	APos	TPos	Freq	Level	Line	Limit	Level	Factor	Loss	Factor	Factor	MHz	dBuV/m	dBuV/m	dB	dBuV	dB/m	dB	dB	dB	1	4804.00	40.60	74.00	-33.40	62.83	34.21	9.53	65.97	0.00	---	---	PEAK
Limit	Over	Read	Ant	Cable	Preamp	Aux	APos	TPos																																																																										
Freq	Level	Line	Limit	Level	Factor	Loss	Factor	Factor																																																																										
MHz	dBuV/m	dBuV/m	dB	dBuV	dB/m	dB	dB	dB																																																																										
1	4804.00	39.58	74.00	-34.42	61.81	34.21	9.53	65.97	0.00	---	---	PEAK																																																																						
Limit	Over	Read	Ant	Cable	Preamp	Aux	APos	TPos																																																																										
Freq	Level	Line	Limit	Level	Factor	Loss	Factor	Factor																																																																										
MHz	dBuV/m	dBuV/m	dB	dBuV	dB/m	dB	dB	dB																																																																										
1	4804.00	40.60	74.00	-33.40	62.83	34.21	9.53	65.97	0.00	---	---	PEAK																																																																						



Mode	2																																																																																																																			
	Harmonic																																																																																																																			
	2400-2483.5_Bluetooth EDR_8-DPSK_CH39_2441MHz																																																																																																																			
ANT	1																																																																																																																			
Pol.	Horizontal	Vertical																																																																																																																		
Peak Avg	<table border="1"> <thead> <tr> <th>Limit</th> <th>Over</th> <th>Read</th> <th>Ant</th> <th>Cable</th> <th>Preamp</th> <th>Aux</th> <th>APos</th> <th>TPos</th> <th>Remark</th> </tr> <tr> <th>Freq</th> <th>Level</th> <th>Line</th> <th>Limit</th> <th>Level</th> <th>Factor</th> <th>Loss</th> <th>Factor</th> <th>Factor</th> <th></th> </tr> <tr> <th>MHz</th> <th>dBuV/m</th> <th>dBuV/m</th> <th>dB</th> <th>dBuV</th> <th>dB/m</th> <th>dB</th> <th>dB</th> <th>dB</th> <th>cm</th> <th>deg</th> </tr> </thead> <tbody> <tr> <td>1</td> <td>4882.00</td> <td>40.91</td> <td>74.00</td> <td>-33.09</td> <td>62.91</td> <td>34.24</td> <td>9.62</td> <td>65.86</td> <td>0.00</td> <td>---</td> <td>---</td> <td>PEAK</td> </tr> <tr> <td>2</td> <td>7323.00</td> <td>42.80</td> <td>74.00</td> <td>-31.20</td> <td>60.58</td> <td>35.55</td> <td>11.88</td> <td>65.21</td> <td>0.00</td> <td>---</td> <td>---</td> <td>PEAK</td> </tr> </tbody> </table>	Limit	Over	Read	Ant	Cable	Preamp	Aux	APos	TPos	Remark	Freq	Level	Line	Limit	Level	Factor	Loss	Factor	Factor		MHz	dBuV/m	dBuV/m	dB	dBuV	dB/m	dB	dB	dB	cm	deg	1	4882.00	40.91	74.00	-33.09	62.91	34.24	9.62	65.86	0.00	---	---	PEAK	2	7323.00	42.80	74.00	-31.20	60.58	35.55	11.88	65.21	0.00	---	---	PEAK	<table border="1"> <thead> <tr> <th>Limit</th> <th>Over</th> <th>Read</th> <th>Ant</th> <th>Cable</th> <th>Preamp</th> <th>Aux</th> <th>APos</th> <th>TPos</th> <th>Remark</th> </tr> <tr> <th>Freq</th> <th>Level</th> <th>Line</th> <th>Limit</th> <th>Level</th> <th>Factor</th> <th>Loss</th> <th>Factor</th> <th>Factor</th> <th></th> </tr> <tr> <th>MHz</th> <th>dBuV/m</th> <th>dBuV/m</th> <th>dB</th> <th>dBuV</th> <th>dB/m</th> <th>dB</th> <th>dB</th> <th>dB</th> <th>cm</th> <th>deg</th> </tr> </thead> <tbody> <tr> <td>1</td> <td>4882.00</td> <td>41.67</td> <td>74.00</td> <td>-32.33</td> <td>63.67</td> <td>34.24</td> <td>9.62</td> <td>65.86</td> <td>0.00</td> <td>---</td> <td>---</td> <td>PEAK</td> </tr> <tr> <td>2</td> <td>7323.00</td> <td>42.45</td> <td>74.00</td> <td>-31.55</td> <td>60.23</td> <td>35.55</td> <td>11.88</td> <td>65.21</td> <td>0.00</td> <td>---</td> <td>---</td> <td>PEAK</td> </tr> </tbody> </table>	Limit	Over	Read	Ant	Cable	Preamp	Aux	APos	TPos	Remark	Freq	Level	Line	Limit	Level	Factor	Loss	Factor	Factor		MHz	dBuV/m	dBuV/m	dB	dBuV	dB/m	dB	dB	dB	cm	deg	1	4882.00	41.67	74.00	-32.33	63.67	34.24	9.62	65.86	0.00	---	---	PEAK	2	7323.00	42.45	74.00	-31.55	60.23	35.55	11.88	65.21	0.00	---	---	PEAK
	Limit	Over	Read	Ant	Cable	Preamp	Aux	APos	TPos	Remark																																																																																																										
Freq	Level	Line	Limit	Level	Factor	Loss	Factor	Factor																																																																																																												
MHz	dBuV/m	dBuV/m	dB	dBuV	dB/m	dB	dB	dB	cm	deg																																																																																																										
1	4882.00	40.91	74.00	-33.09	62.91	34.24	9.62	65.86	0.00	---	---	PEAK																																																																																																								
2	7323.00	42.80	74.00	-31.20	60.58	35.55	11.88	65.21	0.00	---	---	PEAK																																																																																																								
Limit	Over	Read	Ant	Cable	Preamp	Aux	APos	TPos	Remark																																																																																																											
Freq	Level	Line	Limit	Level	Factor	Loss	Factor	Factor																																																																																																												
MHz	dBuV/m	dBuV/m	dB	dBuV	dB/m	dB	dB	dB	cm	deg																																																																																																										
1	4882.00	41.67	74.00	-32.33	63.67	34.24	9.62	65.86	0.00	---	---	PEAK																																																																																																								
2	7323.00	42.45	74.00	-31.55	60.23	35.55	11.88	65.21	0.00	---	---	PEAK																																																																																																								



Mode	3																																																																																																																			
	Band Edge																																																																																																																			
	2400-2483.5_Bluetooth EDR_8-DPSK_CH78_2480MHz																																																																																																																			
ANT	1																																																																																																																			
Pol.	Horizontal	Fundamental																																																																																																																		
Peak	<table border="1"> <thead> <tr> <th>Limit</th> <th>Over</th> <th>Read</th> <th>Ant</th> <th>Cable</th> <th>Preamp</th> <th>Aux</th> <th>APos</th> <th>TPos</th> <th>Remark</th> </tr> <tr> <th>Freq</th> <th>Level</th> <th>Line</th> <th>Limit</th> <th>Level</th> <th>Factor</th> <th>Loss</th> <th>Factor</th> <th>Factor</th> <th></th> </tr> <tr> <th>MHz</th> <th>dBuV/m</th> <th>dBuV/m</th> <th>dB</th> <th>dBuV</th> <th>dB/m</th> <th>dB</th> <th>dB</th> <th>dB</th> <th>cm</th> <th>deg</th> </tr> </thead> <tbody> <tr> <td>1</td> <td>2483.72</td> <td>59.84</td> <td>74.00</td> <td>-14.16</td> <td>47.02</td> <td>32.40</td> <td>6.83</td> <td>32.41</td> <td>6.00</td> <td>101</td> <td>300</td> <td>PEAK</td> </tr> <tr> <td>2</td> <td>2483.72</td> <td>35.05</td> <td>54.00</td> <td>-18.95</td> <td>22.23</td> <td>32.40</td> <td>6.83</td> <td>32.41</td> <td>6.00</td> <td>101</td> <td>300</td> <td>AVERAGE</td> </tr> </tbody> </table>	Limit	Over	Read	Ant	Cable	Preamp	Aux	APos	TPos	Remark	Freq	Level	Line	Limit	Level	Factor	Loss	Factor	Factor		MHz	dBuV/m	dBuV/m	dB	dBuV	dB/m	dB	dB	dB	cm	deg	1	2483.72	59.84	74.00	-14.16	47.02	32.40	6.83	32.41	6.00	101	300	PEAK	2	2483.72	35.05	54.00	-18.95	22.23	32.40	6.83	32.41	6.00	101	300	AVERAGE	<table border="1"> <thead> <tr> <th>Limit</th> <th>Over</th> <th>Read</th> <th>Ant</th> <th>Cable</th> <th>Preamp</th> <th>Aux</th> <th>APos</th> <th>TPos</th> <th>Remark</th> </tr> <tr> <th>Freq</th> <th>Level</th> <th>Line</th> <th>Limit</th> <th>Level</th> <th>Factor</th> <th>Loss</th> <th>Factor</th> <th>Factor</th> <th></th> </tr> <tr> <th>MHz</th> <th>dBuV/m</th> <th>dBuV/m</th> <th>dB</th> <th>dBuV</th> <th>dB/m</th> <th>dB</th> <th>dB</th> <th>dB</th> <th>cm</th> <th>deg</th> </tr> </thead> <tbody> <tr> <td>1</td> <td>2480.00</td> <td>104.77</td> <td>-----</td> <td>-----</td> <td>91.95</td> <td>32.40</td> <td>6.83</td> <td>32.41</td> <td>6.00</td> <td>101</td> <td>300</td> <td>PEAK</td> </tr> <tr> <td>2</td> <td>2480.00</td> <td>79.98</td> <td>-----</td> <td>-----</td> <td>67.16</td> <td>32.40</td> <td>6.83</td> <td>32.41</td> <td>6.00</td> <td>101</td> <td>300</td> <td>AVERAGE</td> </tr> </tbody> </table>	Limit	Over	Read	Ant	Cable	Preamp	Aux	APos	TPos	Remark	Freq	Level	Line	Limit	Level	Factor	Loss	Factor	Factor		MHz	dBuV/m	dBuV/m	dB	dBuV	dB/m	dB	dB	dB	cm	deg	1	2480.00	104.77	-----	-----	91.95	32.40	6.83	32.41	6.00	101	300	PEAK	2	2480.00	79.98	-----	-----	67.16	32.40	6.83	32.41	6.00	101	300	AVERAGE
Limit	Over	Read	Ant	Cable	Preamp	Aux	APos	TPos	Remark																																																																																																											
Freq	Level	Line	Limit	Level	Factor	Loss	Factor	Factor																																																																																																												
MHz	dBuV/m	dBuV/m	dB	dBuV	dB/m	dB	dB	dB	cm	deg																																																																																																										
1	2483.72	59.84	74.00	-14.16	47.02	32.40	6.83	32.41	6.00	101	300	PEAK																																																																																																								
2	2483.72	35.05	54.00	-18.95	22.23	32.40	6.83	32.41	6.00	101	300	AVERAGE																																																																																																								
Limit	Over	Read	Ant	Cable	Preamp	Aux	APos	TPos	Remark																																																																																																											
Freq	Level	Line	Limit	Level	Factor	Loss	Factor	Factor																																																																																																												
MHz	dBuV/m	dBuV/m	dB	dBuV	dB/m	dB	dB	dB	cm	deg																																																																																																										
1	2480.00	104.77	-----	-----	91.95	32.40	6.83	32.41	6.00	101	300	PEAK																																																																																																								
2	2480.00	79.98	-----	-----	67.16	32.40	6.83	32.41	6.00	101	300	AVERAGE																																																																																																								



Mode	3																																																																																																															
	Band Edge																																																																																																															
	2400-2483.5_Bluetooth EDR_8-DPSK_CH78_2480MHz																																																																																																															
ANT	1																																																																																																															
Pol.	Vertical	Fundamental																																																																																																														
Peak	<table border="1"> <thead> <tr> <th>Limit</th> <th>Over</th> <th>Read</th> <th>Ant</th> <th>Cable</th> <th>Preamp</th> <th>Aux</th> <th>APos</th> <th>TPos</th> <th>Remark</th> </tr> <tr> <th>Freq</th> <th>Level</th> <th>Line</th> <th>Limit</th> <th>Level</th> <th>Factor</th> <th>Loss</th> <th>Factor</th> <th>Factor</th> <th></th> </tr> <tr> <th>MHz</th> <th>dBuV/m</th> <th>dBuV/m</th> <th>dB</th> <th>dBuV</th> <th>dB/m</th> <th>dB</th> <th>dB</th> <th>dB</th> <th>cm</th> <th>deg</th> </tr> </thead> <tbody> <tr> <td>1</td> <td>2484.72</td> <td>57.85</td> <td>74.00</td> <td>-16.15</td> <td>45.03</td> <td>32.40</td> <td>6.83</td> <td>32.41</td> <td>6.00</td> <td>139</td> <td>0 PEAK</td> </tr> <tr> <td>2</td> <td>2484.72</td> <td>33.06</td> <td>54.00</td> <td>-20.94</td> <td>20.24</td> <td>32.40</td> <td>6.83</td> <td>32.41</td> <td>6.00</td> <td>139</td> <td>0 AVERAGE</td> </tr> </tbody> </table>	Limit	Over	Read	Ant	Cable	Preamp	Aux	APos	TPos	Remark	Freq	Level	Line	Limit	Level	Factor	Loss	Factor	Factor		MHz	dBuV/m	dBuV/m	dB	dBuV	dB/m	dB	dB	dB	cm	deg	1	2484.72	57.85	74.00	-16.15	45.03	32.40	6.83	32.41	6.00	139	0 PEAK	2	2484.72	33.06	54.00	-20.94	20.24	32.40	6.83	32.41	6.00	139	0 AVERAGE	<table border="1"> <thead> <tr> <th>Limit</th> <th>Over</th> <th>Read</th> <th>Ant</th> <th>Cable</th> <th>Preamp</th> <th>Aux</th> <th>APos</th> <th>TPos</th> <th>Remark</th> </tr> <tr> <th>Freq</th> <th>Level</th> <th>Line</th> <th>Limit</th> <th>Level</th> <th>Factor</th> <th>Loss</th> <th>Factor</th> <th>Factor</th> <th></th> </tr> <tr> <th>MHz</th> <th>dBuV/m</th> <th>dBuV/m</th> <th>dB</th> <th>dBuV</th> <th>dB/m</th> <th>dB</th> <th>dB</th> <th>dB</th> <th>cm</th> <th>deg</th> </tr> </thead> <tbody> <tr> <td>1</td> <td>2480.00</td> <td>103.47</td> <td>-----</td> <td>-----</td> <td>90.65</td> <td>32.40</td> <td>6.83</td> <td>32.41</td> <td>6.00</td> <td>139</td> <td>0 PEAK</td> </tr> <tr> <td>2</td> <td>2480.00</td> <td>78.68</td> <td>-----</td> <td>-----</td> <td>65.86</td> <td>32.40</td> <td>6.83</td> <td>32.41</td> <td>6.00</td> <td>139</td> <td>0 AVERAGE</td> </tr> </tbody> </table>	Limit	Over	Read	Ant	Cable	Preamp	Aux	APos	TPos	Remark	Freq	Level	Line	Limit	Level	Factor	Loss	Factor	Factor		MHz	dBuV/m	dBuV/m	dB	dBuV	dB/m	dB	dB	dB	cm	deg	1	2480.00	103.47	-----	-----	90.65	32.40	6.83	32.41	6.00	139	0 PEAK	2	2480.00	78.68	-----	-----	65.86	32.40	6.83	32.41	6.00	139	0 AVERAGE
Limit	Over	Read	Ant	Cable	Preamp	Aux	APos	TPos	Remark																																																																																																							
Freq	Level	Line	Limit	Level	Factor	Loss	Factor	Factor																																																																																																								
MHz	dBuV/m	dBuV/m	dB	dBuV	dB/m	dB	dB	dB	cm	deg																																																																																																						
1	2484.72	57.85	74.00	-16.15	45.03	32.40	6.83	32.41	6.00	139	0 PEAK																																																																																																					
2	2484.72	33.06	54.00	-20.94	20.24	32.40	6.83	32.41	6.00	139	0 AVERAGE																																																																																																					
Limit	Over	Read	Ant	Cable	Preamp	Aux	APos	TPos	Remark																																																																																																							
Freq	Level	Line	Limit	Level	Factor	Loss	Factor	Factor																																																																																																								
MHz	dBuV/m	dBuV/m	dB	dBuV	dB/m	dB	dB	dB	cm	deg																																																																																																						
1	2480.00	103.47	-----	-----	90.65	32.40	6.83	32.41	6.00	139	0 PEAK																																																																																																					
2	2480.00	78.68	-----	-----	65.86	32.40	6.83	32.41	6.00	139	0 AVERAGE																																																																																																					



Mode	3																																																																																																																			
	Harmonic																																																																																																																			
	2400-2483.5_Bluetooth EDR_8-DPSK_CH78_2480MHz																																																																																																																			
ANT	1																																																																																																																			
Pol.	Horizontal	Vertical																																																																																																																		
Peak Avg	<table border="1"> <thead> <tr> <th>Limit</th> <th>Over</th> <th>Read</th> <th>Ant</th> <th>Cable</th> <th>Preamp</th> <th>Aux</th> <th>APos</th> <th>TPos</th> <th>Remark</th> </tr> <tr> <th>Freq</th> <th>Level</th> <th>Line</th> <th>Limit</th> <th>Level</th> <th>Factor</th> <th>Loss</th> <th>Factor</th> <th>Factor</th> <th></th> </tr> <tr> <th>MHz</th> <th>dBuV/m</th> <th>dBuV/m</th> <th>dB</th> <th>dBuV</th> <th>dB/m</th> <th>dB</th> <th>dB</th> <th>dB</th> <th>cm</th> <th>deg</th> </tr> </thead> <tbody> <tr> <td>1</td> <td>4960.00</td> <td>40.31</td> <td>74.00</td> <td>-33.69</td> <td>62.34</td> <td>34.02</td> <td>9.70</td> <td>65.75</td> <td>0.00</td> <td>---</td> <td>---</td> <td>PEAK</td> </tr> <tr> <td>2</td> <td>7440.00</td> <td>42.61</td> <td>74.00</td> <td>-31.39</td> <td>60.60</td> <td>35.62</td> <td>11.96</td> <td>65.57</td> <td>0.00</td> <td>---</td> <td>---</td> <td>PEAK</td> </tr> </tbody> </table>	Limit	Over	Read	Ant	Cable	Preamp	Aux	APos	TPos	Remark	Freq	Level	Line	Limit	Level	Factor	Loss	Factor	Factor		MHz	dBuV/m	dBuV/m	dB	dBuV	dB/m	dB	dB	dB	cm	deg	1	4960.00	40.31	74.00	-33.69	62.34	34.02	9.70	65.75	0.00	---	---	PEAK	2	7440.00	42.61	74.00	-31.39	60.60	35.62	11.96	65.57	0.00	---	---	PEAK	<table border="1"> <thead> <tr> <th>Limit</th> <th>Over</th> <th>Read</th> <th>Ant</th> <th>Cable</th> <th>Preamp</th> <th>Aux</th> <th>APos</th> <th>TPos</th> <th>Remark</th> </tr> <tr> <th>Freq</th> <th>Level</th> <th>Line</th> <th>Limit</th> <th>Level</th> <th>Factor</th> <th>Loss</th> <th>Factor</th> <th>Factor</th> <th></th> </tr> <tr> <th>MHz</th> <th>dBuV/m</th> <th>dBuV/m</th> <th>dB</th> <th>dBuV</th> <th>dB/m</th> <th>dB</th> <th>dB</th> <th>dB</th> <th>cm</th> <th>deg</th> </tr> </thead> <tbody> <tr> <td>1</td> <td>4960.00</td> <td>42.37</td> <td>74.00</td> <td>-31.63</td> <td>64.40</td> <td>34.02</td> <td>9.70</td> <td>65.75</td> <td>0.00</td> <td>---</td> <td>---</td> <td>PEAK</td> </tr> <tr> <td>2</td> <td>7440.00</td> <td>41.86</td> <td>74.00</td> <td>-32.14</td> <td>59.85</td> <td>35.62</td> <td>11.96</td> <td>65.57</td> <td>0.00</td> <td>---</td> <td>---</td> <td>PEAK</td> </tr> </tbody> </table>	Limit	Over	Read	Ant	Cable	Preamp	Aux	APos	TPos	Remark	Freq	Level	Line	Limit	Level	Factor	Loss	Factor	Factor		MHz	dBuV/m	dBuV/m	dB	dBuV	dB/m	dB	dB	dB	cm	deg	1	4960.00	42.37	74.00	-31.63	64.40	34.02	9.70	65.75	0.00	---	---	PEAK	2	7440.00	41.86	74.00	-32.14	59.85	35.62	11.96	65.57	0.00	---	---	PEAK
Limit	Over	Read	Ant	Cable	Preamp	Aux	APos	TPos	Remark																																																																																																											
Freq	Level	Line	Limit	Level	Factor	Loss	Factor	Factor																																																																																																												
MHz	dBuV/m	dBuV/m	dB	dBuV	dB/m	dB	dB	dB	cm	deg																																																																																																										
1	4960.00	40.31	74.00	-33.69	62.34	34.02	9.70	65.75	0.00	---	---	PEAK																																																																																																								
2	7440.00	42.61	74.00	-31.39	60.60	35.62	11.96	65.57	0.00	---	---	PEAK																																																																																																								
Limit	Over	Read	Ant	Cable	Preamp	Aux	APos	TPos	Remark																																																																																																											
Freq	Level	Line	Limit	Level	Factor	Loss	Factor	Factor																																																																																																												
MHz	dBuV/m	dBuV/m	dB	dBuV	dB/m	dB	dB	dB	cm	deg																																																																																																										
1	4960.00	42.37	74.00	-31.63	64.40	34.02	9.70	65.75	0.00	---	---	PEAK																																																																																																								
2	7440.00	41.86	74.00	-32.14	59.85	35.62	11.96	65.57	0.00	---	---	PEAK																																																																																																								

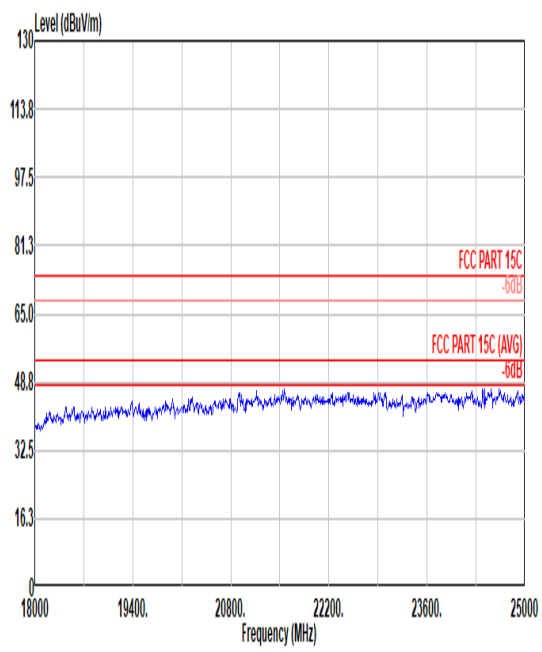
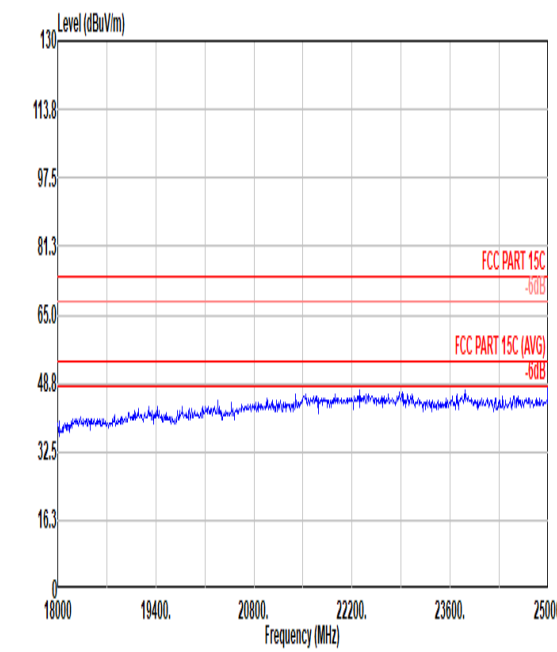

Mode	3	
	18G-25G	
	2400-2483.5_Bluetooth EDR_8-DPSK_CH78_2480MHz	
ANT	1	
Pol.	Horizontal	Vertical
Peak Avg		

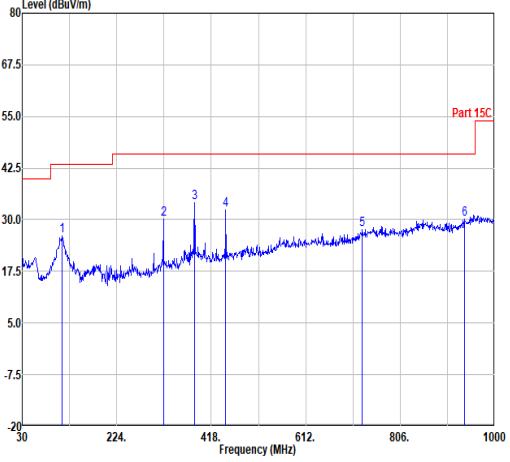
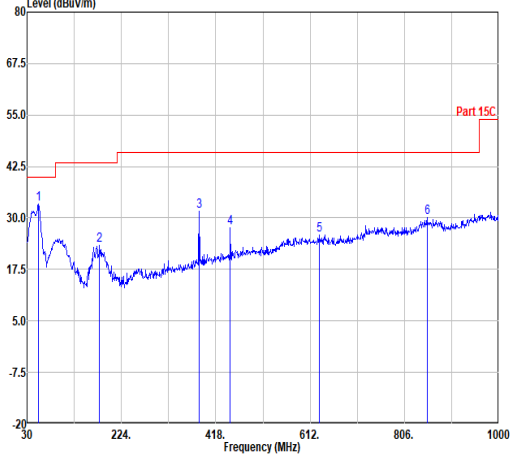

Mode	3																																																																																																																																																																																																	
	30M-1G																																																																																																																																																																																																	
	2400-2483.5_Bluetooth EDR_8-DPSK_CH78_2480MHz																																																																																																																																																																																																	
ANT	1																																																																																																																																																																																																	
Pol.	Horizontal	Vertical																																																																																																																																																																																																
Peak	 <table border="1"> <thead> <tr> <th>Peak</th> <th>Freq</th> <th>Level</th> <th>Limit</th> <th>Over</th> <th>Read</th> <th>Ant</th> <th>Cable</th> <th>Preamp</th> <th>Apos</th> <th>Tpos</th> <th>Remark</th> </tr> <tr> <th></th> <th>MHz</th> <th>dBuV/m</th> <th>dBuV/m</th> <th>dB</th> <th>dBuV</th> <th>dB/m</th> <th>dB</th> <th>dB</th> <th>cm</th> <th>deg</th> <th></th> </tr> </thead> <tbody> <tr> <td>1</td> <td>112.45</td> <td>26.23</td> <td>43.50</td> <td>-17.27</td> <td>39.49</td> <td>17.18</td> <td>1.62</td> <td>32.06</td> <td>--</td> <td>--</td> <td>Peak</td> </tr> <tr> <td>2</td> <td>320.03</td> <td>30.21</td> <td>46.00</td> <td>-15.79</td> <td>40.26</td> <td>19.38</td> <td>2.74</td> <td>32.17</td> <td>--</td> <td>--</td> <td>Peak</td> </tr> <tr> <td>3</td> <td>384.05</td> <td>34.12</td> <td>46.00</td> <td>-11.88</td> <td>42.08</td> <td>21.14</td> <td>2.99</td> <td>32.09</td> <td>--</td> <td>--</td> <td>Peak</td> </tr> <tr> <td>4</td> <td>448.07</td> <td>32.49</td> <td>46.00</td> <td>-13.51</td> <td>38.77</td> <td>22.00</td> <td>3.23</td> <td>32.31</td> <td>--</td> <td>--</td> <td>Peak</td> </tr> <tr> <td>5</td> <td>728.40</td> <td>27.62</td> <td>46.00</td> <td>-18.38</td> <td>27.97</td> <td>27.58</td> <td>4.11</td> <td>32.04</td> <td>--</td> <td>--</td> <td>Peak</td> </tr> <tr> <td>6</td> <td>938.89</td> <td>30.17</td> <td>46.00</td> <td>-15.83</td> <td>26.64</td> <td>29.77</td> <td>4.66</td> <td>30.90</td> <td>--</td> <td>--</td> <td>Peak</td> </tr> </tbody> </table>	Peak	Freq	Level	Limit	Over	Read	Ant	Cable	Preamp	Apos	Tpos	Remark		MHz	dBuV/m	dBuV/m	dB	dBuV	dB/m	dB	dB	cm	deg		1	112.45	26.23	43.50	-17.27	39.49	17.18	1.62	32.06	--	--	Peak	2	320.03	30.21	46.00	-15.79	40.26	19.38	2.74	32.17	--	--	Peak	3	384.05	34.12	46.00	-11.88	42.08	21.14	2.99	32.09	--	--	Peak	4	448.07	32.49	46.00	-13.51	38.77	22.00	3.23	32.31	--	--	Peak	5	728.40	27.62	46.00	-18.38	27.97	27.58	4.11	32.04	--	--	Peak	6	938.89	30.17	46.00	-15.83	26.64	29.77	4.66	30.90	--	--	Peak	 <table border="1"> <thead> <tr> <th>Peak</th> <th>Freq</th> <th>Level</th> <th>Limit</th> <th>Over</th> <th>Read</th> <th>Ant</th> <th>Cable</th> <th>Preamp</th> <th>Apos</th> <th>Tpos</th> <th>Remark</th> </tr> <tr> <th></th> <th>MHz</th> <th>dBuV/m</th> <th>dBuV/m</th> <th>dB</th> <th>dBuV</th> <th>dB/m</th> <th>dB</th> <th>dB</th> <th>cm</th> <th>deg</th> <th></th> </tr> </thead> <tbody> <tr> <td>1</td> <td>53.28</td> <td>33.30</td> <td>40.00</td> <td>-6.70</td> <td>51.31</td> <td>12.95</td> <td>1.11</td> <td>32.07</td> <td>--</td> <td>--</td> <td>Peak</td> </tr> <tr> <td>2</td> <td>179.38</td> <td>23.38</td> <td>43.50</td> <td>-20.12</td> <td>38.56</td> <td>14.86</td> <td>2.04</td> <td>32.08</td> <td>--</td> <td>--</td> <td>Peak</td> </tr> <tr> <td>3</td> <td>384.05</td> <td>31.56</td> <td>46.00</td> <td>-14.44</td> <td>39.52</td> <td>21.14</td> <td>2.99</td> <td>32.09</td> <td>--</td> <td>--</td> <td>Peak</td> </tr> <tr> <td>4</td> <td>448.07</td> <td>27.58</td> <td>46.00</td> <td>-18.42</td> <td>33.86</td> <td>22.80</td> <td>3.23</td> <td>32.31</td> <td>--</td> <td>--</td> <td>Peak</td> </tr> <tr> <td>5</td> <td>630.43</td> <td>25.93</td> <td>46.00</td> <td>-20.07</td> <td>27.86</td> <td>26.31</td> <td>3.84</td> <td>32.08</td> <td>--</td> <td>--</td> <td>Peak</td> </tr> <tr> <td>6</td> <td>852.56</td> <td>30.10</td> <td>46.00</td> <td>-15.90</td> <td>27.46</td> <td>29.68</td> <td>4.44</td> <td>31.48</td> <td>--</td> <td>--</td> <td>Peak</td> </tr> </tbody> </table>	Peak	Freq	Level	Limit	Over	Read	Ant	Cable	Preamp	Apos	Tpos	Remark		MHz	dBuV/m	dBuV/m	dB	dBuV	dB/m	dB	dB	cm	deg		1	53.28	33.30	40.00	-6.70	51.31	12.95	1.11	32.07	--	--	Peak	2	179.38	23.38	43.50	-20.12	38.56	14.86	2.04	32.08	--	--	Peak	3	384.05	31.56	46.00	-14.44	39.52	21.14	2.99	32.09	--	--	Peak	4	448.07	27.58	46.00	-18.42	33.86	22.80	3.23	32.31	--	--	Peak	5	630.43	25.93	46.00	-20.07	27.86	26.31	3.84	32.08	--	--	Peak	6	852.56	30.10	46.00	-15.90	27.46	29.68	4.44	31.48	--	--	Peak
Peak	Freq	Level	Limit	Over	Read	Ant	Cable	Preamp	Apos	Tpos	Remark																																																																																																																																																																																							
	MHz	dBuV/m	dBuV/m	dB	dBuV	dB/m	dB	dB	cm	deg																																																																																																																																																																																								
1	112.45	26.23	43.50	-17.27	39.49	17.18	1.62	32.06	--	--	Peak																																																																																																																																																																																							
2	320.03	30.21	46.00	-15.79	40.26	19.38	2.74	32.17	--	--	Peak																																																																																																																																																																																							
3	384.05	34.12	46.00	-11.88	42.08	21.14	2.99	32.09	--	--	Peak																																																																																																																																																																																							
4	448.07	32.49	46.00	-13.51	38.77	22.00	3.23	32.31	--	--	Peak																																																																																																																																																																																							
5	728.40	27.62	46.00	-18.38	27.97	27.58	4.11	32.04	--	--	Peak																																																																																																																																																																																							
6	938.89	30.17	46.00	-15.83	26.64	29.77	4.66	30.90	--	--	Peak																																																																																																																																																																																							
Peak	Freq	Level	Limit	Over	Read	Ant	Cable	Preamp	Apos	Tpos	Remark																																																																																																																																																																																							
	MHz	dBuV/m	dBuV/m	dB	dBuV	dB/m	dB	dB	cm	deg																																																																																																																																																																																								
1	53.28	33.30	40.00	-6.70	51.31	12.95	1.11	32.07	--	--	Peak																																																																																																																																																																																							
2	179.38	23.38	43.50	-20.12	38.56	14.86	2.04	32.08	--	--	Peak																																																																																																																																																																																							
3	384.05	31.56	46.00	-14.44	39.52	21.14	2.99	32.09	--	--	Peak																																																																																																																																																																																							
4	448.07	27.58	46.00	-18.42	33.86	22.80	3.23	32.31	--	--	Peak																																																																																																																																																																																							
5	630.43	25.93	46.00	-20.07	27.86	26.31	3.84	32.08	--	--	Peak																																																																																																																																																																																							
6	852.56	30.10	46.00	-15.90	27.46	29.68	4.44	31.48	--	--	Peak																																																																																																																																																																																							

Appendix D. Duty Cycle Plots

DH5 on time (One Pulse) Plot on Channel 78

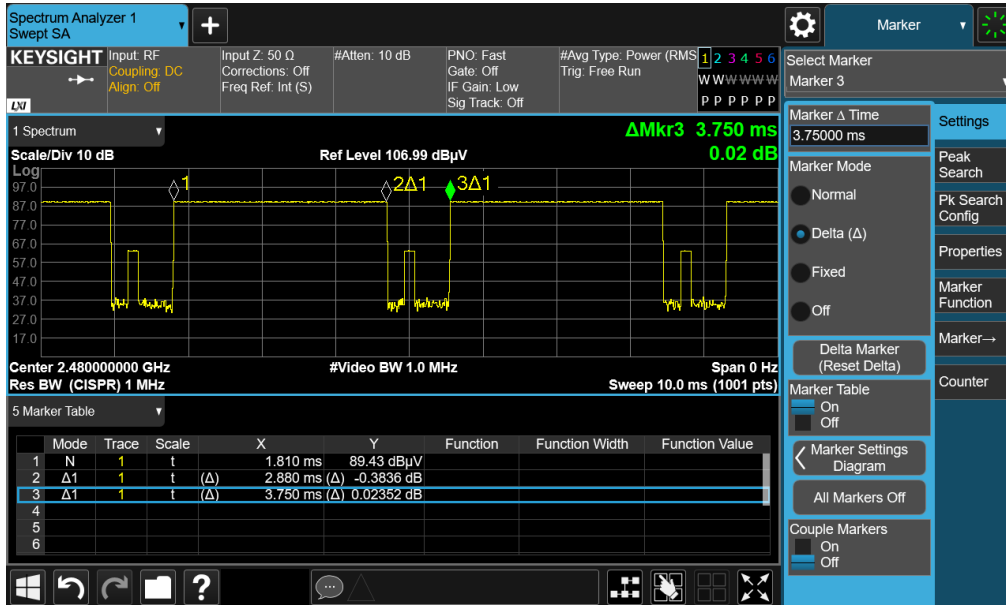

DH5 on time (Count Pulses) Plot on Channel 78

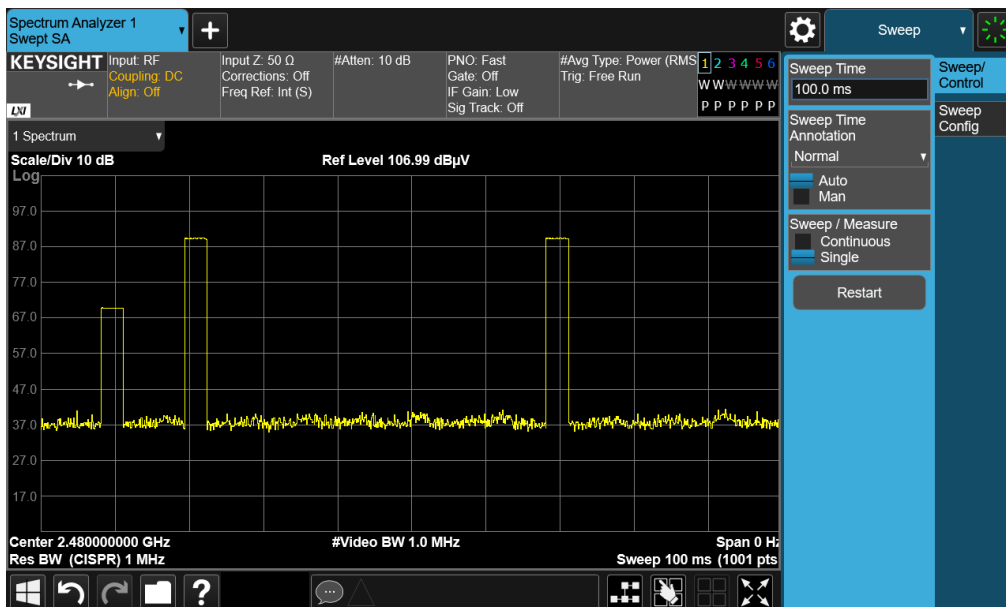

Note:

1. Worst case Duty cycle = on time/100 milliseconds = $2 * 2.88 / 100 = 5.76 \%$
2. Worst case Duty cycle correction factor = $20 * \log(\text{Duty cycle}) = -24.79 \text{ dB}$
3. DH5 has the highest duty cycle worst case and is reported.