

Alignment

Introduction

The VX-261 is carefully aligned at the factory for the specified performance across the frequency range specified for each version. Realignment should therefore not be necessary except in the event of a component failure, or altering version type. All component replacement and service should be performed only by an authorized Vertex Standard representative, or the warranty policy may be void.

The following procedures cover the sometimes critical and tedious adjustments that are not normally required once the transceiver has left the factory. However, if damage occurs and some parts subsequently are replaced, realignment may be required. If a sudden problem occurs during normal operation, it is likely due to component failure; realignment should not be done until after the faulty component has been replaced.

We recommend that servicing be performed only by authorized Vertex Standard service technicians who are experienced with the circuitry and fully equipped for repair and alignment. Therefore, if a fault is suspected, contact the dealer from whom the transceiver was purchased for instructions regarding repair. Authorized Vertex Standard service technicians realign all circuits and make complete performance checks to ensure compliance with factory specifications after replacing any faulty components.

Those who do undertake any of the following alignments are cautioned to proceed at their own risk. Problems caused by unauthorized attempts at realignment are not covered by the warranty policy. Also, Vertex Standard reserves the right to change circuits and alignment procedures in the interest of improved performance, without notifying owners.

Under no circumstances should any alignment be attempted unless the normal function and operation of the transceiver are clearly understood, the cause of the malfunction has been clearly pinpointed and any faulty components replaced, and realignment determined to be absolutely necessary.

The following test equipment (and thorough familiarity with its correct use) is necessary for complete realignment. Correction of problems caused by misalignment resulting from use of improper test equipment is not covered under the warranty policy. While most steps do not require all of the equipment listed, the interactions of some adjustments may require that more complex adjustments be performed afterwards. Do not attempt to perform only a single step unless it is clearly isolated electrically from all other steps. Have all test equipment ready before beginning, and follow all of the steps in a section in the order presented.

Required Test Equipment

- RF Signal Generator with calibrated output level at 600 MHz
- Oscilloscope
- Deviation Meter (linear detector)
- In-line Wattmeter with 5 % accuracy at 600 MHz
- 50 Ohm RF Dummy Load with power rating 10 W at 600 MHz
- Regulated DC Power Supply (standard 7.5 V DC, 3 A)
- Frequency Counter with 0.2 ppm accuracy at 600 MHz
- Audio Signal Generator
- AC Voltmeter
- DC Voltmeter
- UHF Sampling Coupler
- IBM® PC/compatible Computer with Microsoft® Windows® 2000, XP, Vista or Windows7
- Vertex Standard CE150 PC Programming Software
- Vertex Standard FIF-12 USB Programming Interface and CT-104A, CT-106, or CT-171 PC Programming Cable.
- Vertex Standard FRB-6 Tuning Interface Box and CT-160 Connection Cable.
- Vertex Standard CN-3 (P/N: A08760001) Antenna Connector

Alignment Preparation & Precautions

A 50-Ohm RF Dummy Load and in-line wattmeter must be connected to the main antenna jack in all procedures that call for transmission, except where specified otherwise. Correct alignment is not possible with an antenna.

Because of the BTL (Bridged Trans Less) Amplifier circuit used in the VX-261, do not connect earth side of the speaker leads to chassis "ground".

After completing one step, read the following step to determine whether the same test equipment will be required. If not, remove the test equipment (except dummy load and wattmeter, if connected) before proceeding.

Correct alignment requires that the ambient temperature be the same as that of the transceiver and test equipment, and that this temperature be held constant between 68 and 86 °F (20 ~ 30 °C). When the transceiver is brought into the shop from hot or cold air, it should be allowed time to come to room temperature before alignment.

Whenever possible, alignments should be made with oscillator shields and circuit boards firmly affixed in place. Also, the test equipment must be thoroughly warmed up before beginning.

Note: Signal levels in dB referred to in the alignment procedure are based on 0 dB μ EMF = 1 μ V.

Alignment

Test Setup

Setup the test equipment as shown below for transceiver alignment, then apply 7.5 V DC power to the transceiver.

The Alignment Tool Outline

Installation of the alignment tool

- ❑ Install the CE150 (PC Programming Software) to your PC.
- ❑ “Alignment“ function in the “Radio“ menu tab of CE150.

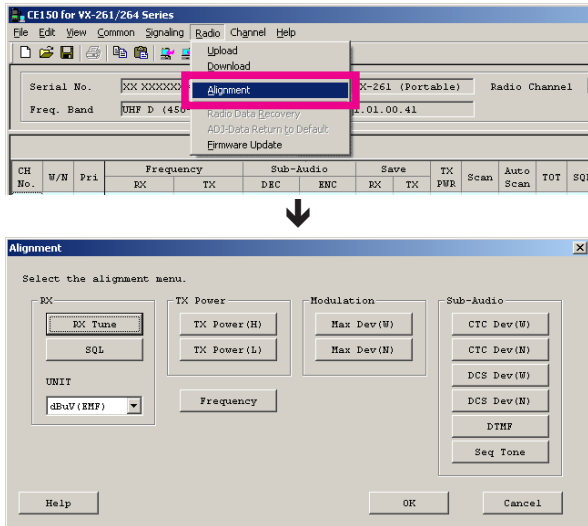

Action of the switches

When the transceiver is in the “Alignment mode,“ the action of the SIDE-1, SIDE-2, and PTT keys are ignored. All of the action is controlled by the PC.

Caution

Please never turn off the power supply during alignment. If the power supply is turned off during alignment, the alignment data will be corrupted.

Alignment Mode

In the “Alignment Mode”, the aligned data written in the radio will be able to re-align its alignment data. The value of each parameter can be changed to desired position by “←”/“→” arrow key for data up/down, “↑”/“↓” arrow key for channel up/down, direct number input, and drag the mouse.

Note: when all items are aligned, it is strongly recommended to align according to following order. The detail information is written in the help document of CE150 PC Programming Software.

1. PLL Reference Frequency (Frequency)
2. RX Sensitivity (RX Tune)
3. Squelch (SQL/RSSI)
4. TX Power <High/Low>
5. Maximum Deviation <Wide/Narrow>

Please adjust the following items when needed.

- CTCSS Deviation <Wide/Narrow>
- DCS Deviation <Wide/Narrow>
- DTMF Alignment
- Sequential Tone

Unit

During alignment, you may select the value among dBμV, μV (EMF or PD), or dBm by the “UNIT” box.

When perform the RX Tune and SQL alignment, the RF level shows this unit according to this setting.

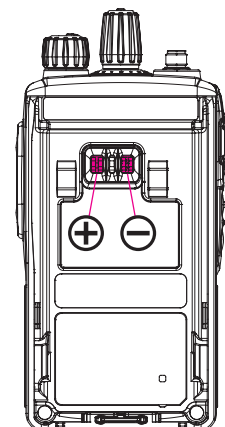
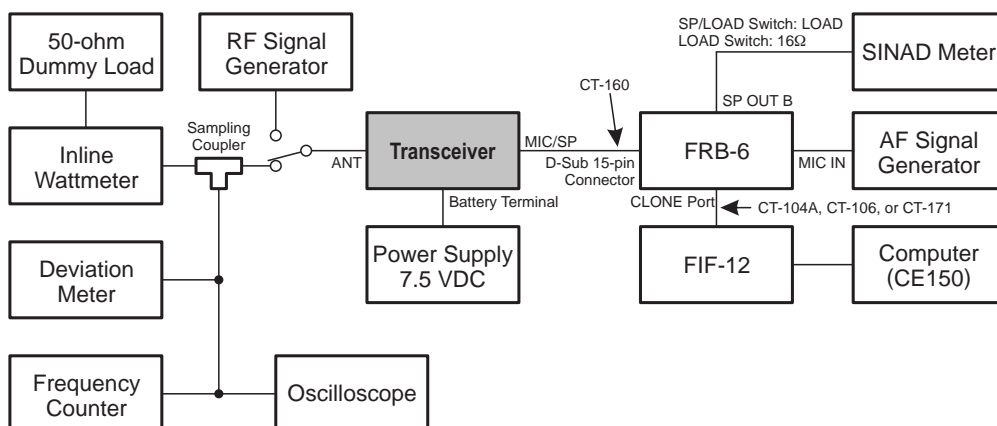

Alignment

1. PLL Reference Frequency (Frequency)

This parameter align the reference frequency for PLL.

1. Press the “Frequency” button to open the “Frequency Alignment” window.
2. Click the “PTT” button to transmit the radio on the center frequency channel.
3. Set the value to get the desired frequency according to the following ways:
 - Dragging the slide bar
 - Clicking the arrow buttons
 - Pressing the left/right arrow key of the computer’s keyboard
 - Entering the value (“0” - “255”) in the “Data” box from the computer’s keyboard
4. After getting the desired frequency, click the “PTT” button to stop transmitting.
5. Click the “OK” button to finish the frequency alignment and save the data.

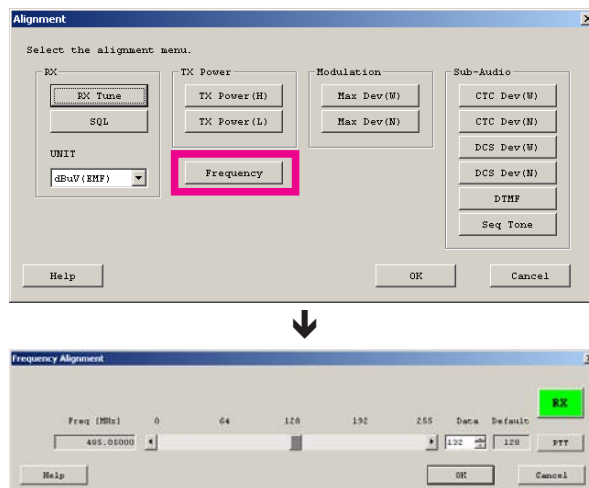

2. RX Sensitivity (RX Tune)

This parameter align the RX BPF (Band Pass Filter) for Receive (RX) sensitivity.

The PLL Reference Frequency (Frequency) alignment must be done before this alignment is performed.

1. Press the “RX Tune” button to open the “RX Sensitivity Alignment” window will appear.
2. Click the slide bar of the desired channel. The radio switches to the selected channel.
3. Set the RF Signal Generator according to the indication at the top of the screen (Setting Your SG as followings).
4. Set the value to get the best RX sensitivity (Highest RSSI value) according to the following ways:
 - Dragging the slide bar
 - Clicking the arrow buttons
 - Pressing the left/right arrow key of the computer’s keyboard
 - Entering the value (“0” - “255”) in the “Data” box from the computer’s keyboard
5. Click the “OK” button to finish the RX Sensitivity alignment and save the data.

You may select the alignment type from the “Radio” button located at the bottom of the screen (**ADJ Type**), as needed.

Basic: “Low Edge / Band Center/ High Edge” and select the channel for alignment (Default).

Single: Alignment value changes only on the selected channel.

All Freq: Alignment value changes on all channels.

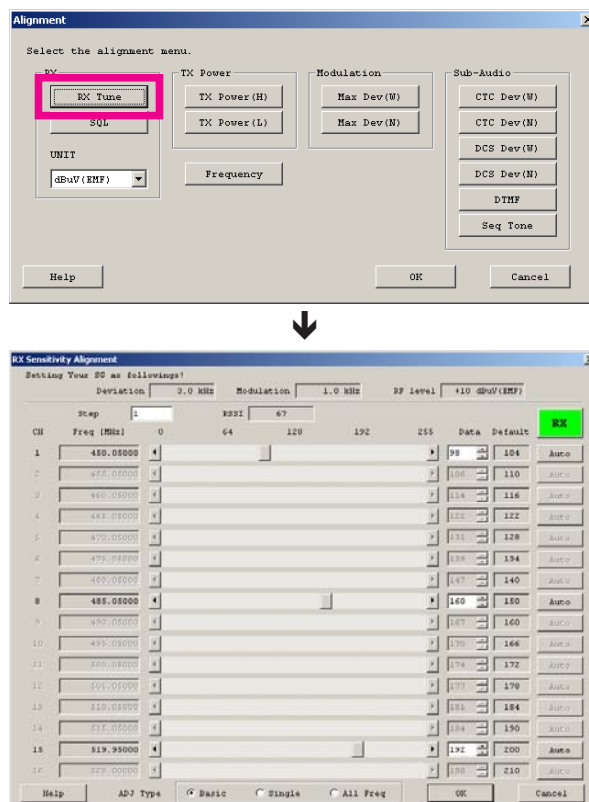

3. Squelch (SQL)

This parameter align the SQL (Squelch) Sensitivity. There are several alignments as follows in the Squelch Sensitivity.

Tight SQL Level (TI NSQ W/N)

The Alignment for the Noise SQL Tight level at Wide (5k/4k) or Narrow (2.5k).

Threshold SQL Level (TH NSQ W/N)

The Alignment for the Noise SQL Threshold level at Wide (5k/4k) or Narrow (2.5k).

Tight SQL RSSI Level (TI RSSI W/N)

The Alignment for the “level 14” of the RSSI SQL level at Wide (5k/4k) or Narrow (2.5k).

TX Save RSSI Level (TX SAVE W/N)

The Alignment for the TX Save RSSI level at Wide (5k/4k) or Narrow (2.5k).

The procedure for all the alignments is as follows.

1. Click the “SQL” button to open the “SQL Alignment” menu.
2. Click the “Start” button on the desired alignment item to open other window.
3. Set the RF Signal Generator according to the indication of the window, then click the “OK” button.
4. The automatic alignment will start to get the optimum level.
5. The alignment result will appear in the “New” box.

On the following alignment items, click the “OK” button and then repeat step 2-5 several times according to the indication of the window.

Threshold SQL Level (Wide/Narrow)

Normal RSSI Level (Wide/Narrow)

Tight RSSI Level (Wide/Narrow)

Other alignment items has not extra step; only one step procedure.

6. Click the “OK” button, then the data will be saved and the alignment is finished.

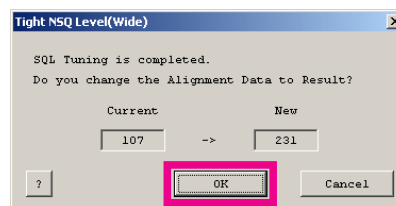
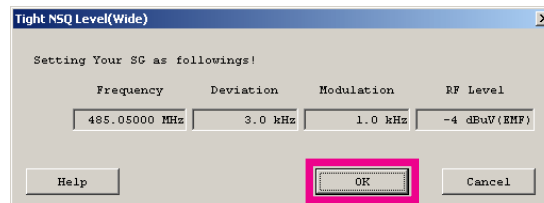
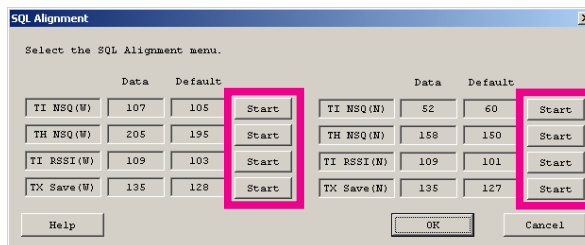
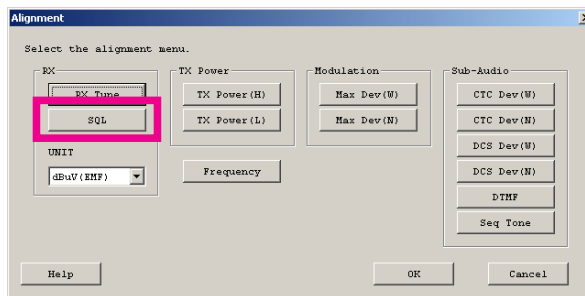

4. TX Power

This parameter align the Transmit Output “High” or “Low” Power for the selected channel.

1. Press the “TX Power (H / L)” button to open the “TX Power Alignment” window.
3. Click the “PTT” button on the desired channel. The radio starts to transmit on the selected channel.
4. Set the value to get desired output power (Normally: High: 5 W, Low: 1 W) on the Power Meter according to the following ways:
 - Dragging the slide bar
 - Clicking the arrow buttons
 - Pressing the left/right arrow key of the computer’s keyboard
 - Entering the value (“0” - “255”) in the “Data” box from the computer’s keyboard
5. After getting the desired output power, click the “PTT” button to stop transmitting.
6. Click the “OK” button to finish the TX Power alignment and save the data.

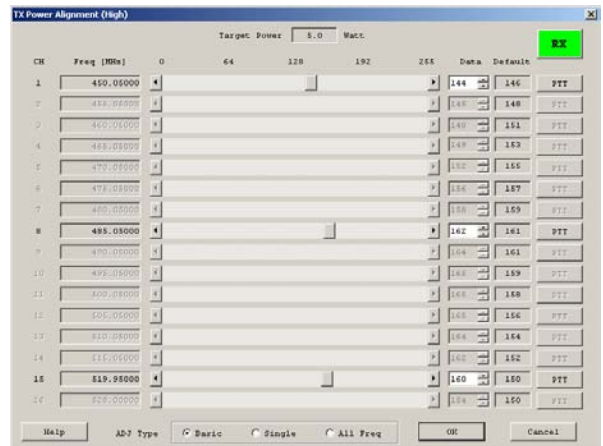
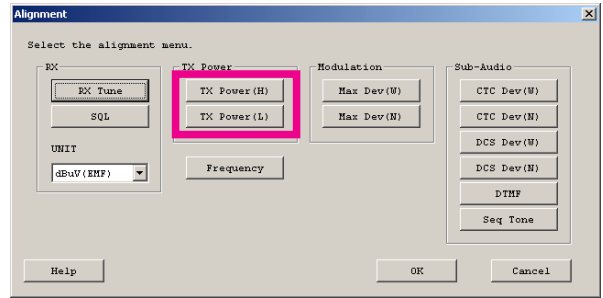

You may select the alignment type from the “Radio” button located at the button of the screen (**ADJ Type**), as needed.

Basic: “Low Edge / Band Center/ High Edge” and select the channel for alignment (Default).

Single: Alignment value changes only on the selected channel.

All Freq: Alignment value changes on all channels.

5. Maximum Deviation <Wide> / <Narrow>

This parameter align the Maximum Deviation (Wide/Narrow).

1. Press the “Max Dev (W / N)” button to open the “Max Deviation Alignment” window.
2. Set the Audio Signal Generator to 100 mV with a 1 kHz tone, Sine Wave.
3. Click the “PTT” button on the desired channel. The radio starts to transmit on the selected channel.
4. Set the value to get desired deviation (Wide: 4.2 kHz, Narrow: 2.1 kHz) on the deviation meter according to the following ways:
 - Dragging the slide bar
 - Clicking the arrow buttons
 - Pressing the left/right arrow key of the computer’s keyboard
 - Entering the value (“0” - “255”) in the “Data” box from the computer’s keyboard
5. After getting the desired deviation, click the “PTT” button to stop transmitting.
6. Click the “OK” button to finish the Max Deviation alignment and save the data.

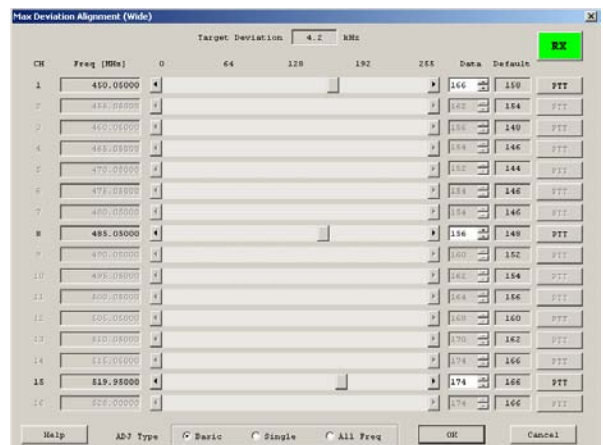
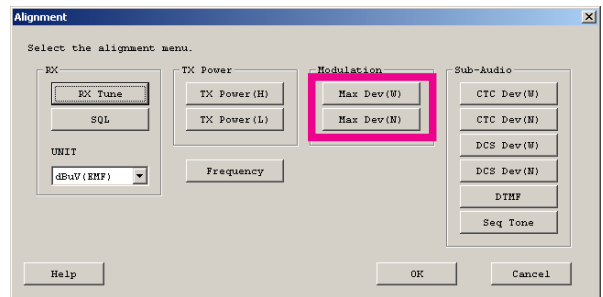

You may select the alignment type from the “Radio” button located at the button of the screen (**ADJ Type**), as needed.

Basic: “Low Edge / Band Center/ High Edge” and select the channel for alignment (Default).

Single: Alignment value changes only on the selected channel.

All Freq: Alignment value changes on all channels.

Adjust the following items if needed.

CTCSS Deviation <Wide> / <Narrow>

This parameter align the CTCSS Deviation of the selected channel.

1. Press the “CTC Dev (W/N)” button to open the “CTCSS Deviation Alignment” window will appear.
2. Click the “PTT” button on the desired channel. The radio starts to transmit with the CTCSS tone on the selected channel.
3. Set the value to get desired deviation (Nominal: Wide: 0.55 kHz, Narrow: 0.35 kHz) on the deviation meter according to the following ways:
 - Dragging the slide bar
 - Clicking the arrow buttons
 - Pressing the left/right arrow key of the computer’s keyboard
 - Entering the value (“0” - “255”) in the “Data” box from the computer’s keyboard
4. After getting the desired deviation, click the “PTT” button to stop transmitting.
5. Click the “OK” button to finish the CTCSS Deviation alignment and save the data.

You may select the alignment type from the “Radio” button located at the button of the screen (**ADJ Type**), as needed.

Basic: “Low Edge / Band Center/ High Edge” and select the channel for alignment (Default).

Single: Alignment value changes only on the selected channel.

All Freq: Alignment value changes on all channels.

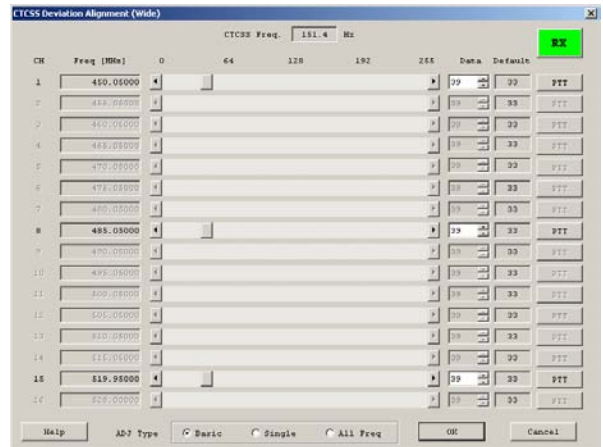
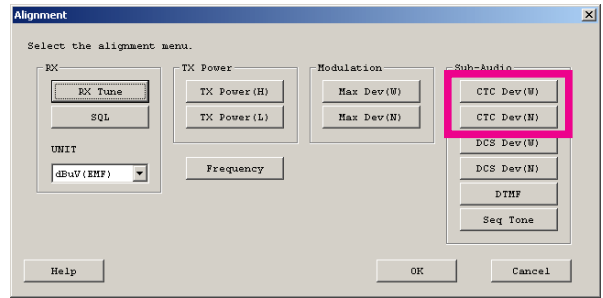

DCS Deviation <Wide> / <Narrow>

This parameter is to align the DCS Deviation of the selected channel.

1. Press the “DCS Dev (W/N)” button to open the “DCS Deviation Alignment” window.
2. Click the “PTT” button on the desired channel. The radio starts to transmit with the DCS code on the selected channel.
3. Set the value to get desired deviation (Nominal: Wide: 0.55 kHz, Narrow: 0.35 kHz) on the deviation meter according to the following ways:
 - Dragging the slide bar
 - Clicking the arrow buttons
 - Pressing the left/right arrow key of the computer’s keyboard
 - Entering the value (“0” - “255”) in the “Data” box from the computer’s keyboard
4. After getting the desired deviation, click “PTT” button to stop transmitting.
5. Click the “OK” button to finish the DCS Deviation alignment and save the data.

You may select the alignment type from the “Radio” button located at the button of the screen (**ADJ Type**), as needed.

Basic: “Low Edge / Band Center/ High Edge” and select the channel for alignment (Default).

Single: Alignment value changes only on the selected channel.

All Freq: Alignment value changes on all channels.

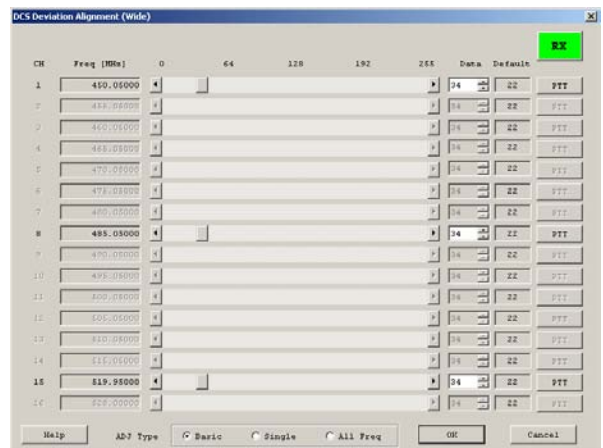
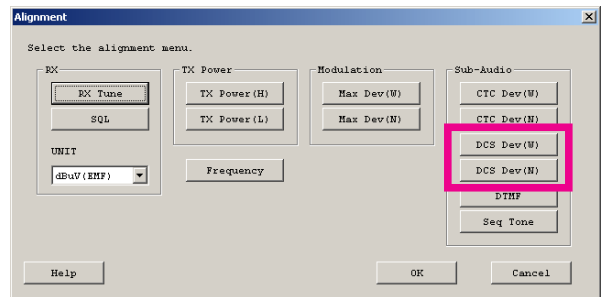

DTMF Deviation

This parameter align the DTMF Deviation.

1. Press the “DTMF” button to open the “DTMF Alignment” window.
2. Click the “PTT” button to transmit the radio on the center frequency channel.
3. Set the value to get desired deviation (Nominal: 3.0 kHz) on the deviation meter according to the following ways:
 - Dragging the slide bar
 - Clicking the arrow buttons
 - Pressing the left/right arrow key of the computer’s keyboard
 - Entering the value (“0” - “255”) in the “Data” box from the computer’s keyboard
4. After getting the desired deviation, click the “PTT” button to stop transmitting.
5. Click the “OK” button to finish the DTMF Deviation alignment and save the data.

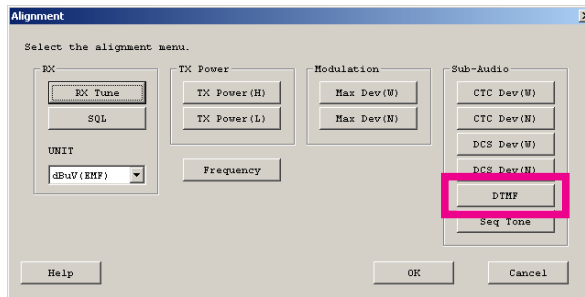

Sequential Tone Deviation

This parameter align the Sequential Tone Deviation for the 2-Tone and 5-Tone Encoder.

1. Press the “Seq Tone” button to open the “Sequential Tone Deviation Alignment” window will appear.
2. Click the “PTT” button to transmit the radio on the center frequency channel.
3. Set the value to get desired deviation (Nominal: 3.0 kHz) on the deviation meter according to the following ways:
 - Dragging the slide bar
 - Clicking the arrow buttons
 - Pressing the left/right arrow key of the computer’s keyboard
 - Entering the value (“0” - “255”) in the “Data” box from the computer’s keyboard
4. After getting the desired deviation, click the “PTT” button to stop transmitting.
5. Click the “OK” button to finish the Sequential Tone Deviation alignment and save the data.

