

PHILIPS

Interactive Display

3000 Series

10BDL3351T



User Manual (English)

Warranty policy for Philips Professional Display Solutions	44
Index.....	46

Table Of Contents

1. Safety Instructions	1
2. Unpacking and Installation.....	7
2.1. Package Contents.....	7
2.2. Installation	8
2.2.1. Connecting the power cable	8
2.2.2. Connecting the network cable	8
2.2.3. Inserting the Micro SD card.....	8
2.2.4. Mounting and installation	9
3. Physical view and features	11
3.1. Left View	11
3.2. Input/Output Terminals.....	12
4. Operation	13
4.1. Setup wizard	13
4.1.1. Welcome	13
4.1.2. Date & Time	13
4.1.3. Clone Media Files into internal	13
4.1.4. Signage Display Settings.....	14
4.1.5. Security Setting	14
4.1.6. Network Setting	14
4.1.7. Setup Complete	15
4.2. Android Launcher	16
4.2.1. Android PD launcher.....	16
4.2.2. Admin mode:.....	16
4.3. Setting menu	18
4.3.1. Network & Internet	18
4.3.2. Connected devices	20
4.3.3. Signage Display.....	20
4.3.4. Apps	34
4.3.5. Sound.....	34
4.3.6. Display	34
4.3.7. Accessibility.....	36
4.3.8. Security.....	36
4.3.9. System.....	37
4.3.10. About.....	39
5. Appendix	40
5.1. Advanced features.....	40
5.2. File manager app.....	40
6. Cleaning and Troubleshooting	42
6.1. Cleaning	42
6.2. Troubleshooting	42
7. Technical Data.....	43
7.1. Specifications.....	43
7.2. Disclaimer	43

1. Safety Instructions

Safety precautions and maintenance

This electronic user guide is intended for anyone who uses the Philips monitor. Take time to read this user manual before you use your monitor. It contains important information and notes regarding operating your monitor. The Philips guarantee applies provided the product is handled properly for its intended use, in accordance with its operating instructions and upon presentation of the original invoice or cash receipt, indicating the date of purchase, dealers name and model and production number of the product.



WARNING: Use of controls, adjustments or procedures other than those specified in this documentation may result in exposure to shock, electrical hazards and/or mechanical hazards.

Read and follow these instructions when connecting and using your display:

Operation:

- Keep the display out of direct sunlight and away from stoves or any other heat sources.
- Remove any object that could fall into ventilation holes or prevent proper cooling of the display's electronics.
- Do not block the ventilation holes on the cabinet.
- When positioning the display, make sure the power plug and outlet are easily accessible.
- When turning off the display by detaching the power cord or DC power cord, wait 6 seconds before re-attaching the power cord or DC power cord for normal operation.
- Ensure the use of an approved power cord provided by Philips at all times. If your power cord is missing, please contact your local service center.
- Do not subject the display to severe vibration or high impact conditions during operation.
- Do not knock or drop the display during operation or transportation.

Maintenance:

- To protect your display from possible damage, do not put excessive pressure on the LCD panel. When moving your display, grasp the frame to lift; do not lift the display by placing your hand or fingers on the LCD panel.
- Unplug the display if you are not going to use it for an extensive period of time.
- Unplug the display if you need to clean it with a slightly damp cloth. The screen may be wiped with a dry cloth when the power is off. However, never use organic solvent, such as, alcohol, or ammonia-based liquids to clean your display.
- To avoid the risk of shock or permanent damage to the set, do not expose the display to dust, rain, water or an excessively moist environment.
- If your display becomes wet, wipe it with dry cloth as soon as possible.
- If a foreign substance or water gets in your display, turn the power off immediately and disconnect the power cord. Then remove the foreign substance or water, and send the unit to the maintenance center.
- Do not store or use the display in locations exposed to heat, direct sunlight or extreme cold.
- In order to maintain the best performance of your display and ensure a longer lifetime, we strongly recommend using the display in a location that falls within the following temperature and humidity ranges.
 - Temperature: 0-40°C 32-104°F
 - Humidity: 10-85% RH

IMPORTANT: Always activate a moving screen saver program when you leave your display unattended. Always activate a periodic screen refresh application if the unit will display unchanging static content. Uninterrupted display of still or static images over an extended period may cause "burn in", also known as "after-imaging" or "ghost imaging", on your screen. This is a well-known phenomenon in LCD panel technology. In most cases, the "burned in" or "after-imaging" or "ghost imaging" will disappear gradually over a period of time after the power has been switched off.

WARNING: Severe "burn-in" or "after-image" or "ghost image" symptoms will not disappear and cannot be repaired. This is also not covered under the terms of your warranty.

Service:

- The casing cover should be opened only by qualified service personnel.
- If there is any need for repair or integration, please contact your local service center.
- Do not leave your display under direct sunlight.



If your display does not operate normally, having followed the instructions set out in this document, please contact a technician or your local service center.

Read and follow these instructions when connecting and using your display:

- Unplug the display if you are not going to use it for an extensive period of time.
- Unplug the display if you need to clean it with a slightly damp cloth. The screen may be wiped with a dry cloth when the power is off. However, never use alcohol, solvents or ammonia-based liquids.
- Consult a service technician if the display does not operate normally when you have followed the instructions in this manual.
- The casing cover should be opened only by qualified service personnel.
- Keep the display out of direct sunlight and away from stoves or any other heat sources.
- Remove any object that could fall into the vents or prevent proper cooling of the display's electronics.
- Do not block the ventilation holes on the cabinet.
- Keep the display dry. To avoid electric shock, do not expose it to rain or excessive moisture.
- When turning off the display by detaching the power cable or DC power cord, wait for 6 seconds before re-attaching the power cable or DC power cord for normal operation..
- To avoid the risk of shock or permanent damage to the set do not expose the display to rain or excessive moisture.
- When positioning the display, make sure the power plug and outlet are easily accessible.
- **IMPORTANT:** Always activate a screen saver program during your application. If a still image in high contrast remains on the screen for an extended period of time, it may leave an 'after-image' or 'ghost image' on the front of the screen. This is a well-known phenomenon that is caused by the shortcomings inherent in LCD technology. In most cases the afterimage will disappear gradually over a period of time after the power has been switched off. Be aware that the after-image symptom cannot be repaired and is not covered under warranty.

EU Declaration of Conformity

This device complies with the requirements set out in the Council Directive on the Approximation of the Laws of the Member States relating to Electromagnetic Compatibility (2014/30/EU), Low-voltage Directive (2014/35/EU), RoHS directive (2011/65/ EU), and Radio Equipment Directive (2014/53/EU).

This product has been tested and found to comply with the harmonized standards for Information Technology Equipment, these harmonized standards published under Directives of Official Journal of the European Union.

Radio Equipment Directive (2014/53/EU): EN60950-1/EN62311/EN300328/EN301489

ESD Warnings

When user close to the monitor may cause the equipment discharge and reboot to the display of main menu.

Warning:

This equipment is compliant with Class A of EN55032/CISPR 32. In a residential environment this equipment may cause radio interference.

Federal Communications Commission (FCC) Notice (U.S. Only)

NOTE: This equipment has been tested and found to comply with the limits for a Class A digital device, pursuant to part 15 of the FCC Rules. These limits are designed to provide reasonable protection against harmful interference when the equipment is operated in a commercial environment. This equipment generates, uses, and can radiate radio frequency energy and, if not installed and used in accordance with the instruction manual, may cause harmful interference to radio communications. Operation of this equipment in a residential area is likely to cause harmful interference in which case the user will be required to correct the interference at his own expense.



Changes or modifications not expressly approved by the party responsible for compliance could void the user's authority to operate the equipment.

Use only an RF shielded cable that was supplied with the display when connecting this display to a computer device.

To prevent damage which may result in fire or shock hazard, do not expose this appliance to rain or excessive moisture.

USA:

WARNING: Changes or modifications to this unit not expressly approved by the party responsible for compliance could void the user's authority to operate the equipment.

This device complies with Part 15 of the FCC Rules. Operation is subject to the following two conditions: (1) This device may not cause harmful interference, and (2) this device must accept any interference received, including interference that may cause undesired operation.

Le présent appareil est conforme aux CNR d'ISED applicables aux appareils radio exempts de licence. L'exploitation est autorisée aux deux conditions suivantes : (1) le dispositif ne doit pas produire de brouillage préjudiciable, et (2) ce dispositif doit accepter tout brouillage reçu, y compris un brouillage susceptible de provoquer un fonctionnement indésirable.

TPV USA Corp
6525 Carnegie Blvd #200
Charlotte, NC 28211
USA

Radiation Exposure Statement:

This equipment complies with FCC/CE-RED radiation exposure limits set forth for an uncontrolled environment. This equipment should be installed and operated with minimum distance 20cm between the radiator & your body.

Déclaration d'exposition aux radiations: Cet équipement est conforme aux limites d'exposition aux rayonnements ISED établies pour un environnement non contrôlé. Cet équipement doit être installé et utilisé avec un minimum de 20 cm de distance entre la source de rayonnement et votre corps.

The suitable temperature for the Color Monitor and accessories is 0°C-40°C.

The device for operation in the band 5150-5250 MHz is only for indoor use to reduce the potential for harmful interference to co-channel mobile satellite systems.

Adaptor with ferrite must be used with this equipment to ensure compliance with the Class A FCC limits.

Power Adapter information:

Model : ADS-26SGP-12 12024E

INPUT: 100-240V~ 50/60Hz

Max.0.7A

OUTPUT: 12Vdc 2.0A 24.0W

Waste Electrical and Electronic Equipment-WEEE

Attention users in European Union private households



This marking on the product or on its packaging illustrates that, under European Directive 2012/19/EU governing used electrical and electronic appliances, this product may not be disposed of with normal household waste. You are responsible for disposal of this equipment through a designated waste electrical and electronic equipment collection. To determine the locations for dropping off such waste electrical and electronic, contact your local government office, the waste disposal organization that serves your household or the store at which you purchased the product.

Attention users in United States:

Please dispose of according to all Local, State and Federal Laws. For the disposal or recycling information, contact: www.mygreenelectronics.com or www.eiae.org.

End of Life Directives-Recycling



Your new Public Information Display contains several materials that can be recycled for new users.

Please dispose of according to all Local, State, and Federal laws.

CAUTION

RISK OF EXPLOSION IF BATTERY IS REPLACED BY AN INCORRECT TYPE.

DISPOSE OF USED BATTERIES ACCORDING TO THE INSTRUCTIONS.



CAUTION

Risk of explosion if the battery is replaced by an incorrect type

Wait one-half hour after switching off before handling parts

- Replacement of a battery with an incorrect type that can defeat a safeguard (for example, in the case of some lithium battery types);
- Disposal of a battery into fire or a hot oven, or mechanically crushing or cutting of a battery, that can result in an explosion;
- Leaving a battery in an extremely high temperature surrounding environment that can result in an explosion or the leakage of flammable liquid or gas;

A battery subjected to extremely low air pressure that may result in an explosion or the leakage of flammable liquid or gas.

NOTICE**SOFTWARE END USER LICENSE AGREEMENT**

THIS SOFTWARE END USER LICENSE AGREEMENT (THIS "AGREEMENT") IS A LEGAL AND BINDING AGREEMENT BETWEEN YOU (EITHER AN INDIVIDUAL OR ENTITY) AND MMD MONITORS & DISPLAYS NEDERLAND B.V., A DUTCH LIMITED LIABILITY COMPANY, WITH ITS PRINCIPAL OFFICE AT PRINS BERNHARDPLEIN 200, 1097 JB AMSTERDAM, THE NETHERLANDS AND ITS SUBSIDIARY COMPANIES (INDIVIDUALLY AND COLLECTIVELY "MMD"). THIS AGREEMENT GIVES YOU THE RIGHT TO USE CERTAIN SOFTWARE (THE "SOFTWARE") INCLUDING USER DOCUMENTATION IN ELECTRONIC FORM WHICH MAY HAVE BEEN PROVIDED SEPARATELY OR TOGETHER WITH A MMD PRODUCT (THE DEVICE"). BY DOWNLOADING, INSTALLING OR OTHERWISE USING THE SOFTWARE, YOU ACCEPT AND AGREE TO BE BOUND BY ALL OF THE TERMS AND CONDITIONS OF THIS AGREEMENT. IF YOU DO NOT AGREE TO THESE TERMS AND CONDITIONS, DO NOT DOWNLOAD, INSTALL OR OTHERWISE USE THE SOFTWARE. IF YOU ACQUIRED THE SOFTWARE IN TANGIBLE MEDIA E.G. CD WITHOUT THE OPPORTUNITY TO REVIEW THIS LICENSE AND DO NOT ACCEPT THESE TERMS, YOU MAY RECEIVE A FULL REFUND OF THE AMOUNT, IF ANY, THAT YOU PAID FOR THE SOFTWARE IF YOU RETURN THE SOFTWARE UNUSED WITH PROOF OF PAYMENT WITHIN 30 DAYS FROM THE DATE OF PURCHASE.

- 1. Grant of License.** This Agreement grants you a non-exclusive, nontransferable, non-sub licensable license to install and use, on the Device, one (1) copy of the specified version of the Software in object code format as set out in the user documentation solely for your personal use. The Software is "in use" when it is loaded into the temporary or permanent memory (i.e. RAM, hard disk, etc.) of the Device.
- 2. Ownership.** The Software is licensed and not sold to you. This Agreement grants you only the right to use the Software, but you do not acquire any rights, express or implied, in the Software other than those specified in this Agreement. MMD and its licensors retain all right, title, and interest in and to the Software, including all patents, copyrights, trade secrets, and other intellectual property rights incorporated therein. The Software is protected by copyright laws, international treaty provisions, and other intellectual property laws. Therefore, other than as expressly set forth herein, you may not copy the Software without prior written authorization of MMD, except that you may make one (1) copy of the Software for your back-up purposes only. You may not copy any printed materials accompanying the Software, nor print more than one (1) copy of any user documentation provided in electronic form, except that you may make one (1) copy of such printed materials for your back-up purposes only.
- 3. License Restrictions.** Except as provided otherwise herein, you shall not rent, lease, sublicense, sell, assign, loan, or otherwise transfer the Software. You shall not, and you shall not permit any third party, to reverse engineer, decompile, or disassemble the Software, except to the extent that applicable law expressly prohibits the foregoing restriction. You may not remove or destroy any product identification, copyright notices, or other proprietary markings or restrictions from the Software. All titles, trademarks, and copyright and restricted rights notices shall be reproduced on your back up copy of the Software. You may not modify or adapt the Software, merge the Software into another program or create derivative works based upon the Software.
- 4. Disclaimer.** THE SOFTWARE IS DESIGNED TO ASSIST YOU IN TRANSFERRING MATERIAL IN WHICH YOU OWN THE COPYRIGHT OR HAVE OBTAINED PERMISSION TO GRAB AND TRANSFER FROM THE COPYRIGHT OWNER. UNLESS YOU OWN THE COPYRIGHT OR HAVE PERMISSION TO GRAB AND TRANSFER FROM THE COPYRIGHT OWNER, YOU MAY BE VIOLATING COPYRIGHT LAW AND BE SUBJECT TO PAYMENT OF DAMAGES AND OTHER REMEDIES. IF YOU ARE UNCERTAIN ABOUT YOUR RIGHTS, YOU SHOULD CONTACT YOUR LEGAL ADVISOR. YOU ASSUME FULL RESPONSIBILITY FOR THE LEGAL AND RESPONSIBLE USE OF THE SOFTWARE
- 5. Open Source Software.** (a) This software may contain components that are subject to open-source terms, as stated in the documentation accompanying the Device. This Agreement does not apply to this software as such. (b) Your license rights under this Agreement do not include any right or license to use, distribute or create derivative works of the Software in any manner that would subject the Software to Open Source Terms. "Open Source Terms" means the terms of any license that directly or indirectly (1) create, or purport to create, obligations for MMD with respect to the Software and/or derivative works thereof; or (2) grant, or purport to grant, to any third party any rights or immunities under intellectual property or proprietary rights in the Software or derivative works thereof.
- 6. Termination.** This Agreement shall be effective upon installation or first use of the Software and shall terminate (i) at the discretion of MMD, due to your failure to comply with any term of this Agreement; or (ii) upon destruction of all copies of the Software and related materials provided to you by MMD hereunder. MMD's rights and your obligations shall survive the termination of this Agreement.
- 7. Upgrades.** MMD may, at its sole option, make upgrades to the Software available by general posting on a website or by any other means or methods. Such upgrades may be made available pursuant to the terms of this Agreement or the release of such upgrades to you may be subject to your acceptance of another agreement.

8. Support Services. MMD is not obligated to provide technical or other support (“Support Services”) for the Software. If MMD does provide you with Support Services, these will be governed by separate terms to be agreed between you and MMD.

9. Limited Software Warranty. MMD provides the Software ‘as is’ and without any warranty except that the Software will perform substantially in accordance with the documentation accompanying the Software for a period of one year after your first download, installation or use of the Software, whichever occurs first. MMD’s entire liability and your exclusive remedy for breach of this warranty shall be, at MMD’s option, either (i) return of the price paid by you for the Software (if any); or (ii) repair or replacement of the Software that does not meet the warranty set forth herein and that is returned to MMD with a copy of your receipt. This limited warranty shall be void if failure of the Software has resulted from any accident, abuse, misuse or wrongful application. Any replacement Software will be warranted for the remainder of the original warranty period or thirty (30) days, whichever is longer. This limited warranty shall not apply to you if the Software was provided to you free of charge on an evaluation only basis.

10. NO OTHER WARRANTIES. EXCEPT AS SET FORTH ABOVE, MMD AND ITS LICENSORS DO NOT WARRANT THAT THE SOFTWARE WILL OPERATE ERROR FREE OR UNINTERRUPTED, OR WILL MEET YOUR REQUIREMENTS. YOU ASSUME ALL RESPONSIBILITIES FOR SELECTION OF THE SOFTWARE TO ACHIEVE YOUR INTENDED RESULTS, AND FOR THE INSTALLATION OF, USE OF, AND RESULTS OBTAINED FROM THE SOFTWARE. TO THE MAXIMUM EXTENT PERMITTED BY APPLICABLE LAW, MMD AND ITS LICENSORS DISCLAIM ALL WARRANTIES AND CONDITIONS, WHETHER EXPRESS OR IMPLIED, INCLUDING BUT NOT LIMITED TO THE IMPLIED WARRANTIES OF MERCHANTABILITY, FITNESS FOR A PARTICULAR PURPOSE, AND ACCURACY OR COMPLETENESS OF RESULTS WITH RESPECT TO THE SOFTWARE AND THE ACCOMPANYING MATERIALS. THERE IS NO WARRANTY AGAINST INFRINGEMENT. MMD DOES NOT WARRANT THAT YOU WILL BE ABLE TO DOWNLOAD, COPY, STORE, DISPLAY, TRANSFER, AND/OR PLAY SECURE CONTENT.

11. LIMITATION OF LIABILITY. UNDER NO CIRCUMSTANCES WILL MMD OR ITS LICENSORS BE LIABLE FOR ANY CONSEQUENTIAL, SPECIAL, INDIRECT, INCIDENTAL OR PUNITIVE DAMAGES WHATSOEVER, INCLUDING, WITHOUT LIMITATION, DAMAGES FOR LOSS OF PROFITS OR REVENUES, BUSINESS INTERRUPTION, LOSS OF BUSINESS INFORMATION, LOSS OF DATA, LOSS OF USE OR OTHER PECUNIARY LOSS, EVEN IF MMD OR ITS LICENSORS HAVE BEEN ADVISED OF THE POSSIBILITY OF SUCH DAMAGES. IN NO EVENT SHALL MMD’S OR ITS LICENSORS’ AGGREGATE LIABILITY FOR DAMAGES ARISING OUT OF THIS AGREEMENT EXCEED THE GREATER OF THE PRICE ACTUALLY PAID BY YOU FOR THE SOFTWARE OR FIVE POUNDS STERLING (5.00).

12. Trademarks. Certain of the product and MMD names used in this Agreement, the Software, and the printed user documentation may constitute trademarks of the MMD, its licensors or other third parties. You are not authorized to use any such trademarks.

13. Export Administration. You agree that you will not directly or indirectly, export or re-export the Software to any country for which the United States Export Administration Act, or any similar United States law or regulation requires an export license or other U.S. Government approval, unless the appropriate export license or approval has first been obtained. By downloading or installing the Software you agree to abide by this Export provision.

14. Governing law. This Agreement is governed by the laws of the Netherlands, without reference to its conflict of laws principles. This Agreement shall not be governed by the United Nations Convention on Contracts for the International Sale of Goods, the application of which is expressly excluded. Any dispute between you and MMD regarding this Agreement shall be subject to the non-exclusive jurisdiction of the courts of the Netherlands. If for any reason a court of competent jurisdiction finds any provision, or portion thereof, to be unenforceable, the remainder of this Agreement shall continue in full force and effect.

15. General. This Agreement contains the entire agreement between you and MMD and supersedes any prior representation, undertaking or other communication or advertising with respect to the Software and user documentation. If any part of this Agreement is held invalid, the remainder of this Agreement will continue in full force and effect. This Agreement shall not prejudice the statutory rights of any party dealing as a consumer.

2. Unpacking and Installation

Before installing the display

- This product is packed in a carton, together with the standard accessories.
- Any other optional accessories will be packed separately.
- After opening the carton, ensure that the contents are complete and in good condition.

2.1. Package Contents

Please verify that you received the following items with your package content:

- Colour Display
- Quick start guide
- DC Power adapter
- Power Plug

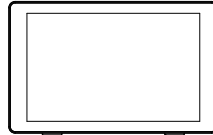

Colour Display

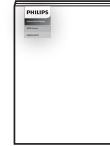

Quick Start Guide

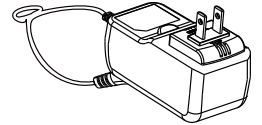

DC Power Adapter

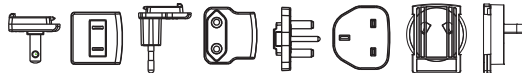

Power Plug
(Provided by regions)

* Items may differ in different locations

* Display design and accessories may differ from the images shown.

2.2. Installation

Securing the power and network cable

2.2.1. Connecting the power cable

1. Connect the power adapter's connector into the display's power input socket.
2. Insert the matching AC plug fully into the power adapter.
3. Plug the AC plug of your power adapter into an electric outlet to power on the device.

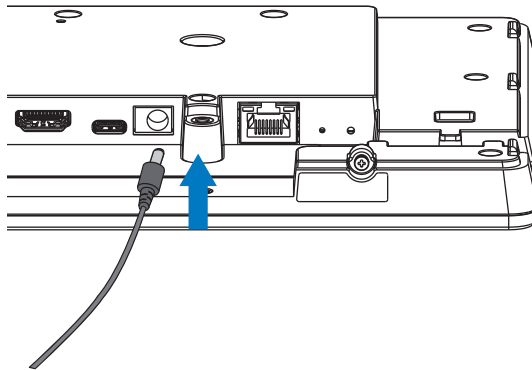

2.2.2. Connecting the network cable

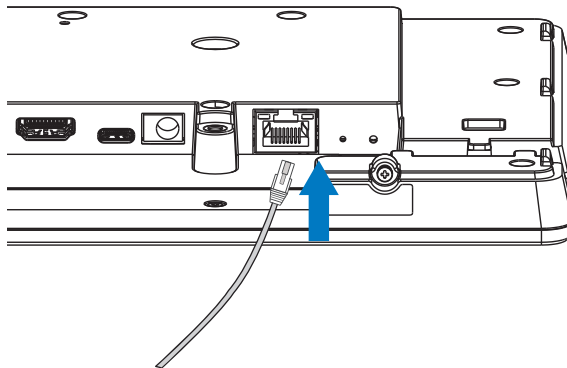

2.2.3. Inserting the Micro SD card

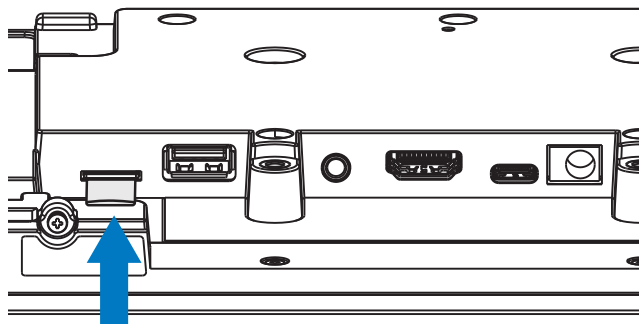

2.2.4. Mounting and installation

Mounting Option 1: [VESA mount]

Supporting VESA standard: VESA MIS-D75 (75*75mm)

Supporting screw: M4*9mm (exclude the mounting plate thickness)

The equipment and its associated mounting facilities still remain secure during the test. Use only the UL listed VESA mount with a minimum weight/load of the weight of the unit without base.

* Installation height: <2 m

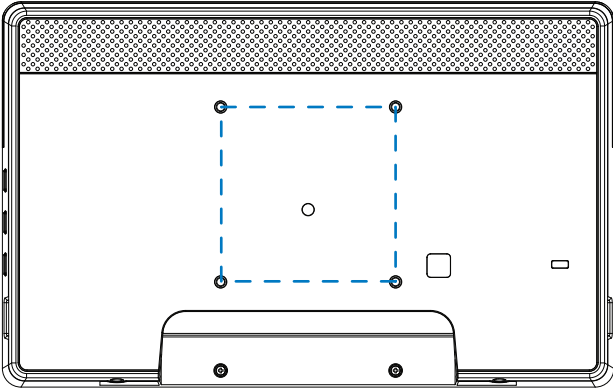

Mounting Option 2: [Using back cover]

Supporting screw: Self-tapping screw*5pcs (exclude the mounting plate thickness)

(1). Use a screwdriver to loosen the screw on the back cover.

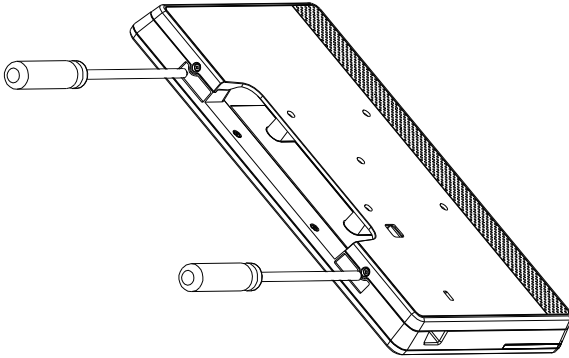

(2). Remove the back shell decoration from the groove indicated by the arrows on both sides of the entire machine.

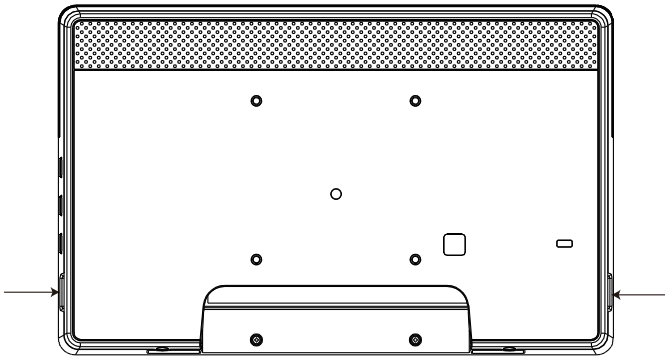

(3). Detach the back cover from the signboard.

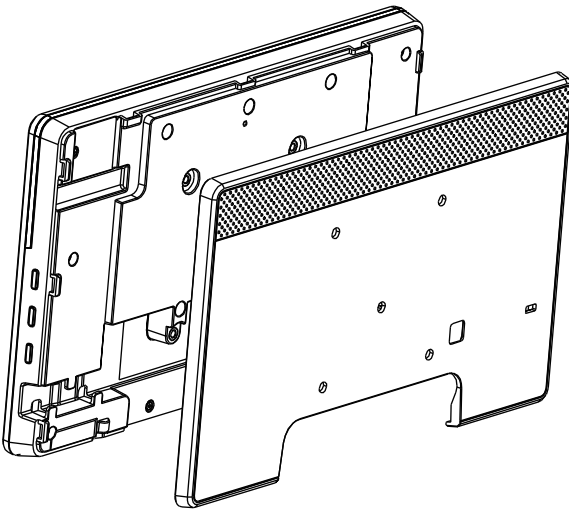

(4). Use screws to secure the back shell trim to the wall.

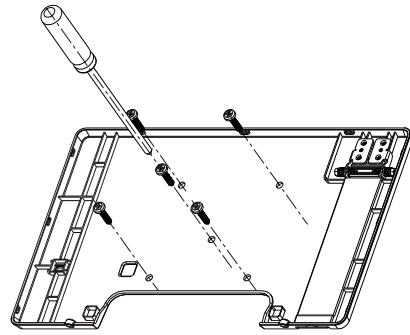

(5). Plug in the cable.

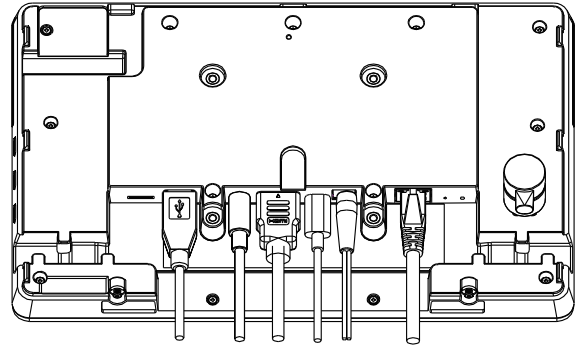

(6). The entire machine is loaded with back shell decorations.

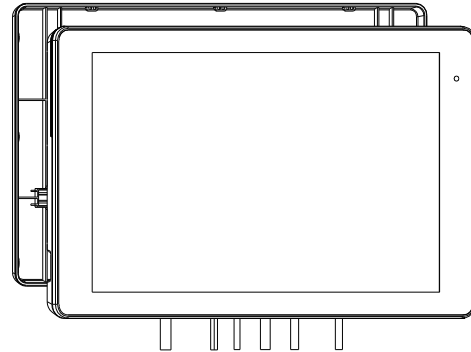

(7). Lock the screws.

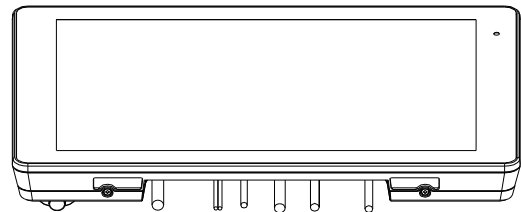

3. Physical view and features

3.1. Left View

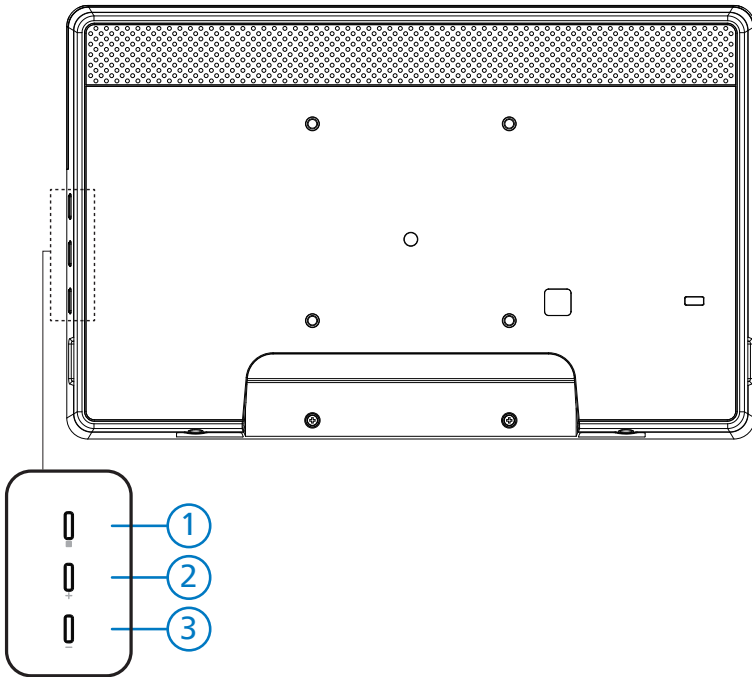

① Menu: To activate the OSD menu.

②/③ Volume +/-: Volume up and down.

Operation	Function
Menu + Volume-	Launch Admin mode app
Menu + Volume+	Launch Quick Information app
Menu + Menu + Volume+ + Volume- + Volume- + Volume+	Enable touch function
Menu + Menu + Volume- + Volume-	Turn on the screen

3.2. Input/Output Terminals

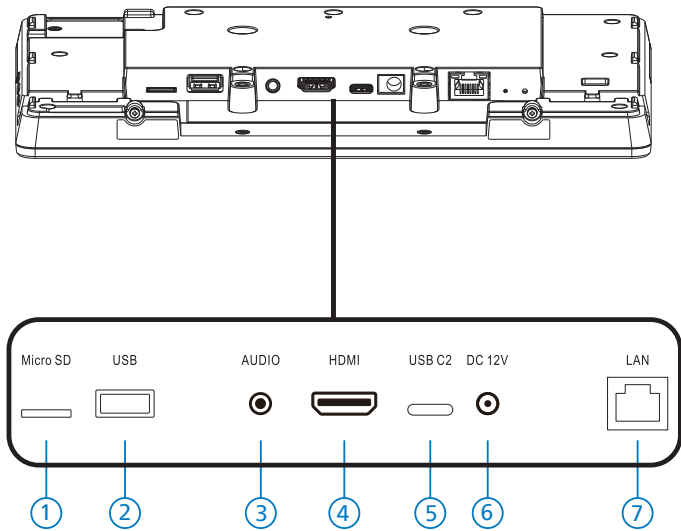

① Micro SD

Insert a Micro SD card.

② Micro USB

Insert a USB storage device.

③ Earphone

Connect to an earphone through this 3.5 mm Ear Jack (CTIA standard).

④ HDMI OUT

HDMI video/audio output.

⑤ USB C2

For adb debugging.

⑥ DC IN

Connect to the DC power adapter.

⑦ LAN

* LAN control function for the use of remote control signal from control center.

* PoE+ (power over Ethernet): 24W

Status	Green	Yellow
NC	OFF	OFF
10Mbps	ON (Flicker)	OFF
100Mbps	ON (Flicker)	ON

4. Operation

4.1. Setup wizard

4.1.1. Welcome

Please select the desired language from the “Language List” and start the setup by pressing the Start button.



Note: After entering OOB, the Signage Display Name will be set to the default value: “PD” + Ethernet Mac Address.

(1). Support Language

System support 22 languages and must set by user during first time boot.

English is default-selected language.

No	Support Language	Display String
1	ENGLISH	English
2	SPANISH	Español
3	FRENCH	Français
4	ITALIAN	Italiano
5	LATVIAN	Latviešu
6	LITHUANIAN	Lietuvių
7	DUTCH	Nederlands
8	NORWEGIAN	Norsk bokmål
9	POLSKI	Polski
10	PORTUGUESE	Português
11	FINNISH	Suomi
12	SWEDISH	Svenska
13	TURKISH	Türkçe
14	RUSSIAN	Русский
15	ARABIC	ةببرعلا
16	SIMPLIFIED CHINESE	简体中文
17	TRADITIONAL CHINESE	繁體中文
18	JAPANESE	日本語
19	CZECH	Čeština
20	DANISH	Dansk
21	GERMAN	Deutsch
22	ESTONIAN	Eesti

4.1.2. Date & Time

To enable or disable automatic time synchronization and select a time zone.

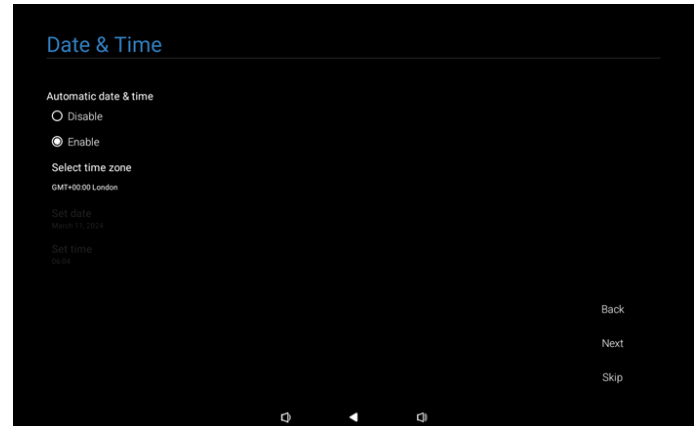

4.1.3. Clone Media Files into internal

Please copy multimedia files from the “philips” folder in the SD card or USB to the “philips” folder in the internal storage.

(1) philips/photo

(2) philips/music

(3) philips/video

(4) philips/pdf

(5) philips/browser

Note: The action of cloning media files will occur on the Setup Complete page and will commence after pressing the Finish button.

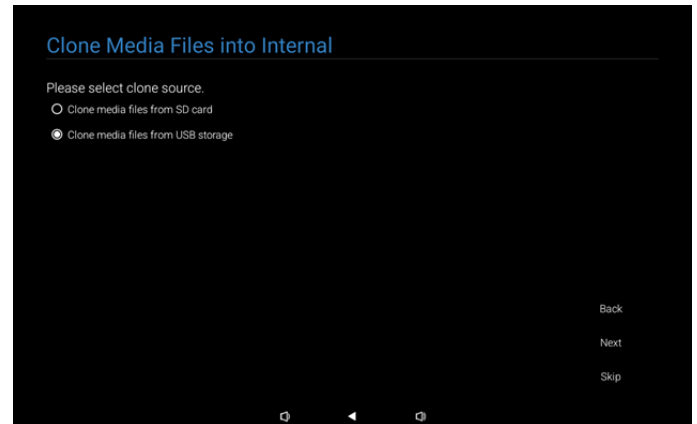

4.1.4. Signage Display Settings

Users can choose to import data or manually configure settings.

If you prefer not to set up this item, you can skip it using the Skip button.

Note: The import action will occur on the Setup Complete page and will commence after pressing the Finish button.

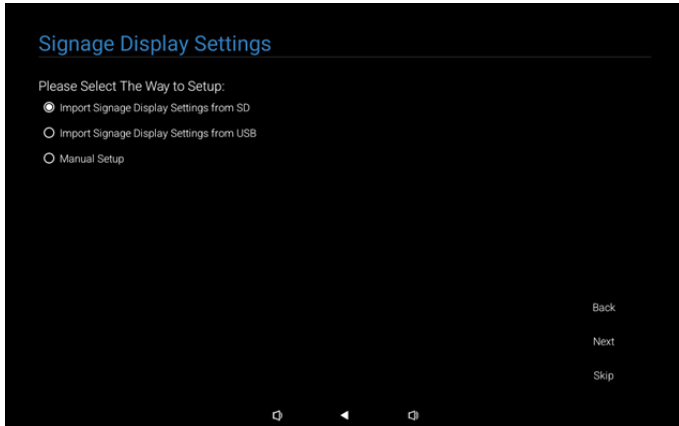

(1). Import Signage Settings from SD / USB

Import data from "philips/clone/10BDL3351T-clone.7z" located in SD card or USB. The import action will be executed when leaving OOB.

After selecting the "Next" button, you will enter the "Setup Complete" page.

(2). Manual Setup

In the manual setup section, the currently required settings are:

- (1) Signage Display Name
- (2) Remote Control

Note: After pressing the "Finish" button on the "Setup Complete" page, the settings will be saved.

Once setup is complete, no reboot is required.

(1). Signage Display Name

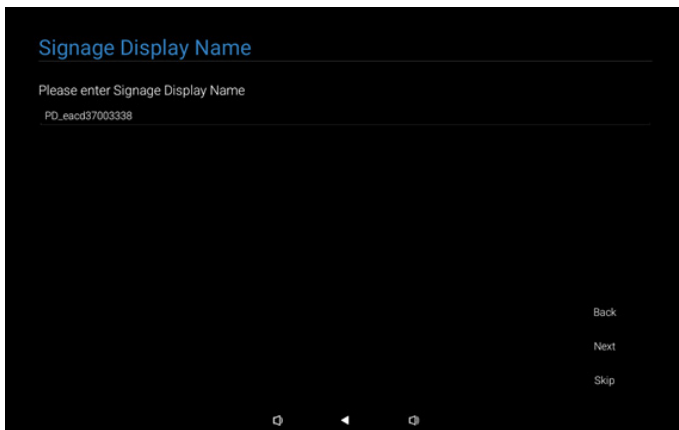

(2). Remote Control

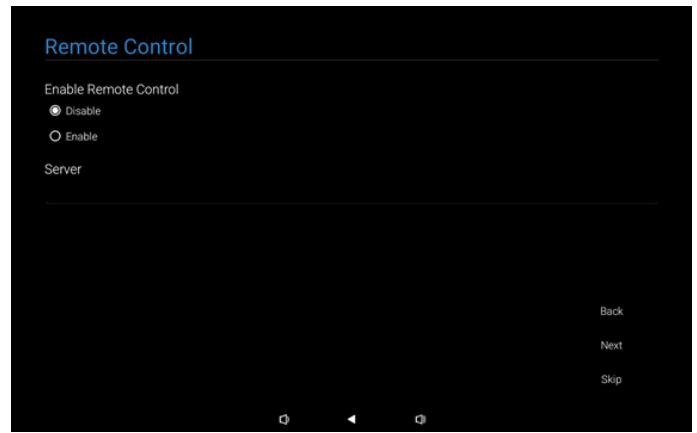

4.1.5. Security Setting

By default, the SICP Network Port, FTP, Admin Password, and External Storage options are enabled. Users can choose to check or uncheck these options as desired. If you prefer not to set up this item, you can skip it using the Skip button.

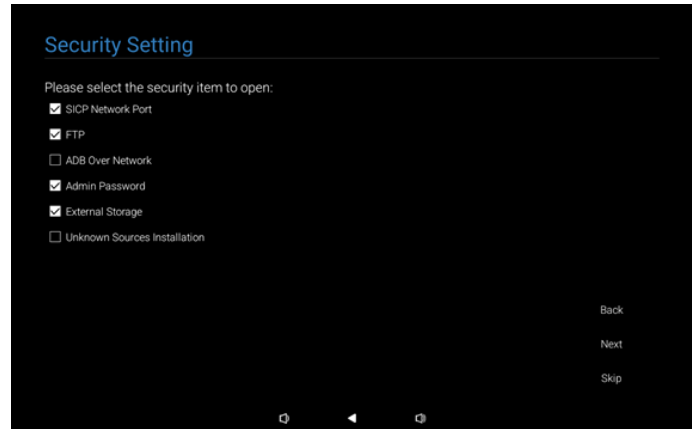

4.1.6. Network Setting

Users can choose their network connection source: Wi-Fi or Ethernet. After selecting, click the Next button to proceed to network setup. Clicking the Skip button allows users to bypass network setup.

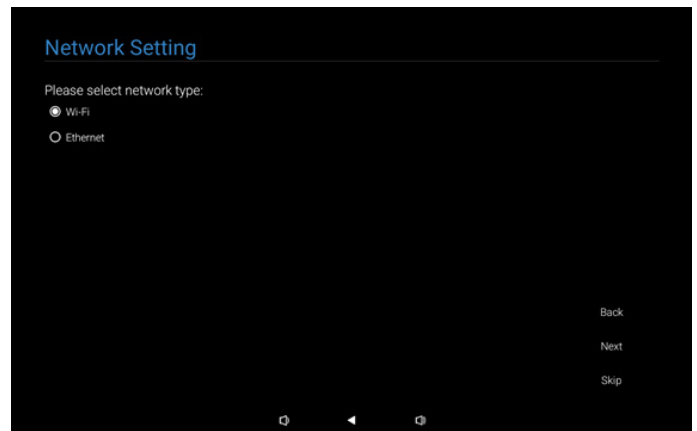

(1).Wireless (Wi-Fi)

After connecting to the Wi-Fi network, you will be automatically directed to the next page

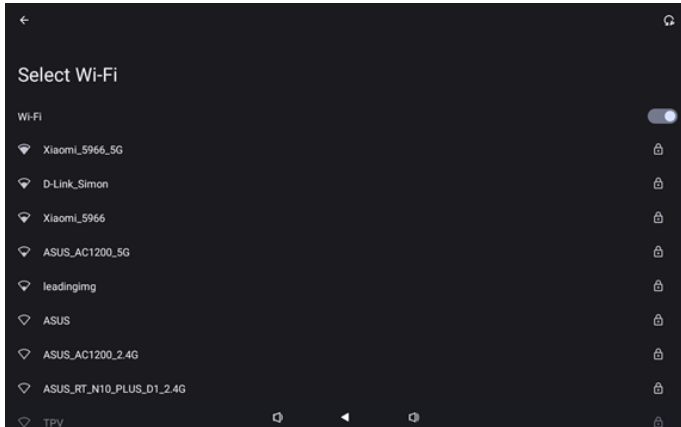

(2).Ethernet

After completing the Ethernet connection, you will be automatically directed to the next page.

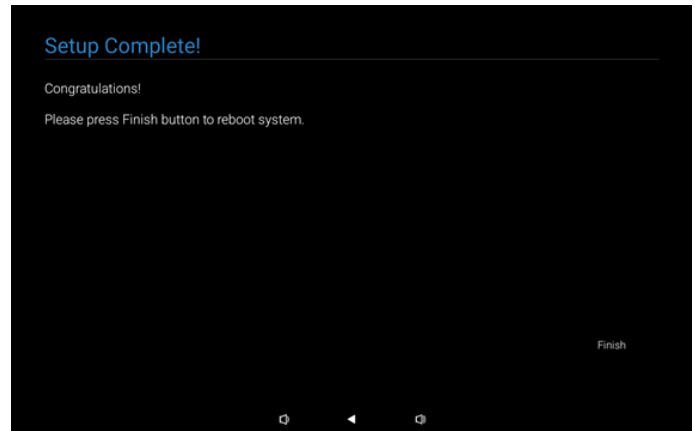
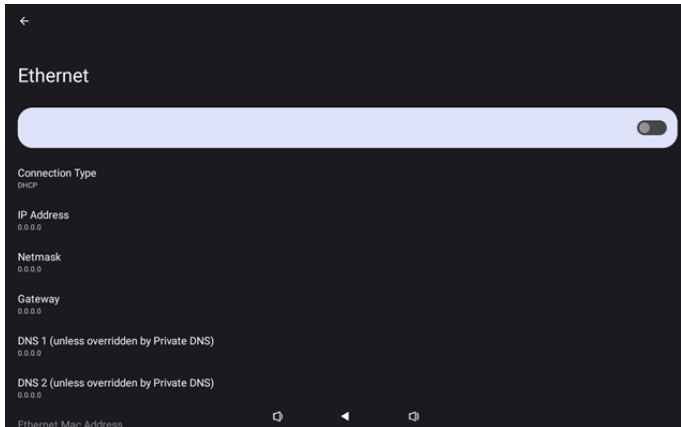

(2).Manual Setup Complete

After pressing Finish, the system will exit OOB after completion of the setup. Any future adjustments to these settings can be made through Admin Mode.

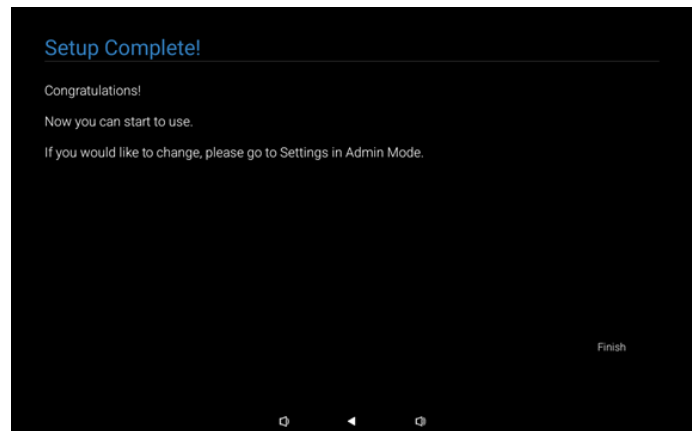

4.1.7. Setup Complete

After pressing the Finish button, it will take some time to complete the initial setup and exit OOB.

Page Display:

(1) When selecting "Import Clone Data from SD/USB" in Signage Display Settings, the Setup Complete page will display "Import Clone Data Complete" page.

(2) When selecting "Manual Setup" in Signage Display Settings, the Setup Complete page will display "Manual Setup Complete" page.

Note: During the Import or Clone Media File process, do not power off!

(1).Import Signage Display Settings Complete

After pressing Finish, if "Import Signage Settings from SD / USB" is configured, the system will automatically reboot after completion.

4.2. Android Launcher

4.2.1. Android PD launcher

- The platform launcher is a black page as shown below:



- Every apps leave by press back key, the screen will go to android PD launcher.

4.2.2. Admin mode:

- You can press Hotkey "Menu + Volume ↓" to startup admin mode. Screen show up a dialog request enter Admin password, default password is "1234". User can change password in "Settings -> Signage Display -> System tools -> Admin Password".
- Admin mode will show six icons: "Settings", "Apps", "Network", "Storage", "Help" and "Power".

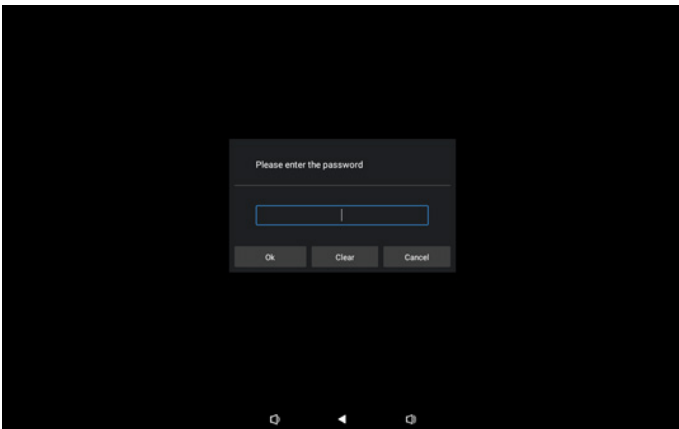

Home page of admin mode, this page has six items: "Settings", "Apps", "Network", "Storage", "Help" and "Power".

1. Settings : Go to settings app.
2. Apps : Show all apps.
3. Network : Set Wi-Fi and Ethernet
4. Storage : Go to File Manager app.
5. Help : Display QRcode.
6. Power : Display "Power off", "Sleep" and "Reboot".

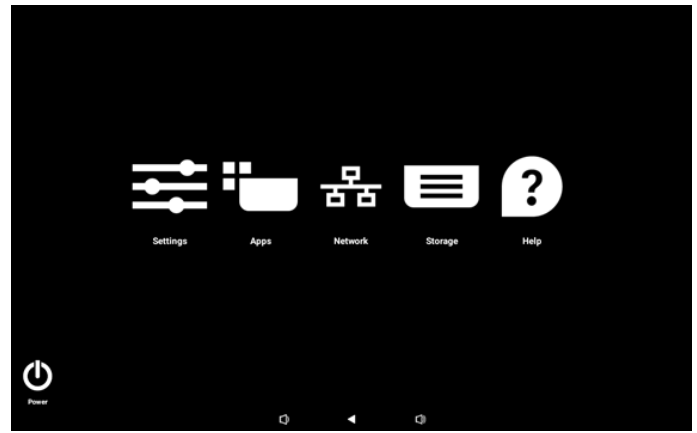

(1). Settings page:

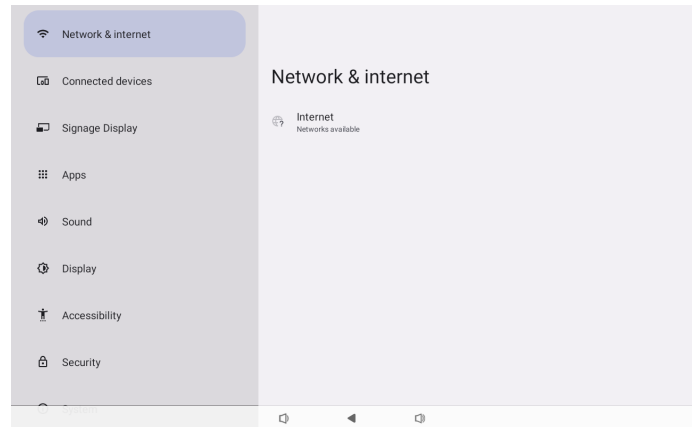

(2). Application page:

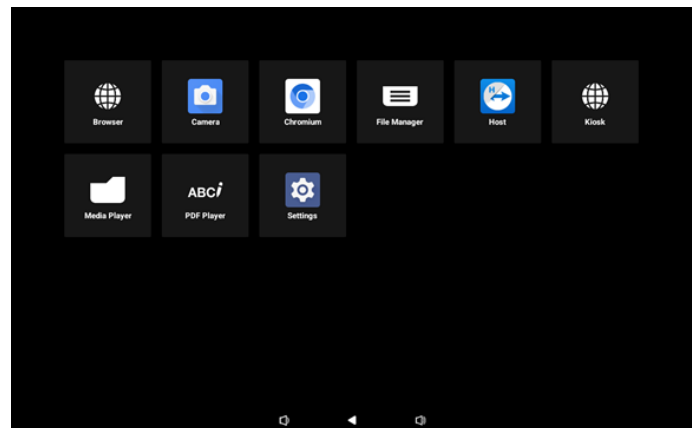

(3). Network page:

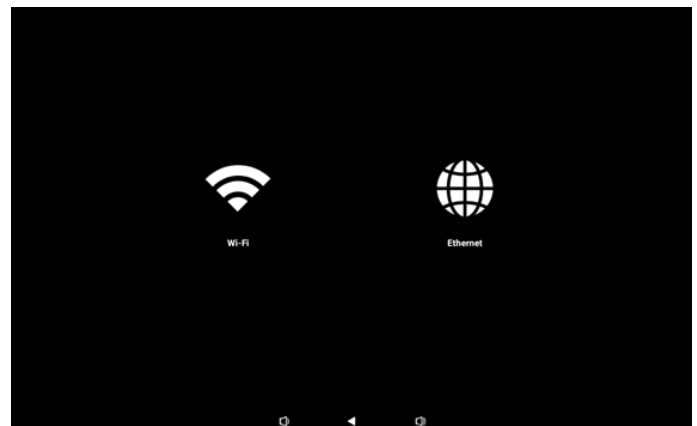

Wi-Fi page:



Ethernet page:



(4). Storage:



(5). Help page:

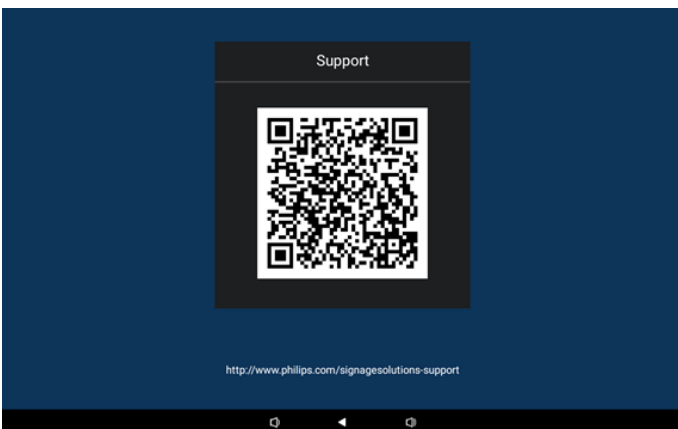

(6). Power page:

User can press the "Power off" button to shutdown device or press the "Reboot" button to reboot device, or press the "Sleep" to sleep device.

User can press "Menu + Menu + Volume↓+ Volume↓" to wakeup device.

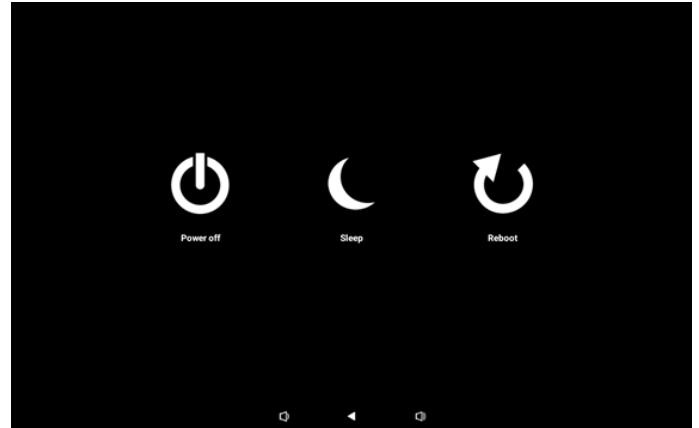

For the always-on model, like 10BDL3351T, the "Power off" button is not really led to power off device. If user press the "Power off", it will go through the all shutdown process until the screen is showing "Unplug power cord" (follows picture) hint picture. User can remove the power cord after showing "Unplug power cord" picture. It will help user to shutdown device more safely.

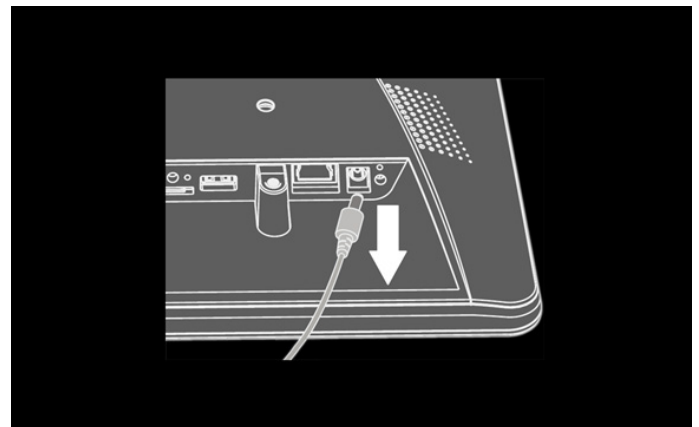

4.3. Setting menu

Enter PD settings by click "Settings" icon in Admin mode.

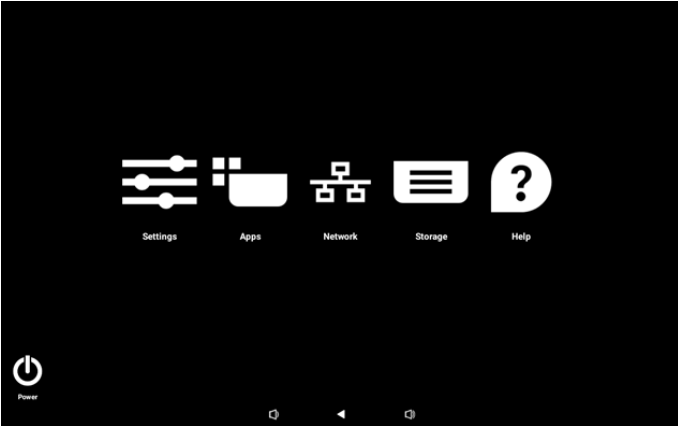

The major items in Settings:

- (1). Network & internet
- (2). Connected devices
- (3). Signage Display
- (4). Apps
- (5). Sound
- (6). Display
- (7). Accessibility
- (8). Security
- (9). System
- (10). About

4.3.1. Network & Internet

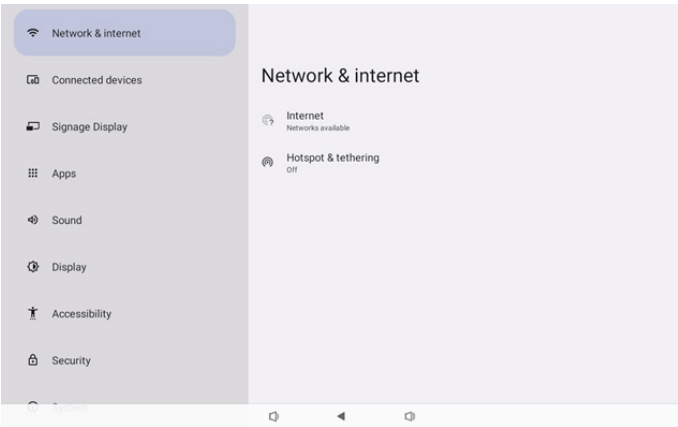

4.3.1.1. Internet

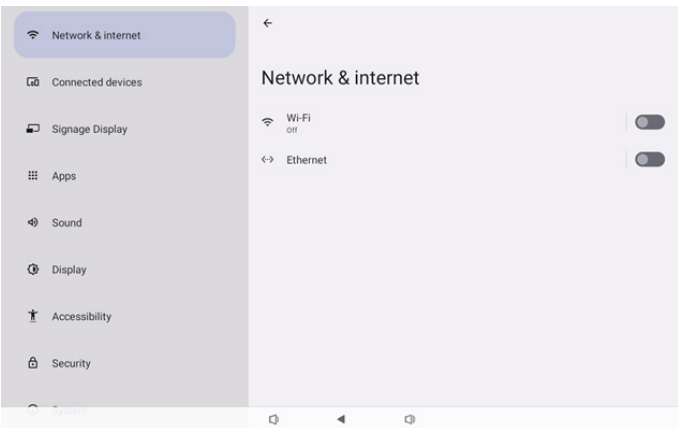

4.3.1.1.1. Wi-Fi

Important Note: This option only shown when supported Wi-Fi dongle is plug-in to device. System not support Wi-Fi dongle hot spot, please reboot device when user plug-in or plug-out USB Wi-Fi dongle.

Enable Wi-Fi

Enable/disable Wi-Fi connection through main switch in Setting -> Network & Internet -> Wi-Fi -> Off/On toggle button.

(1). Wi-Fi Off

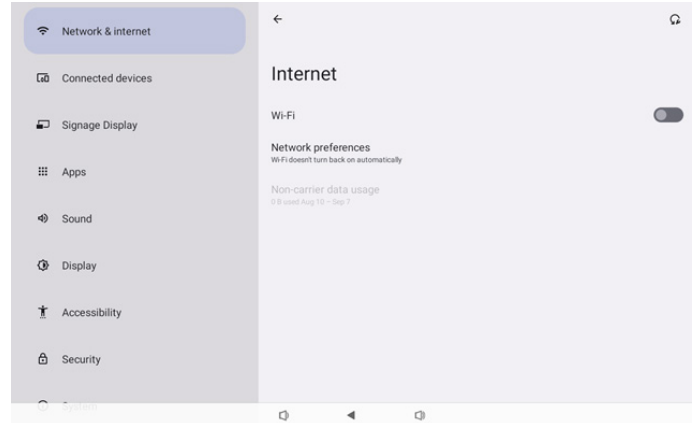

(2). Wi-Fi On

The list of availed Wi-Fi AP (Access Point) in below after Wi-Fi scan environment.

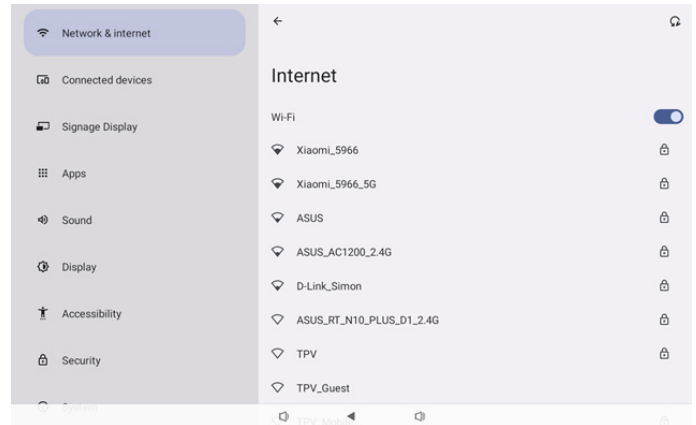

Click the AP name to connect it, a system dialog will pop up if password is need for this network.

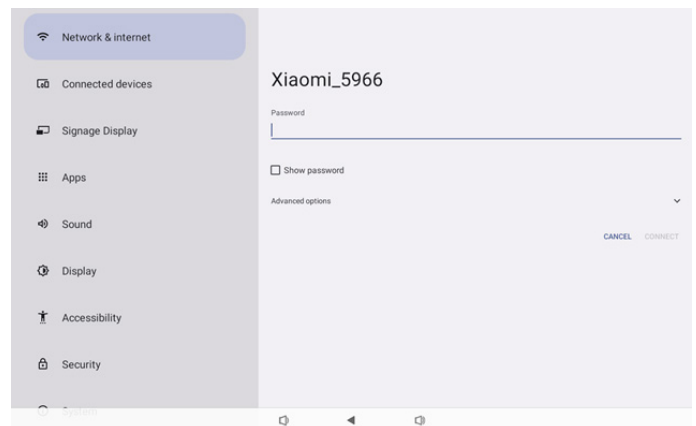

There is an "Add network" item at the end of list. If network does not listed, using add network to join hidden network.

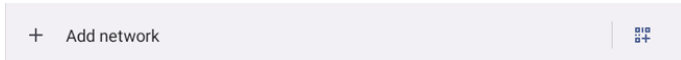

You must input network SSID, security type and other advanced options for this network.

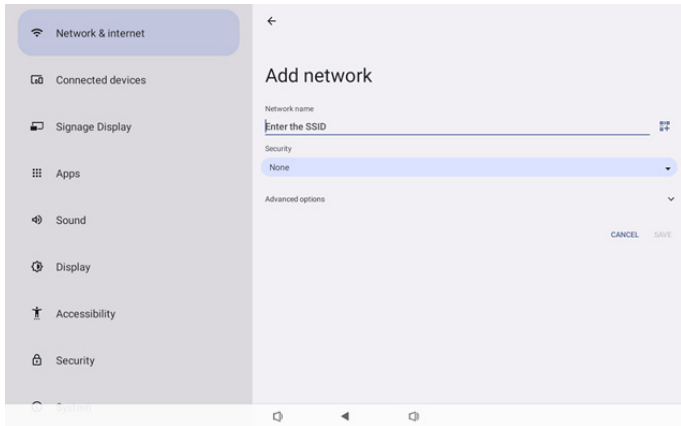

Note:

When Wi-Fi is enable, Ethernet will disable automatically.

Network preferences

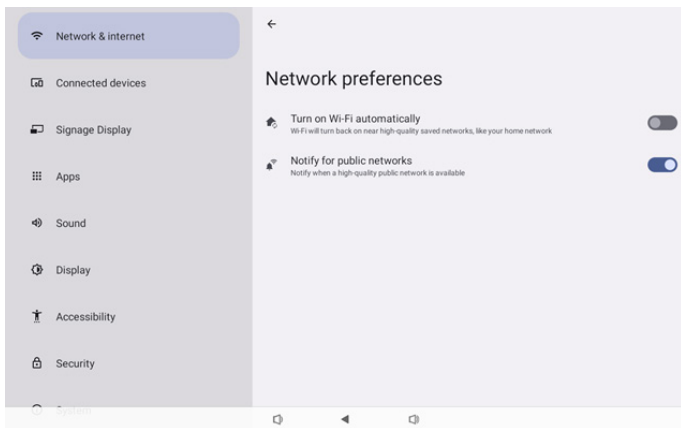

4.3.1.1.2. Ethernet

Enable Ethernet

Enable/disable Ethernet connection by Setting -> Network & Internet -> Ethernet toggle button.

By default, system will using DHCP for join network. After system join network, the connection information will show be below.

Connection Information (UI cannot be modified by user)

- A. IP Address
- B. Netmask
- C. Gateway
- D. DNS 1 (unless overridden by Private DNS)
- E. DNS 2 (unless overridden by Private DNS)
- F. Ethernet Mac Address

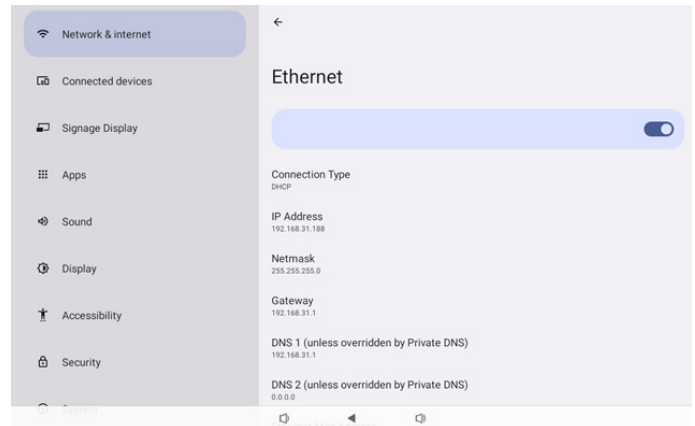

Note:

Wi-Fi connection will disable automatically when Ethernet connection enable.

(1). Ethernet Static IP

When the Connection Type is changed to "Static IP", the user can manually set the Ethernet IP Address, Gateway, Netmask and DNS 1/2 address.

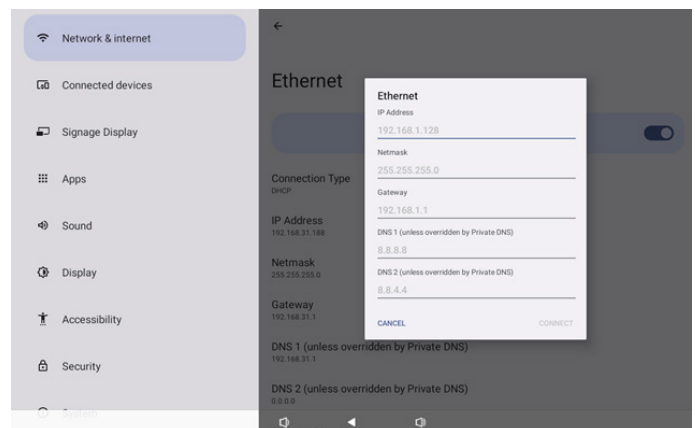

Note:

Please input IPv4 address in all field; in dot-decimal notation, consisting of four decimal numbers, each ranging from 0 to 255, separated by dot.

4.3.2. Connected devices

Show the Bluetooth connected devices.

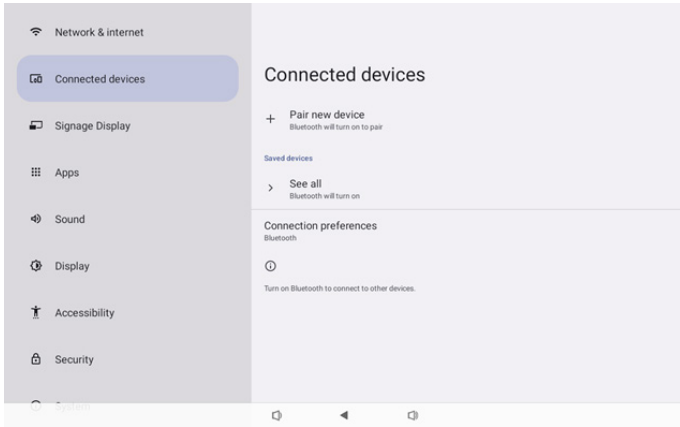

4.3.3. Signage Display

Settings -> Signage Display, to setup most features of signage display. Description in below sessions.

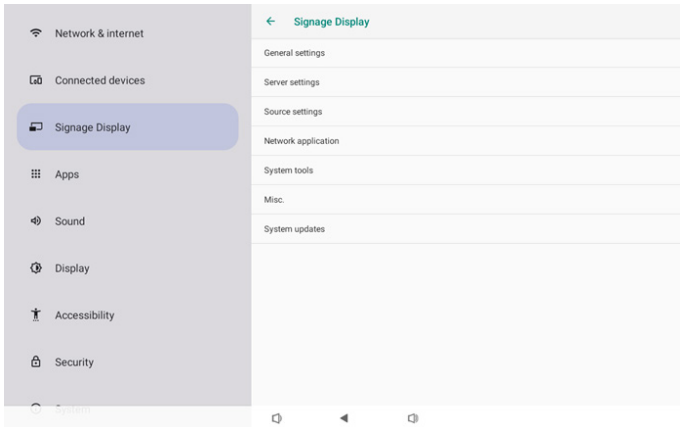

4.3.3.1.2. Monitor ID

Monitor ID in range 1 to 255 decimal and Monitor Group in range 1 to 254 decimal. Default monitor ID and monitor group are both 1.

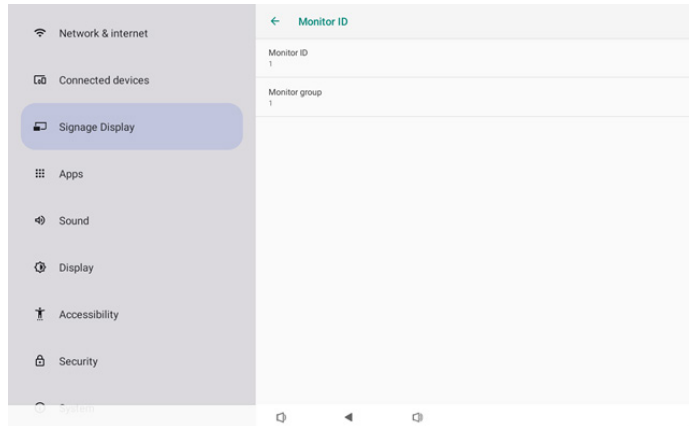

4.3.3.1. General Settings

Set up Signage Display name, User logo and Screenshot.

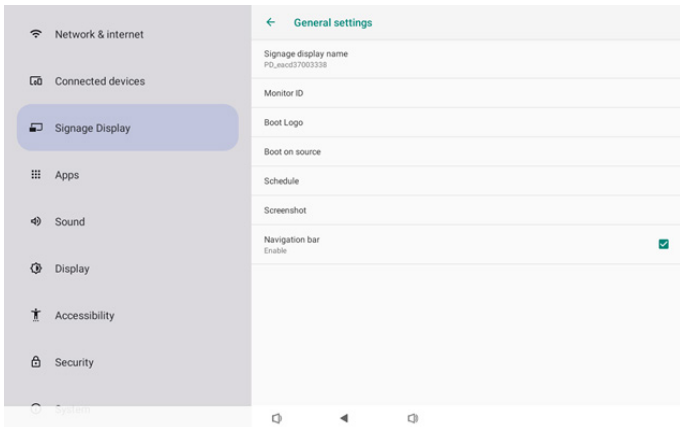

4.3.3.1.3. Boot Logo

User can set up device boot up logo (boot animation) when Settings -> Signage Display -> General Settings -> Boot Logo is set to "User" mode.

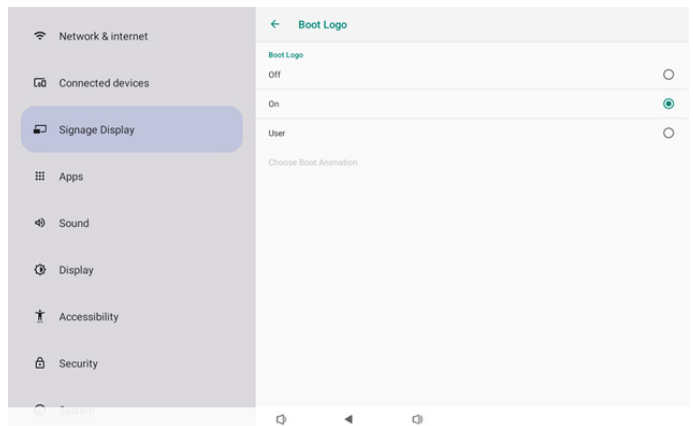

If Logo not set to "User" mode, user cannot select custom boot animation.

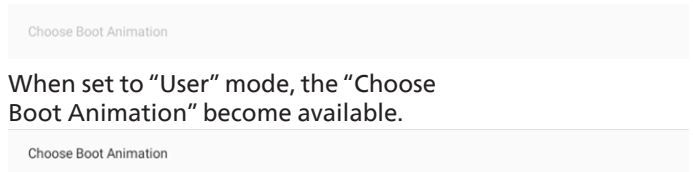

4.3.3.1.1. Signage display Name

Set up PD name, default name Ethernet MAC address with prefix "PD_". For example, "PD_000b12223398". The max length of name is 36 chars in UTF8 format. Click to rename it.

When set to "User" mode, the "Choose Boot Animation" become available.

When Logo set to User mode, system disable default Philips logo and replace with user selected boot animation file. If user does not set boot animation file for User mode, black animation will show during boot time.

Click "Choose Boot Animation" will pop up a dialog for user select boot animation file. System will auto scan the files under SD Card or USB storage.

Boot animation file name must and only set to "bootanimation.zip", others are invalid.

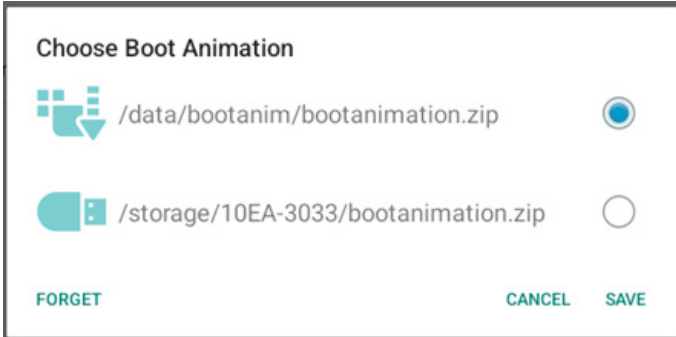

System list available boot animation file from following folder:

1. File under /data/bootanim/:

The boot animation file that copy from SD Card or USB.

2. File under {USB_STORAGE_VOLUME_NAME}/:

The boot animation file under SD Card or USB storage.

Dialog options:

1. FORGET

Clear the bootanimation.zip under /data/bootanim/.

Moreover, not using custom boot animation during system boot up.

2. CANCEL

Do nothing, close dialog.

3. SAVE

Copy selected file to /data/bootanim/. After doing this, user can remove their external storage (US). System uses the boot animation file under /data/bootanim/.

If system does not found any bootanimation.zip file under external storage (SD/USB) and /data, the file list is empty. The "SAVE" and "FORGET" buttons are gray and user should check external storage (SD/USB) has correct file in it. Click "CANCEL" to close the dialog, and then plug-in external storage to try again.

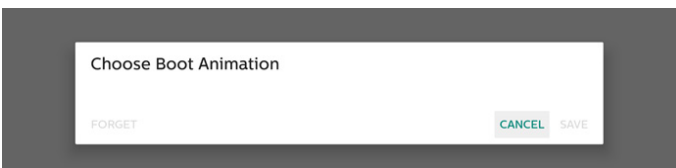

If /data/bootanim/ folder is empty, it means that user did not save bootanimation.zip file before. Default Philips logo shows during system boot up.

When system finds bootanimation.zip file under external storage, list file in dialog.

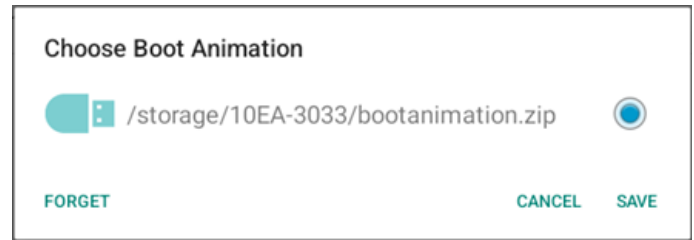

If /data/bootanim/ folder is not empty, and system find a bootanimation.zip in it. The dialog will show the file in first option and select it. That means user copy (SAVE) the bootanimation.zip file before. System will boot up with boot animation in /data/bootanim/bootanimation.zip.

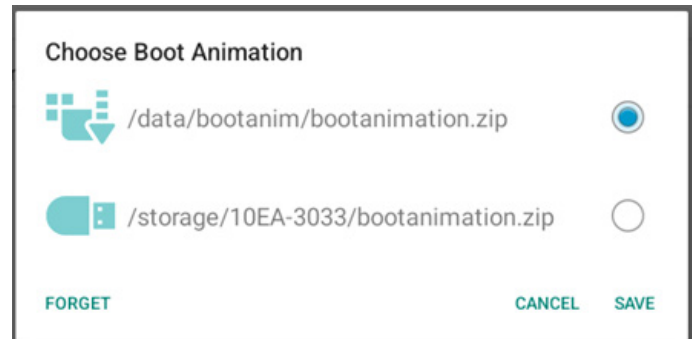

User can replace the boot animation file by using "SAVE" button.

4.3.3.1.4. Boot on source

Boot on source for user set up the default source when device power on.

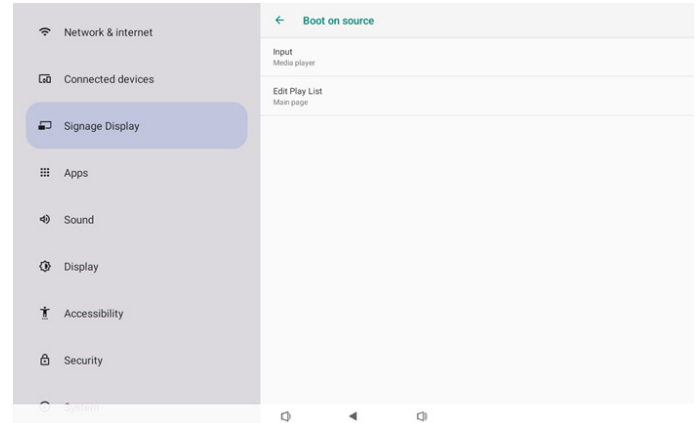

Input: System will boot to selected source automatically after boot complete.

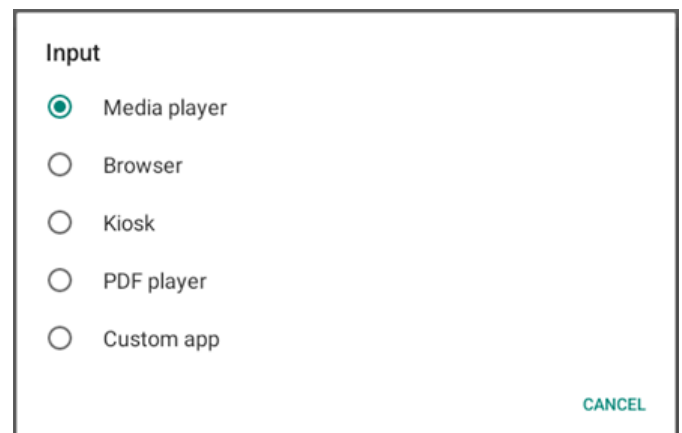

Playlist: If input source is Media Play, Browser or PDF Player, user can select the play list for auto playback or boot to source main page.

Only MediaPlayer has Playlist 8 (Autoplay).

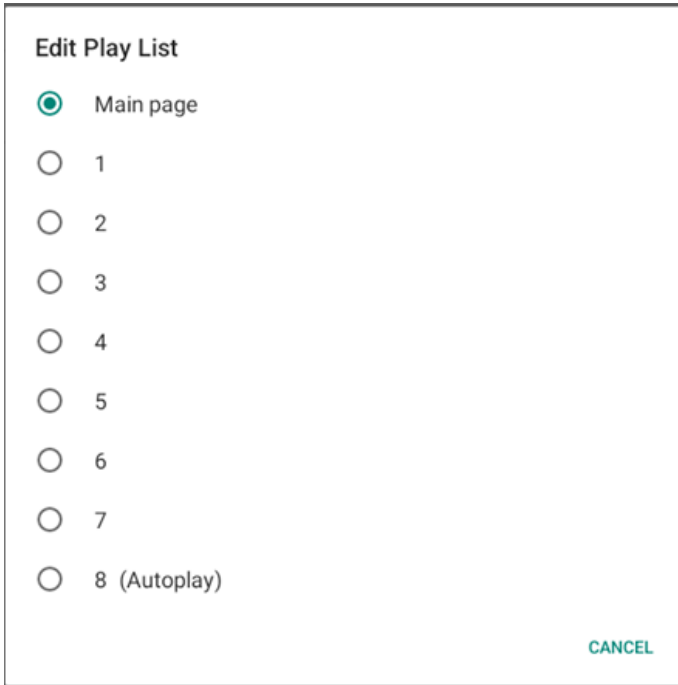

Please note that if user chose "Custom app" as boot on source, the user specified application (APK) must be selected in Settings -> Signage Display -> Source Settings -> Custom APP.

4.3.3.1.5. Schedule

Set up auto playback schedule.

Note:

1. Schedule priority is higher than Display -> Sleep and Display -> Screen save. When schedule is started, system will keep auto playback until schedule end, not effect by sleep time.
2. When schedule off (end time), device can only be wakeup by next schedule start time, hot key or network SICP command to wake up system. After waking up system, the system is black screen since playback applications are finished. User can call back navigation bar by finger scroll up (if touch not disabled) or enter Admin mode, quick info by hot key.
3. The hot key is available when system sleep. User can enter Admin mode or showing quick info dialog by using hot key.

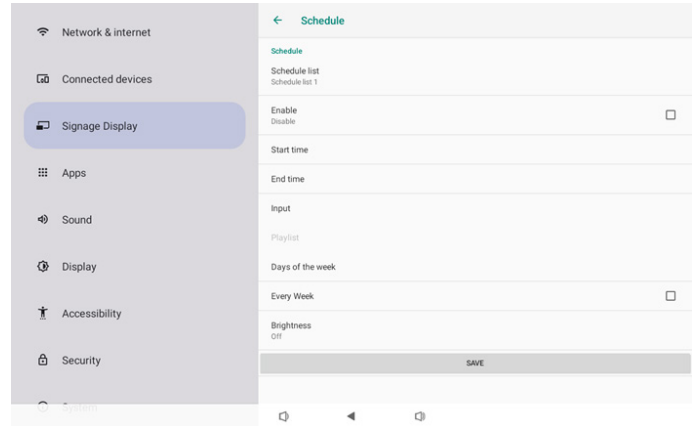

(1).Schedule list: You can set up total 7 schedules. Each schedule setting are independent.

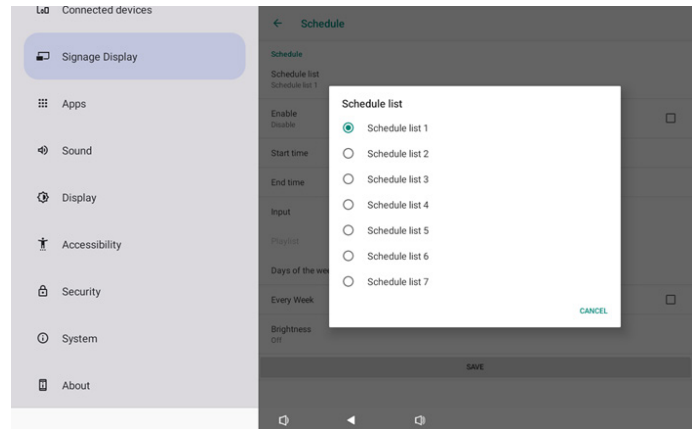

(2).Enable: Enable/disable selected schedule in schedule list. Each schedule has its own enable/disable switch.

(3).Start time: Set up selected schedule start time.

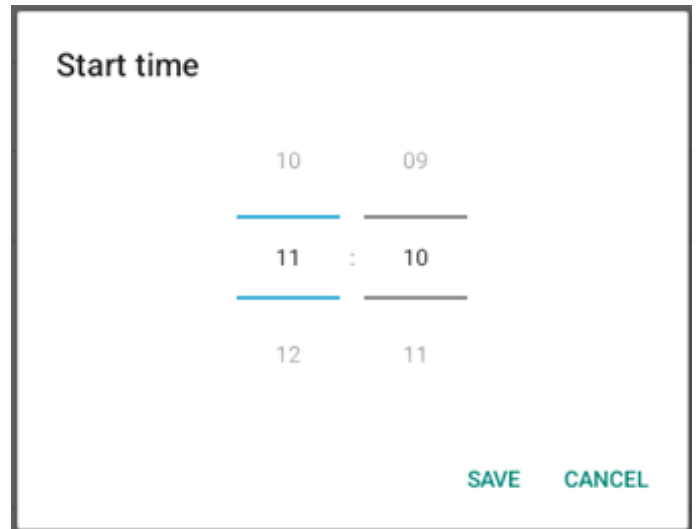

(4).End time: Set up selected schedule end time.

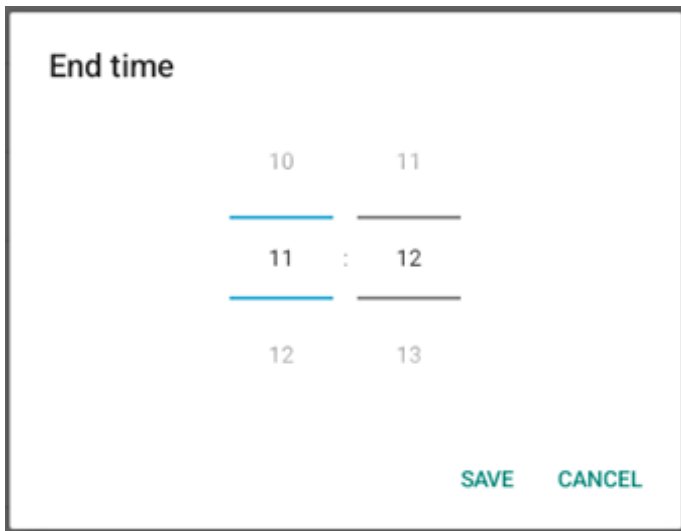

(5).Input: set up selected schedule auto playback source during schedule start.

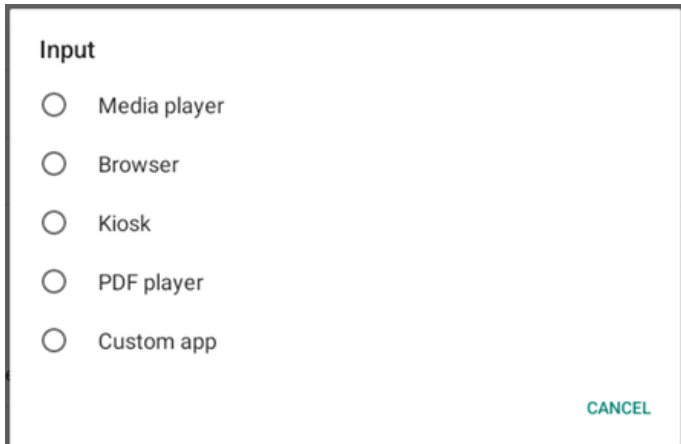

(6).Play list: Select list 1 to 7, only MediaPlayer has Playlist 8 (Autoplay) . If "input" is one of Media Player, Browser, PDF player, user can select playlist and schedule will playback selected playlist automatically.

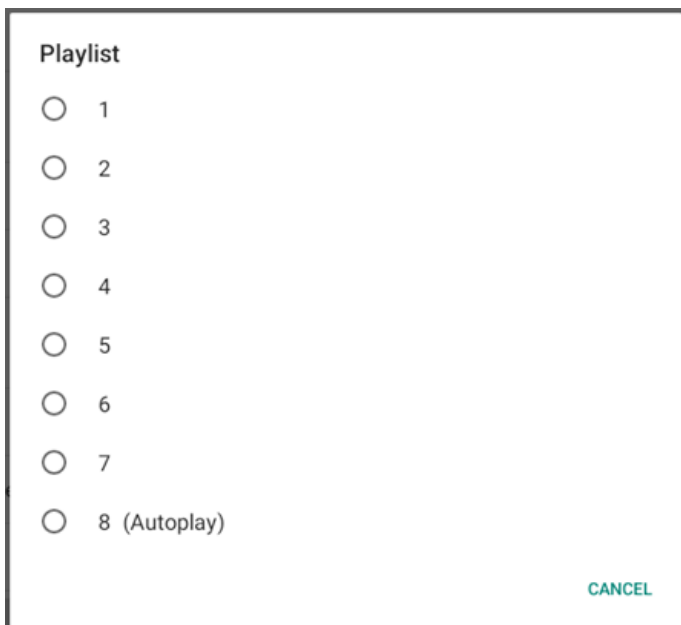

(7).Days of the week: set Sunday, Monday, Tuesday, Wednesday, Thursday, Friday, and Saturday for selected schedule will be run.

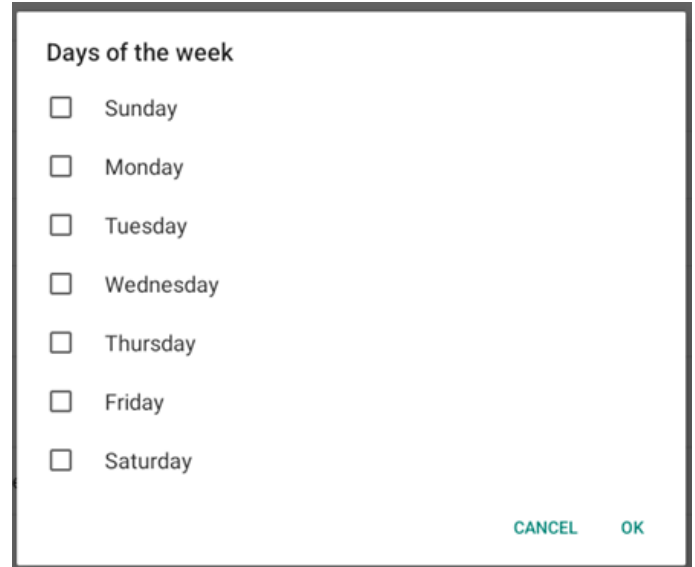

(8).Every week: Set selected schedule's lifecycle.

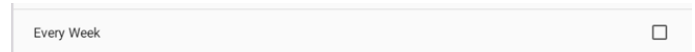

(9).Brightness: Set brightness of schedule source, Range: Off, 0 ~ 100.

(10).SAVE: Store settings of selected schedule. Remember click "SAVE" button, otherwise.

4.3.3.1.6. Screenshot

Setup system doing auto screenshot. Click "Enable" to enable screenshot features. The screenshot options is gray if user not enable screenshot.

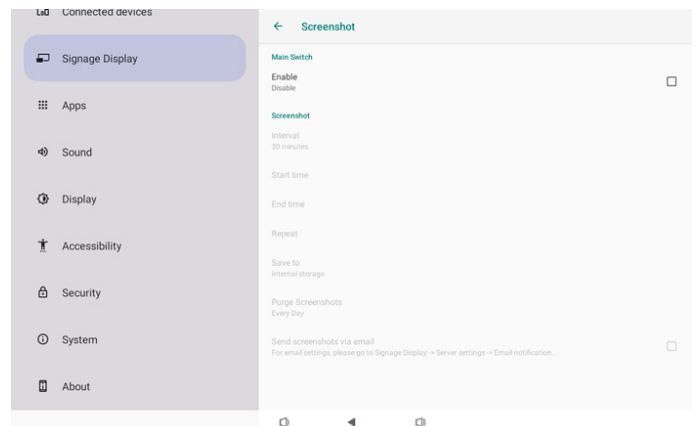

User can set up screenshot interval and saving location folder after user enable it. "Save to" notify user that screenshot images will save in internal storage and user cannot change manually.

NOTE:

A. Screenshot feature will auto delete screenshot photos when:

1. At start time (0 seconds) begin screenshot feature
2. At 40 seconds of minute starting screenshot
3. If user select purge screenshot photos every week, the data of deleting photos will be change to the day of the date user apply any setting of screenshot feature. For example, if user set purge day is Monday of every week at first, but change other settings in screenshot feature in Friday, the purge day will be changed to Friday (day of week of system current time).

B. Sleep (system suspend) and screenshot feature:

Screenshot feature will also suspend when system is sleep (suspend). The mail out screenshot photo feature is also suspended. Screenshot feature will be restart when system wakeup.

(1).Interval

Set up screenshot interval, user can select 30 or 60 minutes interval between each screenshot.



(2).Start Time

Set up screenshot start time of a day.

- a. User must click "SAVE" before leaving dialog, otherwise the time will not be saved.
- b. The start time must lower than end time. A toast message will notify user when interval is wrong.



(3).End Time

Set up screenshot end time of a day.

- a. User must click "SAVE" before leaving dialog, otherwise the time will not be saved.
- b. The start time must lower than end time. A toast message will notify user when interval is wrong.



(4).Repeat

Set up auto screenshot day of week interval, user can select when screenshot will work.

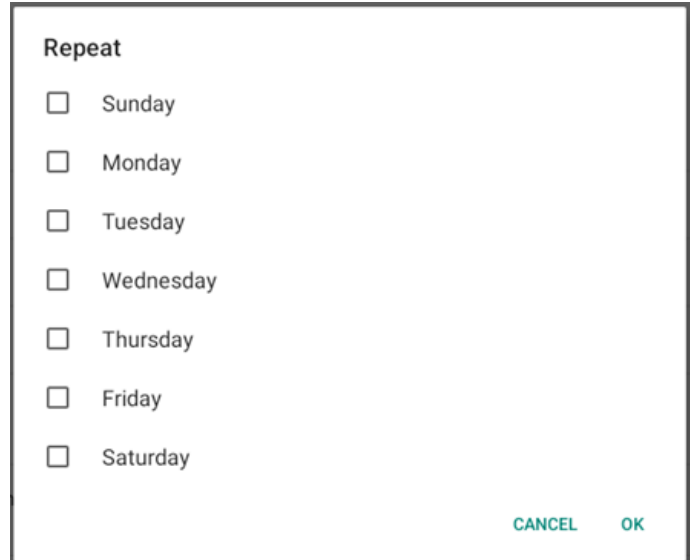

(5).Save to

System saves screenshot images into internal storage. System will create philips/screenshot/ folder in internal storage and saving images under this folder.

(6).Purge Screenshots

Set up the interval of purging (deleting) screenshot images. User can set delete image in every day or every week.

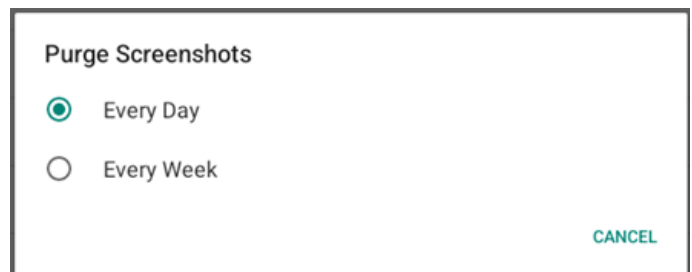

(7).Send screenshots via email

Enable device send out screenshot image by E-mail for every screenshot. User must set up mail information first in "Settings -> Signage Display -> Server Settings -> Email notification" (reference Email Notification section).

Send screenshots via email

For email settings, please go to Signage Display -> Server settings -> Email notification.

4.3.3.1.7. Navigation bar

Set up to enable or disable navigation bar during touch gesture. This option only available when platform has supported touch device.

Navigation bar
Enable

4.3.3.2. Server settings

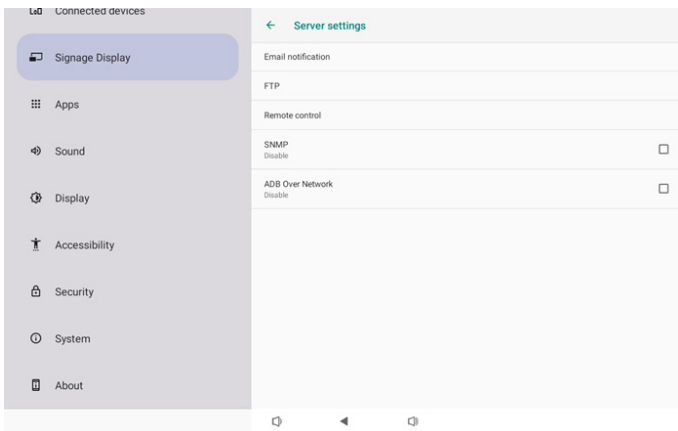

4.3.3.2.1. Email Notification

Click checkbox to enable/disable E-mail notification feature. User can set up SMTP and manager E-mail after enable E-mail notification feature.

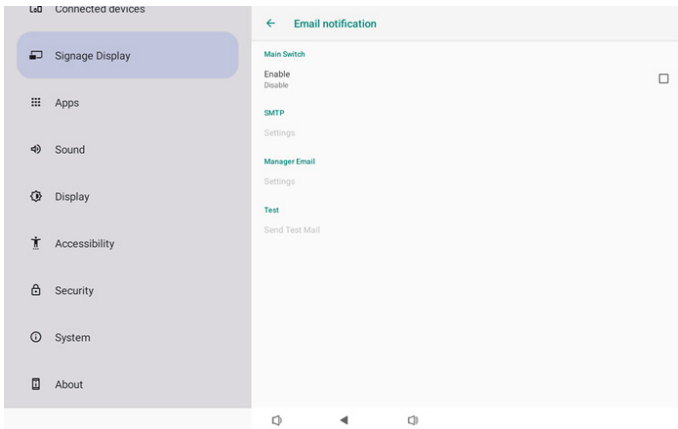

(1).SMTP

Setup sender E-mail address and SMTP server information. There are two types of SMTP server for user set up: "Gmail" and "Other". By using "Other" option, user can manually setup SMTP server, security type and server port.

Note:

- Password length limit into range 6~20 chars in UTF8 format.
- User cannot set port 5000 (SICP default port) and 2121 (FTP server default port).
 - SICP network port setting in "Settings -> Signage Display -> Network Application -> SICP network port".
 - FTP network port settings in "Settings -> Signage Display -> Server settings -> FTP -> Port".

Gmail: (SMTP server, Security type and Port are grayed)

SMTP

Server

Gmail

Other

Email

_____ (for example, example@gmail.com)

Password

SMTP Server

Security type

None ▾

Port

DISCARD **SAVE**

Other:

SMTP

Server

Gmail

Other

Email

_____ (for example, example@gmail.com)

Password

SMTP Server

Security type

None ▾

Port

DISCARD **SAVE**

Gmail Security Settings

Open a web browser and login into your Google account. Click on "Security" menu (it can be located on the left or at the top of the webpage).

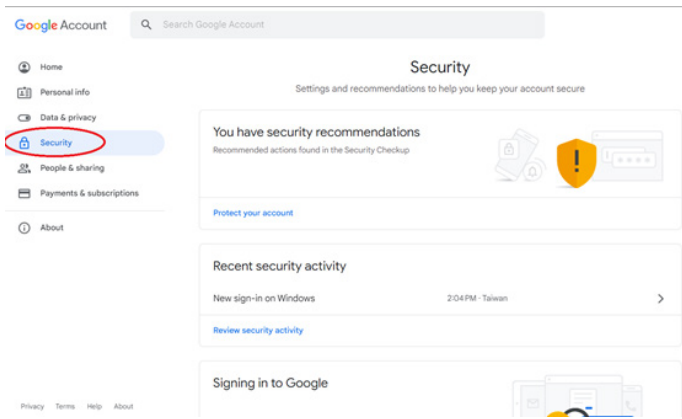

Step 1 - Select "2-Step Verification"
If 2-Step Verification is not turned on, click it to enable it.

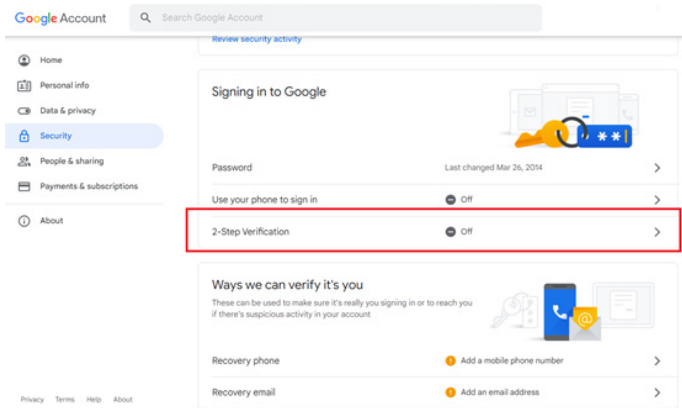

Step 2 - Configure 2-Step verification
Click the "GET STARTED" button to start configuring the 2-step verification options.

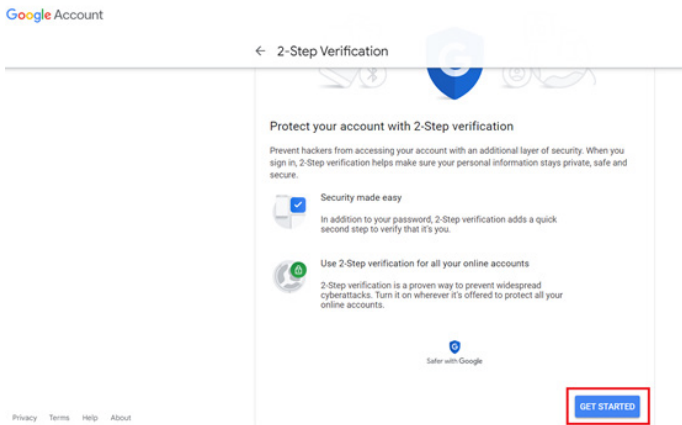

You may be prompted to log in to your Google Account again to confirm it's you:

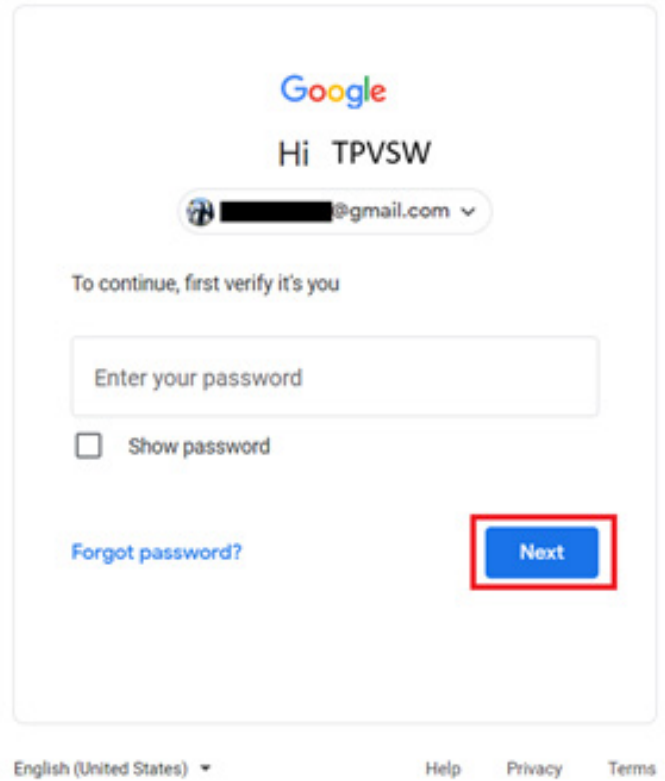

Step 3 - Use your Phone to Complete Configuration
Use on-screen instructions and available options to complete 2-Step verification using your phone.

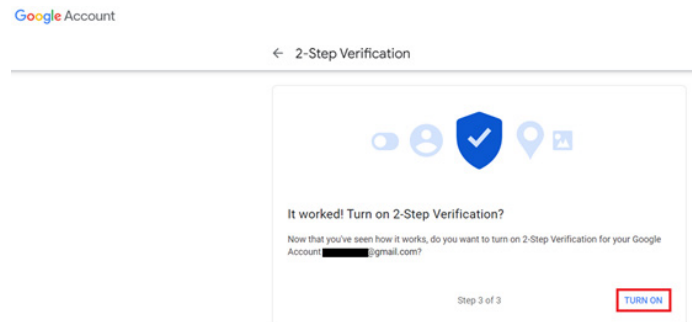
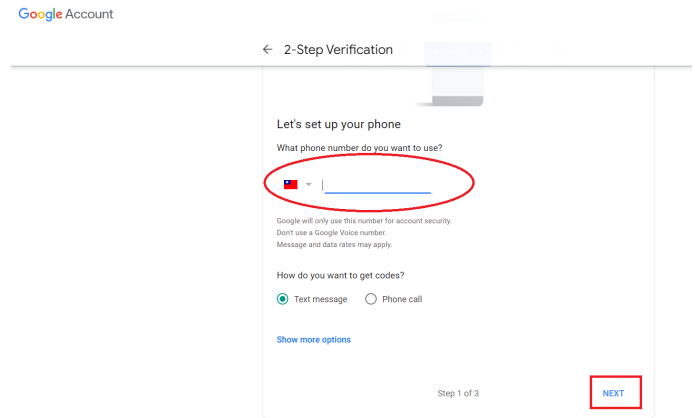

Step 4 - Create the App Password

Click on "App Password" option to create a new application password:

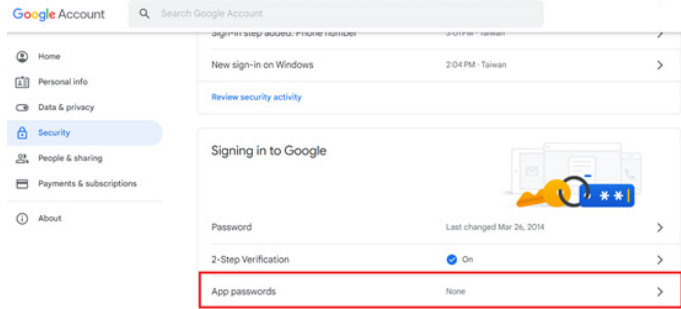

Step 5 - Add New App Name

First, select a device (for example, Windows Computer) and then click on "Select App" menu and choose "Other (custom name)":

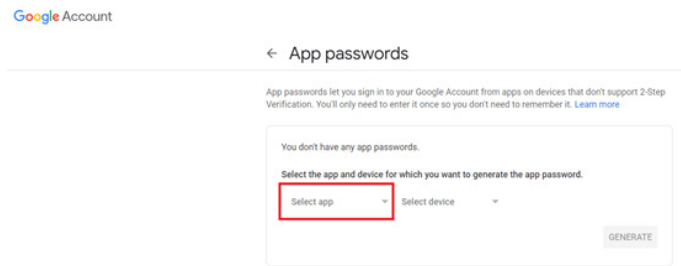

Enter a custom application name (it really does not matter what name is used in this field). Click "Generate" button: (Ex. Enter "SignageDisplay" as an app name)

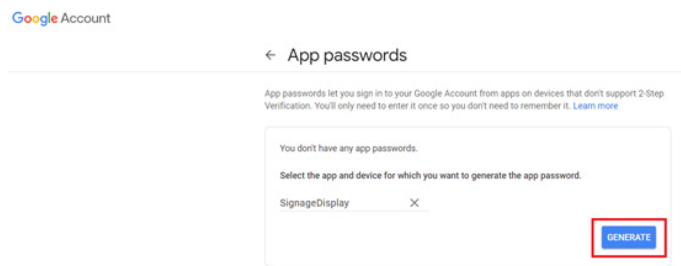

Record the auto-generated app password or simply select it and copy to the clipboard for the later use.

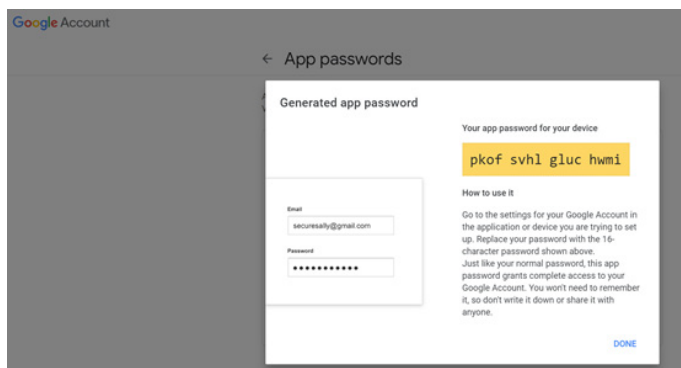

App passwords let you sign in to your Google Account from apps on devices that don't support 2-Step Verification. You'll only need to enter it once so you don't need to remember it. [Learn more](#)

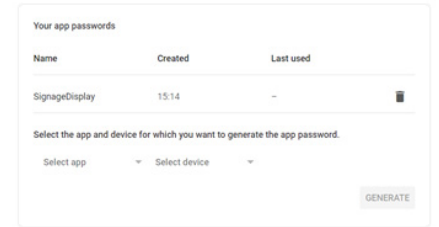

(2). Manager Email

Setup manager (receiver) E-mail address. Device will send E-mail to this account.



(3). Test

Click "Send Test Mail" will send out a test mail to check if settings are correct.

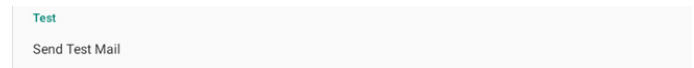

4.3.3.2.2. FTP

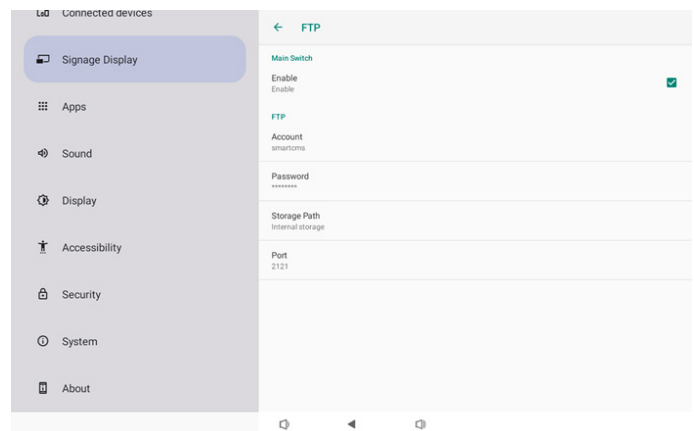

Click the checkbox to enable/disable FTP server feature. After enable, user can setup account, password and port number.

- a. Account: The username for login FTP server. The length of name in range 4~20 characters, and only allow [a-z][A-Z][0-9].
- b. Password: The password for login FTP server. Password length in range 6~20 characters, and only allow [a-z][A-Z][0-9]. The password will show "*" only after set up.
- c. Storage path: The FTP server will access internal storage only. Cannot be changed by user.
- d. Port: The port number for FTP server. Available port number range from 1025 to 65535, default is 2121. The following port number cannot be used: 8000 / 9988 / 15220 / 28123 / 28124 and SICIP network port (default 5000).

Finally, manually reboot system to apply FTP settings.

4.3.3.2.3. Remote Control

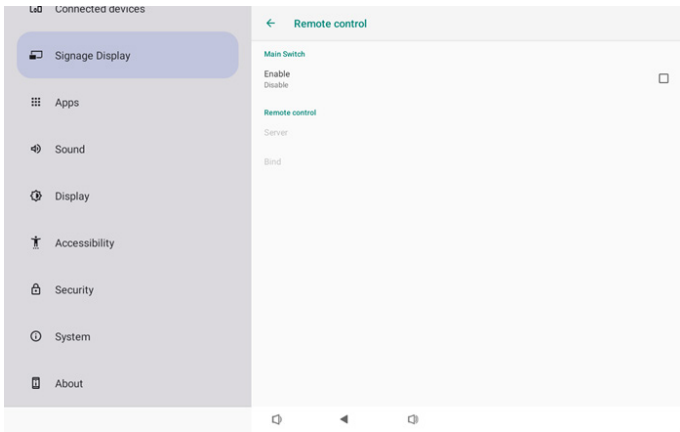

Click Enable checkbox to enable/disable remote control client service, default is disabled. To use remote control must bind device with remote control server.

“Server” for user input remote control server URL address (with https:// prefix). If device does not bind with remote control server before, please input PIN code provided by server.

Bind status:

- (1).When device does not have network, showing “Network is disconnected”.
- (2).If device has network, but not connected with remote control server, showing “Server is disconnected”.
- (3).If server is connected but not bind with server, showing “Server is unbinded”.
- (4).If device bind with server successfully, showing “Server is binded”.
- (5).If PIN code is not correctly, showing “Error PIN code”.

4.3.3.2.4. SNMP

Enable/Disable SNMP service.

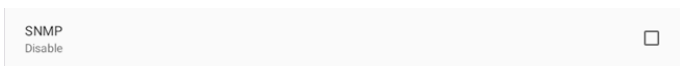

Please refer to the SNMP user manual.

4.3.3.2.5. ADB over Network

You can access ADB over a network connection with port 5555.

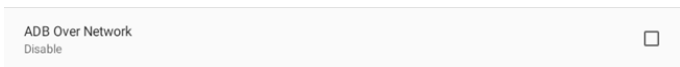

4.3.3.3. Source Settings

User can configure source APK’s detail options.

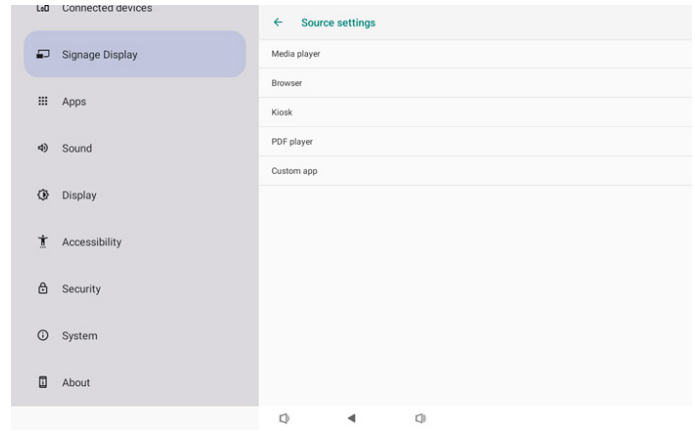

4.3.3.3.1. Media Player

Open Media Player APK’s edit play list activity and edit effect stings activity.

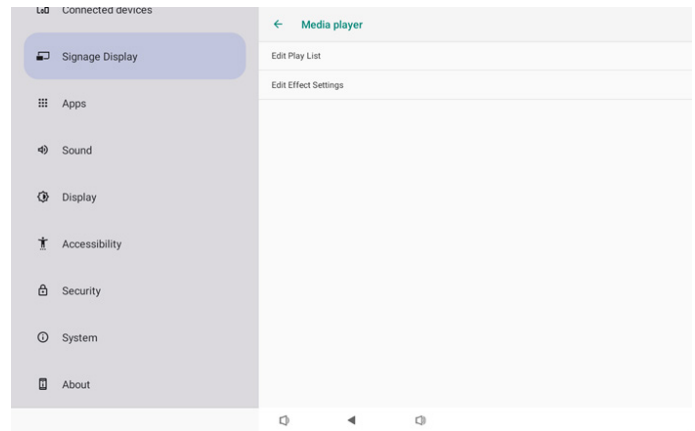

4.3.3.3.2. Browser

Open Browser APK’s bookmark editor activity.

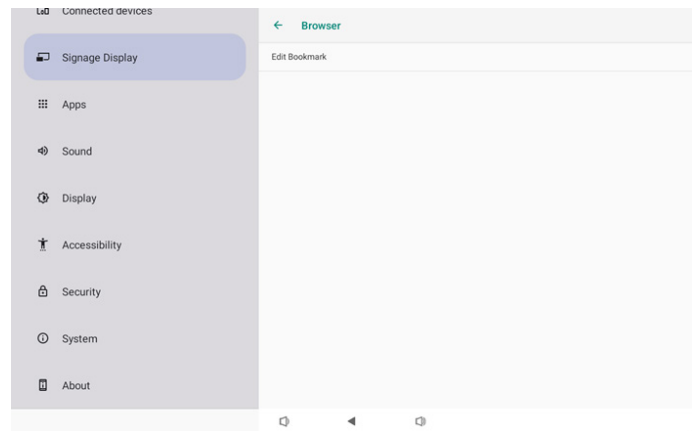

4.3.3.3. PDF Player

Open PDF Player APK's edit play list activity and edit effect settings activity.

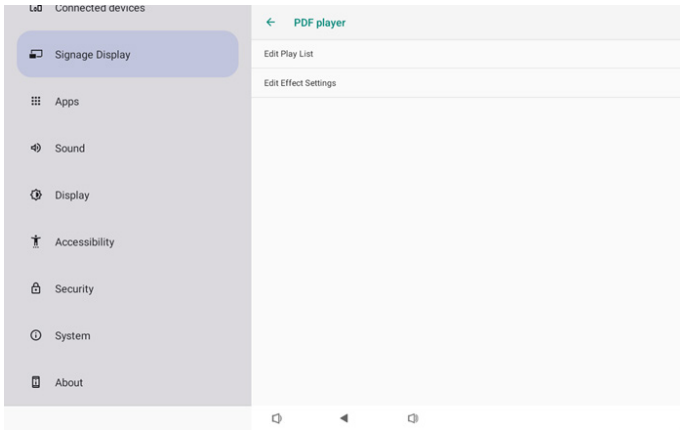

(1).FORGET

Clear custom source application. Gray if user does not set customer source application.

(2).CANCEL

Do nothing and close dialog.

(3).SAVE

Click SAVE to choose selected APK as custom source application. Gray if there is no available application can be selected.

- Force Restart Custom APP

System can monitor custom APP exist or crash when enable "force restart custom APP". If custom APP leaved, and boot on source is set to "Custom app", system will try to lunch custom APP again.

Default is disabled.

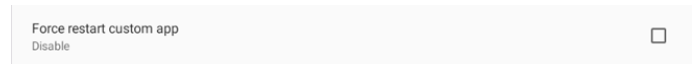

4.3.3.4. Custom app

User set up customer source APK. The selected APK will be launch when switch into customer input source. If user does not set up customer source APK, system will show black screen when switch into customer input source.

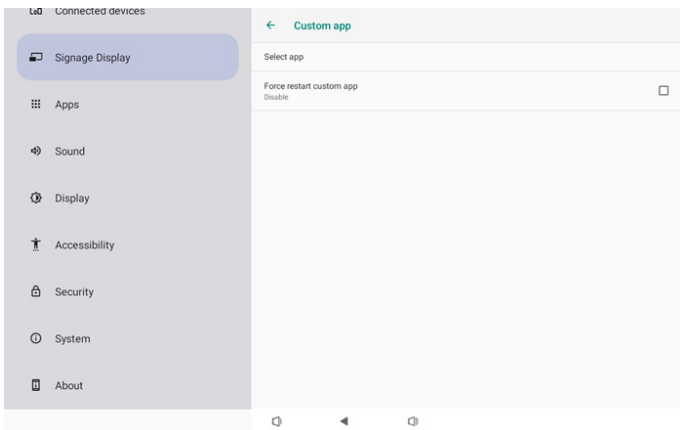

4.3.3.4. Network Application

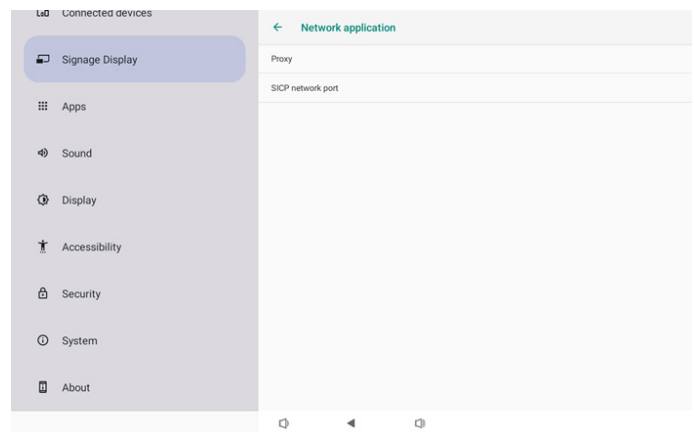

If user set up APK for custom app source, it will show APK name. If not, means that user does not set up custom app.

- Select APP

Select specific APP for custom APP source.

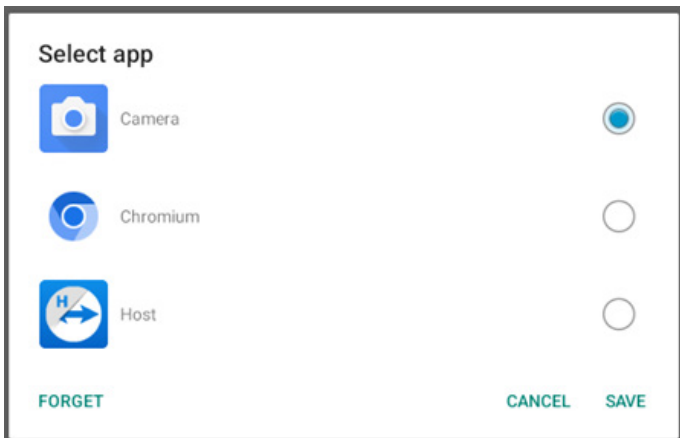

4.3.3.4.1. Proxy

Enable/disable network proxy by click "Enable" checkbox. User can set up host IP and port number of the proxy server. Default is disabled.

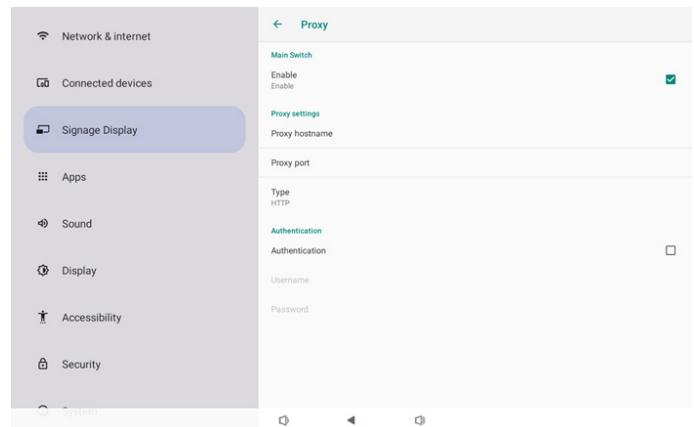

System supports following proxy type: HTTP, HTTPS, SOCKS4, and SOCKS5. Choose one for your proxy server.

Note:

Most system pre-installed APKs will not show in list. Only list the APKs that user manually installed and removable APKs.

Buttons:



If proxy server request authorization by login name and password, enable Authentication and enter Username and Password.

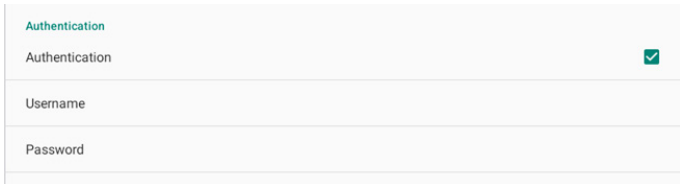

4.3.3.4.2. SICP Network Port

Set up SICP default port and enable/disable network SICP. Default SICP is enabled and using port 5000.

Note:

1. Port number range from 1025 ~ 65535.
2. Following port already been used, cannot assign to SICP network port: 8000, 9988, 15220, 28123, 28124 and FTP port (default 2121).

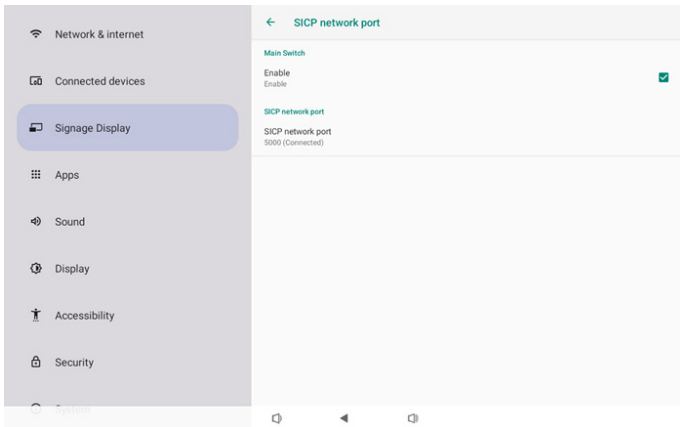

4.3.3.5. System Tools

There are eight major features in signage display system

- (1). Clear Storage
- (2). Reset
- (3). Auto restart
- (4). Import & Export
- (5). Clone
- (6). Security
- (7). Admin Password

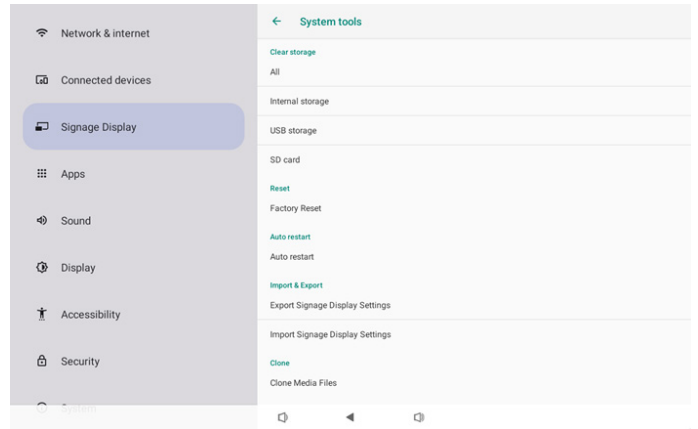

4.3.3.5.1. Clear Storage



Use to clear all data under {storage}/philips/ folder in internal and external storage

- All
- Internal Storage
- USB Storage
- SD card

Clear philips/ folder in internal storage, USB and SD card.
Clear philips/ folder in internal storage only.
Clear philips/ folder in USB storage only.
Clear philips/ folder in SD card only.

A dialog will list folders that system going to clear. Press "RESET" to clear all data under listed folder. Or press back key to leave and do nothing.

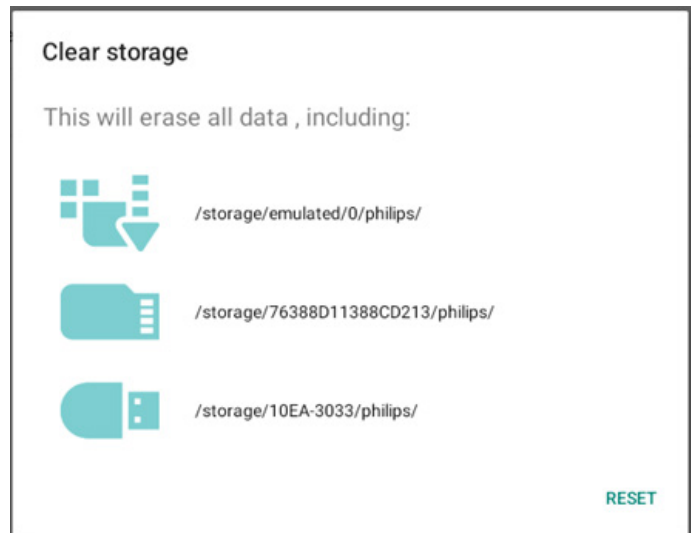

4.3.3.5.2. Reset

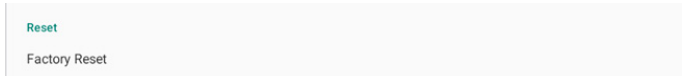

- **Factory Reset**

Doing factory reset to clear all user data and settings. System will auto reboot and jump to OOB after finished.

Important Note:

- (1). All data in system will ERASE and CANNOT REVERT; including device settings, installed APPs, APPs' data, download files, music, photos and all data under /data. However, data in USB storage will not be clear, only clear the data in internal storage.
- (2). Must make sure AC adapter and power always exist during factory reset. Only can power off after user seeing OOB on screen again.

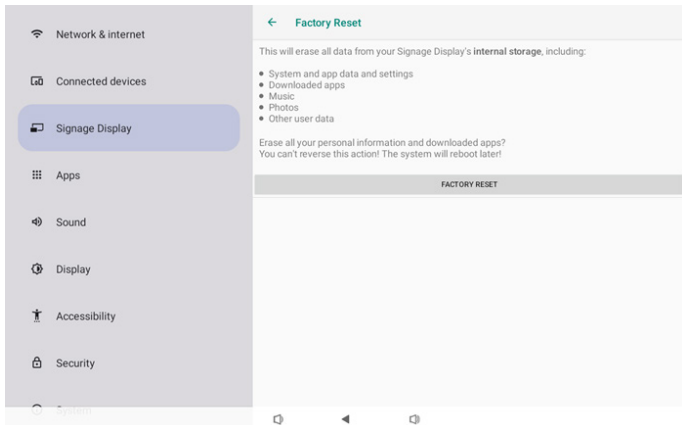

Doing factory reset by click "FACTORY RESET", system pop up a dialog and ask again. Please make sure you understand what you are doing, then press "OK" to perform reset action. Note that this action cannot reverse and erase all data in internal storage.

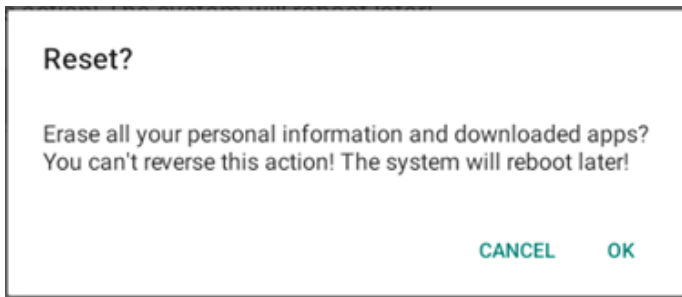

4.3.3.5.3. Auto Restart

User can set device auto restart every day in specific time.

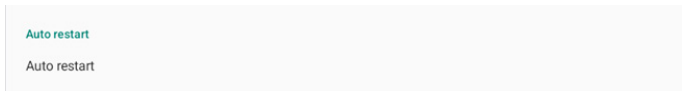

Set enable or disable in main switch to control auto restart feature.

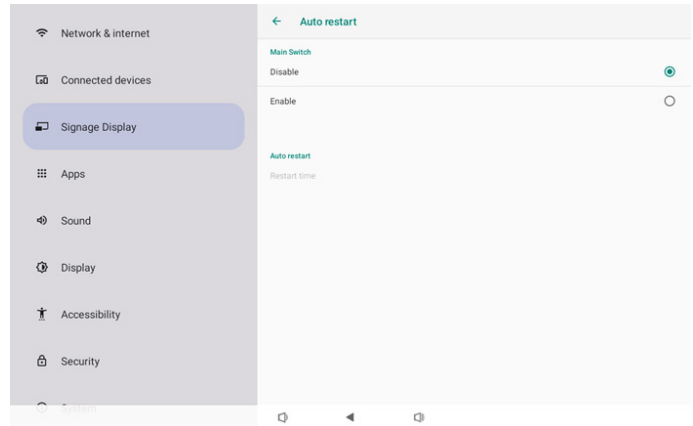

User can set restart time in time picker.

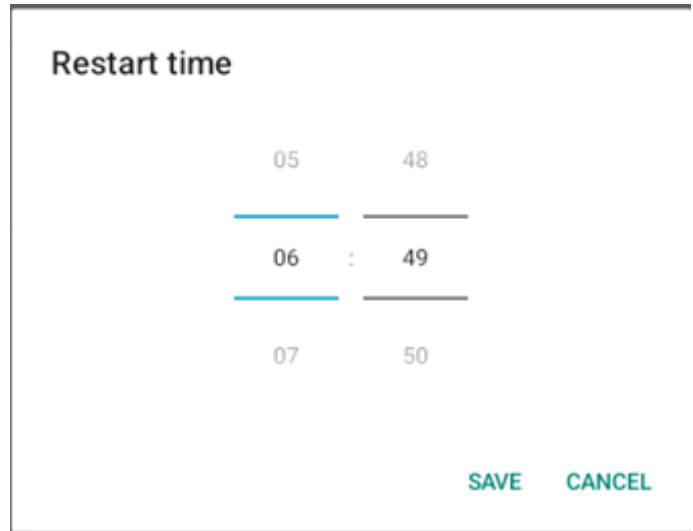

After "SAVE", system restart time will show in below. System will do restart in specific time.

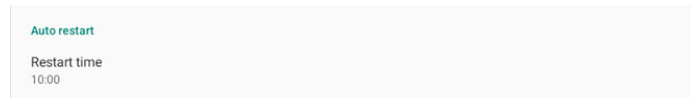

4.3.3.5.4. Import & Export

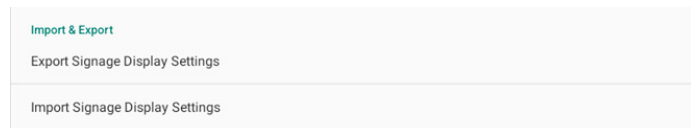

Use export/import signage display setting for user easy copy database settings and 3rd part APK to other device. Please note that:

- (1). Export data to 10BDL3351T-clone.7z file under {storage}/philips/clone folder.
- (2). "Signage Display Name" will not be imported/exported.

- **Export Signage Display Settings**

System exports database data and third party APKs into {storage}/philips/clone/10BDL3351T-clone.7z file in selected storage (internal storage, USB storage and SD card).

Note:

If selected storage (internal storage, USB external storage and SD card) does not have philips/ folder, system will create it.

List all available storage (internal storage and USB storage and SD card) for user choose one of them.

List all available storage (internal storage and USB storage and SD card) for user choose one of them.

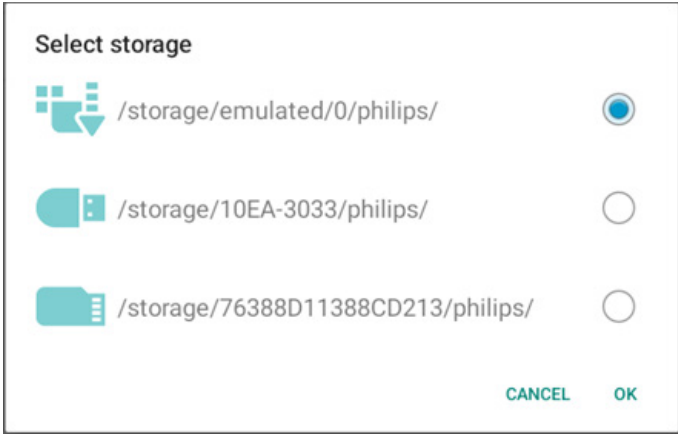

• Import Signage Display Settings

Import database data from philips/clone/10BDL3351T-clone.7z file of selected storage (internal Storage, USB storage and SD card). System imports following data in ZIP file:

- (1).Import Database in 10BDL3351T-clone.7z
- (2).Import 3rd party APK in 10BDL3351T-clone.7z

List all available storage (internal storage, USB and SD card).

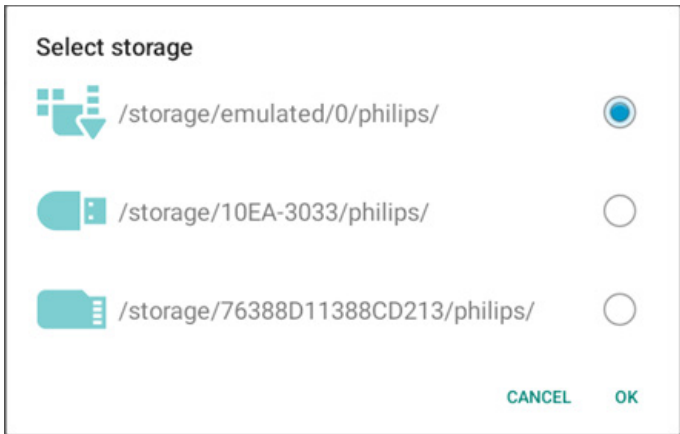

System pop up notification dialog before import settings and APKs. Click "OK" to start import data.

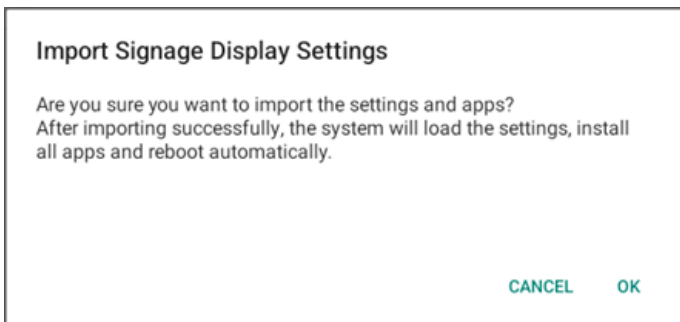

4.3.3.5.5. Clone

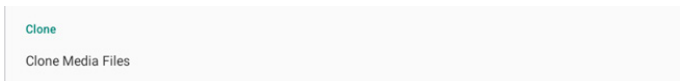

• Clone Media Files

System clone media files from selected source storage to target storage.

- (1).System clone files under following list of folder:

- a. philips/photo
- b. philips/music
- c. philips/video
- d. philips/pdf
- e. philips/browser

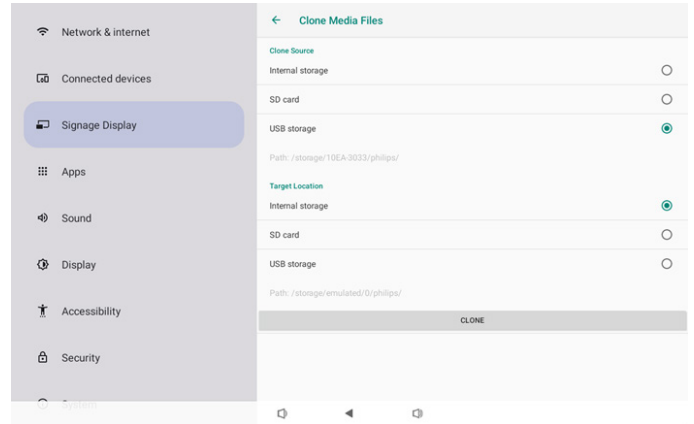

4.3.3.5.6. Security

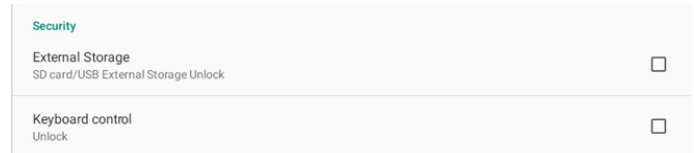

• External Storage

Click the checkbox to lock or unlock external storage (SD card/USB storage). Default is unlocked.

Note:

When you disable external storage lock for enable state, please unplug and plugin external storage again (for SD card and USB storage). After that, system can detect external storage again.

• Keyboard control

Click the checkbox to lock or unlock keypad button.

4.3.3.5.7. Admin Password

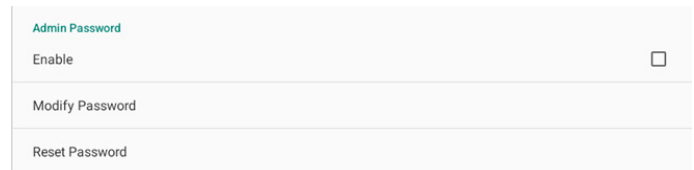

• Enable

Click the checkbox to enable or disable Admin Password. Default is disable.

- Unchecked: Disable.
- Checked: Enable.

Note:

After enable, you need password to login Admin Mode. Default password is "1234".

- **Modify Password**

You could change the password if need password for login Admin Mode. Follow below steps:

- Enter current password first. Default password is "1234".

If current password not correct, you will see an Android Toast "Incorrect password" message.

- Enter new password.

- Enter new password again.

If new password again not match new password, you need to try again.

If change password successfully, you will see an Android Toast "Successful" message.

- **Reset Password**

You could reset the password to default "1234". If success, you will got a "Successful" message.

4.3.3.6. Misc.

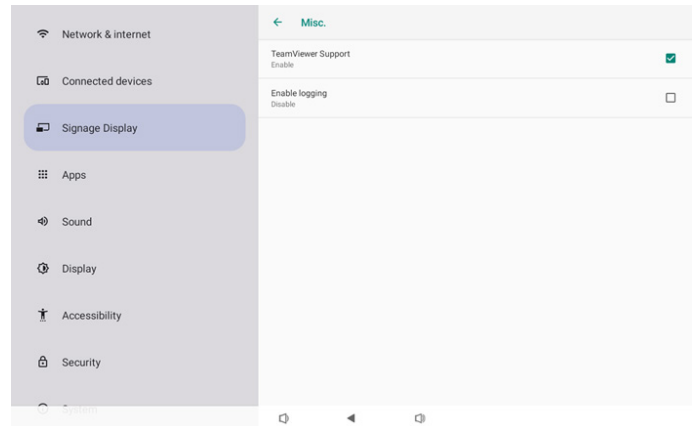

4.3.3.6.1. TeamViewer Support

Click the checkbox to enable or disable TeamViewer support. TeamViewer will send a virtual HOME key to open Admin mode. Default is enable.

TeamViewerHost and TeamViewerQSAddOn APKs will auto install into system. Otherwise, system will remove them if user disable "TeamViewer Support".

The following two APKs will list in Settings->Apps if TeamViewer support enabled.

4.3.3.6.2. Enable logging

Enable or disable logging via checkbox.

Once enabled, PD will start logging android logcat log, kernel message and saved them into USB or internal storage automatically. The first priority is USB storage. If there are no any connected USB devices on PD, all data will then be saved into internal storage.

The saved path will be {root directory of USB storage}/ philips/ Log/10BDL3351T-Log-{ yyyy-MM-dd-HH-mm-ss }

Or {root directory of internal storage}/ philips/ Log/10BDL3351T-Log-{ yyyy-MM-dd-HH-mm-ss }

If disabling logging, all data will be saved to a zip file like {root directory of USB storage}/ philips/Log/10BDL3351T-Log-{ yyyy-MM-dd-HH-mm-ss }.zip

Or {root directory of internal storage}/ philips/ Log/10BDL3351T-Log-{ yyyy-MM-dd-HH-mm-ss }.zip

4.3.3.7. System updates

4.3.3.7.1. Local update

System will auto search "update.zip" in root folder of Internal storage, USB storage and SD card. If system found "update.zip", pop-up a selectable list for user select which file user wants to use for update.

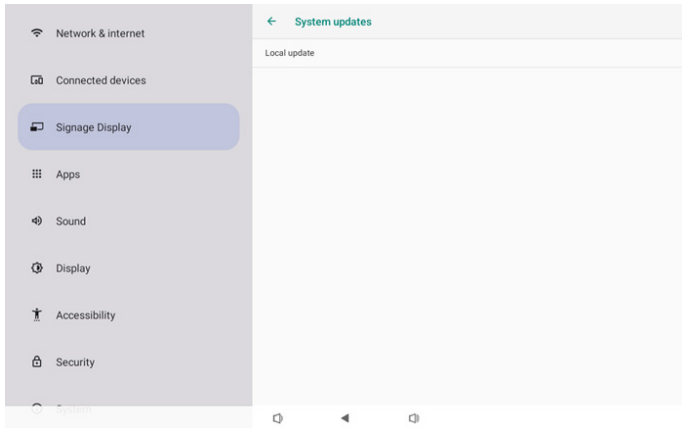

After select the file in list, system will reboot and do system update.

Please note that:

1. Keep system power alive during system update, do not remove power adapter.
2. Currently system only support full Android update.
3. The update file must name as "update.zip" only.

4.3.4. Apps

Display installed APKs information.

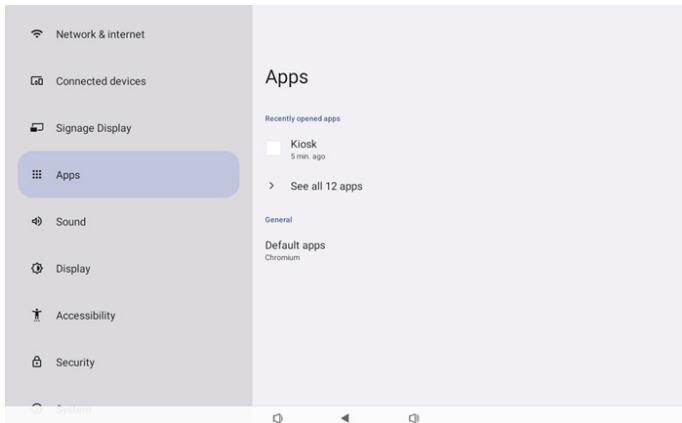

4.3.5. Sound

Set Volume.

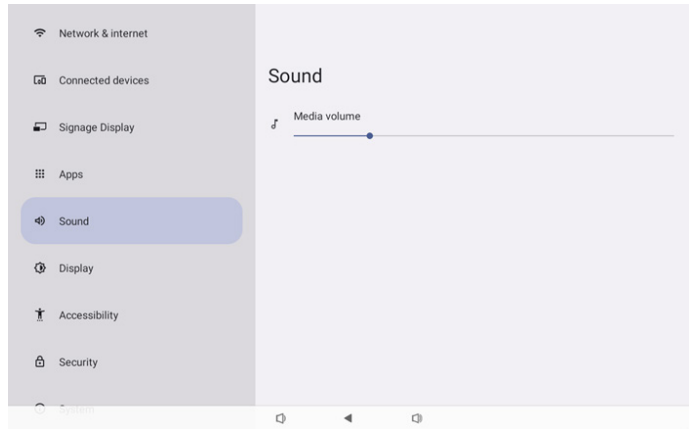

4.3.6. Display

There are following features in Display.

- (1). Brightness level
- (2). Font size
- (3). Sleep
- (4). Auto-rotate screen
- (5). Screen saver
- (6). HDMI

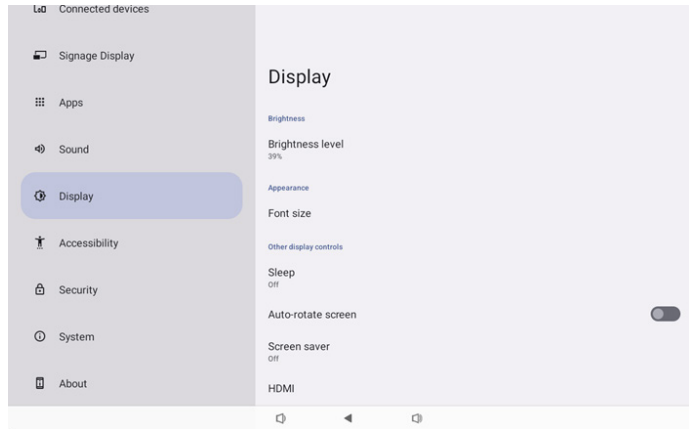

4.3.6.1. Brightness level

The adjust bar will be show on top of the screen. Drag adjust bar to set brightness.

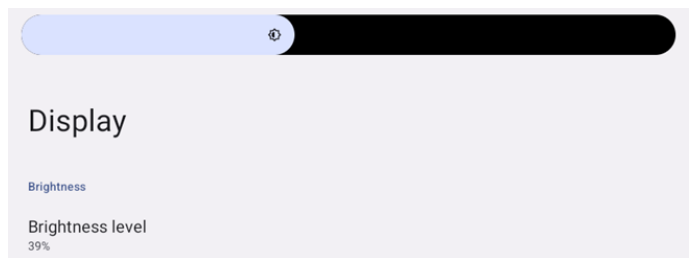

4.3.6.2. Sleep

Set up the time system go into sleep. Option "off" means that system will not go into sleep, screen will always on. Default is "off".

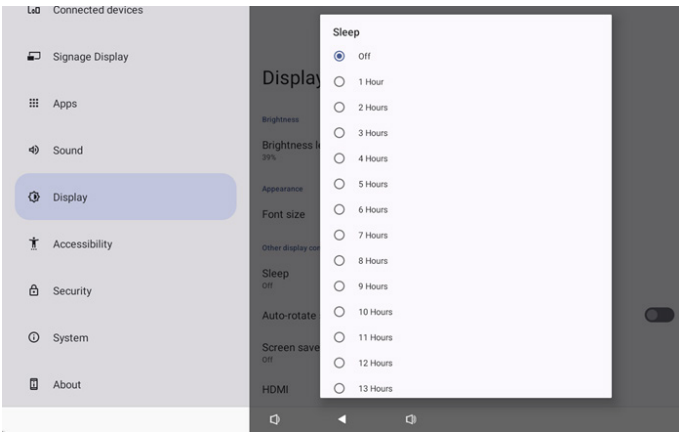

Options are off, 1 hour to 24 hours.

If screen saver is enabled. The sleep options will be changed. Settings the time system start screen saver.

Options are off, 1 minute, 2 minutes, 5 minutes, 10 minutes and 30 minutes for screen saver is on.



4.3.6.3.Auto-rotate screen

Turn On/Off to switch the rotation settings:

1. Turn On : Rotate the contents of the screen
2. Turn Off : Stay in current orientation

User can rotate the contents of the screen when device is rotated if select "Rotation the contents of the screen". If user want to disable rotation, select "Stay in current orientation". System will not rotate the contents but it will stay in current orientation when user set "Stay in current orientation".

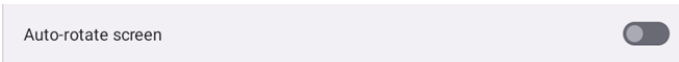

Orientation and HDMI output

See the table below:

Orientation	Panel Output	HDMI output
Landscape		
Portrait		
Reverse Landscape		
Reverse Portrait		

4.3.6.4.Screen saver

Enable screen saver by switch enable/disable main switch in Settings -> Display -> Screen saver.

User can choose screen saver mode: Photo Frame.

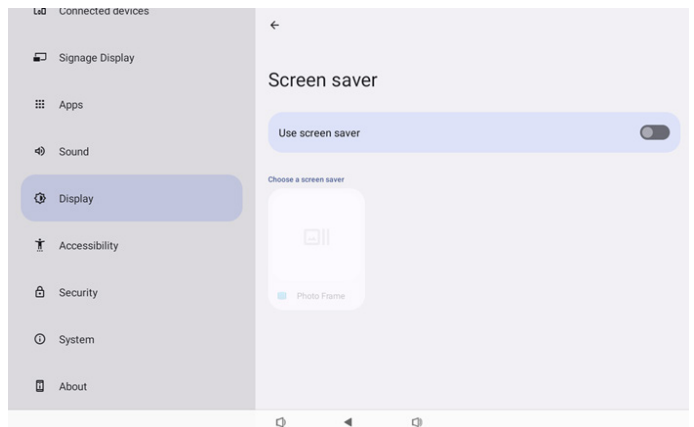

4.3.6.4.1. Screen saver disable

Schedule priority is higher than sleep/screen saver settings. If schedule is on, the sleep/screen saver setting not effect schedule. System will keep display scheduled source until schedule off.

When device is sleep, keypad still workable. User can wake up device by keypad: "menu + menu + volume down + volume down". The default screen is black and nothing display on it. Admin mode "menu + volume down" and quick info "menu + volume up" still work when system sleep and will be show after user wakeup screen

4.3.6.4.2. Screen saver enable

If screen saver is running, touch panel to leaving screen saver.

4.3.6.5.HDMI

HDMI will automatically output when use connect external monitor with HDMI output port. There are two available adjustment for HDMI output:

- (1).Turn on HDMI
- (2).Resolution
- (3).Screen Zoom
- (4).System Direction

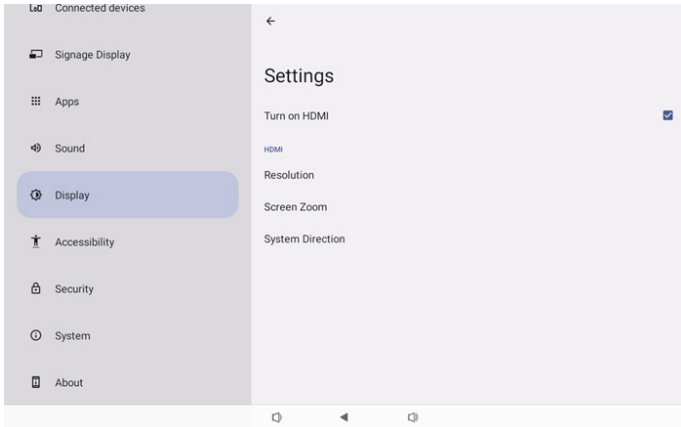

4.3.6.5.1. Turn on HDMI

Turn on/off the HDMI output.

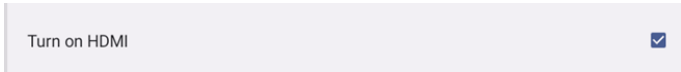

4.3.6.5.2. Resolution

Set HDMI output resolution. The HDMI monitor supported resolution will be list in select dialog. Depend on monitor EDID, resolution list will be changed on different monitor.

And note that output content is the same as panel content, so the HDMI content will be scaling up or down to match HDMI output resolution. The best content resolution of panel is 1920x1080. Content resolution will not be changed when user set different HDMI output resolution.

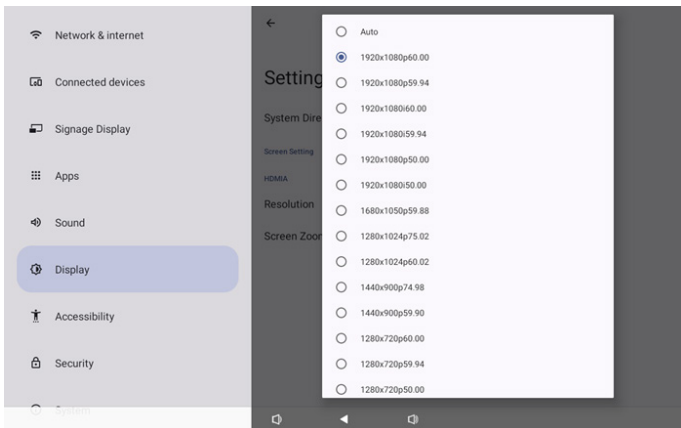

4.3.6.5.3. Screen Zoom

Zoom in or up HDMI output screen. Press "DOWN"/"UP" to increase/decrease screen in vertical. And "RIGHT"/"LEFT" to increase/decrease screen in horizontal.

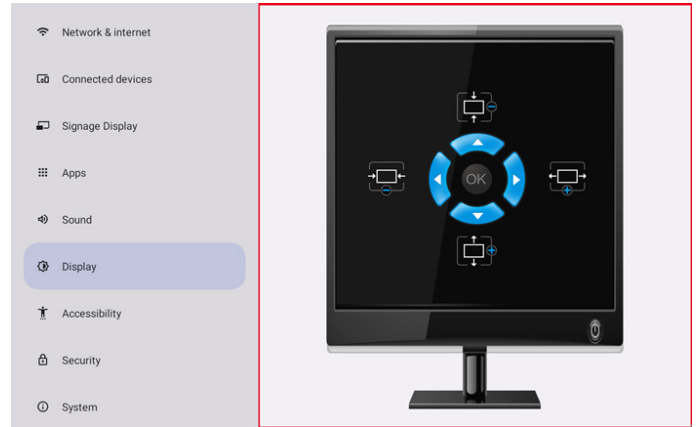

4.3.6.5.4. System Direction

User can fix device rotation screen content and HDMI output direction.



4.3.7. Accessibility

Accessibility services are apps that can help users with disabilities or special needs to interact with their Android device more easily.

In the Downloaded apps menu, you can view all the accessibility apps that are installed on the device, and enable or disable them as needed. You can also access the settings for each individual accessibility app by tapping on its name in the list.

4.3.8. Security

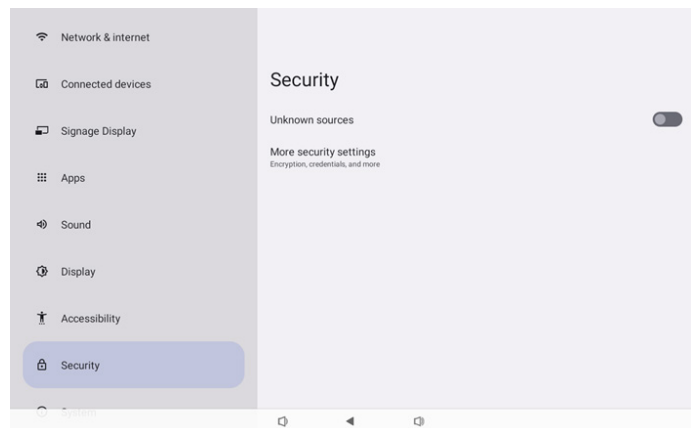

4.3.8.1.Unknown sources

Allowing app installs from Unknown Sources in Android.

4.3.8.2. More security settings

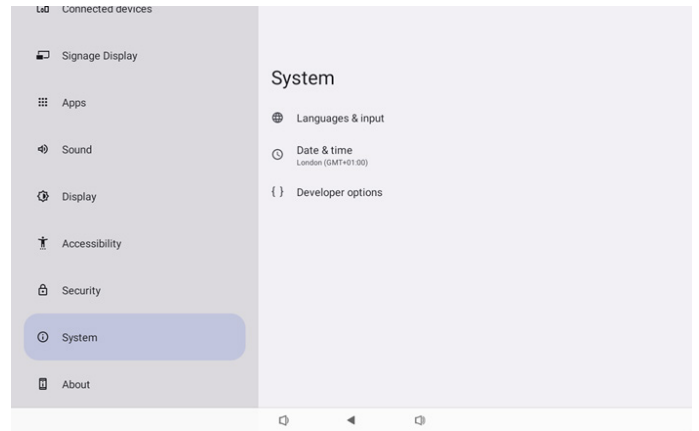
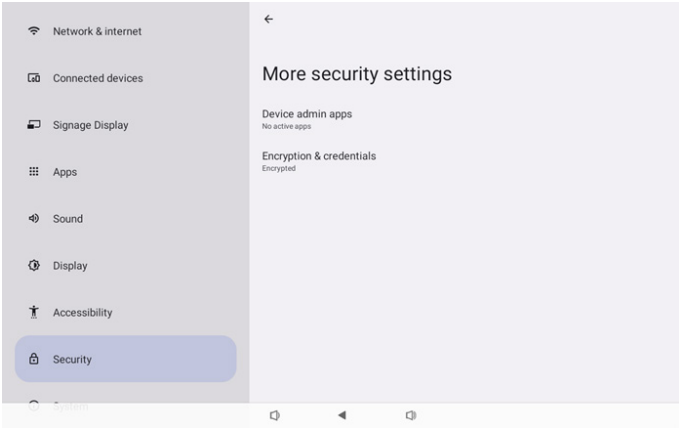

4.3.8.2.1. Device admin apps

A list showing the app that supports admin-related operations and controls.

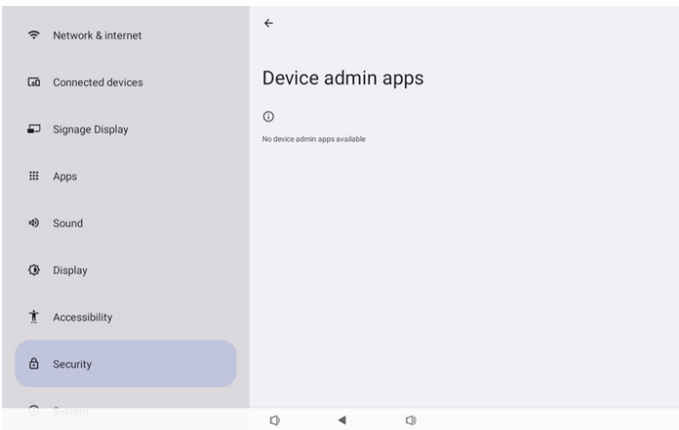

4.3.9.1. Languages & input

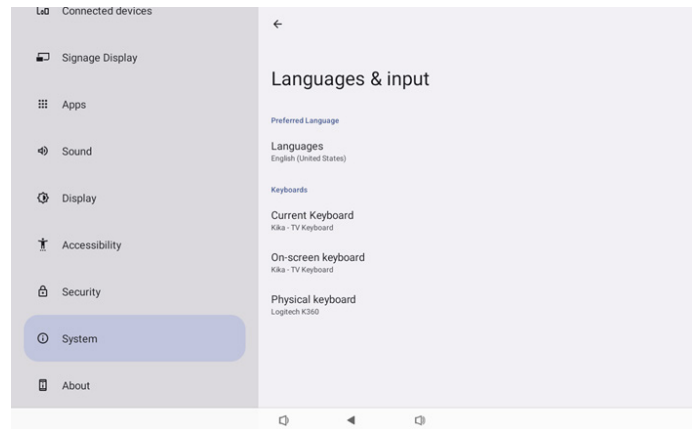

4.3.8.2.2. Encryption & credentials

This will display a list of all trusted certs on the device. User can install/uninstall certificates by themselves.

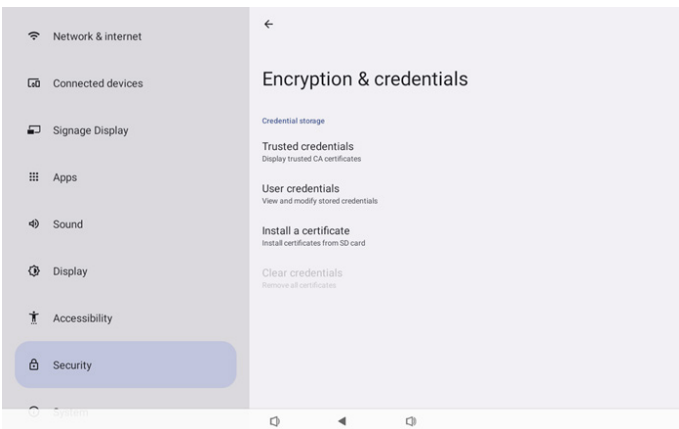

4.3.9.1.1. Language

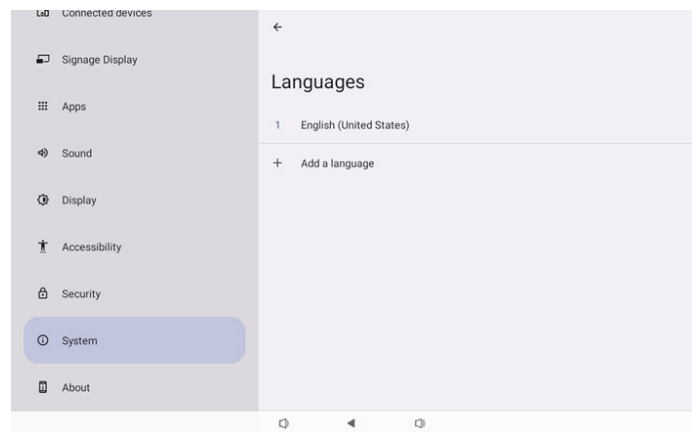

4.3.9. System

Following list will be show in Settings -> System

- (1). Languages & input
- (2). Date & time
- (3). Developer options

4.3.9.1.2. Keyboards

User can change IME and keyboard settings here.

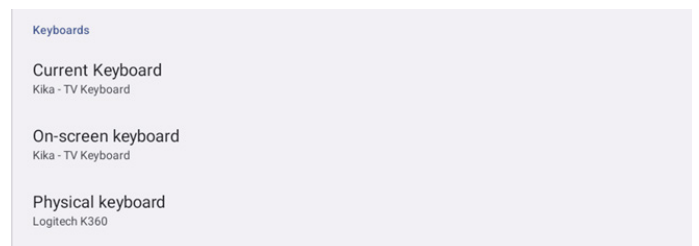

(1).Current Keyboard

Choose input method.

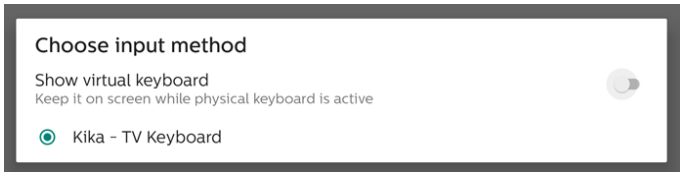

(2).On-Screen keyboard

Let user can set default software IME (Virtual keyboard) and control detail IME settings.

The Japanese IME will auto be installed when user select Japanese language in OOBE.

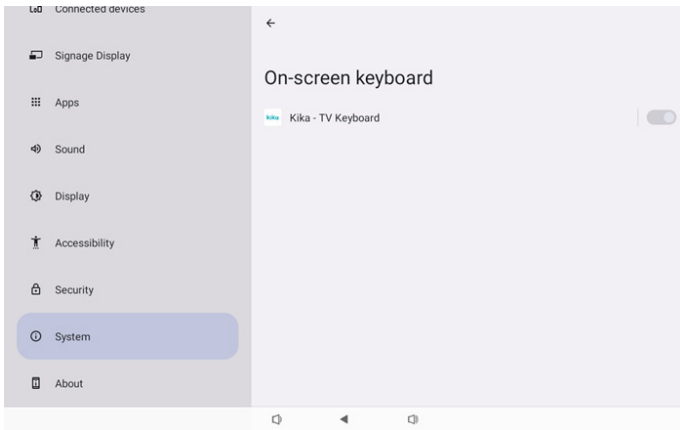

(3).Physical keyboard

Let user control physical keyboard and detail keyboard settings.

The "uinput-key" is system level keyboard for remote control; it will always exist on the keyboard list.

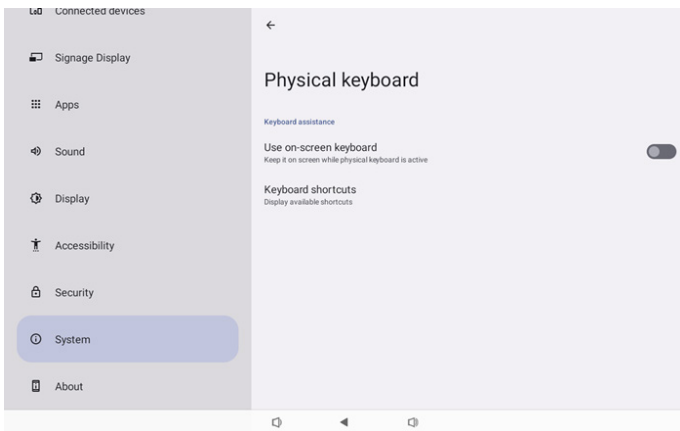

4.3.9.2.Date & Time

User can set date/time, change time zone and NTP server.

If "Set time automatically" is on, system will get date and time from NTP server. If "automatic data & time" is disabled, user can change date and time by "Set date" and "Set time".

User can change time zone in "Time zone". And use can also change 24-hour format in "1:00 PM" or "13:00".

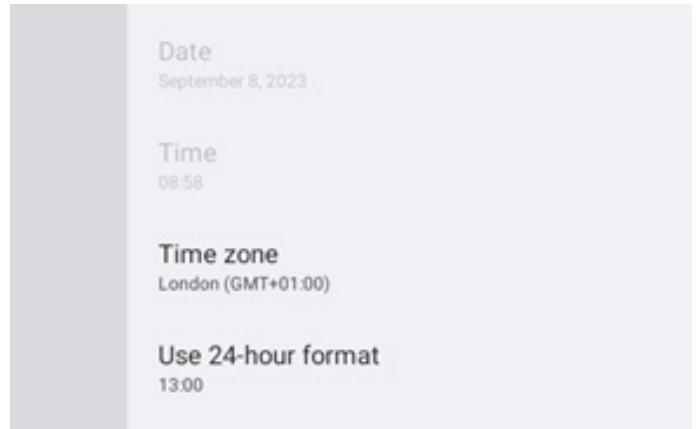

4.3.9.2.1. Time zone

Let user choose the time zone

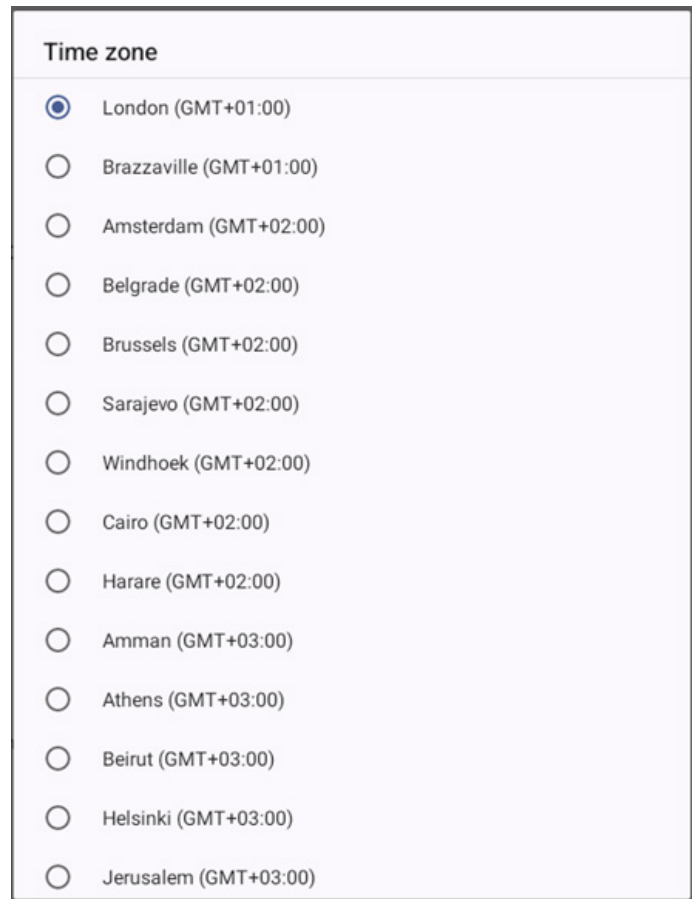

4.3.9.2.2. NTP Server

Let user can edit the NTP server in the prompted dialog

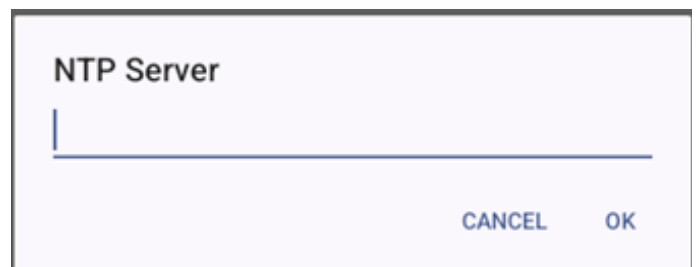

4.3.9.3. Developer options

Android developer options for developers, default is on and USB debugging is default on.

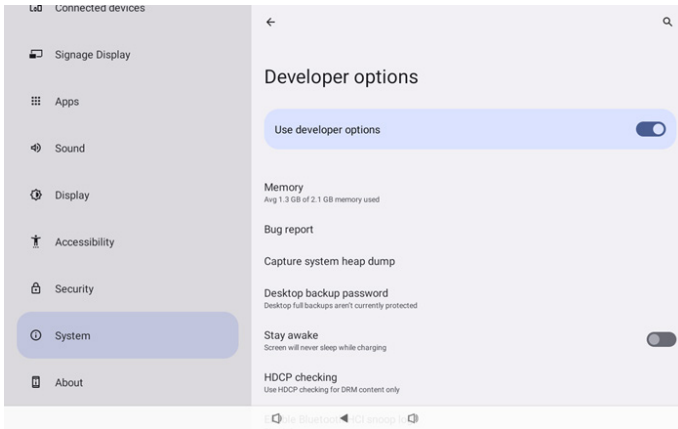

4.3.10.2. Model

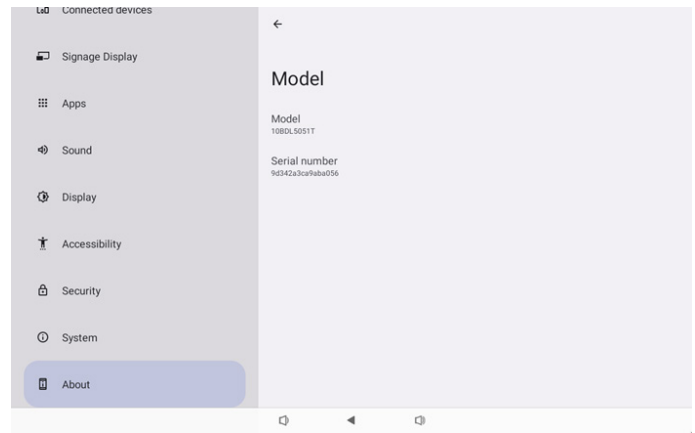

4.3.10. About

Following information shows in about page:

- (1).Legal information
- (2).Model
- (3).Android version
- (4).Up time
- (5).Build number

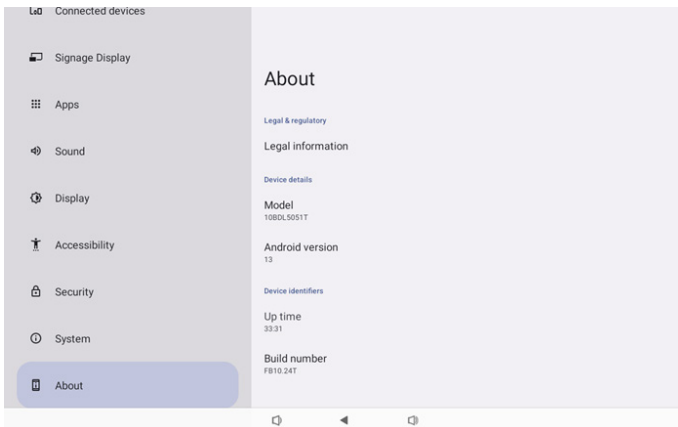

4.3.10.3. Android version

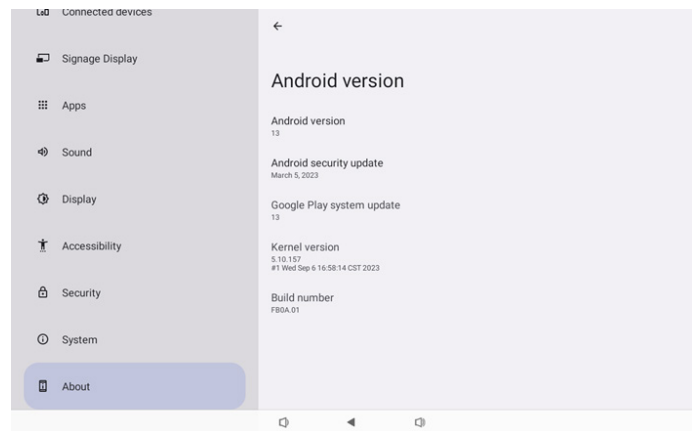

4.3.10.1. Legal Information

List all open source projects legal information and licenses here.

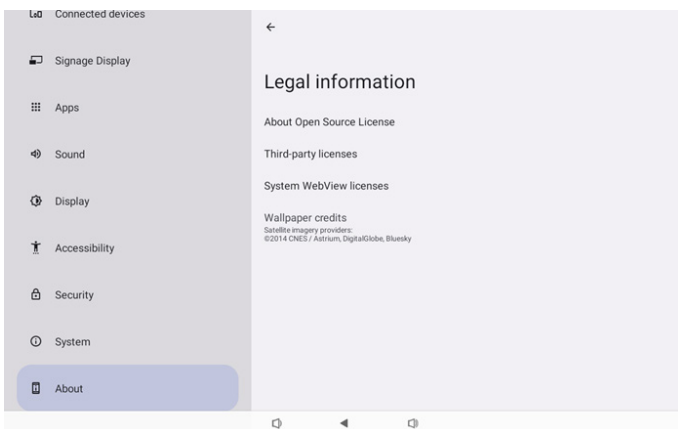

5. Appendix

5.1. Advanced features

(1). Install custom APK

You can use file-manager apk to install it. Please use key combination "Power+ V_Down" to enter "launch admin mode" page. -- click all app -- launch file manager app -- choose the apk to install

(2). Use the LED strips

Only SICIP commands can control the LED strips ON/OFF and colors.

* SICIP commands for controlling Side LED strips

Message-Set

Use this command to simultaneously switch on/off LED strips as shown above and set color based on R, G, and B values.

Bytes	Bytes Description	Bits	Description
DATA[0]	0xF3=Set		Command to set LED STRIPS ON/OFF and Choose color
DATA[1]	Light up status		0x00=off, 0x01=on
DATA[2]	Red value		Valid Values range from 0x00~0xFF only if DATA[1]=0x01
DATA[3]	Green value		Valid Values range from 0x00~0xFF only if DATA[1]=0x01
DATA[4]	Blue value		Valid Values range from 0x00~0xFF only if DATA[1]=0x01

* Led colors

	LED Behavior
Power LED	1. Power LED is amber when power is connected.
R/L LED strips	1. Default is OFF. 2. Only SICIP commands can turn ON/OFF and set colors on side LED strips.

(3). Use the camera

Use the key combination "Menu+ V_Down" to enter "launch admin mode", click "all app" launch camera app.

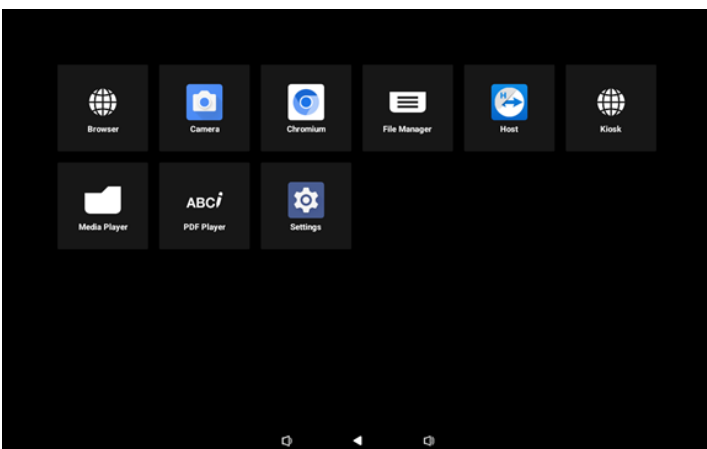

5.2. File manager app

1. The purpose of this software is to provide file browsing, copy, move and install APP, does not guarantee that all files can be opened.
2. Home page will list internal storage, SD card and USB storages. The external storage device must be named in English or by UTF-8.



NOTE:

For the normal operation of the system, the remaining space of the internal storage space needs to be reserved at 20MB.

3. Press OK key to select storage, it will list the folder(s) and file(s). You can press back key or select the top item of list to return to the parent directory.

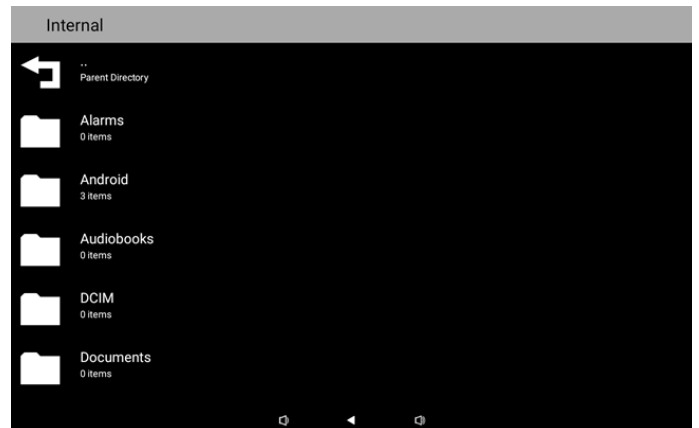

4. Press OK key at a folder or file, it will popup option dialog.
 - Open: open folder or file.
 - Delete: delete folder or file.
 - Copy: copy folder or file.
 - Move: move folder or file.
 - Select: select folder or file to do action.
 - Select All: select all items of this page to do action.

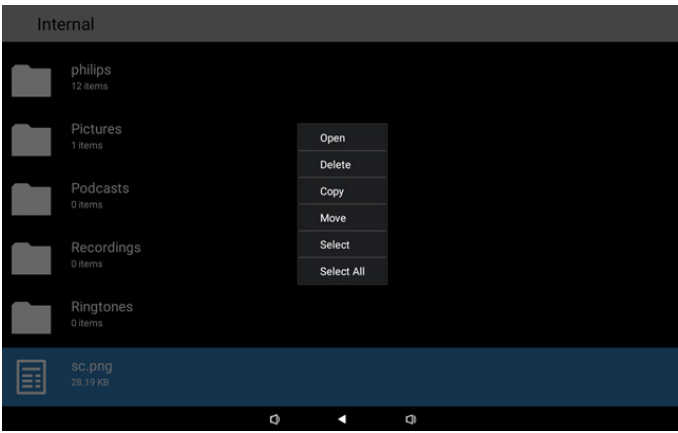

5. Select Copy or Move option, it will popup destination dialog.

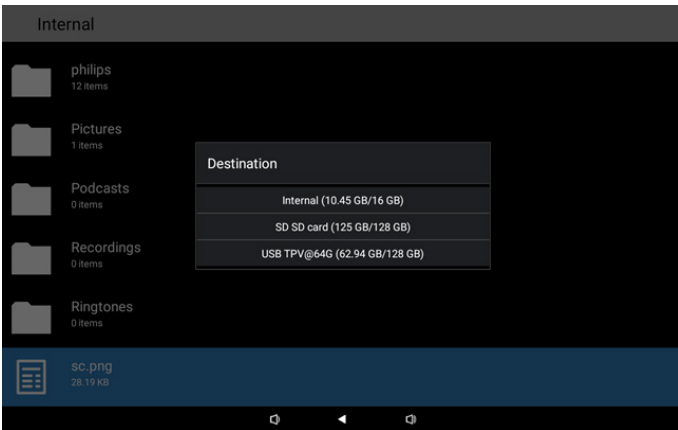

6. Select target storage, the bottom of screen will show function bar. Press up or down key to move to the destination, press left or right key to select the function.



If the focus bar is a folder it will paste in this folder.

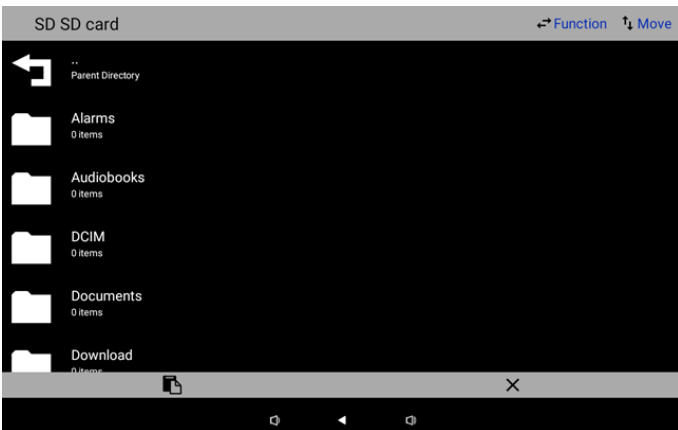

7. Press Select or Select All option, it will turn on the Select Mode.

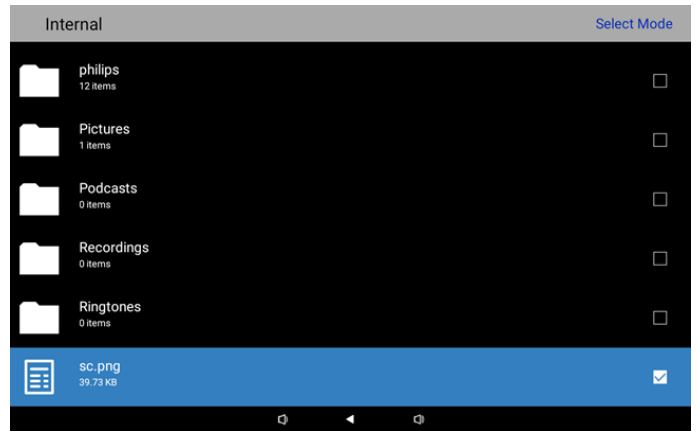

8. In Select Mode, press up or down key to move and press OK key to select multiple items.

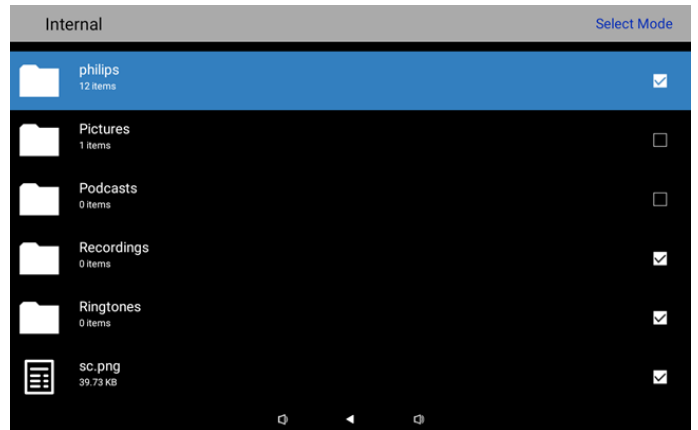

9. Press OK key at selected item, it will popup option dialog.
- Delete Selection: delete the selected folder(s) or file(s).
 - Copy Selection: copy the selected folder(s) or file(s).
 - Move Selection: move the selected folder(s) or file(s).
 - Unselect: unselect the selected folder(s) or file(s). Unselect the last selected item, it will turn off the Select Mode.
 - Unselect All: unselect all of the selected folder(s) or file(s). It will turn off the Select Mode.

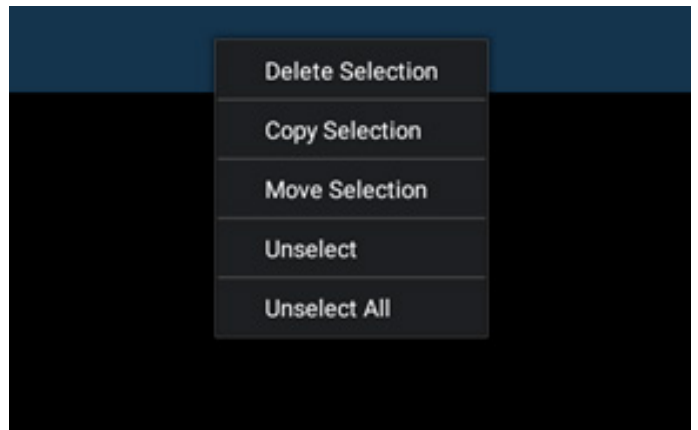

6. Cleaning and Troubleshooting

6.1. Cleaning

Caution When Using the Display

- Be sure to disconnect all cables before moving the monitor. Moving the monitor with its cables attached may damage the cables and thus cause fire or electric shock.
- Disconnect the power plug from the wall outlet as a safety precaution before carrying out any type of cleaning or maintenance procedure.

Front Panel Cleaning Instructions

- The front of the display has been specially treated. Wipe the surface gently using only a cleaning cloth or a soft, lint-free cloth.
- If the surface becomes dirty, soak a soft, lint-free cloth in a mild detergent solution. Wring the cloth to remove excess liquid. Wipe the surface of the display to remove dirt. Then use a dry cloth of the same type to dry.
- Do not scratch or hit the surface of the panel with fingers or hard objects of any kind.
- Do not use volatile substances such as insert sprays, solvents and thinners.

6.2. Troubleshooting

Symptom	Possible Cause	Remedy
No picture is displayed	<ol style="list-style-type: none"> 1. The adapter is disconnected. 2. The monitor is in the standby mode. 	<ol style="list-style-type: none"> 1. Make sure that the power LED is green. Or plug in the adapter. 2. Press Menu + Menu + Volume- + Volume- to turn on the screen.
HDMI output is abnormal	<ol style="list-style-type: none"> 1. HDMI cable is not connected properly. 2. The external device is abnormal. 	<ol style="list-style-type: none"> 1. Make sure that the HDMI cables are attached firmly. 2. Make sure that the external device is in good condition.
Micro USB HOST & Type A USB HOST & LAN interface is abnormal	<ol style="list-style-type: none"> 1. USB cable or output device is abnormal. 2. The cable is not connected properly. 	<ol style="list-style-type: none"> 1. Make sure that the USB cable and output device are in good condition. 2. Make sure that the cable is connected properly, and that the RJ45 interface LED is green.
Can't detect the USB device and SD card	The settings for USB device and SD card are disabled.	Press the "MENU" button, choose "setting" to enable the function.
The display looks normal but the touch function doesn't work	The touch function is disabled.	Press "Menu + Menu + Volume+ + Volume- + Volume- + Volume+" to enable the touch function.

7. Technical Data

7.1. Specifications

Display:

Item	Specifications
Screen Size	10.1"
Number of pixels	1280 (H) x 800 (V)
Brightness (typical)	310 cd/m ²
Viewing angle	160/160

In/Out Terminals:

Item	Specifications	
Input Signal	VIDEO	HDMI x1 (with HDCP)
	LAN	RJ45 Ethernet port
Output Signal	VIDEO	HDMI x1
	AUDIO	Earphone out
Touch panel	Yes (Capacitive 10 points)	
USB Multi Media Function	Yes	
Local storage	8 GB eMMC with Micro SD card expansion slot	

General:

Item	Specifications
Power requirement	12V 2.0A DC 802.3af compliance PoE, power over Ethernet
Power Consumption (Max)	13 W
Dimensions [W x H x D]	262.2mm x 165.2mm x 24.95mm
Weight	X.XXX Kg

Environmental Condition:

Item	Specifications
Temperature	Operational 0 - 40°C
Humidity	Storage 10 - 85% RH (No condensation)

7.2. Disclaimer

Image Retention Disclaimer

When an image is monitored on-screen for prolonged periods of time, you may see a faint image after it is replaced. This is an expected normal behavior for monitors.

Image retention may be reduced by:

- * Avoiding still images shown on-screen for more than a few minutes
- * Using non-contrasting colors and brightness
- * Using background colors other than gray

Warranty policy for Philips Professional Display Solutions

Thank you for purchasing this Philips product. Philips products are designed and manufactured with high standards and deliver high quality performance, ease of use and ease of installation. If you encounter any difficulties while using your product, we recommend that you first consult the user manual or the information in the support section of the website, where (depending on the product type) you may find a downloadable user manual, frequently asked questions, instruction videos or a support forum.

LIMITED WARRANTY

In the unlikely event the product requires service, we will arrange for your Philips product to be serviced free-of-charge within the warranty period, provided that the product was used in accordance with the user manual (e.g. in the intended environment).

For these product categories, a partner company of Philips is the warrantor of the product. Please check the documentation supplied with your product.

WHO IS COVERED?

Your Warranty coverage begins from the first date of purchase of the product. You need to provide proof of purchase to receive warranty service. A valid sales receipt or other valid document showing that you purchased the product is considered proof of purchase.

WHAT IS COVERED?

If any defect due to faulty materials and/or workmanship occurs within the warranty period, we will make arrangements for a free of charge service. Where a repair is not possible or not commercially viable, we may replace the product with a new or equivalent refurbished product with similar functionality. Replacement will be offered at our discretion and the warranty will continue from the date of original purchase of the first date of purchase of the product. Please note that all parts, including repaired and replaced parts, are covered only for the duration of the original warranty period.

WHAT IS EXCLUDED? Your warranty does not cover:

- Consequential damages (including but not limited to loss of data or loss of income), nor compensation for activities done by yourself, such as regular maintenance, installing firmware updates or saving or restoring data (Some states do not allow the exclusion of incidental or consequential damages, so the above exclusion may not apply to you. This includes, but is not limited to, prerecorded material, whether copyrighted or not copyrighted.)
- Labor charges for installation or setup of the product, adjustment of customer controls on the product, and installation or repair of various types of external devices (e.g., WiFi, antenna, USB dongles, OPS type devices) and other systems outside of the product.
- Reception problems caused by signal conditions or cable or antenna systems outside the unit.
- A product that requires modification or adaptation to enable it to operate in any country other than the country for which it was designed, manufactured, approved and/or authorized, or repair of products damaged by these modifications.
- If the model or production number on the product has been altered, deleted, removed or made illegible.

The warranty applies on condition that the product has been handled properly for its intended use and in accordance with the operating instructions

To Obtain Warranty Service And Information

For detailed warranty coverage information and additional support requirement and help line, please contact the seller and/or system integrator you purchased the product from. Please note in the USA, this limited warranty is only valid for Products purchased in the Continental United States, Alaska, and Hawaii.

Before Requesting Service

Please check your user's manual before requesting service. Adjustments of the controls discussed there may save you a service call.

WARRANTY PERIOD

Warranty period for PHILIPS signage display is listed as below, for areas not covered in this table, please follow their warranty statement.

Standard warranty period for PHILIPS signage display is listed as below, for areas not covered in this table, please follow the local warranty statement.

Region	Standard Warranty Period
USA, Canada	3 years
China	1 year
Japan	3 years
Rest of world	3 years
Mexico	3 years
Brazil	3 years
Chile	3 years
Peru	3 years

Note that for professional products, the specific warranty terms of the sale- or purchase agreement may apply.

Index

A

Advanced features 40
Android Launcher 16
Appendix 40

C

Cleaning 42
Cleaning and Troubleshooting 42

D

Disclaimer 43

I

Input/Output Terminals 12
Installation 8

L

Left View 11

O

Operation 13

P

Package Contents 7
Physical view and features 11

S

Safety Instructions 1
Setting menu 18
Setup wizard 13
Specifications 43

T

Technical Data 43
Troubleshooting 42

U

Unpacking and Installation 7

W

Warranty policy for Philips Professional Display Solutions
44



2024 © TOP Victory Investments Ltd. All rights reserved.

This product has been manufactured by and is sold under the responsibility of Top Victory Investments Ltd., and Top Victory Investments Ltd. is the warrantor in relation to this product. Philips and the Philips Shield Emblem are registered trademarks of Koninklijke Philips N.V. and are used under license.

Specifications are subject to change without notice.

Version: V1.00 2024-03-25