

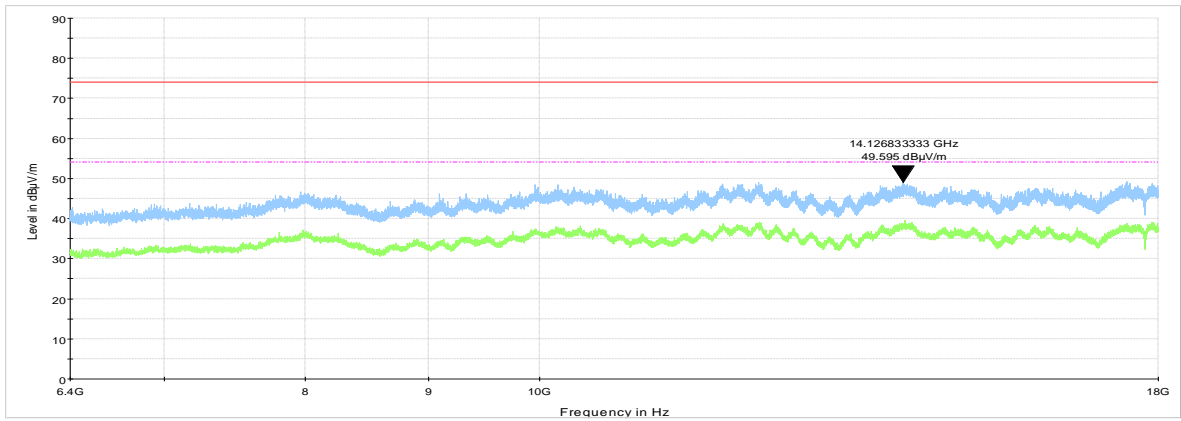

Test specification: FCC section 15.407(b)1, Field strength of undesirable emissions			
Test procedure: KDB 662911; KDB 789033, ANSI C63.10, section 12.7.6 & 12.7.7			
Test mode: Compliance		Verdict: PASS	
Date(s): 07-Feb-19			
Temperature: 25 °C	Relative Humidity: 46 %	Air Pressure: 1012 hPa	Power: 48 VDC
Remarks:			

Plot 7.11.13 Radiated emission measurements from 6.4 to 18 GHz at the low carrier frequency

TEST SITE: Semi Anechoic chamber
TEST DISTANCE: 3 m
ANTENNA POLARIZATION: Vertical and Horizontal



Plot 7.11.14 Radiated emission measurements from 6.4 to 18 GHz at the mid carrier frequency

TEST SITE: Anechoic chamber
TEST DISTANCE: 3 m
ANTENNA POLARIZATION: Vertical and Horizontal

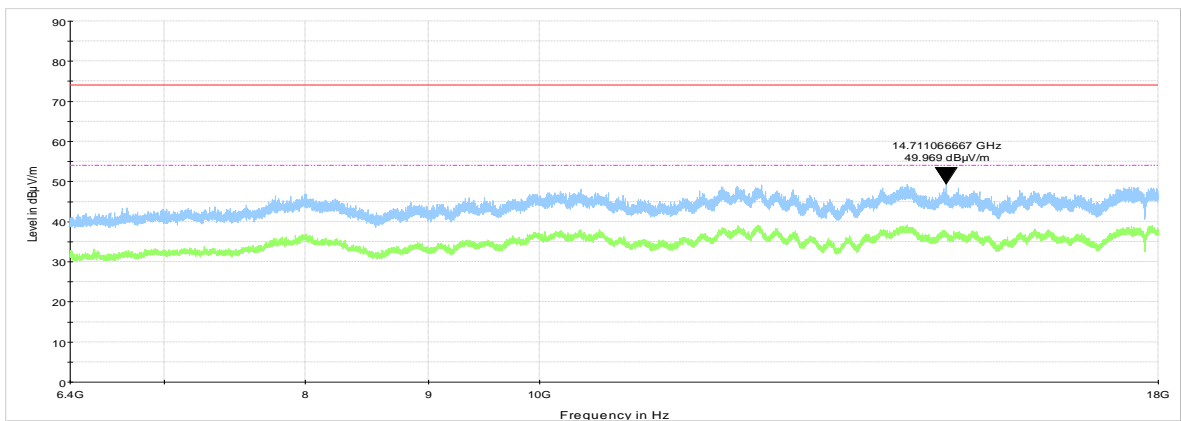



Test specification: FCC section 15.407(b)1, Field strength of undesirable emissions			
Test procedure: KDB 662911; KDB 789033, ANSI C63.10, section 12.7.6 & 12.7.7			
Test mode: Compliance		Verdict: PASS	
Date(s): 07-Feb-19			
Temperature: 25 °C	Relative Humidity: 46 %	Air Pressure: 1012 hPa	Power: 48 VDC
Remarks:			

Plot 7.11.15 Radiated emission measurements from 6.4 to 18 GHz at the high carrier frequency

TEST SITE: Anechoic chamber
TEST DISTANCE: 3 m
ANTENNA POLARIZATION: Vertical and Horizontal

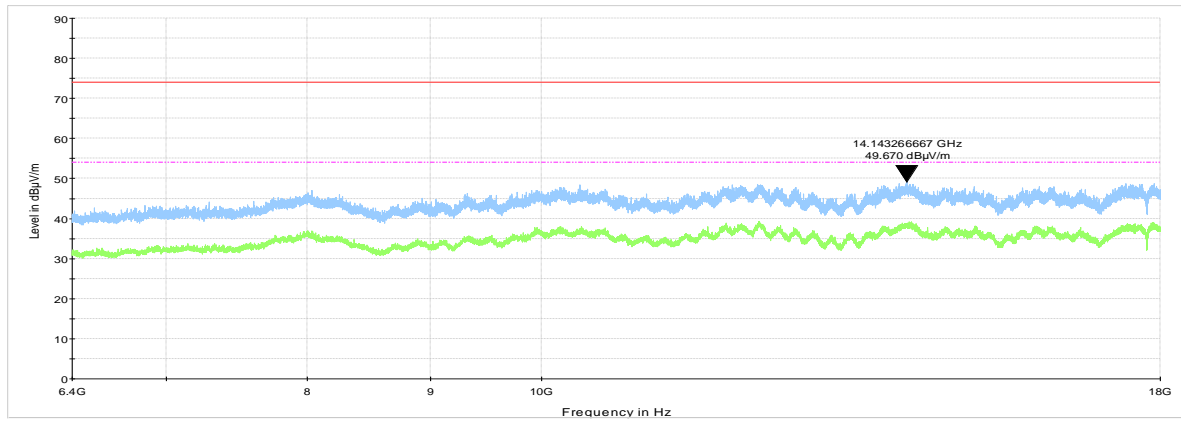



HERMON LABORATORIES

Test specification: FCC section 15.407(b)1, Field strength of undesirable emissions			
Test procedure: KDB 662911; KDB 789033, ANSI C63.10, section 12.7.6 & 12.7.7			
Test mode: Compliance		Verdict: PASS	
Date(s): 07-Feb-19			
Temperature: 25 °C	Relative Humidity: 46 %	Air Pressure: 1012 hPa	Power: 48 VDC
Remarks:			

Plot 7.11.16 Radiated emission measurements from 18 to 40 GHz at the low carrier frequency

TEST SITE: Semi Anechoic chamber
TEST DISTANCE: 3 m
ANTENNA POLARIZATION: Vertical and Horizontal

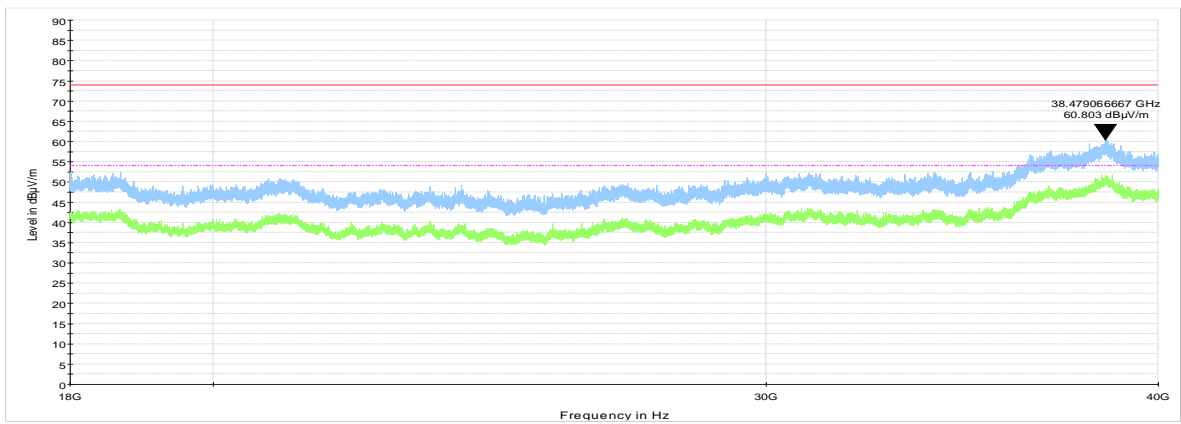

Plot 7.11.17 Radiated emission measurements from 18 to 40 GHz at the mid carrier frequency

TEST SITE: Anechoic chamber
TEST DISTANCE: 3 m
ANTENNA POLARIZATION: Vertical and Horizontal

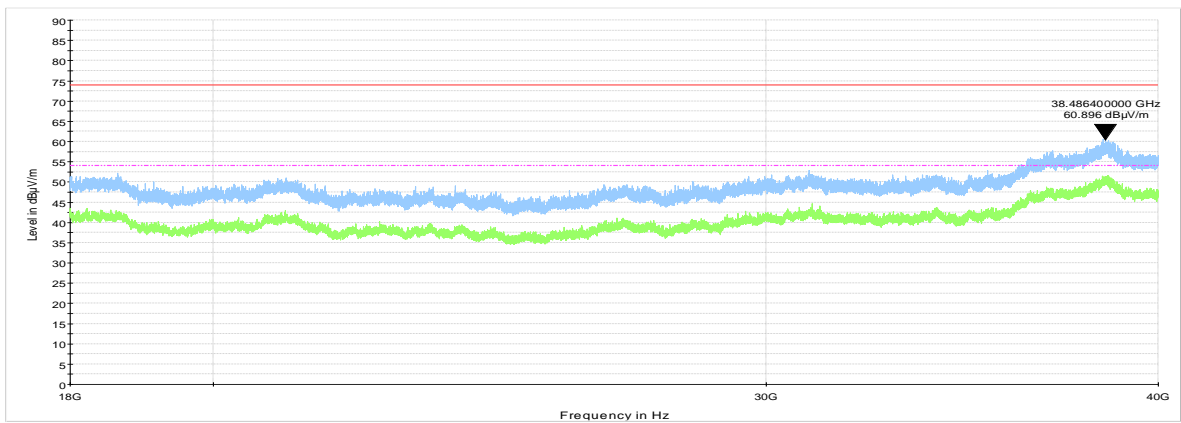



Test specification: FCC section 15.407(b)1, Field strength of undesirable emissions			
Test procedure: KDB 662911; KDB 789033, ANSI C63.10, section 12.7.6 & 12.7.7			
Test mode: Compliance		Verdict: PASS	
Date(s): 07-Feb-19			
Temperature: 25 °C	Relative Humidity: 46 %	Air Pressure: 1012 hPa	Power: 48 VDC
Remarks:			

Plot 7.11.18 Radiated emission measurements from 18 to 40 GHz at the high carrier frequency

TEST SITE: Anechoic chamber
TEST DISTANCE: 3 m
ANTENNA POLARIZATION: Vertical and Horizontal

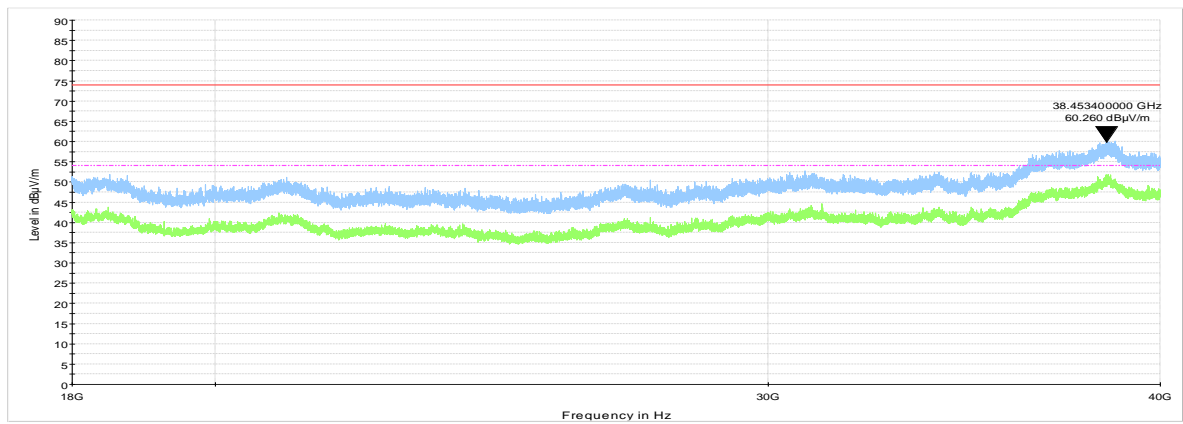



Test specification: FCC section 15.407(b)4, Field strength of undesirable emissions			
Test procedure: KDB 662911; KDB 789033, ANSI C63.10, section 12.7.6 & 12.7.7			
Test mode: Compliance		Verdict: PASS	
Date(s): 07-Feb-19			
Temperature: 25 °C	Relative Humidity: 46 %	Air Pressure: 1012 hPa	Power: 48 VDC
Remarks:			

7.12 Field strength of undesirable emissions at 5725 – 5850 MHz range

7.12.1 General

This test was performed to measure field strength of spurious emissions from the EUT. Specification test limits are given in Table 7.12.1, Table 7.12.2.

Table 7.12.1 Unwanted emissions limits below 1 GHz and within restricted bands above 1 GHz

Frequency, MHz	Field strength at 3 m, dB(µV/m)*		
	Peak	Quasi Peak	Average
0.009 – 0.090	148.5 – 128.5	NA	128.5 – 108.5**
0.090 – 0.110	NA	108.5 – 106.8**	NA
0.110 – 0.490	126.8 – 113.8	NA	106.8 – 93.8**
0.490 – 1.705	NA	73.8 – 63.0**	NA
1.705 – 30.0*		69.5	
30 – 88		40.0	
88 – 216		43.5	
216 – 960		46.0	
960 - 1000		54.0	
1000 – 40000		74.0	

*- The limit for 3 m test distance was calculated using the inverse square distance extrapolation factor as follows:

$$\text{Lims}_2 = \text{Lims}_1 + 40 \log (S_1/S_2),$$

where S_1 and S_2 – standard defined and test distance respectively in meters.

** - The limit decreases linearly with the logarithm of frequency.

Table 7.12.2 EIRP of undesirable emission limits outside restricted bands (above 1 GHz)

Operating frequency band, GHz	EIRP of spurious, dBm/MHz	Field strength at 3 m, dB(µV/m)
5.150 – 5.250	-27	68.23
5.250 – 5.350	-27	68.23
5.470 – 5.725	-27	68.23
5.725 – 5.850	-27 (below 5.650 GHz and above 5.925 GHz)	68.23
	-27 increasing linearly to 10 (in 5.650 - 5.700 GHz and 5.875 - 5.925 GHz)	68.23 - 105.23*
	10 increasing linearly to 15.6 (in 5.700 - 5.720 GHz and 5.855 - 5.875 GHz)	105.23 - 110.83*
	15.6 increasing linearly to 27 (in 5.720 - 5.725 GHz and 5.850 - 5.855 GHz)	110.83 - 122.23*



Test specification: FCC section 15.407(b)4, Field strength of undesirable emissions			
Test procedure: KDB 662911; KDB 789033, ANSI C63.10, section 12.7.6 & 12.7.7			
Test mode: Compliance		Verdict: PASS	
Date(s): 07-Feb-19			
Temperature: 25 °C	Relative Humidity: 46 %	Air Pressure: 1012 hPa	Power: 48 VDC
Remarks:			

Test procedure for spurious emission field strength measurements in 9 kHz to 30 MHz band

7.12.1.1 The EUT was set up as shown in Figure 7.12.1, energized and the performance check was conducted.

7.12.1.2 The specified frequency range was investigated with antenna connected to spectrum analyzer/ EMI receiver. To find maximum radiation the turntable was rotated 360° and the measuring antenna was rotated around its vertical axis.

7.12.1.3 The worst test results (the lowest margins) were recorded and shown in the associated plots.

Test procedure for spurious emission field strength measurements above 30 MHz

7.12.1.4 The EUT was set up as shown in Figure 7.12.2, Figure 7.12.3, energized and the performance check was conducted.

7.12.1.5 The specified frequency range was investigated with antenna connected to spectrum analyzer/ EMI receiver. To find maximum radiation the turntable was rotated 360°, the measuring antenna height was changed from 1 to 4 m, its polarization was switched from vertical to horizontal.

7.12.1.6 The worst test results (the lowest margins) were recorded and shown in the associated plots.

Figure 7.12.1 Setup for spurious emission field strength measurements below 30 MHz

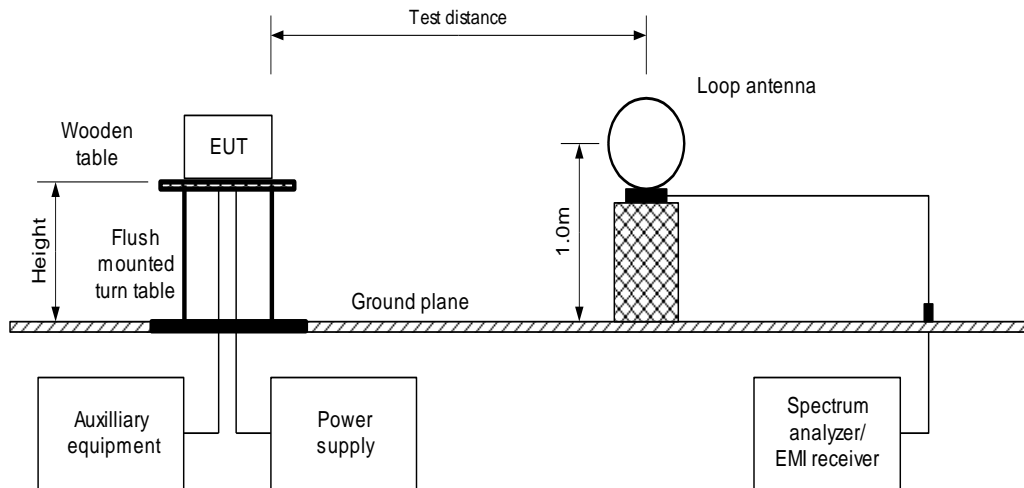



Test specification: FCC section 15.407(b)4, Field strength of undesirable emissions			
Test procedure: KDB 662911; KDB 789033, ANSI C63.10, section 12.7.6 & 12.7.7			
Test mode: Compliance		Verdict: PASS	
Date(s): 07-Feb-19			
Temperature: 25 °C	Relative Humidity: 46 %	Air Pressure: 1012 hPa	Power: 48 VDC
Remarks:			

Figure 7.12.2 Setup for spurious emission field strength measurements from 30 to 1000 MHz

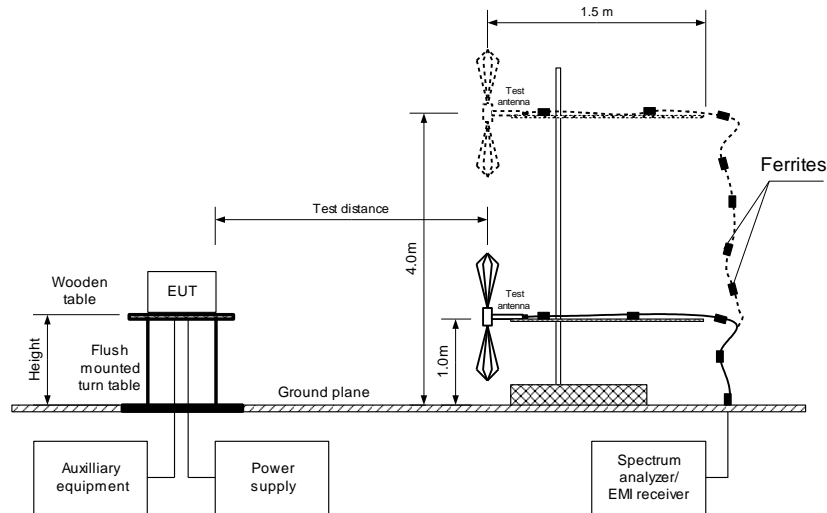
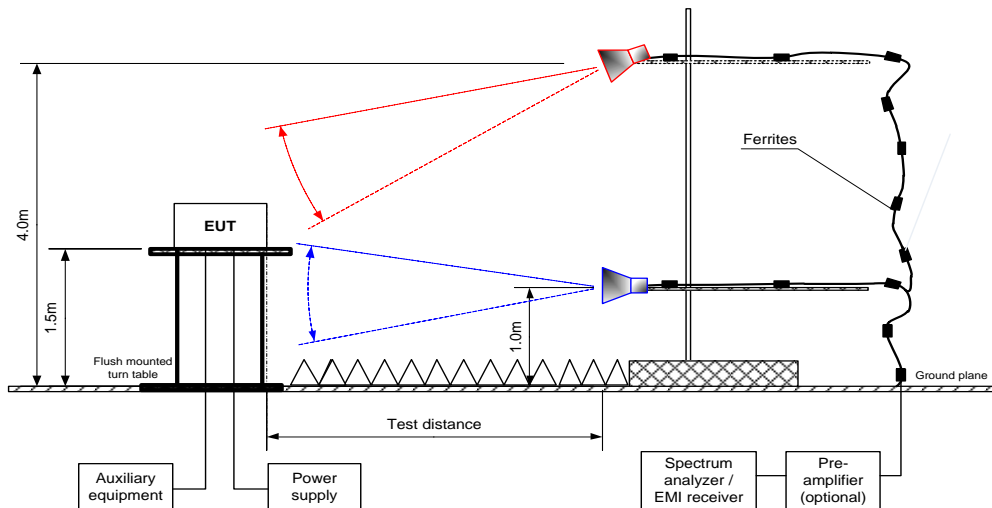

Figure 7.12.3 Setup for spurious emission field strength measurements above 1000 MHz





Test specification: FCC section 15.407(b)4, Field strength of undesirable emissions			
Test procedure: KDB 662911; KDB 789033, ANSI C63.10, section 12.7.6 & 12.7.7			
Test mode: Compliance		Verdict: PASS	
Date(s): 07-Feb-19			
Temperature: 25 °C	Relative Humidity: 46 %	Air Pressure: 1012 hPa	Power: 48 VDC
Remarks:			

Table 7.12.3 Field strength of spurious emissions below 1 GHz

ASSIGNED FREQUENCY BAND: 5.725 – 5.850 GHz
 INVESTIGATED FREQUENCY RANGE: 0.009 – 1000 MHz
 TEST DISTANCE: 3 m
 CHANNEL SPACING: 10MHz
 MODULATION: QPSK
 TRANSMITTER OUTPUT POWER: Maximum
 RESOLUTION BANDWIDTH: 1 kHz (9 kHz – 150 kHz)
 9.0 kHz (150 kHz – 30 MHz)
 120 kHz (30 MHz – 1000 MHz)
 VIDEO BANDWIDTH: > Resolution bandwidth
 TEST ANTENNA TYPE: Active loop (9 kHz – 30 MHz)
 Biconilog (30 MHz – 1000 MHz)

Frequency, MHz	Peak emission, dB(µV/m)	Quasi-peak			Antenna polarization	Antenna height, m	Turn-table position**, degrees	Verdict
		Measured emission, dB(µV/m)	Limit, dB(µV/m)	Margin, dB*				
Low, mid, high carrier frequency								
67.176	27.21	24.02	40.0	-15.98	Vertical	184	-8	Pass
94.499	28.56	23.81	43.5	-19.69	Vertical	100	-157	
129.058	37.29	32.09	43.5	-11.41	Vertical	104	-8	
139.324	39.70	34.28	43.5	-9.22	Vertical	178	-180	
245.751	44.77	41.60	46.0	-4.40	Vertical	102	165	
301.725	44.86	38.39	46.0	-7.61	Horizontal	102	-180	
374.990	41.26	38.67	46.0	-7.33	Horizontal	102	-173	
875.014	42.93	39.11	46.0	-6.89	Vertical	132	-145	

*- Margin = Measured emission - specification limit.
 **- EUT front panel refer to 0 degrees position of turntable.

Table 7.12.4 Field strength of emissions above 1 GHz outside restricted bands

ASSIGNED FREQUENCY BAND: 5.725 – 5.850 GHz
 INVESTIGATED FREQUENCY RANGE: 1000 – 40000 MHz
 TEST DISTANCE: 3 m
 MODULATION: QPSK
 TRANSMITTER OUTPUT POWER: Maximum
 DETECTOR: USED: Peak
 RESOLUTION BANDWIDTH: 1000 kHz
 TEST ANTENNA TYPE: Biconilog (30 MHz – 1000 MHz)
 Double ridged guide (above 1000 MHz)

Frequency, MHz	Antenna polarization	Antenna height, m	Azimuth, degrees*	Field strength of spurious, dB(µV/m)	Limit, dBµV/m	Margin, dB**	Verdict
Low, mid, high carrier frequency							
All emissions are more than 20 dB below the limit							Pass

*- EUT front panel refers to 0 degrees position of turntable.
 **- Margin = Measured emission - specification limit.



Test specification: FCC section 15.407(b)4, Field strength of undesirable emissions			
Test procedure: KDB 662911; KDB 789033, ANSI C63.10, section 12.7.6 & 12.7.7			
Test mode: Compliance		Verdict: PASS	
Date(s): 07-Feb-19			
Temperature: 25 °C	Relative Humidity: 46 %	Air Pressure: 1012 hPa	Power: 48 VDC
Remarks:			

Table 7.12.5 Field strength of spurious emissions above 1 GHz within restricted bands

ASSIGNED FREQUENCY: 5.725 – 5.850 GHz
 INVESTIGATED FREQUENCY RANGE: 1000 - 40000 MHz
 TEST DISTANCE: 3 m
 MODULATION: QPSK
 DUTY CYCLE: 100 %
 TRANSMITTER OUTPUT POWER: Maximum
 DETECTOR USED: Peak
 RESOLUTION BANDWIDTH: 1000 kHz
 TEST ANTENNA TYPE: Double ridged guide

Frequency, MHz	Antenna		Azimuth, degrees*	Peak field strength(VBW=3 MHz)			Average field strength(VBW=1 kHz)				Verdict
	Polarization	Height, m		Measured, dB(µV/m)	Limit, dB(µV/m)	Margin, dB**	Measured, dB(µV/m)	Calculated, dB(µV/m)	Limit, dB(µV/m)	Margin, dB***	
Low, mid, high carrier frequency											Pass
All emissions are more than 20 dB below the limit											

*- EUT front panel refers to 0 degrees position of turntable.
 ** - Margin, dB = Measured, dB(µV/m) – Limit, dB(µV/m)
 *** - Margin, dB = Calculated, dB(µV/m) – Limit, dB(µV/m)

Reference numbers of test equipment used

HL 0446	HL 0604	HL 3903	HL 4355	HL 4360	HL 4933	HL 4956	HL 5405
---------	---------	---------	---------	---------	---------	---------	---------

Full description is given in Appendix A.

Table 7.12.6 Restricted bands according to FCC section 15.205

MHz	MHz	MHz	MHz	MHz	GHz
0.09 - 0.11	8.37625 - 8.38675	73 - 74.6	399.9 - 410	2690 - 2900	10.6 - 12.7
0.495 - 0.505	8.41425 - 8.41475	74.8 - 75.2	608 - 614	3260 - 3267	13.25 - 13.4
2.1735 - 2.1905	12.29 - 12.293	108 - 121.94	960 - 1240	3332 - 3339	14.47 - 14.5
4.125 - 4.128	12.51975 - 12.52025	123 - 138	1300 - 1427	3345.8 - 3358	15.35 - 16.2
4.17725 - 4.17775	12.57675 - 12.57725	149.9 - 150.05	1435 - 1626.5	3600 - 4400	17.7 - 21.4
4.20725 - 4.20775	13.36 - 13.41	156.52475 - 156.52525	1645.5 - 1646.5	4500 - 5150	22.01 - 23.12
6.215 - 6.218	16.42 - 16.423	156.7 - 156.9	1660 - 1710	5350 - 5460	23.6 - 24
6.26775 - 6.26825	16.69475 - 16.69525	162.0125 - 167.17	1718.8 - 1722.2	7250 - 7750	31.2 - 31.8
6.31175 - 6.31225	16.80425 - 16.80475	167.72 - 173.2	2200 - 2300	8025 - 8500	36.43 - 36.5
8.291 - 8.294	25.5 - 25.67	240 - 285	2310 - 2390	9000 - 9200	Above 38.6
8.362 - 8.366	37.5 - 38.25	322 - 335.4	2483.5 - 2500	9300 - 9500	

Table 7.12.7 Restricted bands according to RSS-Gen

MHz	MHz	MHz	MHz	MHz	GHz
0.09 - 0.11	8.291 - 8.294	16.80425 - 16.80475	399.9 - 410	3260 - 3267	10.6 - 12.7
2.1735 - 2.1905	8.362 - 8.366	25.5 - 25.67	608 - 614	3332 - 3339	13.25 - 13.4
3.020 - 3.026	8.37625 - 8.38675	37.5 - 38.25	960 - 1427	3345.8 - 3358	14.47 - 14.5
4.125 - 4.128	8.41425 - 8.41475	73 - 74.6	1435 - 1626.5	3500 - 4400	15.35 - 16.2
4.17725 - 4.17775	12.29 - 12.293	74.8 - 75.2	1645.5 - 1646.5	4500 - 5150	17.7 - 21.4
4.20725 - 4.20775	12.51975 - 12.52025	108 - 138	1660 - 1710	5350 - 5460	22.01 - 23.12
5.677 - 5.683	12.57675 - 12.57725	156.52475 - 156.52525	1718.8 - 1722.2	7250 - 7750	23.6 - 24
6.215 - 6.218	13.36 - 13.41	156.7 - 156.9	2200 - 2300	8025 - 8500	31.2 - 31.8
6.26775 - 6.26825	16.42 - 16.423	240 - 285	2310 - 2390	9000 - 9200	36.43 - 36.5
6.31175 - 6.31225	16.69475 - 16.69525	322 - 335.4	2655 - 2900	9300 - 9500	Above 38.6



Test specification: FCC section 15.407(b)4, Field strength of undesirable emissions			
Test procedure: KDB 662911; KDB 789033, ANSI C63.10, section 12.7.6 & 12.7.7			
Test mode: Compliance		Verdict: PASS	
Date(s): 07-Feb-19			
Temperature: 25 °C	Relative Humidity: 46 %	Air Pressure: 1012 hPa	Power: 48 VDC
Remarks:			

Plot 7.12.1 Radiated emission measurements from 9 kHz to 30 MHz at the low carrier frequency

TEST SITE: Semi anechoic chamber
TEST DISTANCE: 3 m
ANTENNA POLARIZATION: Vertical and Horizontal

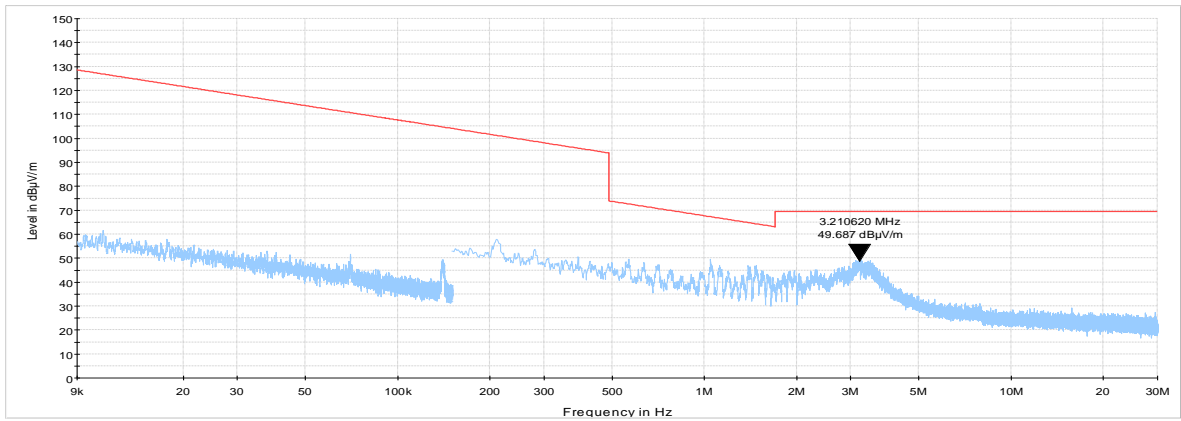

Plot 7.12.2 Radiated emission measurements from 9 kHz to 30 MHz at the mid carrier frequency

TEST SITE: Semi anechoic chamber
TEST DISTANCE: 3 m
ANTENNA POLARIZATION: Vertical and Horizontal

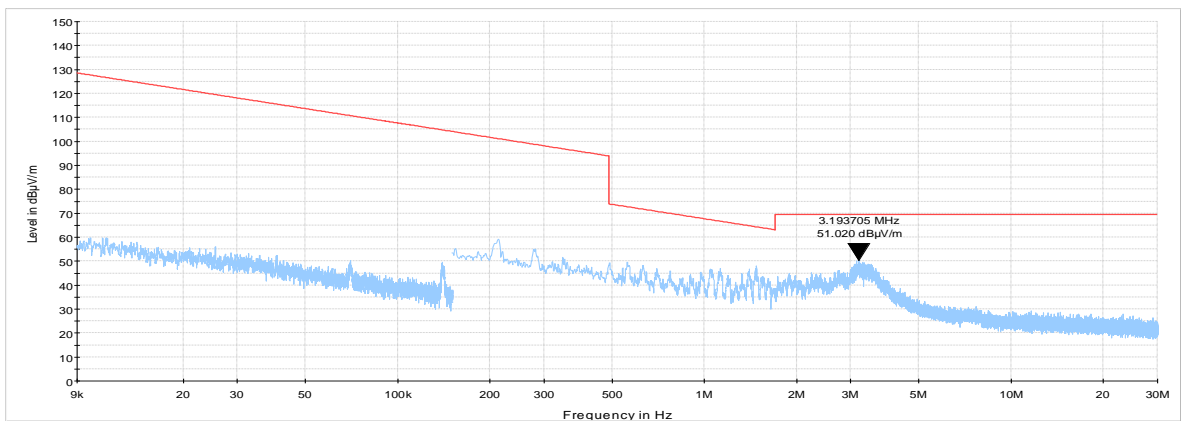



HERMON LABORATORIES

Test specification: FCC section 15.407(b)4, Field strength of undesirable emissions			
Test procedure: KDB 662911; KDB 789033, ANSI C63.10, section 12.7.6 & 12.7.7			
Test mode: Compliance		Verdict: PASS	
Date(s): 07-Feb-19			
Temperature: 25 °C	Relative Humidity: 46 %	Air Pressure: 1012 hPa	Power: 48 VDC
Remarks:			

Plot 7.12.3 Radiated emission measurements from 9 kHz to 30 MHz at the high carrier frequency

TEST SITE: Semi anechoic chamber
TEST DISTANCE: 3 m
ANTENNA POLARIZATION: Vertical and Horizontal

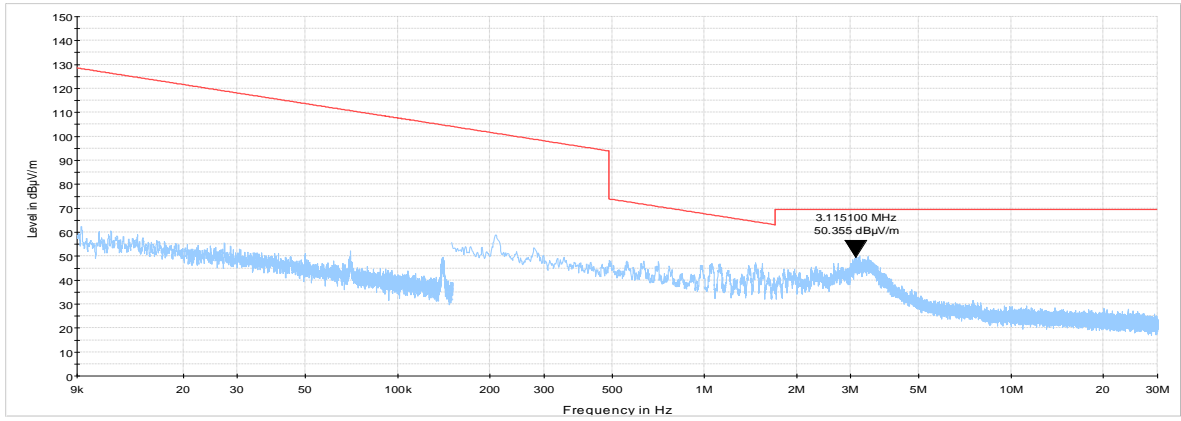



Test specification: FCC section 15.407(b)4, Field strength of undesirable emissions			
Test procedure: KDB 662911; KDB 789033, ANSI C63.10, section 12.7.6 & 12.7.7			
Test mode: Compliance		Verdict: PASS	
Date(s): 07-Feb-19			
Temperature: 25 °C	Relative Humidity: 46 %	Air Pressure: 1012 hPa	Power: 48 VDC
Remarks:			

Plot 7.12.4 Radiated emission measurements from 30 MHz to 1000 MHz at the low carrier frequency

TEST SITE: Semi Anechoic chamber
TEST DISTANCE: 3 m
ANTENNA POLARIZATION: Vertical and Horizontal

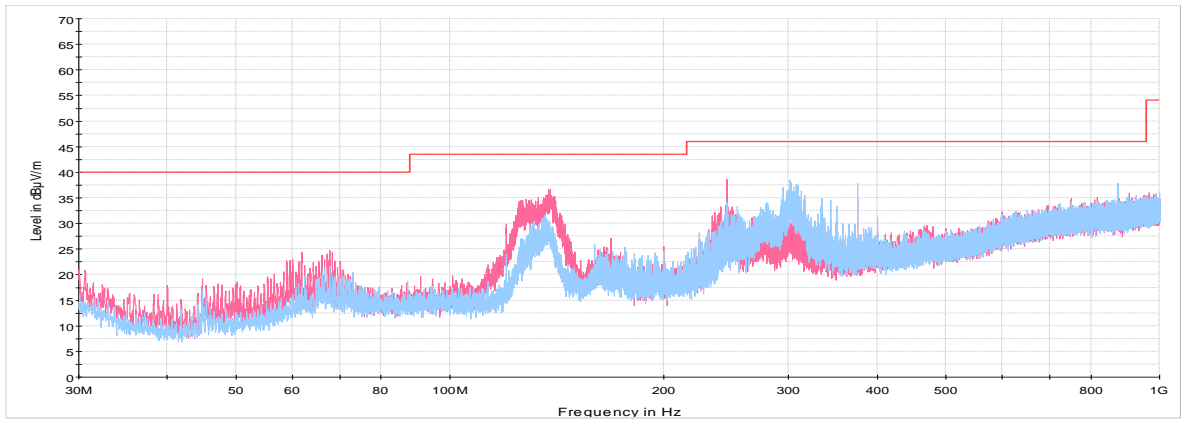

Plot 7.12.5 Radiated emission measurements from 30 MHz to 1000 MHz at the mid carrier frequency

TEST SITE: Semi Anechoic chamber
TEST DISTANCE: 3 m
ANTENNA POLARIZATION: Vertical and Horizontal

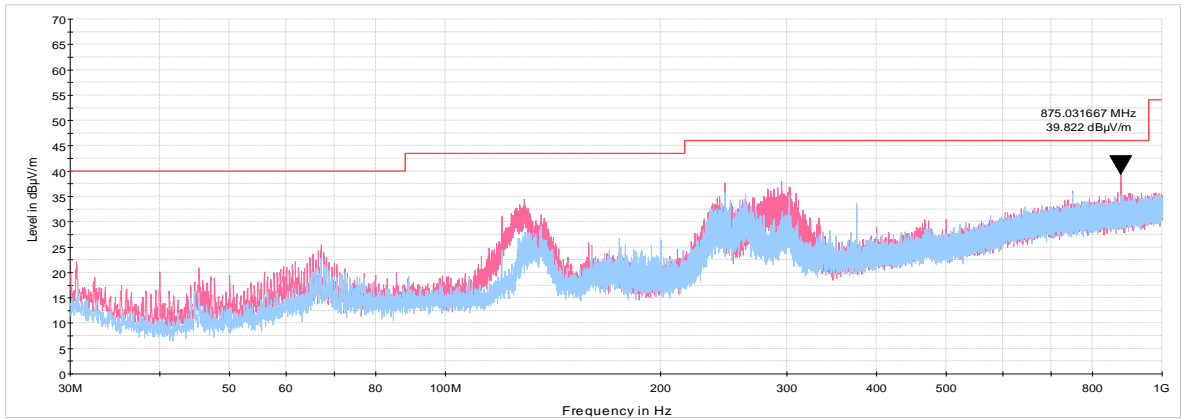



Test specification: FCC section 15.407(b)4, Field strength of undesirable emissions			
Test procedure: KDB 662911; KDB 789033, ANSI C63.10, section 12.7.6 & 12.7.7			
Test mode: Compliance		Verdict: PASS	
Date(s): 07-Feb-19			
Temperature: 25 °C	Relative Humidity: 46 %	Air Pressure: 1012 hPa	Power: 48 VDC
Remarks:			

Plot 7.12.6 Radiated emission measurements from 30 MHz to 1000 MHz at the high carrier frequency

TEST SITE: Semi Anechoic chamber
TEST DISTANCE: 3 m
ANTENNA POLARIZATION: Vertical and Horizontal

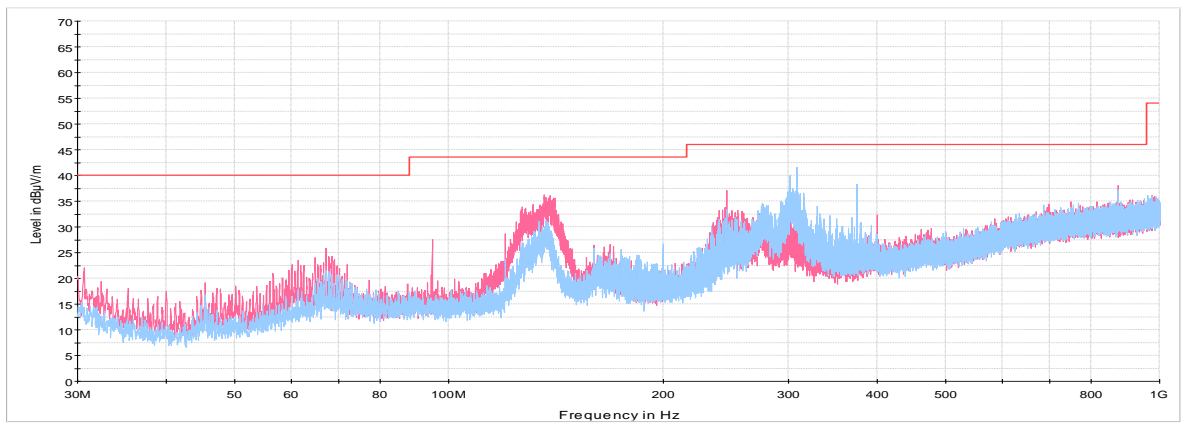



Test specification: FCC section 15.407(b)4, Field strength of undesirable emissions			
Test procedure: KDB 662911; KDB 789033, ANSI C63.10, section 12.7.6 & 12.7.7			
Test mode: Compliance		Verdict: PASS	
Date(s): 07-Feb-19			
Temperature: 25 °C	Relative Humidity: 46 %	Air Pressure: 1012 hPa	Power: 48 VDC
Remarks:			

Plot 7.12.7 Radiated emission measurements from 1.0 to 4.5 GHz at the low carrier frequency

TEST SITE: Semi Anechoic chamber
TEST DISTANCE: 3 m
ANTENNA POLARIZATION: Vertical and Horizontal

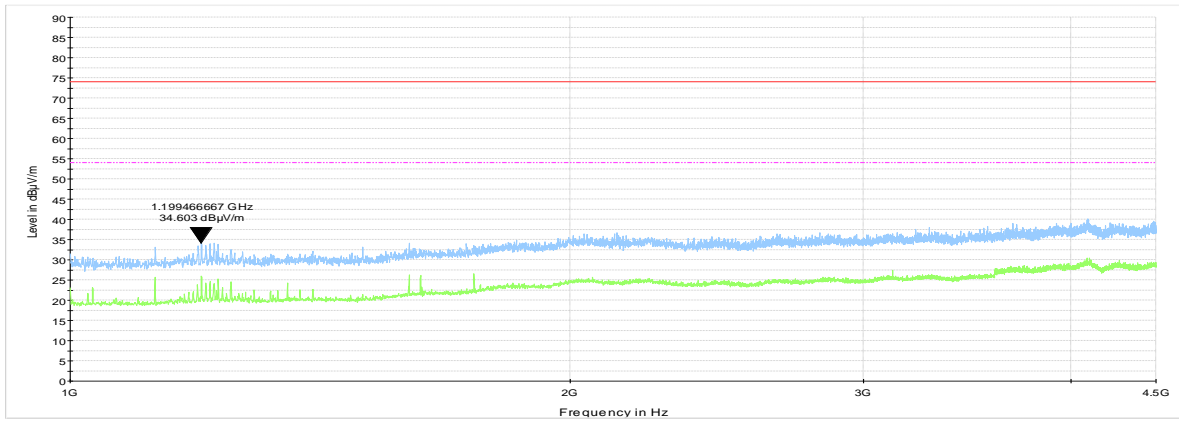

Plot 7.12.8 Radiated emission measurements from 1.0 to 4.5 GHz at the mid carrier frequency

TEST SITE: Anechoic chamber
TEST DISTANCE: 3 m
ANTENNA POLARIZATION: Vertical and Horizontal

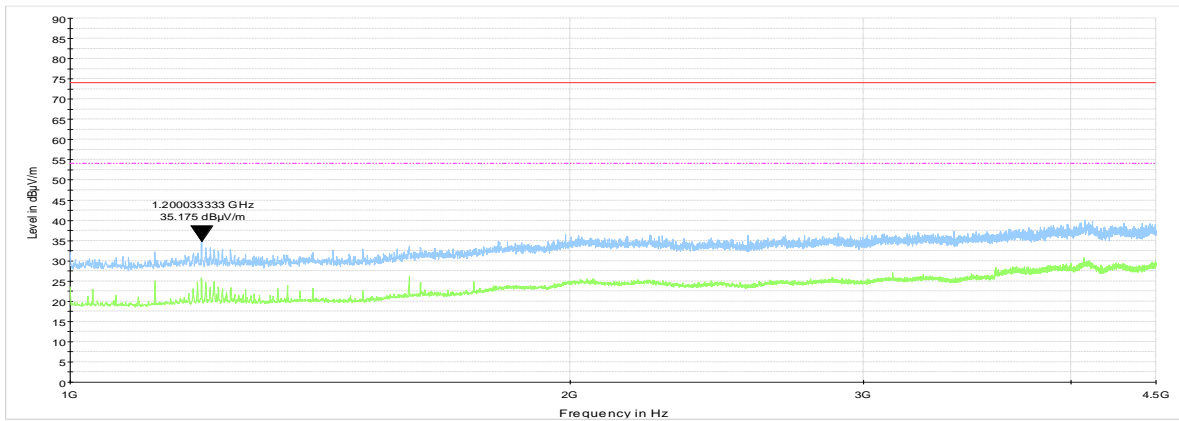



HERMON LABORATORIES

Test specification: FCC section 15.407(b)4, Field strength of undesirable emissions			
Test procedure: KDB 662911; KDB 789033, ANSI C63.10, section 12.7.6 & 12.7.7			
Test mode: Compliance		Verdict: PASS	
Date(s): 07-Feb-19			
Temperature: 25 °C	Relative Humidity: 46 %	Air Pressure: 1012 hPa	Power: 48 VDC
Remarks:			

Plot 7.12.9 Radiated emission measurements from 1.0 to 4.5 GHz at the high carrier frequency

TEST SITE: Anechoic chamber
TEST DISTANCE: 3 m
ANTENNA POLARIZATION: Vertical and Horizontal

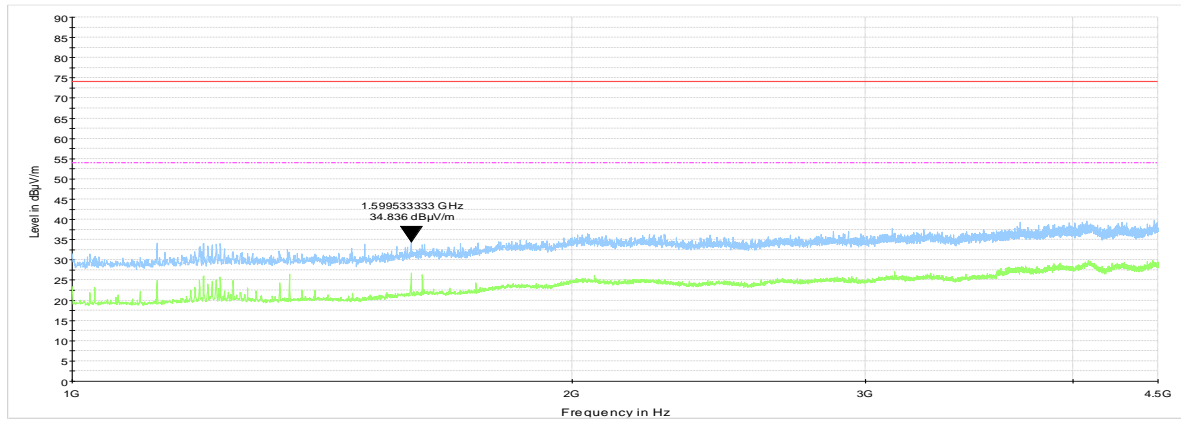



HERMON LABORATORIES

Test specification: FCC section 15.407(b)4, Field strength of undesirable emissions			
Test procedure: KDB 662911; KDB 789033, ANSI C63.10, section 12.7.6 & 12.7.7			
Test mode: Compliance		Verdict: PASS	
Date(s): 07-Feb-19			
Temperature: 25 °C	Relative Humidity: 46 %	Air Pressure: 1012 hPa	Power: 48 VDC
Remarks:			

Plot 7.12.10 Radiated emission measurements from 4.5 to 6.4 GHz at the low carrier frequency with TX output ports terminated

TEST SITE: Semi Anechoic chamber
TEST DISTANCE: 3 m
ANTENNA POLARIZATION: Vertical and Horizontal

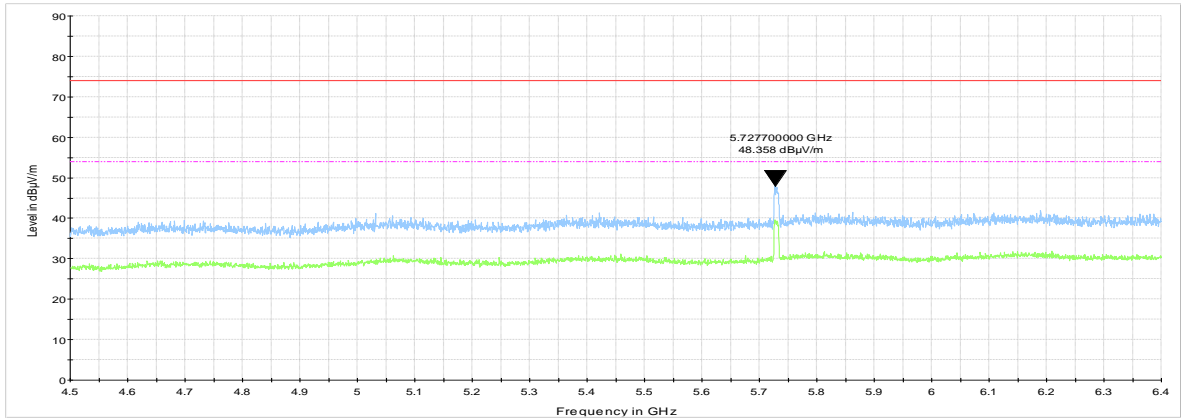

Plot 7.12.11 Radiated emission measurements from 4.5 to 6.4 GHz at the mid carrier frequency with TX output ports terminated

TEST SITE: Anechoic chamber
TEST DISTANCE: 3 m
ANTENNA POLARIZATION: Vertical and Horizontal

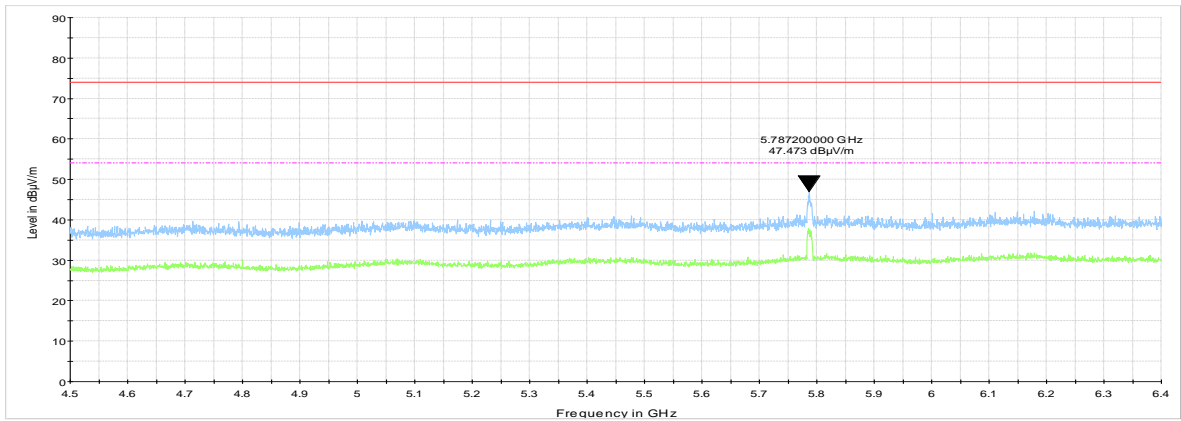



HERMON LABORATORIES

Test specification: FCC section 15.407(b)4, Field strength of undesirable emissions			
Test procedure: KDB 662911; KDB 789033, ANSI C63.10, section 12.7.6 & 12.7.7			
Test mode: Compliance		Verdict: PASS	
Date(s): 07-Feb-19			
Temperature: 25 °C	Relative Humidity: 46 %	Air Pressure: 1012 hPa	Power: 48 VDC
Remarks:			

Plot 7.12.12 Radiated emission measurements from 4.5 to 6.4 GHz at the high carrier frequency with TX output ports terminated

TEST SITE: Anechoic chamber
TEST DISTANCE: 3 m
ANTENNA POLARIZATION: Vertical and Horizontal

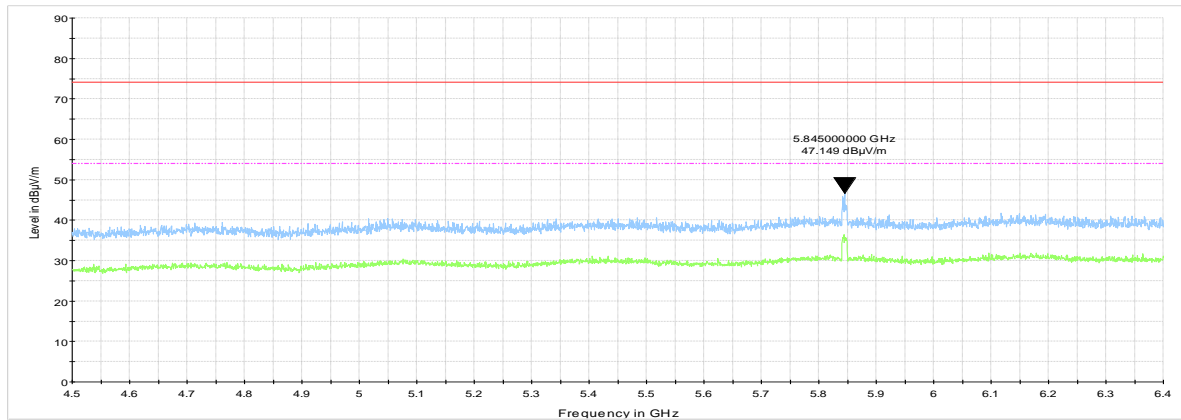



Test specification: FCC section 15.407(b)4, Field strength of undesirable emissions			
Test procedure: KDB 662911; KDB 789033, ANSI C63.10, section 12.7.6 & 12.7.7			
Test mode: Compliance		Verdict: PASS	
Date(s): 07-Feb-19			
Temperature: 25 °C	Relative Humidity: 46 %	Air Pressure: 1012 hPa	Power: 48 VDC
Remarks:			

Plot 7.12.13 Radiated emission measurements from 6.4 to 18 GHz at the low carrier frequency

TEST SITE: Semi Anechoic chamber
TEST DISTANCE: 3 m
ANTENNA POLARIZATION: Vertical and Horizontal

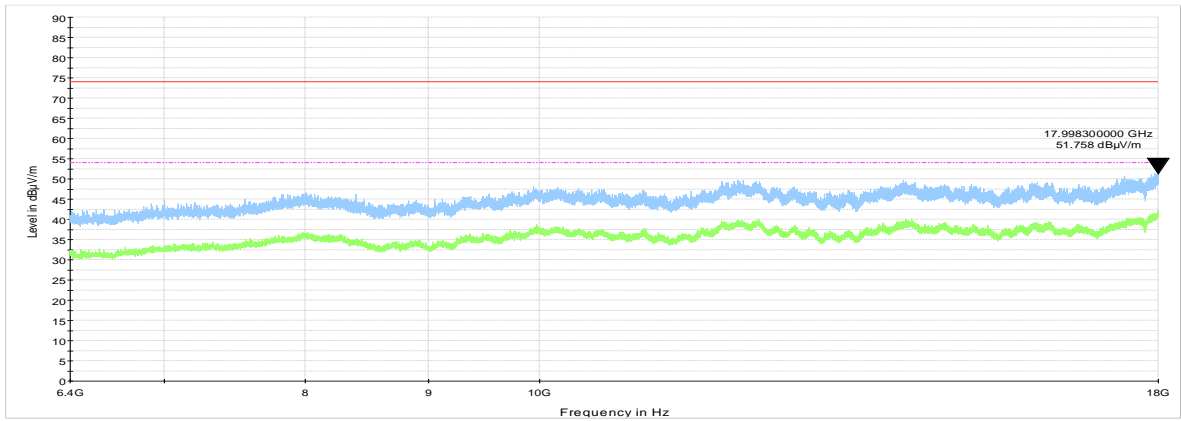

Plot 7.12.14 Radiated emission measurements from 6.4 to 18 GHz at the mid carrier frequency

TEST SITE: Anechoic chamber
TEST DISTANCE: 3 m
ANTENNA POLARIZATION: Vertical and Horizontal

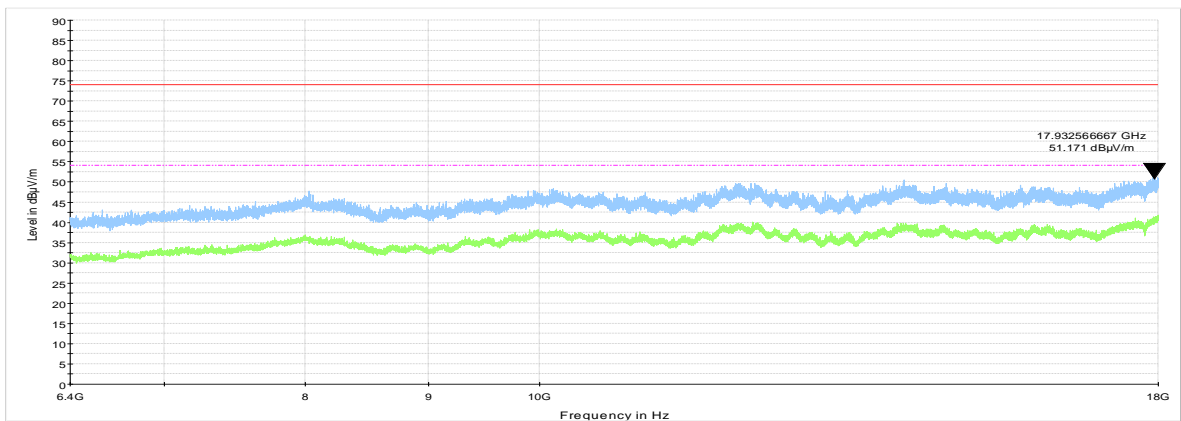



HERMON LABORATORIES

Test specification: FCC section 15.407(b)4, Field strength of undesirable emissions			
Test procedure: KDB 662911; KDB 789033, ANSI C63.10, section 12.7.6 & 12.7.7			
Test mode: Compliance		Verdict: PASS	
Date(s): 07-Feb-19			
Temperature: 25 °C	Relative Humidity: 46 %	Air Pressure: 1012 hPa	Power: 48 VDC
Remarks:			

Plot 7.12.15 Radiated emission measurements from 6.4 to 18 GHz at the high carrier frequency

TEST SITE: Anechoic chamber
TEST DISTANCE: 3 m
ANTENNA POLARIZATION: Vertical and Horizontal

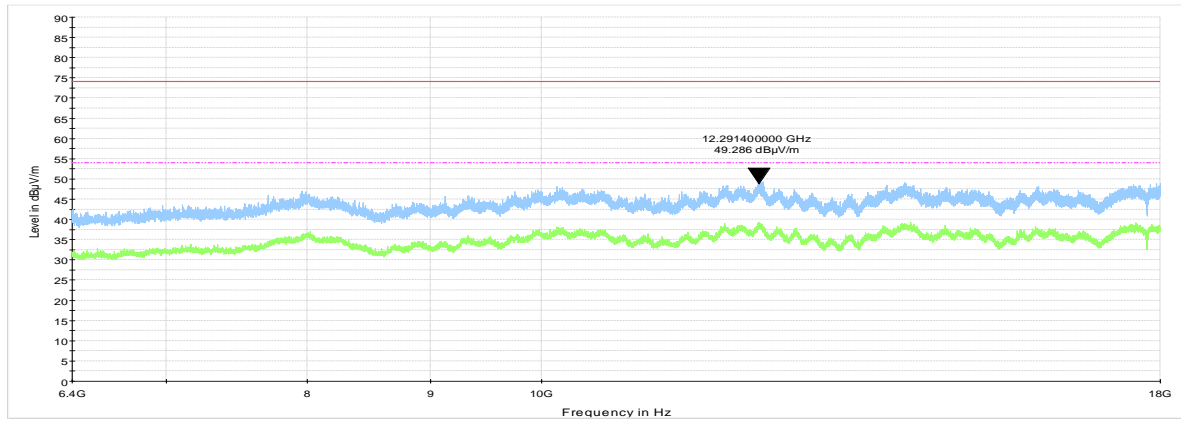



HERMON LABORATORIES

Test specification: FCC section 15.407(b)4, Field strength of undesirable emissions			
Test procedure: KDB 662911; KDB 789033, ANSI C63.10, section 12.7.6 & 12.7.7			
Test mode: Compliance		Verdict: PASS	
Date(s): 07-Feb-19			
Temperature: 25 °C	Relative Humidity: 46 %	Air Pressure: 1012 hPa	Power: 48 VDC
Remarks:			

Plot 7.12.16 Radiated emission measurements from 18 to 40 GHz at the low carrier frequency

TEST SITE: Semi Anechoic chamber
TEST DISTANCE: 3 m
ANTENNA POLARIZATION: Vertical and Horizontal

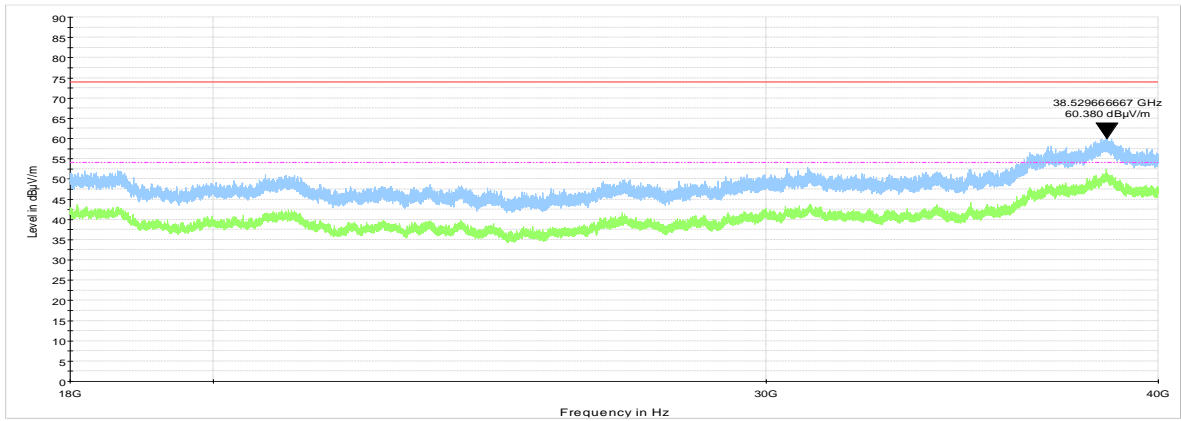

Plot 7.12.17 Radiated emission measurements from 18 to 40 GHz at the mid carrier frequency

TEST SITE: Anechoic chamber
TEST DISTANCE: 3 m
ANTENNA POLARIZATION: Vertical and Horizontal

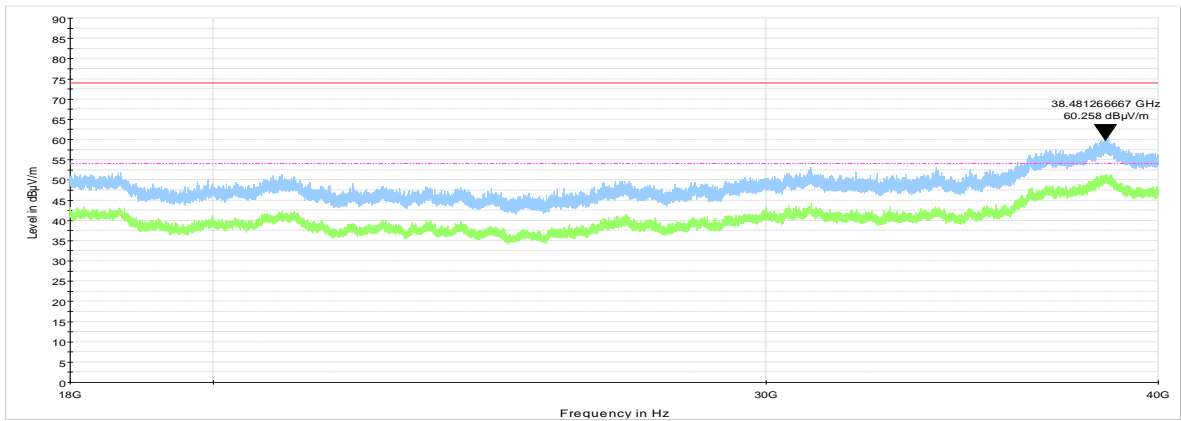



HERMON LABORATORIES

Report ID: TelRad_FCC_31832_rev4
Date of Issue: 18-Sep-19

Test specification: FCC section 15.407(b)4, Field strength of undesirable emissions			
Test procedure: KDB 662911; KDB 789033, ANSI C63.10, section 12.7.6 & 12.7.7			
Test mode: Compliance		Verdict: PASS	
Date(s): 07-Feb-19			
Temperature: 25 °C	Relative Humidity: 46 %	Air Pressure: 1012 hPa	Power: 48 VDC
Remarks:			

Plot 7.12.18 Radiated emission measurements from 18 to 40 GHz at the high carrier frequency

TEST SITE: Anechoic chamber
TEST DISTANCE: 3 m
ANTENNA POLARIZATION: Vertical and Horizontal

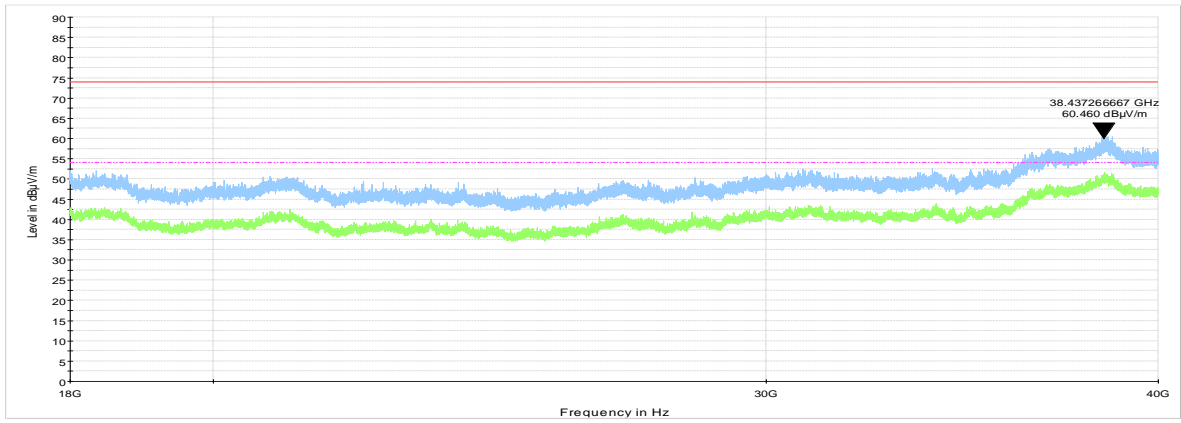



Test specification: FCC section 15.407(b)(6), 15.207(a), Conducted emissions			
Test procedure: ANSI C63.10, Section 12.7.4.1, KDB 789033			
Test mode: Compliance		Verdict: PASS	
Date(s): 21-Jan-19			
Temperature: 26 °C	Relative Humidity: 48 %	Air Pressure: 1018 hPa	Power: 48 VDC
Remarks:			

7.13 Conducted emissions at 5150 – 5250 MHz range

7.13.1 General

This test was performed to measure common mode conducted emissions at the power port. Specification test limits are given in Table 7.13.1.

Table 7.13.1 Limits for conducted emissions according to FCC Part 15, Section 207 / RSS-Gen, Section 7.2

Frequency, MHz	Class B limit, dB(μV)	
	QP	AVRG
0.15 - 0.5	66 - 56*	56 - 46*
0.5 - 5.0	56	46
5.0 - 30	60	50

* - The limit decreases linearly with the logarithm of frequency.

7.13.2 Test procedure

7.13.2.1 The EUT was set up as shown in Figure 7.13.1, energized and the performance check was conducted.

7.13.2.2 The measurements were performed at power terminals with the LISN, connected to a spectrum analyzer while unused coaxial connector of the LISN was terminated with 50 Ohm.

7.13.2.3 The position of the device cables was varied to determine maximum emission level.

7.13.2.4 The worst test results (the lowest margins) were recorded in Table 7.13.2 and shown in the associated plots.

Figure 7.13.1 Setup for conducted emission measurements, table-top equipment

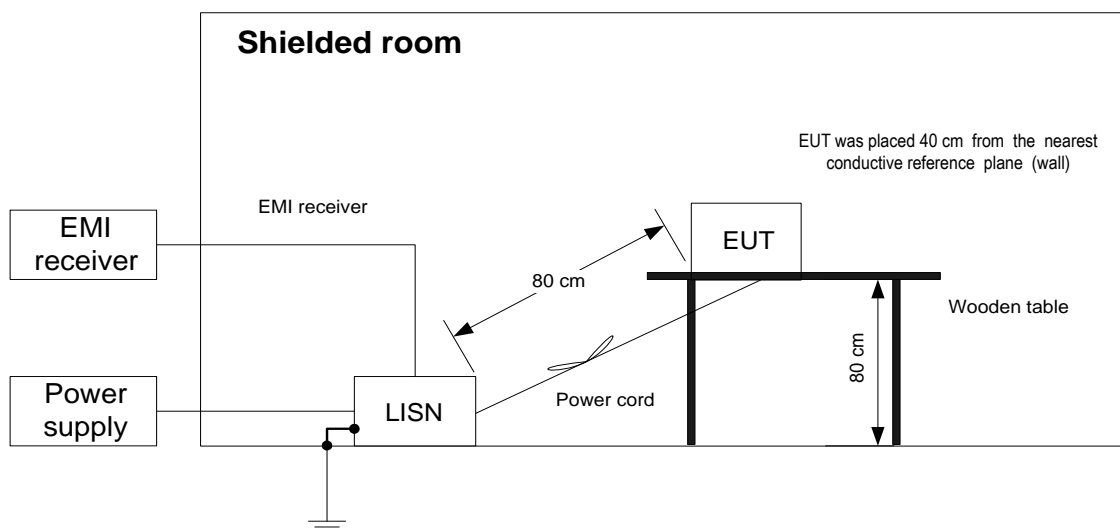



Test specification: FCC section 15.407(b)(6), 15.207(a), Conducted emissions			
Test procedure: ANSI C63.10, Section 12.7.4.1, KDB 789033			
Test mode: Compliance		Verdict: PASS	
Date(s): 21-Jan-19			
Temperature: 26 °C	Relative Humidity: 48 %	Air Pressure: 1018 hPa	Power: 48 VDC
Remarks:			

Table 7.13.2 Conducted emission test results according to FCC Part 15, Section 207 / RSS-Gen, Section 7.2

LINE: AC mains
 EUT OPERATING MODE: Transmit
 ASSIGNED FREQUENCY BAND: 5.15-5.25GHz
 OPERATING FREQUENCY: 5.2GHz
 EUT SET UP: TABLE-TOP
 TEST SITE: SHIELDED ROOM
 FREQUENCY RANGE: 150 kHz - 30 MHz
 RESOLUTION BANDWIDTH: 9 kHz

Frequency, MHz	Peak emission, dB(µV)	Quasi-peak			Average			Line ID	Verdict
		Measured emission, dB(µV)	Limit, dB(µV)	Margin, dB*	Measured emission, dB(µV)	Limit, dB(µV)	Margin, dB*		
0.157	69.8	61.4	65.7	-4.3	29.9	55.7	-25.8	L1	Pass
0.178	67.0	59.3	64.6	-5.3	28.1	54.6	-26.5		
0.230	57.3	49.5	62.5	-13.0	20.4	52.5	-32.1		
0.498	44.8	36.1	56.0	-19.9	5.3	46.0	-40.7		
2.116	36.7	30.9	56.0	-25.1	19.4	46.0	-26.6		
24.600	33.2	27.5	60.0	-32.5	20.4	50.0	-29.6		
0.153	69.9	62.5	65.9	-3.4	31.0	55.9	-24.9	L2	Pass
0.186	66.5	58.9	64.2	-5.3	27.3	54.2	-26.9		
0.439	43.4	36.4	57.1	-20.7	4.8	47.1	-42.3		
1.648	37.6	26.9	56.0	-29.1	1.4	46.0	-44.6		
4.364	37.3	30.9	56.0	-25.1	21.7	46.0	-24.3		
11.253	36.9	28.1	60.0	-31.9	17.3	50.0	-32.7		

*- Margin = Measured emission - specification limit.

Reference numbers of test equipment used

HI 0787	HL 1500	HL 2358	HL 2888	HL 4778			
---------	---------	---------	---------	---------	--	--	--

Full description is given in Appendix A.



HERMON LABORATORIES

Test specification: FCC section 15.407(b)(6), 15.207(a), Conducted emissions			
Test procedure: ANSI C63.10, Section 12.7.4.1, KDB 789033			
Test mode: Compliance		Verdict: PASS	
Date(s): 21-Jan-19			
Temperature: 26 °C	Relative Humidity: 48 %	Air Pressure: 1018 hPa	Power: 48 VDC
Remarks:			

Plot 7.13.1 Conducted emission measurements

LINE: L1
EUT OPERATING MODE: Transmit
LIMIT: QUASI-PEAK, AVERAGE
DETECTOR: PEAK

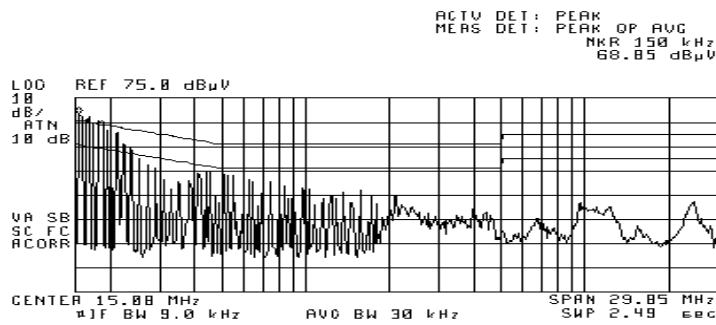

Plot 7.13.2 Conducted emission measurements

LINE: L2
EUT OPERATING MODE: Transmit
LIMIT: QUASI-PEAK, AVERAGE
DETECTOR: PEAK

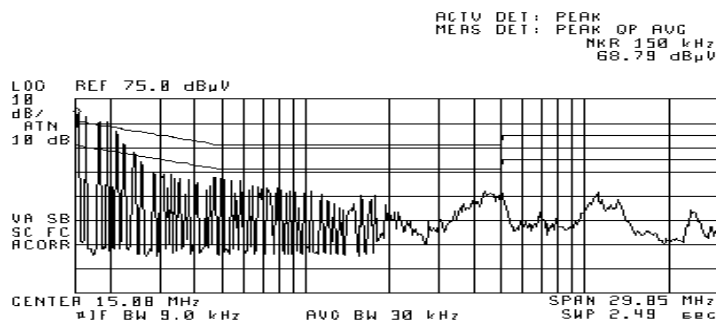



Test specification: FCC section 15.407(b)(6), Conducted emissions			
Test procedure: ANSI C63.10, Section 12.7.4.1, KDB 789033			
Test mode: Compliance		Verdict: PASS	
Date(s): 21-Jan-19			
Temperature: 26 °C	Relative Humidity: 48 %	Air Pressure: 1018 hPa	Power: 48 VDC
Remarks:			

7.14 Conducted emissions at 5725 – 5850 MHz range

7.14.1 General

This test was performed to measure common mode conducted emissions at the power port. Specification test limits are given in Table 7.13.1.

Table 7.14.1 Limits for conducted emissions according to FCC Part 15, Section 207 / RSS-Gen, Section 7.2

Frequency, MHz	Class B limit, dB(μV)	
	QP	AVRG
0.15 - 0.5	66 - 56*	56 - 46*
0.5 - 5.0	56	46
5.0 - 30	60	50

* - The limit decreases linearly with the logarithm of frequency.

7.14.2 Test procedure

7.14.2.1 The EUT was set up as shown in Figure 7.14.1, energized and the performance check was conducted.

7.14.2.2 The measurements were performed at power terminals with the LISN, connected to a spectrum analyzer while unused coaxial connector of the LISN was terminated with 50 Ohm.

7.14.2.3 The position of the device cables was varied to determine maximum emission level.

7.14.2.4 The worst test results (the lowest margins) were recorded in Table 7.14.2 and shown in the associated plots.

Figure 7.14.1 Setup for conducted emission measurements, table-top equipment

