

TEST REPORT (SAR EVALUATION)

Applicant : Sharp Corporation, Consumer Electronics Company,
Communication Systems Division

Address : 2-13-1, Iida, Hachihonmatsu, Higashi-Hiroshima City, Hiroshima,
739-0192, Japan

Products : Cellular Phone

Model No. : HR241

Serial No. : 004401/11/587414/7

FCC ID : APYHRO00241

Test Standard : FCC Rules and Regulations Title 47 CFR Part 2

Test Results : **Passed**

Date of Test : July 28 ~ August 4, 2016



Kousei Shibata
Manager
Japan Quality Assurance Organization
KITA-KANSAI Testing Center
SAITO EMC Branch
7-3-10, Saito-asagi, Ibaraki-shi, Osaka 567-0085, Japan

- The test results in this test report was made by using the measuring instruments which are traceable to national standards of measurement in accordance with ISO/IEC 17025.
- The applicable standard, testing condition and testing method which were used for the tests are based on the request of the applicant.
- The test results presented in this report relate only to the offered test sample.
- The contents of this test report cannot be used for the purposes, such as advertisement for consumers.
- This test report shall not be reproduced except in full without the written approval of JQA.
- VLAC does not approve, certify or warrant the product by this test report.

TABLE OF CONTENTS

	Page
1 Description of the Device Under Test (DUT)	3
2 Summary of Test Results	5
3 Test Procedure.....	6
4 Test Location	6
5 Recognition of Test Laboratory	6
6 Measurement System Diagram.....	7
7 System Components	8
8 Measurement Process.....	11
9 Measurement Uncertainties.....	12
10 Test Arrangement	14
11 Tissue Verification.....	18
12 System Performance Check.....	21
13 RF Output Power Measurements.....	23
14 SAR Measurements	26
15 Test Setup Photographs	31
16 Test Instruments.....	36
17 Appendix.....	37

1 Description of the Device Under Test (DUT)

1.1 General Information

1. Manufacturer : Sharp Corporation, Consumer Electronics Company,
Communication Systems Division
2-13-1, Iida, Hachihonmatsu, Higashi-Hiroshima City, Hiroshima,
739-0192, Japan
2. Products : Cellular Phone
3. Model No. : HR241
4. Serial No. : 004401/11/587414/7
5. Product Type : Pre-production
6. Date of Manufacture : June, 2016
7. Transmitting Frequency : PCS 1900 (1850 MHz – 1910 MHz)
WLAN 2.4 GHz (DTS : 2412 MHz – 2462 MHz)
Bluetooth (2402 MHz – 2480 MHz)
8. Battery Option : Lithium-ion Battery Pack SHBGC1 (1800mAh)
9. Power Rating : 4.0VDC
10. DUT Grounding : None
11. Device Category : Portable Device (§2.1093)
12. Exposure Category : General Population/Uncontrolled Exposure
13. FCC Rule Part(s) : 24(E), 15.247
14. DUT Authorization : Certification
15. Received Date of DUT : July 14, 2016

1.2 Wireless Technologies

Air Interface	Description	
GSM	Frequency band(s)	1900
	Operating mode	GSM (GMSK) GPRS (GMSK)
	GPRS Multi-Slot Class	Class 12 – Four Up
	VoIP	Supported
	DTM (Dual Transfer Mode)	Not supported
WLAN (DTS)	Frequency band(s)	2.4 GHz
	Operating mode	802.11b 802.11g 802.11n [HT20]
	VoIP	Supported
	Wireless Router (Hotspot)	Supported
	Wi-Fi Direct	Supported
Bluetooth	Frequency band(s)	2.4 GHz
	Operating mode	Version 4.1+EDR Version 4.1 LE

1.3 Maximum Output Power

	Mode	Max. Tune-up Limit (dBm)
PCS 1900	Voice	30.4
	GPRS 1 slot	30.0
	GPRS 2 slots	27.8
	GPRS 3 slots	25.8
	GPRS 4 slots	25.0

	Mode	Max. Tune-up Limit (dBm)
WLAN 2.4 GHz (DTS)	802.11b	15.5
	802.11g	11.5
	802.11n HT20	10.0

	Mode	Max. Tune-up Limit (dBm)
	Bluetooth	7.7
	Bluetooth LE	7.7

2 Summary of Test Results

Applied Standard : FCC Rules and Regulations Title 47 CFR Part 2 – Frequency Allocations and Radio Treaty Matters; General Rules and Regulations
§2.1093 Radiofrequency radiation exposure evaluation: portable devices

Test Configuration	Reported 1 g SAR (W/kg)				Limit (W/kg)
	Licensed	DTS	U-NII	DSS (BT)	
Head	0.38	0.18	N/A	N/A	1.6
Body-worn Accessory	0.47	0.19			
Wireless Router (Hotspot)	0.47	0.23			
Simultaneous Transmission	0.70	0.70			

The test results are **passed** for exposure limits specified in ANSI/IEEE Std. C95.1.

In the approval of test results,

- Determining compliance with the limits in this report was based on the results of the compliance measurement, not taking into account measurement instrumentation uncertainty.
- No deviations were employed from the applied standard.
- No modifications were conducted by JQA to achieve compliance to the limitations.

Reviewed by:

Tested by:



Shigeru Kinoshita
Assistant Manager
JQA KITA-KANSAI Testing Center
SAITO EMC Branch



Yasuhisa Sakai
Manager
JQA KITA-KANSAI Testing Center
SAITO EMC Branch

3 Test Procedure

The tests documented in this report were performed in accordance with FCC 47 CFR §2.1093, IEEE Std.1528–2013 and the following KDB Procedures.

- # 248227 D01 802.11 Wi-Fi SAR v02r02
- # 447498 D01 General RF Exposure Guidance v06
- # 648474 D04 SAR Handset SAR v01r03
- # 865664 D01 SAR Measurement 100 MHz to 6 GHz v01r04
- # 865664 D02 RF Exposure Reporting v01r02
- # 941225 D01 3G SAR Procedures v03r01
- # 941225 D06 Hot Spot SAR v02r01

4 Test Location

Japan Quality Assurance Organization (JQA)
KITA-KANSAI Testing Center
7-7, Ishimaru, 1-chome, Minoh-shi, Osaka, 562-0027, Japan
SAITO EMC Branch
7-3-10, Saito-asagi, Ibaraki-shi, Osaka 567-0085, Japan

5 Recognition of Test Laboratory

JQA KITA-KANSAI Testing Center SAITO EMC Branch is accredited under ISO/IEC 17025 by following accreditation bodies and the test facility is registered by the following bodies.

- VLAC Accreditation No. : VLAC-001-2 (Expiry date : March 30, 2018)
- VCCI Registration No. : A-0002 (Expiry date : March 30, 2018)
- BSMI Registration No. : SL2-IS-E-6006, SL2-IN-E-6006, SL2-R1/R2-E-6006, SL2-A1-E-6006
(Expiry date : September 14, 2016)
- IC Registration No. : 2079E-3, 2079E-4 (Expiry date : July 16, 2017)

Accredited as conformity assessment body for Japan electrical appliances and material law by METI.
(Expiry date : February 22, 2019)

6 Measurement System Diagram

These measurements are performed using the DASY5 automated dosimetric assessment system (manufactured by Schmid & Partner Engineering AG (SPEAG) in Zürich, Switzerland). It consists of high precision robotics system, cell controller system, DASY5 measurement server, personal computer with DASY5 software, data acquisition electronic (DAE) circuit, the Electro-optical converter (EOC), near-field probe, and the twin SAM phantom containing the equivalent tissue. The robot is a six-axis industrial robot performing precise movements to position the probe to the location (points) of maximum electromagnetic field (EMF).

The Robot is connected to the cell controller to allow software manipulation of the robot. The DAE is connected to the EOC. The DAE performs the signal amplification, signal multiplexing, A/D conversion, offset measurements, mechanical surface detection, collision detection, etc. The EOC performs the conversion from the optical into digital electric signal of the DAE and transfers data to the DASY5 measurement server.

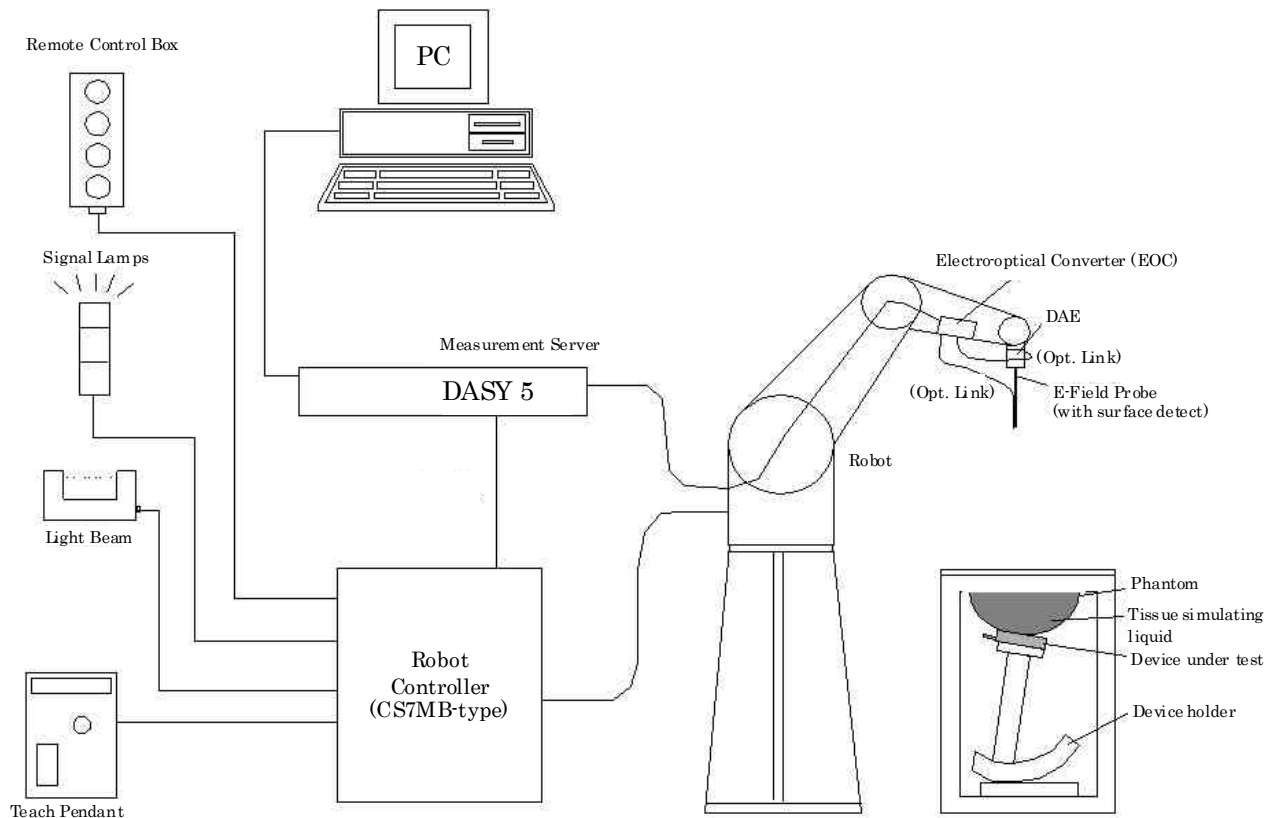

7 System Components

7.1 Probe Specification ET3DV6

Construction	: Symmetrical design with triangular core Built-in optical fiber for surface detection system Built-in shielding against static charges PEEK enclosure material (resistant to organic solvents, e.g., DGBE)	
Calibration	: In air form 10 MHz to 2.3 GHz In head tissue simulating liquid (HSL) and muscle tissue simulating liquid 835 MHz (accuracy $\pm 12.0\%$; k=2) 900 MHz (accuracy $\pm 12.0\%$; k=2) 1450 MHz (accuracy $\pm 12.0\%$; k=2) 1750 MHz (accuracy $\pm 12.0\%$; k=2) 1900 MHz (accuracy $\pm 12.0\%$; k=2) 1950 MHz (accuracy $\pm 12.0\%$; k=2)	
Frequency	: 10 MHz to 2.3 GHz Linearity: ± 0.2 dB (30 MHz to 2.3 GHz)	
Directivity	: ± 0.2 dB in HSL (rotation around probe axis) ± 0.4 dB in HSL (rotation normal to probe axis)	
Dynamic Range	: $5 \mu\text{W/g}$ to $>100 \text{ mW/g}$; Linearity: ± 0.2 dB	
Surface Detection	: ± 0.2 mm repeatability in air and clear liquids over diffuse reflecting surfaces	
Dimensions	: Overall length 337 mm Tip length 16 mm Body diameter 12 mm Tip diameter 6.8 mm Distance from probe tip to dipole centers 2.7 mm	

7.2 Probe Specification EX3DV4

Construction : Symmetrical design with triangular core
Built-in shielding against static charges
PEEK enclosure material (resistant to organic solvents, e.g., DGBE)

Calibration : In air form 10 MHz to 6 GHz
In head tissue simulating liquid (HSL) and
muscle tissue simulating liquid
2450 MHz (accuracy $\pm 12.0\%$; k=2)
2600 MHz (accuracy $\pm 12.0\%$; k=2)
5200 MHz (accuracy $\pm 13.1\%$; k=2)
5300 MHz (accuracy $\pm 13.1\%$; k=2)
5500 MHz (accuracy $\pm 13.1\%$; k=2)
5600 MHz (accuracy $\pm 13.1\%$; k=2)
5800 MHz (accuracy $\pm 13.1\%$; k=2)



Frequency : 10 MHz to 6 GHz
Linearity: ± 0.2 dB (30 MHz to 6 GHz)

Directivity : ± 0.3 dB in HSL (rotation around probe axis)
 ± 0.5 dB in tissue material (rotation normal to probe axis)

Dynamic Range : 10 μ W/g to >100 mW/g; Linearity: ± 0.2 dB (noise: typically < 1 μ W/g)

Dimensions : Overall length 337 mm
Tip length 20 mm
Body diameter 12 mm
Tip diameter 2.5 mm
Distance from probe tip to dipole centers 1 mm

7.3 Twin SAM Phantom

The shell corresponds to the specifications of the Specific Anthropomorphic Mannequin (SAM) phantom defined in IEEE 1528 and IEC 62209-1. It enables the dosimetric evaluation of left and right hand phone usage as well as body mounted usage at the flat phantom region. A cover prevents evaporation of the liquid. Reference markings on the phantom allow the complete setup of all predefined phantom positions and measurement grids by teaching three points with the robot.



Shell Thickness : 2 ± 0.2 mm; Center ear point: 6 ± 0.2 mm
Filling Volume : Volume Approx. 25 liters
Dimensions : $810 \times 1000 \times 500$ mm (H \times L \times W)

7.4 ELI4 Flat Phantom

Phantom for compliance testing of handheld and body-mounted wireless devices in the frequency range of 30 MHz to 6 GHz. ELI is fully compatible with the IEC 62209-2 standard and all known tissue simulating liquids. ELI has been optimized regarding its performance and can be integrated into our standard phantom tables. A cover prevents evaporation of the liquid. Reference markings on the phantom allow installation of the complete setup, including all predefined phantom positions and measurement grids, by teaching three points. The phantom is compatible with all SPEAG dosimetric probes and dipoles.

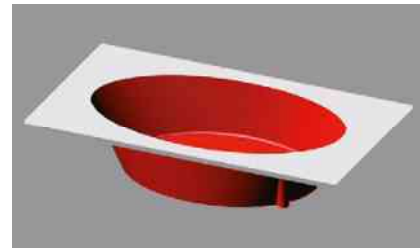

Shell Thickness : 2 ± 0.2 mm (sagging: <1%)
Filling Volume : Volume Approx. 30 liters
Dimensions : Major ellipse axis : 600 mm
Minor axis : 400 mm

7.5 Mounting Device for Transmitters

In combination with the Twin SAM Phantom V4.0/V4.0c or ELI4, the Mounting Device enables the rotation of the mounted transmitter device in spherical coordinates. Rotation point is the ear opening point. Transmitter devices can be easily and accurately positioned according to IEC, IEEE, CENELEC, FCC or other specifications. The device holder can be locked for positioning at different phantom sections (left head, right head, flat point).



8 Measurement Process

Step 1 : Power Reference Measurement

The power reference job measures the field at a specified reference position, at a selectable distance from the phantom surface. The reference position can be either the selected section's grid reference point or a user point in this section. The reference job projects the selected point onto the phantom surface, orients the probe perpendicularly to the surface, and approaches the surface using the selected detection method. The minimum distance of probe sensors to surface set to 4 mm for an ET3DV6 probe, or 2 mm for EX3DV4 probe. This distance cannot be smaller than the distance of sensor calibration points to probe tip as defined in the probe properties.

Step 2 : Area Scan

The area scan is used as a fast scan in two dimensions to find the area of high field values, before doing a fine measurement around the hot spot. The sophisticated interpolation routines implemented in DASY software can find the maximum locations in relatively coarse grids. When an area scan has measured all reachable points, it computes the field maximal found in the scanned area, within a range of the global maximum. If only one zoom scan follows the area scan, then only the absolute maximum will be taken as reference. For cases where multiple maxima within 2 dB of the maximum SAR value are detected, the number of zoom scans has to be increased accordingly.

Step 3 : Zoom Scan

Zoom scans are used to assess the peak spatial SAR values within a cubic averaging volume containing 1 g and 10 g of simulated tissue. The zoom scan measures points specified in standards within a cube whose base faces are centered on the maxima found in a preceding area scan job within the same procedure.

Step 4 : Z Scan

The Z scan measures points along a vertical straight line. The line runs along the Z axis of a one-dimensional grid. In order to get a reasonable extrapolation, the extrapolated distance should not be larger than the step size in Z-direction.

Step 5 : Power Drift Measurement

The power drift measurement measures the field at the same location as the most recent power reference measurement job within the same procedure, and with the same settings. The power drift measurement gives the field difference in dB from the reading conducted within the last power reference measurement. The power reference measurement and power drift measurement are for monitoring the power drift of the device under test in the batch process.

9 Measurement Uncertainties

9.1 300 MHz to 3 GHz

Uncertainty Component	Tol. (± %)	Prob. Dist.	Div.	c_i (1g)	c_i (10g)	Std. Unc. (± %)		ν_i
						1g	10g	
Measurement System								
Probe calibration	6.0	N	1	1	1	6.0	6.0	∞
Axial isotropy	4.7	R	$\sqrt{3}$	0.7	0.7	1.9	1.9	∞
Hemispherical isotropy	9.6	R	$\sqrt{3}$	0.7	0.7	3.9	3.9	∞
Boundary effects	1.0	R	$\sqrt{3}$	1	1	0.6	0.6	∞
Linearity	4.7	R	$\sqrt{3}$	1	1	2.7	2.7	∞
System detection limits	1.0	R	$\sqrt{3}$	1	1	0.6	0.6	∞
Modulation response	2.4	R	$\sqrt{3}$	1	1	1.4	1.4	∞
Readout electronics	0.3	N	1	1	1	0.3	0.3	∞
Response time	0.8	R	$\sqrt{3}$	1	1	0.5	0.5	∞
Integration time	2.6	R	$\sqrt{3}$	1	1	1.5	1.5	∞
RF ambient conditions – noise	3.0	R	$\sqrt{3}$	1	1	1.7	1.7	∞
RF ambient conditions – reflections	3.0	R	$\sqrt{3}$	1	1	1.7	1.7	∞
Probe positioner mechanical tolerance	0.4	R	$\sqrt{3}$	1	1	0.2	0.2	∞
Probe positioning with respect to phantom shell	2.9	R	$\sqrt{3}$	1	1	1.7	1.7	∞
Extrapolation, interpolation and integration algorithms for max. SAR evaluation	2.0	R	$\sqrt{3}$	1	1	1.2	1.2	∞
Test Sample Related								
Device holder uncertainty	2.9	N	1	1	1	2.9	2.9	5
Test sample positioning	3.4	N	1	1	1	3.4	3.4	23
Output power variation – SAR drift measurement	5.0	R	$\sqrt{3}$	1	1	2.9	2.9	∞
Power Scaling	0.0	R	$\sqrt{3}$	1	1	0.0	0.0	∞
Phantom and Tissue Parameters								
Phantom uncertainty	6.1	R	$\sqrt{3}$	1	1	3.5	3.5	∞
Algorithms for correcting SAR for deviations	1.9	R	$\sqrt{3}$	1	0.84	1.1	0.9	∞
Liquid Conductivity – measurement uncertainty	3.2	N	1	0.78	0.71	2.5	2.3	5
Liquid Permittivity – measurement uncertainty	3.0	N	1	0.26	0.26	0.8	0.8	5
Liquid Conductivity – temperature uncertainty	5.2	R	$\sqrt{3}$	0.78	0.71	2.3	2.1	∞
Liquid Permittivity – temperature uncertainty	0.8	R	$\sqrt{3}$	0.23	0.26	0.1	0.1	∞
Combined Standard Uncertainty						11.5	11.4	
Expanded Uncertainty (95% Confidence Interval)						22.9	22.7	
NOTES 1. Tol. : tolerance in influence quantity 2. Prob. Dist. : probability distributions 3. N, R : normal, rectangular 4. Div. : divisor used to obtain standard uncertainty 5. c_i : sensitivity coefficient 6. Std. Unc. : standard uncertainty 7. Measurement uncertainties are according to IEEE Std.1528 and IEC 62209-1.								

9.2 3 GHz to 6 GHz

Uncertainty Component	Tol. (± %)	Prob. Dist.	Div.	c_i (1g)	c_i (10g)	Std. Unc. (± %)		v_i
						1g	10g	
Measurement System								
Probe calibration	6.6	N	1	1	1	6.6	6.6	∞
Axial isotropy	4.7	R	√3	0.7	0.7	1.9	1.9	∞
Hemispherical isotropy	9.6	R	√3	0.7	0.7	3.9	3.9	∞
Boundary effects	2.0	R	√3	1	1	1.2	1.2	∞
Linearity	4.7	R	√3	1	1	2.7	2.7	∞
System detection limits	1.0	R	√3	1	1	0.6	0.6	∞
Modulation response	2.4	R	√3	1	1	1.4	1.4	∞
Readout electronics	0.3	N	1	1	1	0.3	0.3	∞
Response time	0.8	R	√3	1	1	0.5	0.5	∞
Integration time	2.6	R	√3	1	1	1.5	1.5	∞
RF ambient conditions – noise	3.0	R	√3	1	1	1.7	1.7	∞
RF ambient conditions – reflections	3.0	R	√3	1	1	1.7	1.7	∞
Probe positioner mechanical tolerance	0.8	R	√3	1	1	0.5	0.5	∞
Probe positioning with respect to phantom shell	6.7	R	√3	1	1	3.9	3.9	∞
Extrapolation, interpolation and integration algorithms for max. SAR evaluation	4.0	R	√3	1	1	2.3	2.3	∞
Test Sample Related								
Device holder uncertainty	2.9	N	1	1	1	2.9	2.9	5
Test sample positioning	3.4	N	1	1	1	3.4	3.4	23
Output power variation – SAR drift measurement	5.0	R	√3	1	1	2.9	2.9	∞
Power Scaling	0.0	R	√3	1	1	0.0	0.0	∞
Phantom and Tissue Parameters								
Phantom uncertainty	6.6	R	√3	1	1	3.8	3.8	∞
Algorithms for correcting SAR for deviations	1.9	R	√3	1	0.84	1.1	0.9	∞
Liquid Conductivity – measurement uncertainty	3.2	N	1	0.78	0.71	2.5	2.3	5
Liquid Permittivity – measurement uncertainty	3.0	N	1	0.26	0.26	0.8	0.8	5
Liquid Conductivity – temperature uncertainty	3.4	R	√3	0.78	0.71	1.5	1.4	∞
Liquid Permittivity – temperature uncertainty	0.4	R	√3	0.23	0.26	0.1	0.1	∞
Combined Standard Uncertainty			RSS			12.5	12.4	
Expanded Uncertainty (95% Confidence Interval)			k=2			24.9	24.8	
NOTES 1. Tol. : tolerance in influence quantity 2. Prob. Dist. : probability distributions 3. N, R : normal, rectangular 4. Div. : divisor used to obtain standard uncertainty 5. c_i : sensitivity coefficient 6. Std. Unc. : standard uncertainty 7. Measurement uncertainties are according to IEEE Std.1528 and IEC 62209-1.								

10 Test Arrangement

10.1 Head Exposure Conditions

10.1.1 Cheek-Touch Position

1. Position the device with the vertical center line of the body of the device and the horizontal line crossing the center of the ear piece in a plane parallel to the sagittal plane of the phantom.
2. While maintaining the device in this plane, align the vertical center line with the reference plane containing the three ear and mouth reference points (M, RE and LE) and align the center of the ear piece with the line RE-LE.
3. Translate the mobile phone box towards the phantom with the ear piece aligned with the line RE-LE until the phone touches the ear.
4. While maintaining the device in the reference plane and maintaining the phone contact with the ear, move the bottom of the box until any point on the front side is in contact with the cheek of the phantom or until contact with the ear is lost.

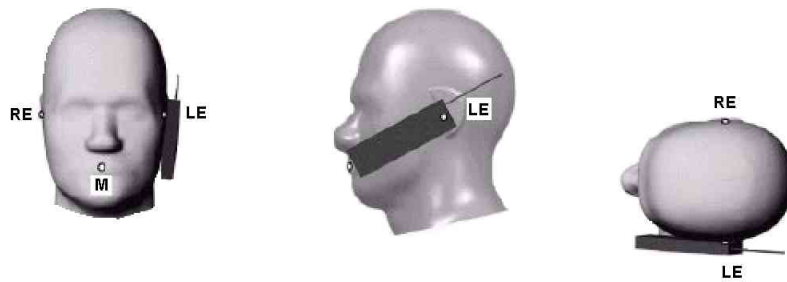
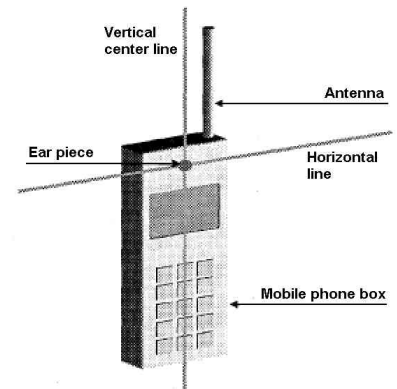

10.1.2 Ear-Tilt Position

1. Position the device in the “Cheek-Touch Position”.
2. While maintaining the device in the reference plane and pivoting against the ear, move it outward away from the mouth by an angle of 15 degrees or until contact with the ear is lost.

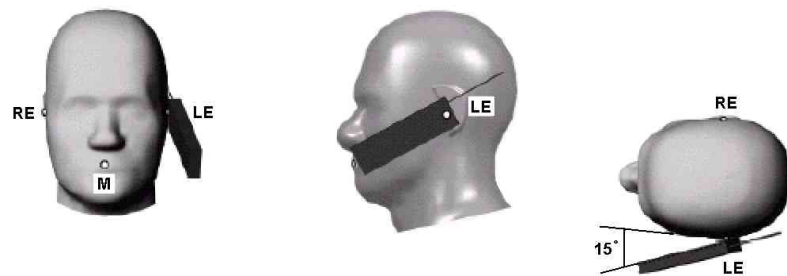

10.2 Body-worn Accessory Exposure Conditions

Body-worn operating configurations should be tested with the belt-clips and holsters attached to the device and positioned against a flat phantom in normal use configurations. Both the physical spacing to the body of the user as dictated by the accessory and the materials used in an accessory affect the SAR produced by the transmitting device. For purpose of determining test requirements, accessories may be divided into two categories: those that do not contain metallic components and those that do.

When multiple accessories that do not contain metallic components are supplied with the device, the device may be tested with only the accessory that dictates the closest spacing to the body. When multiple accessories that contain metallic components are supplied with the device, the device must be tested with each accessory that contains a unique metallic component. If multiple accessories share an identical metallic component (e.g., the same metallic belt-clip used with different holsters with no other metallic components), only the accessory that dictates the closest spacing to the body must be tested.

Body-worn accessories may not always be supplied or available as options for some devices that are intended to be authorized for body-worn use. A separation distance of 1.5 cm between the surface of the device and a flat phantom is recommended for testing body-worn SAR compliance under such circumstances. Other separation distances may be used, but they should not exceed 2.5 cm. In these cases, the device may use body-worn accessories that provide a separation distance greater than that tested for the device provided however that the accessory contains no metallic components.

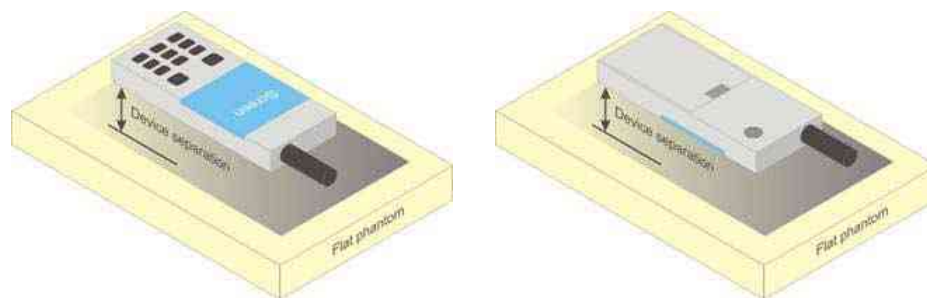

10.3 Hotspot Mode Exposure Conditions

For cell phones that support hotspot mode operations, with wireless router capabilities and various web browsing functions, the relevant hand and body exposure conditions are tested according to the hotspot SAR procedures in KDB 941225. A test separation distance of 10 mm is required between the phantom and all surfaces and edges with a transmitting antenna located within 25 mm from that surface or edge. When the form factor of a handset is smaller than 9 cm × 5 cm, a test separation distance of 5 mm (instead of 10 mm) is required for testing hotspot mode. When the separation distance required for body-worn accessory testing is larger than or equal to that tested for hotspot mode, in the same wireless mode and for the same surface of the phone, the hotspot mode SAR data may be used to support body-worn accessory SAR compliance for that particular configuration (surface).

10.4 RF Exposure Conditions

Handsets are tested for SAR compliance in head, body-worn accessory and other use configurations according to the procedures described in KDB 648474 D04.

RF Exposure Conditions	DUT-to-User Separation	Wireless Technologies	Test Position	Antenna-to-edge/surface	SAR Required	Note
Head	0 mm	All Tx	Left Touch	N/A	YES	
			Left Tilt (15°)	N/A	YES	
			Right Touch	N/A	YES	
			Right Tilt (15°)	N/A	YES	
Body-worn	10 mm	All Tx	Rear	N/A	YES	
			Front	N/A	YES	
Hotspot	10 mm	GSM	Rear	< 25 mm	YES	
			Front	< 25 mm	YES	
			Edge 1 (Top)	< 25 mm	YES	
			Edge 2 (Right)	< 25 mm	YES	
			Edge 3 (Bottom)	> 25 mm	NO	1
		WLAN Bluetooth	Rear	< 25 mm	YES	
			Front	< 25 mm	YES	
			Edge 1 (Top)	< 25 mm	YES	
			Edge 2 (Right)	< 25 mm	YES	
			Edge 3 (Bottom)	> 25 mm	NO	1
Edge 4 (Left)	> 25 mm	NO	1			

Note(s):

1. SAR is not required because the distance from the antenna to the edge is > 25 mm as per KDB 941225 D06.

Antenna Location and Separation Distances

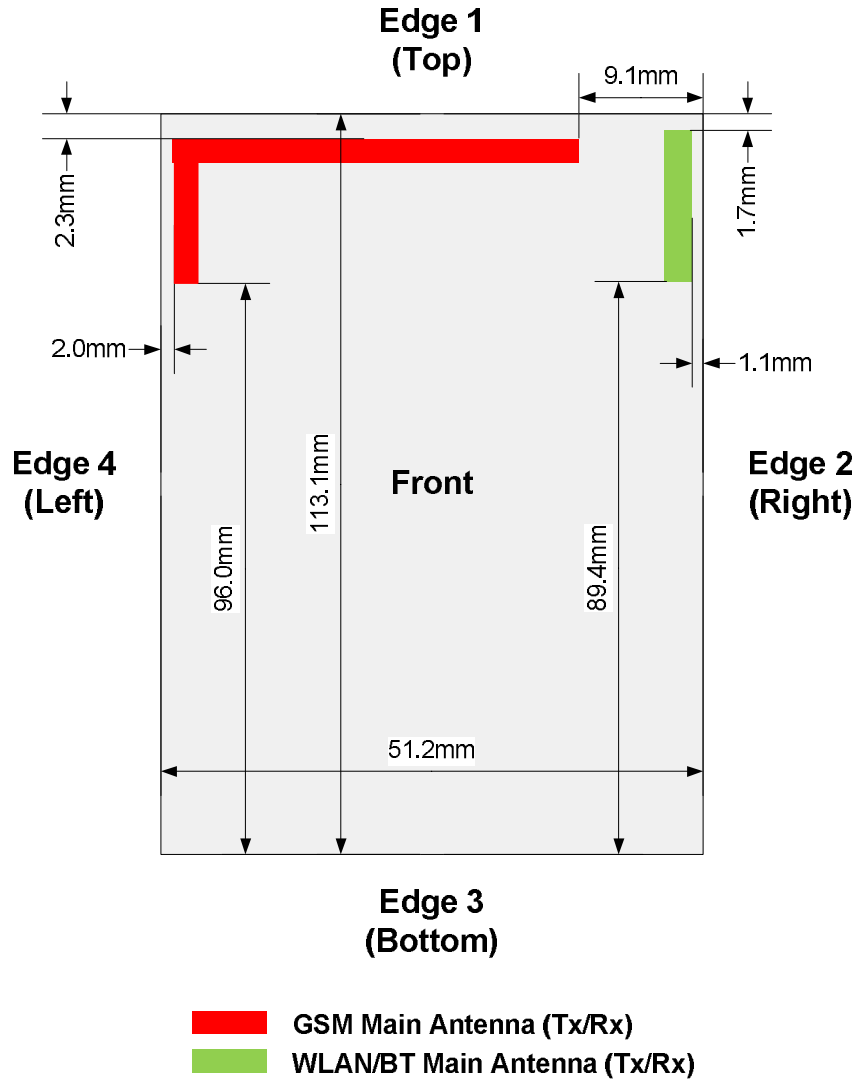

11 Tissue Verification

11.1 Tissue Verification Measurement Condition

The tissue dielectric parameters must be measured before the tissue-equivalent medium is used in a series of SAR measurements. The parameters should be re-measured after each 3 – 4 days of use, or earlier if dielectric parameters can become out of tolerance; for example, when the parameters are marginal at the beginning of the measurement series.

The temperature of the tissue-equivalent medium used during measurement must be within 18°C to 25°C and within ± 2°C of the temperature when the tissue parameters are characterized.

It is verified by using the dielectric probe and the network analyzer.

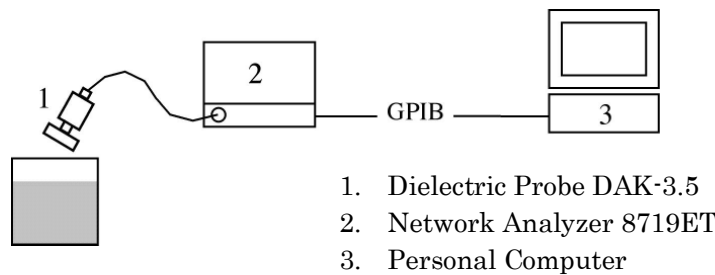

11.2 Tissue Dielectric Properties

The tissue dielectric properties are specified in KDB 865664 D01.

Target Frequency [MHz]	Head		Body	
	Permittivity (ϵ_r)	Conductivity (σ)	Permittivity (ϵ_r)	Conductivity (σ)
150	52.3	0.76	61.9	0.80
300	45.3	0.87	58.2	0.92
450	43.5	0.87	56.7	0.94
835	41.5	0.90	55.2	0.97
900	41.5	0.97	55.0	1.05
915	41.5	0.98	55.0	1.06
1450	40.5	1.20	54.0	1.30
1610	40.3	1.29	53.8	1.40
1800 – 2000	40.0	1.40	53.3	1.52
2450	39.2	1.80	52.7	1.95
3000	38.5	2.40	52.0	2.73
5800	35.3	5.27	48.2	6.00

For tissue dielectric properties at other frequencies within the range, a linear interpolation method shall be used.

11.4 Tissue Verification Results

Tissue dielectric parameters are measured at the low, middle and high frequency of each operating frequency range of the test device.

Date	Liquid	Frequency [MHz]	Parameters	Target	Measured	Deviation [%]	Limit [%]
7/28/2016	Body	1850	Permittivity (ϵ_r)	53.3	53.01	-0.54	± 5
			Conductivity (σ)	1.52	1.489	-2.04	± 5
		1900	Permittivity (ϵ_r)	53.3	52.82	-0.90	± 5
			Conductivity (σ)	1.52	1.545	+1.64	± 5
		1910	Permittivity (ϵ_r)	53.3	52.78	-0.98	± 5
			Conductivity (σ)	1.52	1.555	+2.30	± 5
7/29/2016	Head	1850	Permittivity (ϵ_r)	40.0	39.82	-0.45	± 5
			Conductivity (σ)	1.40	1.379	-1.50	± 5
		1900	Permittivity (ϵ_r)	40.0	39.58	-1.05	± 5
			Conductivity (σ)	1.40	1.431	+2.21	± 5
		1910	Permittivity (ϵ_r)	40.0	39.53	-1.18	± 5
			Conductivity (σ)	1.40	1.440	+2.86	± 5
8/3/2016	Head	2410	Permittivity (ϵ_r)	39.3	39.26	-0.10	± 5
			Conductivity (σ)	1.76	1.822	+3.52	± 5
		2450	Permittivity (ϵ_r)	39.2	39.07	-0.33	± 5
			Conductivity (σ)	1.80	1.872	+4.00	± 5
		2475	Permittivity (ϵ_r)	39.2	38.99	-0.54	± 5
			Conductivity (σ)	1.83	1.901	+3.88	± 5
8/4/2016	Body	2410	Permittivity (ϵ_r)	52.8	52.95	+0.28	± 5
			Conductivity (σ)	1.91	1.894	-0.84	± 5
		2450	Permittivity (ϵ_r)	52.7	52.79	+0.17	± 5
			Conductivity (σ)	1.95	1.947	-0.15	± 5
		2475	Permittivity (ϵ_r)	52.7	52.70	+0.00	± 5
			Conductivity (σ)	1.99	1.979	-0.55	± 5

12 System Performance Check

12.1 System Performance Check Measurement Condition

The power meter PM1 (including Attenuator) measures the forward power at the location of the validation dipole connector. The signal generator is adjusted for 250 mW (100 mW for 3 to 6 GHz) at the dipole connector and the power meter PM2 is read at that level. After connecting the cable to the dipole, the signal generator is readjusted for the same reading at power meter PM2.

The dipole antenna is matched to be used near flat phantom filled with tissue simulating solution. A specific distance holder is used in the positioning of the antenna to ensure correct spacing between the phantom and the dipole.

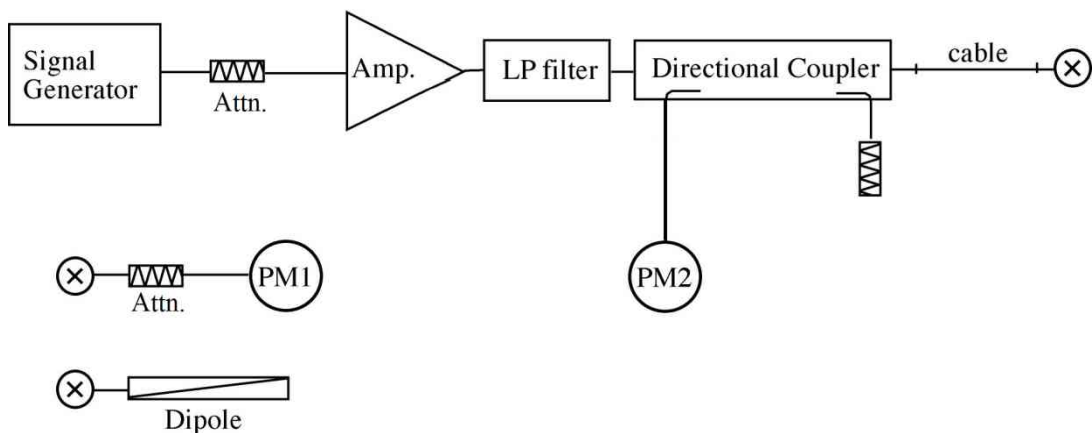

12.2 Target SAR Values for System Performance Check

The target SAR values can be obtained from the calibration certificate of system validation dipoles.

System Dipole		Cal. Date	Frequency [MHz]	Target SAR Values [W/kg]		
Type	Serial			1g/10g	Head	Body
D1900V2	5d129	5/6/2015	1900	1g	38.1	39.3
				10g	20.0	20.8
D2450V2	714	11/10/2015	2450	1g	53.5	53.1
				10g	25.0	25.1

12.3 System Performance Check Results

The SAR measured with a system validation dipole, using the required tissue-equivalent medium at the test frequency, must be within 10 % of the manufacturer calibrated dipole SAR target.

Date	System Dipole		Liquid	Measured SAR [W/kg] (Normalized to 1 W)		Target	Deviation [%]	Limit [%]
	Type	Serial						
7/28/2016	D1900V2	5d129	Body	1 g	40.80	39.3	+3.82	± 10
				10 g	21.28	20.8	+2.31	± 10
7/29/2016	D1900V2	5d129	Head	1 g	39.16	38.1	+2.78	± 10
				10 g	20.48	20.0	+2.40	± 10
8/3/2016	D2450V2	714	Head	1 g	53.60	53.5	+0.19	± 10
				10 g	24.92	25.0	-0.32	± 10
8/4/2016	D2450V2	714	Body	1 g	51.20	53.1	-3.58	± 10
				10 g	24.20	25.1	-3.59	± 10

13 RF Output Power Measurements

13.1 GSM

Settings	Mode	Parameter	
General Settings	Band Indicator	GSM 850	PCS 1900
	Power Control Level	5 (33 dBm)	0 (30 dBm)
GPRS Specific Settings	Connection Type	Test Mode A	
	Multi Slot Class	12 (4 down / 4 up / 5 sum)	
	Coding Scheme	CS1 (GMSK)	

PCS 1900 Results

Mode		Conducted Average Power (dBm)						Sepc. Max. (Frame)
		512 ch (1850.2 MHz)		661 ch (1880.0 MHz)		810 ch (1909.8 MHz)		
		Burst	Frame	Burst	Frame	Burst	Frame	
GSM	Voice	29.10	20.07	29.17	20.14	29.06	20.03	21.37
GPRS	1 slot	29.10	20.07	29.17	20.14	29.07	20.04	20.97
	2 slots	26.86	20.84	26.97	20.95	26.78	20.76	21.78
	3slots	24.88	20.62	24.90	20.64	24.88	20.62	21.54
	4 slots	24.27	21.26	24.33	21.32	24.20	21.19	21.99

Note(s):

KDB 941225 D01 – The worst-case configuration for SAR testing is determined to be as follows.

1. Body : GPRS mode with 4 time slots, based on the output power above
2. Head : Same mode as Body SAR testing (VoIP applicable using GPRS multi-slot)

13.2 WLAN (DTS Band)

DTS Band Results

Band	Mode	Data Rate	Ch#	Frequency (MHz)	Average Power (dBm)	
					Measred	Spec. Max.
2.4 GHz (DTS)	802.11b	1 Mbps	1	2412	13.99	15.5
			6	2437	13.98	
			11	2462	14.03	
	802.11g	6 Mbps	1	2412	9.99	11.5
			6	2437	10.03	
			11	2462	10.09	
	802.11n [HT20]	MCS 0	1	2412	8.47	10.0
			6	2437	8.55	
			11	2462	8.58	

Note(s):

Power measurement is required for the transmission mode configuration with the highest maximum output power specified for production units. (802.11b DSSS and 802.11g/n OFDM configurations are considered separately.)

- When the same highest maximum output power specification applies to multiple transmission modes, the largest channel bandwidth configuration with the lowest order modulation and lowest data rate is measured.
- When the same highest maximum output power is specified for multiple largest channel bandwidth configurations with the same lowest order modulation or lowest order modulation and lowest data rate, power measurement is required for all equivalent 802.11 configurations with the same maximum output power.

13.3 Bluetooth

Maximum tune-up tolerance limit is 7.7 dBm from the rated nominal maximum output power. This power level qualifies for exclusion of SAR testing.

13.4 Standalone SAR Test Exclusion Considerations (KDB 447498 D01)

The 1 g SAR test exclusion thresholds for 100 MHz to 6 GHz at *test separation distances* ≤ 50 mm are determined by;

$[(\text{max. power of channel, including tune-up tolerance, mW}) / (\text{min. test separation distance, mm})] \cdot [\sqrt{f_{\text{(GHz)}}}] \leq 3.0$ for 1 g SAR and ≤ 7.5 for 10 g extremity SAR, where

- $f_{\text{(GHz)}}$ is the RF channel transmit frequency in GHz.
- Power and distance are rounded to the nearest mW and mm before calculation.
- The result is rounded to one decimal place for comparison.
- When the minimum test separation distance is < 5 mm, a distance of 5 mm is applied.

Band	Freq. (MHz)	Max. Power		Test Position	Distance (mm)	Threshold	Test Exclusion
		(dBm)	(mW)				
WLAN (DTS)	2462	15.5	35	Head	< 5	11.0	NO
				Body	10	5.5	NO
Bluetooth	2480	7.7	6	Head	< 5	1.9	YES
				Body	10	0.9	YES

14 SAR Measurements

SAR test reduction criteria are as follows:

When 10 g extremity SAR is required, SAR values indicated below are multiplied by 2.5, i.e. the ratio of the 1 g and extremity 10 g SAR limit.

KDB 447498 D01 General RF Exposure Guidance:

Testing of other required channels within the operating mode of a frequency band is not required when the reported 1 g SAR for the mid-band or highest output power channel is:

- ≤ 0.8 W/kg when the transmission band is ≤ 100 MHz
- ≤ 0.6 W/kg when the transmission band is between 100 MHz and 200 MHz
- ≤ 0.4 W/kg when the transmission band is ≥ 200 MHz

KDB 648474 D04 Handset SAR:

With headset attached, when the reported SAR for body-worn accessory, measured without a headset connected to the handset, is > 1.2 W/kg, the highest reported SAR configuration for that wireless mode and frequency band should be repeated for that body-worn accessory with a headset attached to the handset.

KDB 941225 D01 SAR test for 3G devices:

When the maximum output power and tune-up tolerance specified for production units in a secondary mode is $\leq \frac{1}{4}$ dB higher than the primary mode or when the highest reported SAR of the primary mode is scaled by the ratio of specified maximum output power and tune-up tolerance of secondary to primary mode and the adjusted SAR is ≤ 1.2 W/kg, SAR measurement is not required for the secondary mode.

For phablets, when hotspot mode applies, the UMPC mini-tablet 10 g extremity SAR is not required for the surfaces and edges with hotspot mode 1 g reported SAR ≤ 1.2 W/kg.

KDB 248227 D01 802.11 Wi-Fi SAR:

SAR test reduction is determined according to 802.11 transmission mode configurations and certain exposure conditions with multiple test positions. In the 2.4 GHz band, separate SAR procedures are applied to DSSS and OFDM configurations to simplify DSSS test requirements. For OFDM in both 2.4 GHz and 5 GHz bands, an initial test configuration is first determined for each standalone and aggregated frequency band according to the maximum output power and tune-up tolerance specified for production units. When the same maximum power is specified for multiple transmission modes in a frequency band, the largest channel bandwidth, lowest order modulation, lowest data rate and lowest order 802.11a/g/n/ac mode is used for SAR measurement, on the highest measured output power channel in the initial test configuration, for each frequency band.

SAR is measured using the highest measured maximum output power channel for the determined exposure configurations. When there are multiple test channels with the same measured maximum output power, the channel closest to mid-band frequency is selected for SAR measurement. When there are multiple test channels with the same measured maximum output power and equal separation from mid-band frequency; for example, high and low channels or two mid-band channels, the higher frequency (number) channel is selected for SAR measurement.

An initial test position is applied to further reduce the number of SAR tests for devices operating in next to the ear, UMPC mini-tablet or hotspot mode exposure configurations that require multiple test positions SAR is measured in the initial test position using the 802.11 transmission mode configuration required by the DSSS procedure or initial test configuration according to the OFDM procedures. The initial test position procedure is described in the following:

- When the reported SAR of the initial test position is ≤ 0.4 W/kg, further SAR measurement is not required for the other (remaining) test positions in that exposure configuration and 802.11 transmission mode combination within the frequency band or aggregated band.
- When the reported SAR of the initial test position is > 0.4 W/kg, SAR is repeated for the 802.11 transmission mode configuration tested in the initial test position using subsequent highest extrapolated or estimated 1 g SAR conditions determined by area scans or next closest/smallest test separation distance and maximum RF coupling test positions based on manufacturer justification, on the highest maximum output power channel, until the reported SAR is ≤ 0.8 W/kg or all required test positions (left, right, touch, tilt or subsequent surfaces and edges) are tested.
- For all positions/configurations tested using the initial test position and subsequent test positions, when the reported SAR is > 0.8 W/kg, SAR is measured for these test positions/configurations on the subsequent next highest measured output power channel(s) until the reported SAR is ≤ 1.2 W/kg or all required channels are tested.

To determine the initial test position, Area Scans were performed to determine the position with the estimated 1 g SAR (fast SAR). The position that produced the highest fast SAR is considered the worst case position; thus used as the initial test position. The averaged fast SAR is scaled according to reported SAR requirements.

14.1 PCS 1900

GPRS 4 slots (CS1) – Duty Cycle 48.0%									
RF Exposure Conditions	Test Position	Dist. [mm]	Ch#	Freq. [MHz]	Power [dBm]		1 g SAR [W/kg]		Plot No.
					Tune-up Limit	Meas.	Meas.	Scaled	
Head	Left Touch	0	661	1880.0	25.0	24.33	0.327	0.382	1
	Left Tilt	0	661	1880.0	25.0	24.33	0.186	0.217	
	Right Touch	0	661	1880.0	25.0	24.33	0.319	0.372	
	Right Tilt	0	661	1880.0	25.0	24.33	0.138	0.161	
Body-worn & Hotspot	Rear	10	661	1880.0	25.0	24.33	0.406	0.474	2
	Front	10	661	1880.0	25.0	24.33	0.358	0.418	
Hotspot	Edge 1	10	661	1880.0	25.0	24.33	0.171	0.200	
	Edge 2	10	661	1880.0	25.0	24.33	0.060	0.070	
	Edge 4	10	661	1880.0	25.0	24.33	0.215	0.251	

14.2 WLAN (DTS Band)

802.11b (1 Mbps) – Duty Cycle 100%										
RF Exposure Conditions	Test Position	Dist. [mm]	Ch#	Freq. [MHz]	Averaged Fast SAR [W/kg]	Power [dBm]		1 g SAR [W/kg]		Plot No.
						Tune-up Limit	Meas.	Meas.	Scaled	
Head	Left Touch	0	11	2462	0.182	15.5	14.03	0.128	0.180	3
	Left Tilt	0	11	2462	0.058	15.5	14.03			
	Right Touch	0	11	2462	0.121	15.5	14.03			
	Right Tilt	0	11	2462	0.068	15.5	14.03			
Body-worn & Hotspot	Rear	10	11	2462	0.189	15.5	14.03	0.137	0.192	4
	Front	10	11	2462	0.055	15.5	14.03			
Hotspot	Edge 1	10	11	2462	0.017	15.5	14.03			
	Edge 2	10	11	2462	0.229	15.5	14.03	0.162	0.227	5

Note(s):

SAR is not required for 802.11g/n OFDM configurations when the highest *reported* SAR for DSSS is adjusted by the ratio of OFDM to DSSS specified maximum output power and the adjusted SAR is ≤ 1.2 W/kg.

14.3 SAR Measurement Variability

In accordance with the KDB 865664 D01, these additional measurements are repeated after the completion of all measurements requiring the same head or body tissue-equivalent medium in a frequency band. The DUT should be returned to ambient conditions (normal room temperature) with the battery fully charged before it is re-mounted on the device holder for the repeated measurement(s) to minimize any unexpected variations in the repeated results.

- 1) Repeated measurement is not required when the original highest measured SAR is < 0.80 W/kg; steps 2) through 4) do not apply.
- 2) When the original highest measured SAR is ≥ 0.80 W/kg, repeat that measurement once.
- 3) Perform a 2nd repeated measurement only if the ratio of largest to smallest SAR for the original and first repeated measurements is > 1.20 or when the original or repeated measurement is ≥ 1.45 W/kg (~ 10% from the 1-g SAR limit).
- 4) Perform a 3rd repeated measurement only if the original, first or second repeated measurement is ≥ 1.5 W/kg and the ratio of largest to smallest SAR for the original, first and second repeated measurements is > 1.20.

14.3.1 Highest Measured SAR Configuration in Each Frequency Band

Frequency Band [MHz]	Air Interface	Standalone SAR [W/kg]	
		Head	Body
1900	PCS 1900	0.327	0.406
2450	WLAN 802.11b	0.128	0.162

14.3.2 Repeated SAR Measurement Results

Repeated SAR measurement is not required because the highest measured SAR is < 0.80 W/kg.

14.4 Simultaneous Transmission SAR Analysis

14.4.1 Simultaneous Transmission Condition

WWAN can transmit simultaneously with WLAN/Bluetooth.

WLAN cannot transmit simultaneously with Bluetooth since they share an antenna port.

No.	Conditions	Head	Body	Hotspot
1	GSM + WLAN 2.4 GHz	YES	YES	YES
2	GSM + Bluetooth	YES	YES	NO

14.4.2 Standalone SAR Estimation

When standalone SAR test exclusion applies to an antenna that transmits simultaneously with other antennas, the standalone SAR must be estimated according to following to determine simultaneous transmission SAR test exclusion:

$[(\text{max. power of channel, including tune-up tolerance, mW}) / (\text{min. test separation distance, mm})] \cdot$

$[\sqrt{f_{\text{GHz}} / 7.5}] \text{ W/kg for 1 g SAR, test separation distances} \leq 50 \text{ mm, or}$

$0.4 \text{ W/kg for 1 g SAR, test separation distances} > 50 \text{ mm}$

When the minimum test separation distance is < 5 mm, a distance of 5 mm is applied.

Band	Frequency (MHz)	Max. Power		Test Position	Distance (mm)	Estimated SAR (W/kg)
		(dBm)	(mW)			
Bluetooth	2480	7.7	6	Head	< 5	0.252
				Body	10	0.126

14.4.3 Sum of the SAR for PCS 1900, WLAN & Bluetooth

RF Exposure Conditions	Simultaneous Transmission Scenario				Σ 1 g SAR (W/kg)
	PCS 1900	DTS	U-NII	Bluetooth	
Head	0.382	0.180			0.562
	0.382			0.252	0.634
Body-worn	0.474	0.192			0.666
	0.474			0.126	0.600
Hotspot	0.474	0.227			0.701

SAR to Peak Location Separation Ratio (SPLSR)

As the sum of the 1 g SAR is < 1.6 W/kg, SPLSR assessment is not required.

Conclusion:

Simultaneous transmission SAR measurement (Volume Scan) is not required because the sum of the 1 g SAR is < 1.6 W/kg.

16 Test Instruments

Shielded Room S3				
Type	Model	Serial No. (ID)	Manufacturer	Cal. Due
E-Field Probe	EX3DV4	7372	SPEAG	2017/03/14
DAE	DAE4	508 (S-3)	SPEAG	2016/11/22
Robot	RX60L	F02/5R10A1/A/01 (S-7)	Stäubli	N/A
Probe Alignment Unit	LB5/80	SE UKS 030 AA (S-13)	SPEAG	N/A
Network Analyzer	8719ET	MY42000159 (B-53)	Agilent	2016/08/04
Dielectric Probe	DAK-3.5	1079	SPEAG	2017/04/11
Dielectric Probe	DAK-3.5	1124 (S-32)	SPEAG	2017/07/11
1900MHz Dipole	D1900V2	5d129	SPEAG	2017/05/05
2450MHz Dipole	D2450V2	714 (S-6)	SPEAG	2016/11/09
Signal Generator	MG3681A	6100216166 (B-3)	Anritsu	2016/08/12
RF Power Amplifier	CGA020M602-2633R	B10840 (A-51)	R&K	N/A
Directional Coupler	4226-20	03736 (D-87)	Narda Microwave	N/A
Base Station Simulator	MT8820C	6200918329 (B-5)	Anritsu	2017/02/22
Power Meter	E4417A	GB41290850 (B-51)	Agilent	2017/06/21
Power Sensor	E9323A	US40411939 (B-59)	Agilent	2017/06/21
Power Meter	N1911A	GB45100291 (B-63)	Agilent	2017/07/10
Power Sensor	N1921A	US44510470 (B-64)	Agilent	2017/07/10
Attenuator	54A-10	W5675 (D-28)	Weinschel	2016/08/16
Attenuator	2-20	BY7535 (D-36)	Weinschel	2016/10/12

NOTE : The calibration interval of the above test instruments is 12 months.

17 Appendix

Refer to separated files for the following appendixes.

Appendix 1 – System Performance Check Plots

Appendix 2 – Highest SAR Test Plots

Appendix 3 – Dosimetric E-Field Probe Calibration Data

Appendix 4 – System Validation Dipole Calibration Data