

TEST REPORT (SAR EVALUATION)

Applicant : Sharp Corporation, Communication Systems Division
Address : 2-13-1, Iida, Hachihonmatsu, Higashi-Hiroshima City, Hiroshima,
739-0192, Japan

Products : Smart Phone
Model No. : 502SH
Serial No. : 004401/11/553746/2
FCC ID : APYHRO00226

Test Standard : FCC Rules and Regulations Title 47 CFR Part 2

Test Results : **Passed**

Date of Test : September 7 ~ 22, 2015



Kousei Shibata
Manager
Japan Quality Assurance Organization
KITA-KANSAI Testing Center
SAITO EMC Branch
7-3-10, Saito-asagi, Ibaraki-shi, Osaka 567-0085, Japan

-
- The measurement values stated in Test Report was made with traceable to National Institute of Advanced Industrial Science and Technology (AIST) of Japan, National Institute of Information and Communications Technology (NICT) of Japan , and Laboratory for EMF and Microwave Electronics at the Swiss Federal Institute of Technology (ETH) in Zürich, Switzerland.
 - The applicable standard, testing condition and testing method which were used for the tests are based on the request of the applicant.
 - The test results presented in this report relate only to the offered test sample.
 - The contents of this test report cannot be used for the purposes, such as advertisement for consumers.
 - This test report shall not be reproduced except in full without the written approval of JQA.
 - VLAC does not approve, certify or warrant the product by this test report.

TABLE OF CONTENTS

	Page
1 Description of the Device Under Test (DUT)	3
2 Summary of Test Results	7
3 Test Procedure.....	8
4 Test Location	8
5 Recognition of Test Laboratory	8
6 Measurement System Diagram.....	9
7 System Components	10
8 Measurement Process.....	13
9 Measurement Uncertainties.....	14
10 Test Arrangement	16
11 Tissue Verification.....	20
12 System Performance Check.....	25
13 RF Output Power Measurements.....	27
14 SAR Measurements	41
15 Test Setup Photographs	61
16 Test Instruments.....	66
17 Appendix.....	67

1 Description of the Device Under Test (DUT)

1.1 General Information

1. Manufacturer : Sharp Corporation, Communication Systems Division
2-13-1, Iida, Hachihonmatsu, Higashi-Hiroshima City, Hiroshima,
739-0192, Japan
2. Products : Smart Phone
3. Model No. : 502SH
4. Serial No. : 004401/11/553746/2
5. Product Type : Pre-production
6. Date of Manufacture : July, 2015
7. Transmitting Frequency : GSM 850 (824 MHz – 849 MHz)
PCS 1900 (1850 MHz – 1910 MHz)
W-CDMA Band II (1850 MHz – 1910 MHz)
W-CDMA Band IV (1710 MHz – 1755 MHz)
LTE Band 2 (1850 MHz – 1910 MHz)
LTE Band 4 (1710 MHz – 1755 MHz)
WLAN 2.4 GHz (DTS : 2412 MHz – 2462 MHz)
WLAN 5 GHz (U-NII 1 : 5150 MHz – 5250 MHz)
WLAN 5 GHz (U-NII 2A : 5250 MHz – 5350 MHz)
WLAN 5 GHz (U-NII 2C : 5470 MHz – 5725 MHz)
Bluetooth (2402 MHz – 2480 MHz)
8. Battery Option : Lithium-ion Battery Pack LIS1613SPPC(SY6) (3100mAh)
9. Power Rating : 4.0VDC
10. DUT Grounding : None
11. Device Category : Portable Device (§2.1093)
12. Exposure Category : General Population/Uncontrolled Exposure
13. FCC Rule Part(s) : 22(H), 24(E), 27(L), 15.247, 15.407
14. DUT Authorization : Certification
15. Received Date of DUT : September 3, 2015

1.2 Wireless Technologies

Air Interface	Description	
GSM	Frequency band(s)	850, 1900
	Operating mode	GSM (GMSK) GPRS (GMSK)
	GPRS Multi-Slot Class	Class 12 – Four Up
	VoIP	Supported
	DTM (Dual Transfer Mode)	Not supported
W-CDMA	Frequency band(s)	Band II, IV
	Operating mode	UMTS Rel.99 (Voice & Data) HSDPA Rel.8 HSUPA Rel.8
	VoIP	Supported
LTE (FDD)	Frequency band(s)	Band 2, 4
	Operating mode	QPSK 16QAM
	VoLTE	Supported
	Carrier Aggregation	Not supported
WLAN (DTS)	Frequency band(s)	2.4 GHz
	Operating mode	802.11b 802.11g 802.11n [HT20]
	VoIP	Supported
	Wireless Router (Hotspot)	Supported
	Wi-Fi Direct	Supported
	Tx Diversity Configuration	1Tx (ANT 0 only) 2Tx CDD (802.11b/g) 2Tx MIMO (802.11n)
WLAN (U-NII)	Frequency band(s)	5 GHz
	Operating mode	802.11a 802.11n [HT20] 802.11n [HT40] 802.11ac [VHT20] 802.11ac [VHT40] 802.11ac [VHT80]
	VoIP	Supported
	Wireless Router (Hotspot)	Not supported
	Wi-Fi Direct	Not supported
	TDWR (Terminal Doppler Weather Rader)	Supported
	Band gap channel	Not supported
	Tx Diversity Configuration	2Tx CDD (802.11a) 2Tx MIMO (802.11n/ac)
Bluetooth	Frequency band(s)	2.4 GHz
	Operating mode	Version 4.0+EDR Version 4.0 LE

1.3 Maximum Output Power

Mode		Max. Tune-up Limit (dBm)
GSM 850	Voice	33.3
	GPRS 1 slot	33.3
	GPRS 2 slots	31.0
	GPRS 3 slots	29.3
	GPRS 4 slots	28.5
PCS 1900	Voice	30.3
	GPRS 1 slot	30.3
	GPRS 2 slots	28.0
	GPRS 3 slots	26.0
	GPRS 4 slots	25.1
W-CDMA Band II	Rel. 99	23.5
	HSDPA	23.3
	HSUPA	23.3
W-CDMA Band IV	Rel. 99	23.2
	HSDPA	23.0
	HSUPA	23.0
LTE Band 2	QPSK	23.5
LTE Band 4	QPSK	23.2

Mode		Max. Tune-up Limit (dBm)	
		ANT 0	ANT 1
WLAN 2.4 GHz (DTS)	802.11b	12.5	12.5
	802.11g	10.5	10.5
	802.11n HT20	10.5	10.5
WLAN 5 GHz (U-NII)	802.11a	12.5	12.5
	802.11n HT20	11.5	11.5
	802.11n HT40	11.5	11.5
	802.11ac VHT20	11.5	11.5
	802.11ac VHT40	11.5	11.5
	802.11ac VHT80	11.5	11.5

Mode		Max. Tune-up Limit (dBm)
Bluetooth		7.5
Bluetooth LE		7.5

1.4 General LTE SAR Test and Reporting Considerations

Item	Description																																						
Frequency range and channel bandwidth	LTE Band 2 (1850 MHz – 1910 MHz)																																						
	Bandwidth	Low	Mid	High																																			
	1.4 MHz	18607 ch 1850.7 MHz	18900 ch 1880.0 MHz	19193 ch 1909.3 MHz																																			
	3 MHz	18615 ch 1851.5 MHz	18900 ch 1880.0 MHz	19185 ch 1908.5 MHz																																			
	5 MHz	18625 ch 1852.5 MHz	18900 ch 1880.0 MHz	19175 ch 1907.5 MHz																																			
	10 MHz	18650 ch 1855.0 MHz	18900 ch 1880.0 MHz	19150 ch 1905.0 MHz																																			
	15 MHz	18675 ch 1857.5 MHz	18900 ch 1880.0 MHz	19125 ch 1902.5 MHz																																			
	20 MHz	18700 ch 1860.0 MHz	18900 ch 1880.0 MHz	19100 ch 1900.0 MHz																																			
	LTE Band 4 (1710 MHz – 1755 MHz)																																						
	Bandwidth	Low	Mid	High																																			
	1.4 MHz	19957 ch 1710.7 MHz	20175 ch 1732.5 MHz	20393 ch 1754.3 MHz																																			
	3 MHz	19965 ch 1711.5 MHz	20175 ch 1732.5 MHz	20385 ch 1753.5 MHz																																			
	5 MHz	19975 ch 1712.5 MHz	20175 ch 1732.5 MHz	20375 ch 1752.5 MHz																																			
	10 MHz	20000 ch 1715.0 MHz	20175 ch 1732.5 MHz	20350 ch 1750.0 MHz																																			
	15 MHz	20025 ch 1717.5 MHz	20175 ch 1732.5 MHz	20325 ch 1747.5 MHz																																			
	20 MHz	20050 ch 1720.0 MHz	20175 ch 1732.5 MHz	20300 ch 1745.0 MHz																																			
	LTE transmitter and antenna implementation	LTE has one (1) Tx/Rx antenna and one (1) RX antenna.																																					
	Maximum power reduction (MPR)	<p style="text-align: center;">Table 6.2.3-1: Maximum Power Reduction (MPR) for Power Class 1 and 3</p> <table border="1" style="width: 100%; border-collapse: collapse;"> <thead> <tr> <th rowspan="2">Modulation</th> <th colspan="6">Channel bandwidth / Transmission bandwidth (N_{RB})</th> <th rowspan="2">MPR (dB)</th> </tr> <tr> <th>1.4 MHz</th> <th>3.0 MHz</th> <th>5 MHz</th> <th>10 MHz</th> <th>15 MHz</th> <th>20 MHz</th> </tr> </thead> <tbody> <tr> <td>QPSK</td> <td>> 5</td> <td>> 4</td> <td>> 8</td> <td>> 12</td> <td>> 16</td> <td>> 18</td> <td>≤ 1</td> </tr> <tr> <td>16 QAM</td> <td>≤ 5</td> <td>≤ 4</td> <td>≤ 8</td> <td>≤ 12</td> <td>≤ 16</td> <td>≤ 18</td> <td>≤ 1</td> </tr> <tr> <td>16 QAM</td> <td>> 5</td> <td>> 4</td> <td>> 8</td> <td>> 12</td> <td>> 16</td> <td>> 18</td> <td>≤ 2</td> </tr> </tbody> </table> <p>MPR Built-in by design A-MPR (additional MPR) was disabled during SAR testing.</p>	Modulation	Channel bandwidth / Transmission bandwidth (N _{RB})						MPR (dB)	1.4 MHz	3.0 MHz	5 MHz	10 MHz	15 MHz	20 MHz	QPSK	> 5	> 4	> 8	> 12	> 16	> 18	≤ 1	16 QAM	≤ 5	≤ 4	≤ 8	≤ 12	≤ 16	≤ 18	≤ 1	16 QAM	> 5	> 4	> 8	> 12	> 16	> 18
Modulation	Channel bandwidth / Transmission bandwidth (N _{RB})						MPR (dB)																																
	1.4 MHz	3.0 MHz	5 MHz	10 MHz	15 MHz	20 MHz																																	
QPSK	> 5	> 4	> 8	> 12	> 16	> 18	≤ 1																																
16 QAM	≤ 5	≤ 4	≤ 8	≤ 12	≤ 16	≤ 18	≤ 1																																
16 QAM	> 5	> 4	> 8	> 12	> 16	> 18	≤ 2																																
Power reduction	No																																						
Spectrum plots for RB configurations	A properly configured base station simulator was used for the SAR and power measurements; therefore, spectrum plots for each RB allocation and offset configuration are not included in the SAR report.																																						

2 Summary of Test Results

Applied Standard : FCC Rules and Regulations Title 47 CFR Part 2 – Frequency Allocations and Radio Treaty Matters; General Rules and Regulations
§2.1093 Radiofrequency radiation exposure evaluation: portable devices

Test Configuration	Reported 1 g SAR (W/kg)			Limit (W/kg)
	Licensed	DTS	U-NII	
Head	0.20	< 0.10	< 0.10	1.6
Body-worn Accessory	1.18	0.67	0.13	
Wireless Router (Hotspot)	1.18	0.67	N/A	
Simultaneous Transmission	1.44	1.44	1.20	

The test results are **passed** for exposure limits specified in ANSI/IEEE Std. C95.1.

In the approval of test results,

- Determining compliance with the limits in this report was based on the results of the compliance measurement, not taking into account measurement instrumentation uncertainty.
- No deviations were employed from the applied standard.
- No modifications were conducted by JQA to achieve compliance to the limitations.

Reviewed by:

Tested by:



Shigeru Kinoshita
Assistant Manager
JQA KITA-KANSAI Testing Center
SAITO EMC Branch



Yasuhisa Sakai
Manager
JQA KITA-KANSAI Testing Center
SAITO EMC Branch

3 Test Procedure

The tests documented in this report were performed in accordance with FCC 47 CFR §2.1093, IEEE Std.1528–2013 and the following KDB Procedures.

- # 248227 D01 802.11 Wi-Fi SAR v02r01
- # 447498 D01 General RF Exposure Guidance v05r02
- # 648474 D04 SAR Handset SAR v01r02
- # 865664 D01 SAR Measurement 100 MHz to 6 GHz v01r04
- # 865664 D02 RF Exposure Reporting v01r01
- # 941225 D01 3G SAR Procedures v03
- # 941225 D05 SAR for LTE Devices v02r03
- # 941225 D06 Hot Spot SAR v02

4 Test Location

Japan Quality Assurance Organization (JQA)
KITA-KANSAI Testing Center
7-7, Ishimaru, 1-chome, Minoh-shi, Osaka, 562-0027, Japan
SAITO EMC Branch
7-3-10, Saito-asagi, Ibaraki-shi, Osaka 567-0085, Japan

5 Recognition of Test Laboratory

JQA KITA-KANSAI Testing Center SAITO EMC Branch is accredited under ISO/IEC 17025 by following accreditation bodies and the test facility is registered by the following bodies.

- VLAC Accreditation No. : VLAC-001-2 (Expiry date : March 30, 2016)
- VCCI Registration No. : A-0002 (Expiry date : March 30, 2016)
- BSMI Registration No. : SL2-IS-E-6006, SL2-IN-E-6006, SL2-R1/R2-E-6006, SL2-A1-E-6006
(Expiry date : September 14, 2016)
- IC Registration No. : 2079E-3, 2079E-4 (Expiry date : July 16, 2017)

Accredited as conformity assessment body for Japan electrical appliances and material law by METI.
(Expiry date : February 22, 2016)

6 Measurement System Diagram

These measurements are performed using the DASY5 automated dosimetric assessment system (manufactured by Schmid & Partner Engineering AG (SPEAG) in Zürich, Switzerland). It consists of high precision robotics system, cell controller system, DASY5 measurement server, personal computer with DASY5 software, data acquisition electronic (DAE) circuit, the Electro-optical converter (EOC), near-field probe, and the twin SAM phantom containing the equivalent tissue. The robot is a six-axis industrial robot performing precise movements to position the probe to the location (points) of maximum electromagnetic field (EMF).

The Robot is connected to the cell controller to allow software manipulation of the robot. The DAE is connected to the EOC. The DAE performs the signal amplification, signal multiplexing, A/D conversion, offset measurements, mechanical surface detection, collision detection, etc. The EOC performs the conversion from the optical into digital electric signal of the DAE and transfers data to the DASY5 measurement server.

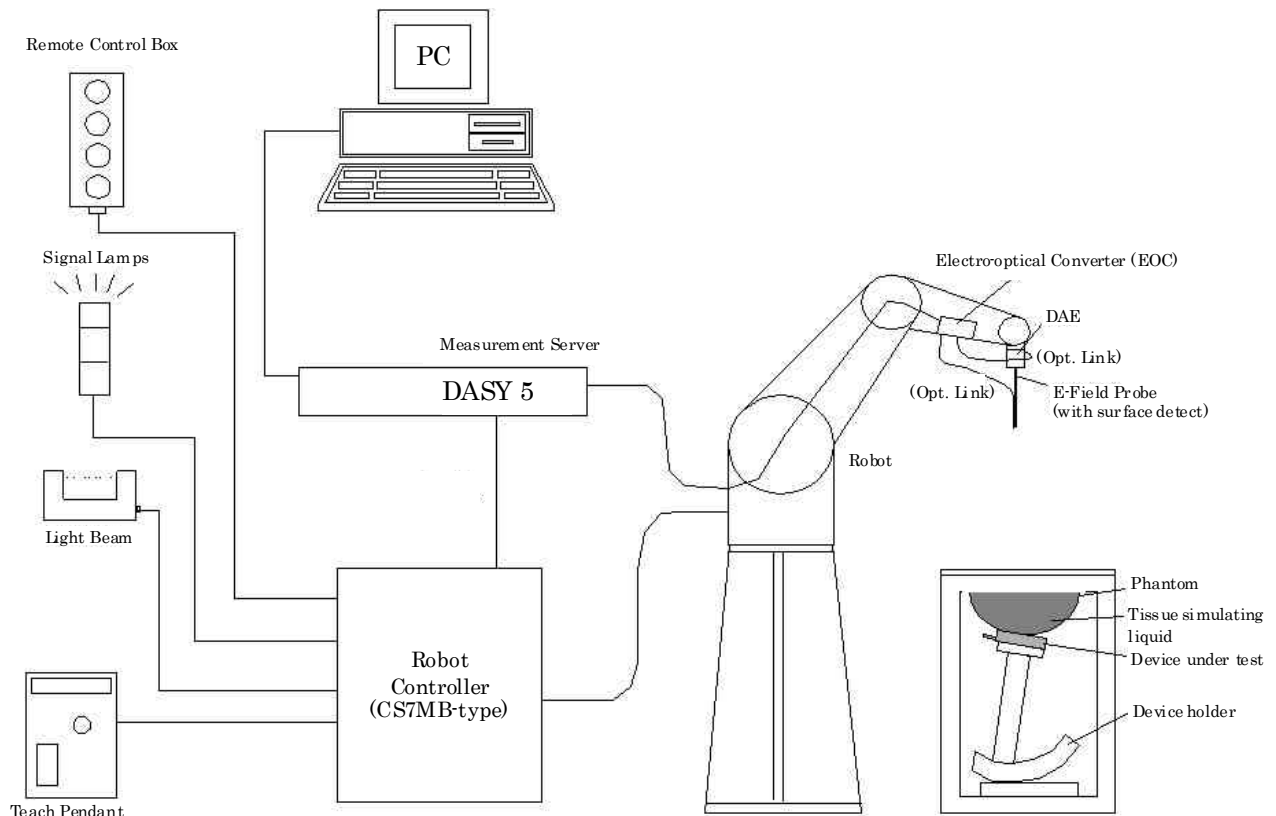

7 System Components

7.1 Probe Specification ET3DV6

Construction	: Symmetrical design with triangular core Built-in optical fiber for surface detection system Built-in shielding against static charges PEEK enclosure material (resistant to organic solvents, e.g., DGBE)	
Calibration	: In air form 10 MHz to 2.3 GHz In head tissue simulating liquid (HSL) and muscle tissue simulating liquid 835 MHz (accuracy $\pm 12.0\%$; $k=2$) 900 MHz (accuracy $\pm 12.0\%$; $k=2$) 1450 MHz (accuracy $\pm 12.0\%$; $k=2$) 1750 MHz (accuracy $\pm 12.0\%$; $k=2$) 1900 MHz (accuracy $\pm 12.0\%$; $k=2$) 1950 MHz (accuracy $\pm 12.0\%$; $k=2$)	
Frequency	: 10 MHz to 2.3 GHz Linearity: ± 0.2 dB (30 MHz to 2.3 GHz)	
Directivity	: ± 0.2 dB in HSL (rotation around probe axis) ± 0.4 dB in HSL (rotation normal to probe axis)	
Dynamic Range	: $5 \mu\text{W/g}$ to $>100 \text{ mW/g}$; Linearity: ± 0.2 dB	
Surface Detection	: ± 0.2 mm repeatability in air and clear liquids over diffuse reflecting surfaces	
Dimensions	: Overall length 337 mm Tip length 16 mm Body diameter 12 mm Tip diameter 6.8 mm Distance from probe tip to dipole centers 2.7 mm	

7.2 Probe Specification EX3DV4

Construction	: Symmetrical design with triangular core Built-in shielding against static charges PEEK enclosure material (resistant to organic solvents, e.g., DGBE)
Calibration	: In air form 10 MHz to 6 GHz In head tissue simulating liquid (HSL) and muscle tissue simulating liquid 2450 MHz (accuracy $\pm 12.0\%$; k=2) 2600 MHz (accuracy $\pm 12.0\%$; k=2) 5200 MHz (accuracy $\pm 13.1\%$; k=2) 5300 MHz (accuracy $\pm 13.1\%$; k=2) 5500 MHz (accuracy $\pm 13.1\%$; k=2) 5600 MHz (accuracy $\pm 13.1\%$; k=2) 5800 MHz (accuracy $\pm 13.1\%$; k=2)
Frequency	: 10 MHz to 6 GHz Linearity: ± 0.2 dB (30 MHz to 6 GHz)
Directivity	: ± 0.3 dB in HSL (rotation around probe axis) ± 0.5 dB in tissue material (rotation normal to probe axis)
Dynamic Range	: 10 μ W/g to >100 mW/g; Linearity: ± 0.2 dB (noise: typically < 1 μ W/g)
Dimensions	: Overall length 337 mm Tip length 20 mm Body diameter 12 mm Tip diameter 2.5 mm Distance from probe tip to dipole centers 1 mm



7.3 Twin SAM Phantom

The shell corresponds to the specifications of the Specific Anthropomorphic Mannequin (SAM) phantom defined in IEEE 1528 and IEC 62209-1. It enables the dosimetric evaluation of left and right hand phone usage as well as body mounted usage at the flat phantom region. A cover prevents evaporation of the liquid. Reference markings on the phantom allow the complete setup of all predefined phantom positions and measurement grids by teaching three points with the robot.



Shell Thickness : 2 ± 0.2 mm; Center ear point: 6 ± 0.2 mm
Filling Volume : Volume Approx. 25 liters
Dimensions : $810 \times 1000 \times 500$ mm (H \times L \times W)

7.4 ELI4 Flat Phantom

Phantom for compliance testing of handheld and body-mounted wireless devices in the frequency range of 30 MHz to 6 GHz. ELI is fully compatible with the IEC 62209-2 standard and all known tissue simulating liquids. ELI has been optimized regarding its performance and can be integrated into our standard phantom tables. A cover prevents evaporation of the liquid. Reference markings on the phantom allow installation of the complete setup, including all predefined phantom positions and measurement grids, by teaching three points. The phantom is compatible with all SPEAG dosimetric probes and dipoles.

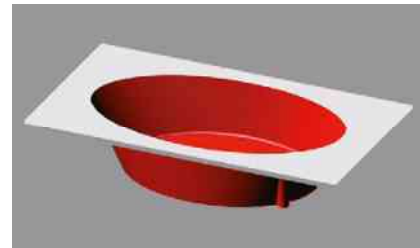

Shell Thickness : 2 ± 0.2 mm (sagging: <1%)
Filling Volume : Volume Approx. 30 liters
Dimensions : Major ellipse axis : 600 mm
Minor axis : 400 mm

7.5 Mounting Device for Transmitters

In combination with the Twin SAM Phantom V4.0/V4.0c or ELI4, the Mounting Device enables the rotation of the mounted transmitter device in spherical coordinates. Rotation point is the ear opening point. Transmitter devices can be easily and accurately positioned according to IEC, IEEE, CENELEC, FCC or other specifications. The device holder can be locked for positioning at different phantom sections (left head, right head, flat point).



8 Measurement Process

Step 1 : Power Reference Measurement

The power reference job measures the field at a specified reference position, at a selectable distance from the phantom surface. The reference position can be either the selected section's grid reference point or a user point in this section. The reference job projects the selected point onto the phantom surface, orients the probe perpendicularly to the surface, and approaches the surface using the selected detection method. The minimum distance of probe sensors to surface set to 4 mm for an ET3DV6 probe, or 2 mm for EX3DV4 probe. This distance cannot be smaller than the distance of sensor calibration points to probe tip as defined in the probe properties.

Step 2 : Area Scan

The area scan is used as a fast scan in two dimensions to find the area of high field values, before doing a fine measurement around the hot spot. The sophisticated interpolation routines implemented in DASY software can find the maximum locations in relatively coarse grids. When an area scan has measured all reachable points, it computes the field maximal found in the scanned area, within a range of the global maximum. If only one zoom scan follows the area scan, then only the absolute maximum will be taken as reference. For cases where multiple maxima within 2 dB of the maximum SAR value are detected, the number of zoom scans has to be increased accordingly.

Step 3 : Zoom Scan

Zoom scans are used to assess the peak spatial SAR values within a cubic averaging volume containing 1 g and 10 g of simulated tissue. The zoom scan measures points specified in standards within a cube whose base faces are centered on the maxima found in a preceding area scan job within the same procedure.

Step 4 : Z Scan

The Z scan measures points along a vertical straight line. The line runs along the Z axis of a one-dimensional grid. In order to get a reasonable extrapolation, the extrapolated distance should not be larger than the step size in Z-direction.

Step 5 : Power Drift Measurement

The power drift measurement measures the field at the same location as the most recent power reference measurement job within the same procedure, and with the same settings. The power drift measurement gives the field difference in dB from the reading conducted within the last power reference measurement. The power reference measurement and power drift measurement are for monitoring the power drift of the device under test in the batch process.

9 Measurement Uncertainties

9.1 300 MHz to 3 GHz

Uncertainty Component	Tol. (± %)	Prob. Dist.	Div.	c_i (1g)	c_i (10g)	Std. Unc. (± %)		ν_i
						1g	10g	
Measurement System								
Probe calibration	6.0	N	1	1	1	6.0	6.0	∞
Axial isotropy	4.7	R	$\sqrt{3}$	0.7	0.7	1.9	1.9	∞
Hemispherical isotropy	9.6	R	$\sqrt{3}$	0.7	0.7	3.9	3.9	∞
Boundary effects	1.0	R	$\sqrt{3}$	1	1	0.6	0.6	∞
Linearity	4.7	R	$\sqrt{3}$	1	1	2.7	2.7	∞
System detection limits	1.0	R	$\sqrt{3}$	1	1	0.6	0.6	∞
Modulation response	2.4	R	$\sqrt{3}$	1	1	1.4	1.4	∞
Readout electronics	0.3	N	1	1	1	0.3	0.3	∞
Response time	0.8	R	$\sqrt{3}$	1	1	0.5	0.5	∞
Integration time	2.6	R	$\sqrt{3}$	1	1	1.5	1.5	∞
RF ambient conditions – noise	3.0	R	$\sqrt{3}$	1	1	1.7	1.7	∞
RF ambient conditions – reflections	3.0	R	$\sqrt{3}$	1	1	1.7	1.7	∞
Probe positioner mechanical tolerance	0.4	R	$\sqrt{3}$	1	1	0.2	0.2	∞
Probe positioning with respect to phantom shell	2.9	R	$\sqrt{3}$	1	1	1.7	1.7	∞
Extrapolation, interpolation and integration algorithms for max. SAR evaluation	2.0	R	$\sqrt{3}$	1	1	1.2	1.2	∞
Test Sample Related								
Device holder uncertainty	2.9	N	1	1	1	2.9	2.9	5
Test sample positioning	3.4	N	1	1	1	3.4	3.4	23
Output power variation – SAR drift measurement	5.0	R	$\sqrt{3}$	1	1	2.9	2.9	∞
Power Scaling	0.0	R	$\sqrt{3}$	1	1	0.0	0.0	∞
Phantom and Tissue Parameters								
Phantom uncertainty	6.1	R	$\sqrt{3}$	1	1	3.5	3.5	∞
Algorithms for correcting SAR for deviations	1.9	R	$\sqrt{3}$	1	0.84	1.1	0.9	∞
Liquid Conductivity – measurement uncertainty	3.2	N	1	0.78	0.71	2.5	2.3	5
Liquid Permittivity – measurement uncertainty	3.0	N	1	0.26	0.26	0.8	0.8	5
Liquid Conductivity – temperature uncertainty	5.2	R	$\sqrt{3}$	0.78	0.71	2.3	2.1	∞
Liquid Permittivity – temperature uncertainty	0.8	R	$\sqrt{3}$	0.23	0.26	0.1	0.1	∞
Combined Standard Uncertainty						11.5	11.4	
Expanded Uncertainty (95% Confidence Interval)						22.9	22.7	
NOTES 1. Tol. : tolerance in influence quantity 2. Prob. Dist. : probability distributions 3. N, R : normal, rectangular 4. Div. : divisor used to obtain standard uncertainty 5. c_i : sensitivity coefficient 6. Std. Unc. : standard uncertainty 7. Measurement uncertainties are according to IEEE Std.1528 and IEC 62209-1.								

9.2 3 GHz to 6 GHz

Uncertainty Component	Tol. (± %)	Prob. Dist.	Div.	c_i (1g)	c_i (10g)	Std. Unc. (± %)		v_i
						1g	10g	
Measurement System								
Probe calibration	6.6	N	1	1	1	6.6	6.6	∞
Axial isotropy	4.7	R	√3	0.7	0.7	1.9	1.9	∞
Hemispherical isotropy	9.6	R	√3	0.7	0.7	3.9	3.9	∞
Boundary effects	2.0	R	√3	1	1	1.2	1.2	∞
Linearity	4.7	R	√3	1	1	2.7	2.7	∞
System detection limits	1.0	R	√3	1	1	0.6	0.6	∞
Modulation response	2.4	R	√3	1	1	1.4	1.4	∞
Readout electronics	0.3	N	1	1	1	0.3	0.3	∞
Response time	0.8	R	√3	1	1	0.5	0.5	∞
Integration time	2.6	R	√3	1	1	1.5	1.5	∞
RF ambient conditions – noise	3.0	R	√3	1	1	1.7	1.7	∞
RF ambient conditions – reflections	3.0	R	√3	1	1	1.7	1.7	∞
Probe positioner mechanical tolerance	0.8	R	√3	1	1	0.5	0.5	∞
Probe positioning with respect to phantom shell	6.7	R	√3	1	1	3.9	3.9	∞
Extrapolation, interpolation and integration algorithms for max. SAR evaluation	4.0	R	√3	1	1	2.3	2.3	∞
Test Sample Related								
Device holder uncertainty	2.9	N	1	1	1	2.9	2.9	5
Test sample positioning	3.4	N	1	1	1	3.4	3.4	23
Output power variation – SAR drift measurement	5.0	R	√3	1	1	2.9	2.9	∞
Power Scaling	0.0	R	√3	1	1	0.0	0.0	∞
Phantom and Tissue Parameters								
Phantom uncertainty	6.6	R	√3	1	1	3.8	3.8	∞
Algorithms for correcting SAR for deviations	1.9	R	√3	1	0.84	1.1	0.9	∞
Liquid Conductivity – measurement uncertainty	3.2	N	1	0.78	0.71	2.5	2.3	5
Liquid Permittivity – measurement uncertainty	3.0	N	1	0.26	0.26	0.8	0.8	5
Liquid Conductivity – temperature uncertainty	3.4	R	√3	0.78	0.71	1.5	1.4	∞
Liquid Permittivity – temperature uncertainty	0.4	R	√3	0.23	0.26	0.1	0.1	∞
Combined Standard Uncertainty			RSS			12.5	12.4	
Expanded Uncertainty (95% Confidence Interval)			k=2			24.9	24.8	
NOTES 1. Tol. : tolerance in influence quantity 2. Prob. Dist. : probability distributions 3. N, R : normal, rectangular 4. Div. : divisor used to obtain standard uncertainty 5. c_i : sensitivity coefficient 6. Std. Unc. : standard uncertainty 7. Measurement uncertainties are according to IEEE Std.1528 and IEC 62209-1.								

10 Test Arrangement

10.1 Head Exposure Conditions

10.1.1 Cheek-Touch Position

1. Position the device with the vertical center line of the body of the device and the horizontal line crossing the center of the ear piece in a plane parallel to the sagittal plane of the phantom.
2. While maintaining the device in this plane, align the vertical center line with the reference plane containing the three ear and mouth reference points (M, RE and LE) and align the center of the ear piece with the line RE-LE.
3. Translate the mobile phone box towards the phantom with the ear piece aligned with the line RE-LE until the phone touches the ear.
4. While maintaining the device in the reference plane and maintaining the phone contact with the ear, move the bottom of the box until any point on the front side is in contact with the cheek of the phantom or until contact with the ear is lost.

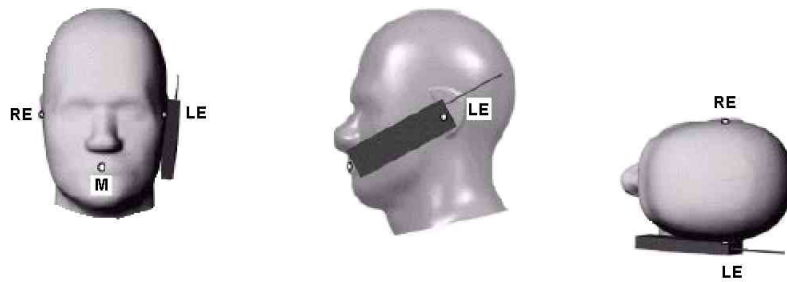
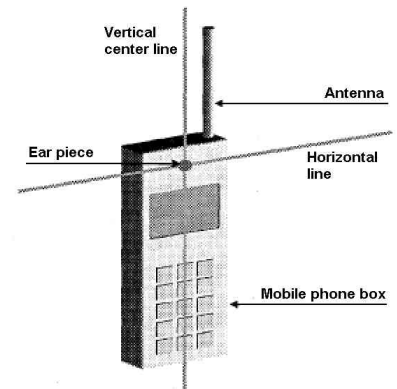

10.1.2 Ear-Tilt Position

1. Position the device in the “Cheek-Touch Position”.
2. While maintaining the device in the reference plane and pivoting against the ear, move it outward away from the mouth by an angle of 15 degrees or until contact with the ear is lost.

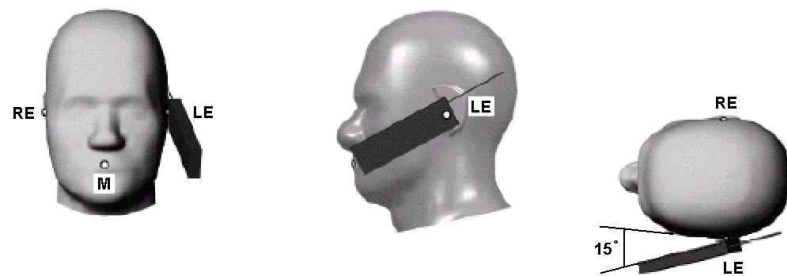

10.2 Body-worn Accessory Exposure Conditions

Body-worn operating configurations should be tested with the belt-clips and holsters attached to the device and positioned against a flat phantom in normal use configurations. Both the physical spacing to the body of the user as dictated by the accessory and the materials used in an accessory affect the SAR produced by the transmitting device. For purpose of determining test requirements, accessories may be divided into two categories: those that do not contain metallic components and those that do.

When multiple accessories that do not contain metallic components are supplied with the device, the device may be tested with only the accessory that dictates the closest spacing to the body. When multiple accessories that contain metallic components are supplied with the device, the device must be tested with each accessory that contains a unique metallic component. If multiple accessories share an identical metallic component (e.g., the same metallic belt-clip used with different holsters with no other metallic components), only the accessory that dictates the closest spacing to the body must be tested.

Body-worn accessories may not always be supplied or available as options for some devices that are intended to be authorized for body-worn use. A separation distance of 1.5 cm between the surface of the device and a flat phantom is recommended for testing body-worn SAR compliance under such circumstances. Other separation distances may be used, but they should not exceed 2.5 cm. In these cases, the device may use body-worn accessories that provide a separation distance greater than that tested for the device provided however that the accessory contains no metallic components.

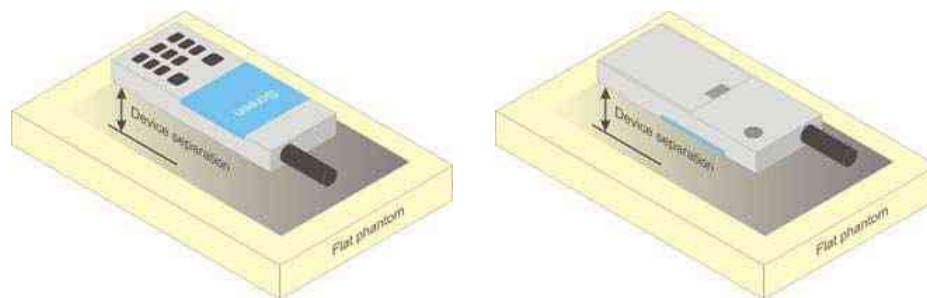

10.3 Hotspot Mode Exposure Conditions

For cell phones that support hotspot mode operations, with wireless router capabilities and various web browsing functions, the relevant hand and body exposure conditions are tested according to the hotspot SAR procedures in KDB 941225. A test separation distance of 10 mm is required between the phantom and all surfaces and edges with a transmitting antenna located within 25 mm from that surface or edge. When the form factor of a handset is smaller than 9 cm × 5 cm, a test separation distance of 5 mm (instead of 10 mm) is required for testing hotspot mode. When the separation distance required for body-worn accessory testing is larger than or equal to that tested for hotspot mode, in the same wireless mode and for the same surface of the phone, the hotspot mode SAR data may be used to support body-worn accessory SAR compliance for that particular configuration (surface).

10.4 RF Exposure Conditions

Handsets are tested for SAR compliance in head, body-worn accessory and other use configurations according to the procedures described in KDB 648474 D04.

RF Exposure Conditions	DUT-to-User Separation	Wireless Technologies	Test Position	Antenna-to-edge/surface	SAR Required	Note	
Head	0 mm	All Tx	Left Touch	N/A	YES		
			Left Tilt (15°)	N/A	YES		
			Right Touch	N/A	YES		
			Right Tilt (15°)	N/A	YES		
Body-worn	10 mm	All Tx	Rear	N/A	YES		
			Front	N/A	YES		
Hotspot	10 mm	GSM W-CDMA LTE	Rear	< 25 mm	YES		
			Front	< 25 mm	YES		
			Edge 1 (Top)	> 25 mm	NO	1	
			Edge 2 (Right)	< 25 mm	YES		
			Edge 3 (Bottom)	< 25 mm	YES		
			Edge 4 (Left)	< 25 mm	YES		
		WLAN Bluetooth (ANT 0)	Rear	< 25 mm	YES		
			Front	< 25 mm	YES		
			Edge 1 (Top)	< 25 mm	YES		
			Edge 2 (Right)	< 25 mm	YES		
			Edge 3 (Bottom)	> 25 mm	NO	1	
			Edge 4 (Left)	> 25 mm	NO	1	
			WLAN (ANT 1)	Rear	< 25 mm	YES	
				Front	< 25 mm	YES	
		Edge 1 (Top)		< 25 mm	YES		
		Edge 2 (Right)		> 25 mm	NO	1	
Edge 3 (Bottom)	> 25 mm	NO		1			
Edge 4 (Left)	< 25 mm	YES					

Note(s):

1. SAR is not required because the distance from the antenna to the edge is > 25 mm as per KDB 941225 D06.

Antenna Location and Separation Distances

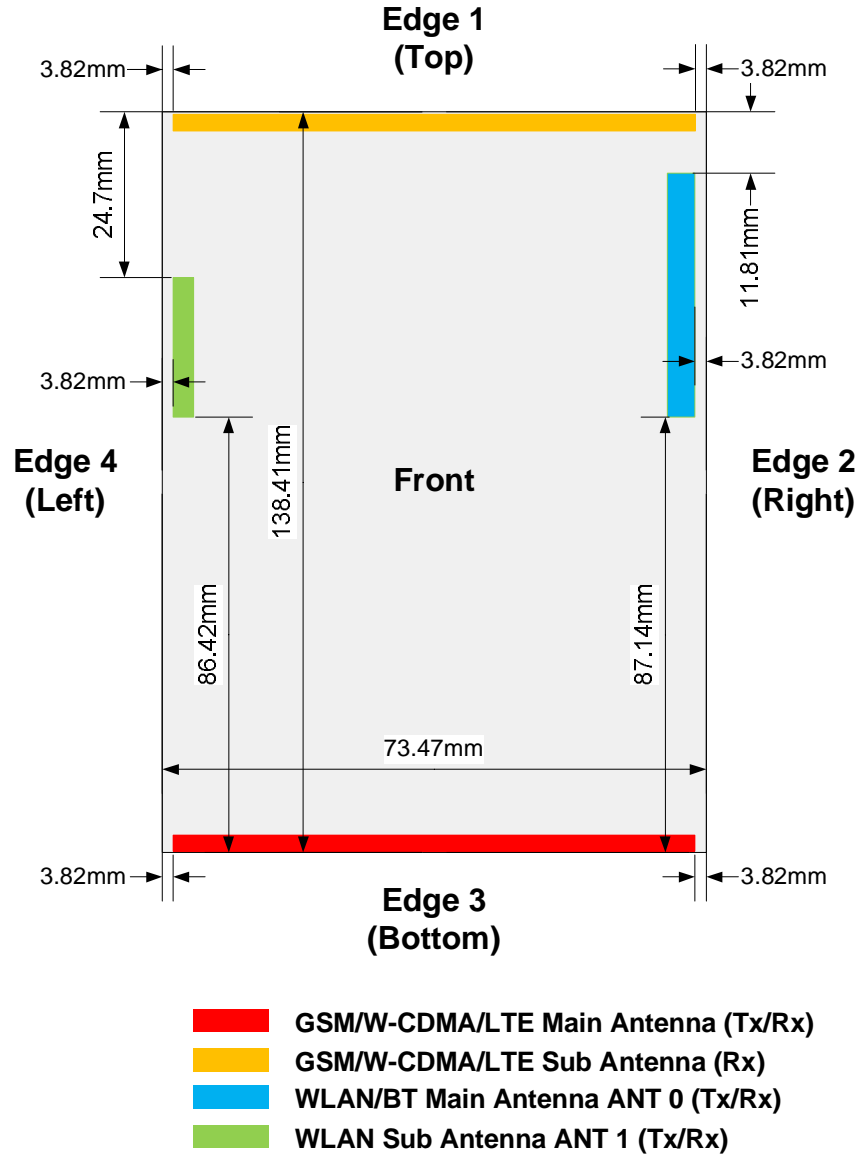

11 Tissue Verification

11.1 Tissue Verification Measurement Condition

The tissue dielectric parameters must be measured before the tissue-equivalent medium is used in a series of SAR measurements. The parameters should be re-measured after each 3 – 4 days of use, or earlier if dielectric parameters can become out of tolerance; for example, when the parameters are marginal at the beginning of the measurement series.

The temperature of the tissue-equivalent medium used during measurement must be within 18°C to 25°C and within ± 2°C of the temperature when the tissue parameters are characterized.

It is verified by using the dielectric probe and the network analyzer.

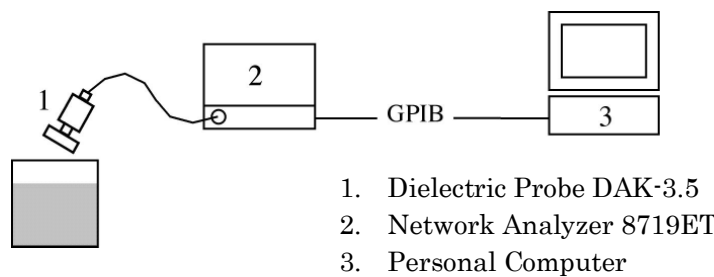

11.2 Tissue Dielectric Properties

The tissue dielectric properties are specified in KDB 865664 D01.

Target Frequency [MHz]	Head		Body	
	Permittivity (ϵ_r)	Conductivity (σ)	Permittivity (ϵ_r)	Conductivity (σ)
150	52.3	0.76	61.9	0.80
300	45.3	0.87	58.2	0.92
450	43.5	0.87	56.7	0.94
835	41.5	0.90	55.2	0.97
900	41.5	0.97	55.0	1.05
915	41.5	0.98	55.0	1.06
1450	40.5	1.20	54.0	1.30
1610	40.3	1.29	53.8	1.40
1800 – 2000	40.0	1.40	53.3	1.52
2450	39.2	1.80	52.7	1.95
3000	38.5	2.40	52.0	2.73
5800	35.3	5.27	48.2	6.00

For tissue dielectric properties at other frequencies within the range, a linear interpolation method shall be used.

11.3 Composition of Ingredients for the Tissue Material Used in the SAR Tests

The following tissue formulations are provided for reference only as some of the parameters have not been thoroughly verified. The composition of ingredients may be modified accordingly to achieve the desired target tissue parameters required for routine SAR evaluation.

Head and Body Liquids (Below 1 GHz)

Item	Head and Muscle Tissue Simulation Liquids HSL/MSL 750, HSL/MSL 900
H ₂ O	Water, 35 – 58 %
Sucrose	Sugar, white, refined, 40 – 60 %
NaCl	Sodium Chloride, 0 – 6 %
Hydroxyethyl-cellulose	Medium Viscosity (CAS# 9004-62-0), < 0.3 %
Preventol-D7	Preservative: aqueous preparation, (CAS# 55965-84-9), containing 5-chloro-2-methyl-3(2H)-isothiazolone and 2-methyyl-3(2H)-isothiazolone, 0.1 – 0.7 %

Head and Body Liquids (1 to 3 GHz)

Item	Head and Muscle Tissue Simulation Liquids HSL/MSL 1750, HSL/MSL 1900, HSL/MSL 2450
H ₂ O	Water, 52 – 75 %
C ₈ H ₁₈ O ₃	Diethylene glycol monobutyl ether (DGBE), 25 – 48% (CAS-No. 112-34-5, EC-No. 203-961-6, EC-index-No. 603-096-00-8)
NaCl	Sodium Chloride, < 1.0 %

Head Liquids (3 to 6 GHz)

Item	Head Broad Band Tissue Simulation Liquids HBBL 3500-5800
Water	50 – 65 %
Mineral oil	10 – 30 %
Emulsifiers	8 – 25 %
Sodium salt	0 – 1.5 %
Safety relevant ingredients according to EU directives: EINECS-No 203-489-0 1.0 – 2.8 % 2-Methyl-pentane-2,4-diol (Hexylene Glycol): CAS-No 107-41-5 (Xi irritant, R36/38 irritant for eyes and skin)	

Body Liquids (3 to 6 GHz)

Item	Muscle Broad Band Tissue Simulation Liquids MBBL 3500-5800
Water	60 – 80 %
Esters, Emulsifiers, Inhibitors	20 – 40 %
Sodium salt	0 – 1.5 %
Safety relevant ingredients according to EU directives: none Safety relevant ingredients according to other directives: CAS-No 26399-02-0 10 – 28 % Oleic acid, alkylester	

11.4 Tissue Verification Results

Tissue dielectric parameters are measured at the low, middle and high frequency of each operating frequency range of the test device.

Date	Liquid	Frequency [MHz]	Parameters	Target	Measured	Deviation [%]	Limit [%]
9/7/2015	Body	1710	Permittivity (ϵ_r)	53.5	53.12	-0.71	± 5
			Conductivity (σ)	1.46	1.435	-1.71	± 5
		1750	Permittivity (ϵ_r)	53.4	52.99	-0.77	± 5
			Conductivity (σ)	1.49	1.483	-0.47	± 5
		1755	Permittivity (ϵ_r)	53.4	52.95	-0.84	± 5
			Conductivity (σ)	1.49	1.488	-0.13	± 5
9/8/2015	Body	1710	Permittivity (ϵ_r)	53.5	53.16	-0.64	± 5
			Conductivity (σ)	1.46	1.446	-0.96	± 5
		1750	Permittivity (ϵ_r)	53.4	53.02	-0.71	± 5
			Conductivity (σ)	1.49	1.493	+0.20	± 5
		1755	Permittivity (ϵ_r)	53.4	52.97	-0.81	± 5
			Conductivity (σ)	1.49	1.498	+0.54	± 5
9/8/2015	Body	1850	Permittivity (ϵ_r)	53.3	52.65	-1.22	± 5
			Conductivity (σ)	1.52	1.493	-1.78	± 5
		1900	Permittivity (ϵ_r)	53.3	52.46	-1.58	± 5
			Conductivity (σ)	1.52	1.552	+2.11	± 5
		1910	Permittivity (ϵ_r)	53.3	52.43	-1.63	± 5
			Conductivity (σ)	1.52	1.564	+2.89	± 5
9/9/2015	Body	1850	Permittivity (ϵ_r)	53.3	52.64	-1.24	± 5
			Conductivity (σ)	1.52	1.495	-1.64	± 5
		1900	Permittivity (ϵ_r)	53.3	52.50	-1.50	± 5
			Conductivity (σ)	1.52	1.554	+2.24	± 5
		1910	Permittivity (ϵ_r)	53.3	52.46	-1.58	± 5
			Conductivity (σ)	1.52	1.565	+2.96	± 5
9/10/2015	Head	1850	Permittivity (ϵ_r)	40.0	40.55	+1.37	± 5
			Conductivity (σ)	1.40	1.355	-3.21	± 5
		1900	Permittivity (ϵ_r)	40.0	40.37	+0.92	± 5
			Conductivity (σ)	1.40	1.410	+0.71	± 5
		1910	Permittivity (ϵ_r)	40.0	40.34	+0.85	± 5
			Conductivity (σ)	1.40	1.421	+1.50	± 5
9/11/2015	Head	1710	Permittivity (ϵ_r)	40.1	39.81	-0.72	± 5
			Conductivity (σ)	1.35	1.336	-1.04	± 5
		1750	Permittivity (ϵ_r)	40.1	39.62	-1.20	± 5
			Conductivity (σ)	1.37	1.377	+0.51	± 5
		1755	Permittivity (ϵ_r)	40.1	39.60	-1.25	± 5
			Conductivity (σ)	1.37	1.381	+0.80	± 5

Tissue Verification Results (continued)

Date	Liquid	Frequency [MHz]	Parameters	Target	Measured	Deviation [%]	Limit [%]
9/13/2015	Body	820	Permittivity (ϵ_r)	55.3	55.27	-0.05	± 5
			Conductivity (σ)	0.97	0.969	-0.10	± 5
		835	Permittivity (ϵ_r)	55.2	55.12	-0.14	± 5
			Conductivity (σ)	0.97	0.984	+1.44	± 5
		850	Permittivity (ϵ_r)	55.2	54.97	-0.42	± 5
			Conductivity (σ)	0.99	0.999	+0.91	± 5
9/14/2015	Head	820	Permittivity (ϵ_r)	41.6	42.49	+2.14	± 5
			Conductivity (σ)	0.90	0.895	-0.56	± 5
		835	Permittivity (ϵ_r)	41.5	42.23	+1.76	± 5
			Conductivity (σ)	0.90	0.910	+1.11	± 5
		850	Permittivity (ϵ_r)	41.5	41.97	+1.13	± 5
			Conductivity (σ)	0.92	0.923	+0.33	± 5
9/15/2015	Head	2410	Permittivity (ϵ_r)	39.3	39.65	+0.89	± 5
			Conductivity (σ)	1.76	1.815	+3.13	± 5
		2450	Permittivity (ϵ_r)	39.2	39.48	+0.71	± 5
			Conductivity (σ)	1.80	1.862	+3.44	± 5
		2475	Permittivity (ϵ_r)	39.2	39.38	+0.46	± 5
			Conductivity (σ)	1.83	1.892	+3.39	± 5
9/15/2015	Body	2410	Permittivity (ϵ_r)	52.8	52.74	-0.11	± 5
			Conductivity (σ)	1.91	1.901	-0.47	± 5
		2450	Permittivity (ϵ_r)	52.7	52.56	-0.27	± 5
			Conductivity (σ)	1.95	1.951	+0.05	± 5
		2475	Permittivity (ϵ_r)	52.7	52.46	-0.46	± 5
			Conductivity (σ)	1.99	1.991	+0.05	± 5
9/16/2015	Body	5180	Permittivity (ϵ_r)	49.0	48.46	-1.10	± 5
			Conductivity (σ)	5.28	5.378	+1.86	± 5
		5250	Permittivity (ϵ_r)	48.9	48.34	-1.15	± 5
			Conductivity (σ)	5.36	5.472	+2.09	± 5
		5320	Permittivity (ϵ_r)	48.9	48.22	-1.39	± 5
			Conductivity (σ)	5.44	5.568	+2.35	± 5
9/16/2015	Body	5500	Permittivity (ϵ_r)	48.6	47.94	-1.36	± 5
			Conductivity (σ)	5.65	5.798	+2.62	± 5
		5600	Permittivity (ϵ_r)	48.5	47.76	-1.53	± 5
			Conductivity (σ)	5.77	5.936	+2.88	± 5
		5700	Permittivity (ϵ_r)	48.3	47.61	-1.43	± 5
			Conductivity (σ)	5.88	6.075	+3.32	± 5

Tissue Verification Results (continued)

Date	Liquid	Frequency [MHz]	Parameters	Target	Measured	Deviation [%]	Limit [%]
9/17/2015	Head	5180	Permittivity (ϵ_r)	36.0	35.98	-0.06	± 5
			Conductivity (σ)	4.63	4.528	-2.20	± 5
		5250	Permittivity (ϵ_r)	35.9	35.90	+0.00	± 5
			Conductivity (σ)	4.71	4.598	-2.38	± 5
		5320	Permittivity (ϵ_r)	35.8	35.78	-0.06	± 5
			Conductivity (σ)	4.78	4.669	-2.32	± 5
9/18/2015	Head	5500	Permittivity (ϵ_r)	35.6	35.51	-0.25	± 5
			Conductivity (σ)	4.96	4.833	-2.56	± 5
		5600	Permittivity (ϵ_r)	35.5	35.34	-0.45	± 5
			Conductivity (σ)	5.07	4.937	-2.62	± 5
		5700	Permittivity (ϵ_r)	35.4	35.22	-0.51	± 5
			Conductivity (σ)	5.17	5.033	-2.65	± 5
9/22/2015	Body	1710	Permittivity (ϵ_r)	53.5	53.51	+0.02	± 5
			Conductivity (σ)	1.46	1.437	-1.58	± 5
		1750	Permittivity (ϵ_r)	53.4	53.37	-0.06	± 5
			Conductivity (σ)	1.49	1.480	-0.67	± 5
		1755	Permittivity (ϵ_r)	53.4	53.35	-0.09	± 5
			Conductivity (σ)	1.49	1.484	-0.40	± 5

12 System Performance Check

12.1 System Performance Check Measurement Condition

The power meter PM1 (including Attenuator) measures the forward power at the location of the validation dipole connector. The signal generator is adjusted for 250 mW (100 mW for 3 to 6 GHz) at the dipole connector and the power meter PM2 is read at that level. After connecting the cable to the dipole, the signal generator is readjusted for the same reading at power meter PM2.

The dipole antenna is matched to be used near flat phantom filled with tissue simulating solution. A specific distance holder is used in the positioning of the antenna to ensure correct spacing between the phantom and the dipole.

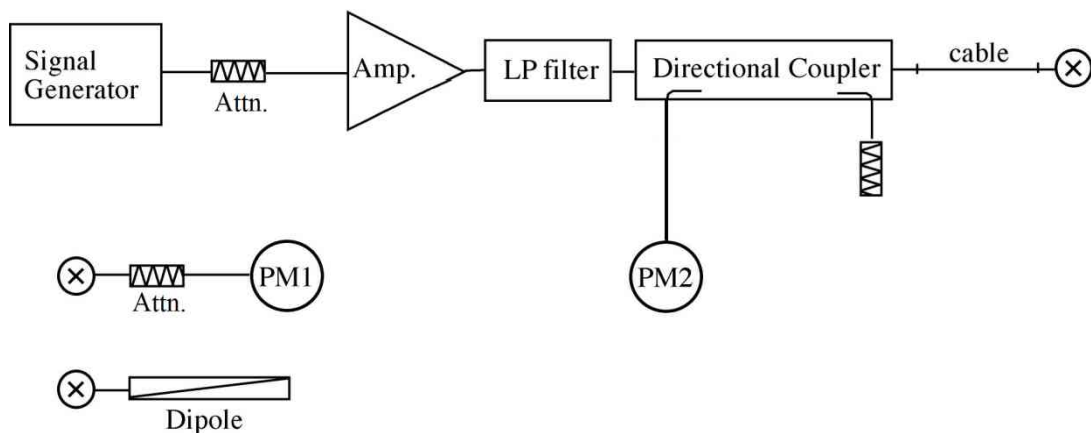

12.2 Target SAR Values for System Performance Check

The target SAR values can be obtained from the calibration certificate of system validation dipoles.

System Dipole		Cal. Date	Frequency [MHz]	Target SAR Values [W/kg]		
Type	Serial			1g/10g	Head	Body
D835V2	4d081	8/10/2015	835	1g	9.23	9.28
				10g	6.01	6.11
D1750V2	1012	8/11/2015	1750	1g	37.0	37.4
				10g	19.8	20.2
D1900V2	5d112	8/11/2015	1900	1g	41.1	40.4
				10g	21.5	21.6
D2450V2	714	11/13/2014	2450	1g	53.1	50.6
				10g	24.8	23.6
D5GHzV2	1092	11/12/2014	5250	1g	80.8	78.6
				10g	23.0	21.9
			5600	1g	84.9	83.6
				10g	24.1	23.2
			5750	1g	81.7	78.3
				10g	23.2	21.7

12.3 System Performance Check Results

The SAR measured with a system validation dipole, using the required tissue-equivalent medium at the test frequency, must be within 10 % of the manufacturer calibrated dipole SAR target.

Date	System Dipole		Liquid	Measured SAR [W/kg] (Normalized to 1 W)		Target	Deviation [%]	Limit [%]
	Type	Serial		1 g	10 g			
9/7/2015	D1750V2	1012	Body	1 g	36.24	37.4	-3.10	± 10
				10 g	20.12	20.2	-0.40	± 10
9/8/2015	D1750V2	1012	Body	1 g	36.92	37.4	-1.28	± 10
				10 g	20.52	20.2	+1.58	± 10
9/8/2015	D1900V2	5d112	Body	1 g	39.32	40.4	-2.67	± 10
				10 g	21.28	21.6	-1.48	± 10
9/9/2015	D1900V2	5d112	Body	1 g	39.76	40.4	-1.58	± 10
				10 g	21.32	21.6	-1.30	± 10
9/10/2015	D1900V2	5d112	Head	1 g	40.00	41.1	-2.68	± 10
				10 g	21.28	21.5	-1.02	± 10
9/11/2015	D1750V2	1012	Head	1 g	36.40	37.0	-1.62	± 10
				10 g	19.80	19.8	+0.00	± 10
9/13/2015	D835V2	4d081	Body	1 g	9.32	9.28	+0.43	± 10
				10 g	6.16	6.11	+0.82	± 10
9/14/2015	D835V2	4d081	Head	1 g	9.40	9.23	+1.84	± 10
				10 g	6.20	6.01	+3.16	± 10
9/15/2015	D2450V2	714	Head	1 g	53.60	53.1	+0.94	± 10
				10 g	24.84	24.8	+0.16	± 10
9/15/2015	D2450V2	714	Body	1 g	49.60	50.6	-1.98	± 10
				10 g	23.36	23.6	-1.02	± 10
9/16/2015	D5GHzV2 (5.25GHz)	1092	Body	1 g	75.90	78.6	-3.44	± 10
				10 g	21.40	21.9	-2.28	± 10
9/16/2015	D5GHzV2 (5.60GHz)	1092	Body	1 g	83.70	83.6	+0.12	± 10
				10 g	23.50	23.2	+1.29	± 10
9/17/2015	D5GHzV2 (5.25GHz)	1092	Head	1 g	77.80	80.8	-3.71	± 10
				10 g	22.20	23.0	-3.48	± 10
9/18/2015	D5GHzV2 (5.60GHz)	1092	Head	1 g	82.20	84.9	-3.18	± 10
				10 g	23.50	24.1	-2.49	± 10
9/22/2015	D1750V2	1012	Body	1 g	37.08	37.4	-0.86	± 10
				10 g	20.60	20.2	+1.98	± 10

13 RF Output Power Measurements

13.1 GSM

Settings	Mode	Parameter	
General Settings	Band Indicator	GSM 850	PCS 1900
	Power Control Level	5 (33 dBm)	0 (30 dBm)
GPRS Specific Settings	Connection Type	Test Mode A	
	Multi Slot Class	12 (4 down / 4 up / 5 sum)	
	Coding Scheme	CS1 (GMSK)	

GSM 850 Results

Mode		Conducted Average Power (dBm)						Sepc. Max. (Frame)
		128 ch (824.2 MHz)		189 ch (836.4 MHz)		251 ch (848.8 MHz)		
		Burst	Frame	Burst	Frame	Burst	Frame	
GSM	Voice	32.67	23.64	32.21	23.18	32.21	23.18	24.27
GPRS	1 slot	32.66	23.63	32.19	23.16	32.20	23.17	24.27
	2 slots	30.27	24.25	30.23	24.21	30.22	24.20	24.98
	3slots	28.03	23.77	28.04	23.78	28.03	23.77	25.04
	4 slots	27.57	24.56	27.53	24.52	27.52	24.51	25.49

Note(s):

KDB 941225 D01 – The worst-case configuration for SAR testing is determined to be as follows.

1. Body : GPRS mode with 4 time slots, based on the output power above
2. Head : Same mode as Body SAR testing (VoIP applicable using GPRS multi-slot)

PCS 1900 Results

Mode		Conducted Average Power (dBm)						Sepc. Max. (Frame)
		512 ch (1850.2 MHz)		661 ch (1880.0 MHz)		810 ch (1909.8 MHz)		
		Burst	Frame	Burst	Frame	Burst	Frame	
GSM	Voice	29.20	20.17	29.30	20.27	28.89	19.86	21.27
GPRS	1 slot	29.19	20.16	29.29	20.26	28.89	19.86	21.27
	2 slots	27.00	20.98	26.43	20.41	26.79	20.77	21.98
	3slots	24.59	20.33	24.84	20.58	24.85	20.59	21.74
	4 slots	24.42	21.41	24.55	21.54	23.98	20.97	22.09

Note(s):

KDB 941225 D01 – The worst-case configuration for SAR testing is determined to be as follows.

1. Body : GPRS mode with 4 time slots, based on the output power above
2. Head : Same mode as Body SAR testing (VoIP applicable using GPRS multi-slot)

13.2 W-CDMA

The following tests were completed according to the test requirements outlined in section 5.2 of the 3GPP TS34.121-1 specification.

Release 99 W-CDMA

Settings	Release 99	
Loopback Mode	Mode 1	OFF
Channel Coding	12.2kbps RMC	Voice AMR
TPC Bit Pattern	All 1	
Power Tolerance (dB)	+1.7/-3.7	

HSDPA

Settings	Release 8 HSDPA			
Sub-test	1	2	3	4
Loopback Mode	Mode 1			
Channel Coding	Fixed Reference Channel (QPSK)			
TPC Algorithm	2			
TPC Bit Pattern	All 1			
Beta C	2	11	15	15
Beta D	15	15	8	4
Delta ACK	8			
Delta NACK	8			
Delta CQI	8			
CQI Feedback Cycle	4 ms			
Ack-Nack Repetition Factor	3			
CQI Repetition Factor	2			
MPR (dB)	0	0	0.5	0.5
Power Tolerance (dB)	+1.7/-3.7	+1.7/-3.7	+2.7/-3.7	+3.7/-3.7

HSPA (HSDPA & HSUPA)

Settings	Release 8 HSPA				
Sub-test	1	2	3	4	5
Loopback Mode	Mode 1				
Channel Coding	E-DCH RF Test with TTI 10ms (QPSK)				
TPC Algorithm	2				1
TPC Bit Pattern	Inner Loop Power Control				All 1
Beta C	10	6	15	2	15
Beta D	15	15	9	15	0
Delta ACK	8				0
Delta NACK	8				0
Delta CQI	8				0
CQI Feedback Cycle	4 ms				
Ack-Nack Repetition Factor	3				
CQI Repetition Factor	2				
Delta E-DPCCH	6	8	8	5	0
Absolute Grant Value	20	12	15	17	12
E-TFCI	75	67	92	71	67
MPR (dB)	0	2	1	2	0
Power Tolerance (dB)	+1.7/-6.7	+3.7/-5.2	+2.7/-5.2	+3.7/-5.2	+1.7/-3.7

Band II Results

Mode		Conducted Average Power (dBm)			MPR
		9262 ch (1852.4 MHz)	9400 ch (1880.0 MHz)	9538 ch (1907.6 MHz)	
Rel.99	12.2 kbps RMC	23.01	23.17	23.08	--
	64 kbps RMC	23.00	23.15	23.08	--
	144 kbps RMC	23.01	23.16	23.06	--
	384 kbps RMC	23.01	23.17	23.07	--
	Voice AMR	22.98	23.15	23.07	--
HSDPA	Sub-test 1	22.00	22.15	22.07	0
	Sub-test 2	22.03	22.15	22.07	0
	Sub-test 3	21.52	21.70	21.61	0.5
	Sub-test 4	21.53	21.68	21.61	0.5
HSPA	Sub-test 1	21.88	22.02	21.97	0
	Sub-test 2	20.44	20.58	20.56	2
	Sub-test 3	20.66	20.79	20.74	1
	Sub-test 4	21.47	21.63	21.57	2
	Sub-test 5	21.98	22.16	22.06	0

Band IV Results

Mode		Conducted Average Power (dBm)			MPR
		1312 ch (1712.4 MHz)	1413 ch (1732.6 MHz)	1513 ch (1752.6 MHz)	
Rel.99	12.2 kbps RMC	22.98	22.98	22.97	--
	64 kbps RMC	22.97	22.97	22.97	--
	144 kbps RMC	22.98	22.98	22.97	--
	384 kbps RMC	22.97	22.98	22.98	--
	Voice AMR	22.96	22.98	22.97	--
HSDPA	Sub-test 1	21.97	21.99	21.97	0
	Sub-test 2	21.96	21.98	21.98	0
	Sub-test 3	21.55	21.51	21.49	0.5
	Sub-test 4	21.53	21.51	21.47	0.5
HSPA	Sub-test 1	21.85	21.84	21.84	0
	Sub-test 2	20.85	20.86	20.83	2
	Sub-test 3	20.83	20.85	20.84	1
	Sub-test 4	21.02	21.03	21.02	2
	Sub-test 5	21.96	21.96	21.97	0

13.3 LTE

The following tests were completed according to the test requirements outlined in section 6.2 of the 3GPP TS36.101 specification.

For UE power class 1 and 3, the allowed Maximum Power Reduction (MPR) for the maximum output power due to higher order modulation and transmit bandwidth configuration (resource blocks) is specified in Table 6.2.3-1 of the 3GPP TS36.101.

Table 6.2.3-1: Maximum Power Reduction (MPR) for Power Class 1 and 3

Modulation	Channel bandwidth / Transmission bandwidth (N_{RB})						MPR (dB)
	1.4 MHz	3.0 MHz	5 MHz	10 MHz	15 MHz	20 MHz	
QPSK	> 5	> 4	> 8	> 12	> 16	> 18	≤ 1
16 QAM	≤ 5	≤ 4	≤ 8	≤ 12	≤ 16	≤ 18	≤ 1
16 QAM	> 5	> 4	> 8	> 12	> 16	> 18	≤ 2

The allowed A-MPR values specified below in Table 6.2.4-1 of 3GPP TS36.101 are in addition to the allowed MPR requirements. All the measurements below were performed with A-MPR disabled, by using Network Signaling Value of "NS_01".

Table 6.2.4-1: Additional Maximum Power Reduction (A-MPR)

Network Signalling value	Requirements (subclause)	E-UTRA Band	Channel bandwidth (MHz)	Resources Blocks (N_{RB})	A-MPR (dB)
NS_01	6.6.2.1.1	Table 5.5-1	1.4, 3, 5, 10, 15, 20	Table 5.6-1	N/A
NS_03	6.6.2.2.1	2, 4, 10, 23, 25, 35, 36	3	>5	≤ 1
			5	>6	≤ 1
			10	>6	≤ 1
			15	>8	≤ 1
			20	>10	≤ 1
NS_04	6.6.2.2.2	41	5	>6	≤ 1
			10, 15, 20	Table 6.2.4-4	
NS_05	6.6.3.3.1	1	10, 15, 20	≥ 50	≤ 1
NS_06	6.6.2.2.3	12, 13, 14, 17	1.4, 3, 5, 10	Table 5.6-1	N/A
NS_07	6.6.2.2.3 6.6.3.3.2	13	10	Table 6.2.4-2	
NS_08	6.6.3.3.3	19	10, 15	> 44	≤ 3
NS_09	6.6.3.3.4	21	10, 15	> 40	≤ 1
				> 55	≤ 2
NS_10		20	15, 20	Table 6.2.4-3	
NS_11	6.6.2.2.1	23	1.4, 3, 5, 10, 15, 20	Table 6.2.4-5	
...					
NS_32	-	-	-	-	-

Band 2 Results

Mode				Conducted Average Power (dBm)			MPR
BW [MHz]	Modulation	RB Allocation		18607 ch	18900 ch	19193 ch	
		RB#	Offset	(1850.7 MHz)	(1880.0 MHz)	(1909.3 MHz)	
1.4	QPSK	1	0	22.78	23.03	22.84	0
		1	3	23.07	23.06	22.83	0
		1	5	23.03	22.99	22.71	0
		3	0	22.96	22.89	22.82	0
		3	2	22.99	22.94	22.83	0
		3	3	22.96	22.92	22.76	0
		6	0	21.85	21.84	21.83	1
	16QAM	1	0	22.08	21.98	21.99	1
		1	3	22.13	22.18	22.01	1
		1	5	22.15	22.05	21.91	1
		3	0	21.96	21.94	21.92	1
		3	2	22.01	21.96	21.94	1
		3	3	21.99	21.99	21.87	1
		6	0	20.88	20.86	20.87	2
Mode				Conducted Average Power (dBm)			MPR
BW [MHz]	Modulation	RB Allocation		18615 ch	18900 ch	19185 ch	
		RB#	Offset	(1851.5 MHz)	(1880.0 MHz)	(1908.5 MHz)	
3	QPSK	1	0	22.89	22.92	23.06	0
		1	8	23.09	22.98	22.86	0
		1	14	23.02	23.03	22.77	0
		8	0	21.91	21.83	22.02	1
		8	4	21.95	21.93	21.99	1
		8	7	21.95	21.87	21.92	1
		15	0	21.98	21.85	21.92	1
	16QAM	1	0	22.09	22.07	22.22	1
		1	8	22.27	22.23	22.10	1
		1	14	22.14	22.16	22.02	1
		8	0	20.91	20.84	20.96	2
		8	4	20.95	20.95	21.02	2
		8	7	20.96	20.90	21.01	2
		15	0	20.98	20.88	20.87	2

Mode				Conducted Average Power (dBm)			MPR
BW [MHz]	Modulation	RB Allocation		18625 ch	18900 ch	19175 ch	
		RB#	Offset	(1852.5 MHz)	(1880.0 MHz)	(1907.5 MHz)	
5	QPSK	1	0	23.04	22.92	23.09	0
		1	13	23.12	23.03	23.09	0
		1	24	23.05	23.05	22.79	0
		12	0	21.90	21.93	21.96	1
		12	7	21.92	21.91	22.04	1
		12	13	21.95	21.85	22.03	1
		25	0	22.03	21.88	21.96	1
	16QAM	1	0	22.44	22.34	22.45	1
		1	13	22.27	22.23	22.31	1
		1	24	22.29	22.27	22.02	1
		12	0	20.95	20.96	21.00	2
		12	7	20.96	20.94	21.03	2
		12	13	20.95	20.85	21.00	2
		25	0	22.98	20.89	21.00	2
Mode				Conducted Average Power (dBm)			MPR
BW [MHz]	Modulation	RB Allocation		18650 ch	18900 ch	19150 ch	
		RB#	Offset	(1855.0 MHz)	(1880.0 MHz)	(1905.0 MHz)	
10	QPSK	1	0	23.16	23.07	23.19	0
		1	25	23.15	23.05	23.16	0
		1	49	22.99	23.10	22.81	0
		25	0	21.88	21.87	22.04	1
		25	13	22.01	21.91	22.02	1
		25	25	21.91	21.90	22.00	1
		50	0	21.85	21.91	21.95	1
	16QAM	1	0	22.28	22.19	22.32	1
		1	25	22.26	22.12	22.23	1
		1	49	22.15	22.18	22.03	1
		25	0	20.93	20.89	21.03	2
		25	13	21.00	20.91	21.04	2
		25	25	20.90	20.96	21.01	2
		50	0	20.89	20.92	21.00	2

Mode				Conducted Average Power (dBm)			MPR
BW [MHz]	Modulation	RB Allocation		18675 ch	18900 ch	19125 ch	
		RB#	Offset	(1857.5 MHz)	(1880.0 MHz)	(1902.5 MHz)	
15	QPSK	1	0	23.22	23.16	23.26	0
		1	38	23.04	23.09	23.18	0
		1	74	22.96	23.15	22.89	0
		36	0	22.08	22.12	22.07	1
		36	20	22.00	22.03	22.15	1
		36	39	22.06	22.12	22.14	1
		75	0	22.14	22.05	22.07	1
	16QAM	1	0	22.36	22.27	22.32	1
		1	38	22.16	22.21	22.28	1
		1	74	22.08	22.23	22.10	1
		36	0	21.07	21.12	21.06	2
		36	20	21.03	21.04	21.13	2
		36	39	21.09	21.09	21.10	2
		75	0	21.12	21.08	21.11	2
Mode				Conducted Average Power (dBm)			MPR
BW [MHz]	Modulation	RB Allocation		18700 ch	18900 ch	19100 ch	
		RB#	Offset	(1860.0 MHz)	(1880.0 MHz)	(1900.0 MHz)	
20	QPSK	1	0	23.24	23.16	23.27	0
		1	50	23.15	23.07	23.15	0
		1	99	22.97	23.09	22.87	0
		50	0	22.03	22.02	22.02	1
		50	25	22.08	22.12	22.13	1
		50	50	21.97	22.12	22.12	1
		100	0	22.16	22.07	22.09	1
	16QAM	1	0	22.38	22.22	22.38	1
		1	50	22.20	22.21	22.27	1
		1	99	22.06	22.15	22.11	1
		50	0	21.02	21.04	20.99	2
		50	25	21.07	21.13	21.13	2
		50	50	20.97	21.08	21.10	2
		100	0	21.09	21.08	21.08	2

Band 4 Results

Mode				Conducted Average Power (dBm)			MPR
BW [MHz]	Modulation	RB Allocation		19957 ch	20175 ch	20393 ch	
		RB#	Offset	(1710.7 MHz)	(1732.5 MHz)	(1754.3 MHz)	
1.4	QPSK	1	0	22.96	22.85	22.80	0
		1	3	22.90	22.85	22.76	0
		1	5	22.78	22.79	22.77	0
		3	0	22.81	22.68	22.68	0
		3	2	22.84	22.85	22.67	0
		3	3	22.82	22.75	22.72	0
		6	0	21.74	21.68	21.62	1
	16QAM	1	0	21.96	21.80	21.85	1
		1	3	22.06	22.09	22.11	1
		1	5	22.08	21.99	22.06	1
		3	0	21.92	21.88	21.83	1
		3	2	21.97	21.89	21.84	1
		3	3	21.99	21.85	21.89	1
		6	0	20.83	20.70	20.67	2
Mode				Conducted Average Power (dBm)			MPR
BW [MHz]	Modulation	RB Allocation		19965 ch	20175 ch	20385 ch	
		RB#	Offset	(1711.5 MHz)	(1732.5 MHz)	(1753.5 MHz)	
3	QPSK	1	0	22.80	22.79	22.61	0
		1	8	22.85	22.88	22.79	0
		1	14	22.73	22.69	22.71	0
		8	0	21.78	21.66	21.62	1
		8	4	21.81	21.84	21.82	1
		8	7	21.85	21.84	21.71	1
		15	0	21.87	21.78	21.78	1
	16QAM	1	0	22.04	22.02	21.87	1
		1	8	22.43	22.27	22.30	1
		1	14	21.96	22.04	22.04	1
		8	0	20.90	20.75	20.75	2
		8	4	20.78	20.83	20.83	2
		8	7	20.85	20.78	20.78	2
		15	0	20.82	20.72	20.72	2

Mode				Conducted Average Power (dBm)			MPR
BW [MHz]	Modulation	RB Allocation		19975 ch	20175 ch	20375 ch	
		RB#	Offset	(1712.5 MHz)	(1732.5 MHz)	(1752.5 MHz)	
5	QPSK	1	0	22.95	22.87	22.74	0
		1	13	22.94	22.96	22.86	0
		1	24	22.75	22.85	22.82	0
		12	0	21.77	21.81	21.68	1
		12	7	21.92	21.84	21.67	1
		12	13	21.80	21.67	21.69	1
		25	0	21.84	21.77	21.75	1
	16QAM	1	0	22.45	22.32	22.26	1
		1	13	22.12	22.21	22.15	1
		1	24	22.17	22.23	22.25	1
		12	0	20.80	20.83	20.74	2
		12	7	20.89	20.80	20.68	2
		12	13	20.77	20.68	20.72	2
		25	0	20.85	20.73	20.73	2
Mode				Conducted Average Power (dBm)			MPR
BW [MHz]	Modulation	RB Allocation		20000 ch	20175 ch	20350 ch	
		RB#	Offset	(1715.0 MHz)	(1732.5 MHz)	(1750.0 MHz)	
10	QPSK	1	0	23.01	23.00	22.92	0
		1	25	22.96	22.98	22.91	0
		1	49	22.74	22.72	22.76	0
		25	0	21.90	21.77	21.79	1
		25	13	21.81	21.83	21.75	1
		25	25	21.75	21.77	21.66	1
		50	0	21.82	21.76	21.71	1
	16QAM	1	0	22.27	22.19	22.08	1
		1	25	22.06	22.16	22.04	1
		1	49	21.96	22.02	22.08	1
		25	0	20.91	20.79	20.78	2
		25	13	20.85	20.78	20.78	2
		25	25	20.81	20.75	20.68	2
		50	0	20.77	20.69	20.69	2

Mode				Conducted Average Power (dBm)			MPR
BW [MHz]	Modulation	RB Allocation		20025 ch	20175 ch	20325 ch	
		RB#	Offset	(1717.5 MHz)	(1732.5 MHz)	(1747.5 MHz)	
15	QPSK	1	0	23.11	23.05	23.00	0
		1	38	22.98	22.95	22.95	0
		1	74	22.79	22.80	22.71	0
		36	0	21.95	22.00	22.00	1
		36	20	22.00	21.99	22.01	1
		36	39	21.86	21.93	21.87	1
		75	0	21.87	21.91	21.92	1
	16QAM	1	0	22.29	22.24	22.19	1
		1	38	22.14	22.13	22.15	1
		1	74	21.93	21.97	21.91	1
		36	0	20.96	21.04	20.99	2
		36	20	21.01	20.99	21.01	2
		36	39	20.85	20.87	20.86	2
		75	0	20.93	20.93	20.95	2
Mode				Conducted Average Power (dBm)			MPR
BW [MHz]	Modulation	RB Allocation		20175 ch			
		RB#	Offset	(1732.5 MHz)			
20	QPSK	1	0	23.10		0	
		1	50	22.98		0	
		1	99	22.67		0	
		50	0	22.05		1	
		50	25	21.96		1	
		50	50	21.88		1	
		100	0	21.95		1	
	16QAM	1	0	22.27		1	
		1	50	22.20		1	
		1	99	21.80		1	
		50	0	21.05		2	
		50	25	21.00		2	
		50	50	20.87		2	
		100	0	20.97		2	

Note(s):

LTE Band 4 does not support three non-overlapping channels in 20 MHz channel bandwidths. When a device supports overlapping channel assignment in a channel bandwidth configuration, the middle channel of the group of overlapping channels should be selected for testing per KDB 941225 D05 SAR for LTE Devices

13.4 WLAN (DTS Band)

DTS Band Results (ANT 0)

Band	Mode	Data Rate	Ch#	Frequency (MHz)	Average Power (dBm)	
					Measred	Spec. Max.
2.4 GHz (DTS)	802.11b	1 Mbps	1	2412	11.27	12.5
			6	2437	11.58	
			11	2462	11.17	
	802.11g	6 Mbps	1	2412	9.08	10.5
			6	2437	9.19	
			11	2462	9.38	
	802.11n [HT20]	MCS 0	1	2412	8.94	10.5
			6	2437	9.12	
			11	2462	9.22	

DTS Band Results (ANT 1)

Band	Mode	Data Rate	Ch#	Frequency (MHz)	Average Power (dBm)	
					Measred	Spec. Max.
2.4 GHz (DTS)	802.11b	1 Mbps	1	2412	10.60	12.5
			6	2437	10.81	
			11	2462	10.95	
	802.11g	6 Mbps	1	2412	8.68	10.5
			6	2437	8.59	
			11	2462	8.65	
	802.11n [HT20]	MCS 0	1	2412	8.42	10.5
			6	2437	8.43	
			11	2462	8.52	

Note(s):

Power measurement is required for the transmission mode configuration with the highest maximum output power specified for production units. (802.11b DSSS and 802.11g/n OFDM configurations are considered separately.)

- When the same highest maximum output power specification applies to multiple transmission modes, the largest channel bandwidth configuration with the lowest order modulation and lowest data rate is measured.
- When the same highest maximum output power is specified for multiple largest channel bandwidth configurations with the same lowest order modulation or lowest order modulation and lowest data rate, power measurement is required for all equivalent 802.11 configurations with the same maximum output power.

13.5 WLAN (U-NII Band)

U-NII Band Results (ANT 0)

Band	Mode	Data Rate	Ch#	Frequency (MHz)	Average Power (dBm)	
					Measred	Spec. Max.
5.2 GHz (U-NII 1)	802.11a	6 Mbps	36	5180	11.41	12.5
			40	5200	11.36	
			44	5220	11.34	
			48	5240	11.33	
	802.11n [HT20]	MCS 0	36 – 48	5180 – 5240	Not Required	11.5
	802.11n [HT40]	MCS 0	38 – 46	5190 – 5230		11.5
	802.11ac [VHT20]	MCS 0	36 – 48	5180 – 5240		11.5
802.11ac [VHT40]	MCS 0	38 – 46	5190 – 5230	11.5		
802.11ac [VHT80]	MCS 0	42	5210	11.5		
5.3 GHz (U-NII 2A)	802.11a	6 Mbps	52	5260	11.32	12.5
			56	5280	11.52	
			60	5300	11.48	
			64	5320	11.45	
	802.11n [HT20]	MCS 0	52 – 64	5260 – 5320	Not Required	11.5
	802.11n [HT40]	MCS 0	54 – 62	5270 – 5310		11.5
	802.11ac [VHT20]	MCS 0	52 – 64	5260 – 5320		11.5
802.11ac [VHT40]	MCS 0	54 – 62	5270 – 5310	11.5		
802.11ac [VHT80]	MCS 0	58	5290	11.5		
5.6 GHz (U-NII 2C)	802.11a	6 Mbps	100	5500	11.42	12.5
			120	5600	11.36	
			140	5700	10.99	
	802.11n [HT20]	MCS 0	100 – 140	5500 – 5700	Not Required	11.5
	802.11n [HT40]	MCS 0	102 – 134	5510 – 5670		11.5
	802.11ac [VHT20]	MCS 0	100 – 140	5500 – 5700		11.5
	802.11ac [VHT40]	MCS 0	102 – 134	5510 – 5670		11.5
802.11ac [VHT80]	MCS 0	106 – 122	5530 – 5610	11.5		

U-NII Band Results (ANT 1)

Band	Mode	Data Rate	Ch#	Frequency (MHz)	Average Power (dBm)	
					Measred	Spec. Max.
5.2 GHz (U-NII 1)	802.11a	6 Mbps	36	5180	11.75	12.5
			40	5200	11.71	
			44	5220	11.67	
			48	5240	11.65	
	802.11n [HT20]	MCS 0	36 – 48	5180 – 5240	Not Required	11.5
	802.11n [HT40]	MCS 0	38 – 46	5190 – 5230		11.5
	802.11ac [VHT20]	MCS 0	36 – 48	5180 – 5240		11.5
802.11ac [VHT40]	MCS 0	38 – 46	5190 – 5230		11.5	
802.11ac [VHT80]	MCS 0	42	5210		11.5	
5.3 GHz (U-NII 2A)	802.11a	6 Mbps	52	5260	11.65	12.5
			56	5280	11.76	
			60	5300	11.74	
			64	5320	11.67	
	802.11n [HT20]	MCS 0	52 – 64	5260 – 5320	Not Required	11.5
	802.11n [HT40]	MCS 0	54 – 62	5270 – 5310		11.5
	802.11ac [VHT20]	MCS 0	52 – 64	5260 – 5320		11.5
802.11ac [VHT40]	MCS 0	54 – 62	5270 – 5310		11.5	
802.11ac [VHT80]	MCS 0	58	5290		11.5	
5.6 GHz (U-NII 2C)	802.11a	6 Mbps	100	5500	11.65	12.5
			120	5600	11.43	
			140	5700	11.16	
	802.11n [HT20]	MCS 0	100 – 140	5500 – 5700	Not Required	11.5
	802.11n [HT40]	MCS 0	102 – 134	5510 – 5670		11.5
	802.11ac [VHT20]	MCS 0	100 – 140	5500 – 5700		11.5
	802.11ac [VHT40]	MCS 0	102 – 134	5510 – 5670		11.5
802.11ac [VHT80]	MCS 0	106 – 122	5530 – 5610		11.5	

Note(s):

Power measurement is required for the transmission mode configuration with the highest maximum output power specified for production units.

- When the same highest maximum output power specification applies to multiple transmission modes, the largest channel bandwidth configuration with the lowest order modulation and lowest data rate is measured.
- When the same highest maximum output power is specified for multiple largest channel bandwidth configurations with the same lowest order modulation or lowest order modulation and lowest data rate, power measurement is required for all equivalent 802.11 configurations with the same maximum output power.

13.6 Bluetooth

Maximum tune-up tolerance limit is 7.5 dBm from the rated nominal maximum output power. This power level qualifies for exclusion of SAR testing.

13.7 Standalone SAR Test Exclusion Considerations (KDB 447498 D01)

The 1 g SAR test exclusion thresholds for 100 MHz to 6 GHz at *test separation distances* ≤ 50 mm are determined by;

$[(\text{max. power of channel, including tune-up tolerance, mW}) / (\text{min. test separation distance, mm})] \cdot [\sqrt{f_{\text{(GHz)}}}] \leq 3.0$ for 1 g SAR and ≤ 7.5 for 10 g extremity SAR, where

- $f_{\text{(GHz)}}$ is the RF channel transmit frequency in GHz.
- Power and distance are rounded to the nearest mW and mm before calculation.
- The result is rounded to one decimal place for comparison.
- When the minimum test separation distance is < 5 mm, a distance of 5 mm is applied.

Band		Freq. (MHz)	Max. Power		Test Position	Distance (mm)	Threshold	Test Exclusion
			(dBm)	(mW)				
WLAN (DTS)	ANT 0	2462	12.5	18	Head	< 5	5.6	NO
					Body	10	2.8	YES *
	ANT 1	2462	12.5	18	Head	< 5	5.6	NO
					Body	10	2.8	YES *
WLAN (U-NII)	ANT 0	5700	12.5	18	Head	< 5	8.6	NO
					Body	10	4.3	NO
	ANT 1	5700	12.5	18	Head	< 5	8.6	NO
					Body	10	4.3	NO
Bluetooth		2480	7.5	6	Head	< 5	1.9	YES
					Body	10	0.9	YES

* Standalone SAR measurement was performed because of the overly conservative estimated SAR to determine simultaneous transmission SAR test exclusion.

14 SAR Measurements

SAR test reduction criteria are as follows:

When 10 g extremity SAR is required, SAR values indicated below are multiplied by 2.5, i.e. the ratio of the 1 g and extremity 10 g SAR limit.

KDB 447498 D01 General RF Exposure Guidance:

Testing of other required channels within the operating mode of a frequency band is not required when the reported 1 g SAR for the mid-band or highest output power channel is:

- ≤ 0.8 W/kg when the transmission band is ≤ 100 MHz
- ≤ 0.6 W/kg when the transmission band is between 100 MHz and 200 MHz
- ≤ 0.4 W/kg when the transmission band is ≥ 200 MHz

KDB 648474 D04 Handset SAR:

With headset attached, when the reported SAR for body-worn accessory, measured without a headset connected to the handset, is > 1.2 W/kg, the highest reported SAR configuration for that wireless mode and frequency band should be repeated for that body-worn accessory with a headset attached to the handset.

KDB 941225 D01 SAR test for 3G devices:

When the maximum output power and tune-up tolerance specified for production units in a secondary mode is $\leq \frac{1}{4}$ dB higher than the primary mode or when the highest reported SAR of the primary mode is scaled by the ratio of specified maximum output power and tune-up tolerance of secondary to primary mode and the adjusted SAR is ≤ 1.2 W/kg, SAR measurement is not required for the secondary mode.

For phablets, when hotspot mode applies, the UMPC mini-tablet 10 g extremity SAR is not required for the surfaces and edges with hotspot mode 1 g reported SAR ≤ 1.2 W/kg.

KDB 941225 D05 SAR for LTE Devices:

SAR test reduction is applied using the following criteria:

- Start with the largest channel bandwidth and measure SAR for QPSK with 1 RB, and 50% RB allocation, using the RB offset and required test channel combination with the highest maximum output power among RB offsets at the upper edge, middle and lower edge of each required test channel.
- When the reported SAR is > 0.8 W/kg, testing for other Channels is performed at the highest output power level for 1 RB, and 50% RB configuration for that channel.
- Testing for 100% RB configuration is performed at the highest output power level for 100% RB configuration across the Low, Mid and High Channel when the highest reported SAR for 1 RB and 50% RB are > 0.8 W/kg. Testing for the remaining required channels is not needed because the reported SAR for 100% RB Allocation < 1.45 W/kg.
- Testing for 16-QAM modulation is not required because the reported SAR for QPSK is < 1.45 W/Kg and its output power is not more than $\frac{1}{2}$ dB higher than that of QPSK.
- Testing for the other channel bandwidths is not required because the reported SAR for the highest channel bandwidth is < 1.45 W/Kg and its output power is not more than $\frac{1}{2}$ dB higher than that of the highest channel bandwidth.

KDB 248227 D01 802.11 Wi-Fi SAR:

SAR test reduction is determined according to 802.11 transmission mode configurations and certain exposure conditions with multiple test positions. In the 2.4 GHz band, separate SAR procedures are applied to DSSS and OFDM configurations to simplify DSSS test requirements. For OFDM in both 2.4 GHz and 5 GHz bands, an initial test configuration is first determined for each standalone and aggregated frequency band according to the maximum output power and tune-up tolerance specified for production units. When the same maximum power is specified for multiple transmission modes in a frequency band, the largest channel bandwidth, lowest order modulation, lowest data rate and lowest order 802.11a/g/n/ac mode is used for SAR measurement, on the highest measured output power channel in the initial test configuration, for each frequency band.

SAR is measured using the highest measured maximum output power channel for the determined exposure configurations. When there are multiple test channels with the same measured maximum output power, the channel closest to mid-band frequency is selected for SAR measurement. When there are multiple test channels with the same measured maximum output power and equal separation from mid-band frequency; for example, high and low channels or two mid-band channels, the higher frequency (number) channel is selected for SAR measurement.

An initial test position is applied to further reduce the number of SAR tests for devices operating in next to the ear, UMPC mini-tablet or hotspot mode exposure configurations that require multiple test positions SAR is measured in the initial test position using the 802.11 transmission mode configuration required by the DSSS procedure or initial test configuration according to the OFDM procedures. The initial test position procedure is described in the following:

- When the reported SAR of the initial test position is ≤ 0.4 W/kg, further SAR measurement is not required for the other (remaining) test positions in that exposure configuration and 802.11 transmission mode combination within the frequency band or aggregated band.
- When the reported SAR of the initial test position is > 0.4 W/kg, SAR is repeated for the 802.11 transmission mode configuration tested in the initial test position using subsequent highest extrapolated or estimated 1 g SAR conditions determined by area scans or next closest/smallest test separation distance and maximum RF coupling test positions based on manufacturer justification, on the highest maximum output power channel, until the reported SAR is ≤ 0.8 W/kg or all required test positions (left, right, touch, tilt or subsequent surfaces and edges) are tested.
- For all positions/configurations tested using the initial test position and subsequent test positions, when the reported SAR is > 0.8 W/kg, SAR is measured for these test positions/configurations on the subsequent next highest measured output power channel(s) until the reported SAR is ≤ 1.2 W/kg or all required channels are tested.

To determine the initial test position, Area Scans were performed to determine the position with the estimated 1 g SAR (fast SAR). The position that produced the highest fast SAR is considered the worst case position; thus used as the initial test position. The averaged fast SAR is scaled according to reported SAR requirements.

14.1 GSM 850

GPRS 4 slots (CS1) – Duty Cycle 48.0%									
RF Exposure Conditions	Test Position	Dist. [mm]	Ch#	Freq. [MHz]	Power [dBm]		1 g SAR [W/kg]		Plot No.
					Tune-up Limit	Meas.	Meas.	Scaled	
Head	Left Touch	0	189	836.4	28.5	27.53	0.127	0.159	1
	Left Tilt	0	189	836.4	28.5	27.53	0.074	0.093	
	Right Touch	0	189	836.4	28.5	27.53	0.113	0.141	
	Right Tilt	0	189	836.4	28.5	27.53	0.068	0.085	
Body-worn & Hotspot	Rear	10	189	836.4	28.5	27.53	0.170	0.213	2
	Front	10	189	836.4	28.5	27.53	0.168	0.210	
Hotspot	Edge 2	10	189	836.4	28.5	27.53	0.082	0.103	
	Edge 3	10	189	836.4	28.5	27.53	0.023	0.029	
	Edge 4	10	189	836.4	28.5	27.53	0.121	0.151	

14.2 PCS 1900

GPRS 4 slots (CS1) – Duty Cycle 48.0%									
RF Exposure Conditions	Test Position	Dist. [mm]	Ch#	Freq. [MHz]	Power [dBm]		1 g SAR [W/kg]		Plot No.
					Tune-up Limit	Meas.	Meas.	Scaled	
Head	Left Touch	0	661	1880.0	25.1	24.55	0.050	0.057	3
	Left Tilt	0	661	1880.0	25.1	24.55	0.018	0.020	
	Right Touch	0	661	1880.0	25.1	24.55	0.024	0.027	
	Right Tilt	0	661	1880.0	25.1	24.55	0.012	0.014	
Body-worn & Hotspot	Rear	10	661	1880.0	25.1	24.55	0.423	0.480	
	Front	10	512	1850.2	25.1	24.42	0.707	0.827	4
		10	661	1880.0	25.1	24.55	0.433	0.491	
		10	810	1909.8	25.1	23.98	0.358	0.463	
Hotspot	Edge 2	10	661	1880.0	25.1	24.55	0.015	0.017	
	Edge 3	10	512	1850.2	25.1	24.42	0.726	0.849	5
		10	661	1880.0	25.1	24.55	0.451	0.512	
		10	810	1909.8	25.1	23.98	0.351	0.454	
	Edge 4	10	661	1880.0	25.1	24.55	0.094	0.107	

14.3 W-CDMA Band II

Rel.99 12.2kbps RMC – Duty Cycle 100%									
RF Exposure Conditions	Test Position	Dist. [mm]	Ch#	Freq. [MHz]	Power [dBm]		1 g SAR [W/kg]		Plot No.
					Tune-up Limit	Meas.	Meas.	Scaled	
Head	Left Touch	0	9400	1880.0	23.5	23.17	0.096	0.104	6
	Left Tilt	0	9400	1880.0	23.5	23.17	0.026	0.028	
	Right Touch	0	9400	1880.0	23.5	23.17	0.043	0.046	
	Right Tilt	0	9400	1880.0	23.5	23.17	0.031	0.033	
Body-worn & Hotspot	Rear	10	9400	1880.0	23.5	23.17	0.665	0.717	
	Front	10	9262	1852.4	23.5	23.01	0.834	0.934	7
		10	9400	1880.0	23.5	23.17	0.705	0.761	
Hotspot	Edge 2	10	9400	1880.0	23.5	23.17	0.027	0.029	
		10	9400	1880.0	23.5	23.17	0.628	0.678	
	Edge 4	10	9400	1880.0	23.5	23.17	0.185	0.200	

14.4 W-CDMA Band IV

Rel.99 12.2kbps RMC – Duty Cycle 100%									
RF Exposure Conditions	Test Position	Dist. [mm]	Ch#	Freq. [MHz]	Power [dBm]		1 g SAR [W/kg]		Plot No.
					Tune-up Limit	Meas.	Meas.	Scaled	
Head	Left Touch	0	1413	1732.6	23.2	22.98	0.190	0.200	8
	Left Tilt	0	1413	1732.6	23.2	22.98	0.063	0.066	
	Right Touch	0	1413	1732.6	23.2	22.98	0.097	0.102	
	Right Tilt	0	1413	1732.6	23.2	22.98	0.080	0.084	
Body-worn & Hotspot	Rear	10	1312	1712.4	23.2	22.98	0.769	0.809	
		10	1413	1732.6	23.2	22.98	0.897	0.944	
		10	1513	1752.6	23.2	22.97	1.000	1.054	
	Front	10	1312	1712.4	23.2	22.98	0.868	0.913	
		10	1413	1732.6	23.2	22.98	0.996	1.048	
		10	1513	1752.6	23.2	22.97	1.120	1.181	9
Front (repeat #1)	10	1513	1752.6	23.2	22.97	1.110	1.170		
Hotspot	Edge 2	10	1413	1732.6	23.2	22.98	0.038	0.040	
	Edge 3	10	1312	1712.4	23.2	22.98	0.819	0.862	
		10	1413	1732.6	23.2	22.98	0.945	0.994	
		10	1513	1752.6	23.2	22.97	1.070	1.128	
	Edge 4	10	1413	1732.6	23.2	22.98	0.191	0.201	

14.5 LTE Band 2

QPSK 20 MHz BW – Duty Cycle 100%											
RF Exposure Conditions	Test Position	Dist. [mm]	Ch#	Freq. [MHz]	RB#	Offset	Power [dBm]		1 g SAR [W/kg]		Plot No.
							Tune-up Limit	Meas.	Meas.	Scaled	
Head	Left Touch	0	18900	1880.0	1	0	23.5	23.16	0.107	0.116	10
					50	25	22.5	22.12	0.080	0.087	
	Left Tilt	0	18900	1880.0	1	0	23.5	23.16	0.027	0.029	
					50	25	22.5	22.12	0.021	0.023	
	Right Touch	0	18900	1880.0	1	0	23.5	23.16	0.048	0.052	
					50	25	22.5	22.12	0.036	0.039	
	Right Tilt	0	18900	1880.0	1	0	23.5	23.16	0.035	0.038	
					50	25	22.5	22.12	0.025	0.027	
Body-worn & Hotspot	Rear	10	18700	1860.0	1	0	23.5	23.24	0.917	0.974	
		10	18900	1880.0	1	0	23.5	23.16	0.754	0.815	
					50	25	22.5	22.12	0.558	0.609	
	10	19100	1900.0	1	0	23.5	23.27	0.608	0.641		
	Front	10	18700	1860.0	1	0	23.5	23.24	0.964	1.023	11
		10	18900	1880.0	1	0	23.5	23.16	0.797	0.862	
					50	25	22.5	22.12	0.594	0.648	
	10	19100	1900.0	1	0	23.5	23.27	0.646	0.681		
Front (repeat #1)	10	18700	1860.0	1	0	23.5	23.27	0.964	1.023		
Hotspot	Edge 2	10	18900	1880.0	1	0	23.5	23.16	0.027	0.029	
					50	25	22.5	22.12	0.022	0.024	
	Edge 3	10	18900	1880.0	1	0	23.5	23.16	0.702	0.759	
					50	25	22.5	22.12	0.520	0.568	
	Edge 4	10	18900	1880.0	1	0	23.5	23.16	0.207	0.224	
					50	25	22.5	22.12	0.151	0.165	

14.6 LTE Band 4

QPSK 20 MHz BW – Duty Cycle 100%											
RF Exposure Conditions	Test Position	Dist. [mm]	Ch#	Freq. [MHz]	RB#	Offset	Power [dBm]		1 g SAR [W/kg]		Plot No.
							Tune-up Limit	Meas.	Meas.	Scaled	
Head	Left Touch	0	20175	1732.5	1	0	23.2	23.10	0.192	0.196	12
					50	0	22.2	22.05	0.150	0.155	
	Left Tilt	0	20175	1732.5	1	0	23.2	23.10	0.063	0.064	
					50	0	22.2	22.05	0.048	0.050	
	Right Touch	0	20175	1732.5	1	0	23.2	23.10	0.092	0.094	
					50	0	22.2	22.05	0.071	0.073	
	Right Tilt	0	20175	1732.5	1	0	23.2	23.10	0.079	0.081	
					50	0	22.2	22.05	0.060	0.062	
Body-worn & Hotspot	Rear	10	20175	1732.5	1	0	23.2	23.10	0.858	0.878	
					50	0	22.2	22.05	0.681	0.705	
	Front	10	20175	1732.5	1	0	23.2	23.10	0.949	0.971	
					50	0	22.2	22.05	0.790	0.818	
					100	0	22.2	21.95	0.781	0.827	
					50	0	22.2	22.05	0.790	0.818	
Hotspot	Edge 2	10	20175	1732.5	1	0	23.2	23.10	0.036	0.037	
					50	0	22.2	22.05	0.030	0.031	
	Edge 3	10	20175	1732.5	1	0	23.2	23.10	0.918	0.939	
					50	0	22.2	22.05	0.776	0.803	
					100	0	22.2	21.95	0.749	0.793	
					50	0	22.2	22.05	0.749	0.793	
	Edge 4	10	20175	1732.5	1	0	23.2	23.10	0.189	0.193	
					50	0	22.2	22.05	0.149	0.154	
QPSK 15 MHz BW – Duty Cycle 100%											
Body-worn & Hotspot	Rear	10	20025	1717.5	1	0	23.2	23.11	0.765	0.781	
		10	20325	1747.5	1	0	23.2	23.00	0.988	1.035	
	Front	10	20025	1717.5	1	0	23.2	23.11	0.867	0.885	
					36	20	22.2	22.00	0.706	0.739	
		10	20325	1747.5	1	0	23.2	23.00	1.090	1.141	13
					36	20	22.2	22.01	0.864	0.903	
					75	0	22.2	21.92	0.862	0.919	
					36	20	22.2	22.01	0.864	0.903	
Hotspot	Edge 3	10	20025	1717.5	1	0	23.2	23.11	0.839	0.857	
					36	20	22.2	22.00	0.655	0.686	
	10	20325	1747.5	1	0	23.2	23.00	1.030	1.079		
				36	20	22.2	22.01	0.833	0.870		
				75	0	22.2	21.92	0.828	0.883		
				36	20	22.2	22.01	0.833	0.870		

14.7 WLAN (DTS Band)

ANT 0

802.11b (1 Mbps) – Duty Cycle 100%										
RF Exposure Conditions	Test Position	Dist. [mm]	Ch#	Freq. [MHz]	Averaged Fast SAR [W/kg]	Power [dBm]		1 g SAR [W/kg]		Plot No.
						Tune-up Limit	Meas.	Meas.	Scaled	
Head	Left Touch	0	6	2437	0.017	12.5	11.58	0.014	0.017	14
	Left Tilt	0	6	2437	0.005	12.5	11.58			
	Right Touch	0	6	2437	0.003	12.5	11.58			
	Right Tilt	0	6	2437	0.001	12.5	11.58			
Body-worn & Hotspot	Rear	10	6	2437	0.586	12.5	11.58	0.540	0.667	15
	Front	10	6	2437	0.003	12.5	11.58	0.003	0.004	
Hotspot	Edge 1	10	6	2437	0.007	12.5	11.58			
	Edge 2	10	6	2437	0.087	12.5	11.58	0.071	0.088	

ANT 1

802.11b (1 Mbps) – Duty Cycle 100%										
RF Exposure Conditions	Test Position	Dist. [mm]	Ch#	Freq. [MHz]	Averaged Fast SAR [W/kg]	Power [dBm]		1 g SAR [W/kg]		Plot No.
						Tune-up Limit	Meas.	Meas.	Scaled	
Head	Left Touch	0	11	2462	0.000	12.5	10.95			
	Left Tilt	0	11	2462	0.000	12.5	10.95			
	Right Touch	0	11	2462	0.001	12.5	10.95	0.002	0.003	16
	Right Tilt	0	11	2462	0.000	12.5	10.95			
Body-worn & Hotspot	Rear	10	11	2462	0.040	12.5	10.95	0.041	0.059	17
	Front	10	11	2462	0.000	12.5	10.95	0.000	0.000	
Hotspot	Edge 1	10	11	2462	0.000	12.5	10.95			
	Edge 4	10	11	2462	0.008	12.5	10.95			

Note(s):

SAR is not required for 802.11g/n OFDM configurations when the highest *reported* SAR for DSSS is adjusted by the ratio of OFDM to DSSS specified maximum output power and the adjusted SAR is ≤ 1.2 W/kg.

14.8 WLAN (U-NII Band)

14.8.1 5.2 GHz Band (U-NII 1)

The same maximum output power is specified for U-NII 1 and U-NII 2A band, therefore begin SAR measurement in U-NII 2A band by applying the OFDM SAR requirements.

The highest reported SAR for U-NII 2A band is ≤ 1.2 W/kg, then the SAR is not required for U-NII 1 band.

14.8.2 5.3 GHz Band (U-NII 2A)

ANT 0

802.11a (6Mbps) – Duty Cycle 100%										
RF Exposure Conditions	Test Position	Dist. [mm]	Ch#	Freq. [MHz]	Averaged Fast SAR [W/kg]	Power [dBm]		1 g SAR [W/kg]		Plot No.
						Tune-up Limit	Meas.	Meas.	Scaled	
Head	Left Touch	0	56	5280	0.056	12.5	11.52	0.028	0.035	18
	Left Tilt	0	56	5280	0.043	12.5	11.52			
	Right Touch	0	56	5280	0.040	12.5	11.52			
	Right Tilt	0	56	5280	0.032	12.5	11.52			
Body-worn	Rear	10	56	5280	0.130	12.5	11.52	0.104	0.130	19
	Front	10	56	5280	0.000	12.5	11.52	0.000	0.000	

ANT 1

802.11a (6Mbps) – Duty Cycle 100%										
RF Exposure Conditions	Test Position	Dist. [mm]	Ch#	Freq. [MHz]	Averaged Fast SAR [W/kg]	Power [dBm]		1 g SAR [W/kg]		Plot No.
						Tune-up Limit	Meas.	Meas.	Scaled	
Head	Left Touch	0	56	5280	0.000	12.5	11.76			
	Left Tilt	0	56	5280	0.003	12.5	11.76			
	Right Touch	0	56	5280	0.040	12.5	11.76	0.039	0.046	20
	Right Tilt	0	56	5280	0.005	12.5	11.76			
Body-worn	Rear	10	56	5280	0.009	12.5	11.76	0.014	0.017	21
	Front	10	56	5280	0.001	12.5	11.76	0.003	0.004	

Note(s):

SAR is not required for subsequent test configurations when the highest reported SAR for the initial test configuration is adjusted by the ratio of the subsequent test configuration to initial test configuration specified maximum output power and the adjusted SAR is ≤ 1.2 W/kg.

14.8.3 5.6 GHz Band (U-NII 2C)

ANT 0

802.11a (6Mbps) – Duty Cycle 100%										
RF Exposure Conditions	Test Position	Dist. [mm]	Ch#	Freq. [MHz]	Averaged Fast SAR [W/kg]	Power [dBm]		1 g SAR [W/kg]		Plot No.
						Tune-up Limit	Meas.	Meas.	Scaled	
Head	Left Touch	0	100	5500	0.098	12.5	11.42	0.069	0.088	22
	Left Tilt	0	100	5500	0.022	12.5	11.42			
	Right Touch	0	100	5500	0.025	12.5	11.42			
	Right Tilt	0	100	5500	0.017	12.5	11.42			
Body-worn	Rear	10	100	5500	0.095	12.5	11.42	0.077	0.099	23
	Front	10	100	5500	0.000	12.5	11.42	0.000	0.000	

ANT 1

802.11a (6Mbps) – Duty Cycle 100%										
RF Exposure Conditions	Test Position	Dist. [mm]	Ch#	Freq. [MHz]	Averaged Fast SAR [W/kg]	Power [dBm]		1 g SAR [W/kg]		Plot No.
						Tune-up Limit	Meas.	Meas.	Scaled	
Head	Left Touch	0	100	5500	0.004	12.5	11.65			
	Left Tilt	0	100	5500	0.007	12.5	11.65			
	Right Touch	0	100	5500	0.064	12.5	11.65	0.048	0.059	24
	Right Tilt	0	100	5500	0.007	12.5	11.65			
Body-worn	Rear	10	100	5500	0.037	12.5	11.65	0.024	0.029	25
	Front	10	100	5500	0.003	12.5	11.65	0.009	0.011	

Note(s):

SAR is not required for subsequent test configurations when the highest reported SAR for the initial test configuration is adjusted by the ratio of the subsequent test configuration to initial test configuration specified maximum output power and the adjusted SAR is ≤ 1.2 W/kg.

14.9 SAR Measurement Variability

In accordance with the KDB 865664 D01, these additional measurements are repeated after the completion of all measurements requiring the same head or body tissue-equivalent medium in a frequency band. The DUT should be returned to ambient conditions (normal room temperature) with the battery fully charged before it is re-mounted on the device holder for the repeated measurement(s) to minimize any unexpected variations in the repeated results.

- 1) Repeated measurement is not required when the original highest measured SAR is < 0.80 W/kg; steps 2) through 4) do not apply.
- 2) When the original highest measured SAR is ≥ 0.80 W/kg, repeat that measurement once.
- 3) Perform a 2nd repeated measurement only if the ratio of largest to smallest SAR for the original and first repeated measurements is > 1.20 or when the original or repeated measurement is ≥ 1.45 W/kg (~ 10% from the 1-g SAR limit).
- 4) Perform a 3rd repeated measurement only if the original, first or second repeated measurement is ≥ 1.5 W/kg and the ratio of largest to smallest SAR for the original, first and second repeated measurements is > 1.20.

14.9.1 Highest Measured SAR Configuration in Each Frequency Band

Frequency Band [MHz]	Air Interface	Standalone SAR [W/kg]	
		Head	Body
850	GSM 850	0.127	0.170
1750	W-CDMA Band IV	0.190	1.120
	LTE Band 4	0.192	1.090
1900	PCS 1900	0.050	0.726
	W-CDMA Band II	0.096	0.834
	LTE Band 2	0.107	0.964
2450	WLAN 802.11b	0.014	0.540
5250	WLAN 802.11a	0.039	0.104
5600	WLAN 802.11a	0.069	0.077

14.9.2 Repeated SAR Measurement Results

Band	Test Position	Ch#	Frequency [MHz]	Measured SAR [W/kg]		Largest to Smallest SAR Ratio
				Original	Repeated	
W-CDMA Band IV	Rear	1513	1752.6	1.120	1.110	1.01
LTE Band 2	Rear	18700	1860.0	0.964	0.964	1.00

14.10 Simultaneous Transmission SAR Analysis

14.10.1 Simultaneous Transmission Condition

WWAN can transmit simultaneously with WLAN/Bluetooth.

WLAN cannot transmit simultaneously with Bluetooth since they share an antenna port.

No.	Conditions	Head	Body	Hotspot
1	GSM + WLAN 2.4 GHz	YES	YES	YES
2	W-CDMA + WLAN 2.4 GHz	YES	YES	YES
3	LTE + WLAN 2.4 GHz	YES	YES	YES
4	GSM + WLAN 5 GHz	YES	YES	NO
5	W-CDMA + WLAN 5 GHz	YES	YES	NO
6	LTE + WLAN 5 GHz	YES	YES	NO
7	GSM + Bluetooth	YES	YES	NO
8	W-CDMA + Bluetooth	YES	YES	NO
9	LTE + Bluetooth	YES	YES	NO

14.10.2 Standalone SAR Estimation

When standalone SAR test exclusion applies to an antenna that transmits simultaneously with other antennas, the standalone SAR must be estimated according to following to determine simultaneous transmission SAR test exclusion:

$[(\text{max. power of channel, including tune-up tolerance, mW}) / (\text{min. test separation distance, mm})] \cdot$

$[\sqrt{f_{\text{(GHz)}}} / 7.5] \text{ W/kg for 1 g SAR, test separation distances} \leq 50 \text{ mm, or}$

$0.4 \text{ W/kg for 1 g SAR, test separation distances} > 50 \text{ mm}$

When the minimum test separation distance is $< 5 \text{ mm}$, a distance of 5 mm is applied.

Band	Frequency (MHz)	Max. Power		Test Position	Distance (mm)	Estimated SAR (W/kg)
		(dBm)	(mW)			
Bluetooth	2480	7.5	6	Head	< 5	0.252
				Body	10	0.126

14.10.3 Sum of the SAR for GSM 850, WLAN & Bluetooth

RF Exposure Conditions	Test Position	Simultaneous Transmission Scenario						Σ 1 g SAR (W/kg)
		GSM 850	DTS		U-NII		BT	
			ANT 0	ANT 1	ANT 0	ANT 1		
Head	Left Touch	0.159	0.017	0.003				0.179
		0.159			0.088	0.059		0.306
		0.159					0.252	0.411
	Left Tilt	0.093	0.017	0.003				0.113
		0.093			0.088	0.059		0.240
		0.093					0.252	0.345
	Right Touch	0.141	0.017	0.003				0.161
		0.141			0.088	0.059		0.288
		0.141					0.252	0.393
	Right Tilt	0.085	0.017	0.003				0.105
		0.085			0.088	0.059		0.232
		0.085					0.252	0.337
Body-worn & Hotspot	Rear	0.213	0.667	0.059				0.939
		0.213			0.130	0.017		0.360
		0.213					0.126	0.339
	Front	0.210	0.004	0.000				0.214
		0.210			0.000	0.011		0.221
		0.210					0.126	0.336
Hotspot	Edge 1		0.667	0.059				0.726
	Edge 2	0.103	0.088					0.191
	Edge 3	0.029						0.029
	Edge 4	0.151		0.059				0.210

SAR to Peak Location Separation Ratio (SPLSR)

As the sum of the 1 g SAR is < 1.6 W/kg, SPLSR assessment is not required.

Conclusion:

Simultaneous transmission SAR measurement (Volume Scan) is not required because the sum of the 1 g SAR is < 1.6 W/kg.

14.10.4 Sum of the SAR for PCS 1900, WLAN & Bluetooth

RF Exposure Conditions	Test Position	Simultaneous Transmission Scenario						Σ 1 g SAR (W/kg)
		PCS 1900	DTS		U-NII		BT	
			ANT 0	ANT 1	ANT 0	ANT 1		
Head	Left Touch	0.057	0.017	0.003				0.077
		0.057			0.088	0.059		0.204
		0.057					0.252	0.309
	Left Tilt	0.020	0.017	0.003				0.040
		0.020			0.088	0.059		0.167
		0.020					0.252	0.272
	Right Touch	0.027	0.017	0.003				0.047
		0.027			0.088	0.059		0.174
		0.027					0.252	0.279
	Right Tilt	0.014	0.017	0.003				0.034
		0.014			0.088	0.059		0.161
		0.014					0.252	0.266
Body-worn & Hotspot	Rear	0.480	0.667	0.059				1.206
		0.480			0.130	0.017		0.627
		0.480					0.126	0.606
	Front	0.827	0.004	0.000				0.831
		0.827			0.000	0.011		0.838
		0.827					0.126	0.953
Hotspot	Edge 1		0.667	0.059				0.726
	Edge 2	0.017	0.088					0.105
	Edge 3	0.849						0.849
	Edge 4	0.107		0.059				0.166

SAR to Peak Location Separation Ratio (SPLSR)

As the sum of the 1 g SAR is < 1.6 W/kg, SPLSR assessment is not required.

Conclusion:

Simultaneous transmission SAR measurement (Volume Scan) is not required because the sum of the 1 g SAR is < 1.6 W/kg.

14.10.5 Sum of the SAR for W-CDMA Band II, WLAN & Bluetooth

RF Exposure Conditions	Test Position	Simultaneous Transmission Scenario						Σ 1 g SAR (W/kg)
		W-CDMA Band II	DTS		U-NII		BT	
			ANT 0	ANT 1	ANT 0	ANT 1		
Head	Left Touch	0.104	0.017	0.003				0.124
		0.104			0.088	0.059		0.251
		0.104					0.252	0.356
	Left Tilt	0.028	0.017	0.003				0.048
		0.028			0.088	0.059		0.175
		0.028					0.252	0.280
	Right Touch	0.046	0.017	0.003				0.066
		0.046			0.088	0.059		0.193
		0.046					0.252	0.298
	Right Tilt	0.033	0.017	0.003				0.053
		0.033			0.088	0.059		0.180
		0.033					0.252	0.285
Body-worn & Hotspot	Rear	0.717	0.667	0.059				1.443
		0.717			0.130	0.017		0.864
		0.717					0.126	0.843
	Front	0.934	0.004	0.000				0.938
		0.934			0.000	0.011		0.945
		0.934					0.126	1.060
Hotspot	Edge 1		0.667	0.059				0.726
	Edge 2	0.029	0.088					0.117
	Edge 3	0.678						0.678
	Edge 4	0.200		0.059				0.259

SAR to Peak Location Separation Ratio (SPLSR)

As the sum of the 1 g SAR is < 1.6 W/kg, SPLSR assessment is not required.

Conclusion:

Simultaneous transmission SAR measurement (Volume Scan) is not required because the sum of the 1 g SAR is < 1.6 W/kg.

14.10.6 Sum of the SAR for W-CDMA Band IV, WLAN & Bluetooth

RF Exposure Conditions	Test Position	Simultaneous Transmission Scenario						Σ 1 g SAR (W/kg)
		W-CDMA Band IV	DTS		U-NII		BT	
			ANT 0	ANT 1	ANT 0	ANT 1		
Head	Left Touch	0.200	0.017	0.003				0.220
		0.200			0.088	0.059		0.347
		0.200					0.252	0.452
	Left Tilt	0.066	0.017	0.003				0.086
		0.066			0.088	0.059		0.213
		0.066					0.252	0.318
	Right Touch	0.102	0.017	0.003				0.122
		0.102			0.088	0.059		0.249
		0.102					0.252	0.354
	Right Tilt	0.084	0.017	0.003				0.104
		0.084			0.088	0.059		0.231
		0.084					0.252	0.336
Body-worn & Hotspot	Rear	1.054	0.667	0.059				1.780
		1.054			0.130	0.017		1.201
		1.054					0.126	1.180
	Front	1.181	0.004	0.000				1.185
		1.181			0.000	0.011		1.192
		1.181					0.126	1.307
Hotspot	Edge 1		0.667	0.059				0.726
	Edge 2	0.040	0.088					0.128
	Edge 3	1.128						1.128
	Edge 4	0.201		0.059				0.260

SAR to Peak Location Separation Ratio (SPLSR)

Test Position	Worst-case combination			Σ 1 g SAR (W/kg)	Distance [mm]	SPLSR	Fig. No.
	W-CDMA Band IV	DTS					
		ANT 0	ANT 1				
Rear	1.054	0.667		1.721	120.5	0.019	1
	1.054		0.059	1.113	104.1	0.011	
		0.667	0.059	0.726	59.9	0.010	

Conclusion:

Simultaneous transmission SAR measurement (Volume Scan) is not required because the sum of the 1 g SAR is < 1.6 W/kg or the SPLSR is < 0.04 for all circumstances that require SPLSR calculation.

Figure 1

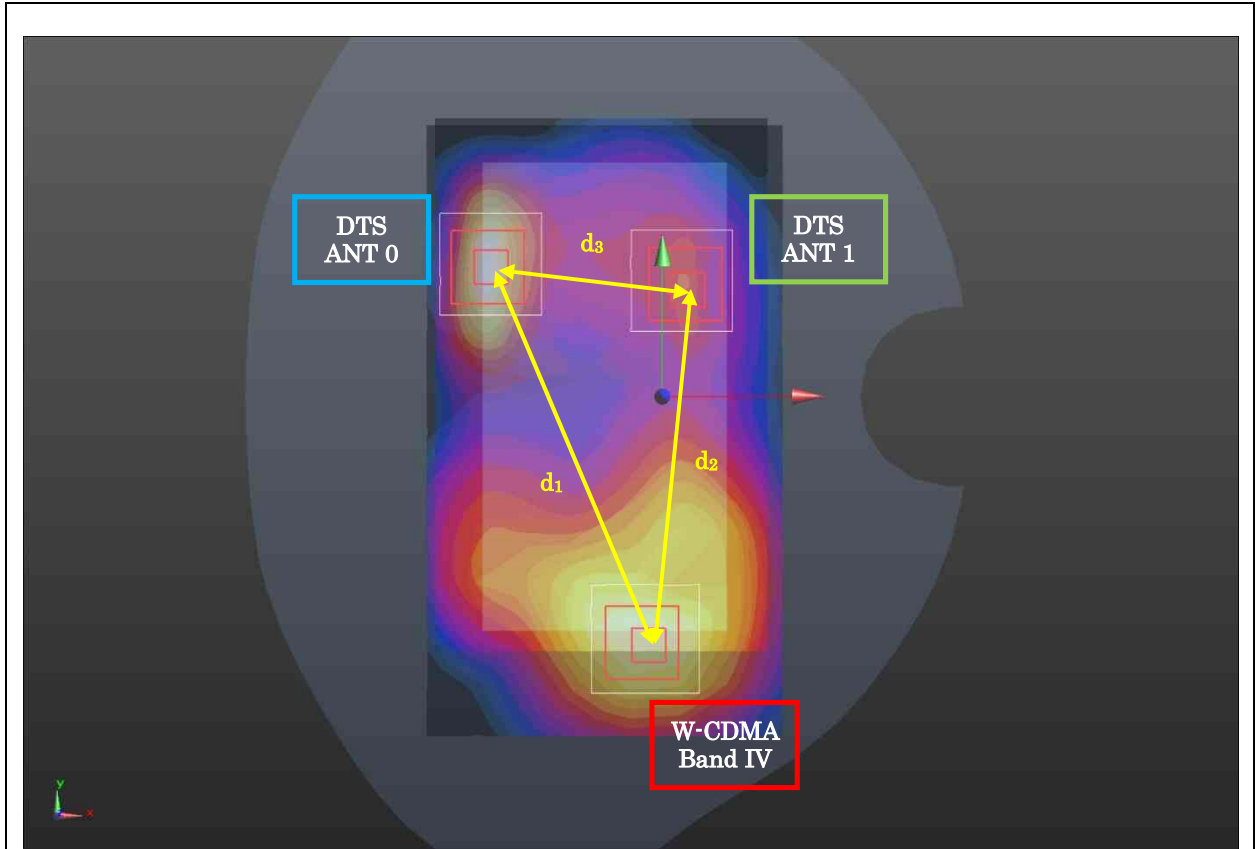

Band	x (m)	y (m)	z (m)
W-CDMA Band IV	0.0120	-0.0731	-0.0007
DTS ANT 0	-0.0346	0.0380	-0.0015
DTS ANT 1	0.0248	0.0302	-0.0016

Calculated Distance : d ₁ (mm)	120.5
Calculated Distance : d ₂ (mm)	104.1
Calculated Distance : d ₃ (mm)	59.9

Note(s):

The peak location separation distance is computed by the square root of $[(x_1-x_2)^2+(y_1-y_2)^2+(z_1-z_2)^2]$.

14.10.7 Sum of the SAR for LTE Band 2, WLAN & Bluetooth

RF Exposure Conditions	Test Position	Simultaneous Transmission Scenario						Σ 1 g SAR (W/kg)
		LTE Band 2	DTS		U-NII		BT	
			ANT 0	ANT 1	ANT 0	ANT 1		
Head	Left Touch	0.116	0.018	0.003				0.137
		0.116			0.088	0.059		0.263
		0.116					0.252	0.368
	Left Tilt	0.029	0.018	0.003				0.050
		0.029			0.088	0.059		0.176
		0.029					0.252	0.281
	Right Touch	0.052	0.018	0.003				0.073
		0.052			0.088	0.059		0.199
		0.052					0.252	0.304
	Right Tilt	0.038	0.018	0.003				0.059
		0.038			0.088	0.059		0.185
		0.038					0.252	0.290
Body-worn & Hotspot	Rear	0.974	0.667	0.059				1.700
		0.974			0.130	0.017		1.121
		0.974					0.126	1.100
	Front	1.023	0.004	0.000				1.027
		1.023			0.000	0.011		1.034
		1.023					0.126	1.149
Hotspot	Edge 1		0.667	0.059				0.726
	Edge 2	0.029	0.088					0.117
	Edge 3	0.759						0.759
	Edge 4	0.224		0.059				0.283

SAR to Peak Location Separation Ratio (SPLSR)

Test Position	Worst-case combination			Σ 1 g SAR (W/kg)	Distance [mm]	SPLSR	Fig. No.
	LTE Band 2	DTS					
		ANT 0	ANT 1				
Rear	0.974	0.667		1.641	119.6	0.018	2
	0.974		0.059	1.033	102.3	0.010	
		0.667	0.059	0.726	59.9	0.010	

Conclusion:

Simultaneous transmission SAR measurement (Volume Scan) is not required because the sum of the 1 g SAR is < 1.6 W/kg or the SPLSR is < 0.04 for all circumstances that require SPLSR calculation.

Figure 2

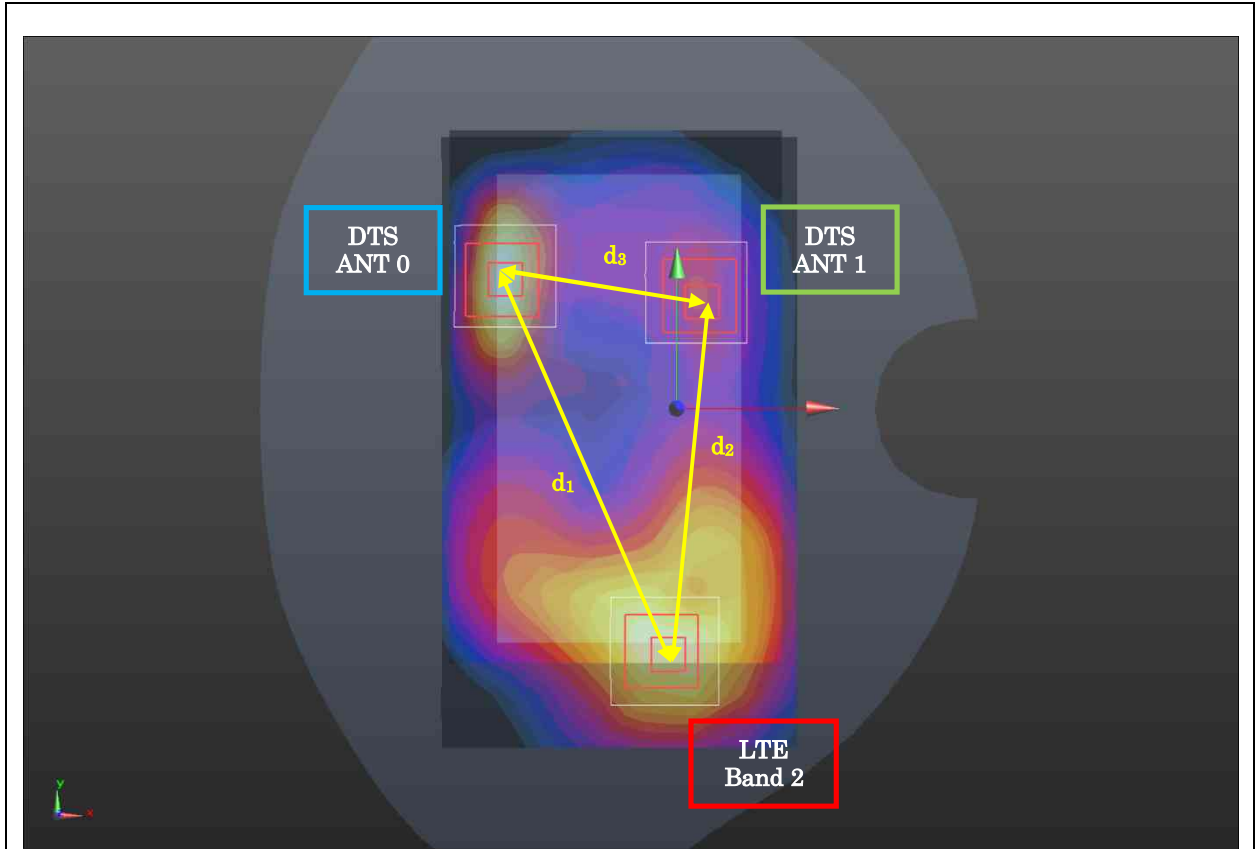

Band	x (m)	y (m)	z (m)
LTE Band 2	0.0135	-0.0715	-0.0007
DTS ANT 0	-0.0346	0.0380	-0.0015
DTS ANT 1	0.0248	0.0302	-0.0016

Calculated Distance : d ₁ (mm)	119.6
Calculated Distance : d ₂ (mm)	102.3
Calculated Distance : d ₃ (mm)	59.9

Note(s):

The peak location separation distance is computed by the square root of $[(x_1-x_2)^2+(y_1-y_2)^2+(z_1-z_2)^2]$.

14.10.8 Sum of the SAR for LTE Band 4, WLAN & Bluetooth

RF Exposure Conditions	Test Position	Simultaneous Transmission Scenario						Σ 1 g SAR (W/kg)
		LTE Band 4	DTS		U-NII		BT	
			ANT 0	ANT 1	ANT 0	ANT 1		
Head	Left Touch	0.196	0.018	0.003				0.217
		0.196			0.088	0.059		0.343
		0.196					0.252	0.448
	Left Tilt	0.064	0.018	0.003				0.085
		0.064			0.088	0.059		0.211
		0.064					0.252	0.316
	Right Touch	0.094	0.018	0.003				0.115
		0.094			0.088	0.059		0.241
		0.094					0.252	0.346
	Right Tilt	0.081	0.018	0.003				0.102
		0.081			0.088	0.059		0.228
		0.081					0.252	0.333
Body-worn & Hotspot	Rear	1.035	0.667	0.059				1.761
		1.035			0.130	0.017		1.182
		1.035					0.126	1.161
	Front	1.141	0.004	0.000				1.145
		1.141			0.000	0.011		1.152
		1.141					0.126	1.267
Hotspot	Edge 1		0.667	0.059				0.726
	Edge 2	0.037	0.088					0.125
	Edge 3	1.079						1.079
	Edge 4	0.196		0.059				0.255

SAR to Peak Location Separation Ratio (SPLSR)

Test Position	Worst-case combination			Σ 1 g SAR (W/kg)	Distance [mm]	SPLSR	Fig. No.
	LTE Band 4	DTS					
		ANT 0	ANT 1				
Rear	1.035	0.667		1.702	120.4	0.019	3
	1.035		0.059	1.094	104.1	0.011	
		0.667	0.059	0.726	59.9	0.010	

Conclusion:

Simultaneous transmission SAR measurement (Volume Scan) is not required because the sum of the 1 g SAR is < 1.6 W/kg or the SPLSR is < 0.04 for all circumstances that require SPLSR calculation.

Figure 3

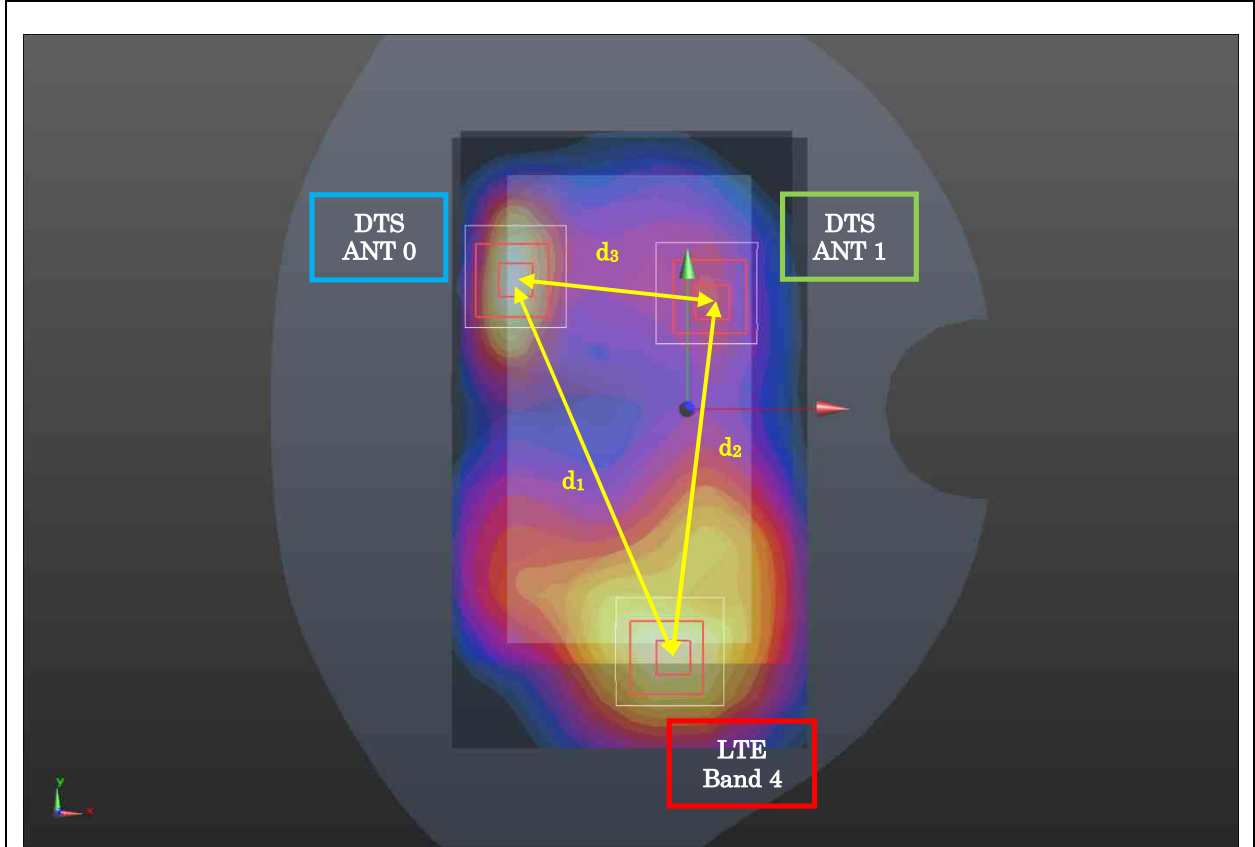

Band	x (m)	y (m)	z (m)
LTE Band 4	0.0119	-0.0730	-0.0003
DTS ANT 0	-0.0346	0.0380	-0.0015
DTS ANT 1	0.0248	0.0302	-0.0016

Calculated Distance : d ₁ (mm)	120.4
Calculated Distance : d ₂ (mm)	104.1
Calculated Distance : d ₃ (mm)	59.9

Note(s):

The peak location separation distance is computed by the square root of $[(x_1-x_2)^2+(y_1-y_2)^2+(z_1-z_2)^2]$.

16 Test Instruments

Shielded Room S3				
Type	Model	Serial No. (ID)	Manufacturer	Cal. Due
E-Field Probe	ET3DV6	1679 (S-2)	SPEAG	2016/08/11
E-Field Probe	EX3DV4	7321 (S-17)	SPEAG	2016/08/17
DAE	DAE4	508 (S-3)	SPEAG	2015/11/06
Robot	RX60L	F02/5R10A1/A/01 (S-7)	Stäubli	N/A
Probe Alignment Unit	LB5/80	SE UKS 030 AA (S-13)	SPEAG	N/A
Network Analyzer	8719ET	MY42000159 (B-53)	Agilent	2016/08/04
Dielectric Probe	DAK-3.5	1124 (S-32)	SPEAG	2016/07/08
835MHz Dipole	D835V2	4d081 (S-23)	SPEAG	2016/08/09
1750MHz Dipole	D1750V2	1012 (S-24)	SPEAG	2016/08/10
1900MHz Dipole	D1900V2	5d112 (S-25)	SPEAG	2016/08/10
2450MHz Dipole	D2450V2	714 (S-6)	SPEAG	2015/11/12
5GHz Dipole	D5GHzV2	1092	SPEAG	2015/11/11
Signal Generator	MG3681A	6100216166 (B-3)	Anritsu	2016/08/12
Signal Generator	MG3710A	6201171711 (B-41)	Anritsu	2016/08/13
RF Power Amplifier	CGA020M602-2633R	B10840 (A-51)	R&K	N/A
Directional Coupler	4226-20	03736 (D-87)	Narda Microwave	N/A
Base Station Simulator	MT8820C	6200918329 (B-5)	Anritsu	2016/03/02
Power Meter	E4417A	GB41290850 (B-51)	Agilent	2016/07/08
Power Sensor	E9323A	US40411939 (B-59)	Agilent	2016/07/07
Power Meter	N1911A	GB45100291 (B-63)	Agilent	2016/07/16
Power Sensor	N1921A	US44510470 (B-64)	Agilent	2016/07/16
Attenuator	54A-10	W5675 (D-28)	Weinschel	2016/08/16
Attenuator	2-20	BY7535 (D-36)	Weinschel	2015/10/26

NOTE : The calibration interval of the above test instruments is 12 months.

17 Appendix

Refer to separated files for the following appendixes.

Appendix 1 – System Performance Check Plots

Appendix 2 – Highest SAR Test Plots

Appendix 3 – Dosimetric E-Field Probe Calibration Data

Appendix 4 – System Validation Dipole Calibration Data