

TEST REPORT

Applicant : Sharp Corporation, Communication Systems Division
Address : 2-13-1, Iida Hachihonmatsu, Higashi-Hiroshima City, Hiroshima,
739-0192, Japan

Products : Smart Phone
Model No. : 502SH
Serial No. : 004401/11/553748/8
004401/11/553947/6

FCC ID : APYHRO00226

Test Standard : CFR 47 FCC Rules and Regulations Part 15

Test Results : **Passed**

Date of Test : September 4 ~ 16, 2015



Kousei Shibata
Manager
Japan Quality Assurance Organization
KITA-KANSAI Testing Center
SAITO EMC Branch
7-3-10, Saito-asagi, Ibaraki-shi, Osaka 567-0085, Japan

-
- The measurement values stated in Test Report was made with traceable to National Institute of Advanced Industrial Science and Technology (AIST) of Japan and National Institute of Information and Communications Technology (NICT) of Japan.
 - The applicable standard, testing condition and testing method which were used for the tests are based on the request of the applicant.
 - The test results presented in this report relate only to the offered test sample.
 - The contents of this test report cannot be used for the purposes, such as advertisement for consumers.
 - This test report shall not be reproduced except in full without the written approval of JQA.
 - VLAC does not approve, certify or warrant the product by this test report.

TABLE OF CONTENTS

	Page
1 Description of the Equipment Under Test	3
2 Summary of Test Results	4
3 Test Procedure.....	5
4 Test Location	5
5 Recognition of Test Laboratory	5
6 Description of Test Setup	6
7 Test Requirements	10

DEFINITIONS FOR ABBREVIATION AND SYMBOLS USED IN THIS TEST REPORT**EUT** : Equipment Under Test**AE** : Associated Equipment**N/A** : Not Applicable**N/T** : Not Tested**EMC** : Electromagnetic Compatibility**EMI** : Electromagnetic Interference**EMS** : Electromagnetic Susceptibility - indicates that the listed condition, standard or equipment is applicable for this report. - indicates that the listed condition, standard or equipment is not applicable for this report.

1 Description of the Equipment Under Test

1. Manufacturer : Sharp Corporation, Communication Systems Division
2-13-1, Iida Hachihonmatsu, Higashi-Hiroshima City, Hiroshima,
739-0192, Japan
2. Products : Smart Phone
3. Model No. : 502SH
4. Serial No. : 004401/11/553748/8
004401/11/553947/6
5. Product Type : Pre-production
6. Date of Manufacture : July, 2015
7. Power Rating : 4.0VDC (Lithium-ion Battery LIS1613SPPC(SY6) 3100mAh)
8. Grounding : None
9. Transmitting Frequency : WLAN: 2412.0 MHz(01CH) –2462.0MHz(11CH)
Bluetooth LE: 2402.0 MHz(00CH) – 2480.0MHz(39CH)
10. Receiving Frequency : WLAN: 2412.0 MHz(01CH) –2462.0MHz(11CH)
Bluetooth LE: 2402.0 MHz(00CH) – 2480.0MHz(39CH)
11. Max. RF Output Power : 18.10 dBm(Measure Value of IEEE802.11b)
24.62 dBm(Measure Value of IEEE802.11g)
24.78 dBm(Measure Value of IEEE802.11n)
3.46 dBm(Measure Value of Bluetooth LE)
12. Antenna Type : Inverted-L Type Antenna (Integral)
13. Antenna Gain : 0 dBi (Main/Sub)
14. Category : DTS
15. EUT Authorization : Certification
16. Received Date of EUT : September 3, 2015

17. Channel Plan

WLAN:

The carrier spacing is 5 MHz.

The carrier frequency is designated by the absolute frequency channel number (ARFCN).

The carrier frequency is expressed in the equation shown as follows:

$$\text{Transmitting Frequency (in MHz)} = 2407.0 + 5*n$$

$$\text{Receiving Frequency (in MHz)} = 2407.0 + 5*n$$

where, n : channel number ($1 \leq n \leq 11$)

Bluetooth Low Energy Mode:

The carrier spacing is 2 MHz.

The carrier frequency is designated by the absolute frequency channel number (ARFCN).

The carrier frequency is expressed in the equation shown as follows:

$$\text{Transmitting Frequency (in MHz)} = 2402.0 + 2*n$$

$$\text{Receiving Frequency (in MHz)} = 2402.0 + 2*n$$

where, n : channel number ($0 \leq n \leq 39$)

2 Summary of Test Results

Applied Standard : CFR 47 FCC Rules and Regulations Part 15
Subpart C – Intentional Radiators

The EUT described in clause 1 was tested according to the applied standard shown above.
Details of the test configuration is shown in clause 6.

The conclusion for the test items of which are required by the applied standard is indicated under the test result.

- The test result was **passed** for the test requirements of the applied standard.
- The test result was **failed** for the test requirements of the applied standard.
- The test result was **not judged** the test requirements of the applied standard.

In the approval of test results,

- Determining compliance with the limits in this report was based on the results of the compliance measurement, not taking into account measurement instrumentation uncertainty.
- No deviations were employed from the applied standard.
- No modifications were conducted by JQA to achieve compliance to the limitations.

Reviewed by:

Tested by:



Shigeru Kinoshita
Assistant Manager
JQA KITA-KANSAI Testing Center
SAITO EMC Branch



Shigeru Osawa
Deputy Manager
JQA KITA-KANSAI Testing Center
SAITO EMC Branch

3 Test Procedure

Test Requirements : §15.247, §15.207 and §15.209

Test Procedure : ANSI C63.10–2009
Testing unlicensed wireless devices.

KDB 558074 D01
DTS Meas Guidance v03r03: June 9, 2015.

KDB 662911 D01
Multiple Transmitter Output v02r01: October 31, 2013

4 Test Location

Japan Quality Assurance Organization (JQA)
KITA-KANSAI Testing Center
7-7, Ishimaru, 1-chome, Minoh-shi, Osaka, 562-0027, Japan
SAITO EMC Branch
7-3-10, Saito-asagi, Ibaraki-shi, Osaka 567-0085, Japan

5 Recognition of Test Laboratory

JQA KITA-KANSAI Testing Center SAITO EMC Branch is accredited under ISO/IEC 17025 by following accreditation bodies and the test facility is registered by the following bodies.

VLAC Accreditation No. : VLAC-001-2 (Expiry date : March 30, 2016)
VCCI Registration No. : A-0002 (Expiry date : March 30, 2016)
BSMI Registration No. : SL2-IS-E-6006, SL2-IN-E-6006, SL2-R1/R2-E-6006, SL2-A1-E-6006
(Expiry date : September 14, 2016)
IC Registration No. : 2079E-3, 2079E-4 (Expiry date : July 16, 2017)

Accredited as conformity assessment body for Japan electrical appliances and material law by METI.
(Expiry date : February 22, 2016)

6 Description of Test Setup

6.1 Test Configuration

The equipment under test (EUT) consists of :

	Item	Manufacturer	Model No.	Serial No.	FCC ID
A	Smart Phone	Sharp	502SH	004401/11/553748/8 *1) 004401/11/553947/6 *2)	APYHRO00226
B	AC Adapter	Hosiden	ZTDAC1	D7A	N/A
C	Earphone	Softbank Mobile	ZTCAA1	--	N/A
D	DTV Antenna	Sharp	--	--	N/A

*1) Used for AC Powerline Conducted Emission and Field Strength of Spurious Emission

*2) Used for Antenna Conducted Emission

The auxiliary equipment used for testing :

None

Type of Cable:

No.	Description	Identification (Manu. etc.)	Connector Shielded	Cable Shielded	Ferrite Core	Length (m)
1	USB conversion cable	--	--	NO	NO	1.5
2	Earphone Cable	--	--	NO	NO	0.5
3	DTV Antenna Cable	--	--	NO	NO	0.1

6.2 Test Arrangement (Drawings)

a) Single Unit

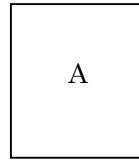

b) AC Adapter used

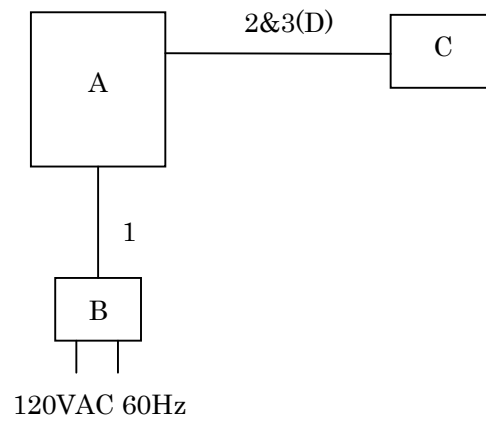

c) Earphone used

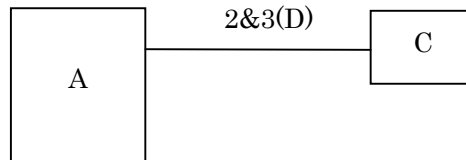

6.3 Operating Condition

Power Supply Voltage : 4.0 VDC (for Battery)
 120 VAC, 60 Hz (For AC Adapter)

Transmitting/Receiving

WLAN:

Transmitting frequency : 2412.0 MHz(1CH) – 2462.0 MHz(11CH)
 Receiver frequency : 2412.0 MHz(1CH) – 2462.0 MHz(11CH)

Bluetooth Low Energy Mode(Bluetooth 4.0 + EDR + LE):

Transmitting frequency : 2402.0 MHz(0CH) – 2480.0 MHz(39CH)
 Receiver frequency : 2402.0 MHz(0CH) – 2480.0 MHz(39CH)

Modulation Type

1. 802.11b : DSSS
2. 802.11g : OFDM
3. 802.11n : OFDM
4. LE Packet (Modulation Type : GFSK)

The equipment has two antennas(Main Antenna[ANT0]/Sub Antenna[ANT1]) in the WLAN mode, and uses the MIMO technology.

This equipment works in 1TX(Main) and 2TX(Main+Sub) mode.

Therefore, the radiated emission tests were carried out in the following mode.

- a) 1TX (Main)
- b) 2TX (Main+Sub)

In 1TX mode and 2TX mode, the output level in each antenna is the same.

Other Clock Frequency

19.2MHz, 48MHz, 12MHz, 27.12MHz

The tests were performed in the following worst condition.

Mode	Condition
IEEE802.11b	11 Mbps
IEEE802.11g	24 Mbps
IEEE802.11n	MCS4 (39 Mbps)

Note: The worst condition was determined based on the test result of Maximum Peak Output Power(Mid channel).(Main Antenna)

The EUT was rotated through three orthogonal axis (X, Y and Z axis) in radiated measurement.

The EUT with temporary antenna port was used in conducted measurement.

DIRECTIONAL ANTENNA GAIN

For Power: The TX chains are uncorrelated and the antenna gain is the same for each chain. The directional gain is equal to the antenna gain.

ANT0 Antenna Gain [dBi]	ANT1 Antenna Gain [dBi]	Uncorrelated Chains Directional Gain [dBi]
0.00	0.00	0.00

For PSD: The TX chains are correlated. The directional gain is:

ANT0 Antenna Gain [dBi]	ANT1 Antenna Gain [dBi]	Correlated Chains Directional Gain [dBi]
0.00	0.00	3.01

7 Test Requirements

7.0 Summary of the Test Results

Test Item	FCC Specification	Reference of the Test Report	Results	Remarks
Antenna Requirement	Section 15.203	Section 1.12	Passed	-
Channel Separation	Section 15.247(a)(1)	-	-	-
Minimum Hopping Channel	Section 15.247(a)(1)(iii)	-	-	-
Occupied Bandwidth	Section 15.247(a)(2)	Section 7.3	Passed	-
Dwell Time	Section 15.247(a)(1)(iii)	-	-	-
Peak Output Power (Conduction)	Section 15.247(b)(3)	Section 7.5	Passed	-
Peak Power Density (Conduction)	Section 15.247(e)	Section 7.6	Passed	-
Spurious Emissions (Conduction)	Section 15.247(d)	Section 7.7	Passed	-
AC Powerline Conducted Emission	Section 15.207	Section 7.8	Passed	-
Radiated Emission	Section 15.247(d)	Section 7.9	Passed	-

7.1 Channel Separation

For the requirements, - Applicable [- Tested. - Not tested by applicant request.]
 - Not Applicable

Remarks : _____

7.2 Minimum Hopping Channel

For the requirements, - Applicable [- Tested. - Not tested by applicant request.]
 - Not Applicable

Remarks : _____

7.3 Occupied Bandwidth

For the requirements, - Applicable [- Tested. - Not tested by applicant request.]
 - Not Applicable

7.3.1 Test Results

For the standard, - **Passed** - **Failed** - **Not judged**

The 99% Bandwidth of IEEE802.11b is	<u>12.872</u> MHz	at	<u>2462.0</u> MHz
The 99% Bandwidth of IEEE802.11g is	<u>16.444</u> MHz	at	<u>2437.0</u> MHz
The 99% Bandwidth of IEEE802.11n is	<u>17.640</u> MHz	at	<u>2412.0</u> MHz
The 99% Bandwidth of Bluetooth LE is	<u>1098.2</u> kHz	at	<u>2440.0</u> MHz

The 6dB Bandwidth of IEEE802.11b is	<u>8.373</u> MHz	at	<u>2462.0</u> MHz
The 6dB Bandwidth of IEEE802.11g is	<u>16.511</u> MHz	at	<u>2437.0</u> MHz
The 6dB Bandwidth of IEEE802.11n is	<u>17.712</u> MHz	at	<u>2412/2437</u> MHz
The 6dB Bandwidth of Bluetooth LE is	<u>679.3</u> kHz	at	<u>2440.0</u> MHz

Uncertainty of Measurement Results ± 0.9 %(2σ)

Remarks : _____

7.3.2 Test Instruments

Shielded Room S4				
Type	Model	Serial No. (ID)	Manufacturer	Cal. Due
Spectrum Analyzer	E4446A	US44300388 (A-39)	Agilent	2016/08/11
Attenuator	54A-10	W5675 (D-28)	Weinschel	2016/08/16
RF Cable	SUCOFLEX102	14253/2 (C-52)	HUBER+SUHNER	2016/08/16

NOTE : The calibration interval of the above test instruments is 12 months.

7.3.3 Test Method and Test Setup (Diagrammatic illustration)

The test system is shown as follows:

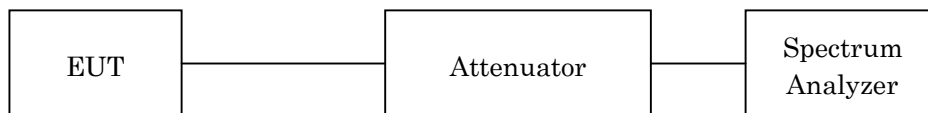

The setting of the spectrum analyzer are shown as follows:

	WLAN	Bluetooth
Res. Bandwidth	100 kHz	100 kHz
Video Bandwidth	300 kHz	300 kHz
Span	30 MHz	3 MHz
Sweep Time	AUTO	AUTO
Trace	Maxhold	Maxhold

7.3.4 Test Data

Mode of EUT : WLAN

Test Date : September 11, 2015

Temp.:26°C, Humi:57%

The resolution bandwidth was set to 100 kHz, -6dBc display line was placed on the screen (or 99% bandwidth), the occupied bandwidth is the delta frequency between the two points where the display line intersects the signal trace.

A) IEEE 802.11b

1) Main Antenna

Channel	Frequency (MHz)	99% Bandwidth (MHz)	-6dBc Bandwidth (MHz)	Minimum -6dBc Bandwidth Limit (kHz)
01	2412.0	12.801	7.956	500
06	2437.0	12.848	7.538	500
11	2462.0	12.798	7.989	500

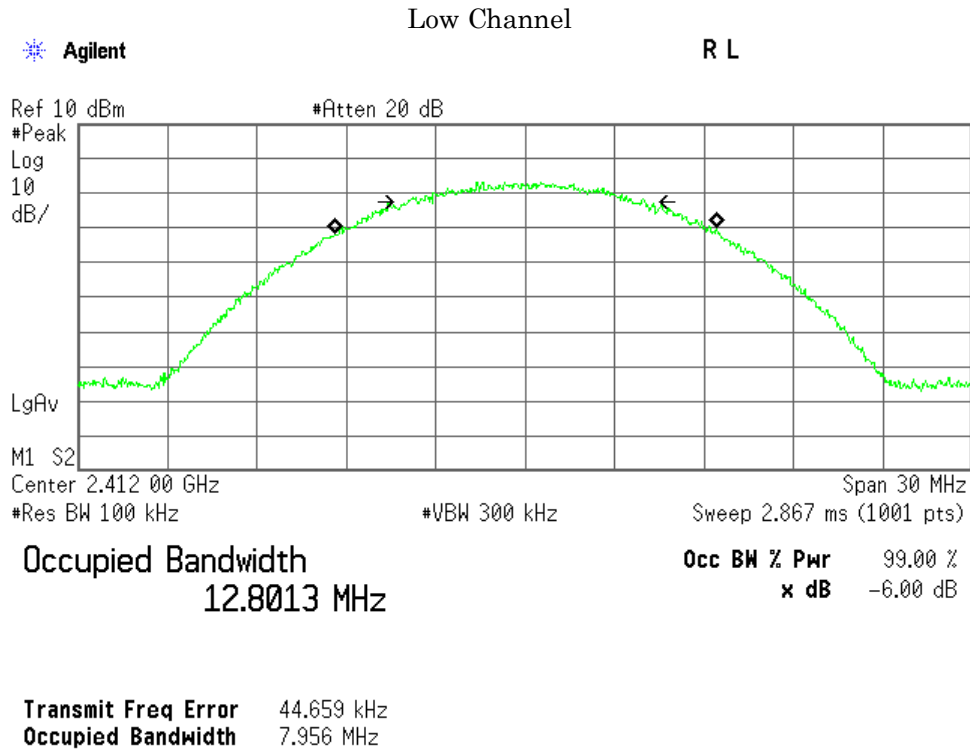

Middle Channel

Agilent

R L

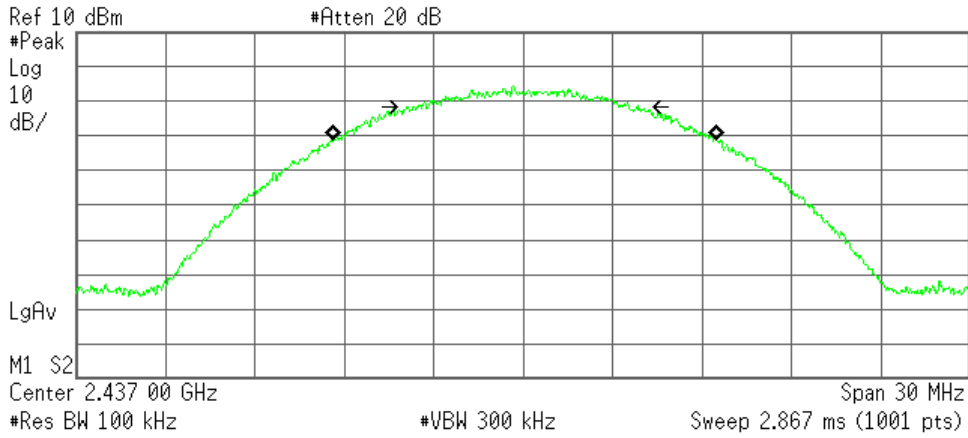

Occupied Bandwidth
12.8484 MHz

Occ BW % Pwr 99.00 %
x dB -6.00 dB

Transmit Freq Error 57.905 kHz
Occupied Bandwidth 7.538 MHz

High Channel

Agilent

R T

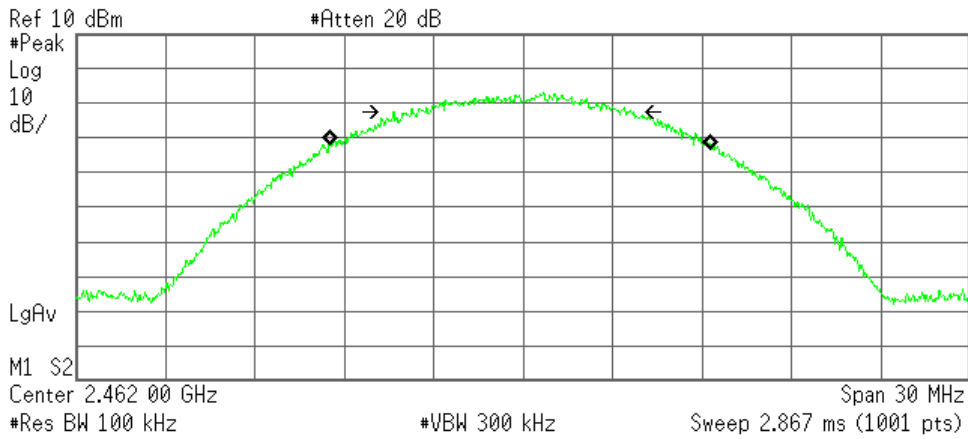

Occupied Bandwidth
12.7979 MHz

Occ BW % Pwr 99.00 %
x dB -6.00 dB

Transmit Freq Error -91.095 kHz
Occupied Bandwidth 7.989 MHz

2) Sub Antenna

Channel	Frequency (MHz)	99% Bandwidth (MHz)	-6dBc Bandwidth (MHz)	Minimum -6dBc Bandwidth Limit (kHz)
01	2412.0	12.831	8.065	500
06	2437.0	12.779	7.224	500
11	2462.0	12.872	8.373	500

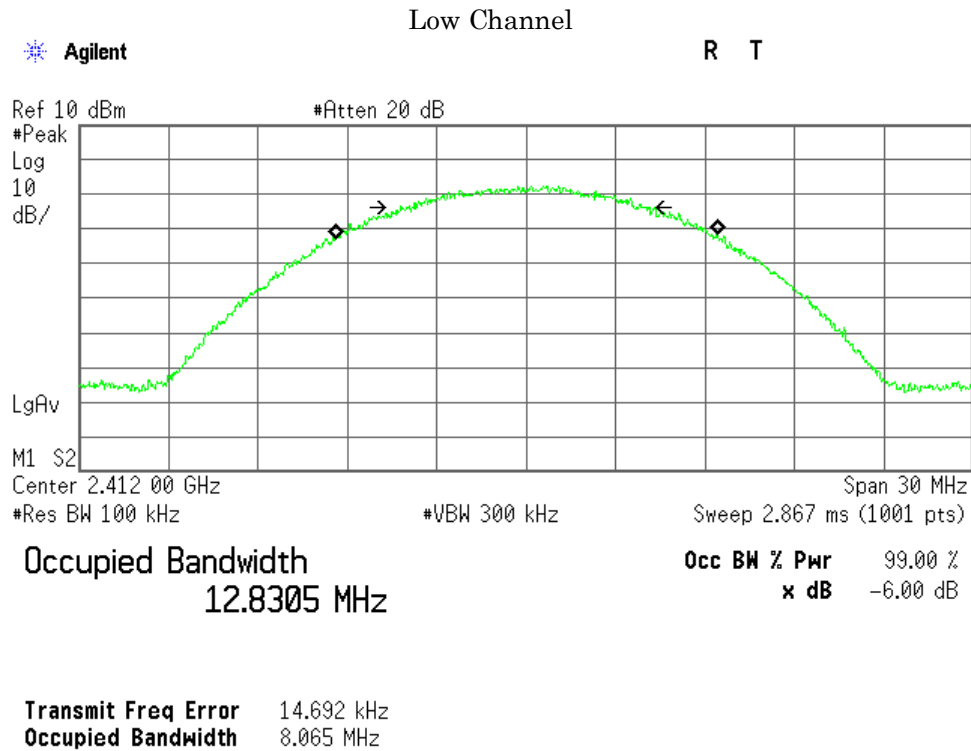

Middle Channel

Agilent

R L

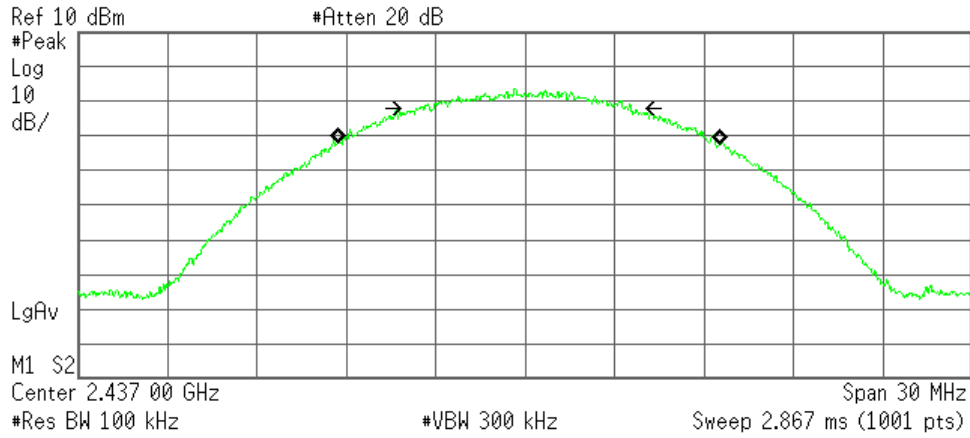

Occupied Bandwidth
12.7785 MHz

Occ BW % Pwr 99.00 %
x dB -6.00 dB

Transmit Freq Error 107.101 kHz
Occupied Bandwidth 7.224 MHz

High Channel

Agilent

R T

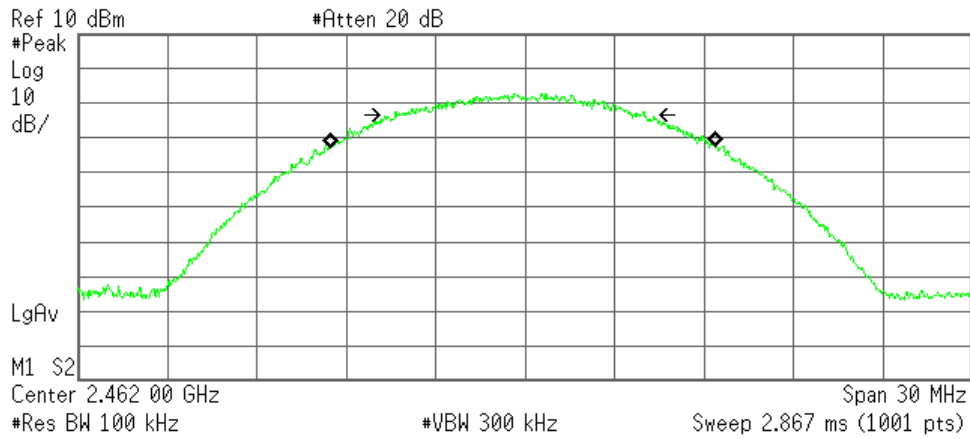

Occupied Bandwidth
12.8724 MHz

Occ BW % Pwr 99.00 %
x dB -6.00 dB

Transmit Freq Error -82.338 kHz
Occupied Bandwidth 8.373 MHz

B) IEEE 802.11g

1) Main Antenna

Channel	Frequency (MHz)	99% Bandwidth (MHz)	-6dBc Bandwidth (MHz)	Minimum -6dBc Bandwidth Limit (kHz)
01	2412.0	16.442	16.508	500
06	2437.0	16.441	16.511	500
11	2462.0	16.433	16.478	500

Low Channel

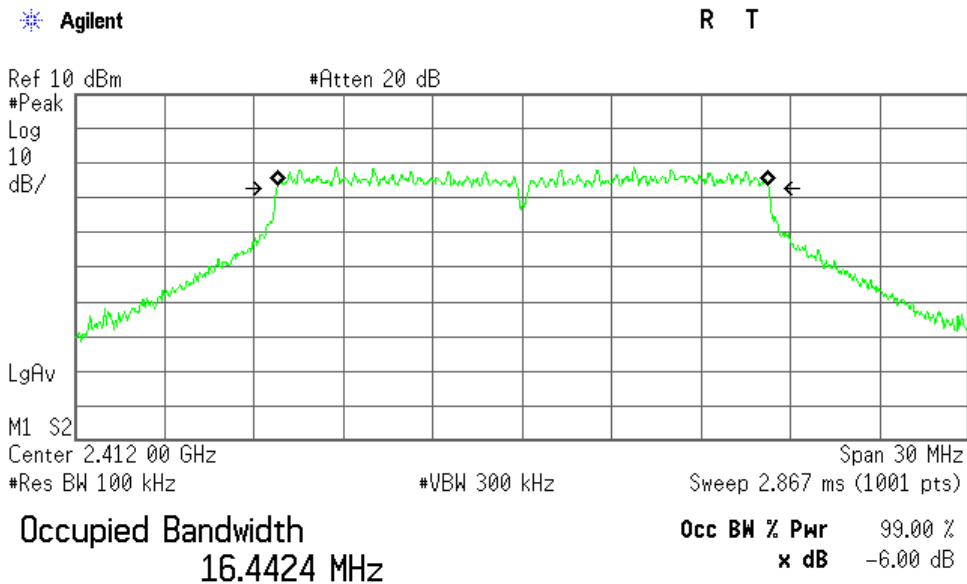

Transmit Freq Error 28.188 kHz
Occupied Bandwidth 16.508 MHz

Middle Channel

Agilent

R L

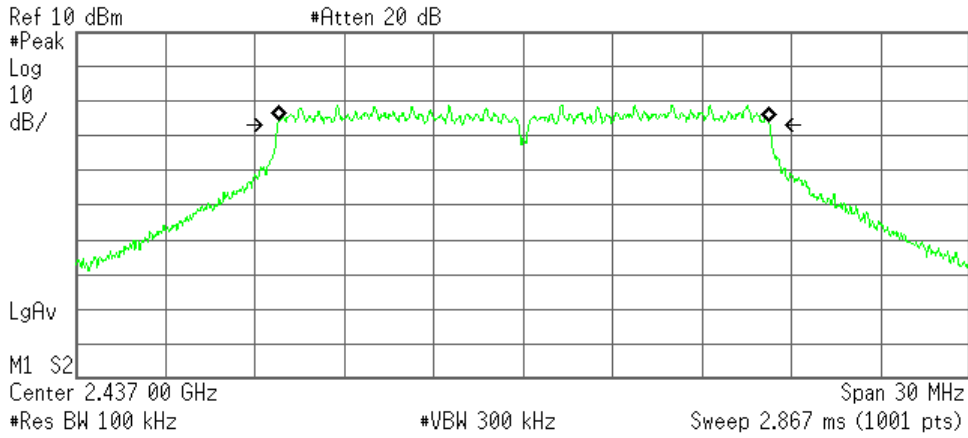

Occupied Bandwidth
16.4414 MHz

Occ BW % Pwr 99.00 %
x dB -6.00 dB

Transmit Freq Error 24.271 kHz
Occupied Bandwidth 16.511 MHz

High Channel

Agilent

R T

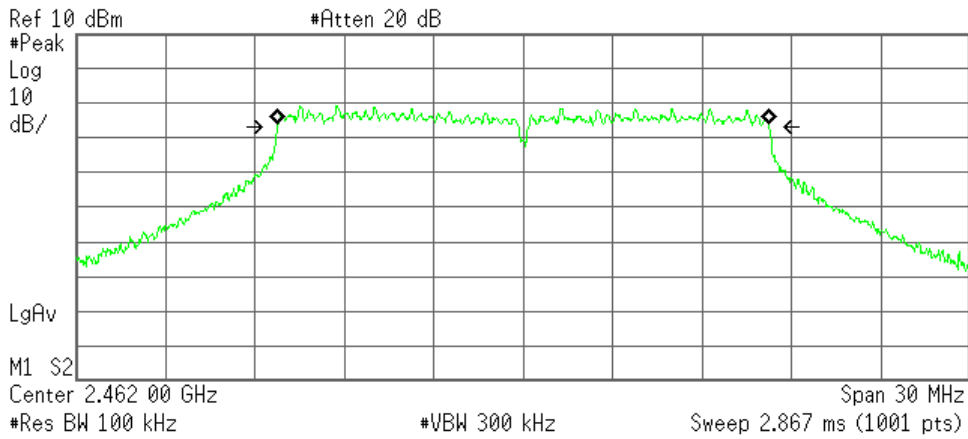

Occupied Bandwidth
16.4332 MHz

Occ BW % Pwr 99.00 %
x dB -6.00 dB

Transmit Freq Error 7.178 kHz
Occupied Bandwidth 16.478 MHz

2) Sub Antenna

Channel	Frequency (MHz)	99% Bandwidth (MHz)	-6dBc Bandwidth (MHz)	Minimum -6dBc Bandwidth Limit (kHz)
01	2412.0	16.441	16.507	500
06	2437.0	16.444	16.483	500
11	2462.0	16.438	16.484	500

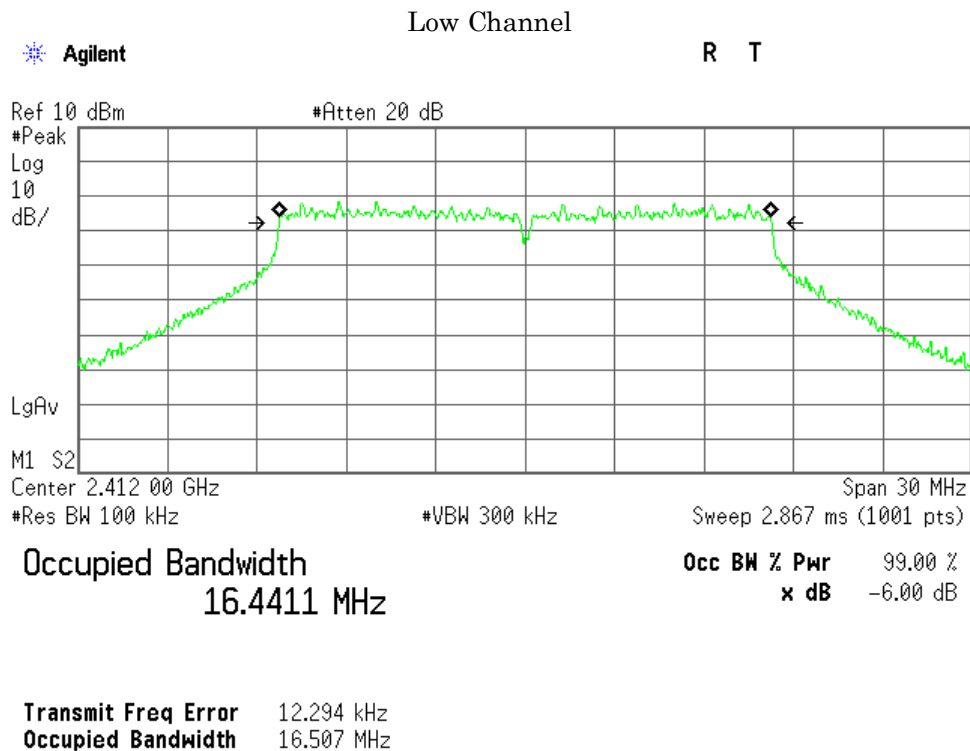

Middle Channel

Agilent

R T

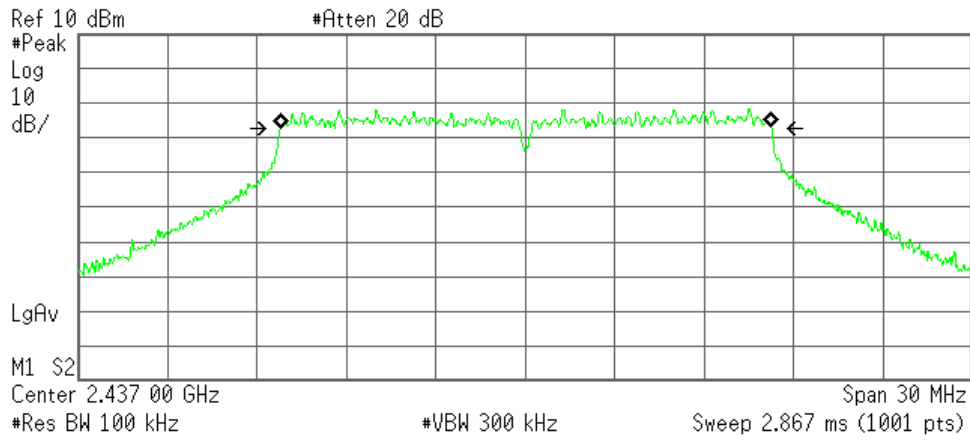

Occupied Bandwidth
16.4444 MHz

Occ BW % Pwr 99.00 %
x dB -6.00 dB

Transmit Freq Error 32.634 kHz
Occupied Bandwidth 16.483 MHz

High Channel

Agilent

R L

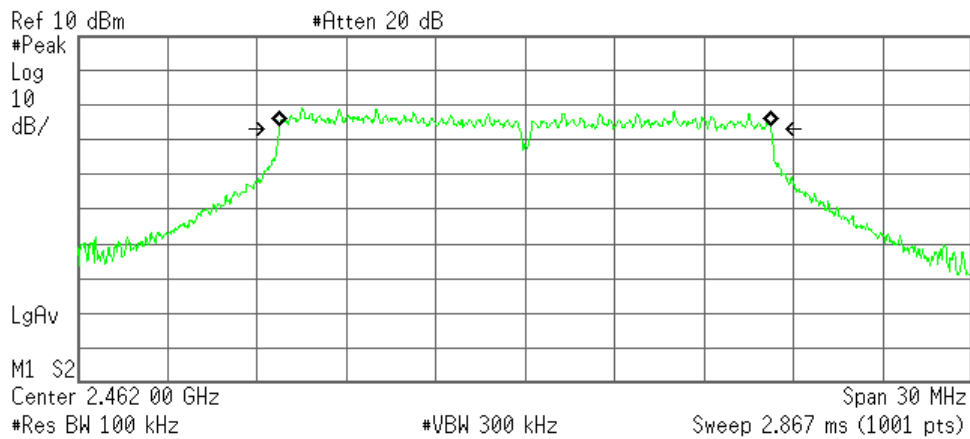

Occupied Bandwidth
16.4377 MHz

Occ BW % Pwr 99.00 %
x dB -6.00 dB

Transmit Freq Error -3.004 kHz
Occupied Bandwidth 16.484 MHz

C) IEEE 802.11n
1) Main Antenna

Channel	Frequency (MHz)	99% Bandwidth (MHz)	-6dBc Bandwidth (MHz)	Minimum -6dBc Bandwidth Limit (kHz)
01	2412.0	17.636	17.697	500
06	2437.0	17.634	17.712	500
11	2462.0	17.623	17.666	500

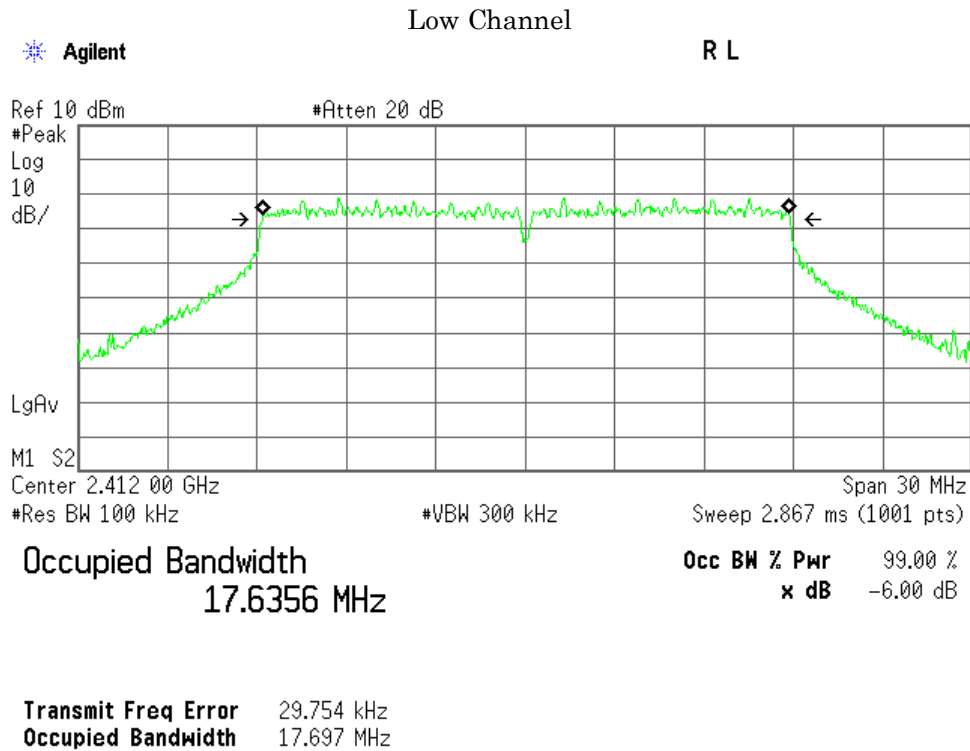

Middle Channel

Agilent

R L

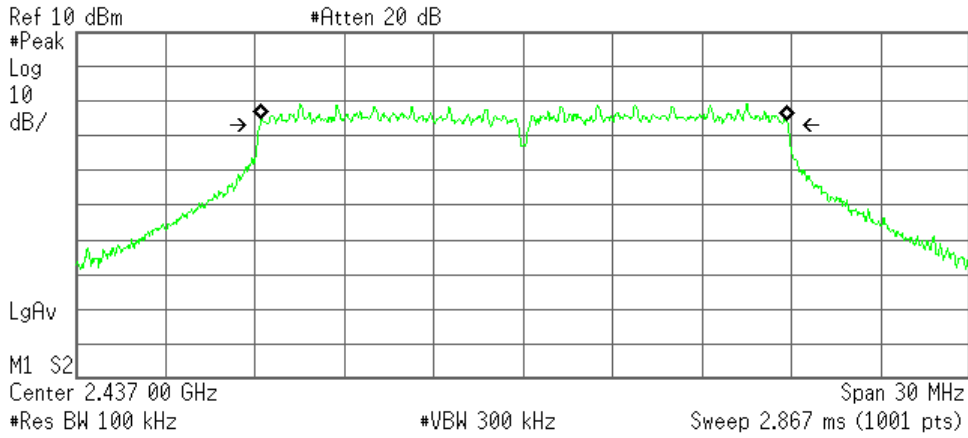

Occupied Bandwidth
17.6340 MHz

Occ BW % Pwr 99.00 %
x dB -6.00 dB

Transmit Freq Error 25.550 kHz
Occupied Bandwidth 17.712 MHz

High Channel

Agilent

R L

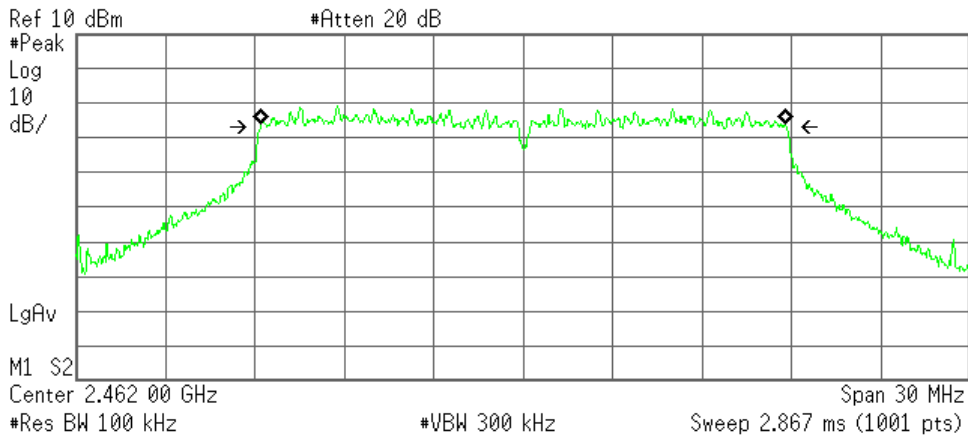

Occupied Bandwidth
17.6231 MHz

Occ BW % Pwr 99.00 %
x dB -6.00 dB

Transmit Freq Error 5.828 kHz
Occupied Bandwidth 17.666 MHz

2) Sub Antenna

Channel	Frequency (MHz)	99% Bandwidth (MHz)	-6dBc Bandwidth (MHz)	Minimum -6dBc Bandwidth Limit (kHz)
01	2412.0	17.640	17.712	500
06	2437.0	17.638	17.693	500
11	2462.0	17.631	17.682	500

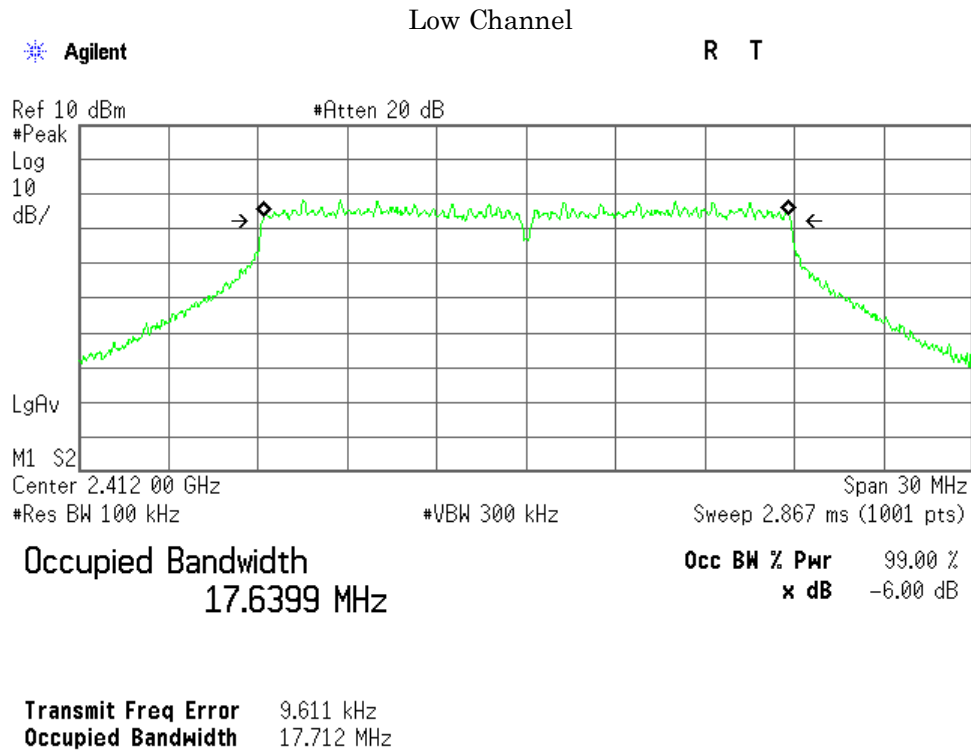

Middle Channel

Agilent

R T

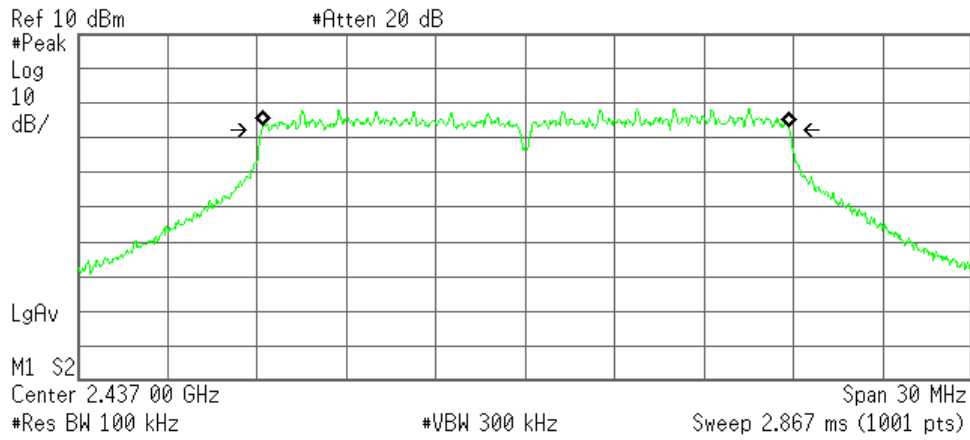

Occupied Bandwidth
17.6379 MHz

Occ BW % Pwr 99.00 %
x dB -6.00 dB

Transmit Freq Error 20.766 kHz
Occupied Bandwidth 17.693 MHz

High Channel

Agilent

R L

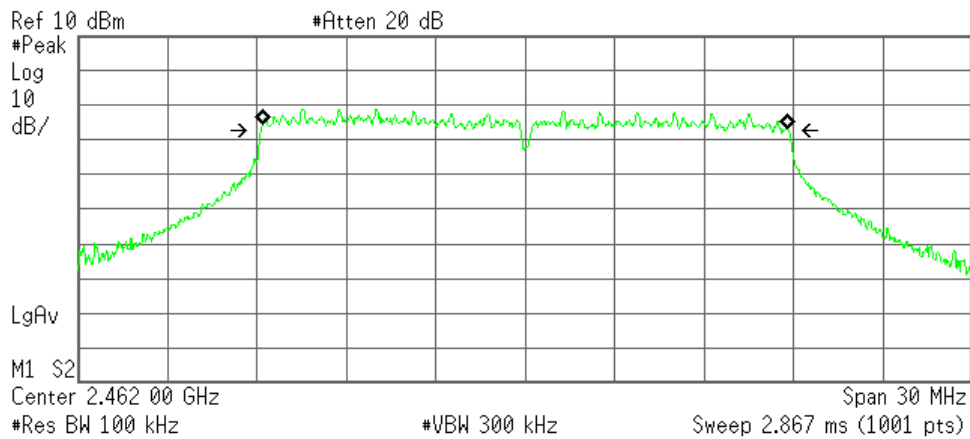

Occupied Bandwidth
17.6306 MHz

Occ BW % Pwr 99.00 %
x dB -6.00 dB

Transmit Freq Error -3.433 kHz
Occupied Bandwidth 17.682 MHz

Mode of EUT : Bluetooth Low Energy

Test Date : September 12, 2015

Temp.:25°C, Humi:59%

The resolution bandwidth was set to 100 kHz, -6dBc display line was placed on the screen (or 99% bandwidth), the occupied bandwidth is the delta frequency between the two points where the display line intersects the signal trace.

1)Packet Setting : LE (Modulation type : GFSK)

Channel	Frequency (MHz)	99% Bandwidth (kHz)	-6dBc Bandwidth (kHz)	Minimum -6dBc Bandwidth Limit (kHz)
00	2402.0	1096.2	670.5	500
19	2440.0	1098.2	679.3	500
39	2480.0	1096.7	665.7	500

1)Packet Setting : LE (Modulation type : GFSK)

Low Channel

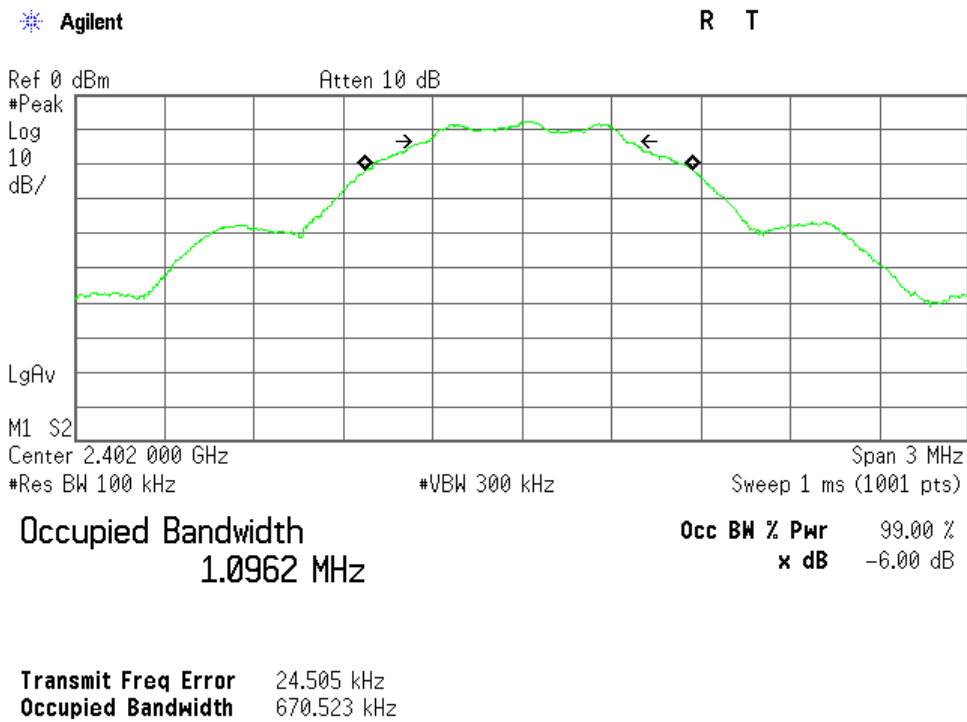

Middle Channel

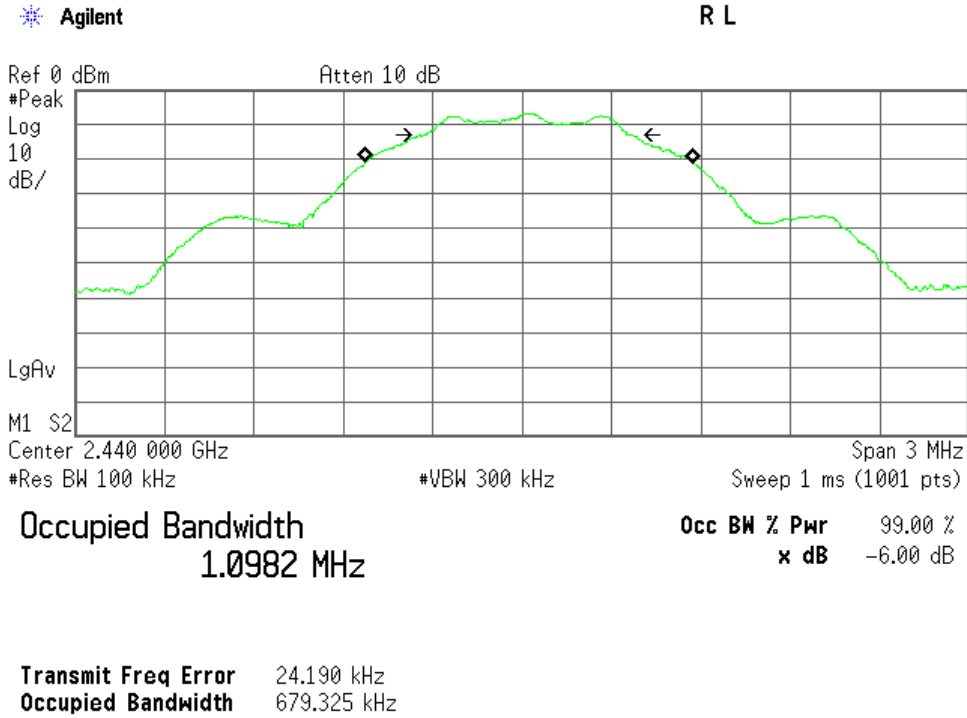

High Channel

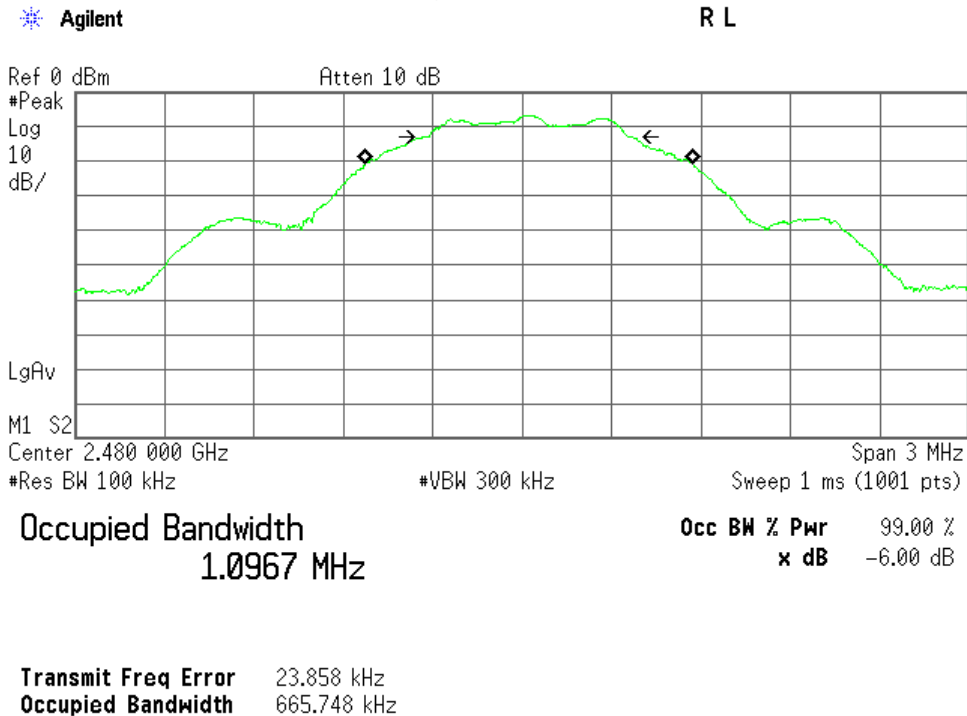

7.4 Dwell Time

For the requirements, - Applicable [- Tested. - Not tested by applicant request.]
 - Not Applicable

Remarks : _____

7.5 Peak Output Power(Conduction)

For the requirements, - Applicable [- Tested. - Not tested by applicant request.]
 - Not Applicable

7.5.1 Test Results

For the standard, - **Passed** - **Failed** - **Not judged**

Peak Output Power of IEEE802.11b is	<u>18.10</u>	dBm	at	<u>2437.0</u>	MHz
Peak Output Power of IEEE802.11g is	<u>24.62</u>	dBm	at	<u>2437.0</u>	MHz
Peak Output Power of IEEE802.11n is	<u>24.78</u>	dBm	at	<u>2437.0</u>	MHz
Peak Output Power of Bluetooth LE is	<u>3.46</u>	dBm	at	<u>2440.0</u>	MHz

Uncertainty of Measurement Results ± 0.9 dB(2 σ)

Remarks : _____

7.5.2 Test Instruments

Shielded Room S4				
Type	Model	Serial No. (ID)	Manufacturer	Cal. Due
Power Meter	N1911A	GB45100291 (B-63)	Agilent	2016/07/16
Power Sensor	N1921A	US44510470 (B-64)	Agilent	2016/07/16
Attenuator	54A-10	W5675 (D-28)	Weinschel	2016/08/16
RF Cable	SUCOFLEX102	14253/2 (C-52)	HUBER+SUHNER	2016/08/16

NOTE : The calibration interval of the above test instruments is 12 months.

7.5.3 Test Method and Test Setup (Diagrammatic illustration)

The Conducted RF Power Output was measured with a power meter, one attenuator and a short, low loss cable.

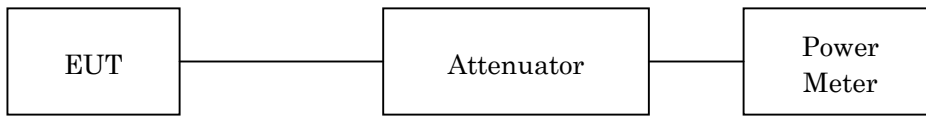

7.5.4 Test Data

1) IEEE 802.11b

Data Rate : 11Mbps

Test Date: September 4, 2015
 Temp.: 26 °C, Humi: 57 %

Transmitting Frequency		Correction Factor [dB]	Meter Reading			Conducted Peak Output Power		Limits [dBm]	Margin [dB]
CH	[MHz]		ANT0 [dBm]	ANT1 [dBm]	Total [dBm]	[dBm]	[mW]		
01	2412	10.06	4.70	3.46	7.13	17.19	52.36	30.00	+12.81
06	2437	10.08	5.47	4.50	8.02	18.10	64.57	30.00	+11.90
11	2462	10.08	3.96	3.83	6.91	16.99	50.00	30.00	+13.01

Calculated result at 2437.000 MHz, as the worst point shown on underline:

Correction Factor	=	10.08 dB
+) Meter Reading	=	8.02 dBm
Result	=	18.10 dBm = 64.57 mW

Minimum Margin: 30.00 - 18.10 = 11.90 (dB)

NOTES

- The correction factor shows the attenuation pad loss including the short, low loss cable or adapter.
- Setting of measuring instrument(s) :

Detector Function	Video B.W.
Peak	OFF

CH	[MHz]	Rate	Meter Reading [dBm]	Remark
06	2437			
		1Mbps	5.11	
		2Mbps	5.24	
		5.5Mbps	5.13	
		11Mbps	5.47	*

* : Worst Rate

All comparison were performed on the same measurement condition.

2) IEEE 802.11g

Test Date: September 4, 2015
 Temp.: 26 °C, Humi: 57 %

Data Rate : 24Mbps

CH	Transmitting Frequency [MHz]	Correction Factor [dB]	Meter Reading			Conducted Peak Output Power		Limits [dBm]	Margin [dB]
			ANT0 [dBm]	ANT1 [dBm]	Total [dBm]	[dBm]	[mW]		
01	2412	10.06	11.76	10.89	14.36	24.42	276.69	30.00	+ 5.58
06	2437	10.08	11.82	11.21	14.54	24.62	289.73	30.00	+ 5.38
11	2462	10.08	11.21	10.72	13.98	24.06	254.68	30.00	+ 5.94

Calculated result at 2437.000 MHz, as the worst point shown on underline:

Correction Facto	=	10.08 dB
+) Meter Reading	=	14.54 dBm
Result	=	24.62 dBm = 289.73 mW

Minimum Margin: 30.00 - 24.62 = 5.38 (dB)

NOTES

- The correction factor shows the attenuation pad loss including the short, low loss cable or adapter.
- Setting of measuring instrument(s) :

Detector Function	Video B.W.
Peak	OFF

CH	[MHz]	Rate	Meter Reading [dBm]	Remark
06	2437			
		6Mbps	6.83	
		9Mbps	6.73	
		12Mbps	6.76	
		18Mbps	7.15	
		24Mbps	11.82	*
		36Mbps	11.54	
		48Mbps	11.66	
		54Mbps	11.34	

* : Worst Rate

All comparison were performed on the same measurement condition.

3) IEEE 802.11n

Test Date: September 4, 2015
 Temp.: 26 °C, Humi: 57 %

Data Rate : MCS4

CH	Transmitting Frequency [MHz]	Correction Factor [dB]	Meter Reading			Conducted Peak Output Power		Limits [dBm]	Margin [dB]
			ANT0 [dBm]	ANT1 [dBm]	Total [dBm]	[dBm]	[mW]		
01	2412	10.06	11.45	11.35	14.41	24.47	279.90	30.00	+ 5.53
06	2437	10.08	12.07	11.28	14.70	24.78	300.61	30.00	+ 5.22
11	2462	10.08	11.67	10.98	14.35	24.43	277.33	30.00	+ 5.57

Calculated result at 2437.000 MHz, as the worst point shown on underline:

Correction Facto	=	10.08 dB
+) Meter Reading	=	14.70 dBm
Result	=	24.78 dBm = 300.61 mW

Minimum Margin: 30.00 - 24.78 = 5.22 (dB)

NOTES

- The correction factor shows the attenuation pad loss including the short, low loss cable or adapter.
- Setting of measuring instrument(s) :

Detector Function	Video B.W.
Peak	OFF

CH	[MHz]	Rate	Meter Reading [dBm]	Remark
06	2437			
		MCS0	6.68	
		MCS1	6.94	
		MCS2	6.88	
		MCS3	11.22	
		MCS4	12.07	*
		MCS5	11.70	
		MCS6	11.37	
		MCS7	11.46	

* : Worst Rate

All comparison were performed on the same measurement condition.

4) Bluetooth LE(Modulation type : GFSK)

Test Date: September 12, 2015

Temp.: 25 °C, Humi: 59 %

CH	Transmitting Frequency [MHz]	Correction Factor [dB]	Meter Reading [dBm]	Conducted		Limits [dBm]	Margin [dB]
				Peak Output Power [dBm]	[mW]		
00	2402	10.06	-7.43	2.63	1.83	30.00	+27.37
19	2440	10.08	-6.62	3.46	2.22	30.00	+26.54
39	2480	10.08	-6.65	3.43	2.20	30.00	+26.57

Calculated result at 2440.000 MHz, as the worst point shown on underline:

Correction Factor	=	10.08 dB
+) Meter Reading	=	<u>-6.62 dBm</u>
Result	=	3.46 dBm = 2.22 mW

Minimum Margin: 30.00 - 3.46 = 26.54 (dB)

NOTES

1. The correction factor shows the attenuation pad loss including the short, low loss cable or adapter.
2. Setting of measuring instrument(s) :

Detector Function	Video B.W.
Peak	Off

7.6 Peak Power Density(Conduction)

For the requirements, - Applicable [- Tested. - Not tested by applicant request.]
 - Not Applicable

7.6.1 Test Results

For the standard, - Passed - Failed - Not judged

Peak Power Density of IEEE802.11b is	<u>2.06</u>	dBm	at	<u>2437.0</u>	MHz
Peak Power Density of IEEE802.11g is	<u>-1.69</u>	dBm	at	<u>2462.0</u>	MHz
Peak Power Density of IEEE802.11n is	<u>-2.73</u>	dBm	at	<u>2437.0</u>	MHz
Peak Power Density of Bluetooth LE is	<u>2.70</u>	dBm	at	<u>2440.0</u>	MHz

Uncertainty of Measurement Results ± 1.7 dB(2σ)

Remarks : _____

7.6.2 Test Instruments

Shielded Room S4				
Type	Model	Serial No. (ID)	Manufacturer	Cal. Due
Spectrum Analyzer	E4446A	US44300388 (A-39)	Agilent	2016/08/11
Attenuator	54A-10	W5675 (D-28)	Weinschel	2016/08/16
RF Cable	SUCOFLEX102	14253/2 (C-52)	HUBER+SUHNER	2016/08/16

NOTE : The calibration interval of the above test instruments is 12 months.

7.6.3 Test Method and Test Setup (Diagrammatic illustration)

The test system is shown as follows:

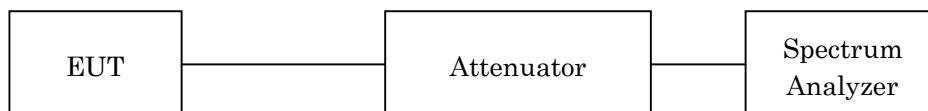

7.6.4 Test Data

1) IEEE 802.11b

Test Date: September 11, 2015

Temp.: 26 °C, Humi: 57 %

Data Rate : 11Mbps

CH	Transmitting Frequency [MHz]	Correction Factor [dB]	Meter Reading			Conducted Peak Power Density		Limits [dBm]	Margin [dB]
			ANT0 [dBm]	ANT1 [dBm]	Total [dBm]	[dBm]	[mW]		
01	2412	10.06	-11.10	-12.07	-8.55	1.51	1.42	8.00	+ 6.49
06	2437	10.08	-10.46	-11.69	-8.02	2.06	1.61	8.00	+ 5.94
11	2462	10.08	-11.69	-11.84	-8.75	1.33	1.36	8.00	+ 6.67

Calculated result at 2437.000 MHz, as the worst point shown on underline:

Correction Facto	=	10.08 dB
+) Meter Reading	=	-8.02 dBm
Result	=	2.06 dBm = 1.61 mW

Minimum Margin: 8.00 - 2.06 = 5.94 (dB)

NOTES

1. The peak power density complied with the limit using 30 kHz resolution bandwidth of Spectrum Analyzer.
2. The correction factor shows the attenuation pad loss including the short, low loss cable or adapter.
3. Setting of measuring instrument(s) :

Detector Function	RES B.W.	Video B.W.
Peak	30kHz	100kHz

a) Main Antenna (ANT0)

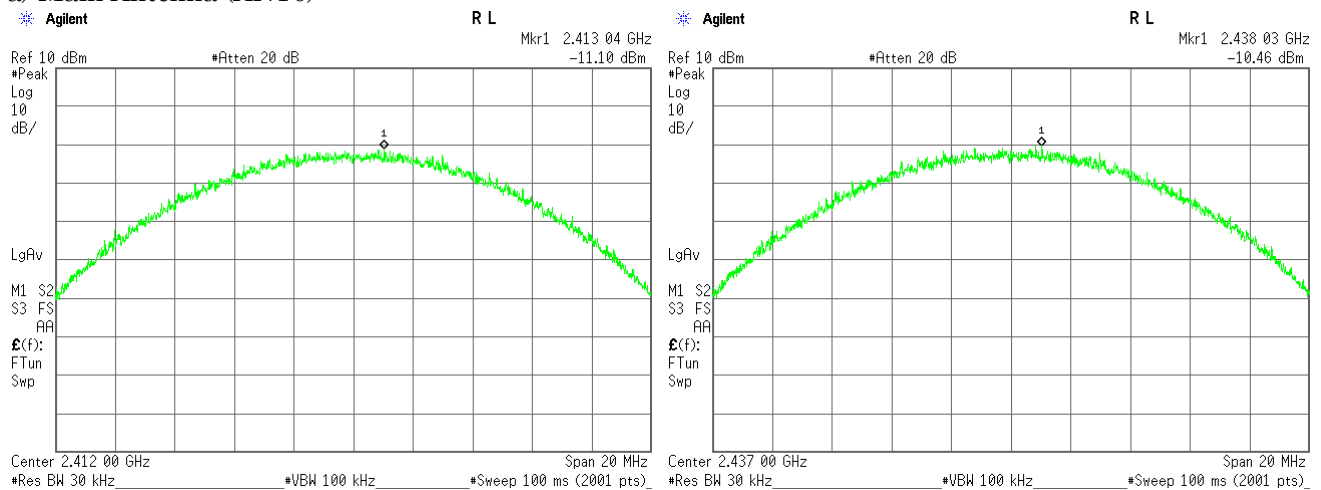

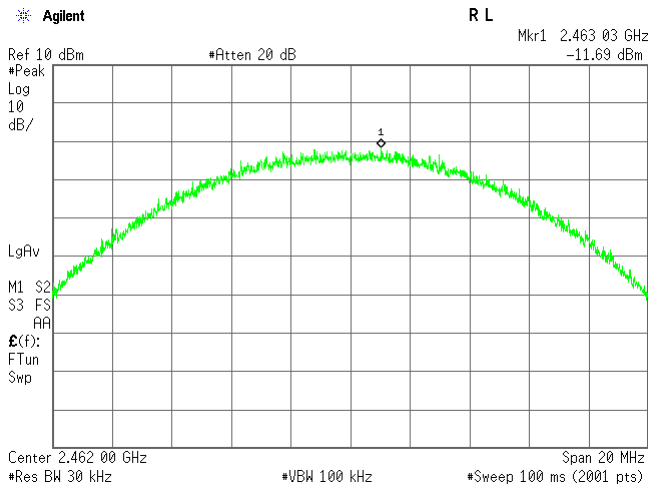

b) Sub Antenna (ANT1)

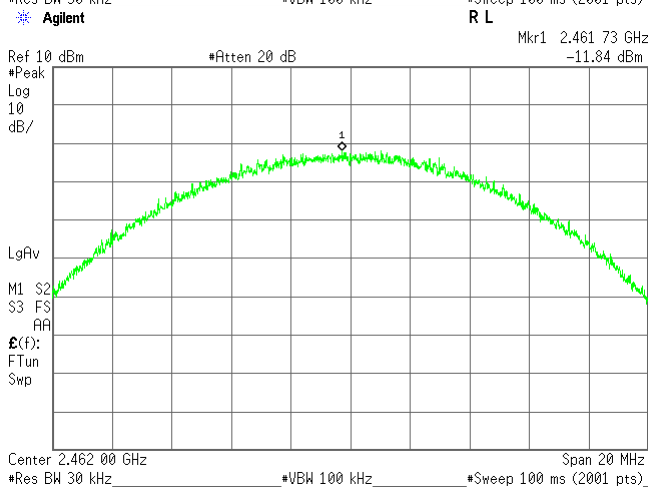
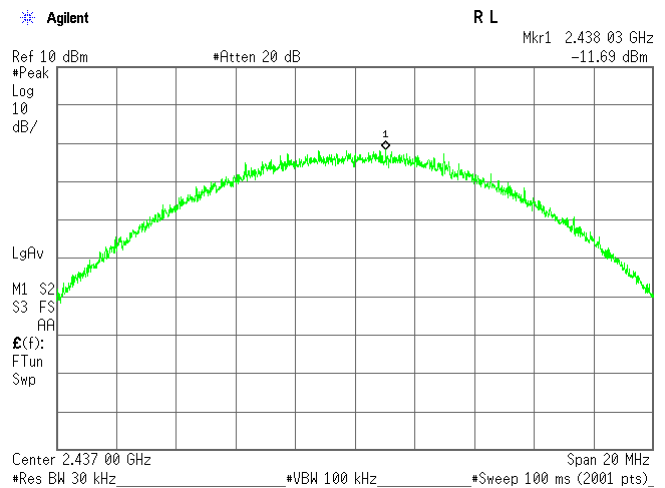
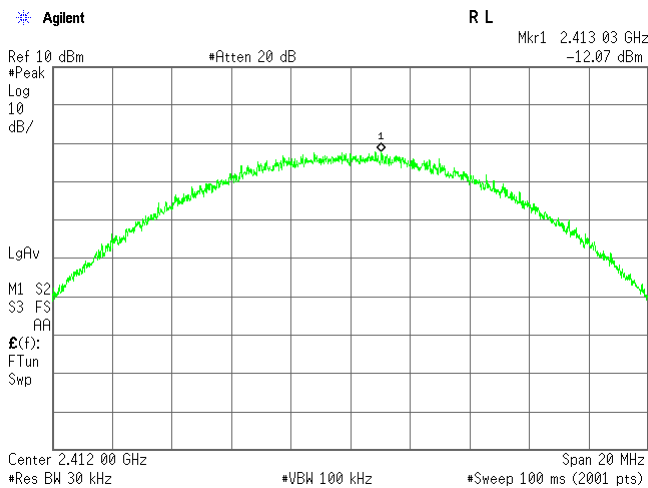

2) IEEE 802.11g

Test Date: September 11, 2015
 Temp.: 26 °C, Humi: 57 %

Data Rate : 24Mbps

CH	Transmitting Frequency [MHz]	Correction Factor [dB]	Meter Reading			Conducted Peak Power Density		Limits [dBm]	Margin [dB]
			ANT0 [dBm]	ANT1 [dBm]	Total [dBm]	[dBm]	[mW]		
01	2412	10.06	-14.98	-16.18	-12.53	-2.47	0.57	8.00	+10.47
06	2437	10.08	-14.76	-16.11	-12.37	-2.29	0.59	8.00	+10.29
11	2462	10.08	-14.59	-14.97	-11.77	-1.69	0.68	8.00	+ 9.69

Calculated result at 2462.000 MHz, as the worst point shown on underline:

Correction Factor	=	10.08 dB
+) Meter Reading	=	-11.77 dBm
Result	=	-1.69 dBm = 0.68 mW

Minimum Margin: 8.00 - -1.69 = 9.69 (dB)

NOTES

1. The peak power density complied with the limit using 30 kHz resolution bandwidth of Spectrum Analyzer.
2. The correction factor shows the attenuation pad loss including the short, low loss cable or adapter.
3. Setting of measuring instrument(s) :

Detector Function	RES B.W.	Video B.W.
Peak	30kHz	100kHz

a) Main Antenna (ANT0)

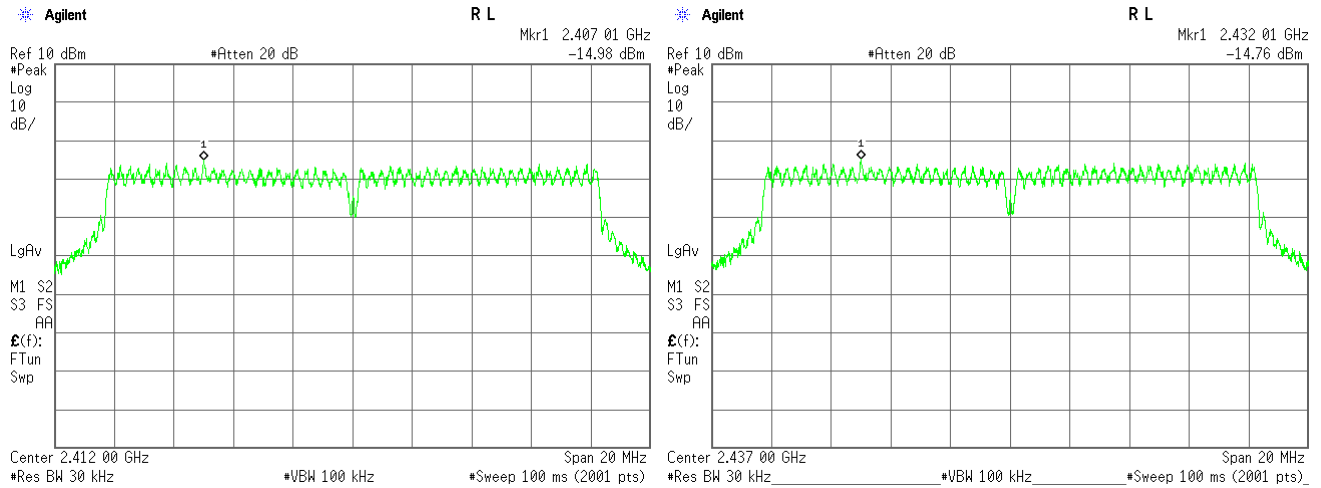

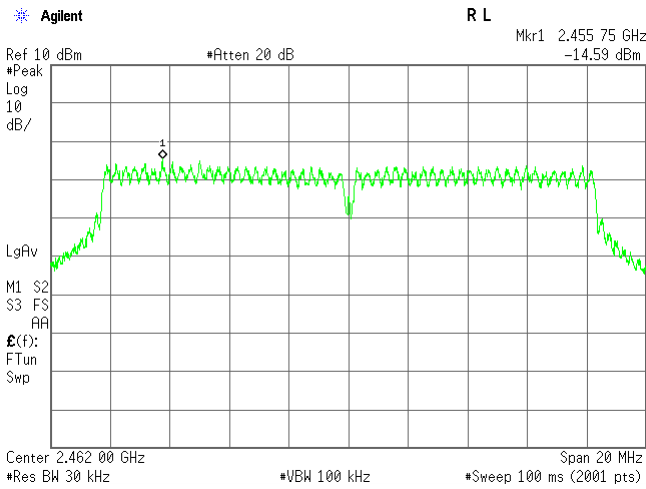

b) Sub Antenna (ANT1)

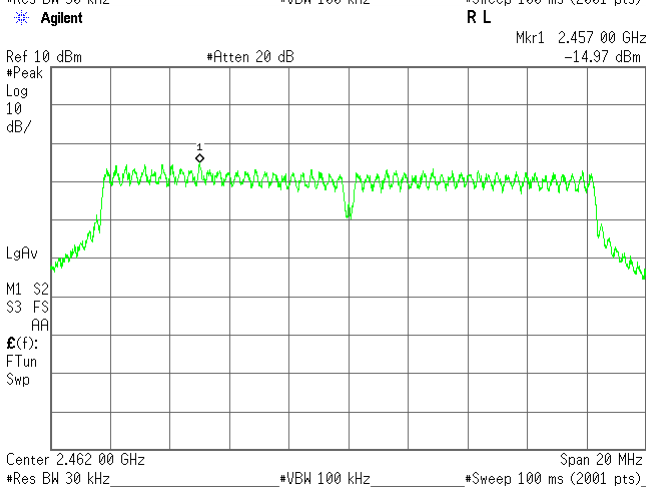
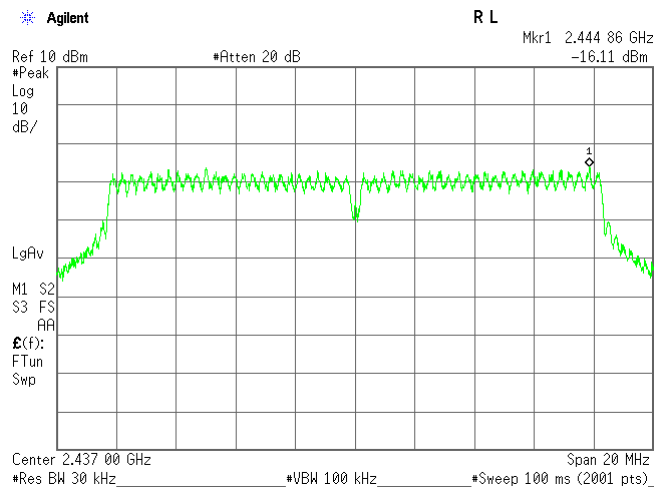
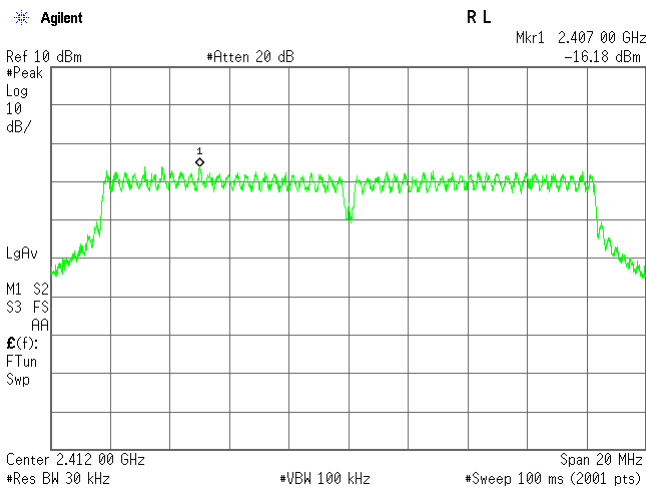

3) IEEE 802.11n

Test Date: September 11, 2015
 Temp.: 26 °C, Humi: 57 %

Data Rate : MCS4

CH	Transmitting Frequency [MHz]	Correction Factor [dB]	Meter Reading			Conducted Peak Power Density		Limits [dBm]	Margin [dB]
			ANT0 [dBm]	ANT1 [dBm]	Total [dBm]	[dBm]	[mW]		
01	2412	10.06	-16.13	-16.66	-13.38	-3.32	0.47	8.00	+11.32
06	2437	10.08	-15.59	-16.05	-12.81	-2.73	0.53	8.00	+10.73
11	2462	10.08	-16.01	-16.19	-13.09	-3.01	0.50	8.00	+11.01

Calculated result at 2437.000 MHz, as the worst point shown on underline:

Correction Facto	=	10.08 dB
+) Meter Reading	=	-12.81 dBm
Result	=	-2.73 dBm = 0.53 mW

Minimum Margin: 8.00 - -2.73 = 10.73 (dB)

NOTES

- The peak power density complied with the limit using 30 kHz resolution bandwidth of Spectrum Analyzer.
- The correction factor shows the attenuation pad loss including the short, low loss cable or adapter.
- Setting of measuring instrument(s) :

Detector Function	RES B.W.	Video B.W.
Peak	30kHz	100kHz

a) Main Antenna (ANT0)

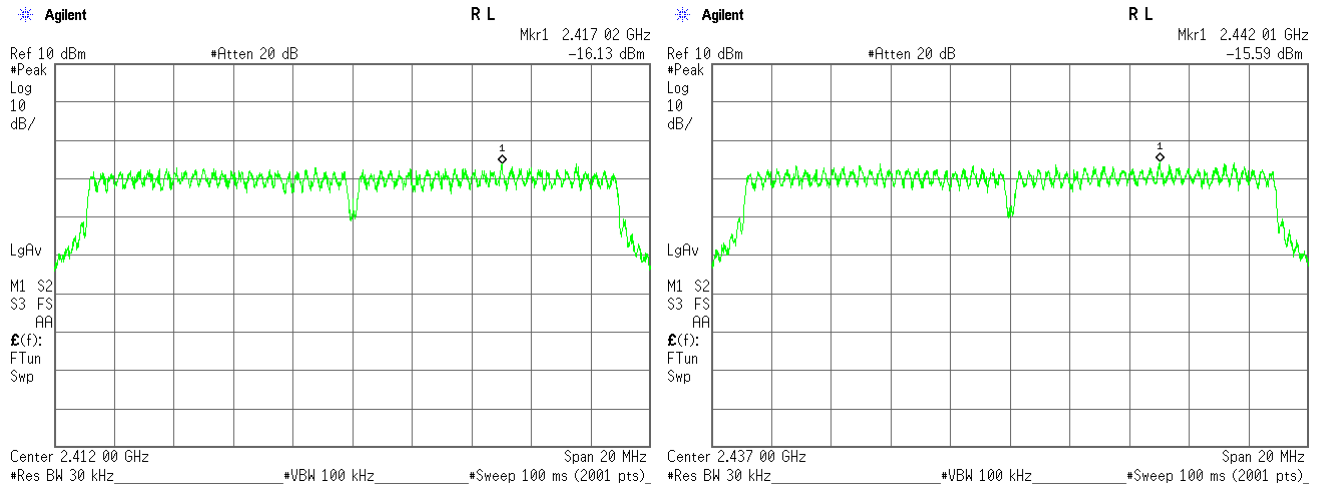

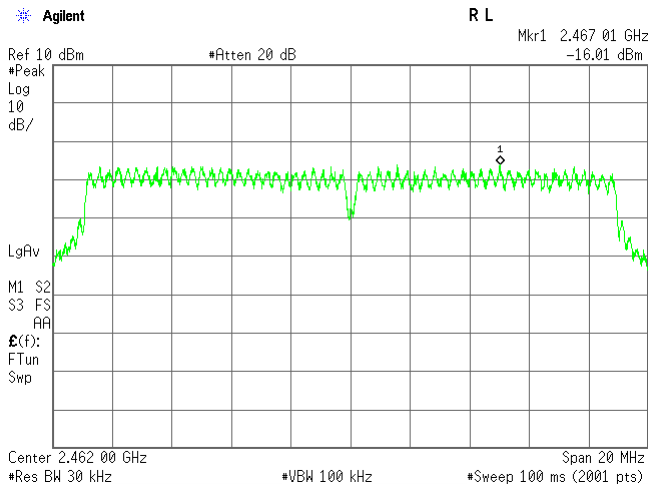

b) Sub Antenna (ANT1)

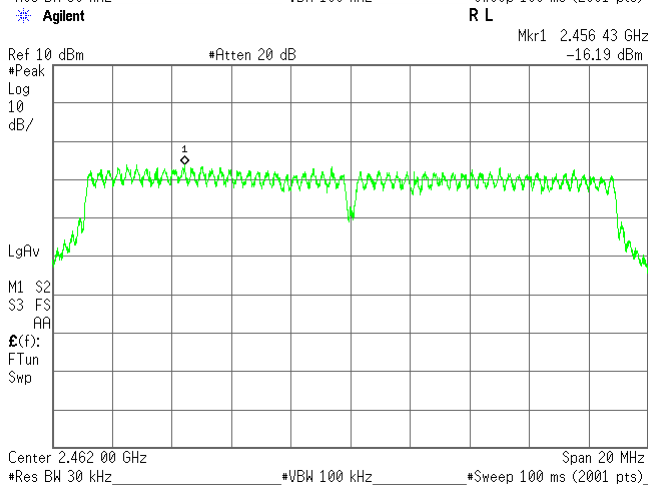
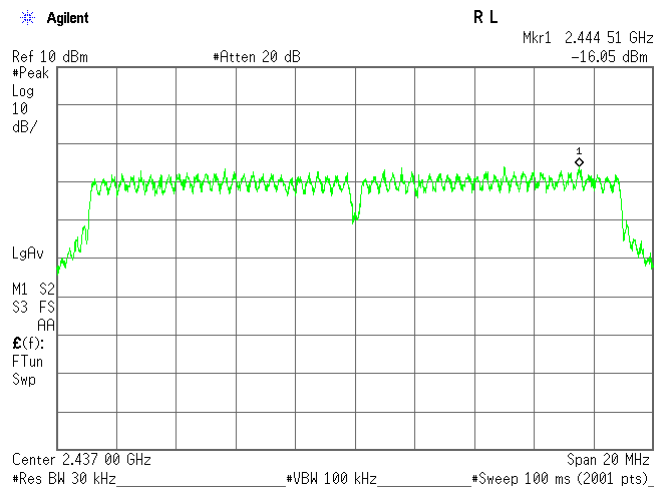
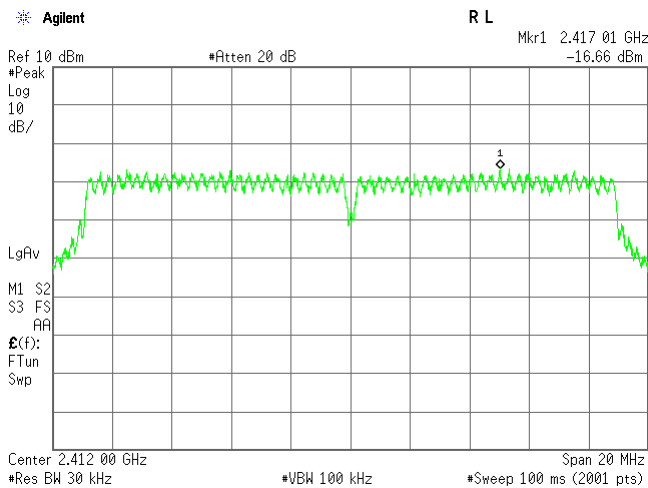

4) Bluetooth LE(Modulation type : GFSK)

Test Date: September 12, 2015
 Temp.: 25 °C, Humi: 59 %

Transmitting Frequency	Correction Factor	Meter Reading	Conducted		Limits	Margin
CH	[MHz]	[dB]	[dBm]	Peak Power Density [dBm] [mW]	[dBm]	[dB]
00	2402	10.06	-8.21	1.85 1.53	8.00	+ 6.15
19	2440	10.08	-7.38	2.70 1.86	8.00	+ 5.30
39	2480	10.08	-7.39	2.69 1.86	8.00	+ 5.31

Calculated result at 2440.000 MHz, as the worst point shown on underline:
 Correction Factor = 10.08 dB
 +) Meter Reading = -7.38 dBm
 Result = 2.70 dBm = 1.86 mW
 Minimum Margin: 8.00 - 2.70 = 5.30 (dB)

NOTES
 1. The peak power density complied with the limit using 30 kHz resolution bandwidth of Spectrum Analyzer.
 2. The correction factor shows the attenuation pad loss including the short, low loss cable or adapter.
 3. Setting of measuring instrument(s) :

Detector Function	RES B.W.	Video B.W.
Peak	30kHz	100kHz

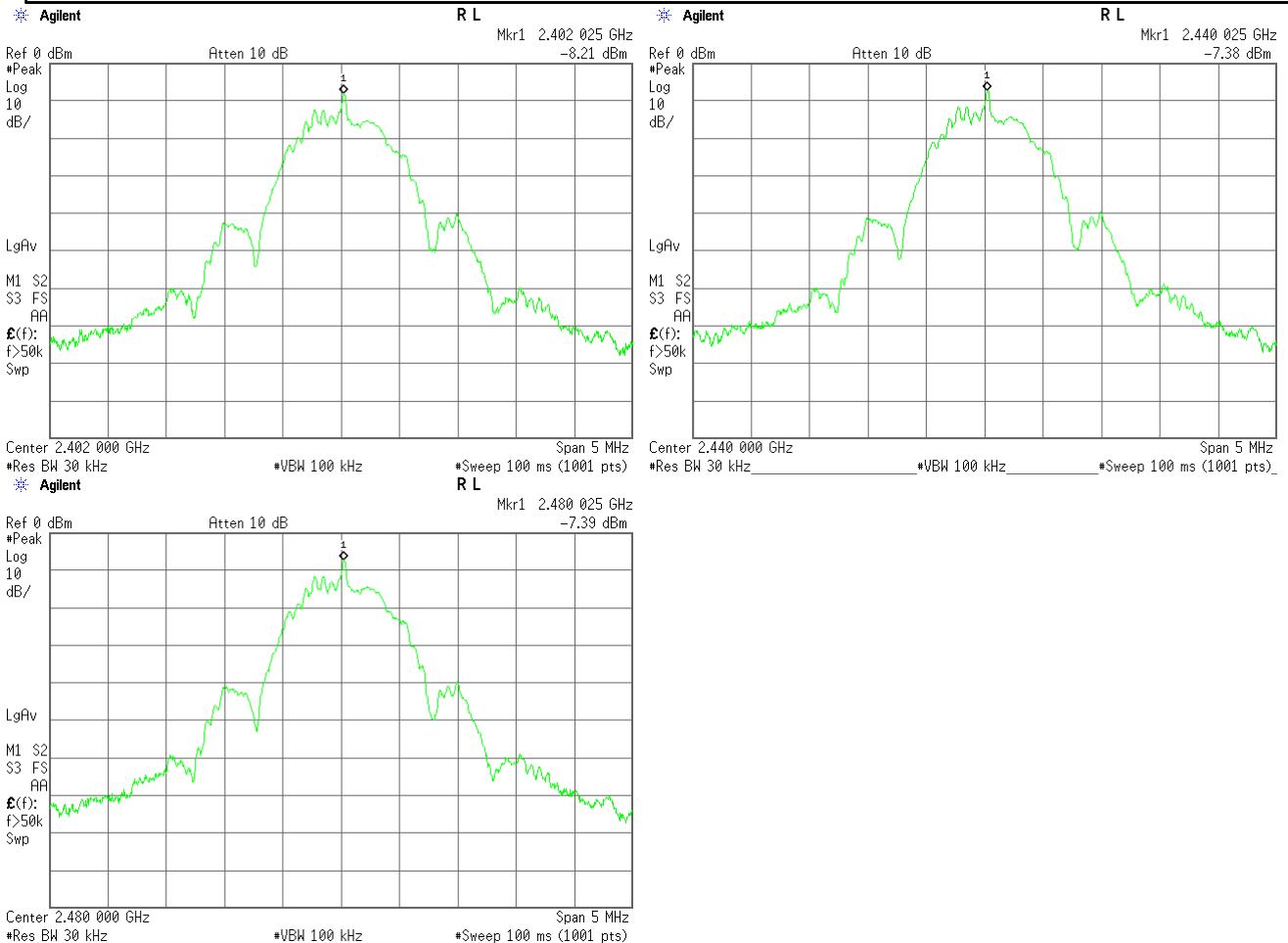

7.7 Spurious Emissions(Conduction)

For the requirements, - Applicable [- Tested. - Not tested by applicant request.]
 - Not Applicable

7.7.1 Test Results

For the standard, - Passed - Failed - Not judged

Uncertainty of Measurement Results

9 kHz – 1 GHz	<u>± 1.4</u>	dB(2σ)
1 GHz – 18 GHz	<u>± 1.7</u>	dB(2σ)
18 GHz – 40 GHz	<u>± 2.3</u>	dB(2σ)

Remarks : _____

7.7.2 Test Instruments

Shielded Room S4				
Type	Model	Serial No. (ID)	Manufacturer	Cal. Due
Spectrum Analyzer	E4446A	US44300388 (A-39)	Agilent	2016/08/11
Attenuator	54A-10	W5675 (D-28)	Weinschel	2016/08/16
RF Cable	SUCOFLEX102	14253/2 (C-52)	HUBER+SUHNER	2016/08/16

NOTE : The calibration interval of the above test instruments is 12 months.

7.7.3 Test Method and Test Setup (Diagrammatic illustration)

The test system is shown as follows:

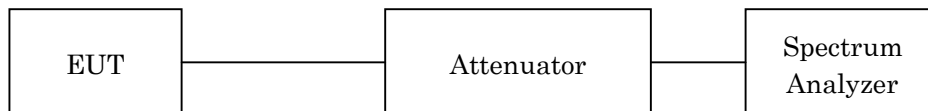

The setting of the spectrum analyzer are shown as follows:

Frequency Range	30 MHz - 25 GHz	Band-Edge
Res. Bandwidth	100 kHz	100 kHz
Video Bandwidth	300 kHz	300 kHz
Sweep Time	AUTO	AUTO
Trace	Maxhold	Maxhold

7.7.4 Test Data

Test Date : September 11, 2015

Temp.:26°C, Humi:57%

1-1) IEEE 802.11b (Main Antenna)

Low Channel

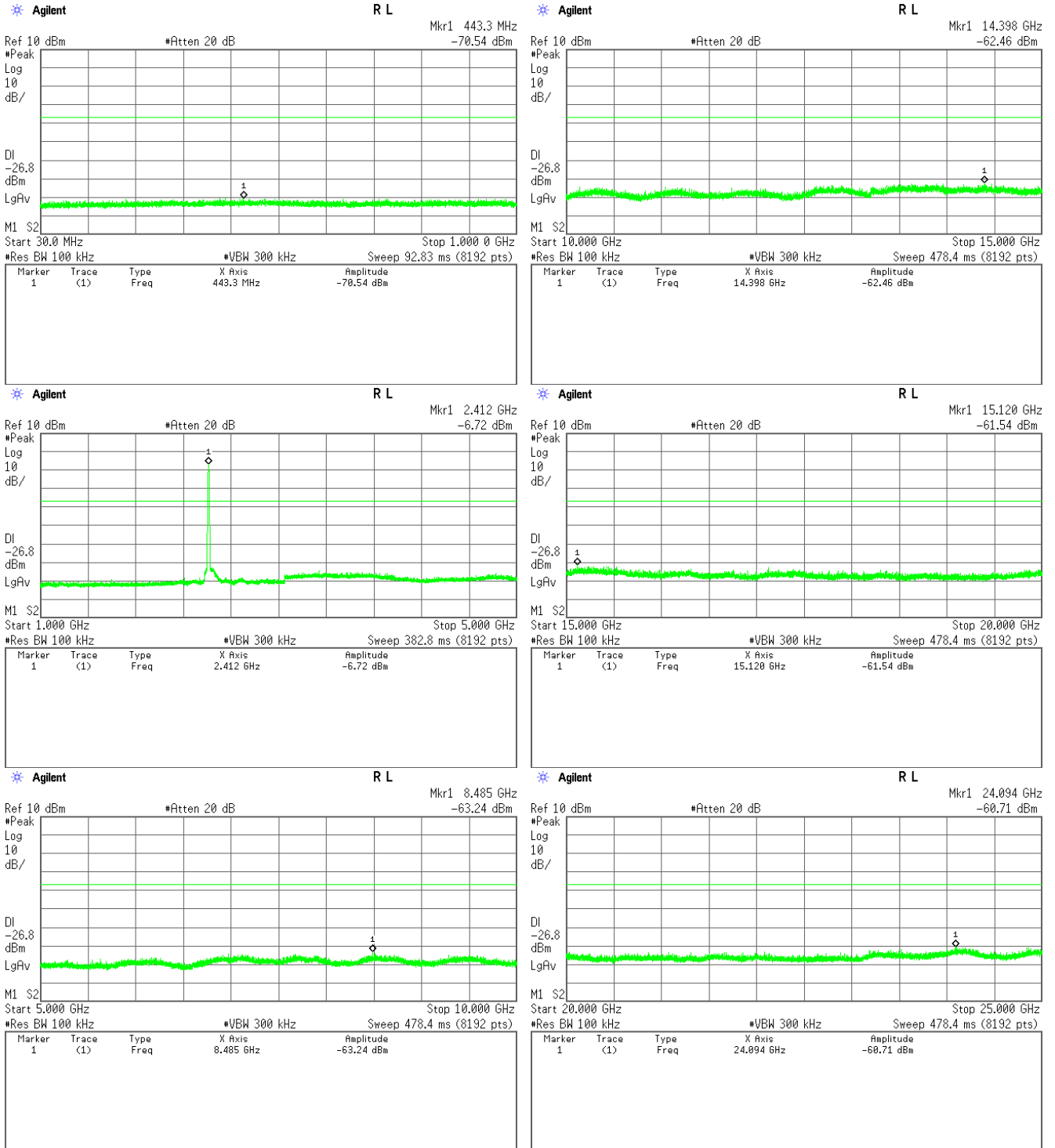

Middle Channel

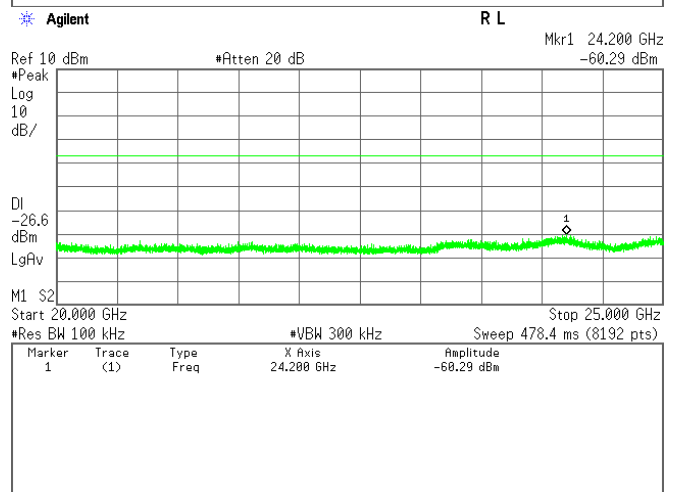
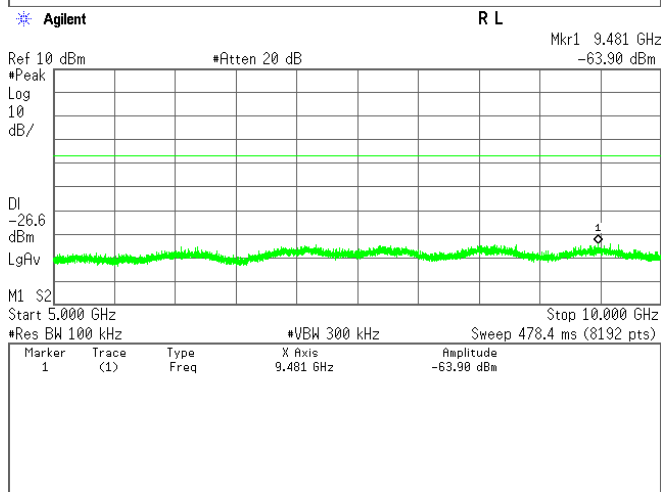
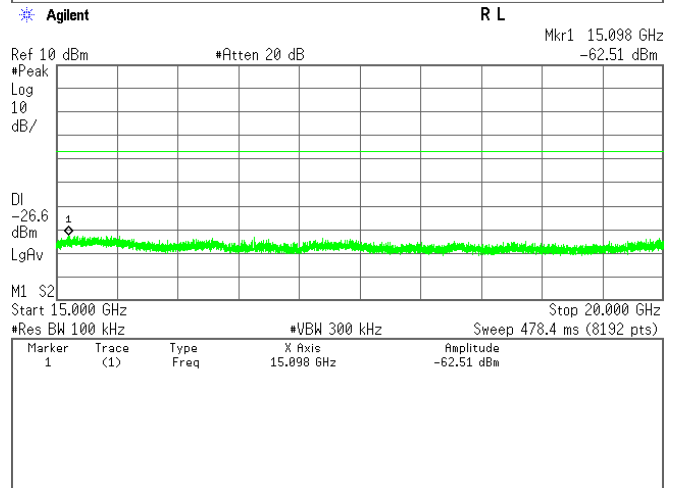
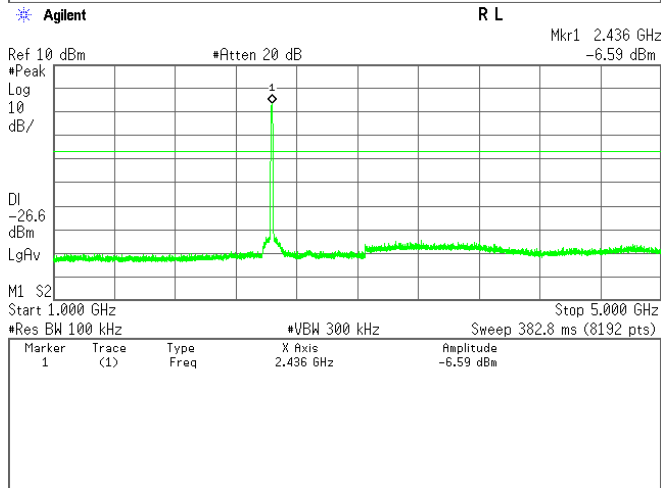
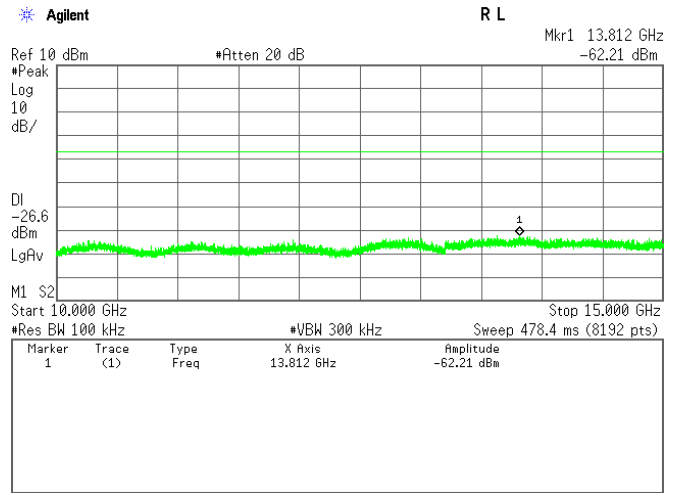
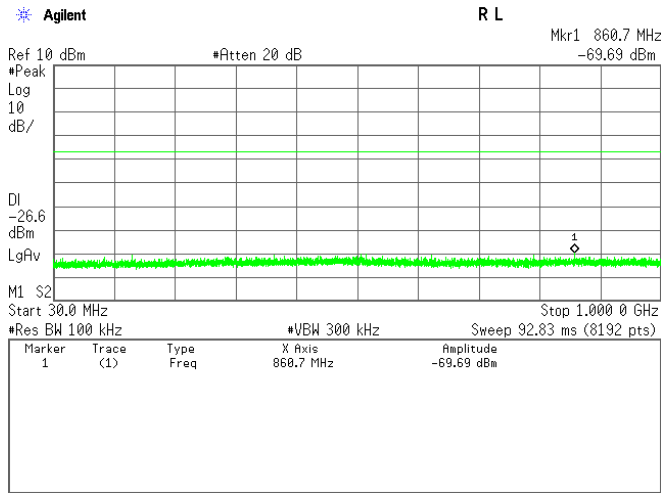

High Channel

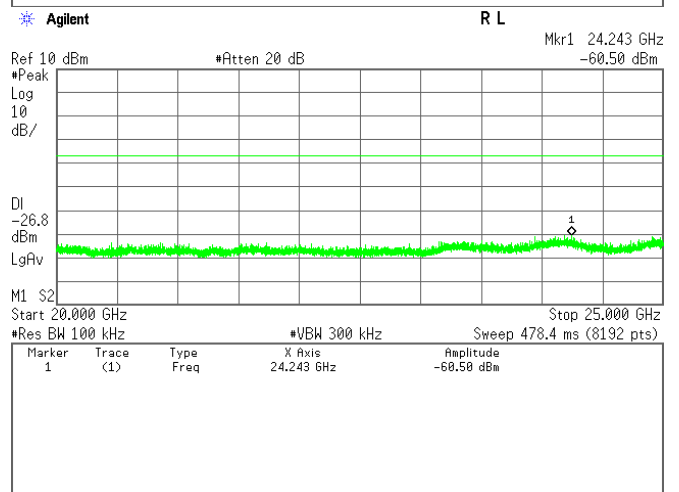
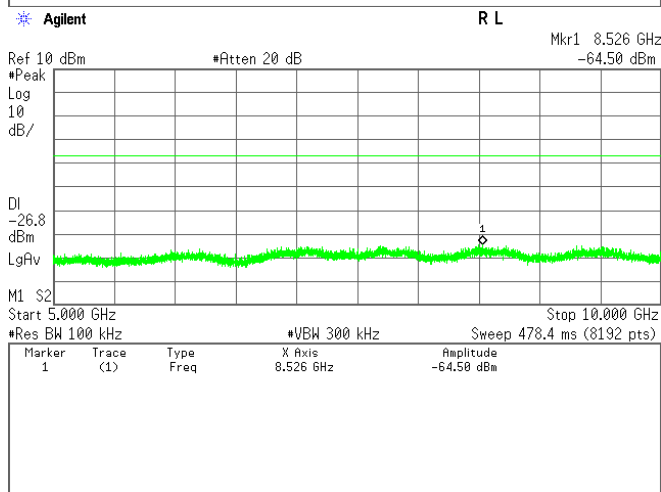
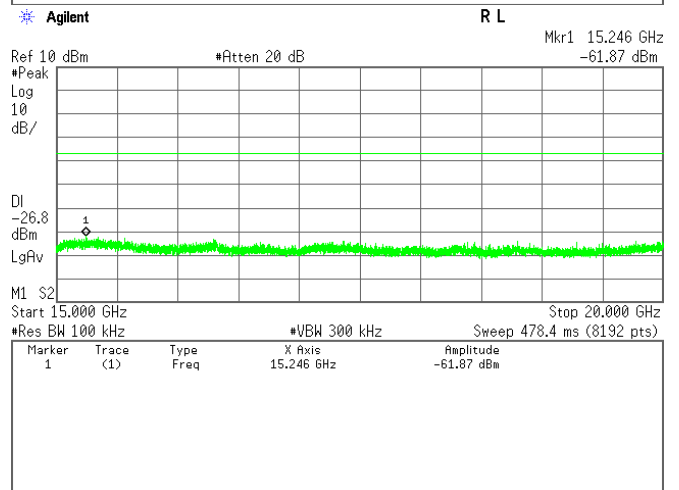
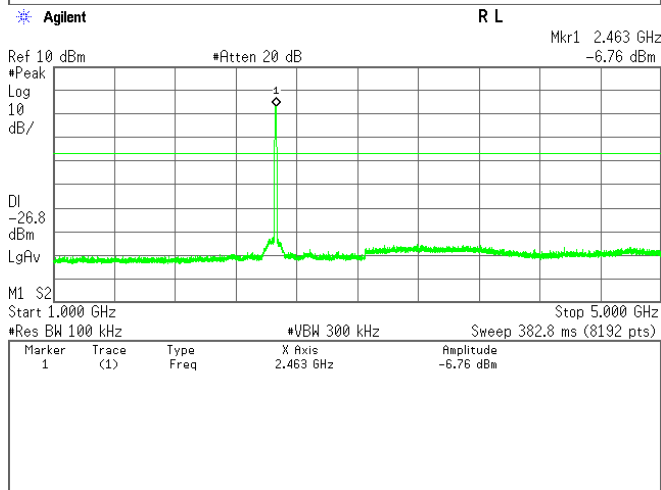
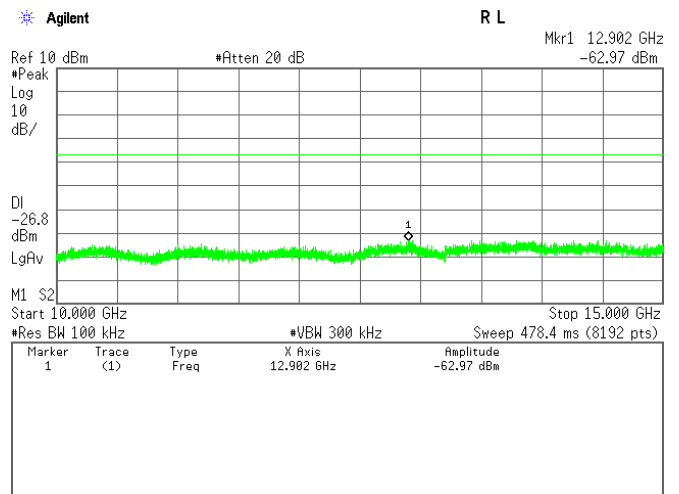
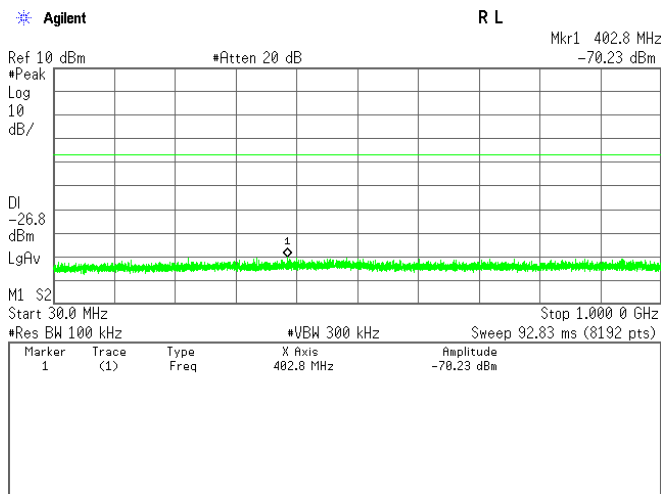

1-2) IEEE 802.11b (Sub Antenna)

Low Channel

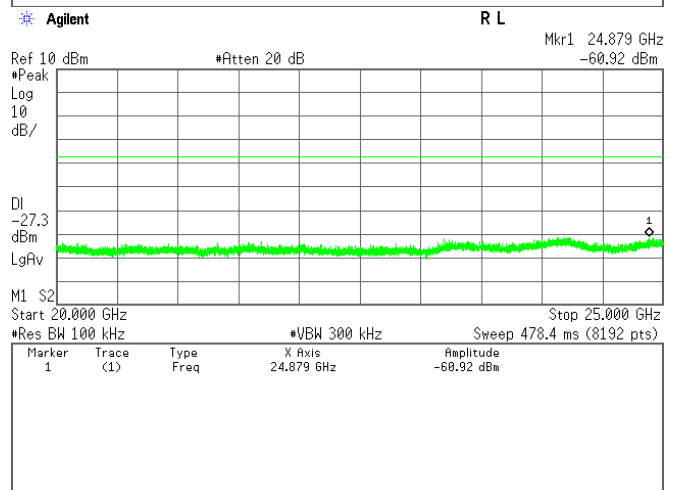
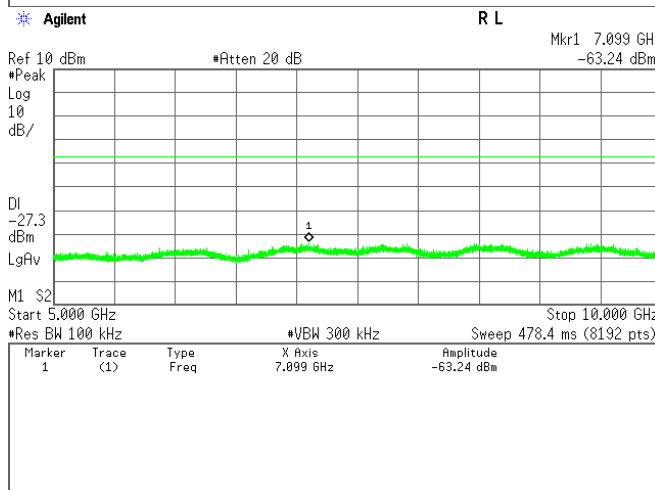
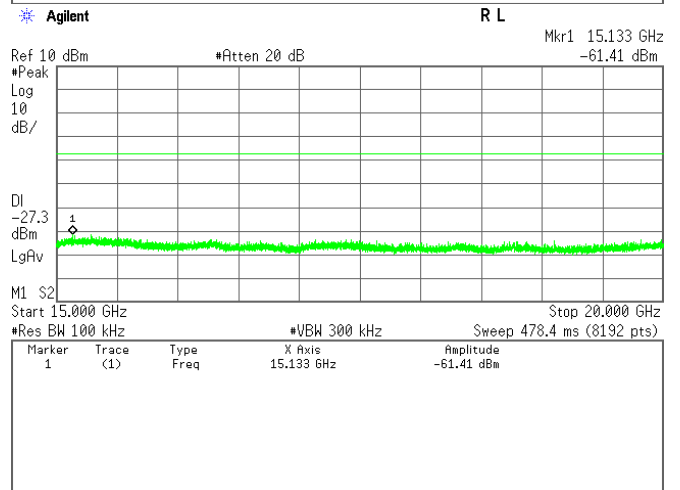
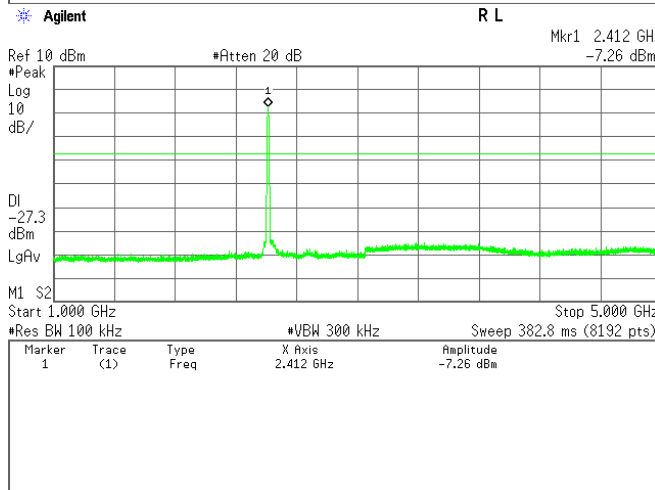
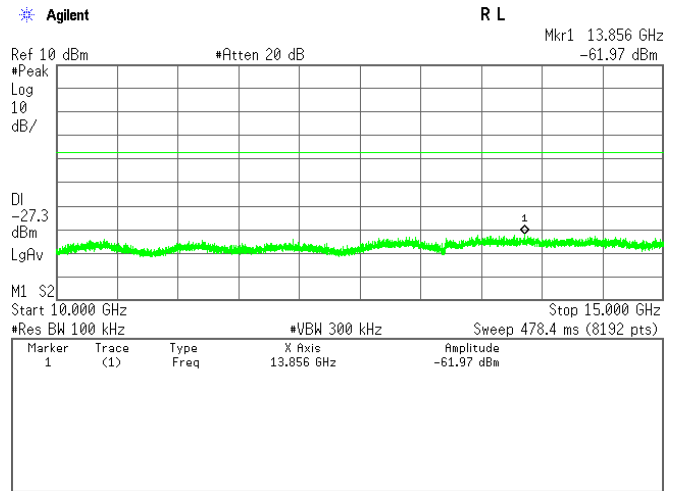
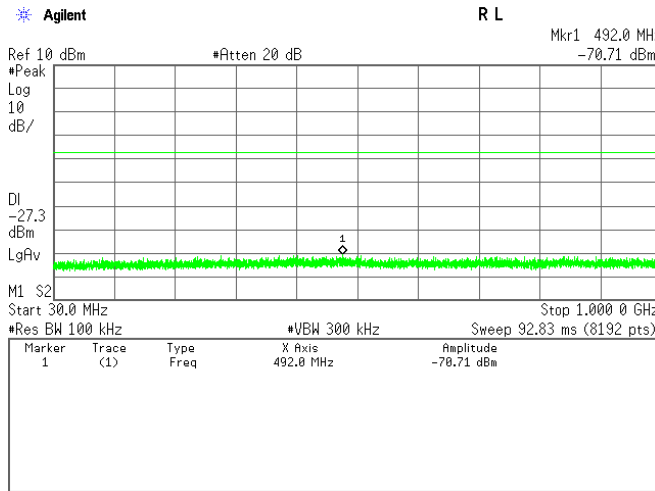

Middle Channel

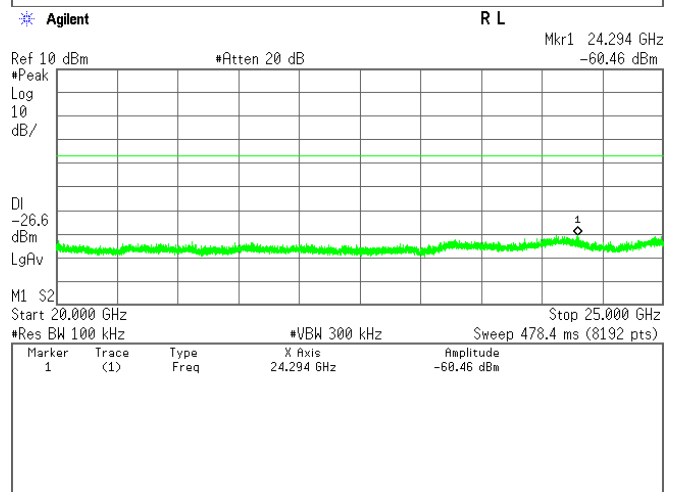
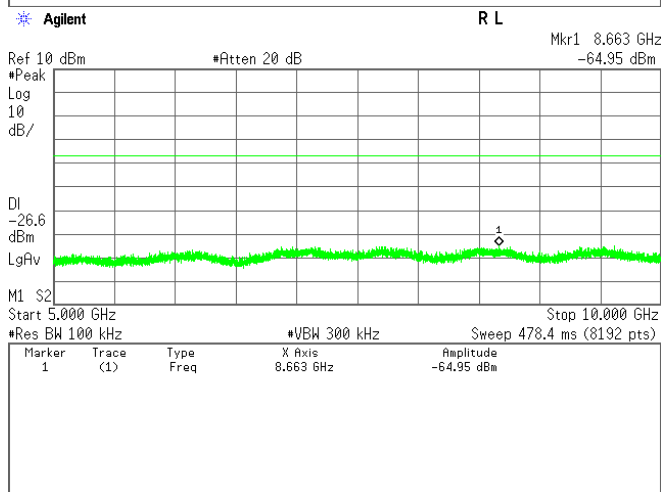
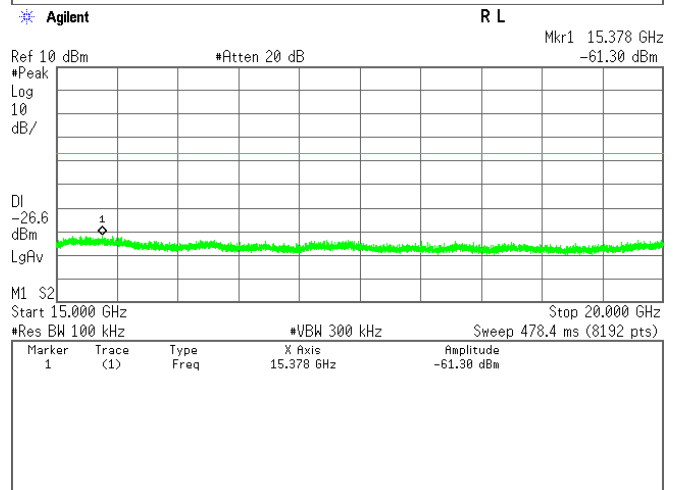
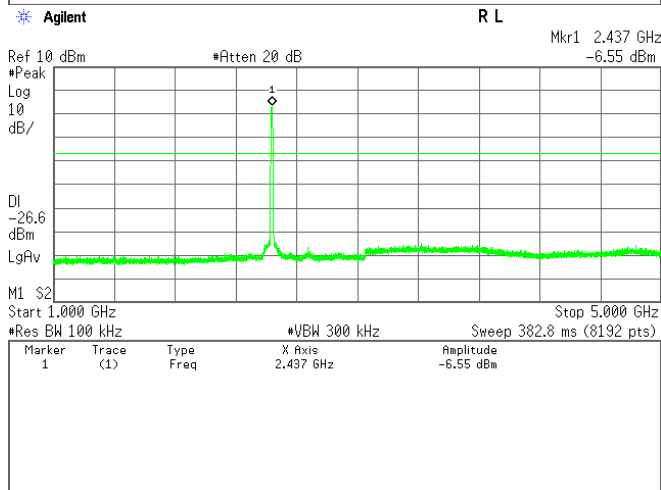
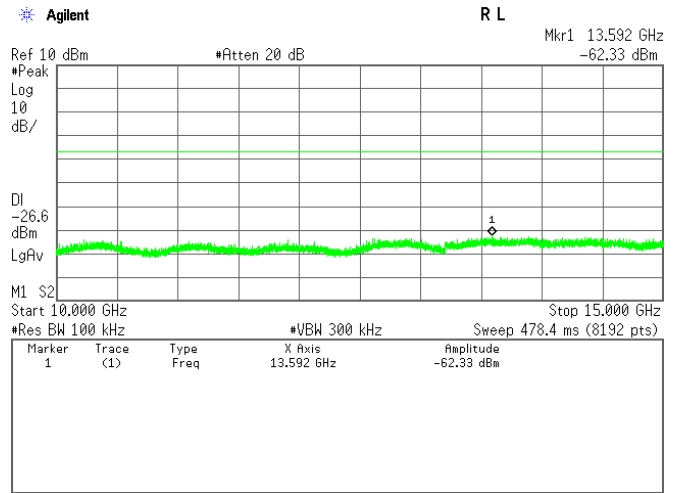
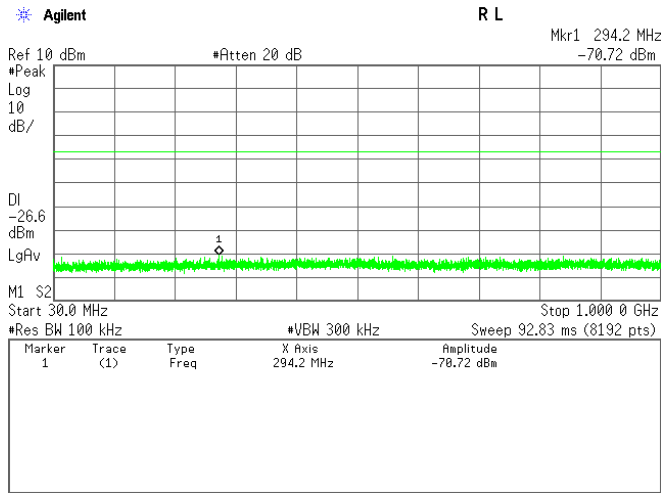

High Channel

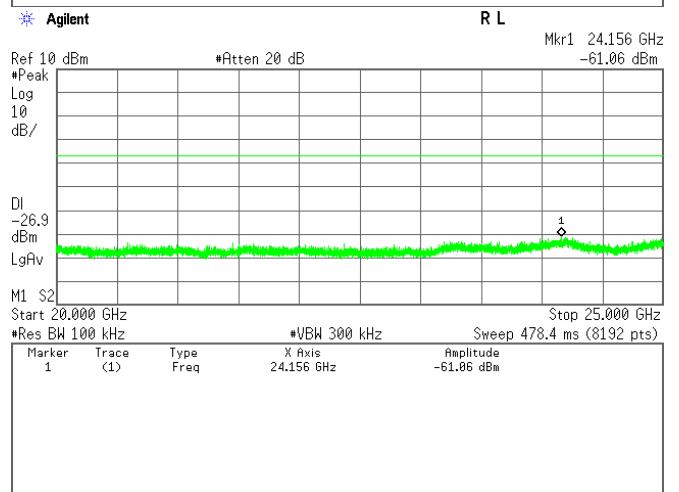
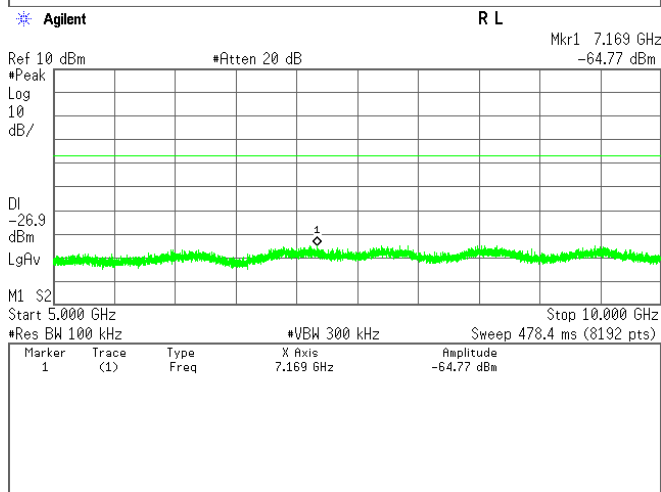
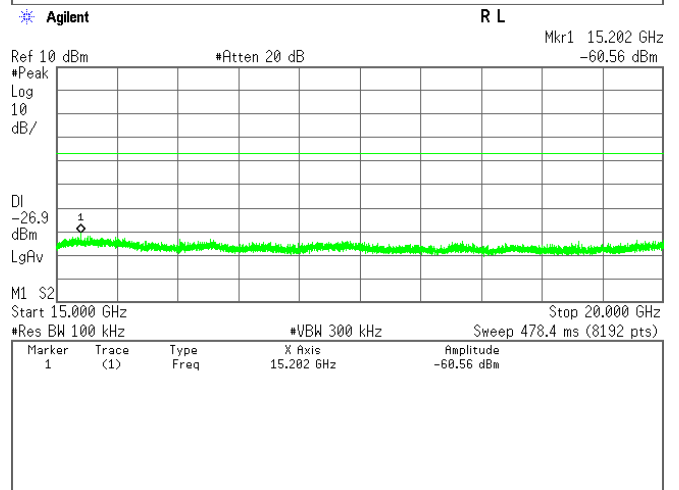
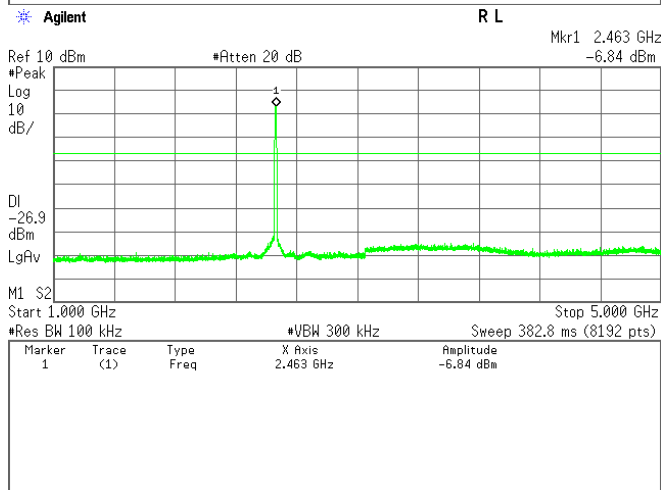
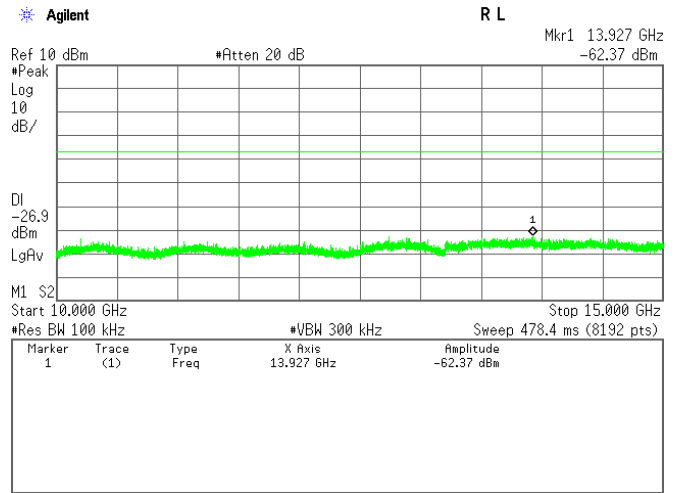
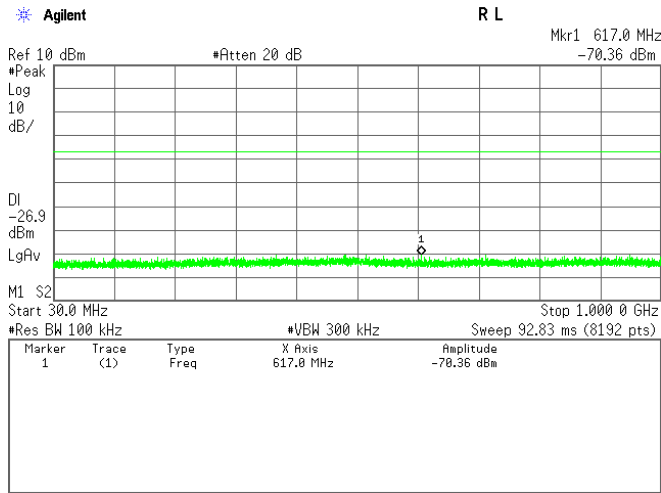

2-1) IEEE 802.11g (Main Antenna)

Low Channel

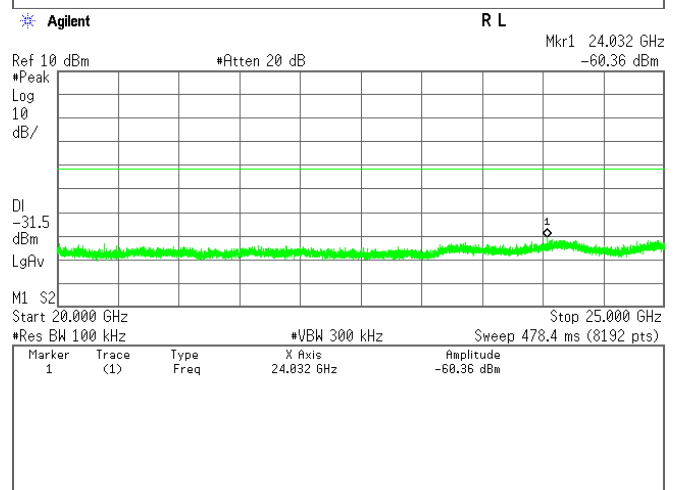
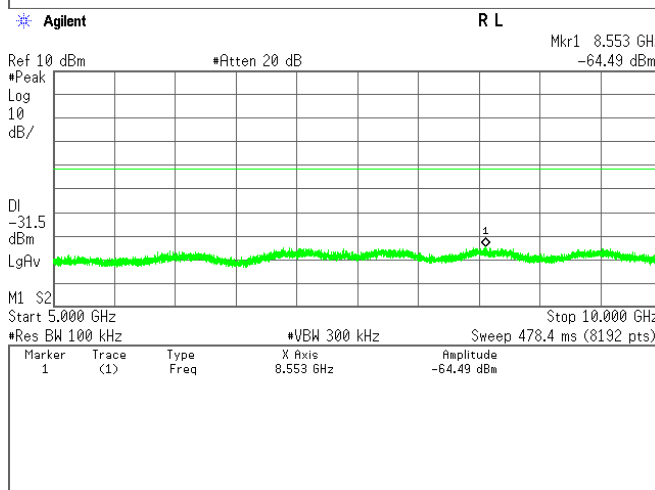
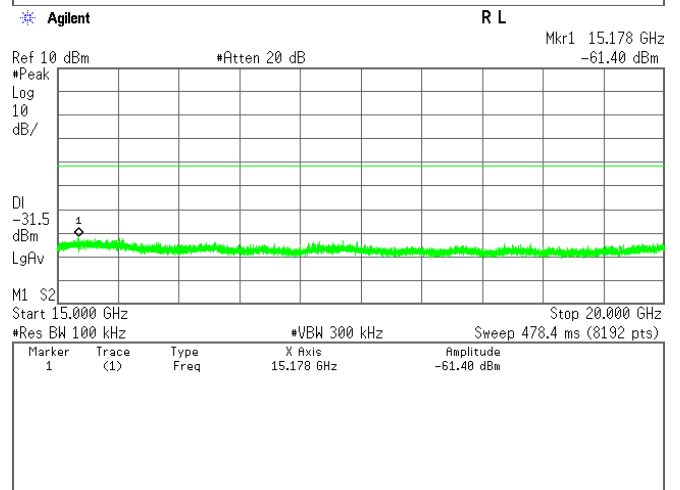
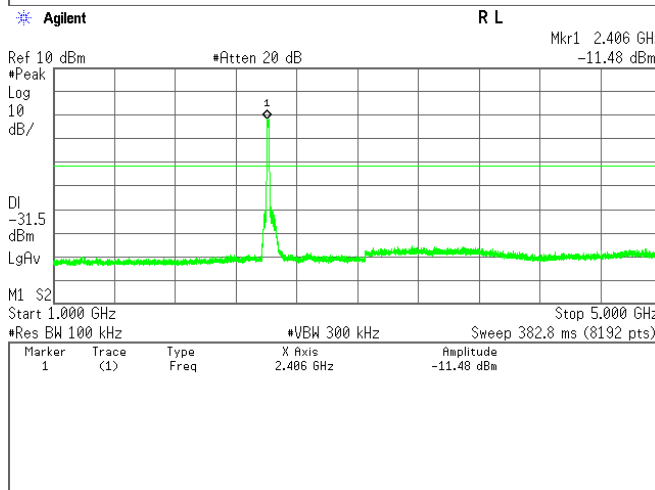
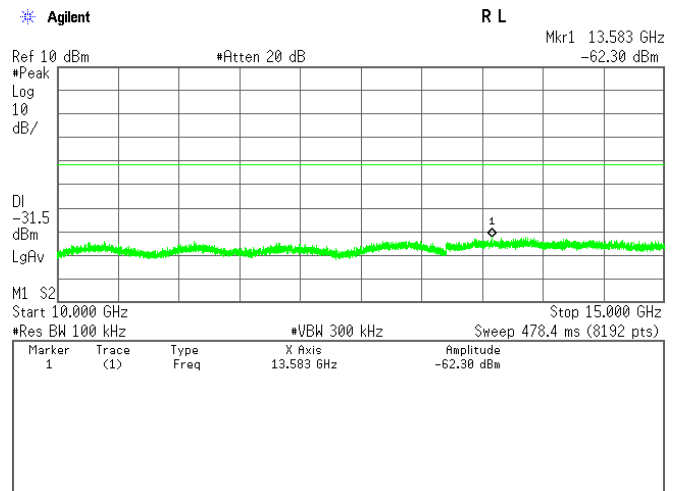
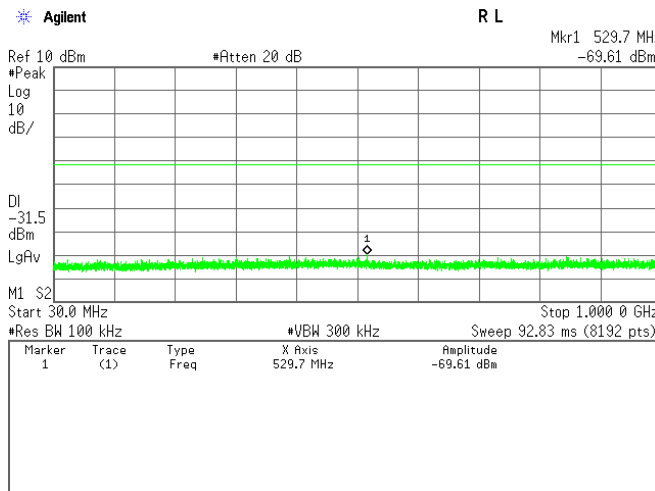

Middle channel

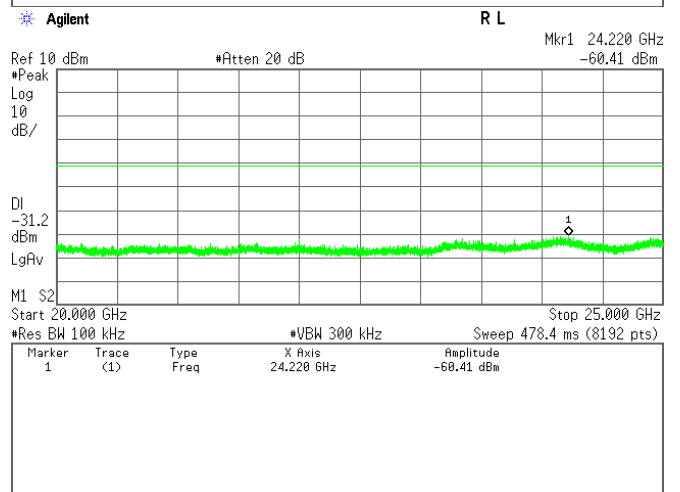
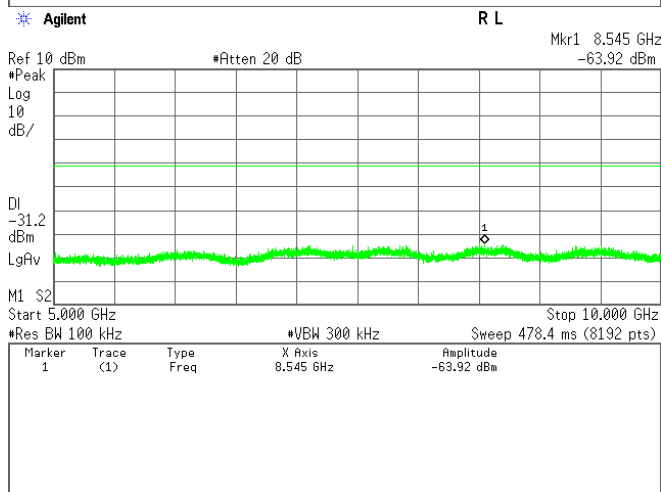
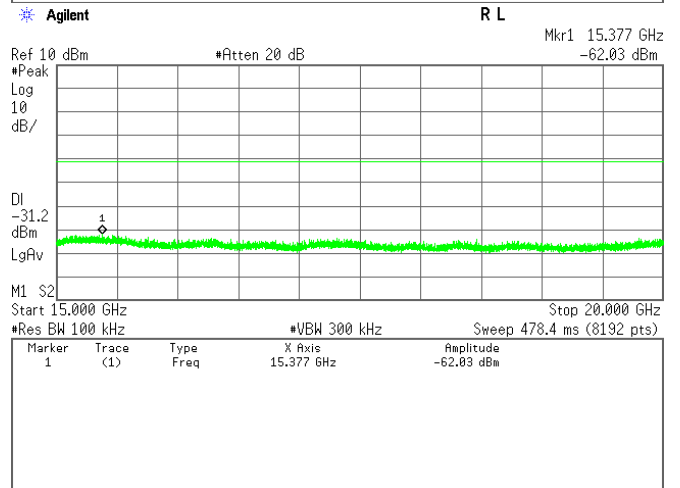
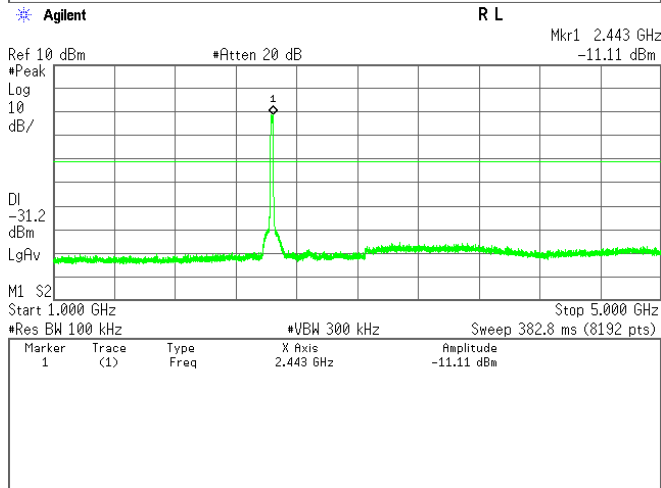
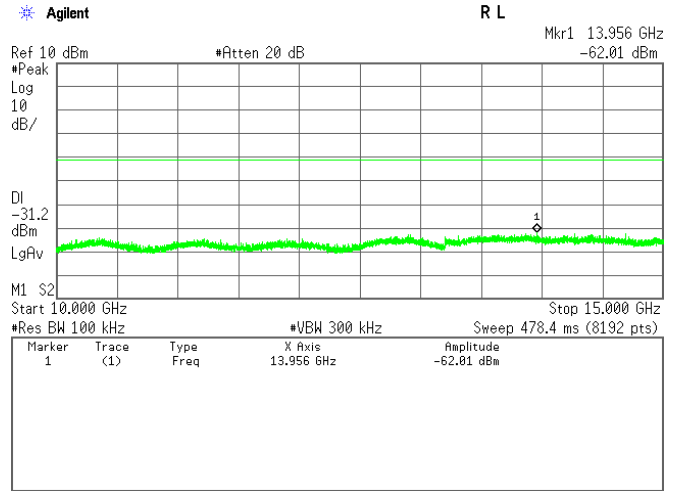
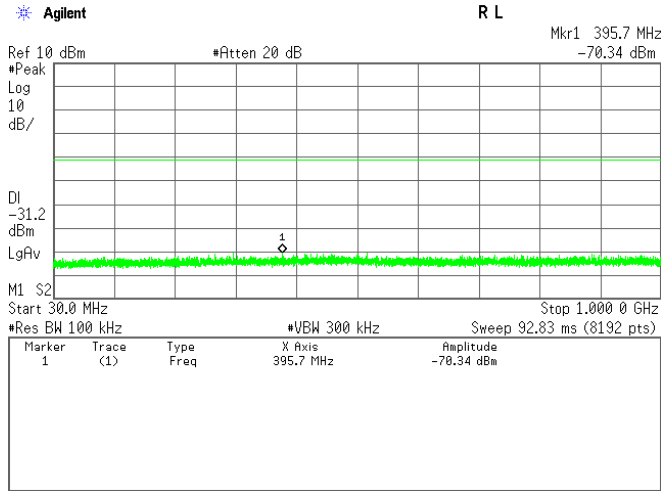

High Channel

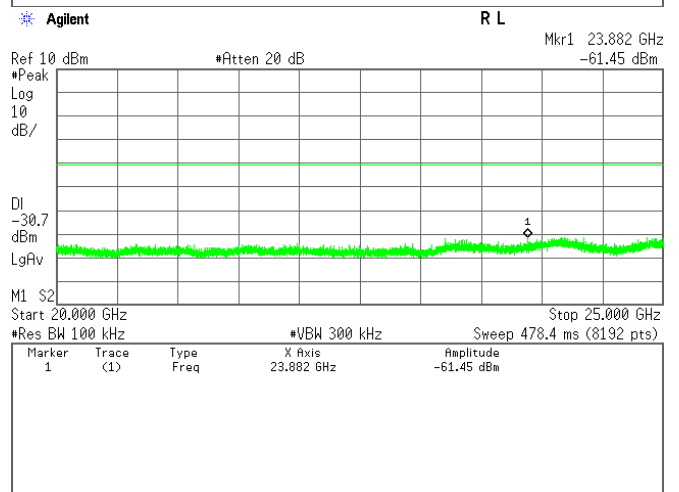
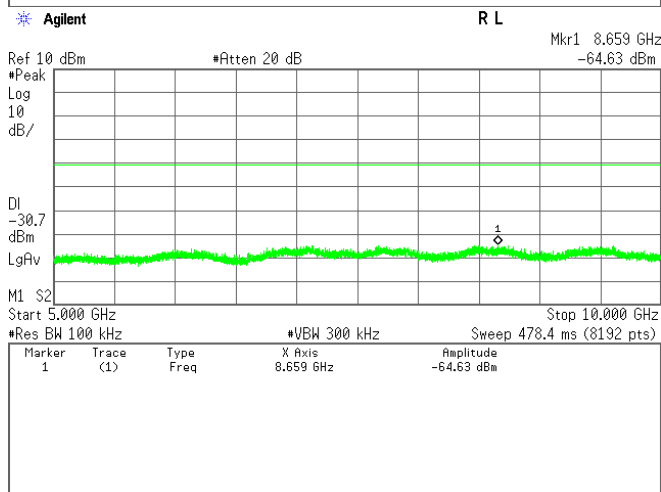
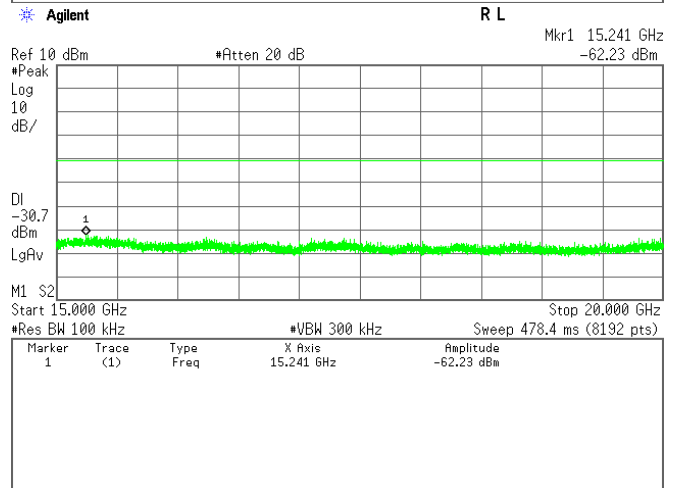
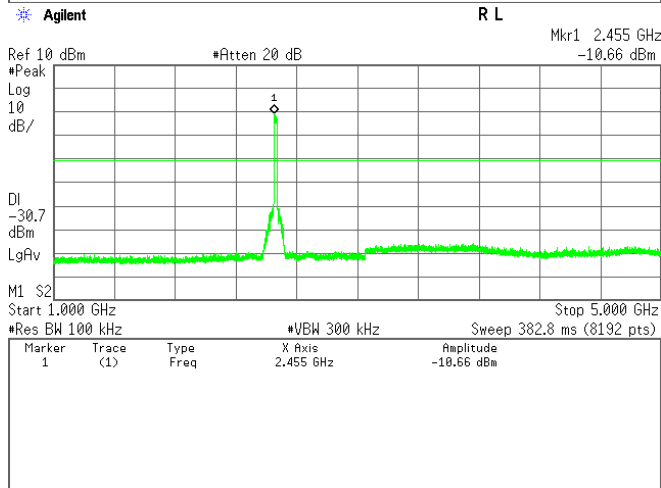
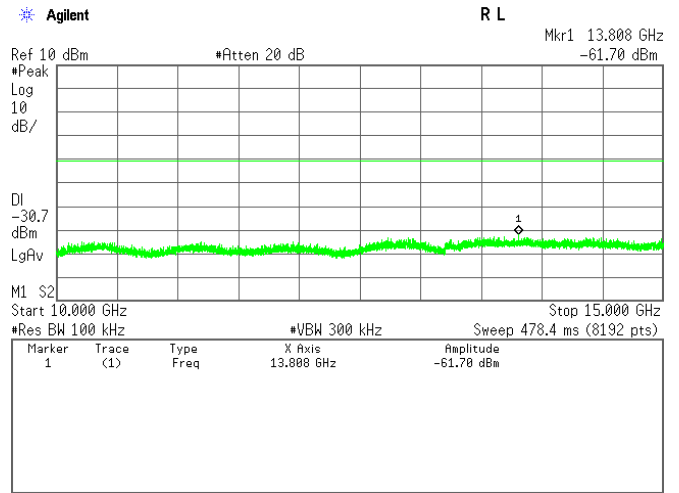
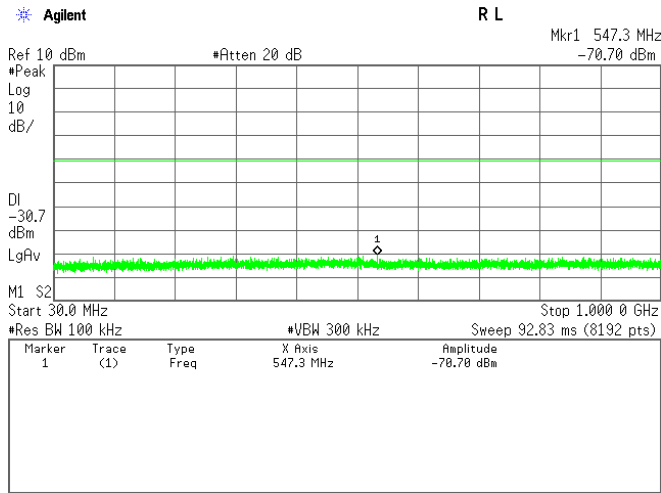

2-2) IEEE 802.11g (Sub Antenna)

Low Channel

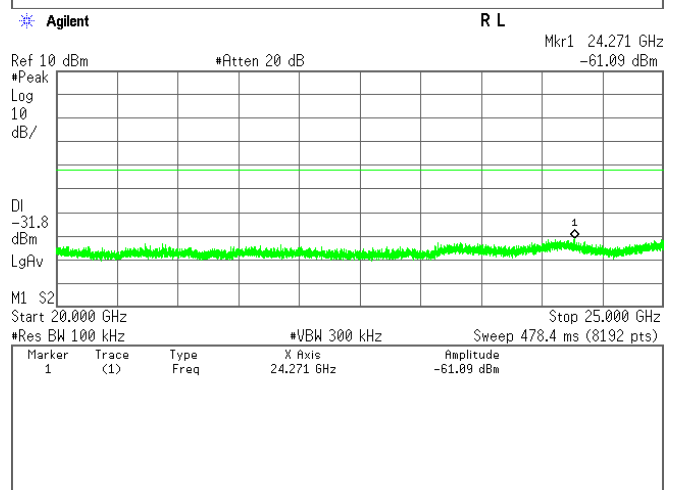
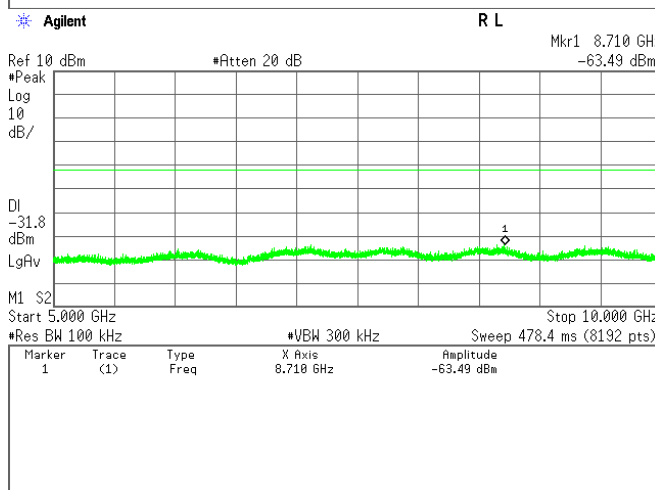
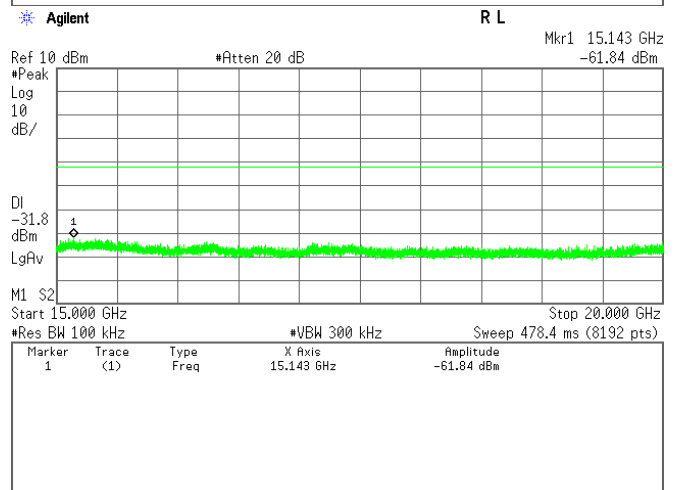
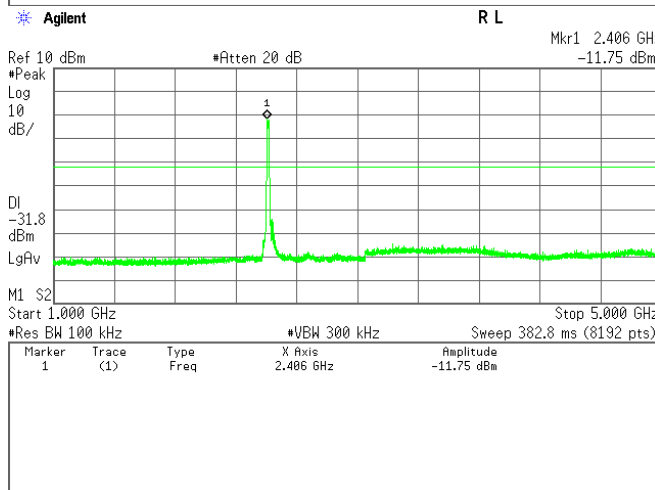
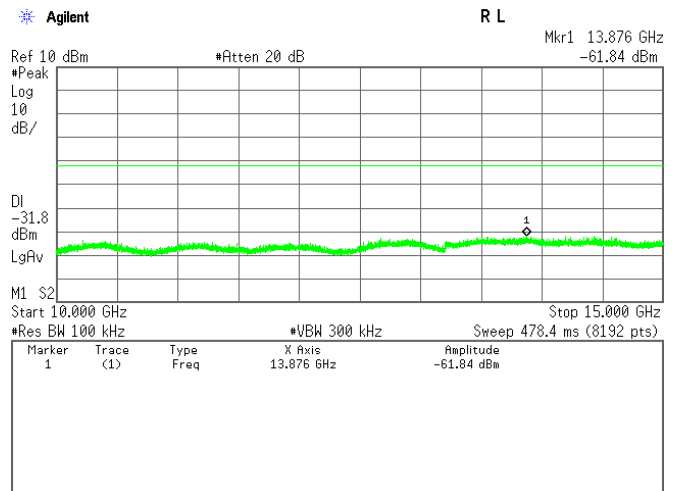
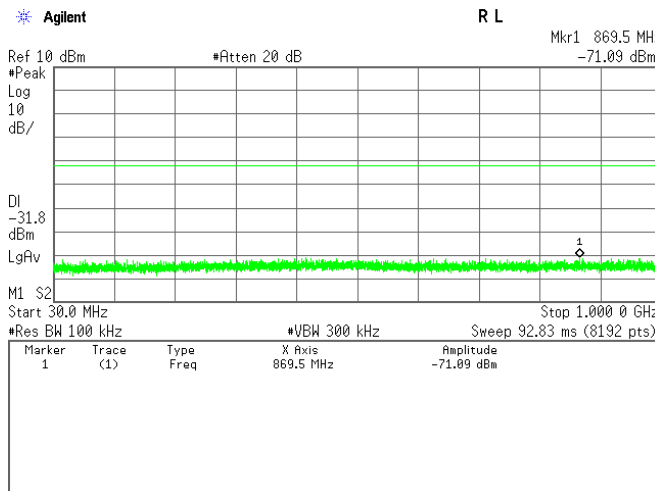

Middle channel

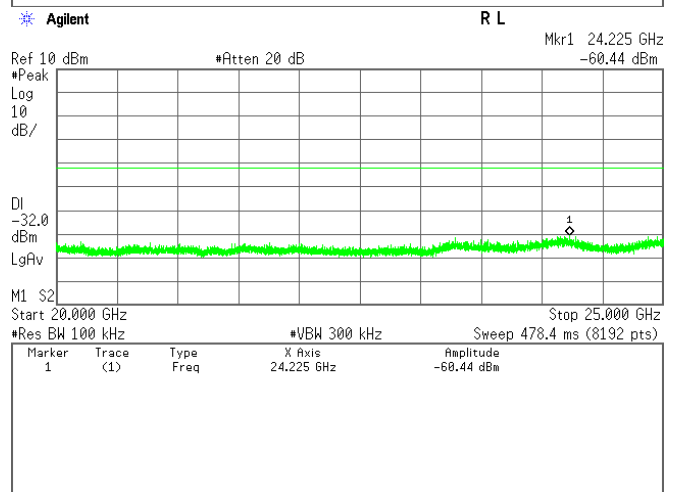
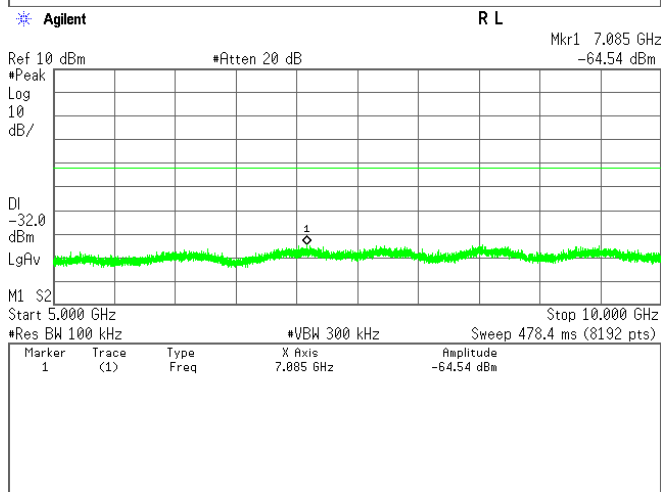
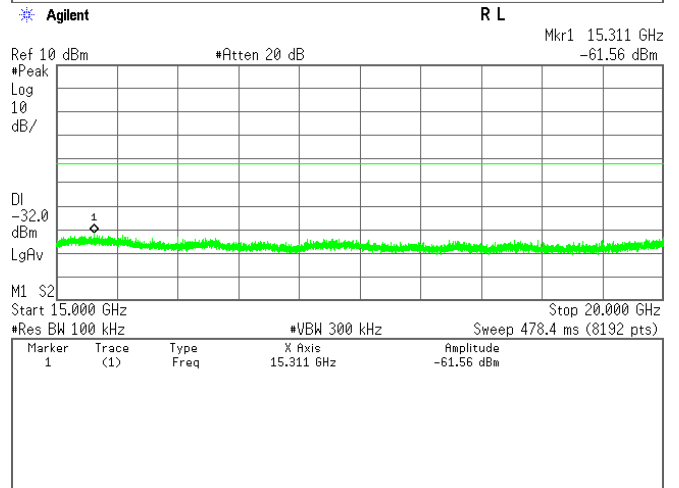
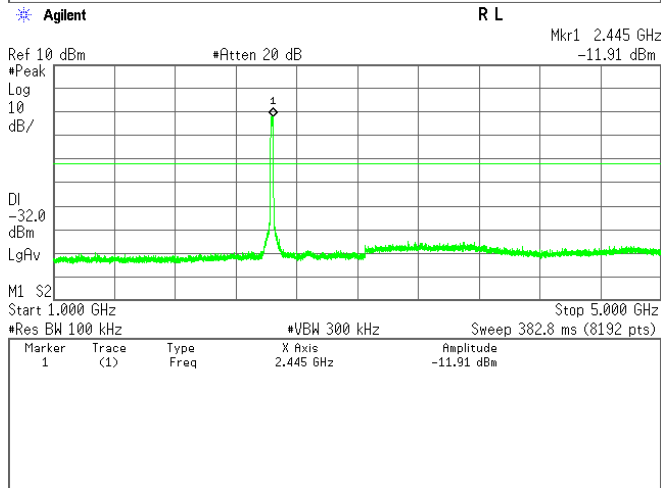
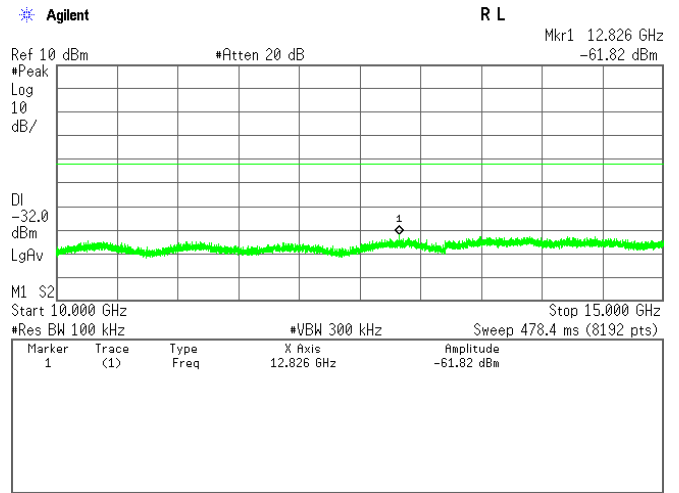
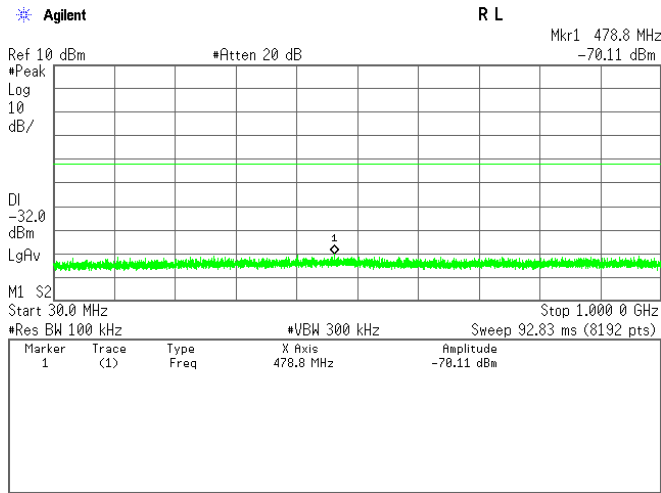

High Channel

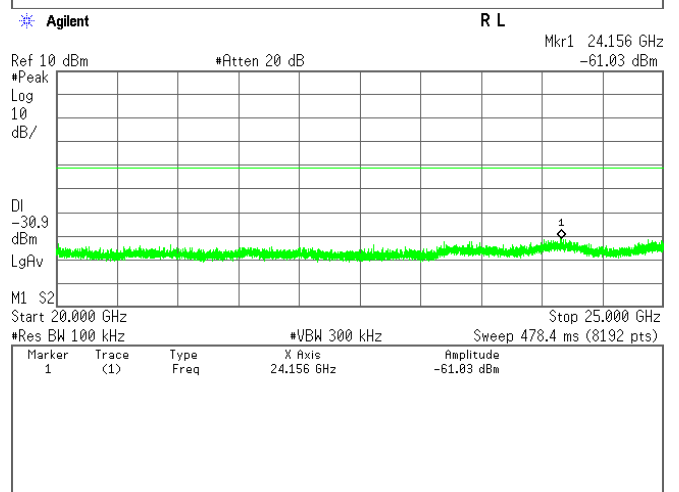
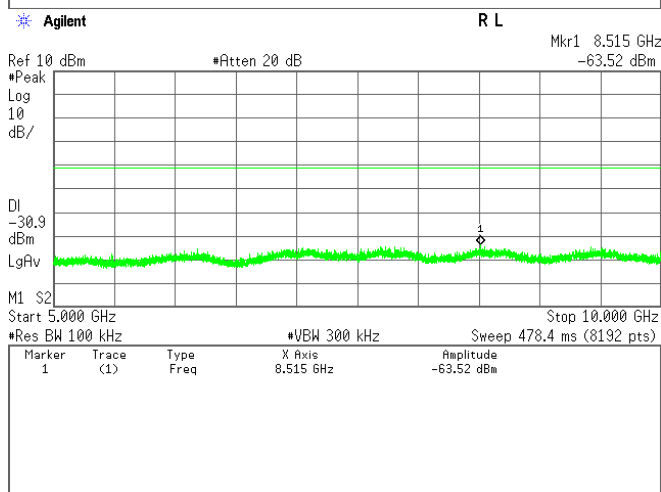
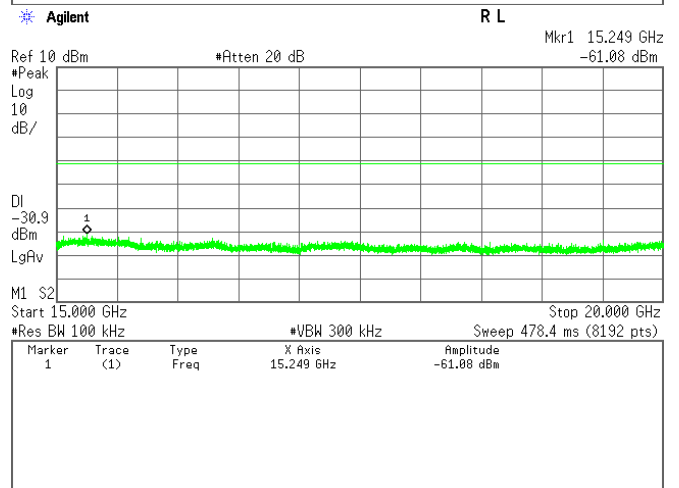
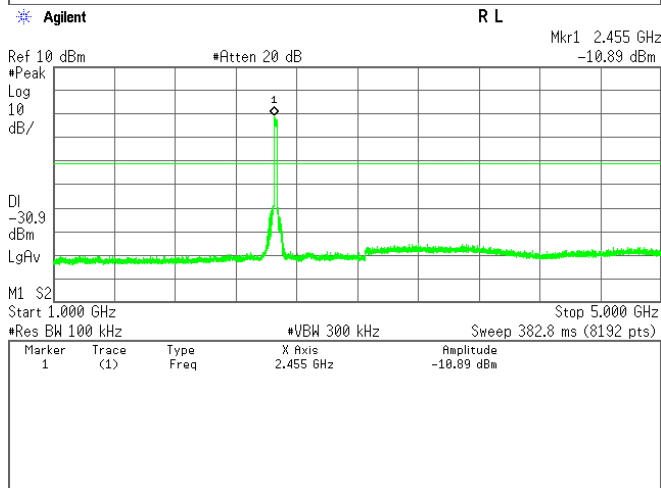
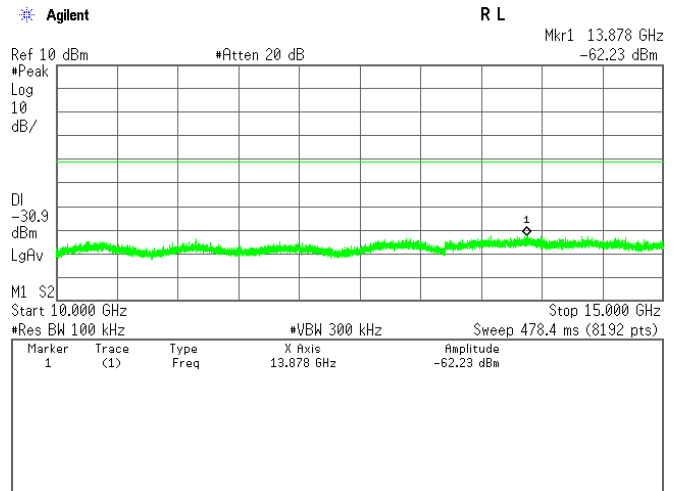
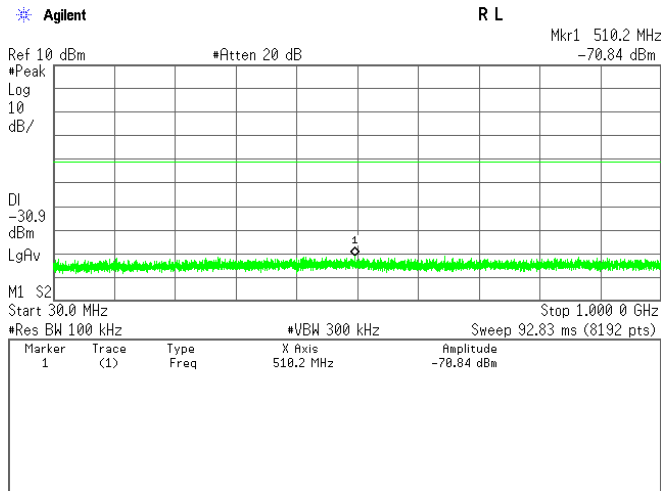

3-1) IEEE 802.11n (Main Antenna)

Low Channel

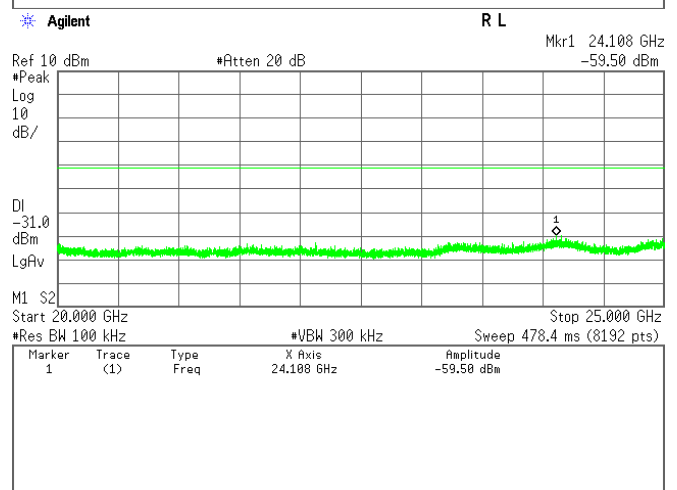
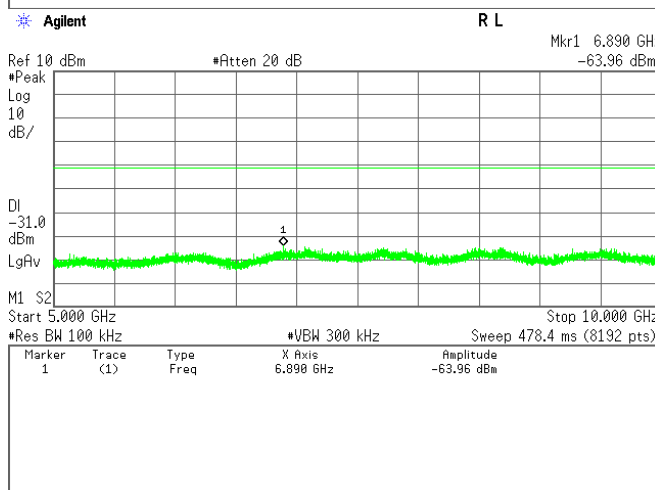
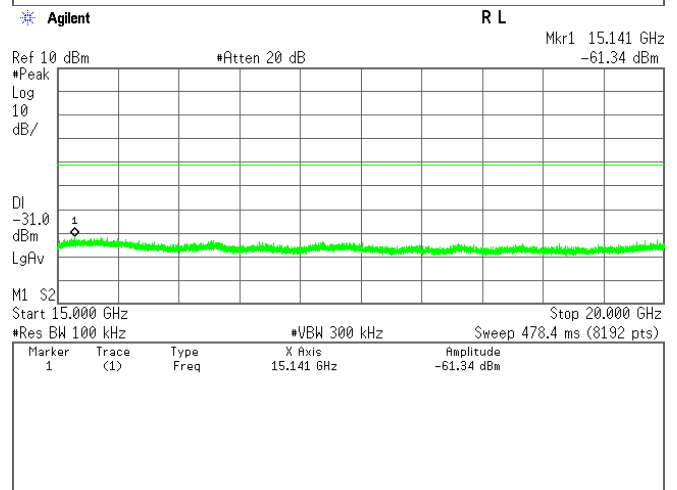
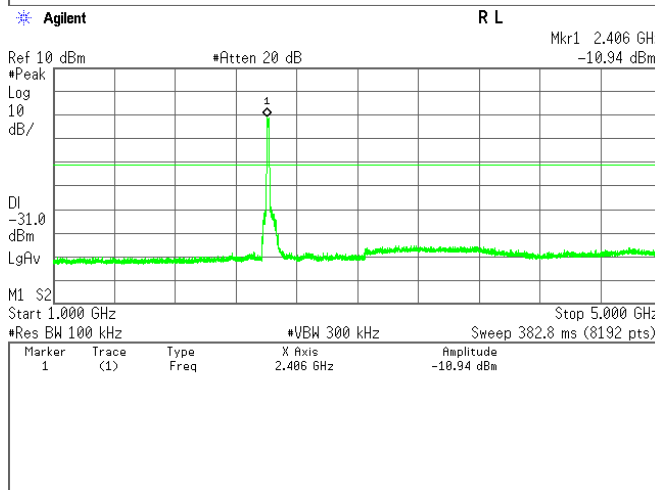
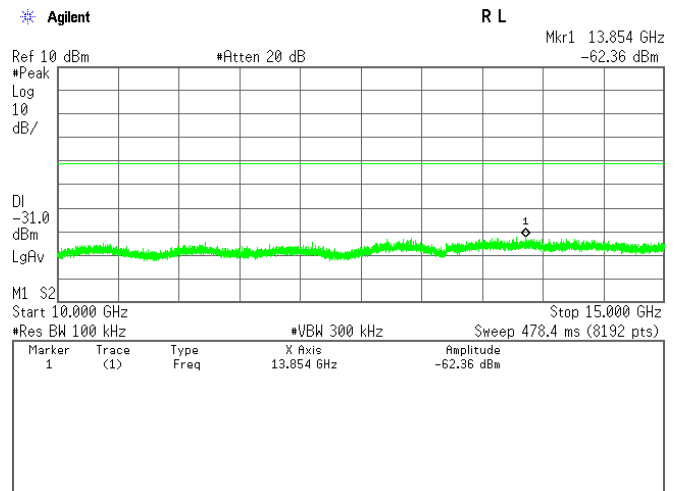
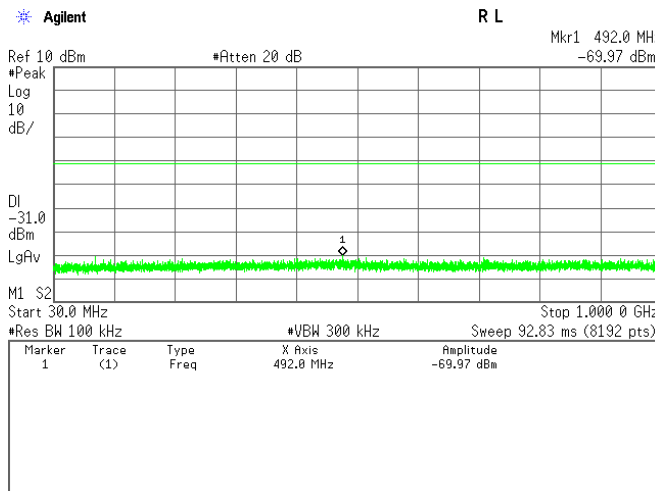

Middle Channel

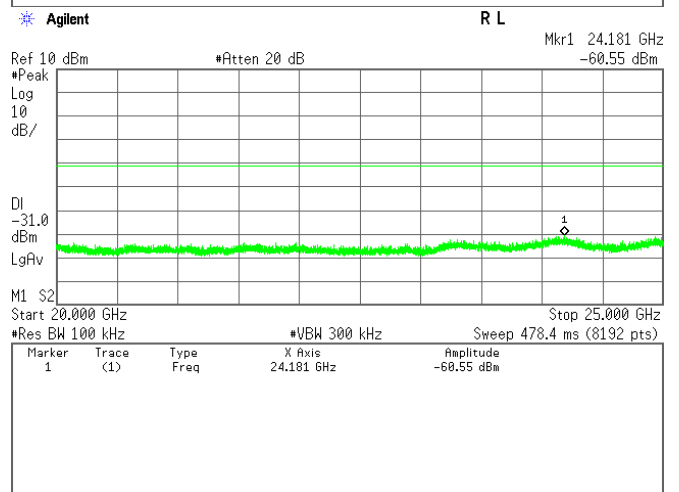
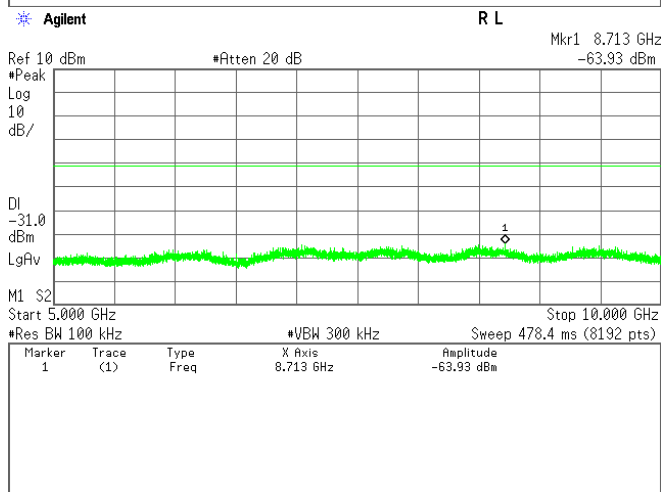
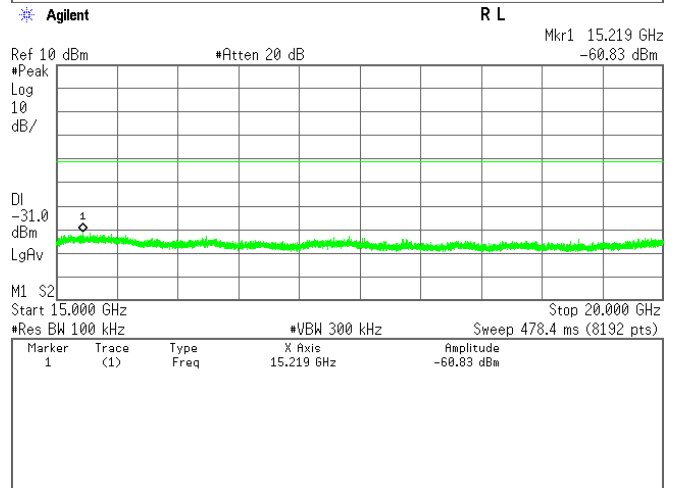
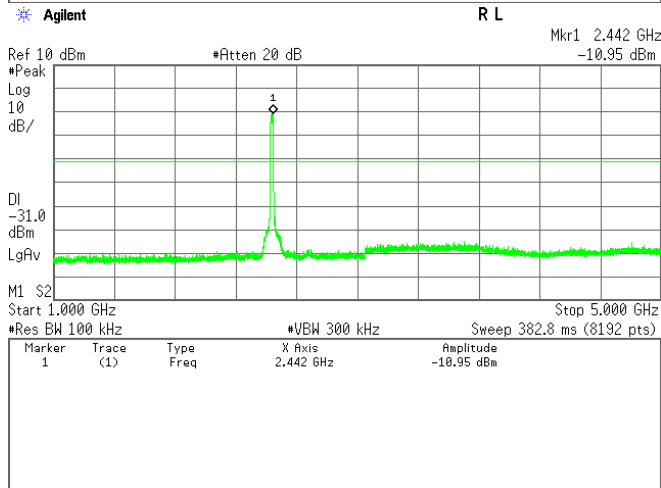
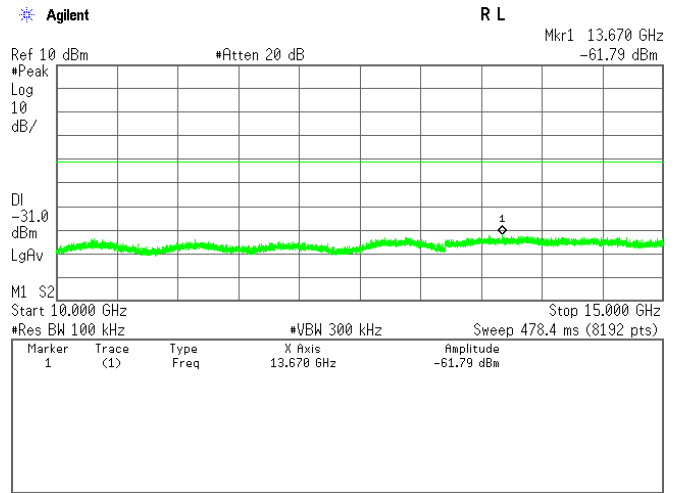
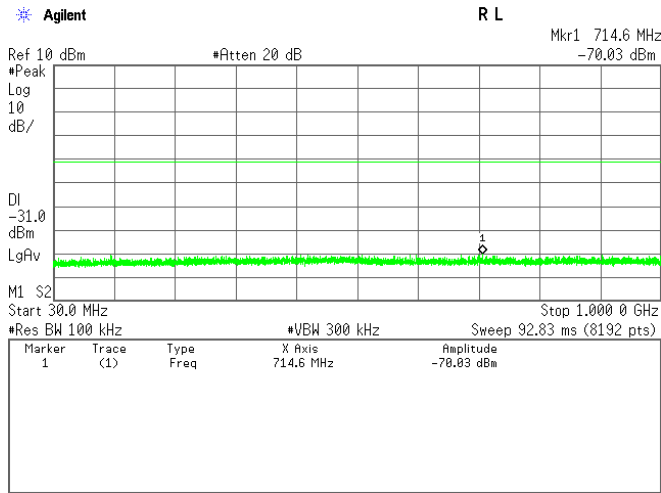

High Channel

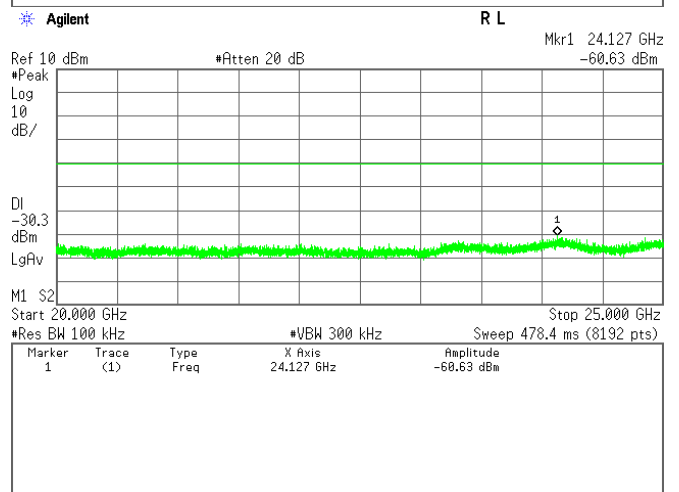
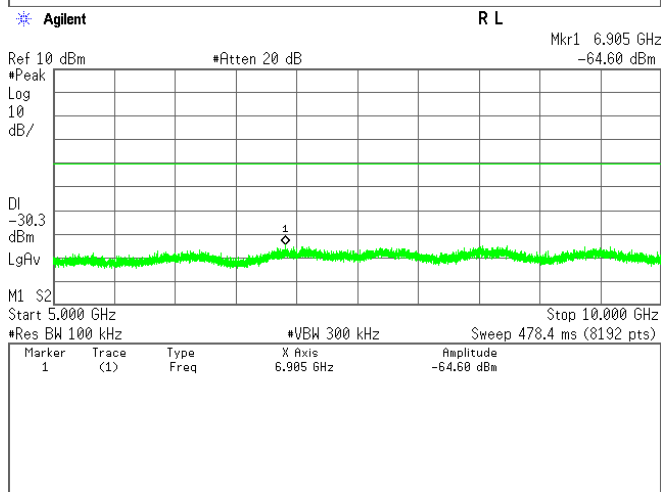
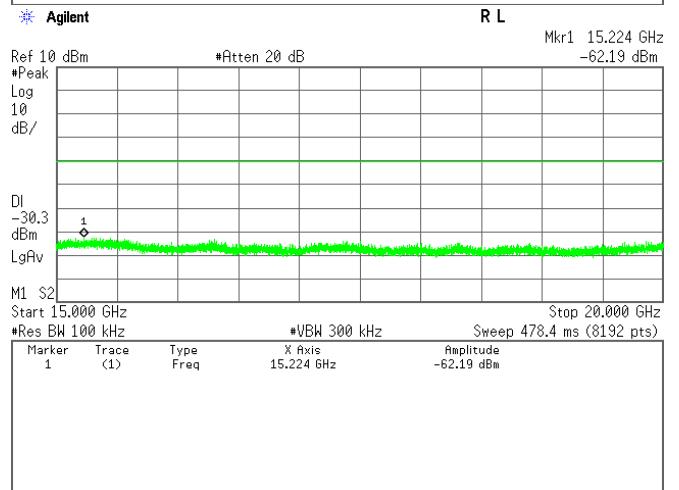
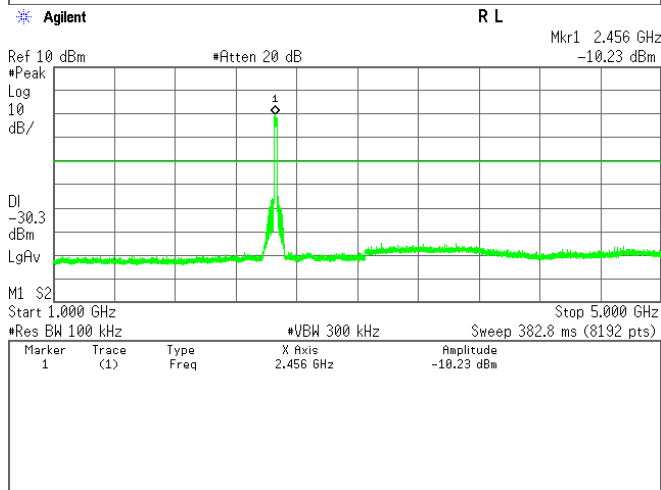
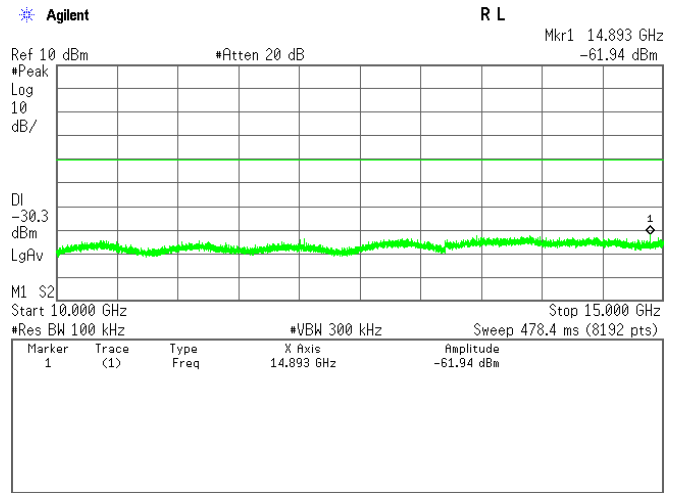
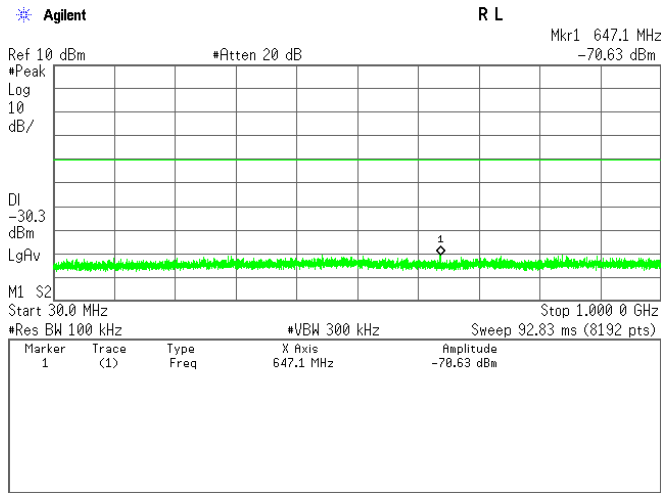

3-2) IEEE 802.11n (Sub Antenna)

Low Channel

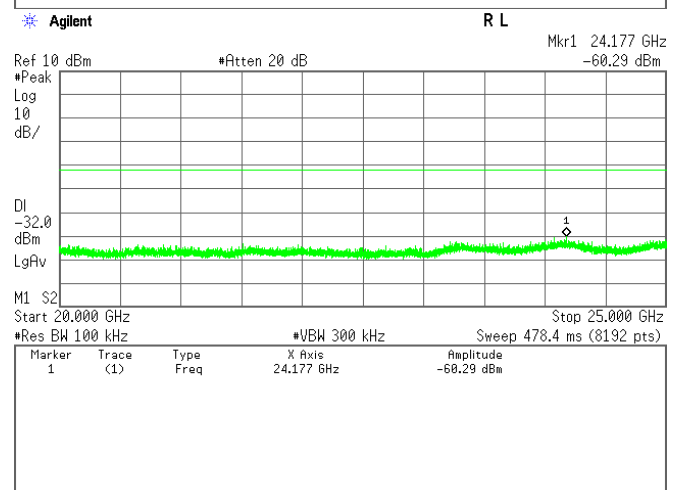
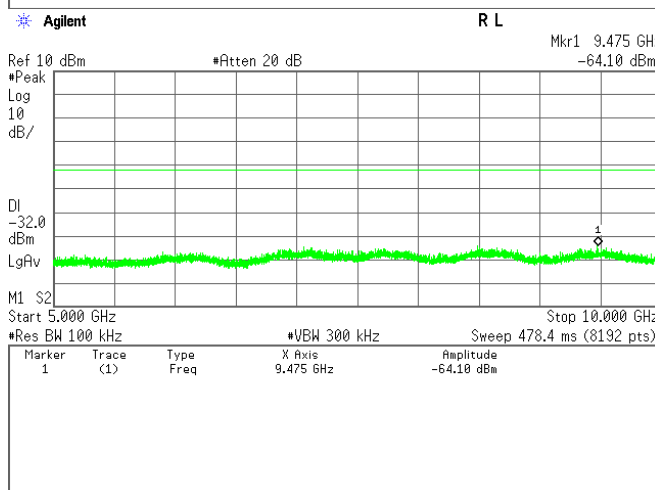
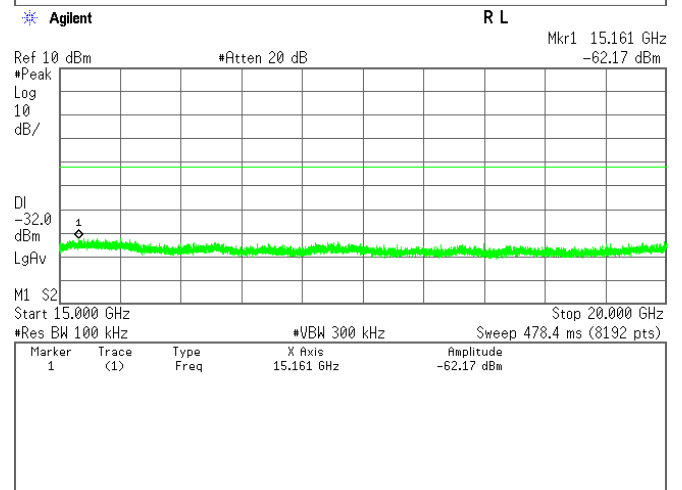
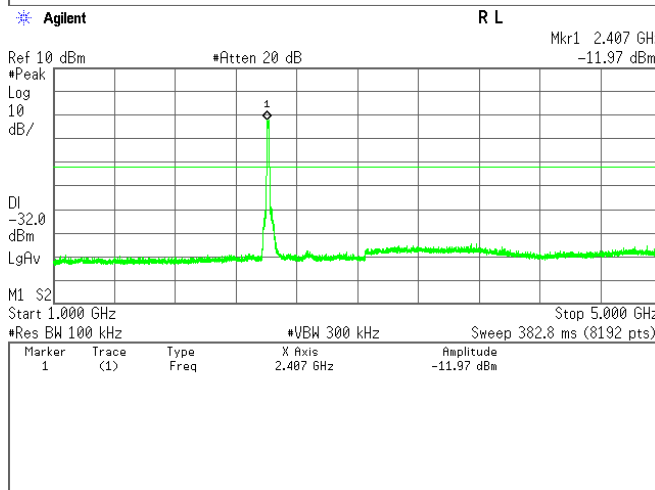
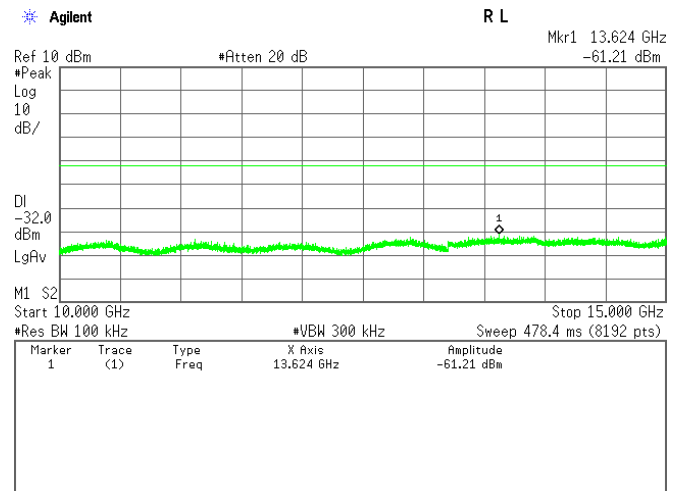
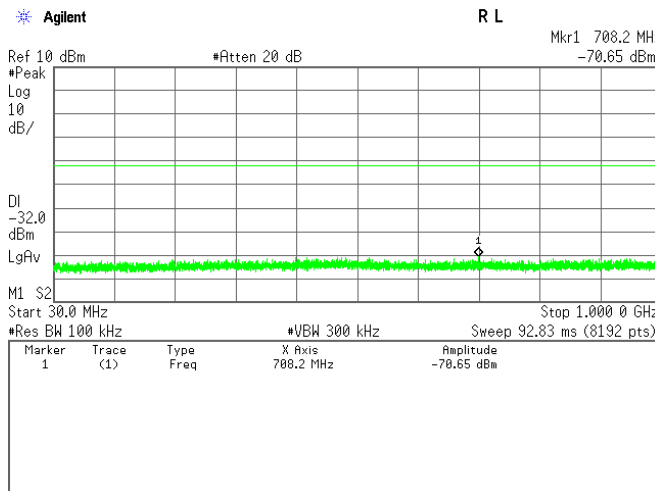

Middle Channel

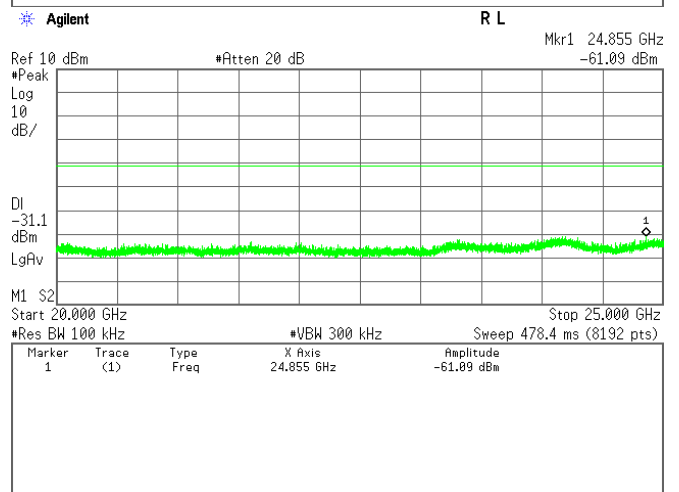
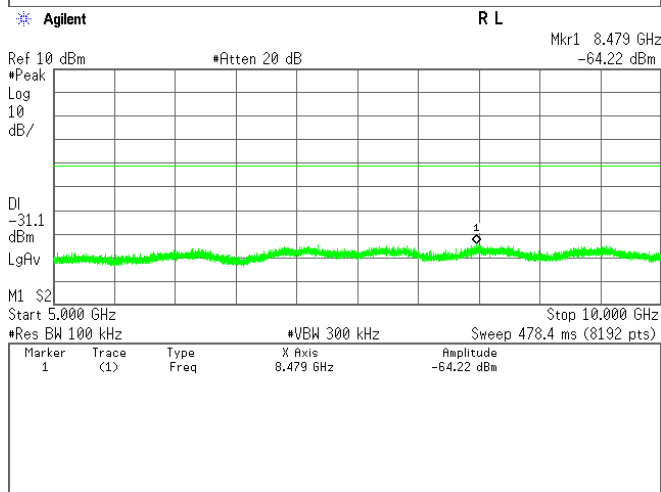
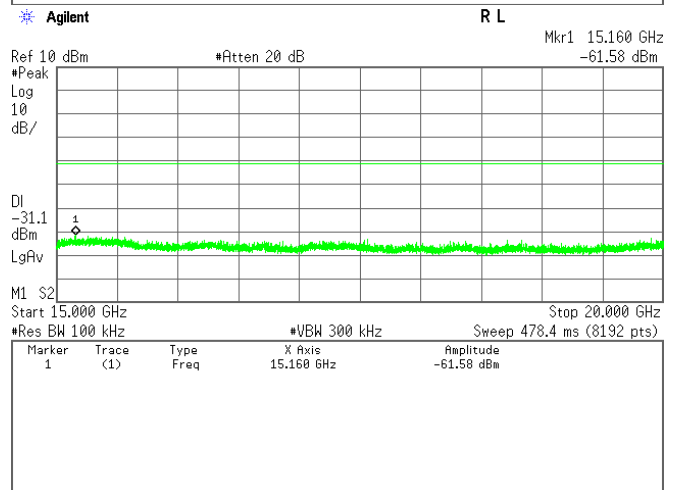
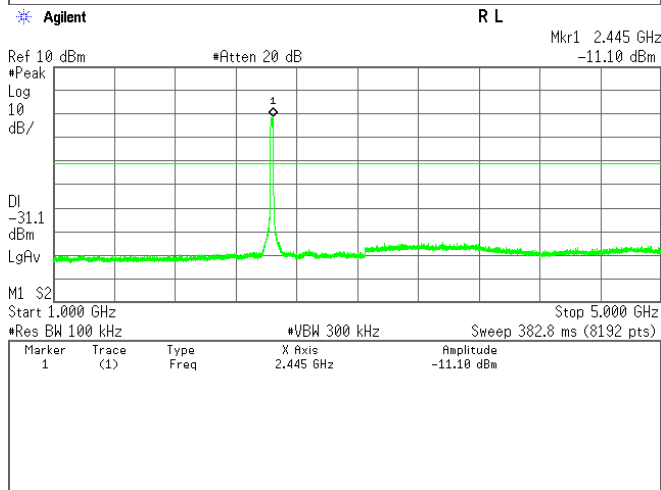
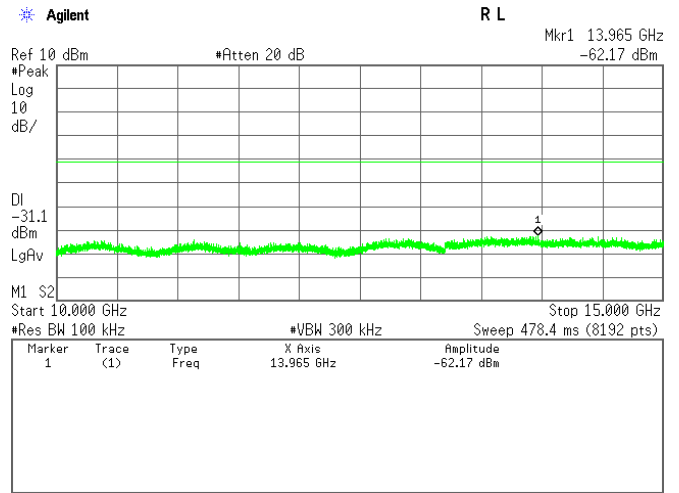
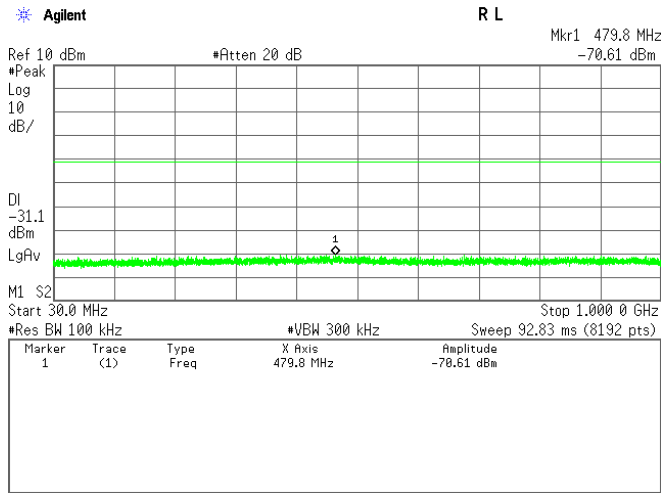

High Channel

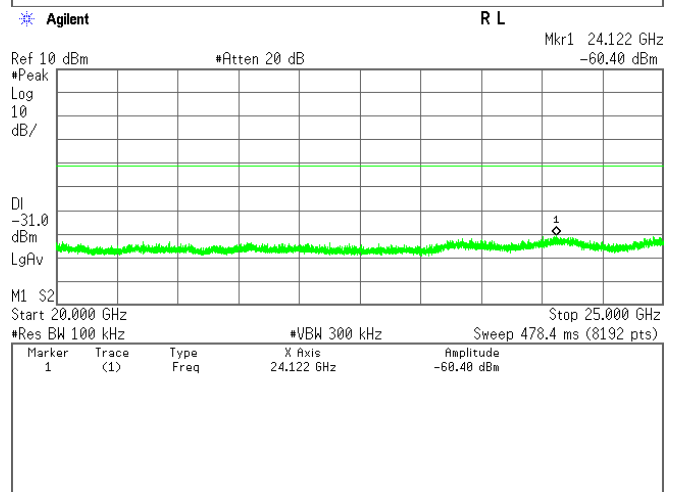
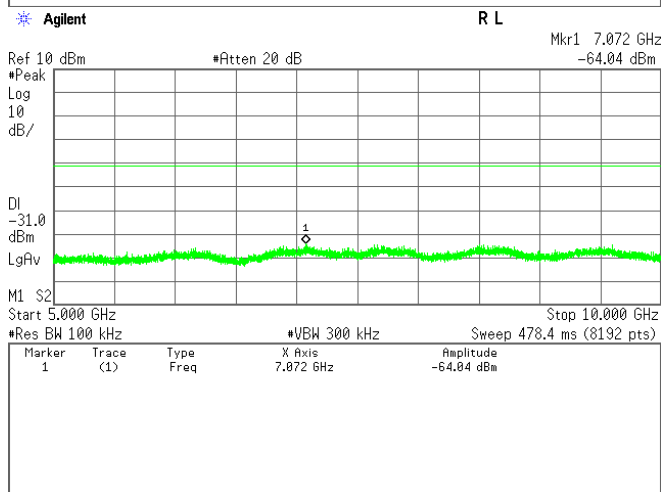
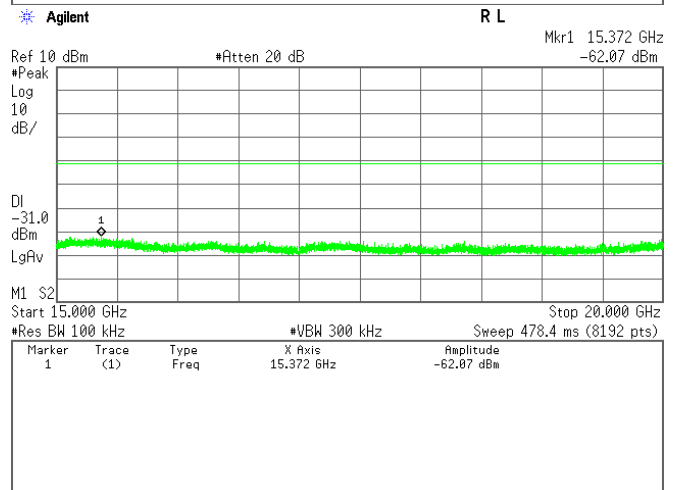
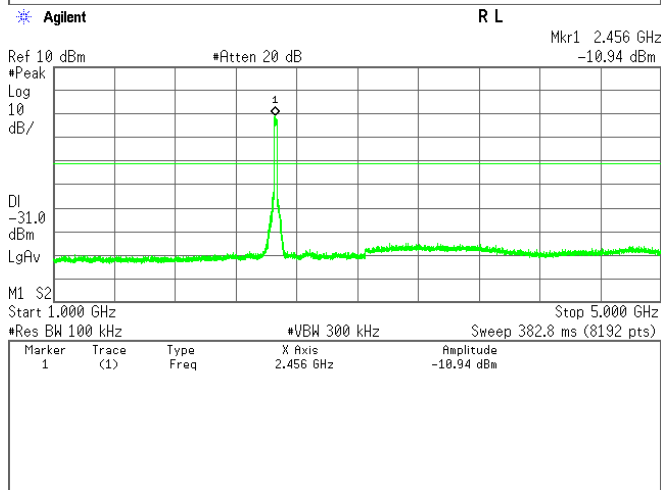
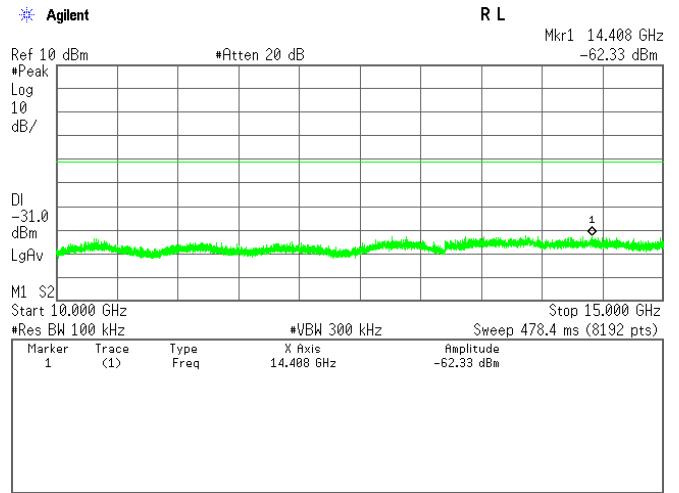
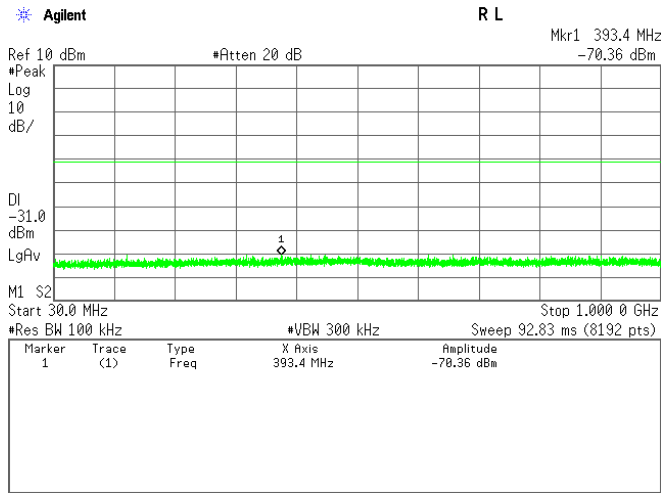

4) Bluetooth Low Energy

Low Channel

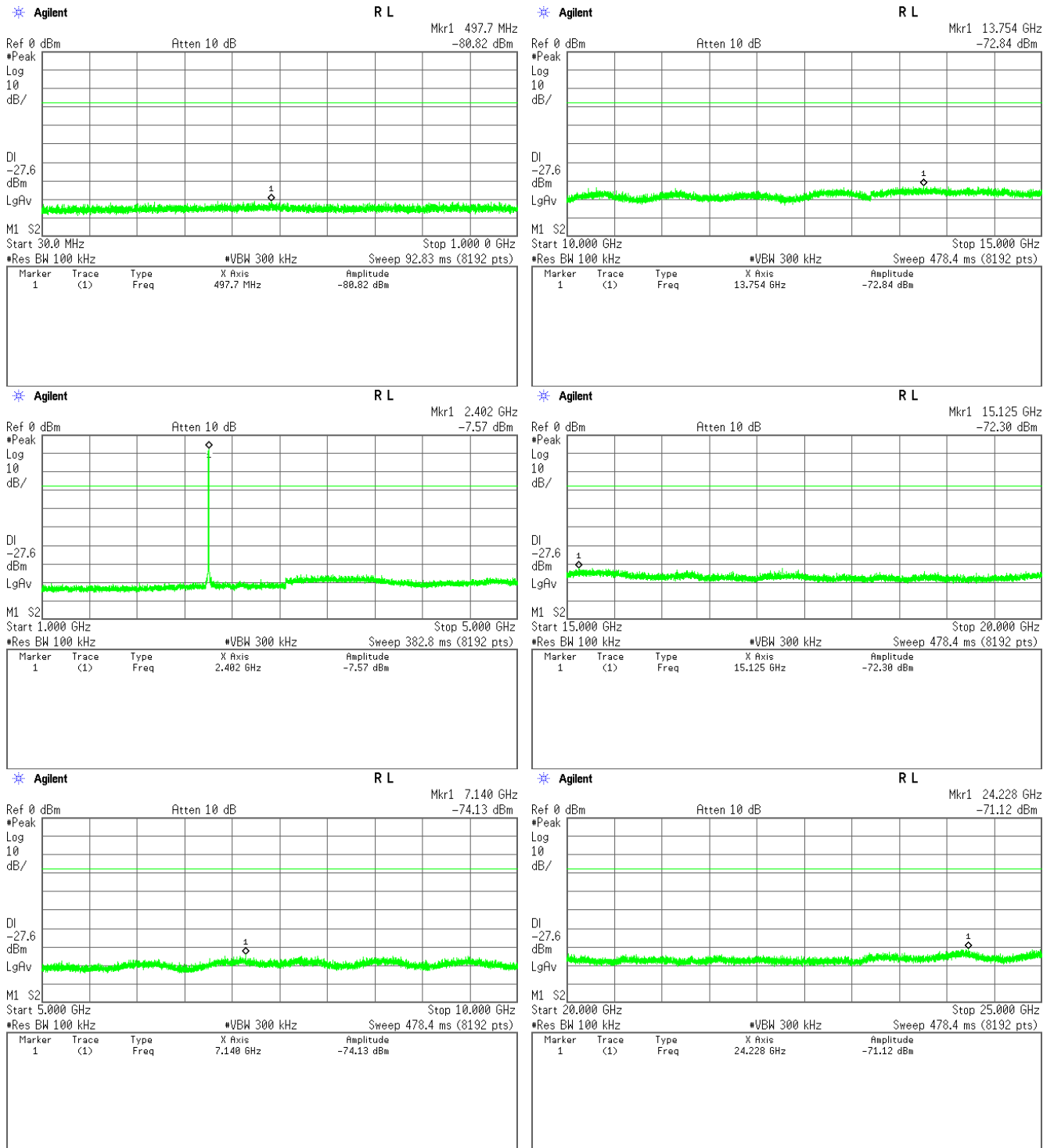

Middle Channel

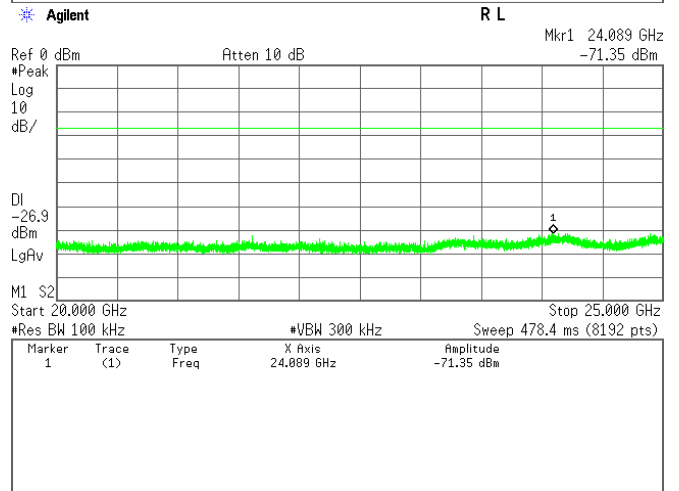
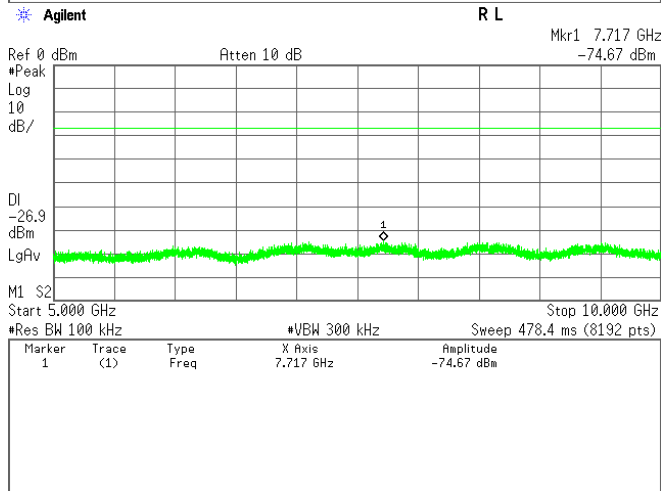
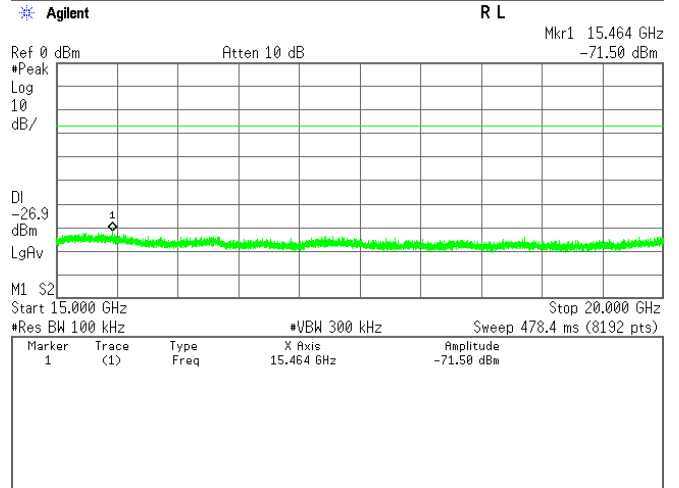
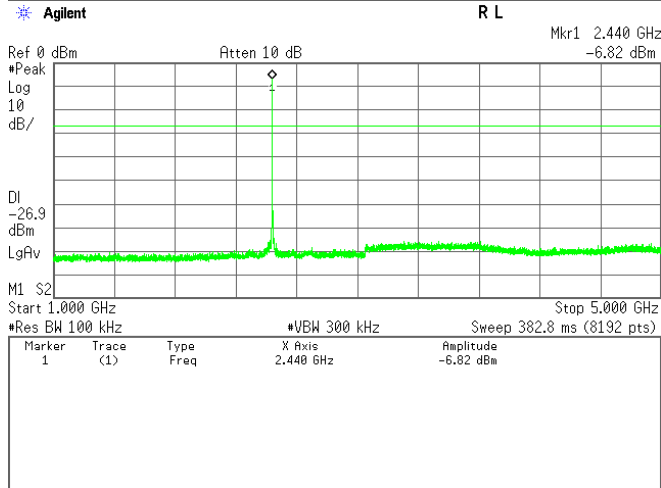
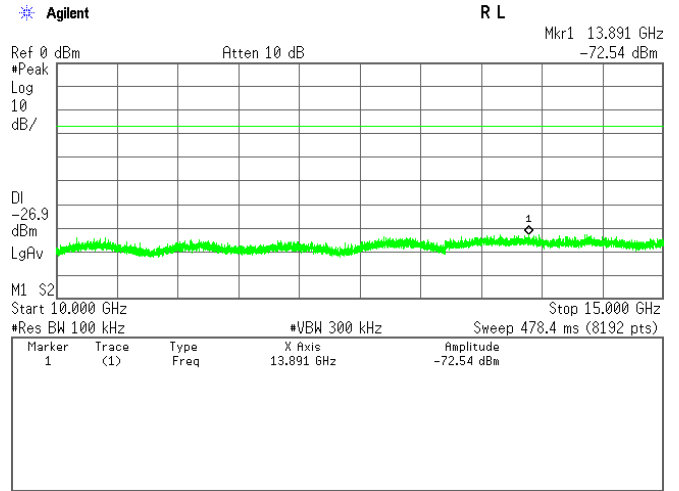
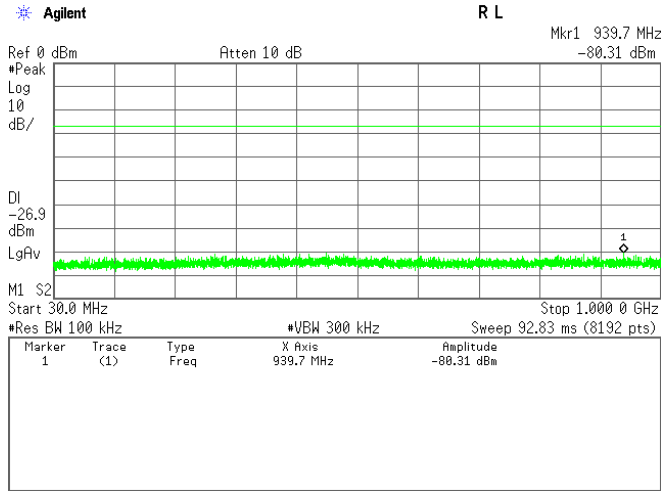

High Channel

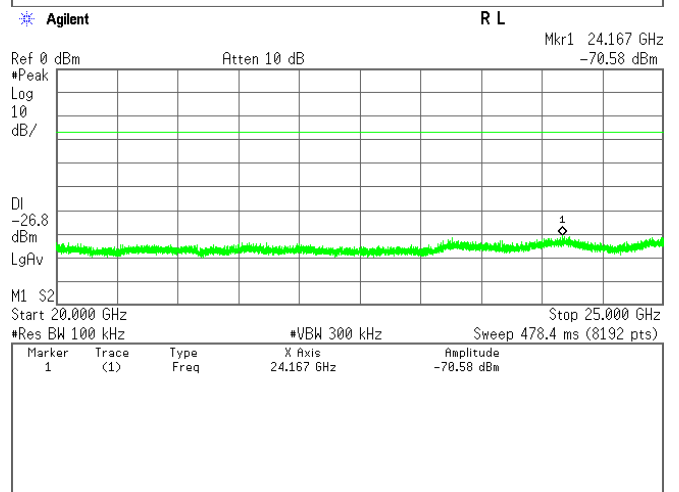
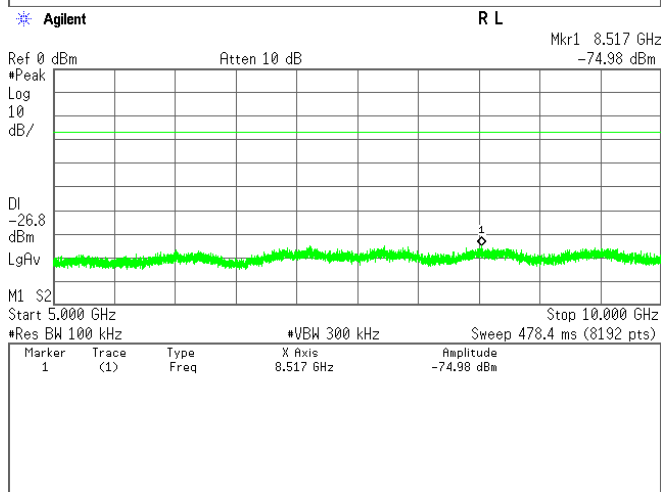
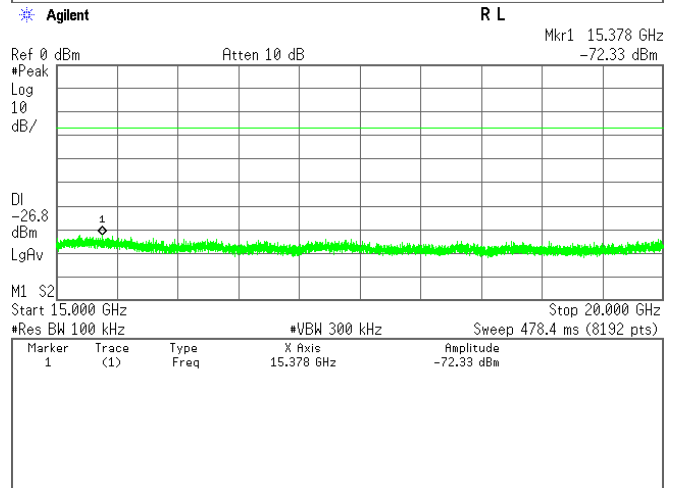
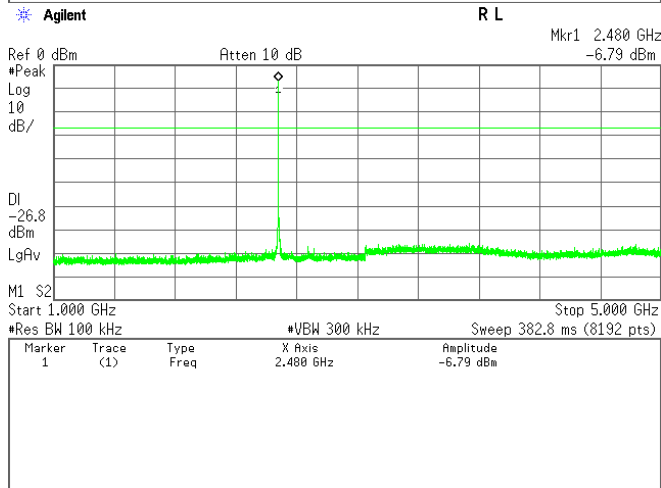
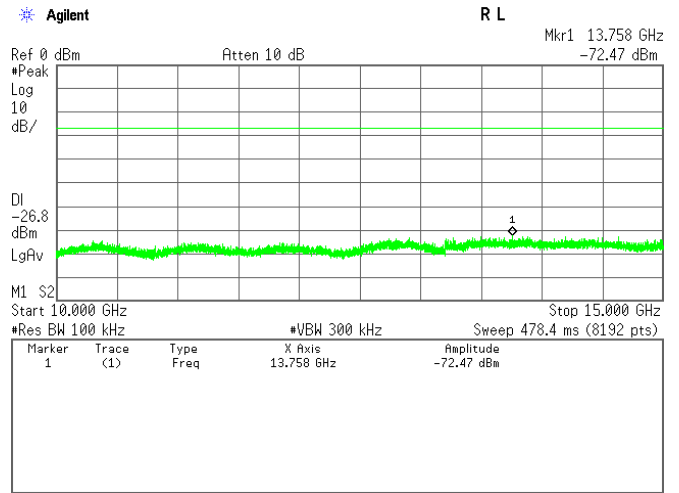
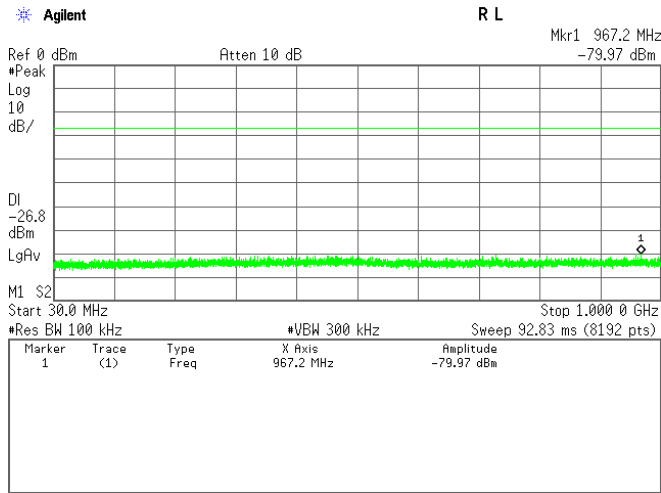

Band-Edge Emission

Test Date : September 11, 2015

Temp.:26°C, Humi:57%

1-1) IEEE 802.11b (Main Antenna)

Low Channel

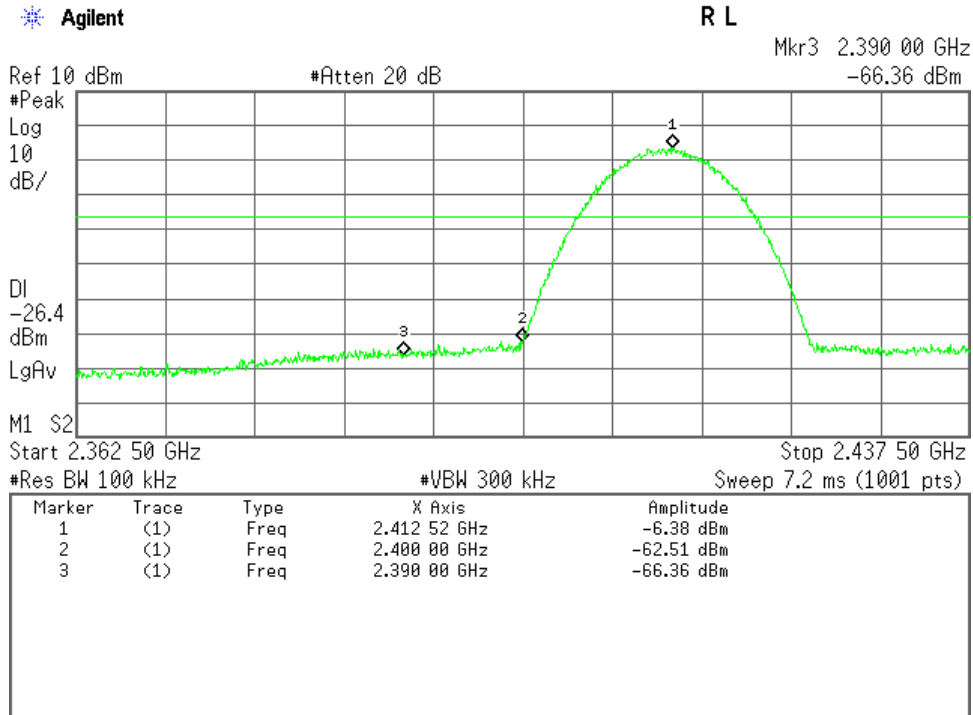

High Channel

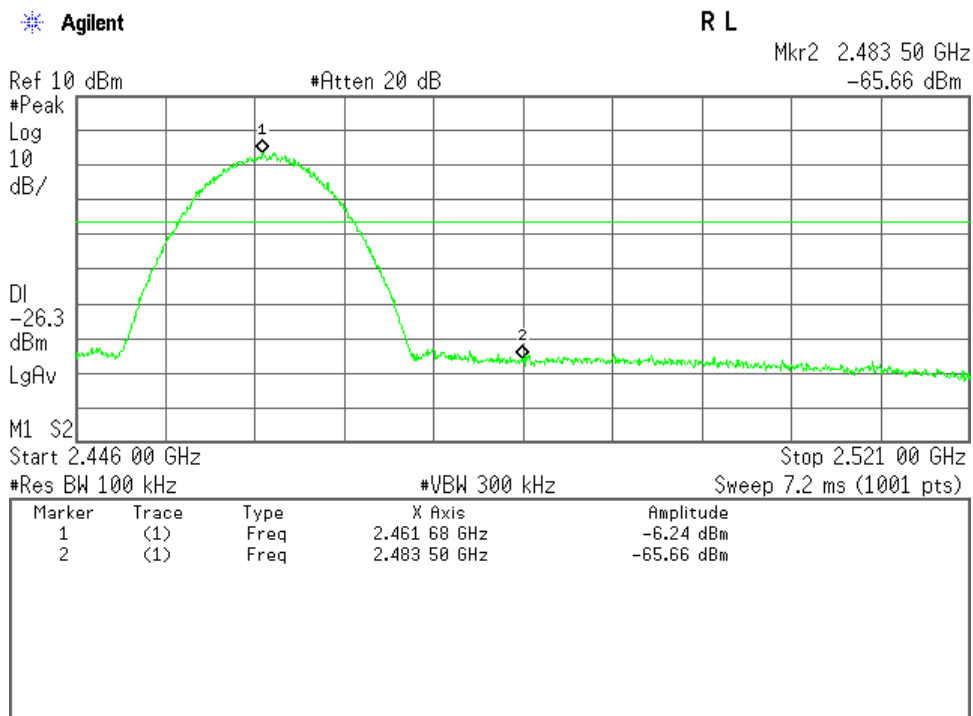

1-2) IEEE 802.11b (Sub Antenna)

Low Channel

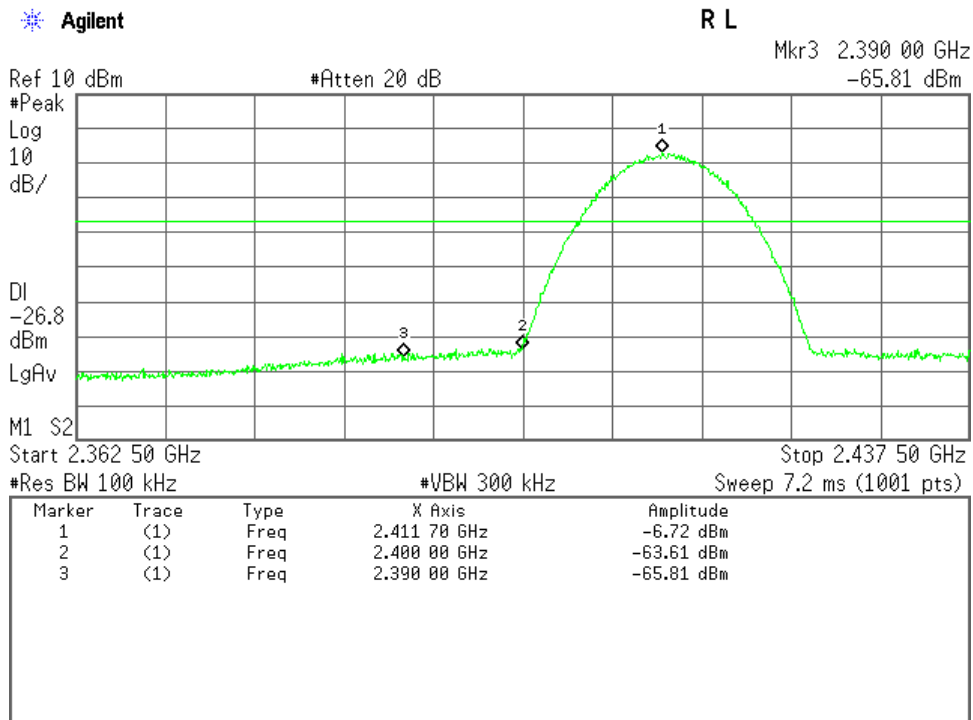

High Channel

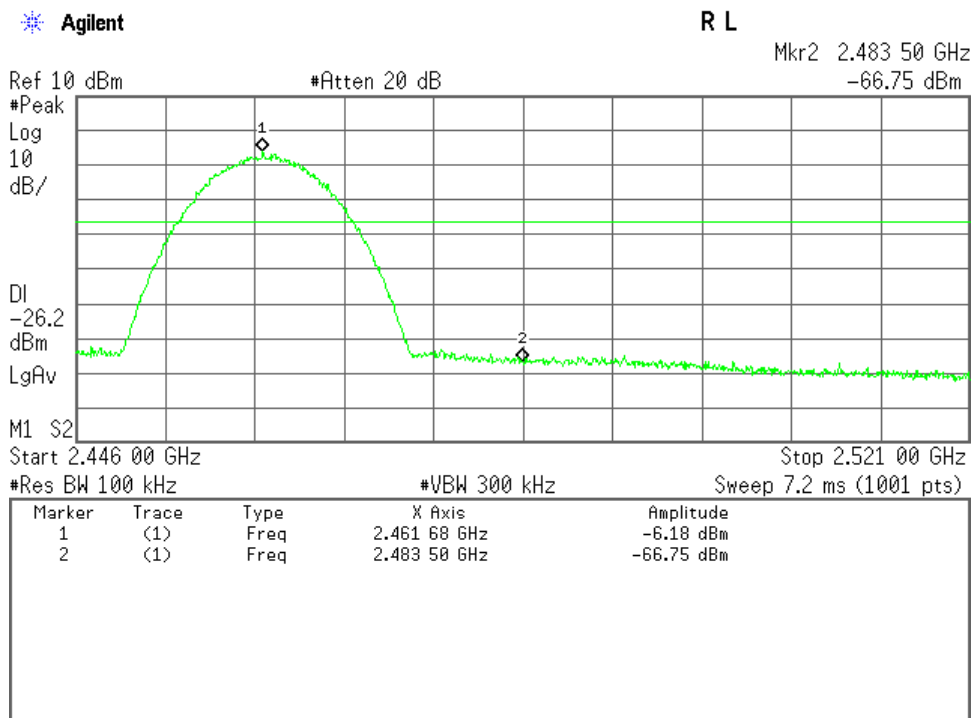

2-1) IEEE 802.11g (Main Antenna)

Low Channel

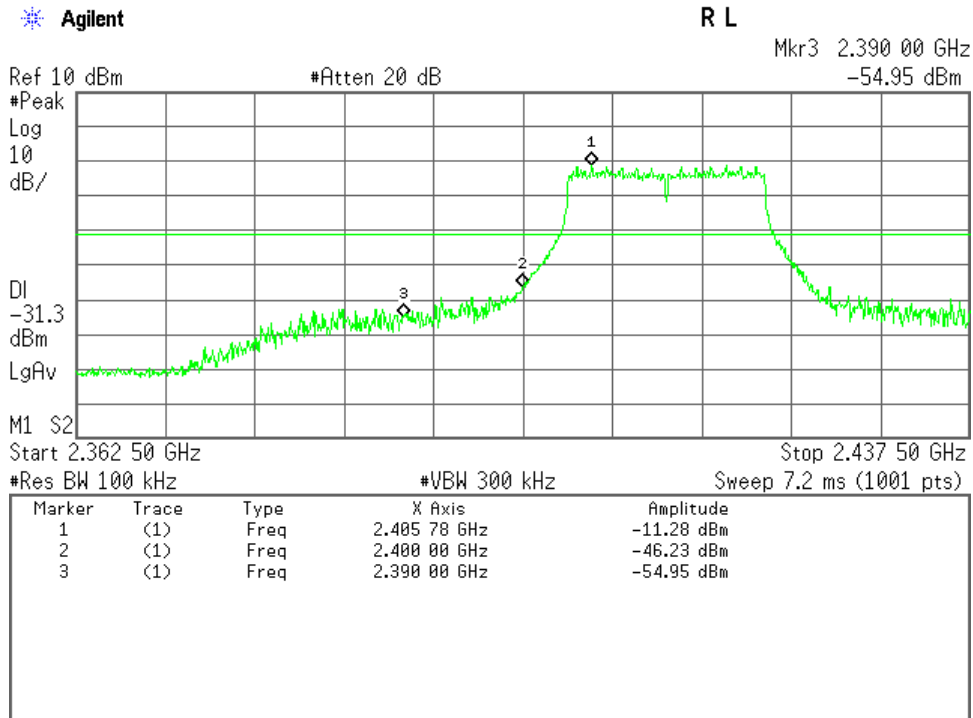

High Channel

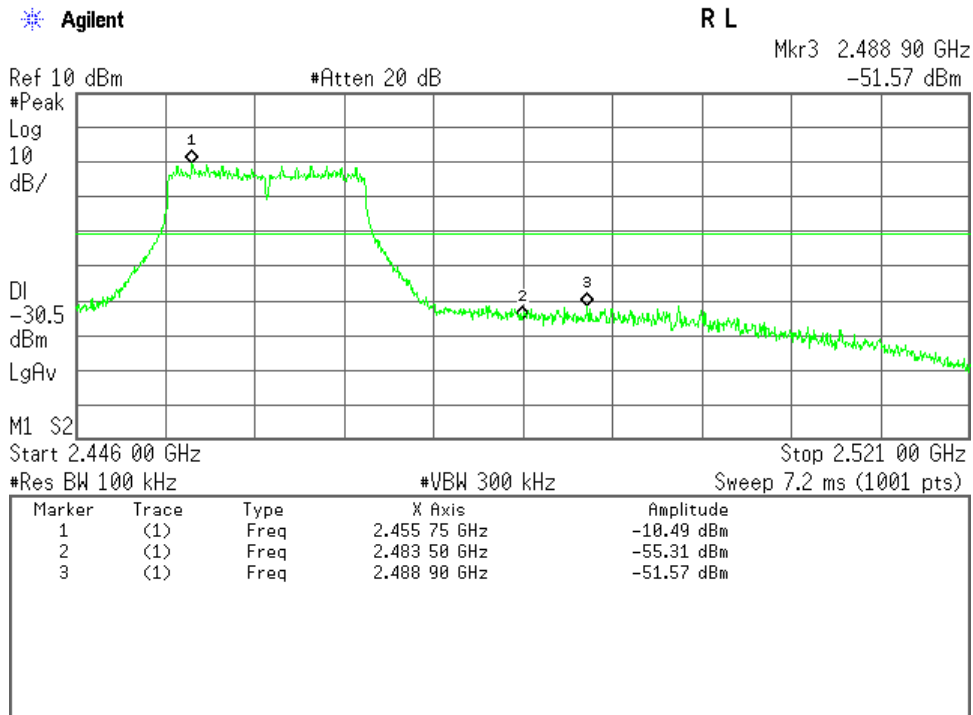

2-2) IEEE 802.11g (Sub Antenna)

Low Channel

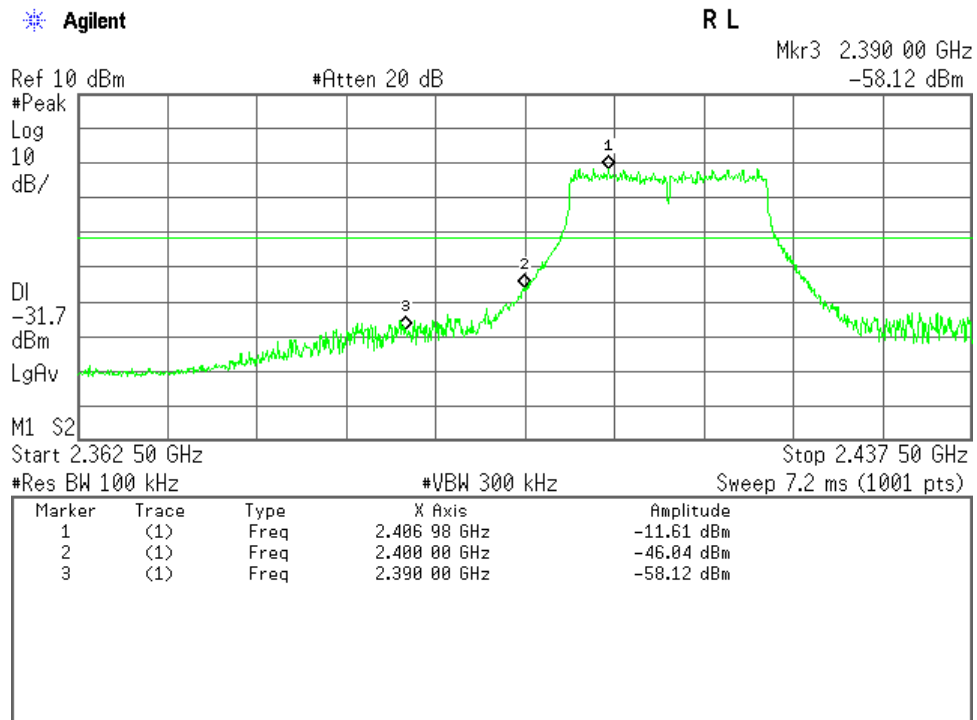

High Channel

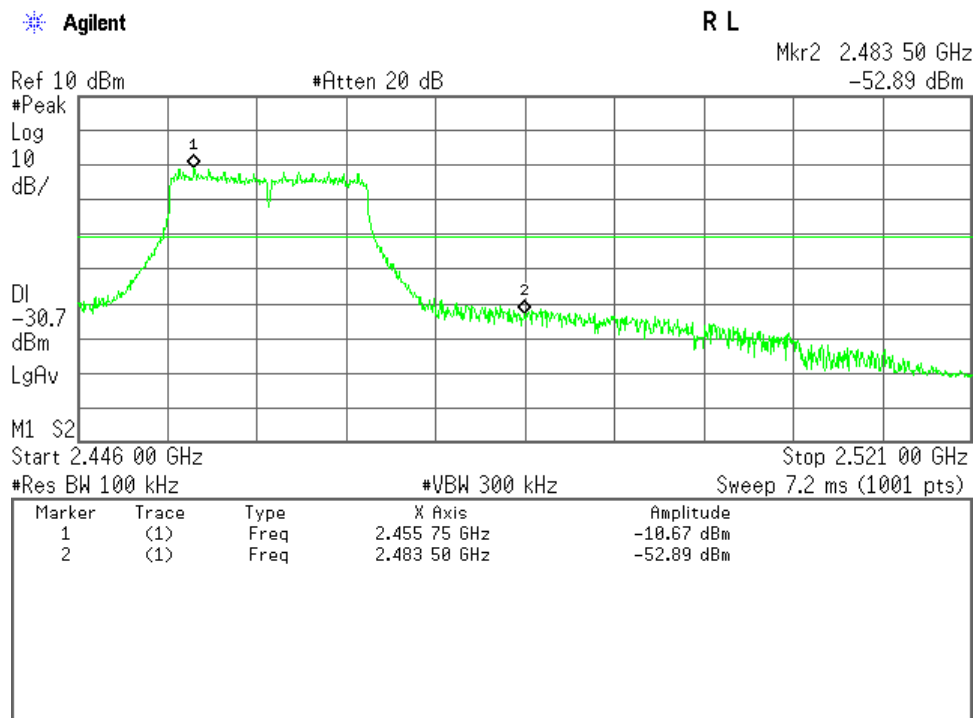

3-1) IEEE 802.11n (Main Antenna)

Low Channel

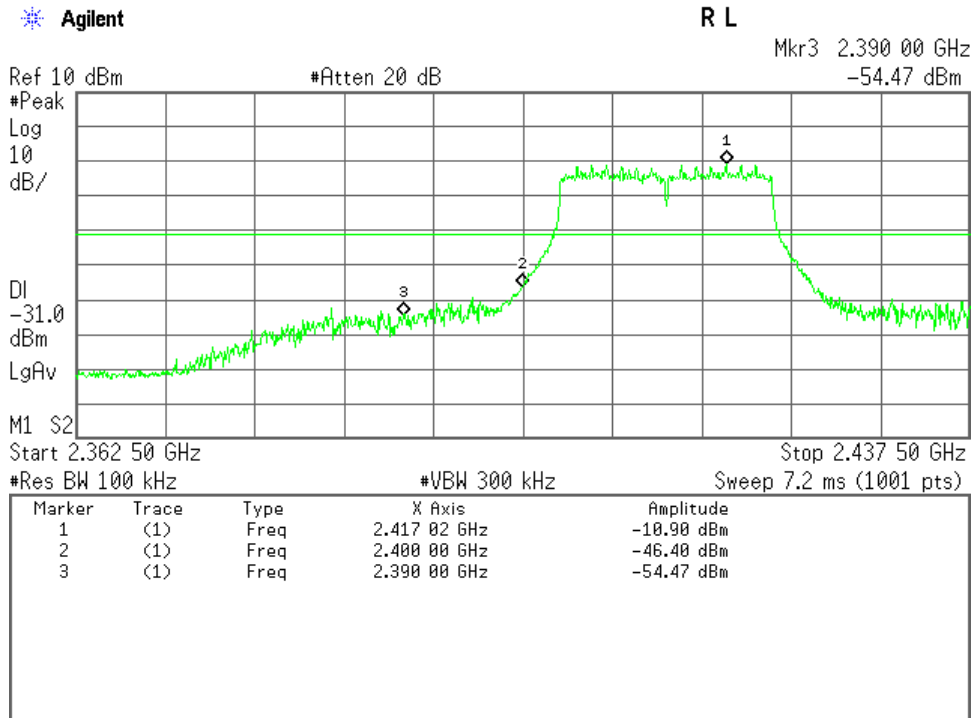

High Channel

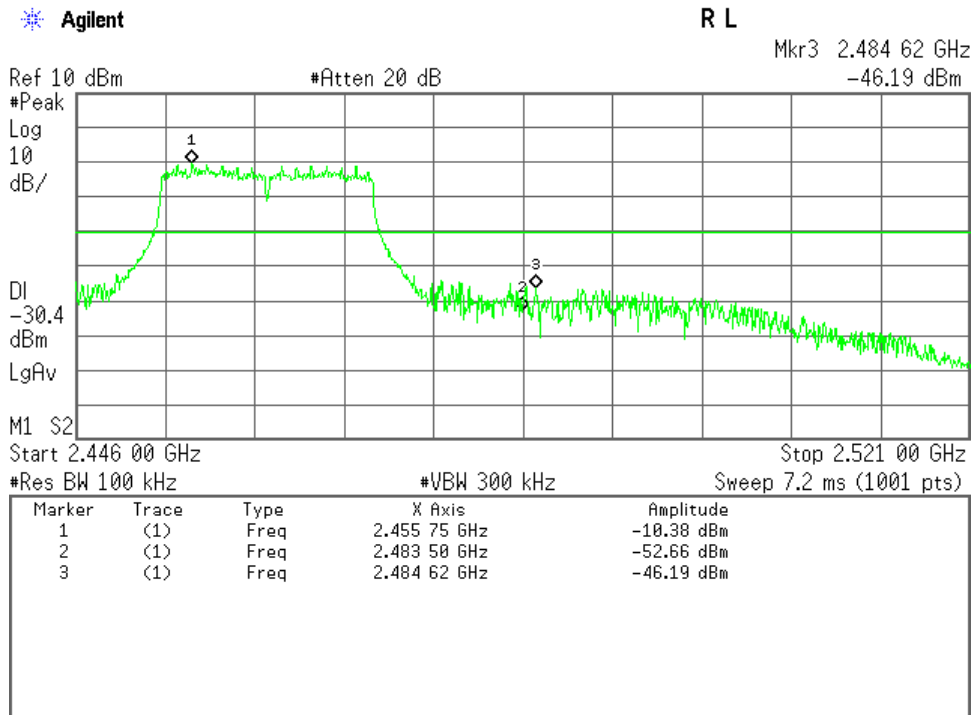

3-2) IEEE 802.11n (Sub Antenna)

Low Channel

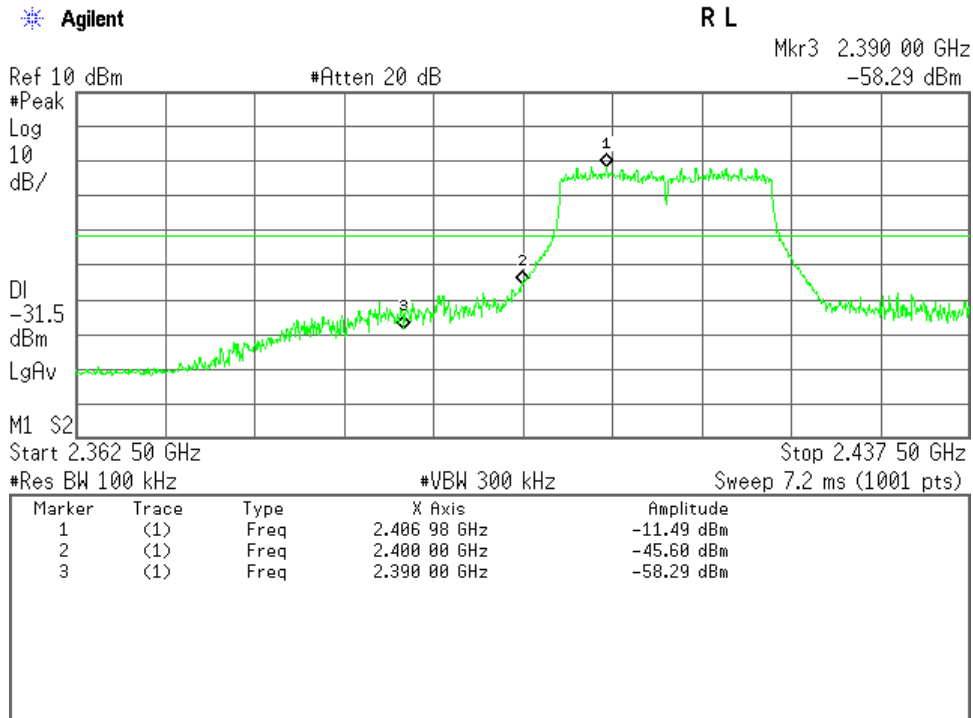

High Channel

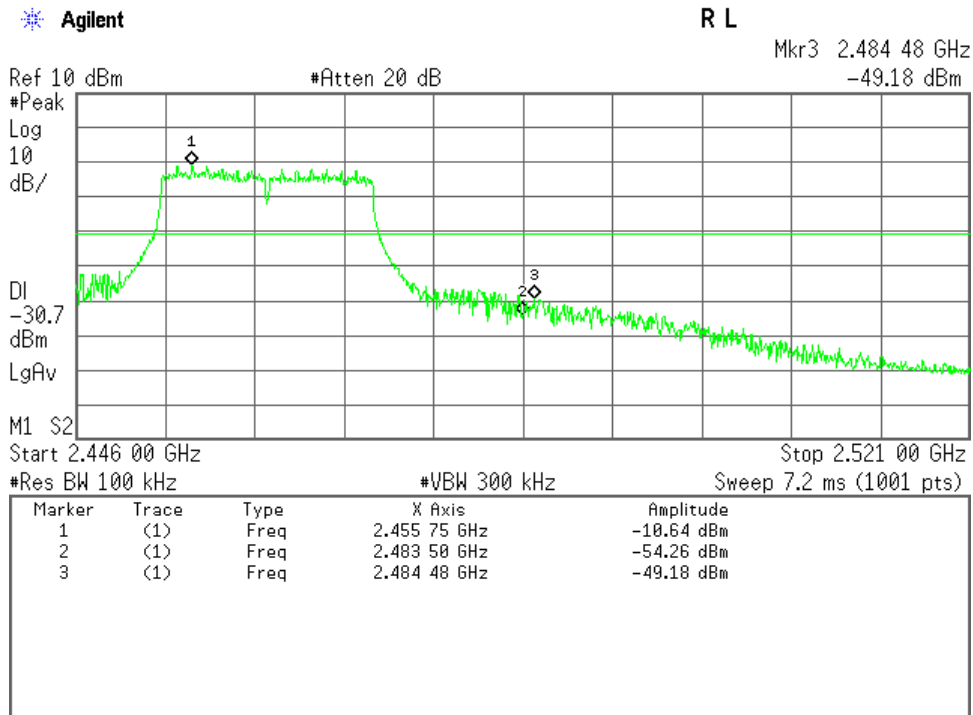

4) Bluetooth Low Energy

Low Channel

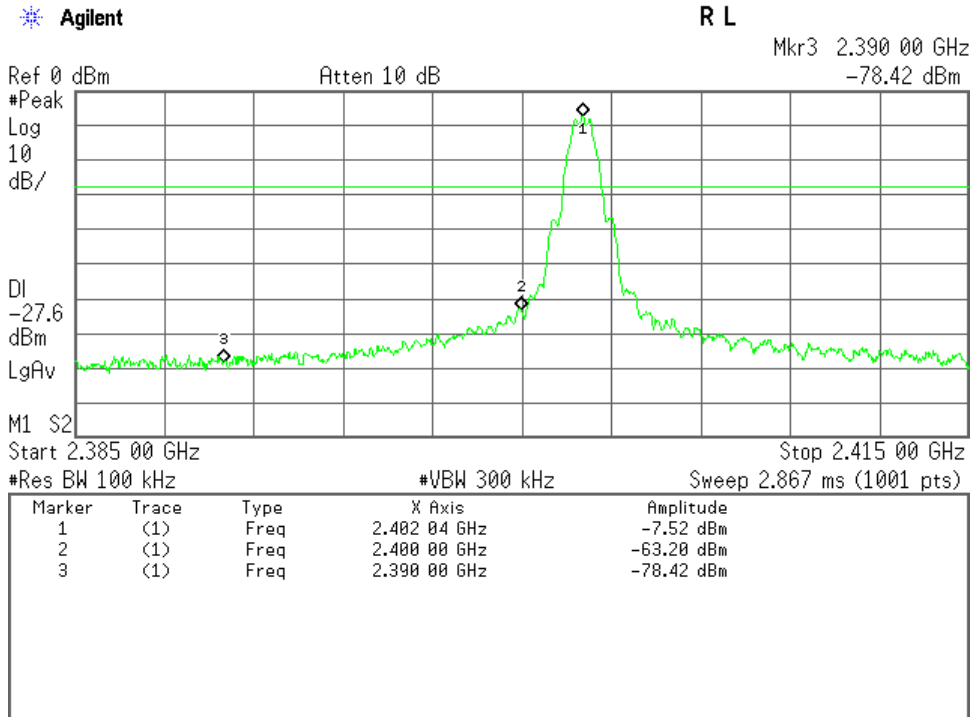

High Channel

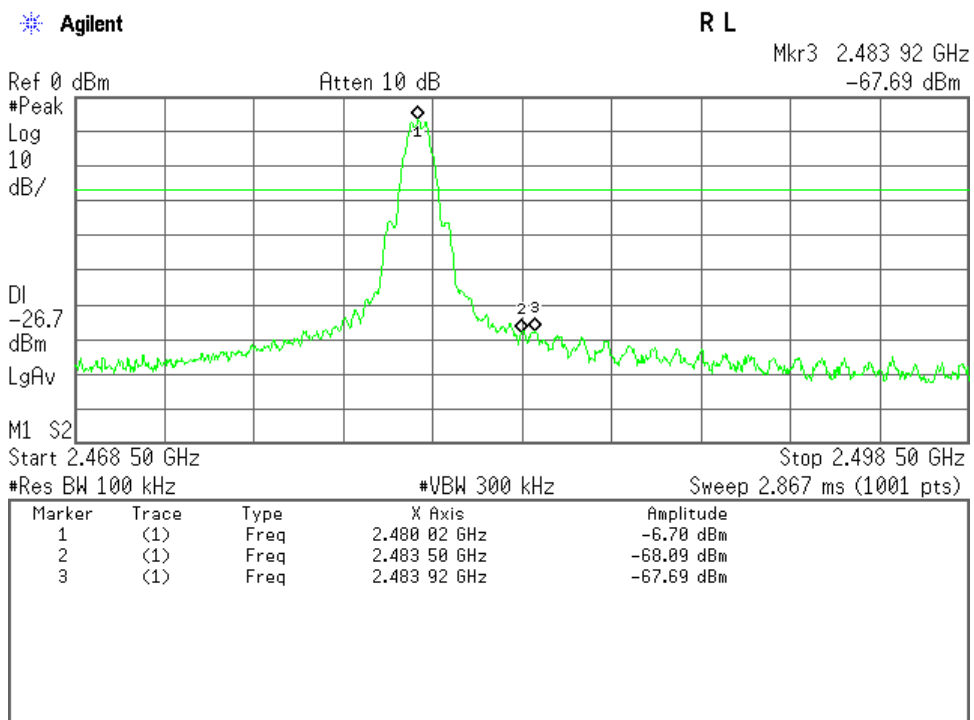

7.8 AC Powerline Conducted Emission

For the requirements, - Applicable [- Tested. - Not tested by applicant request.]
 - Not Applicable

7.8.1 Test Results

For the standard, - Passed - Failed - Not judged

Min. Limit Margin (Quasi-Peak) 12.0 dB at 1.480 MHz

Uncertainty of Measurement Results ± 2.6 dB(2σ)

Remarks : Bluetooth Low Energy mode

7.8.2 Test Instruments

Measurement Room M2				
Type	Model	Serial No. (ID)	Manufacturer	Cal. Due
Test Receiver	ESU 26	100170 (A-6)	Rohde & Schwarz	2016/04/25
AMN (main)	ESH3-Z5	893045/007 (D-12)	Rohde & Schwarz	2016/08/27
RF Cable	RG223/U	--- (H-35)	HUBER+SUHNER	2016/06/04

NOTE : The calibration interval of the above test instruments is 12 months.

7.8.3 Test Method and Test Setup (Diagrammatic illustration)

The preliminary tests were performed using the scan mode of test receiver or spectrum analyzer to observe the emissions characteristics of the EUT.

The EUT configuration, cable configuration and mode of operation were determined for producing the maximum level of emissions.

This configurations was used for final tests.

– Side View –

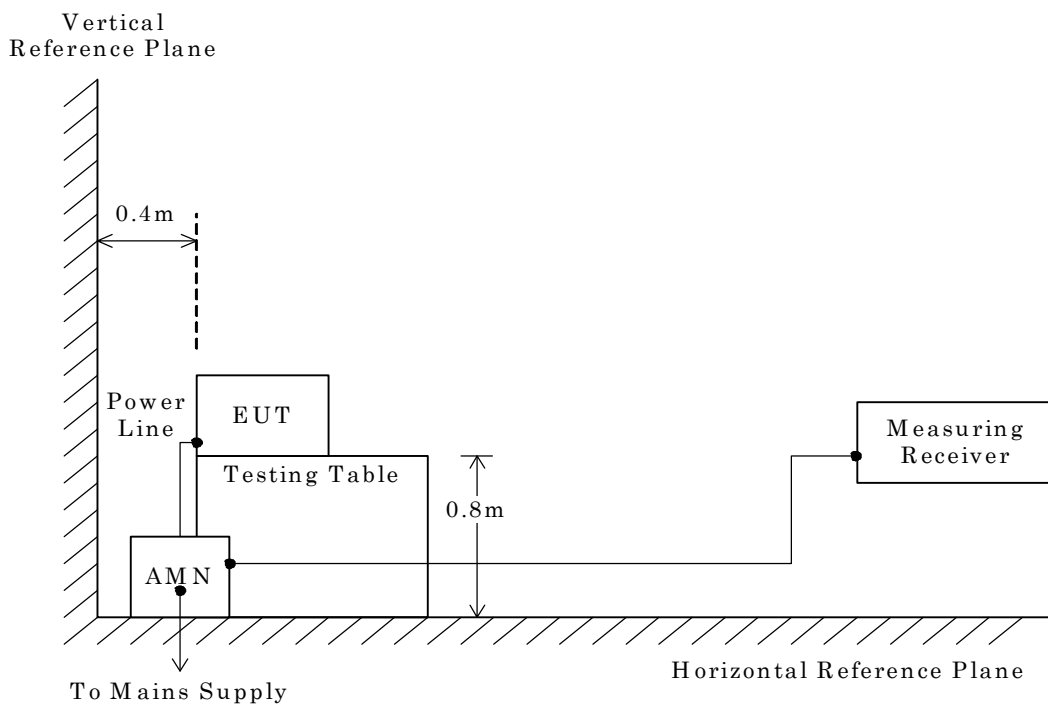

NOTE

AMN : Artificial Mains Network

7.8.4 Test Data

- 1) Mode of EUT : (WLAN) All modes have been investigated and the worst case mode for channel (06ch: 2437MHz / IEEE 802.11b, IEEE 802.11g and IEEE 802.11n) has been listed.

Test voltage : 120VAC 60Hz

Test Date: September 16, 2015
Temp.: 23 °C, Humi.: 65 %

Measured phase : L1

Frequency [MHz]	Corr. Factor [dB]	Meter Readings [dB(μV)]		Limits [dB(μV)]		Results [dB(μV)]		Margin [dB]		Remarks
		QP	AVE	QP	AVE	QP	AVE	QP	AVE	
0.200	10.1	22.1	--	63.6	53.6	32.2	--	+31.4	--	-
0.310	10.2	21.3	--	60.0	50.0	31.5	--	+28.5	--	-
0.720	10.2	17.7	--	56.0	46.0	27.9	--	+28.1	--	-
1.480	10.3	23.8	--	56.0	46.0	34.1	--	+21.9	--	-
2.780	10.3	25.8	--	56.0	46.0	36.1	--	+19.9	--	-
5.660	10.4	20.9	--	60.0	50.0	31.3	--	+28.7	--	-
18.260	11.1	21.9	--	60.0	50.0	33.0	--	+27.0	--	-
28.000	11.2	26.4	--	60.0	50.0	37.6	--	+22.4	--	-
30.000	11.2	24.6	--	60.0	50.0	35.8	--	+24.2	--	-

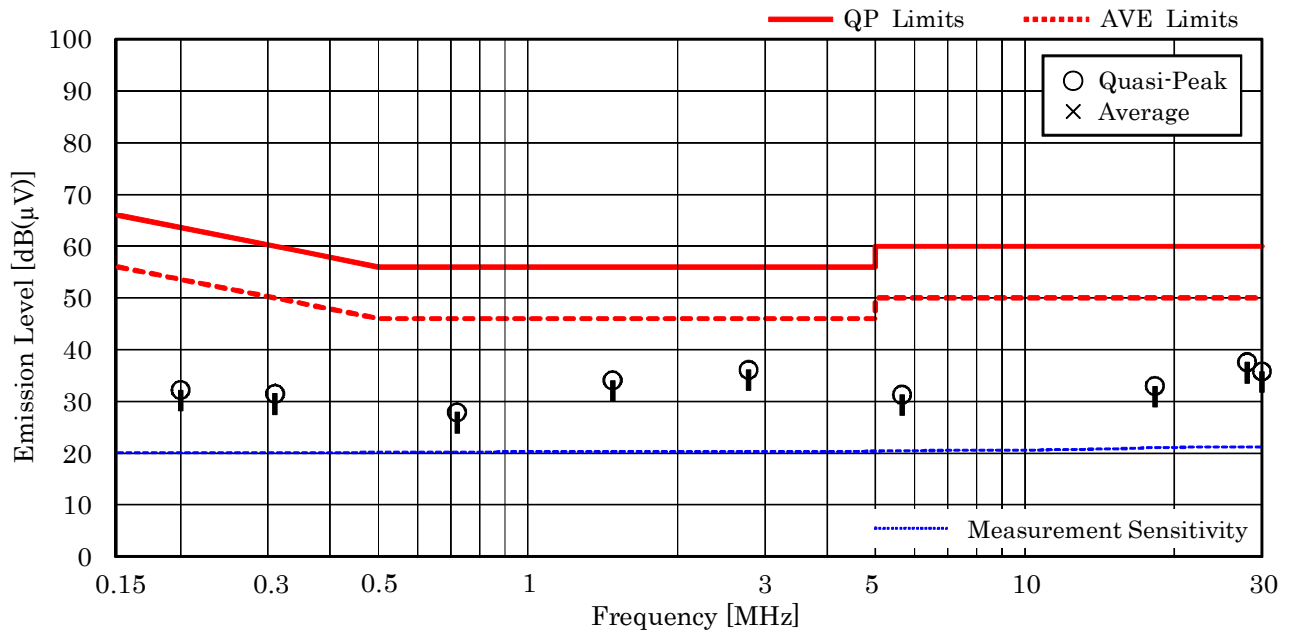

NOTES

- The spectrum was checked from 0.15 MHz to 30 MHz.
- The correction factor includes the AMN insertion loss and the cable loss.
- The symbol of "<" means "or less".
- The symbol of ">" means "more than".
- The symbol of "--" means "not applicable".
- Calculated result at 2.780 MHz, as the worst point shown on underline:
 Correction Factor + Meter Reading (QP) = 10.3 + 25.8 = 36.1 dB(μV)
- QP : Quasi-Peak Detector / AVE : Average Detector
- Test receiver setting(s) : CISPR QP 9 kHz / Average 9 kHz

Test voltage : 120VAC 60Hz

Test Date: September 16, 2015
Temp.: 23 °C, Humi.: 65 %

Measured phase : L2

Frequency [MHz]	Corr. Factor [dB]	Meter Readings [dB(μV)]		Limits [dB(μV)]		Results [dB(μV)]		Margin [dB]		Remarks
		QP	AVE	QP	AVE	QP	AVE	QP	AVE	
0.200	10.1	21.5	--	63.6	53.6	31.6	--	+32.0	--	-
0.310	10.2	21.7	--	60.0	50.0	31.9	--	+28.1	--	-
0.720	10.2	24.4	--	56.0	46.0	34.6	--	+21.4	--	-
<u>1.480</u>	<u>10.3</u>	<u>32.9</u>	<u>19.5</u>	<u>56.0</u>	<u>46.0</u>	<u>43.2</u>	<u>29.8</u>	<u>+12.8</u>	<u>+16.2</u>	-
2.780	10.3	13.8	--	56.0	46.0	24.1	--	+31.9	--	-
5.660	10.4	11.2	--	60.0	50.0	21.6	--	+38.4	--	-
18.260	11.2	11.4	--	60.0	50.0	22.6	--	+37.4	--	-
28.000	11.6	19.1	--	60.0	50.0	30.7	--	+29.3	--	-
30.000	11.5	18.3	--	60.0	50.0	29.8	--	+30.2	--	-

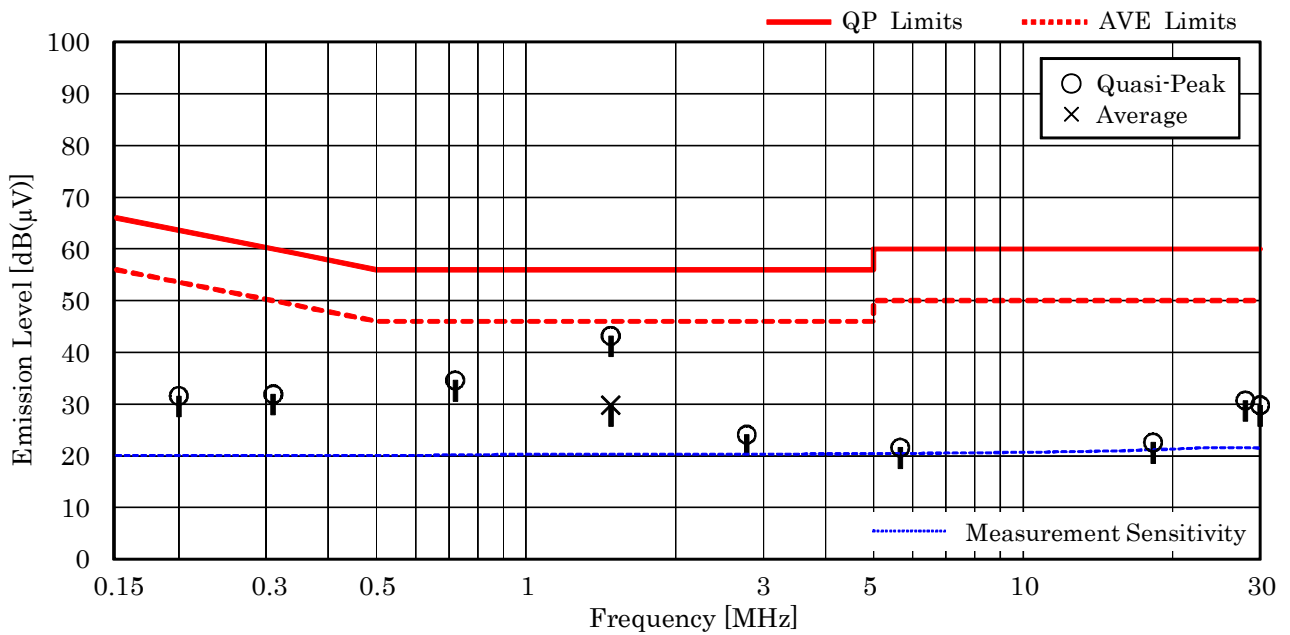

NOTES

1. The spectrum was checked from 0.15 MHz to 30 MHz.
2. The correction factor includes the AMN insertion loss and the cable loss.
3. The symbol of “<” means “or less”.
4. The symbol of “>” means “more than”.
5. The symbol of “-” means “not applicable”.
6. Calculated result at 1.480 MHz, as the worst point shown on underline:
 Correction Factor + Meter Reading (QP) = 10.3 + 32.9 = 43.2 dB(μV)
7. QP : Quasi-Peak Detector / AVE : Average Detector
8. Test receiver setting(s) : CISPR QP 9 kHz / Average 9 kHz

2) Mode of EUT : Bluetooth Low Energy

Test voltage : 120VAC 60Hz

Test Date: September 16, 2015
Temp.: 23 °C, Humi.: 65 %

Measured phase : L1

Frequency [MHz]	Corr. Factor [dB]	Meter Readings [dB(μV)]		Limits [dB(μV)]		Results [dB(μV)]		Margin [dB]		Remarks
		QP	AVE	QP	AVE	QP	AVE	QP	AVE	
0.210	10.2	21.7	--	63.2	53.2	31.9	--	+31.3	--	-
0.320	10.2	21.1	--	59.7	49.7	31.3	--	+28.4	--	-
0.730	10.2	17.9	--	56.0	46.0	28.1	--	+27.9	--	-
1.480	10.3	24.8	--	56.0	46.0	35.1	--	+20.9	--	-
2.580	10.3	27.3	--	56.0	46.0	37.6	--	+18.4	--	-
5.610	10.4	21.5	--	60.0	50.0	31.9	--	+28.1	--	-
18.010	11.1	21.6	--	60.0	50.0	32.7	--	+27.3	--	-
28.080	11.2	25.6	--	60.0	50.0	36.8	--	+23.2	--	-
30.000	11.2	24.0	--	60.0	50.0	35.2	--	+24.8	--	-

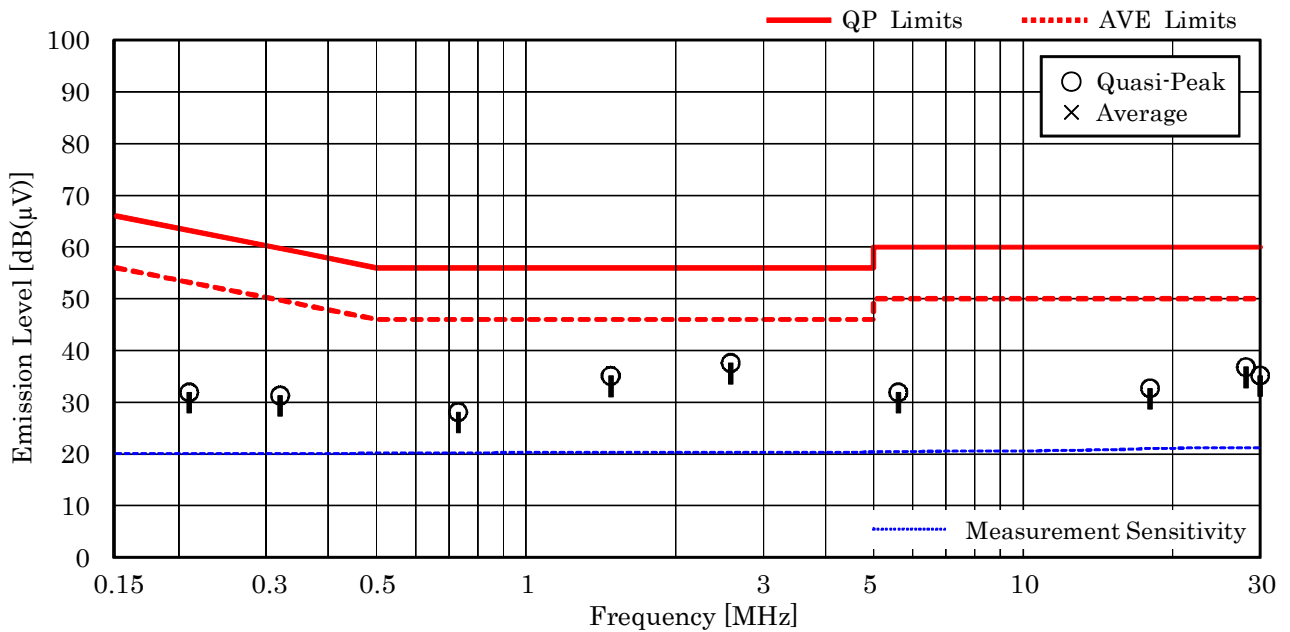

NOTES

1. The spectrum was checked from 0.15 MHz to 30 MHz.
2. The correction factor includes the AMN insertion loss and the cable loss.
3. The symbol of "<" means "or less".
4. The symbol of ">" means "more than".
5. The symbol of "--" means "not applicable".
6. Calculated result at 2.580 MHz, as the worst point shown on underline:
 Correction Factor + Meter Reading (QP) = 10.3 + 27.3 = 37.6 dB(μV)
7. QP : Quasi-Peak Detector / AVE : Average Detector
8. Test receiver setting(s) : CISPR QP 9 kHz / Average 9 kHz

Test voltage : 120VAC 60Hz

Test Date: September 16, 2015
Temp.: 23 °C, Humi.: 65 %

Measured phase : L2

Frequency [MHz]	Corr. Factor [dB]	Meter Readings [dB(μV)]		Limits [dB(μV)]		Results [dB(μV)]		Margin [dB]		Remarks
		QP	AVE	QP	AVE	QP	AVE	QP	AVE	
0.210	10.1	21.7	--	63.2	53.2	31.8	--	+31.4	--	-
0.320	10.2	21.7	--	59.7	49.7	31.9	--	+27.8	--	-
0.730	10.2	24.3	--	56.0	46.0	34.5	--	+21.5	--	-
<u>1.480</u>	<u>10.3</u>	<u>33.7</u>	<u>20.4</u>	<u>56.0</u>	<u>46.0</u>	<u>44.0</u>	<u>30.7</u>	<u>+12.0</u>	<u>+15.3</u>	-
2.580	10.3	16.9	--	56.0	46.0	27.2	--	+28.8	--	-
5.610	10.4	11.7	--	60.0	50.0	22.1	--	+37.9	--	-
18.010	11.2	< 10.0	--	60.0	50.0	< 21.2	--	> +38.8	--	-
28.080	11.6	16.3	--	60.0	50.0	27.9	--	+32.1	--	-
30.000	11.5	16.4	--	60.0	50.0	27.9	--	+32.1	--	-

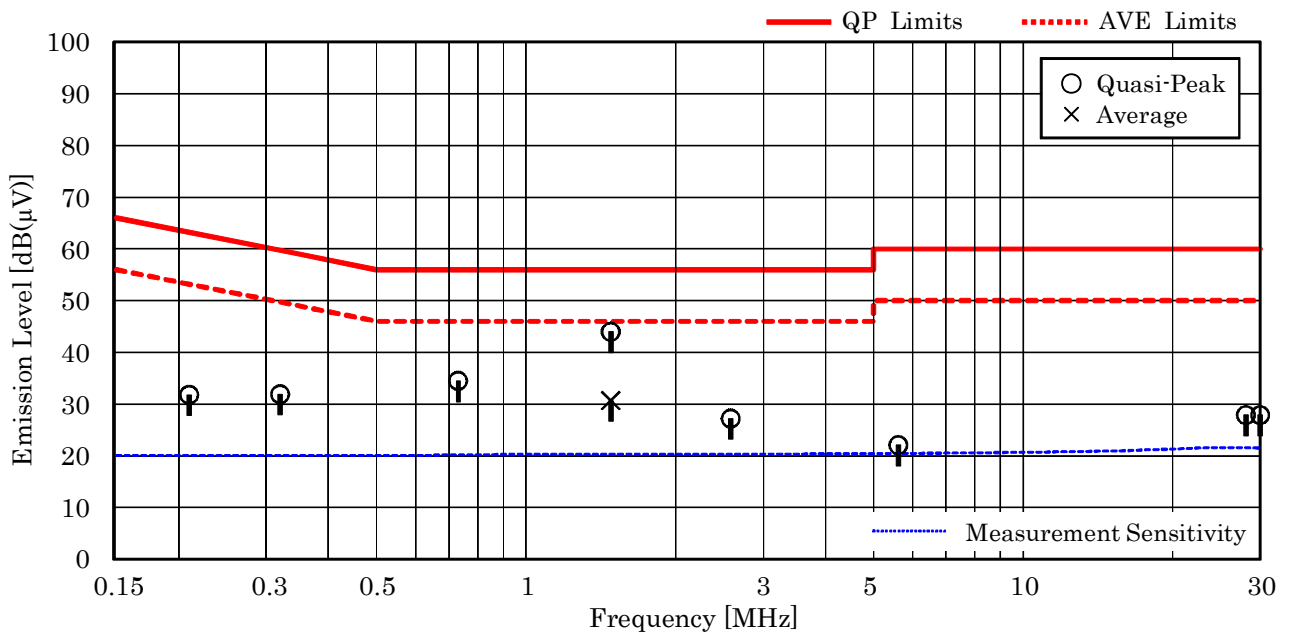

NOTES

1. The spectrum was checked from 0.15 MHz to 30 MHz.
2. The correction factor includes the AMN insertion loss and the cable loss.
3. The symbol of "<" means "or less".
4. The symbol of ">" means "more than".
5. The symbol of "--" means "not applicable".
6. Calculated result at 1.480 MHz, as the worst point shown on underline:
 Correction Factor + Meter Reading (QP) = 10.3 + 33.7 = 44.0 dB(μV)
7. QP : Quasi-Peak Detector / AVE : Average Detector
8. Test receiver setting(s) : CISPR QP 9 kHz / Average 9 kHz

7.9 Radiated Emission

For the requirements, - Applicable [- Tested. - Not tested by applicant request.]
 - Not Applicable

7.9.1 Test Results

For the standard, - Passed - Failed - Not judged

Min. Limit Margin (Peak) 3.4 dB at 2390.0 MHz

Uncertainty of Measurement Results

9 kHz – 30 MHz	<u>± 3.0</u>	dB(2 σ)
30 MHz – 300 MHz	<u>± 3.8</u>	dB(2 σ)
300 MHz – 1000 MHz	<u>± 4.8</u>	dB(2 σ)
1 GHz – 6 GHz	<u>± 4.7</u>	dB(2 σ)
6 GHz – 18 GHz	<u>± 4.6</u>	dB(2 σ)
18 GHz – 40 GHz	<u>± 5.5</u>	dB(2 σ)

Remarks : IEEE802.11g mode, Z axis position. The measurement result is within the range of measurement uncertainty.

7.9.2 Test Instruments

Anechoic Chamber A2				
Type	Model	Serial No. (ID)	Manufacturer	Cal. Due
Test Receiver	ESU 26	100170 (A-6)	Rohde & Schwarz	2016/04/25
Loop Antenna	HFH2-Z2	872096/25 (C-2)	Rohde & Schwarz	2016/07/26
RF Cable	RG213/U	--- (H-28)	HUBER+SUHNER	2016/07/26
Pre-Amplifier	310N	304573 (A-17)	SONOMA	2016/04/15
Biconical Antenna	VHA9103/BBA9106	2355 (C-30)	Schwarzbeck	2016/05/24
Log-periodic Antenna	UHALP9108-A1	0694 (C-31)	Schwarzbeck	2016/05/24
RF Cable	S 10162 B-11 etc.	--- (H-4)	HUBER+SUHNER	2016/04/15
Site Attenuation	--	--- (H-15)	----	2016/01/05
Pre-Amplifier	TPA0118-36	1010 (A-37)	TOYO	2016/05/11
Horn Antenna	91888-2	562 (C-41-1)	EATON	2016/06/16
Horn Antenna	91889-2	568 (C-41-2)	EATON	2016/06/16
Horn Antenna	3160-04	9903-1053 (C-55)	EMCO	2016/06/29
Horn Antenna	3160-05	9902-1061 (C-56)	EMCO	2016/06/29
Horn Antenna	3160-06	9712-1045 (C-57)	EMCO	2016/06/29
Horn Antenna	3160-07	9902-1113 (C-58)	EMCO	2016/06/29
Horn Antenna	3160-08	9904-1099 (C-59)	EMCO	2016/06/29
Horn Antenna	3160-09	9808-1117 (C-48)	EMCO	2016/06/28
Attenuator	54A-10	W5713 (D-29)	Weinschel	2016/08/16
Attenuator	2-10	BA6214 (D-79)	Weinschel	2015/11/18
RF Cable	SUCOFLEX104	267479/4 (C-66)	HUBER+SUHNER	2016/01/19
RF Cable	SUCOFLEX104	267414/4 (C-67)	HUBER+SUHNER	2016/01/19
RF Cable	SUCOFLEX102EA	3041/2EA (C-69)	HUBER+SUHNER	2016/01/19
Band Rejection Filter	BRM50701	029 (D-93)	MICRO-TRONICS	2016/02/08
SVSWR	--	--- (H-19)	----	2016/02/27

NOTE : The calibration interval of the above test instruments is 12 months.

7.9.3 Test Method and Test Setup (Diagrammatic illustration)

7.9.3.1 Radiated Emission 9 kHz – 30 MHz

The preliminary tests were performed at the measurement distance that specified for compliance to determine the emission characteristics of the EUT.

The EUT configuration(in X, Y and Z axis), cable configuration and mode of operation were determined for producing the maximum level of emissions.

This configurations was used for the final tests.

– Side View –

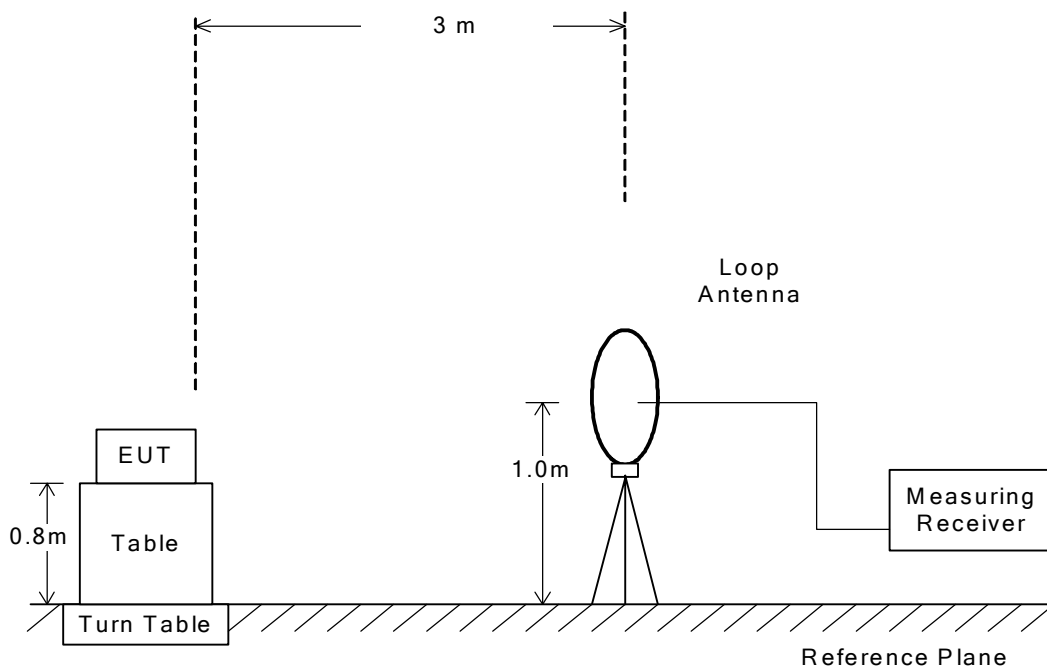

7.9.3.2 Radiated Emission 30 MHz – 1000 MHz

The preliminary tests were performed at the measurement distance that specified for compliance to determine the emission characteristics of the EUT.

The EUT configuration(in X, Y and Z axis), cable configuration and mode of operation were determined for producing the maximum level of emissions.

This configurations was used for the final tests.

– Side View –

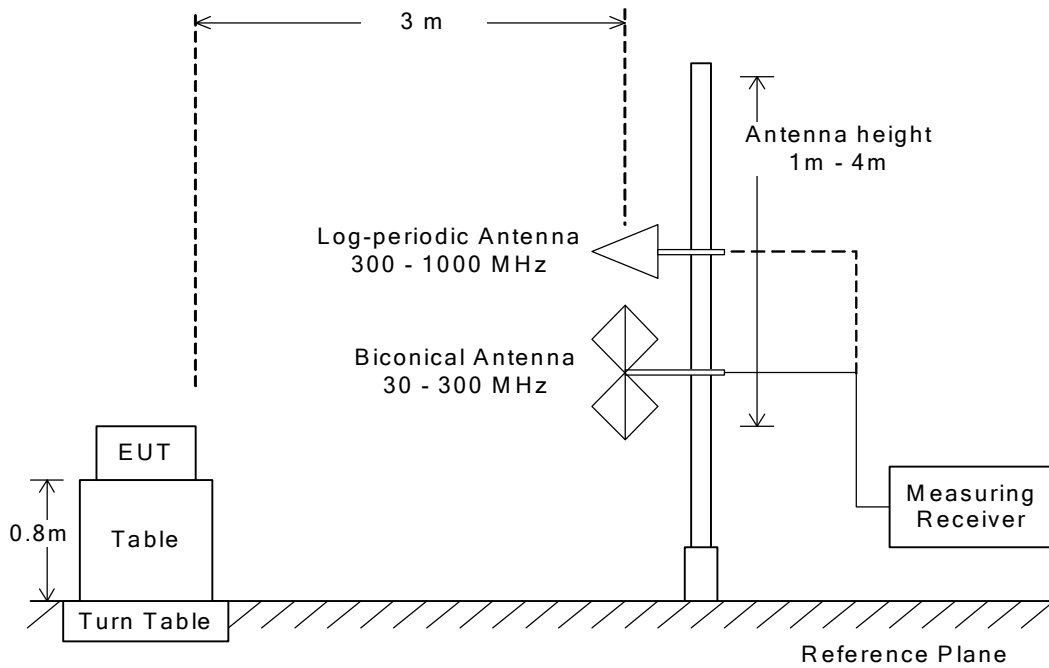

7.9.3.3 Radiated Emission above 1 GHz

The preliminary tests were performed at the measurement distance that specified for compliance to determine the emission characteristics of the EUT.

The EUT configuration(in X, Y and Z axis), cable configuration and mode of operation were determined for producing the maximum level of emissions.

This configurations was used for the final tests.

The setting of the measuring instruments are shown as follows:

Type	Peak	Average
Detector Function	Peak	Peak
Res. Bandwidth	1 MHz	1 MHz
Video Bandwidth	3 MHz	$\geq 1/T *1)$
Video Filtering	Linear Voltage	Linear Voltage
Sweep Time	AUTO	AUTO
Trace	Max Hold	Max Hold

Note: 1. T: Minimum transmission duration

Average (VBW) Setting:

Mode	Interval	Cycle	Duty cycle	Burst on period(T)	Min. VBW(1/T)	VBW Setting
	(msec)	(msec)	(%)	(msec)	(kHz)	(kHz)
IEEE802.11b(11Mbps)	0.10	1.39	92.8%	1.29	0.78	1.00
IEEE802.11g(24Mbps)	0.11	0.63	82.5%	0.52	1.92	2.00
IEEE802.11n(39Mbps(MCS4))	0.11	0.45	75.6%	0.34	2.94	3.00
Bluetooth LE	0.22	0.62	64.5%	0.40	2.50	3.00

– Side View –

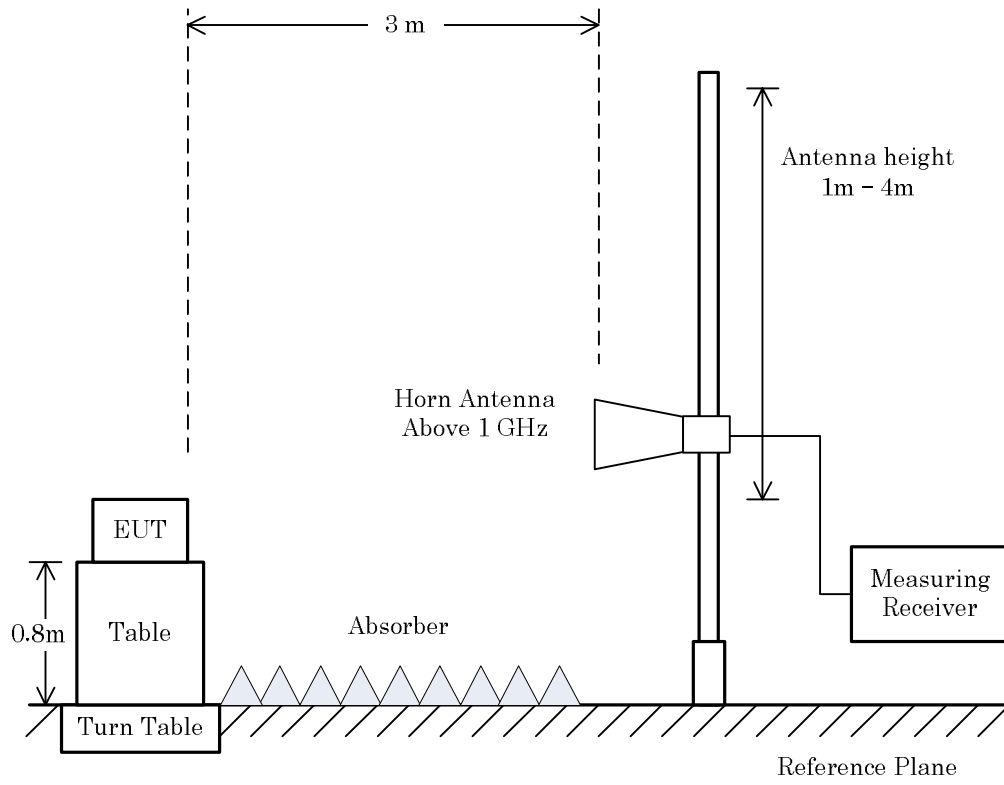
**NOTE**

The antenna height is scanned depending on the EUT's size and mounting height.

7.9.4 Test Data

7.9.4.1 Band-edge Compliance

Test Date : September 10, 2015
Temp.:24°C, Humi:70%

Mode of EUT : 1TX: Main (1ch: 2412 MHz, (IEEE 802.11b))
 Antenna Polarization : Horizontal

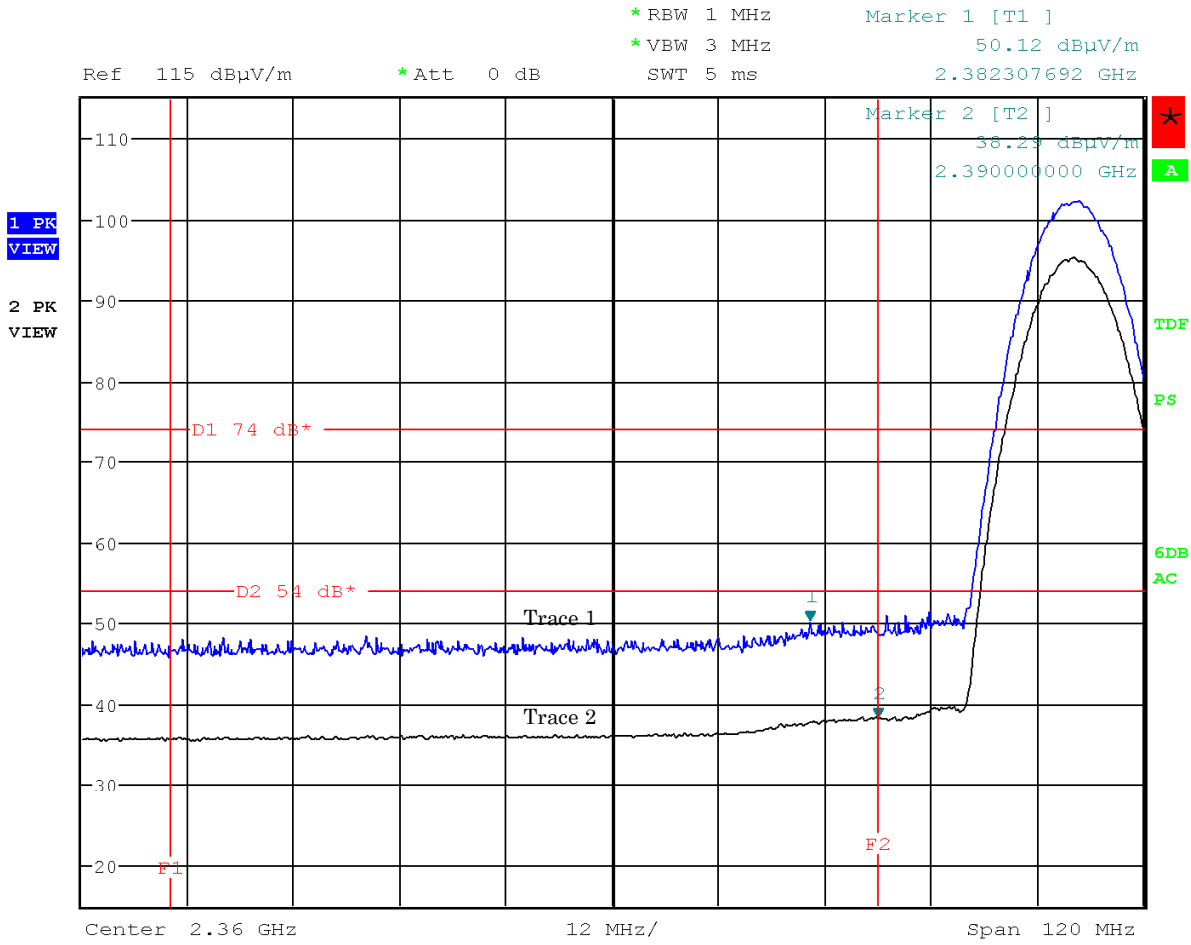

Note: The trace 1 is Peak . The trace 2 is Average.

Mode of EUT : 1TX: Main (1ch: 2412 MHz, (IEEE 802.11b))

Antenna Polarization : Vertical

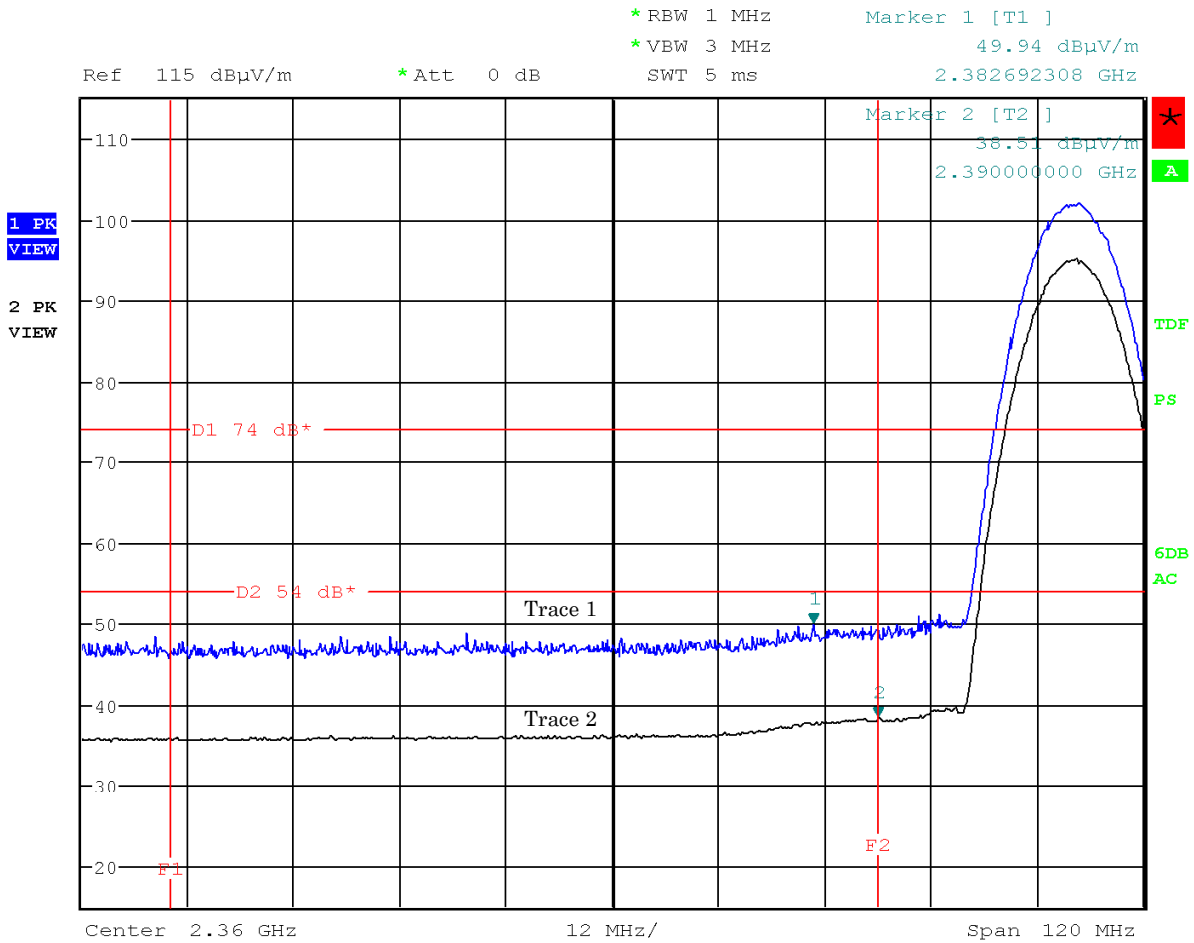

Note: The trace 1 is Peak . The trace 2 is Average.

Mode of EUT : 1TX: Main (11ch: 2462 MHz, (IEEE 802.11b))
 Antenna Polarization : Horizontal

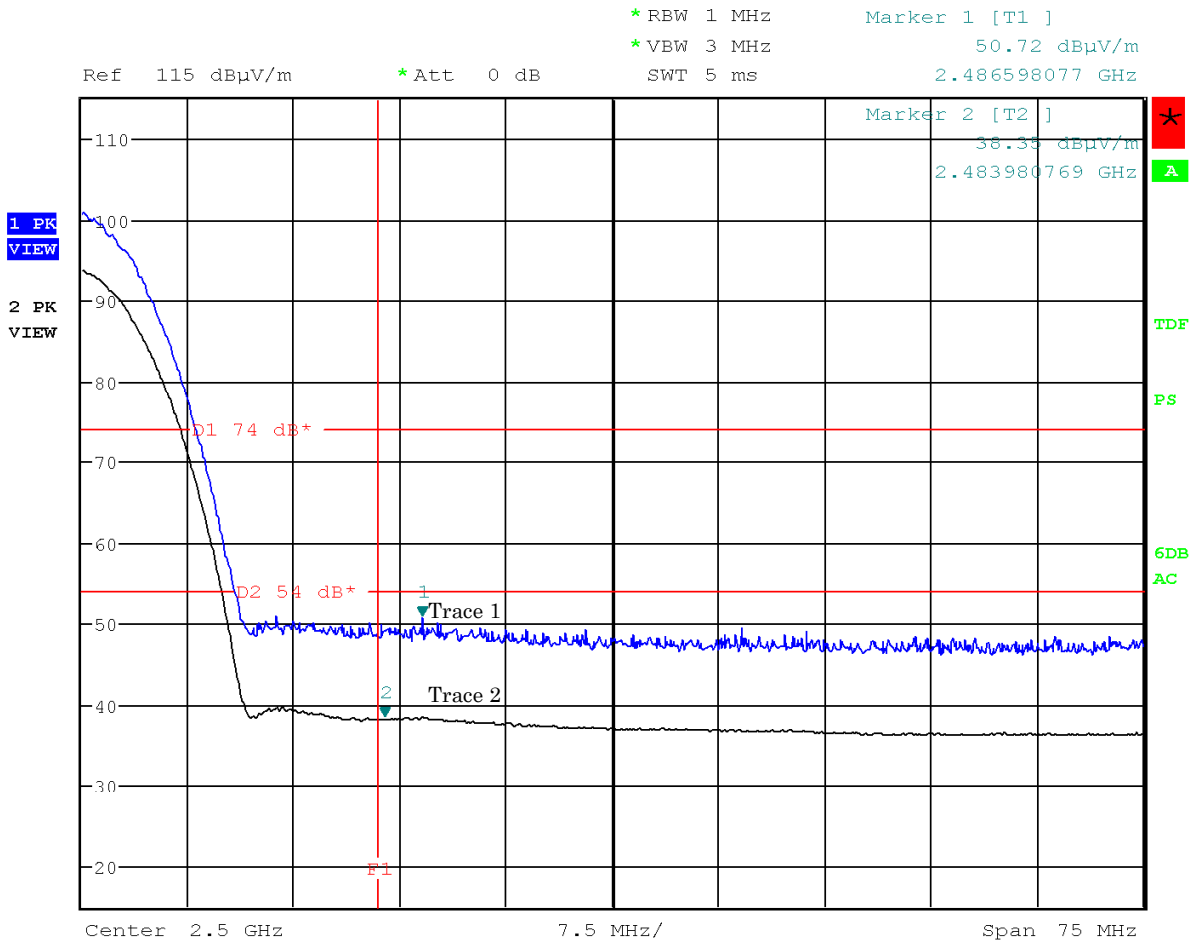

Note: The trace 1 is Peak . The trace 2 is Average.

Mode of EUT : 1TX: Main (11ch: 2462 MHz, (IEEE 802.11b))

Antenna Polarization : Vertical

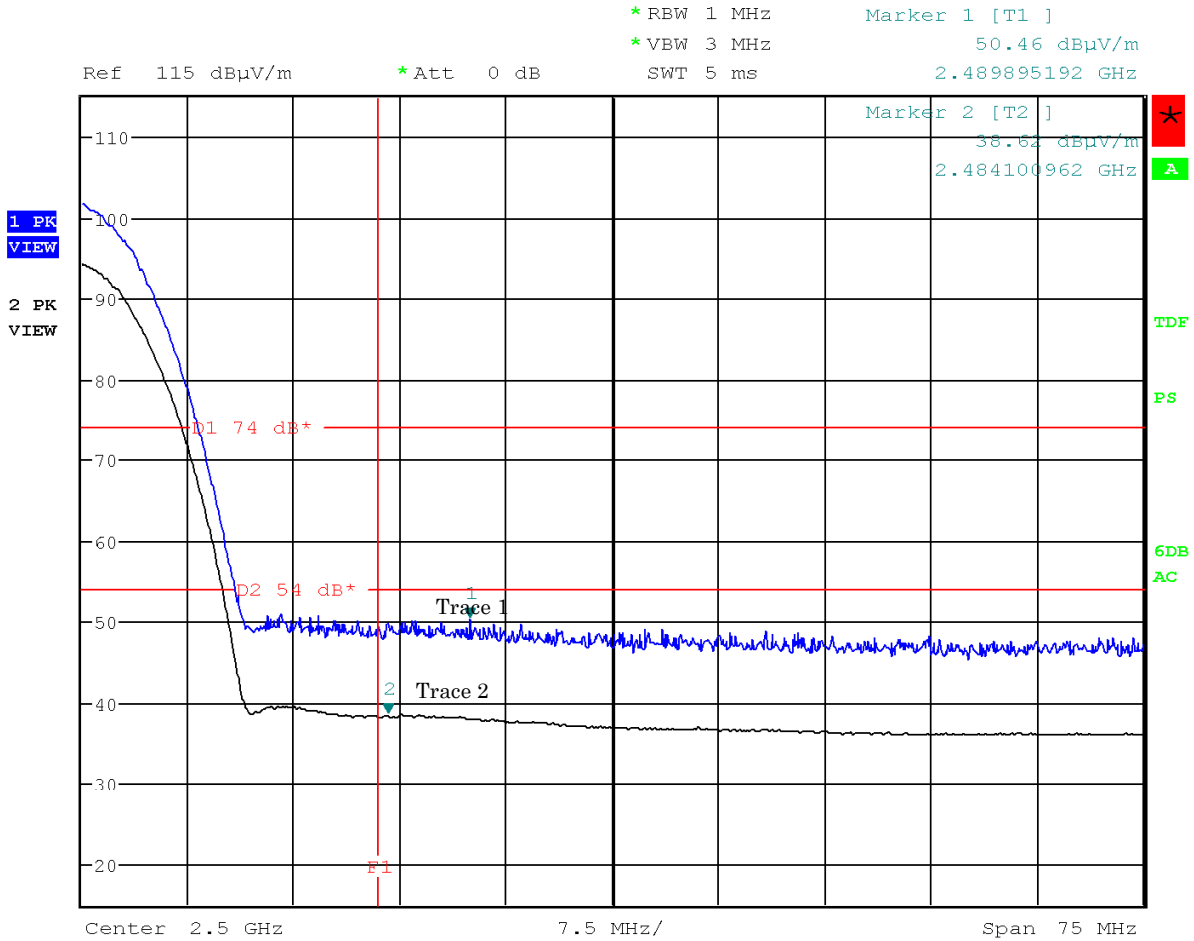

Note: The trace 1 is Peak . The trace 2 is Average.

Mode of EUT : 2TX: Main+Sub (1ch: 2412 MHz, (IEEE 802.11b))

Antenna Polarization : Horizontal

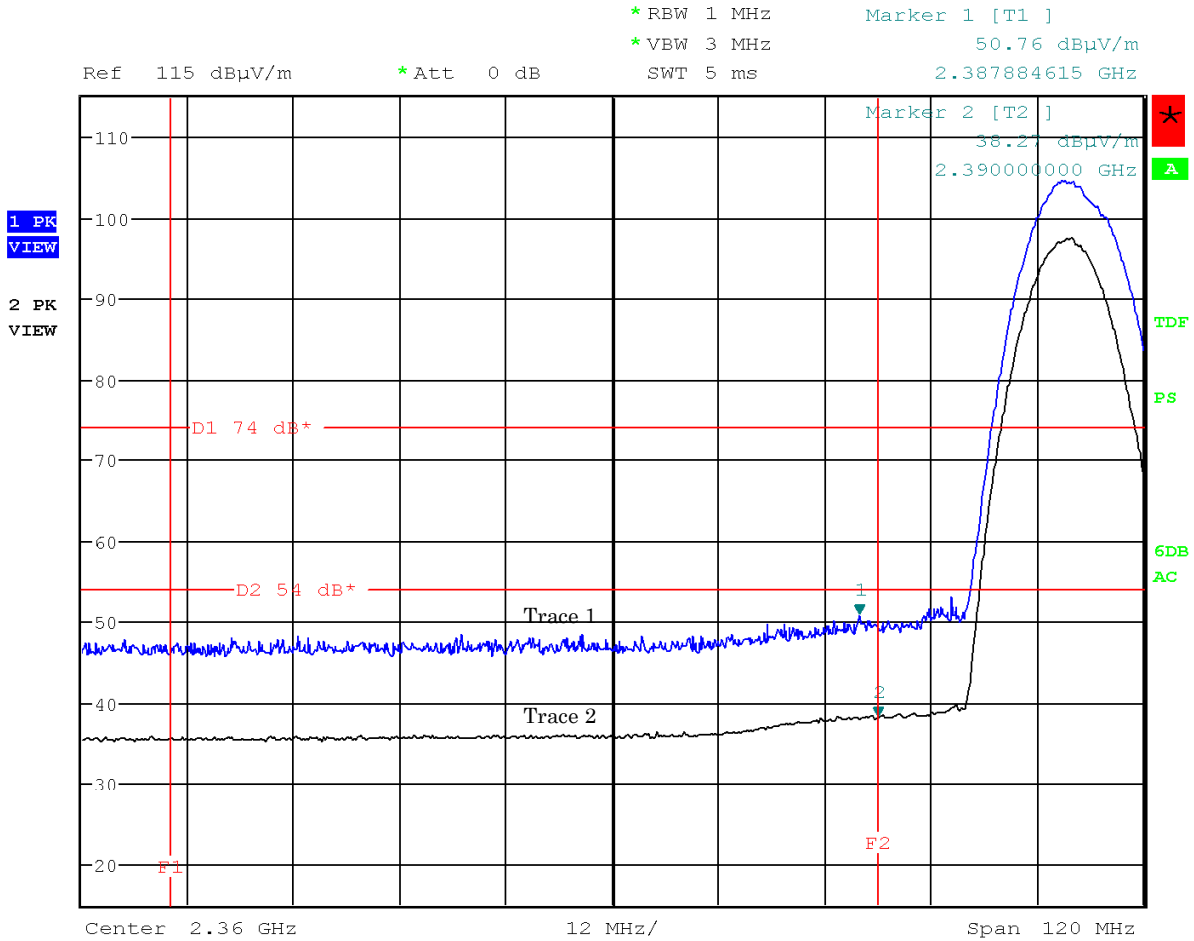

Note: The trace 1 is Peak . The trace 2 is Average.

Mode of EUT : 2TX: Main+Sub (1ch: 2412 MHz, (IEEE 802.11b))

Antenna Polarization : Vertical

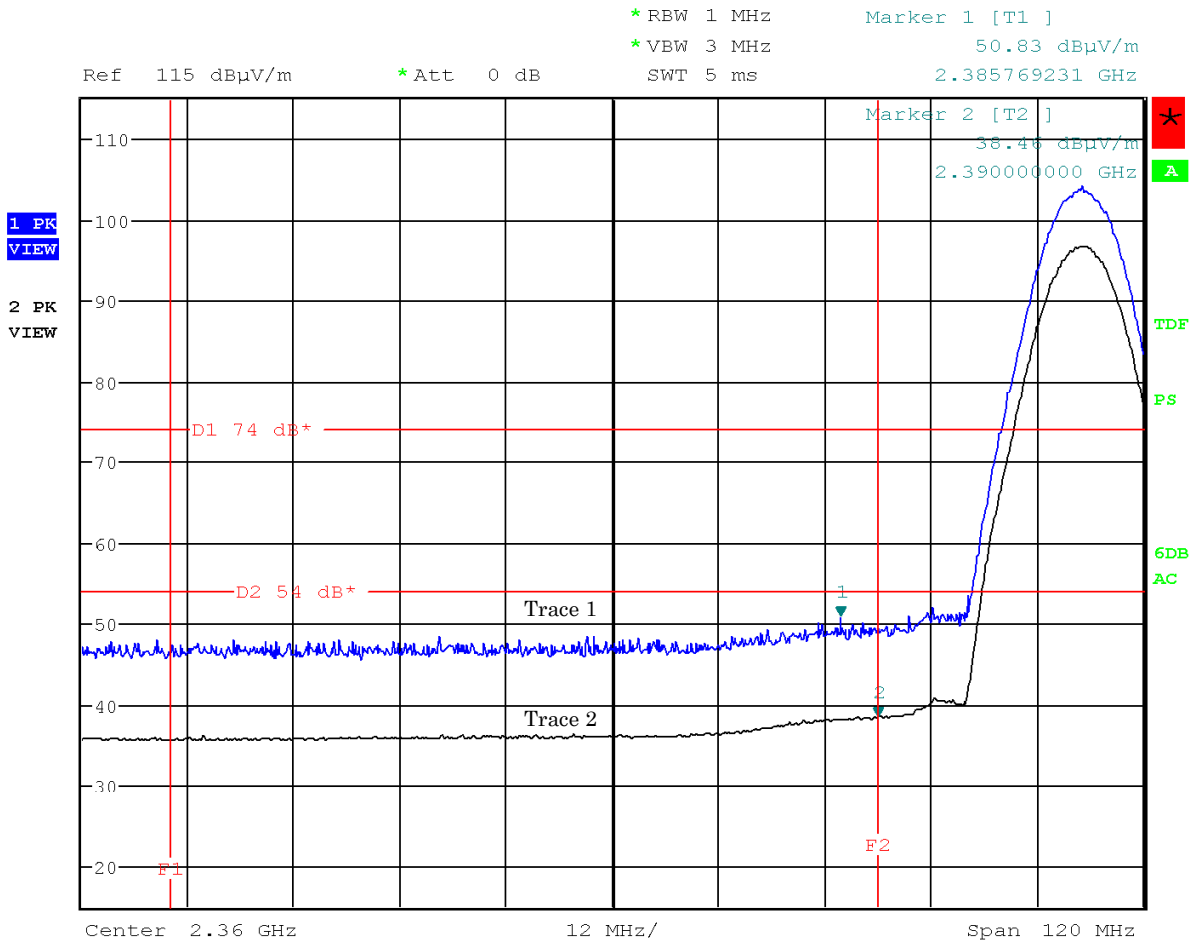

Note: The trace 1 is Peak . The trace 2 is Average.

Mode of EUT : 2TX: Main+Sub (11ch: 2462 MHz, (IEEE 802.11b))

Antenna Polarization : Horizontal

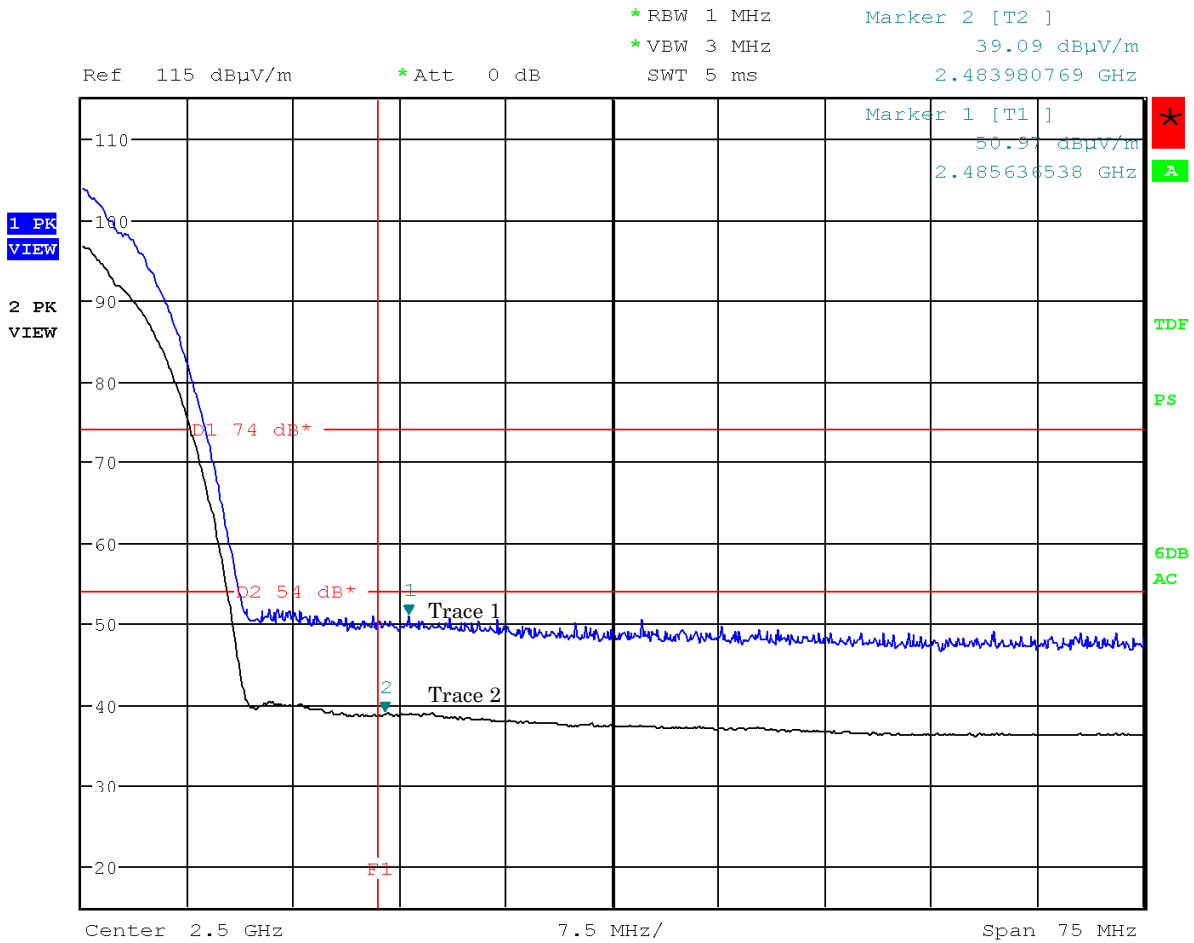

Note: The trace 1 is Peak . The trace 2 is Average.

Mode of EUT : 2TX: Main+Sub (11ch: 2462 MHz, (IEEE 802.11b))

Antenna Polarization : Vertical

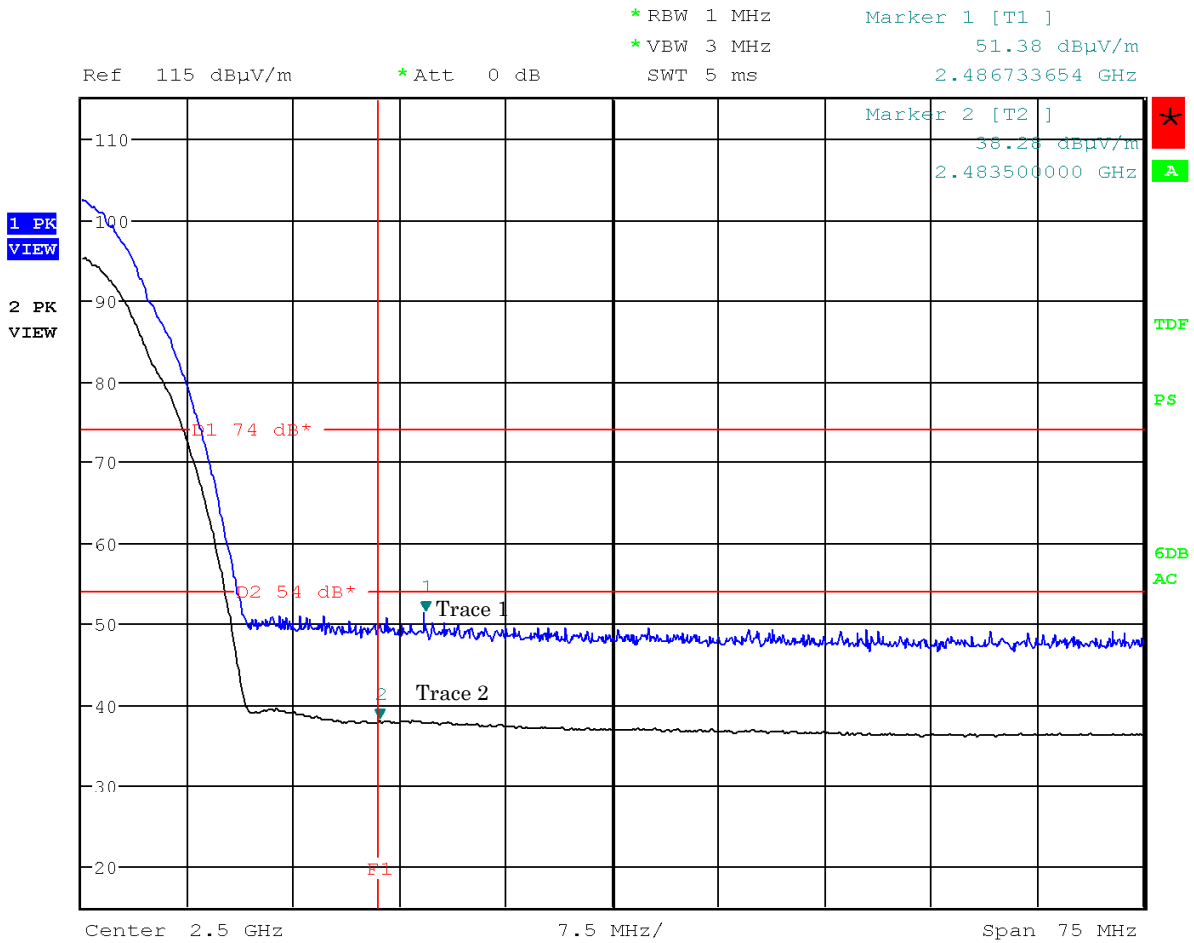

Note: The trace 1 is Peak . The trace 2 is Average.

Mode of EUT : 1TX: Main (1ch: 2412 MHz, (IEEE 802.11g))

Antenna Polarization : Horizontal

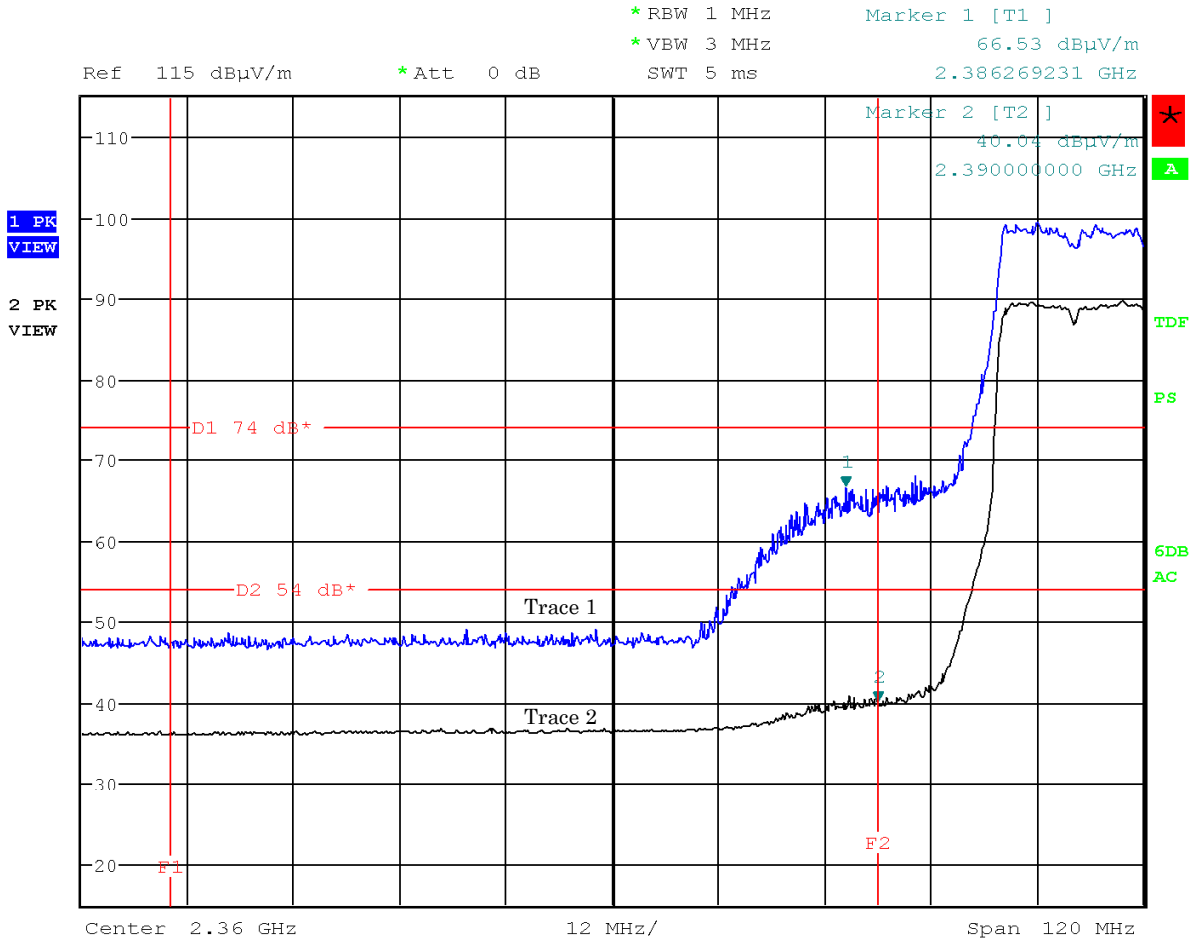

Note: The trace 1 is Peak . The trace 2 is Average.

Mode of EUT : 1TX: Main (1ch: 2412 MHz, (IEEE 802.11g))

Antenna Polarization : Vertical

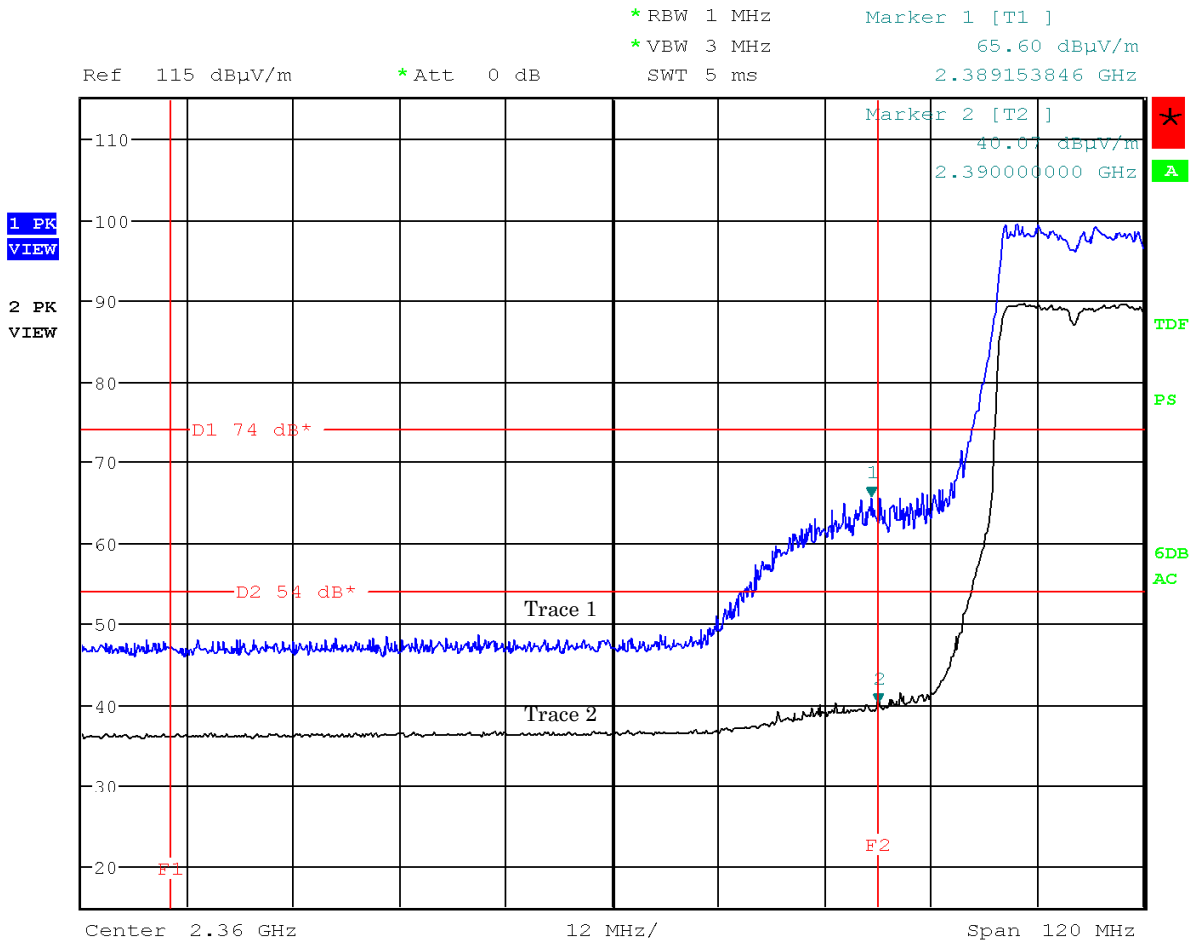

Note: The trace 1 is Peak . The trace 2 is Average.

Mode of EUT : 1TX: Main (11ch: 2462 MHz, (IEEE 802.11g))

Antenna Polarization : Horizontal

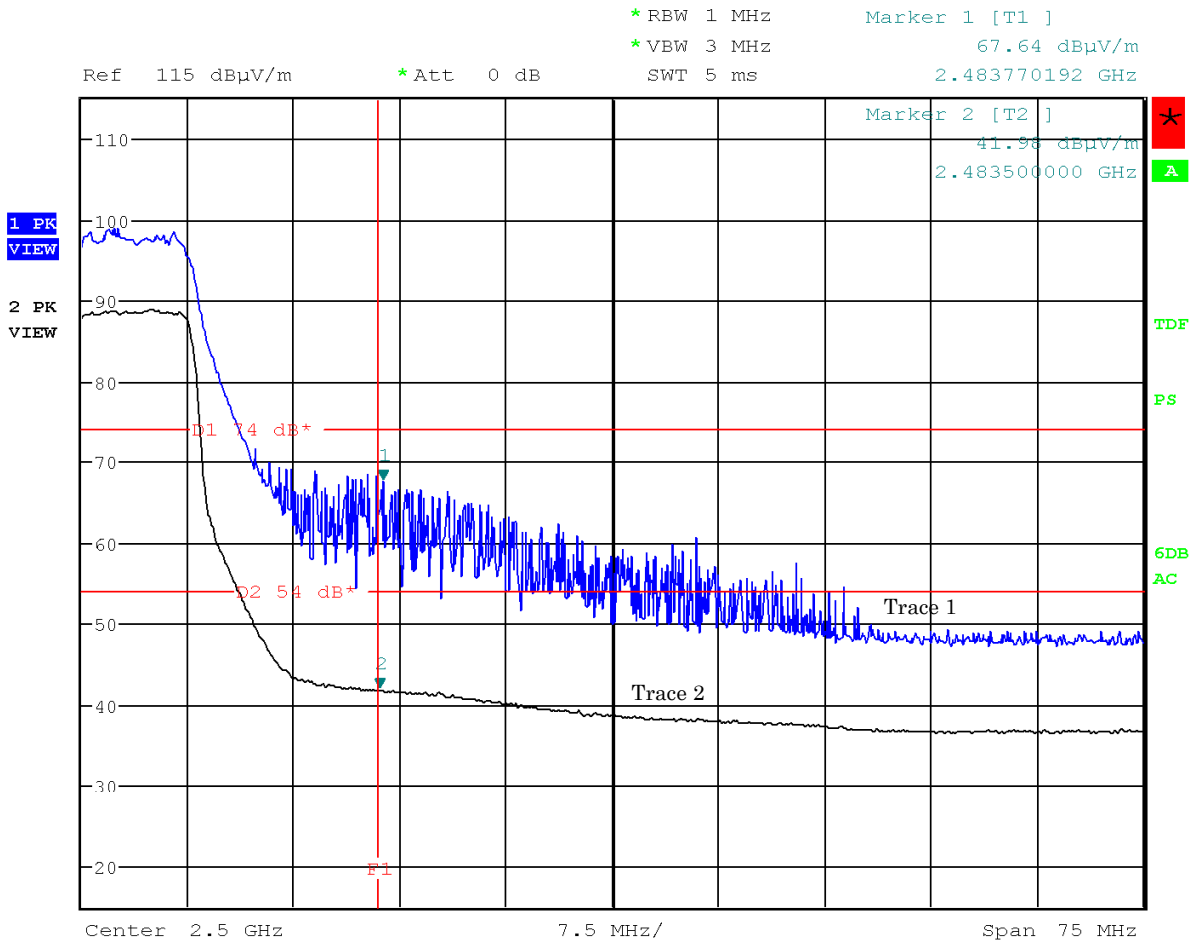

Note: The trace 1 is Peak . The trace 2 is Average.

Mode of EUT : 1TX: Main (11ch: 2462 MHz, (IEEE 802.11g))
 Antenna Polarization : Vertical

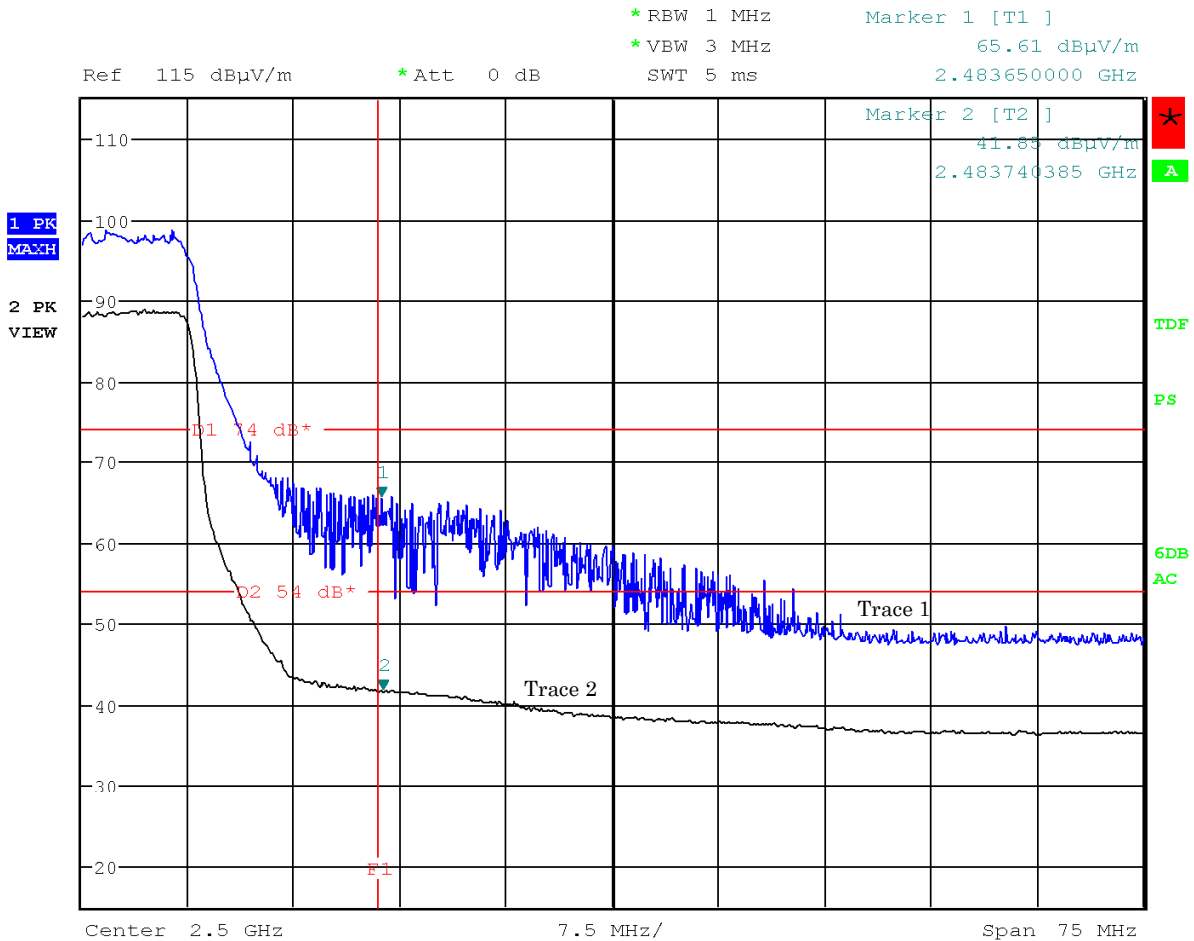

Note: The trace 1 is Peak . The trace 2 is Average.

Mode of EUT : 2TX: Main+Sub (1ch: 2412 MHz, (IEEE 802.11g))
 Antenna Polarization : Horizontal

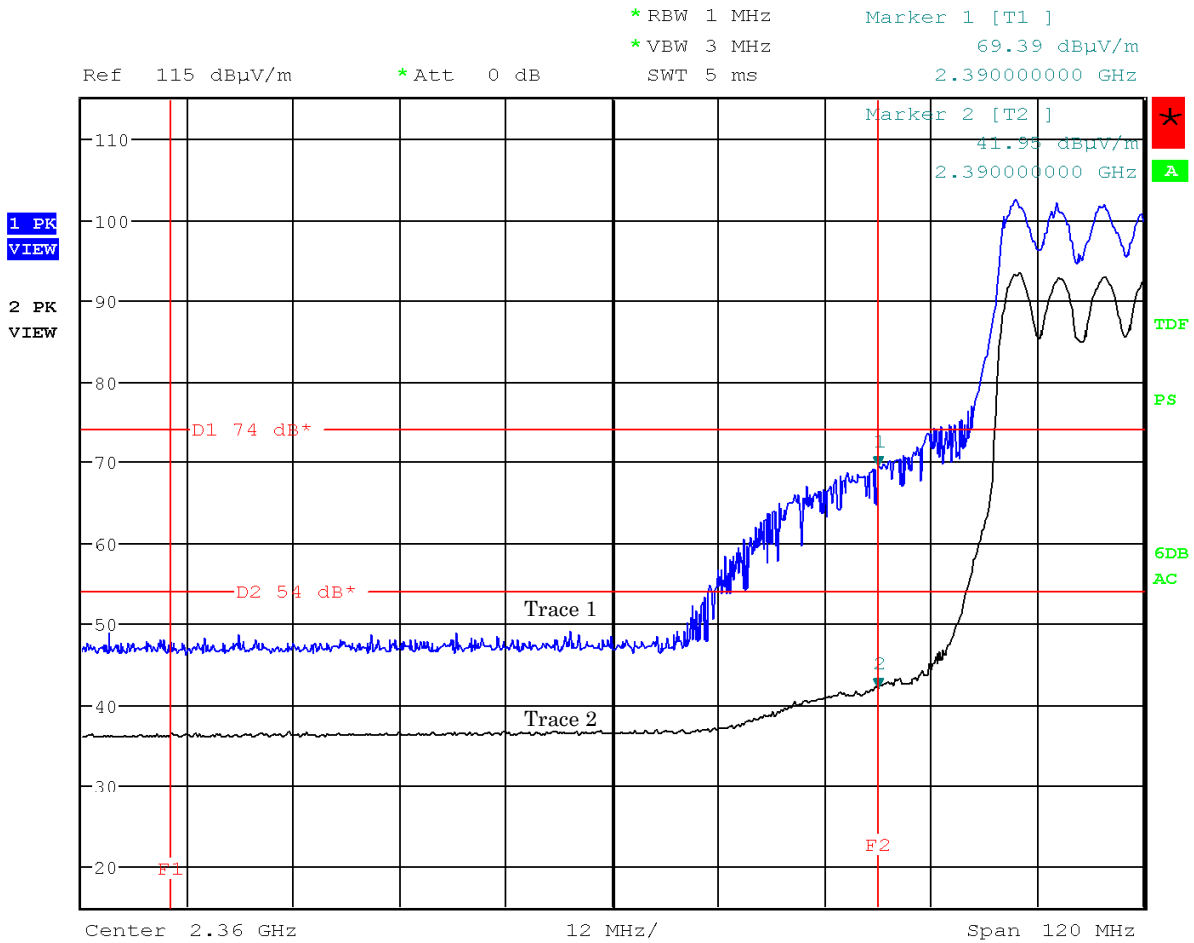

Note: The trace 1 is Peak . The trace 2 is Average.

Mode of EUT : 2TX: Main+Sub (1ch: 2412 MHz, (IEEE 802.11g))

Antenna Polarization : Vertical

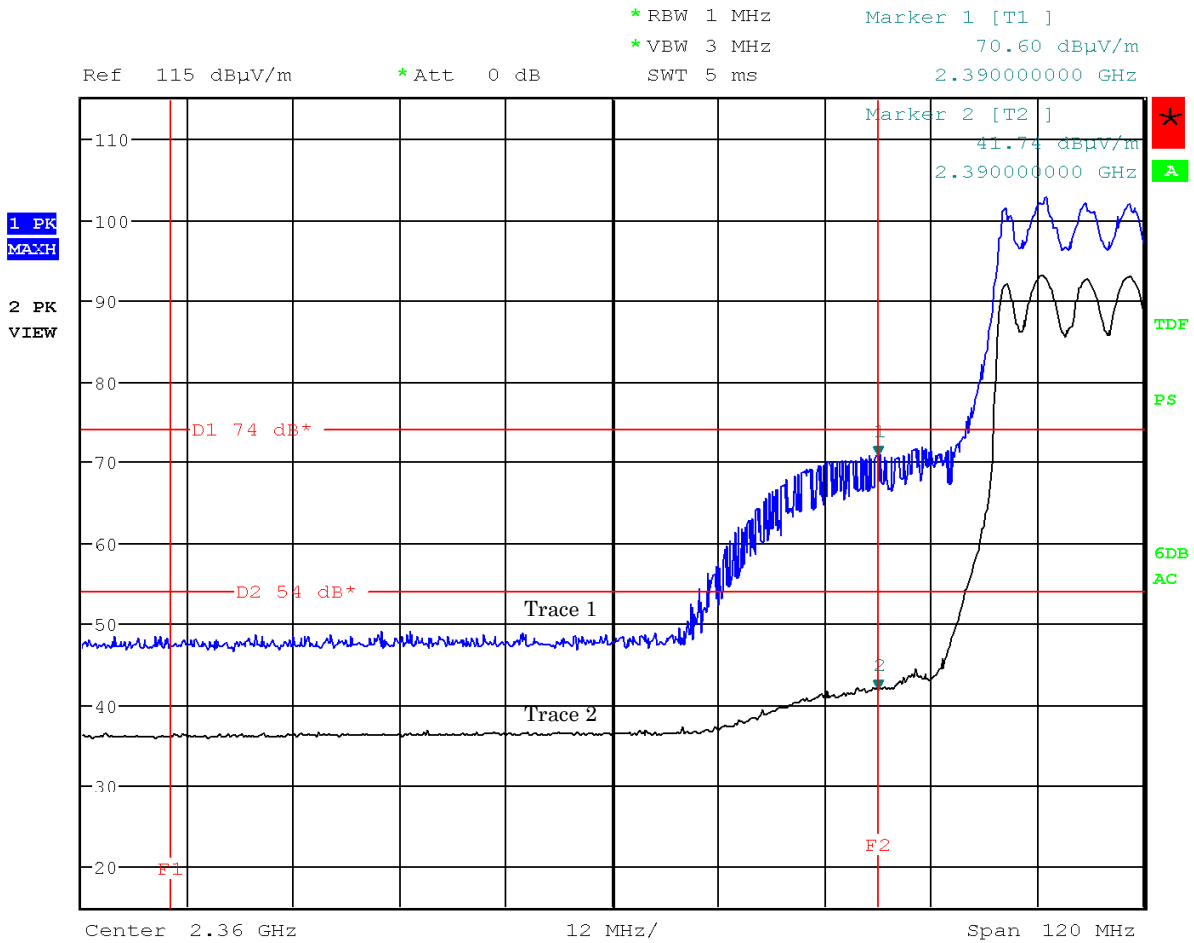

Note: The trace 1 is Peak . The trace 2 is Average.

Mode of EUT : 2TX: Main+Sub (11ch: 2462 MHz, (IEEE 802.11g))

Antenna Polarization : Horizontal

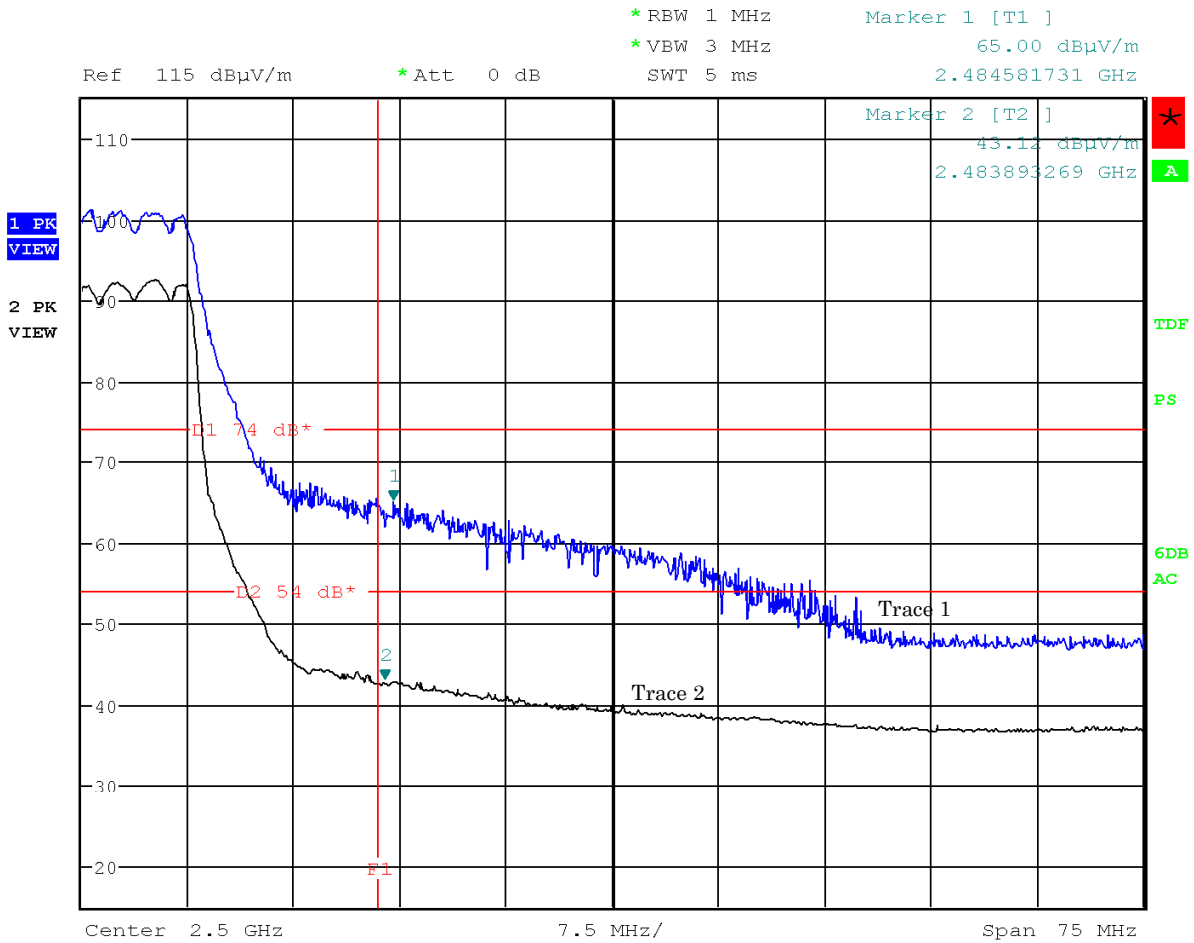

Note: The trace 1 is Peak . The trace 2 is Average.

Mode of EUT : 2TX: Main+Sub (11ch: 2462 MHz, (IEEE 802.11g))

Antenna Polarization : Vertical

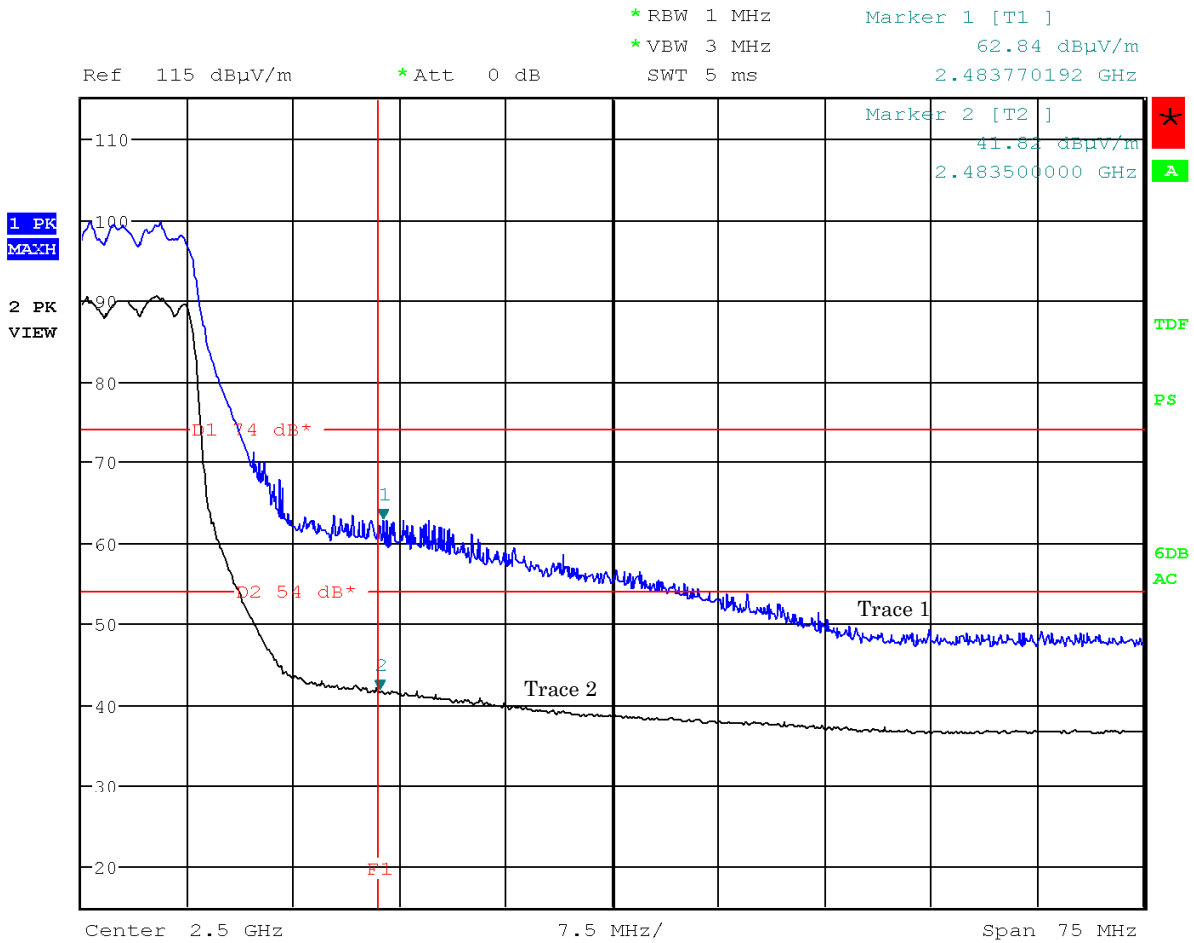

Note: The trace 1 is Peak . The trace 2 is Average.

Mode of EUT : 1TX: Main (1ch: 2412 MHz, (IEEE 802.11n))

Antenna Polarization : Horizontal

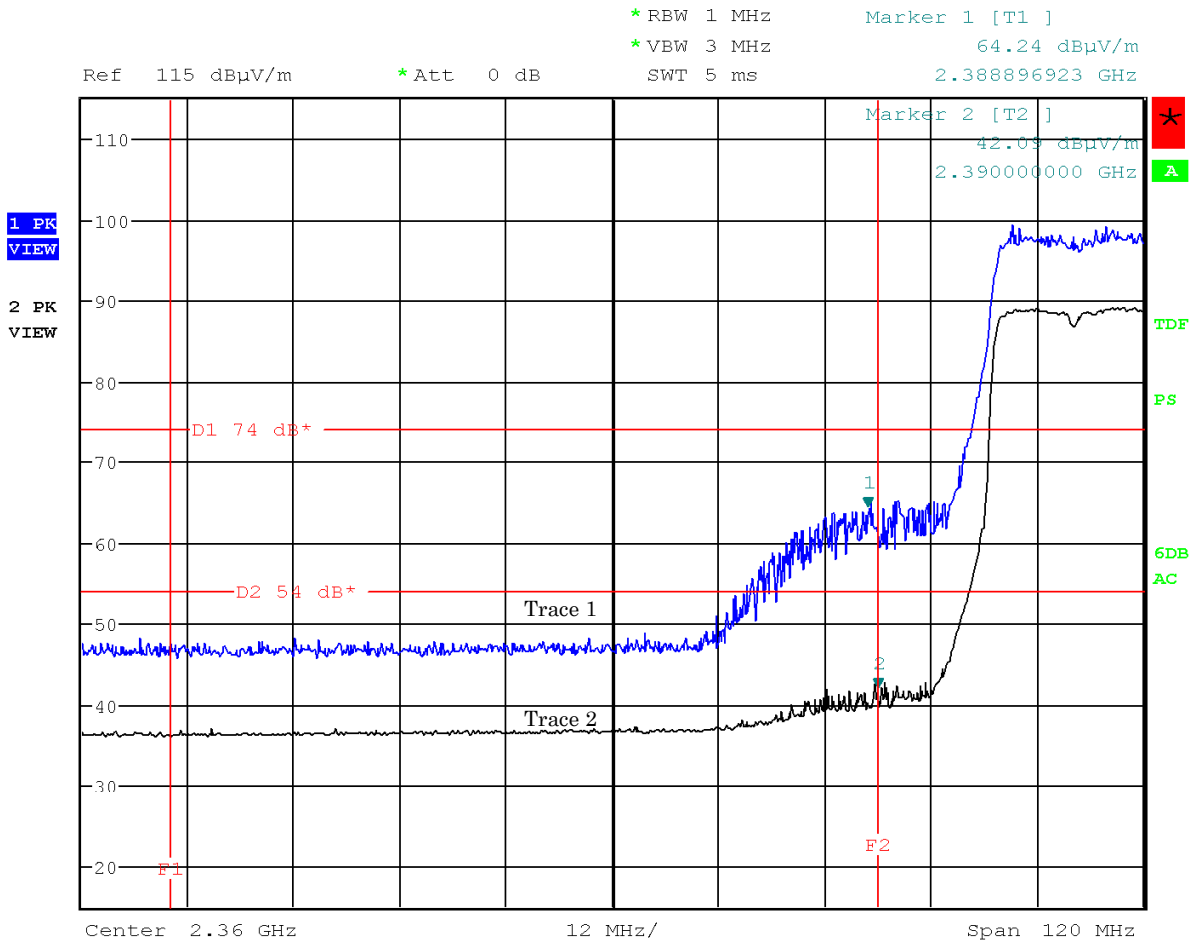

Note: The trace 1 is Peak . The trace 2 is Average.

Mode of EUT : 1TX: Main (1ch: 2412 MHz, (IEEE 802.11n))
 Antenna Polarization : Vertical

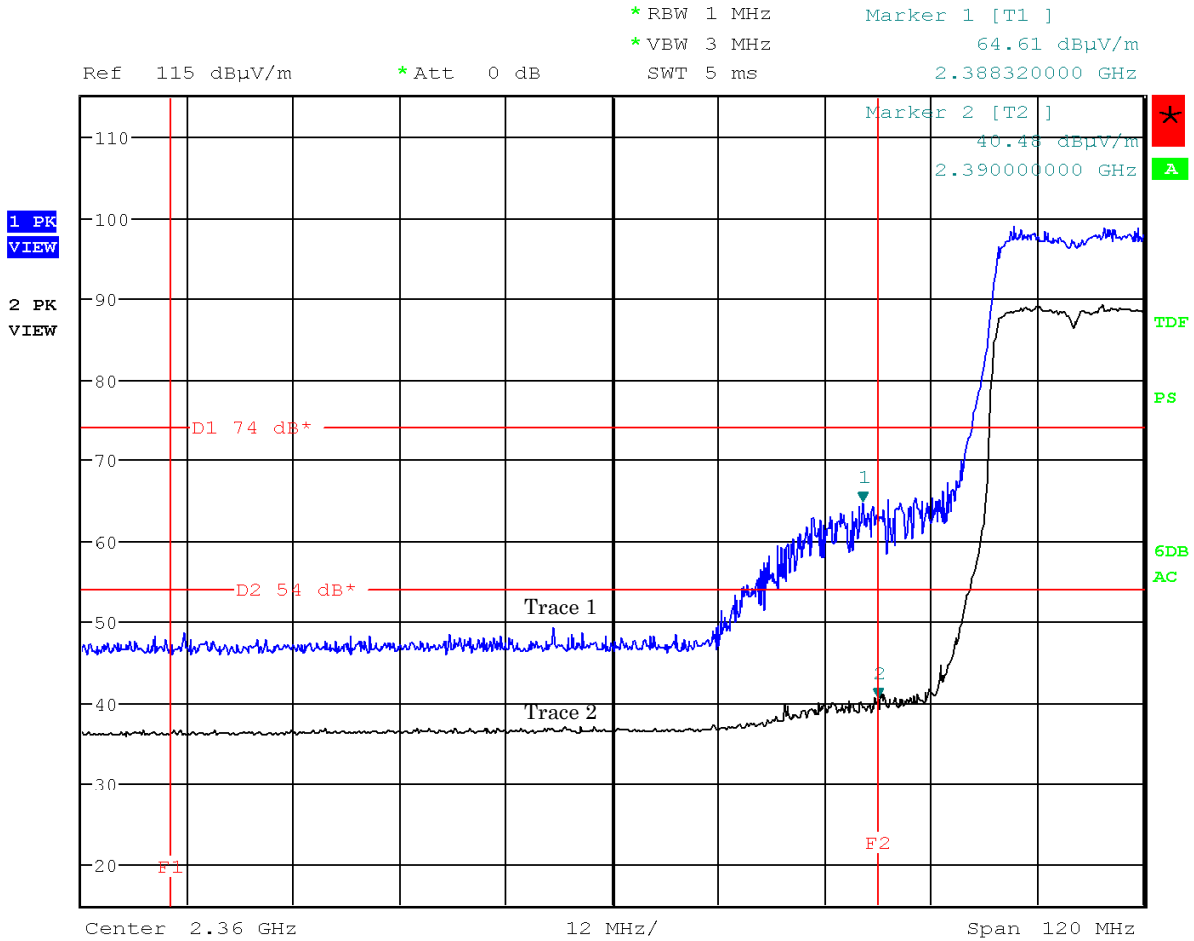

Note: The trace 1 is Peak . The trace 2 is Average.

Mode of EUT : 1TX: Main (11ch: 2462 MHz, (IEEE 802.11n))

Antenna Polarization : Horizontal

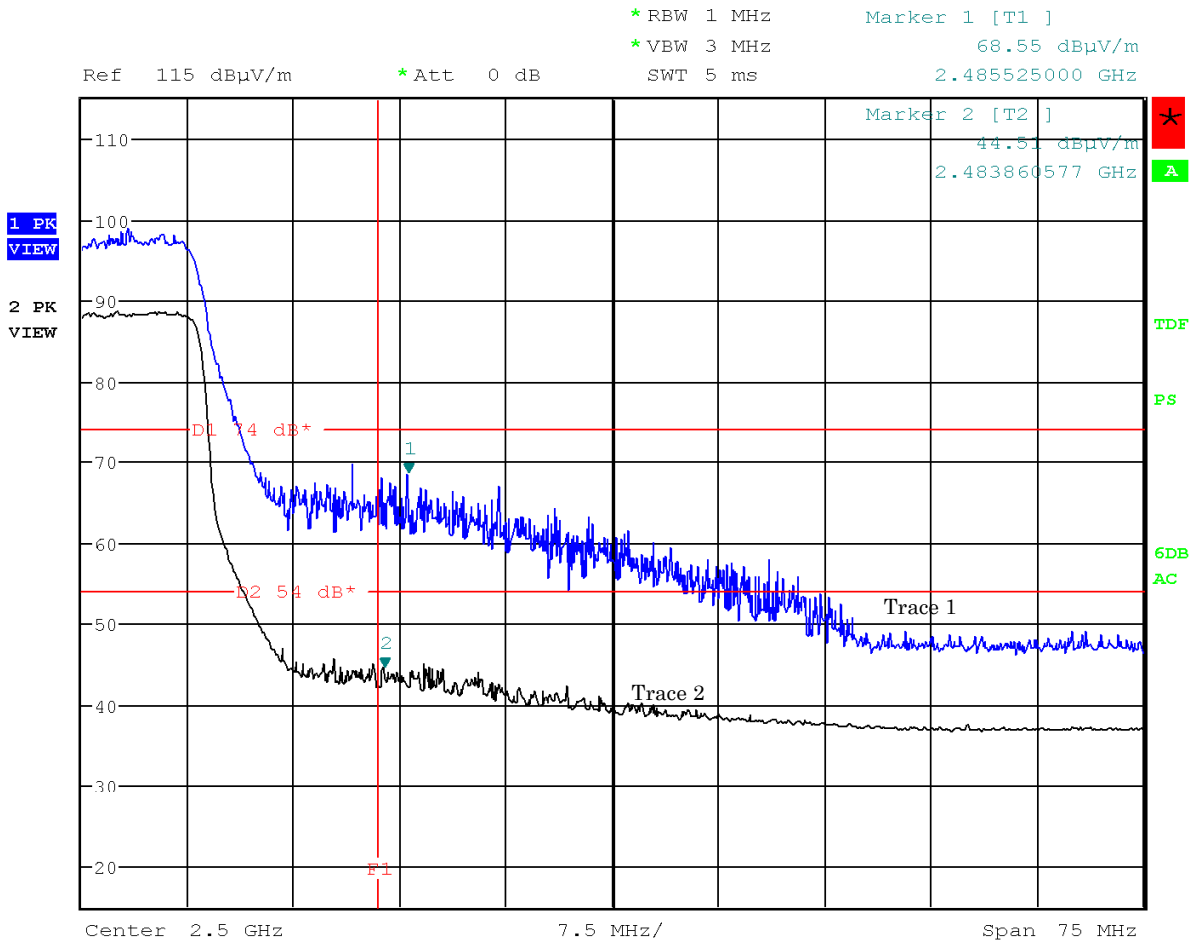

Note: The trace 1 is Peak . The trace 2 is Average.

Mode of EUT : 1TX: Main (11ch: 2462 MHz, (IEEE 802.11n))

Antenna Polarization : Vertical

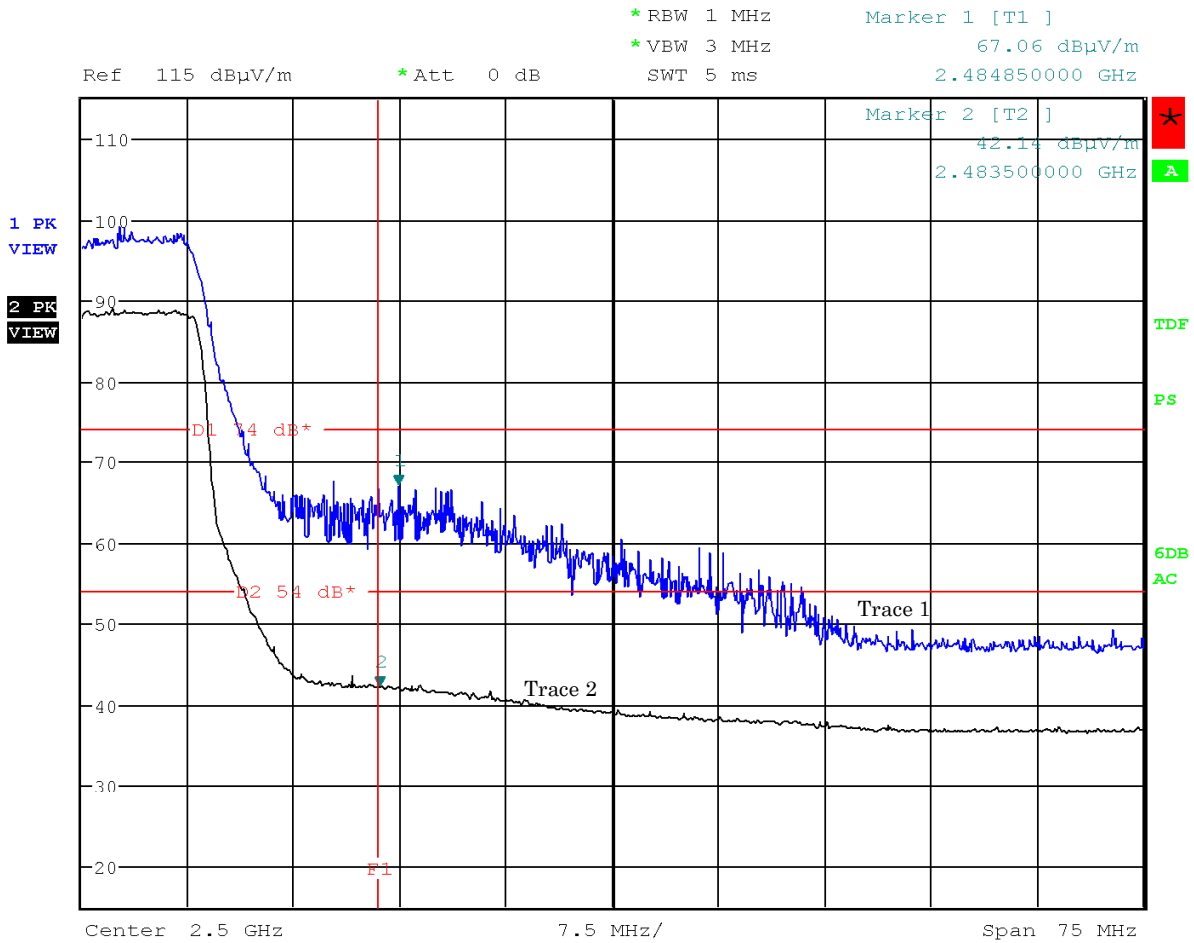

Note: The trace 1 is Peak . The trace 2 is Average.

Mode of EUT : 2TX: Main+Sub (1ch: 2412 MHz, (IEEE 802.11n))
 Antenna Polarization : Horizontal

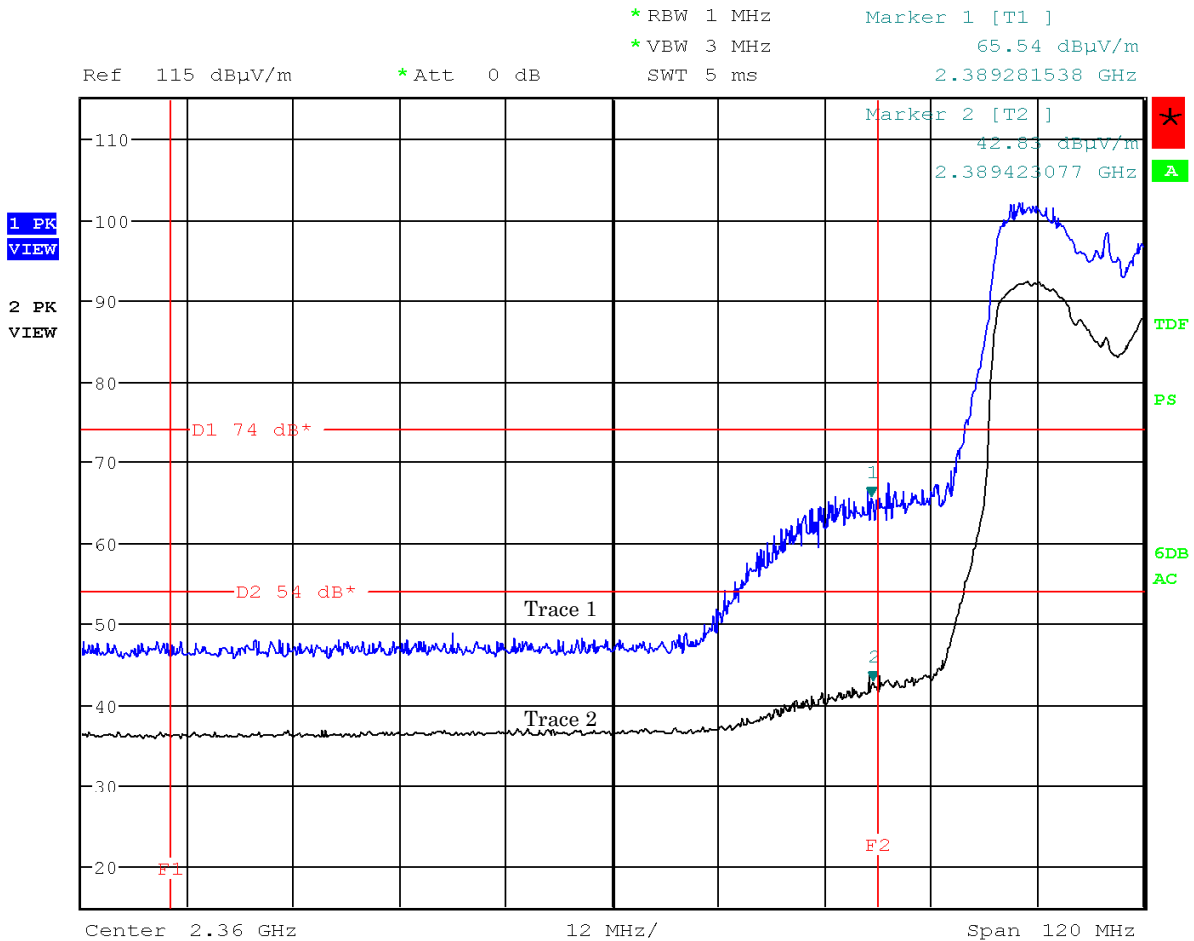

Note: The trace 1 is Peak . The trace 2 is Average.

Mode of EUT : 2TX: Main+Sub (1ch: 2412 MHz, (IEEE 802.11n))
 Antenna Polarization : Vertical

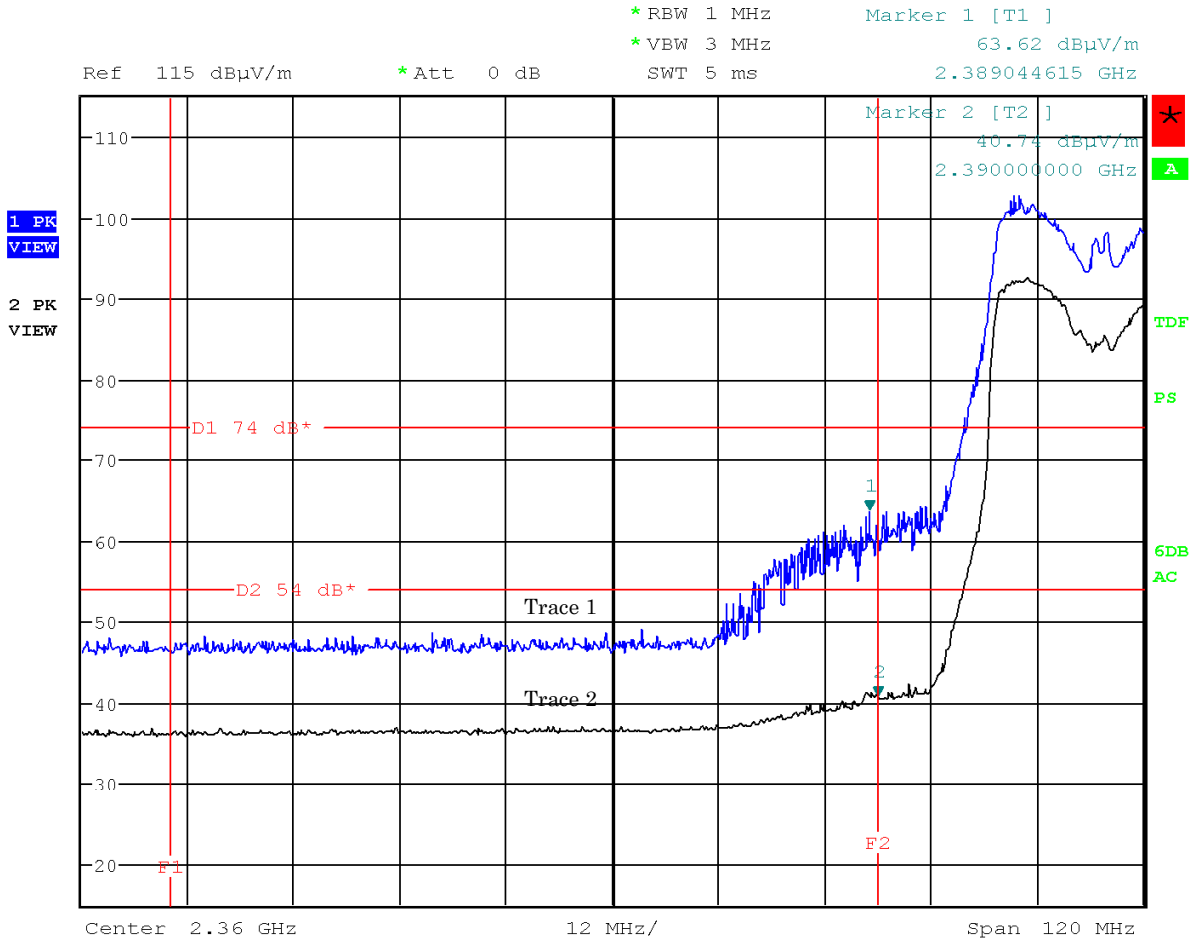

Note: The trace 1 is Peak . The trace 2 is Average.

Mode of EUT : 2TX: Main+Sub (11ch: 2462 MHz, (IEEE 802.11n))

Antenna Polarization : Horizontal

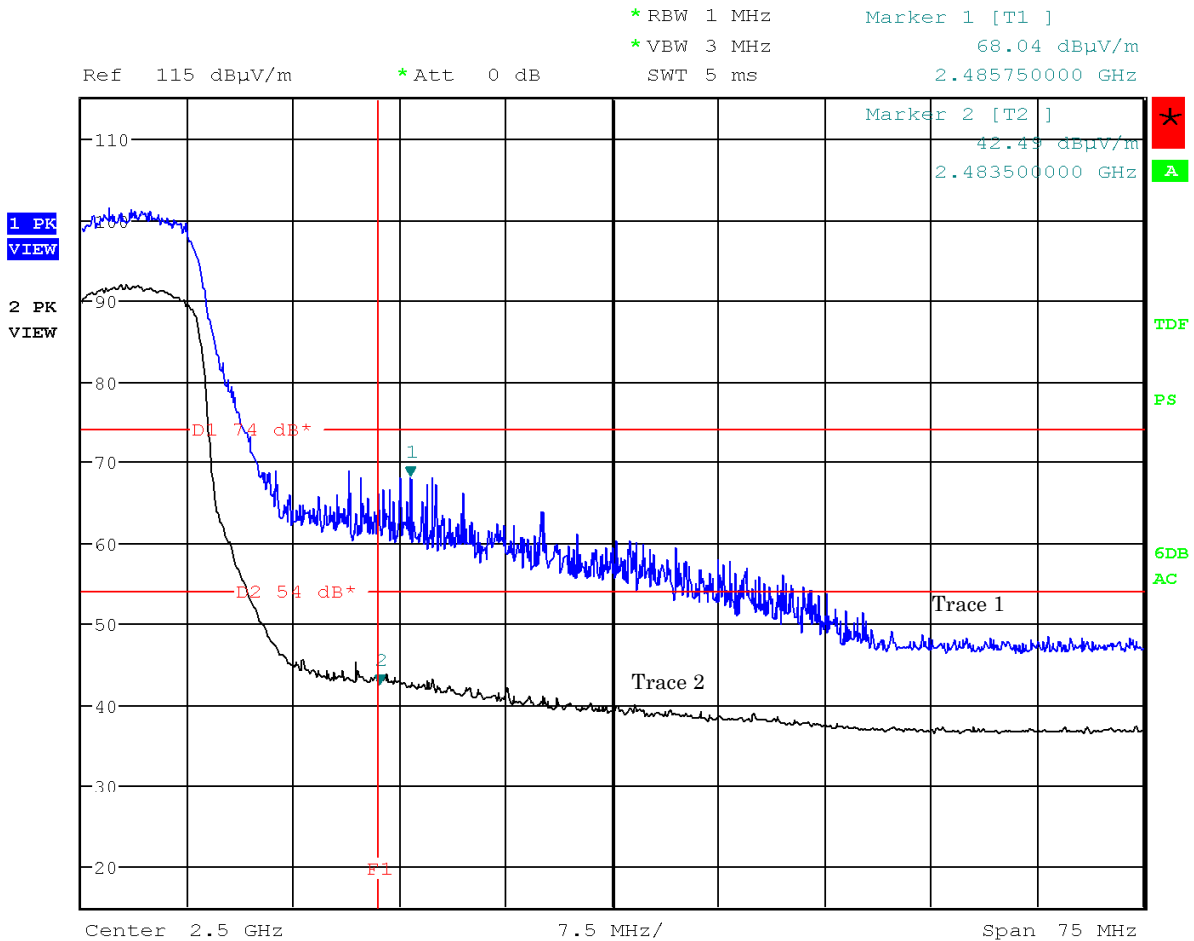

Note: The trace 1 is Peak . The trace 2 is Average.

Mode of EUT : 2TX: Main+Sub (11ch: 2462 MHz, (IEEE 802.11n))

Antenna Polarization : Vertical

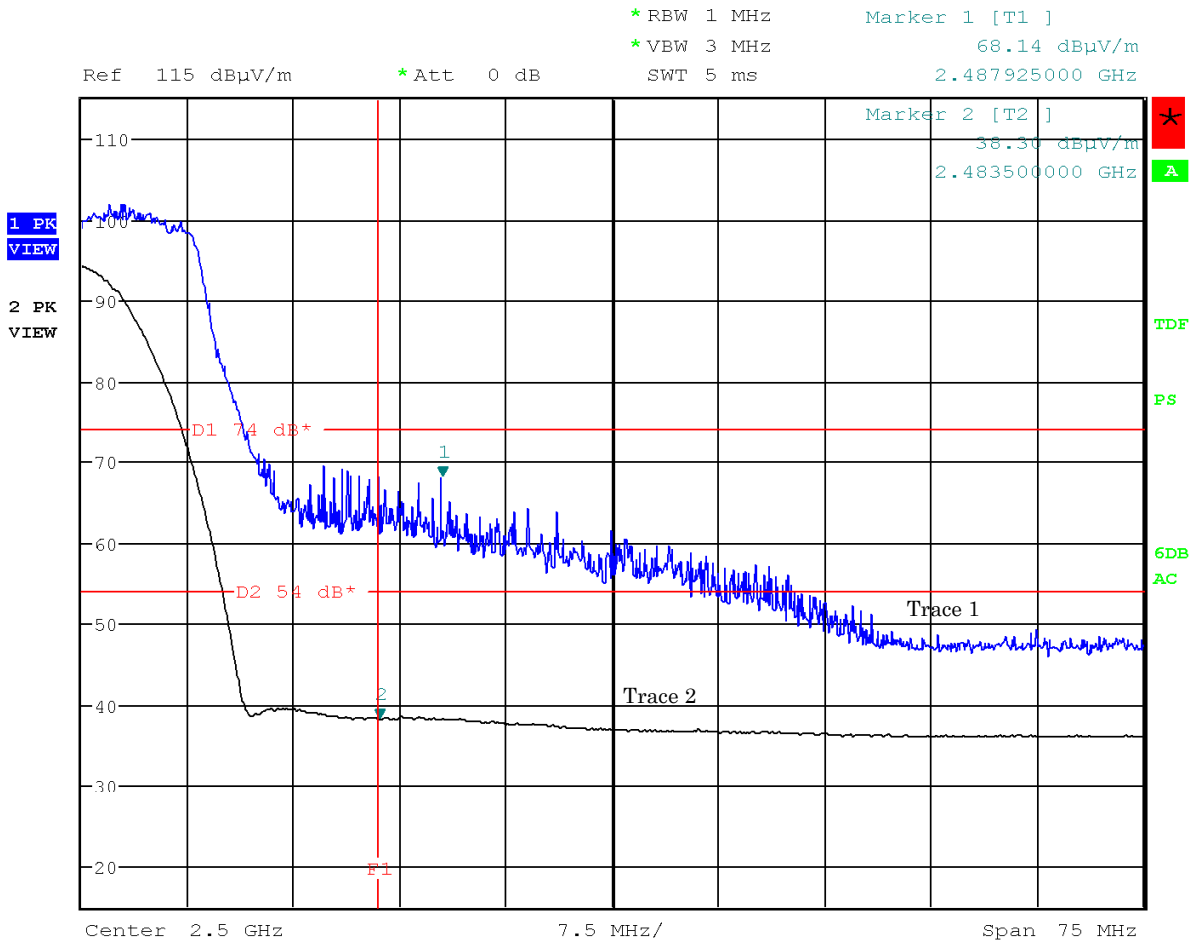

Note: The trace 1 is Peak . The trace 2 is Average.

Mode of EUT : Bluetooth Low Energy, Hopping off (0ch: 2402 MHz)
 Antenna Polarization : Horizontal

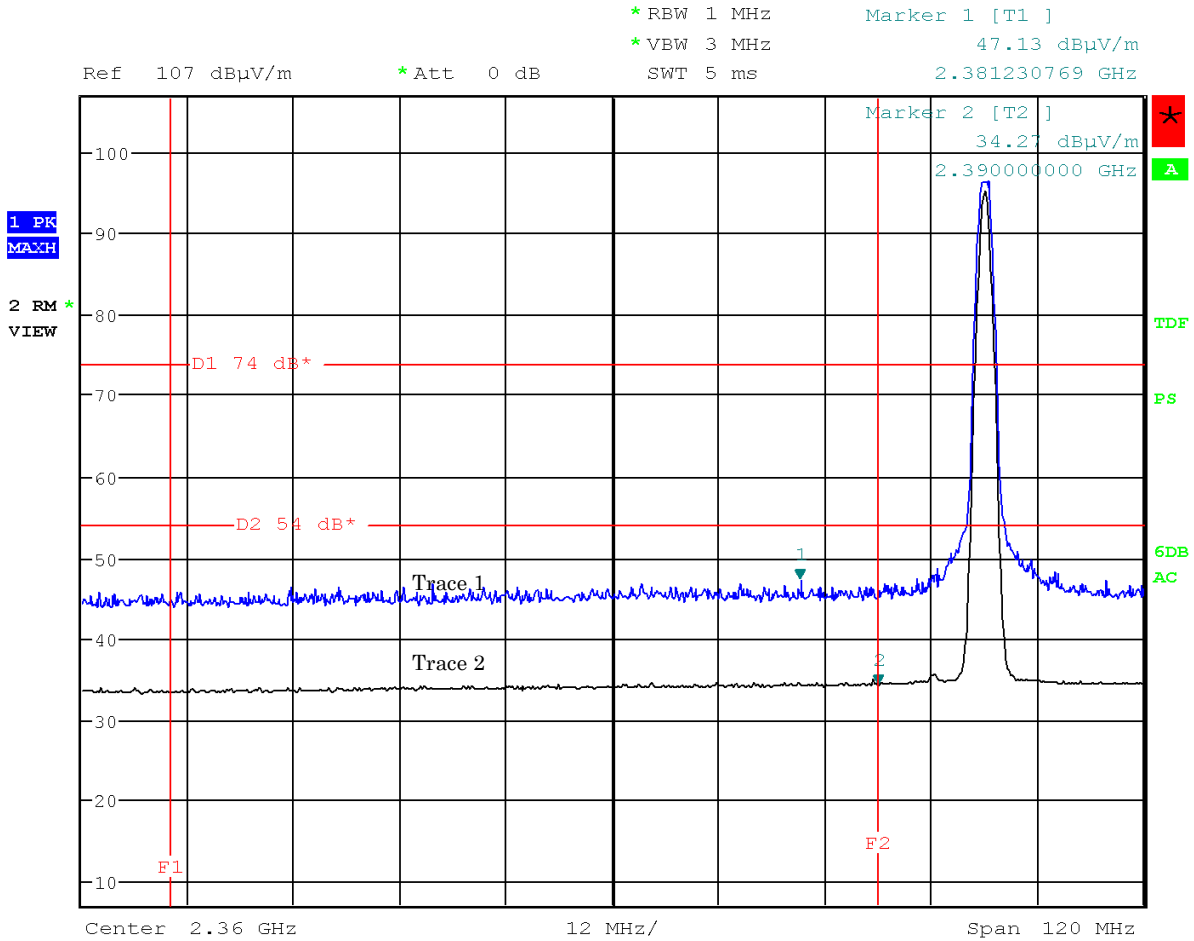

Note: The trace 1 is Peak . The trace 2 is Average.

Mode of EUT : Bluetooth Low Energy, Hopping off (Och: 2402 MHz)

Antenna Polarization : Vertical

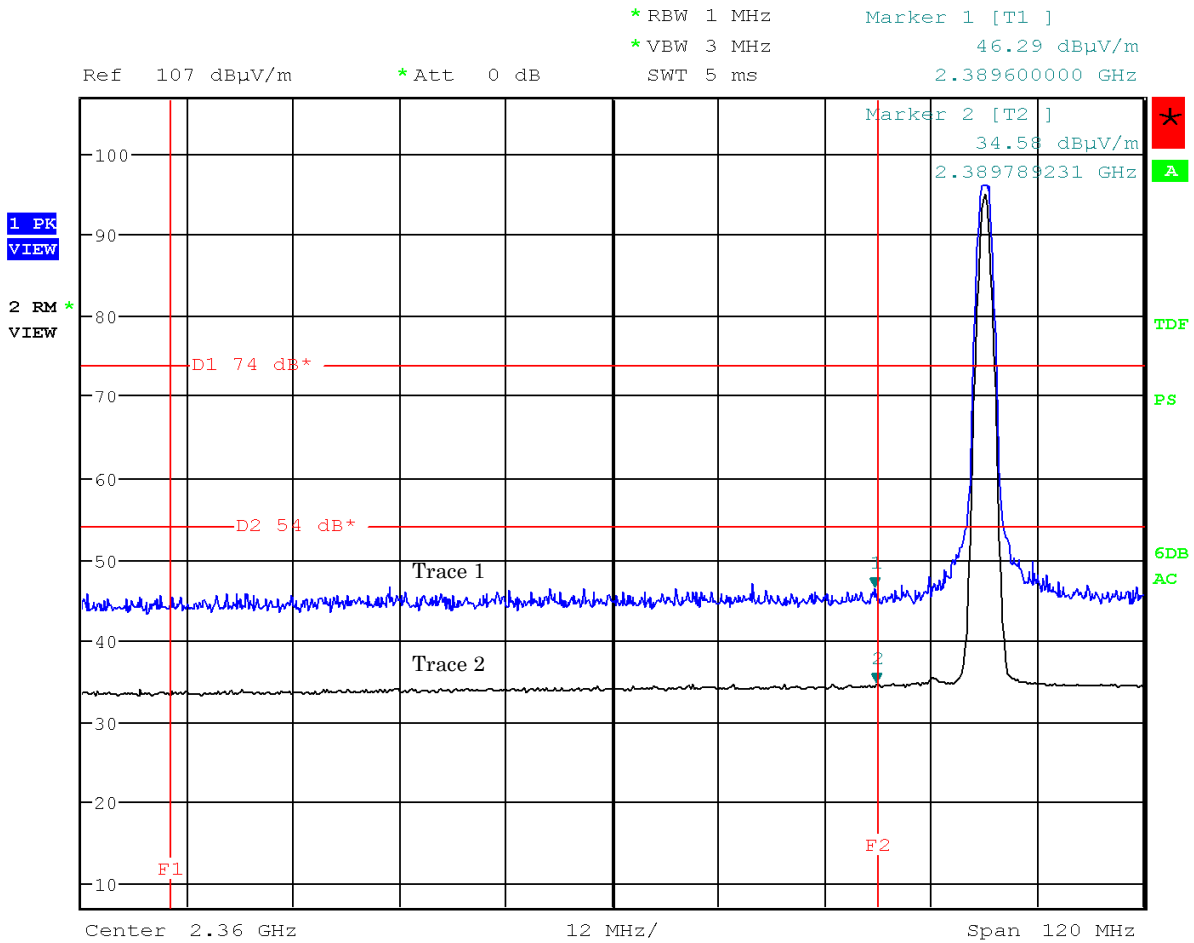

Note: The trace 1 is Peak . The trace 2 is Average.

Mode of EUT : Bluetooth Low Energy, Hopping off (39ch: 2480 MHz)

Antenna Polarization : Horizontal

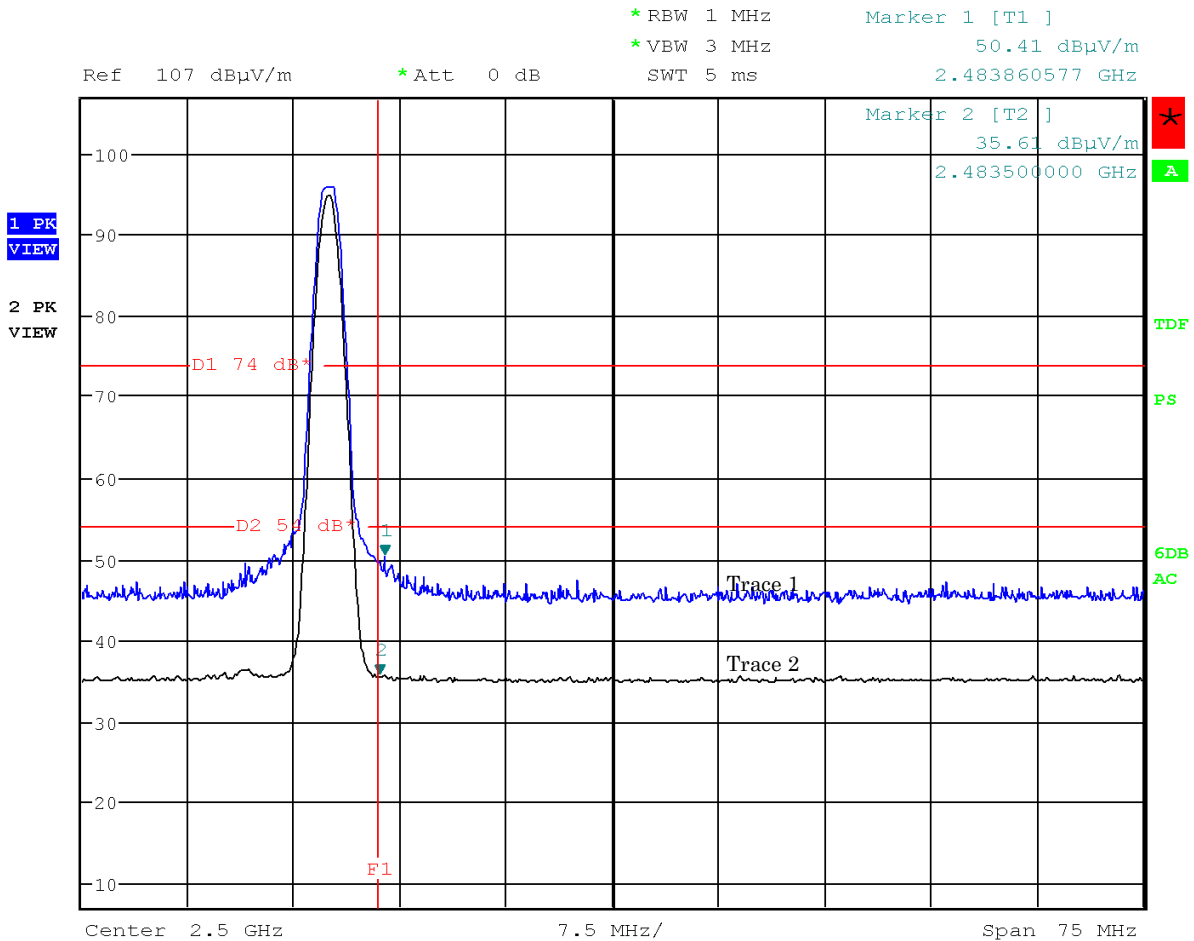

Note: The trace 1 is Peak . The trace 2 is Average.

Mode of EUT : Bluetooth Low Energy, Hopping off (39ch: 2480 MHz)

Antenna Polarization : Vertical

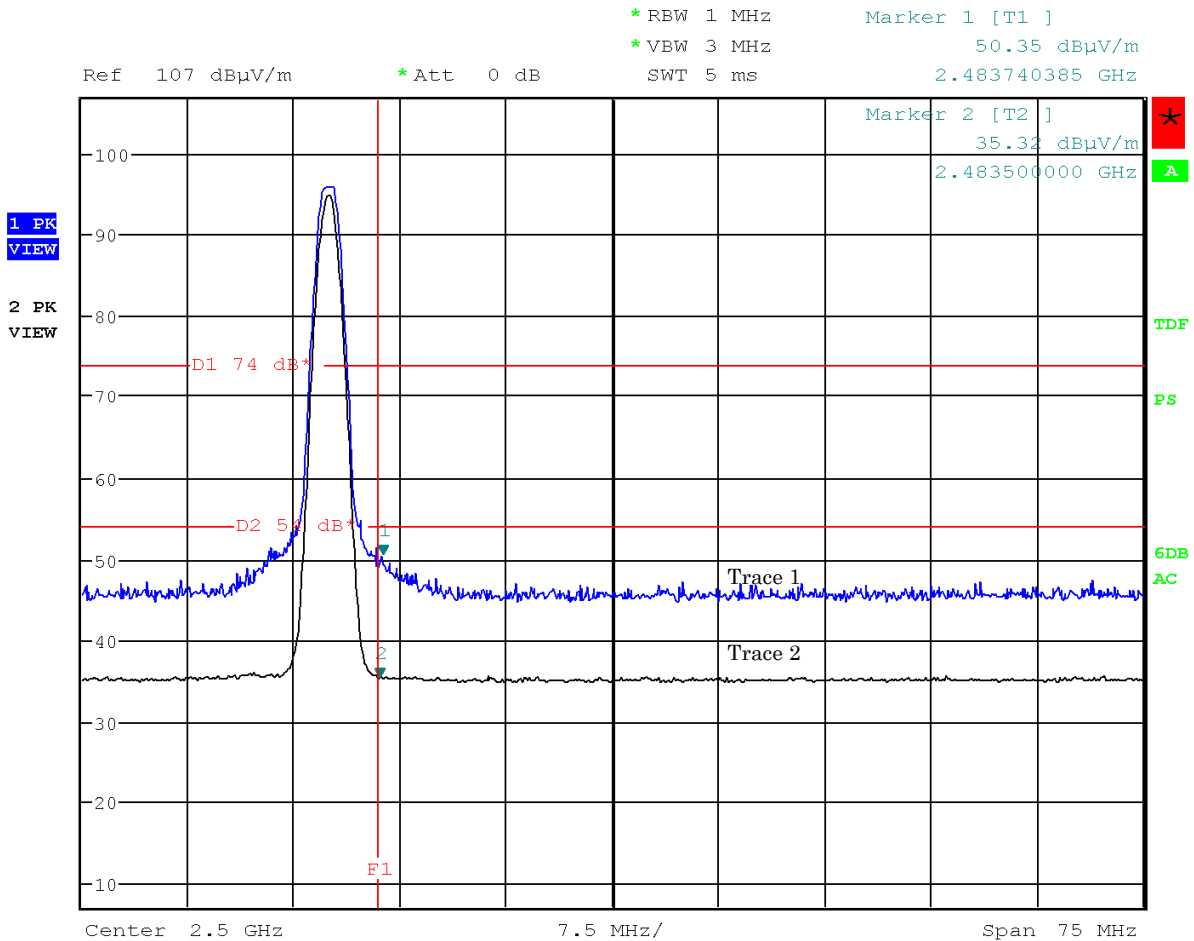

Note: The trace 1 is Peak . The trace 2 is Average.

7.9.4.2 Other Spurious Emission (9kHz – 30MHz)

Test Date : September 15, 2015

Temp.:24°C, Humi:55%

Mode of EUT : WLAN/Bluetooth LE

Results : No spurious emissions in the range 20dB below the limit.

7.9.4.3 Other Spurious Emission (30MHz – 1000MHz)

Mode of EUT : (WLAN) All modes have been investigated and the worst case mode for channel (06ch: 2437MHz / IEEE802.11b, IEEE802.11g and IEEE802.11n) has been listed.

Test Date: September 15, 2015

Temp.: 24 °C, Humi: 55 %

Antenna pole : Horizontal

Frequency [MHz]	Antenna Factor [dB(1/m)]	Corr. Factor [dB]	Meter Readings [dB(μV)]	Limits [dB(μV/m)]	Results [dB(μV/m)]	Margin [dB]	Remarks
96.00	9.3	-26.7	27.8	43.5	10.4	+33.1	-
207.60	16.6	-25.8	29.4	43.5	20.2	+23.3	-

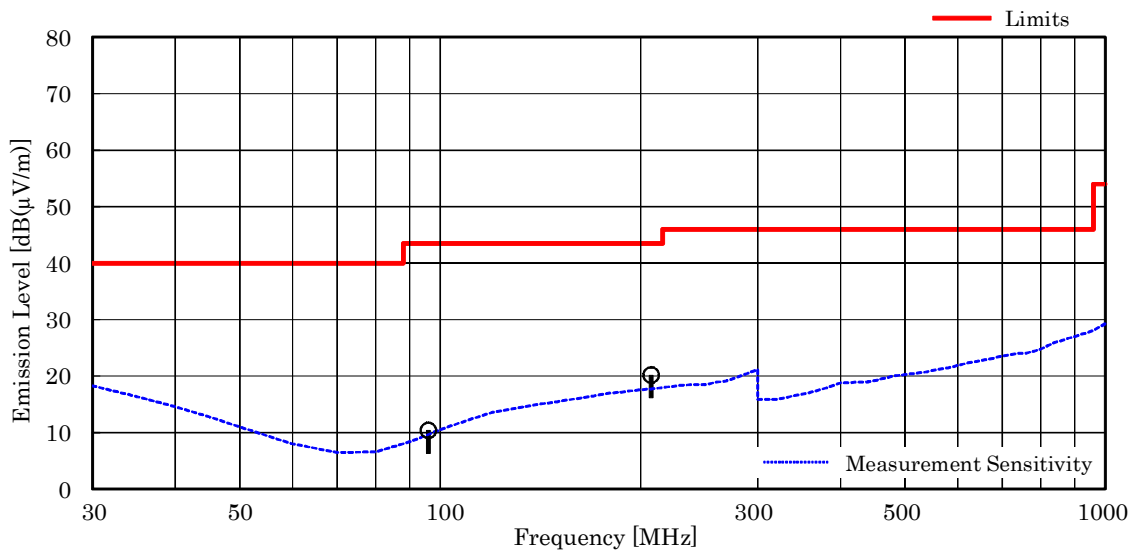

NOTES

1. Test Distance : 3 m
2. The spectrum was checked from 30 MHz to 1000 MHz.
3. The correction factor is composed of cable loss, pad attenuation and/or amplifier gain.
4. The symbol of "<" means "or less".
5. The symbol of ">" means "more than".
6. Calculated result at 207.60 MHz, as the worst point shown on underline:
 Antenna Factor + Coorection Factor + Meter Reading = 16.6 + (-25.8) + 29.4 = 20.2 dB(μV/m)
 Antenna Height : 1.73 m, Turntable Angle : 108 °
7. Test receiver setting(s) : CISPR QP 120 kHz (QP : Quasi-Peak)

Test Date: September 15, 2015

Temp.: 24 °C, Humi: 55 %

Antenna pole : Vertical

Frequency [MHz]	Antenna Factor [dB(1/m)]	Corr. Factor [dB]	Meter Readings [dB(μV)]	Limits [dB(μV/m)]	Results [dB(μV/m)]	Margin [dB]	Remarks
<u>30.74</u>	18.5	-27.5	35.8	40.0	26.8	+13.2	-
33.44	17.4	-27.5	35.2	40.0	25.1	+14.9	-
39.83	15.1	-27.4	29.8	40.0	17.5	+22.5	-
56.66	9.0	-27.1	29.8	40.0	11.7	+28.3	-
115.20	12.4	-26.5	31.6	43.5	17.5	+26.0	-
134.40	14.0	-26.3	28.3	43.5	16.0	+27.5	-
172.80	15.6	-26.0	30.5	43.5	20.1	+23.4	-

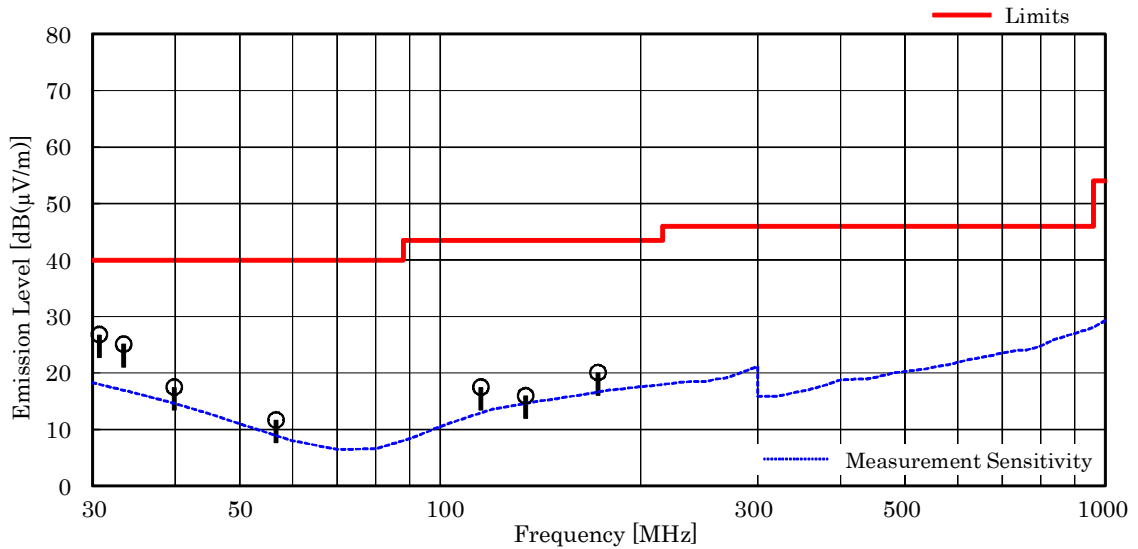

NOTES

1. Test Distance : 3 m
2. The spectrum was checked from 30 MHz to 1000 MHz.
3. The correction factor is composed of cable loss, pad attenuation and/or amplifier gain.
4. The symbol of "<" means "or less".
5. The symbol of ">" means "more than".
6. Calculated result at 30.74 MHz, as the worst point shown on underline:
 $\text{Antenna Factor} + \text{Coorection Factor} + \text{Meter Reading} = 18.5 + (-27.5) + 35.8 = 26.8 \text{ dB}(\mu\text{V}/\text{m})$
 Antenna Height : 1.00 m, Turntable Angle : 205 °
7. Test receiver setting(s) : CISPR QP 120 kHz (QP : Quasi-Peak)

Mode of EUT : Bluetooth Low Energy

Test Date: September 15, 2015
 Temp.: 24 °C, Humi: 55 %

Antenna pole : Horizontal

Frequency [MHz]	Antenna Factor [dB(1/m)]	Corr. Factor [dB]	Meter Readings [dB(μV)]	Limits [dB(μV/m)]	Results [dB(μV/m)]	Margin [dB]	Remarks
96.00	9.3	-26.7	28.1	43.5	10.7	+32.8	-
134.40	14.0	-26.3	28.0	43.5	15.7	+27.8	-
172.80	15.6	-26.0	< 27.0	43.5	< 16.6	> +26.9	-
192.00	16.2	-25.9	28.8	43.5	19.1	+24.4	-
207.60	16.6	-25.8	30.0	43.5	20.8	+22.7	-

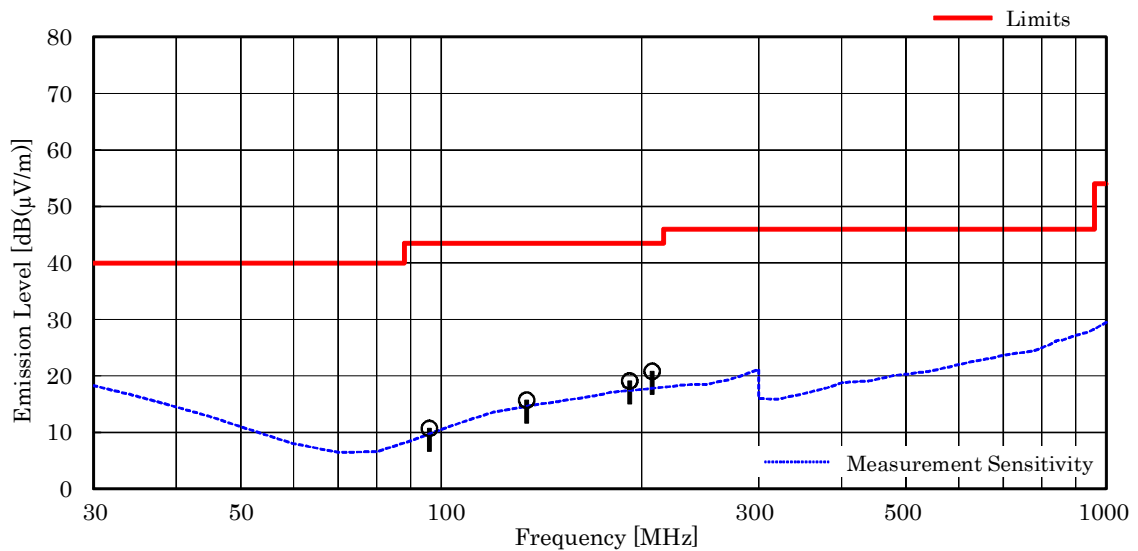

NOTES

1. Test Distance : 3 m
2. The spectrum was checked from 30 MHz to 1000 MHz.
3. The correction factor is composed of cable loss, pad attenuation and/or amplifier gain.
4. The symbol of "<" means "or less".
5. The symbol of ">" means "more than".
6. Calculated result at 207.60 MHz, as the worst point shown on underline:
 Antenna Factor + Coorection Factor + Meter Reading = 16.6 + (-25.8) + 30.0 = 20.8 dB(μV/m)
 Antenna Height : 1.60 m, Turntable Angle : 98 °
7. Test receiver setting(s) : CISPR QP 120 kHz (QP : Quasi-Peak)

Test Date: September 15, 2015
 Temp.: 24 °C, Humi: 55 %

Antenna pole : Vertical

Frequency [MHz]	Antenna Factor [dB(1/m)]	Corr. Factor [dB]	Meter Readings [dB(μV)]	Limits [dB(μV/m)]	Results [dB(μV/m)]	Margin [dB]	Remarks
<u>30.52</u>	18.6	-27.5	< 27.0	40.0	< 18.1	> +21.9	-
57.60	8.7	-27.1	31.6	40.0	13.2	+26.8	-
115.20	12.4	-26.5	28.5	43.5	14.4	+29.1	-
134.40	14.0	-26.3	28.4	43.5	16.1	+27.4	-
172.80	15.6	-26.0	30.0	43.5	19.6	+23.9	-
192.00	16.2	-25.9	< 27.0	43.5	< 17.3	> +26.2	-

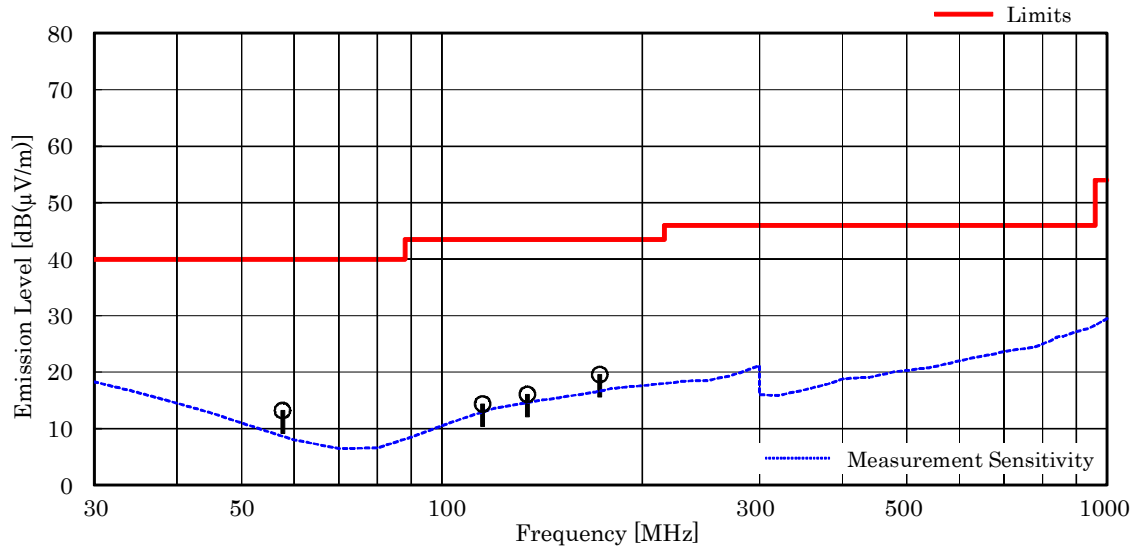

NOTES

1. Test Distance : 3 m
2. The spectrum was checked from 30 MHz to 1000 MHz.
3. The correction factor is composed of cable loss, pad attenuation and/or amplifier gain.
4. The symbol of "<" means "or less".
5. The symbol of ">" means "more than".
6. Calculated result at 30.52 MHz, as the worst point shown on underline:
 Antenna Factor + Coorection Factor + Meter Reading = 18.6 + (-27.5) + <27.0 = <18.1 dB(μV/m)
 Antenna Height : 1.00 m, Turntable Angle : 317 °
7. Test receiver setting(s) : CISPR QP 120 kHz (QP : Quasi-Peak)

7.9.4.4 Other Spurious Emission (Above 1000MHz)

7.9.4.4.1 Mode of TX

7.9.4.4.1.1 IEEE802.11b

a) 1TX (Main)

Test Date: September 11, 2015

Temp.: 22 °C, Humi: 67 %

Frequency [MHz]	Antenna Factor [dB(1/m)]	Corr. Factor [dB]	Meter Readings [dB(μV)]				Limits [dB(μV/m)]		Results [dB(μV/m)]		Margin [dB]	Remarks
			Horizontal		Vertical		PK	AVE	PK	AVE		
Test condition : Tx Low Ch												
4824.0	27.3	-16.1	< 38.0	< 28.0	< 38.0	< 28.0	74.0	54.0	< 49.2	< 39.2	> +14.8	
12060.0	33.6	-25.8	< 38.0	< 28.0	< 38.0	< 28.0	74.0	54.0	< 45.8	< 35.8	> +18.2	
14472.0	37.0	-26.4	< 38.0	< 28.0	< 38.0	< 28.0	74.0	54.0	< 48.6	< 38.6	> +15.4	
19296.0	40.5	-42.6	< 50.0	< 40.0	< 50.0	< 40.0	74.0	54.0	< 47.9	< 37.9	> +16.1	
Test condition : TX Middle Ch												
4874.0	27.3	-16.0	< 38.0	< 28.0	< 38.0	< 28.0	74.0	54.0	< 49.3	< 39.3	> +14.7	
<u>7311.0</u>	<u>29.9</u>	<u>-16.5</u>	<u>< 38.0</u>	<u>< 28.0</u>	<u>< 38.0</u>	<u>< 28.0</u>	<u>74.0</u>	<u>54.0</u>	<u>< 51.4</u>	<u>< 41.4</u>	<u>> +12.6</u>	
12185.0	33.5	-26.1	< 38.0	< 28.0	< 38.0	< 28.0	74.0	54.0	< 45.4	< 35.4	> +18.6	
19496.0	40.5	-42.6	< 50.0	< 40.0	< 50.0	< 40.0	74.0	54.0	< 47.9	< 37.9	> +16.1	
Test condition : TX High Ch												
4924.0	27.3	-15.9	< 38.0	< 28.0	< 38.0	< 28.0	74.0	54.0	< 49.4	< 39.4	> +14.6	
7386.0	29.8	-16.5	< 38.0	< 28.0	< 38.0	< 28.0	74.0	54.0	< 51.3	< 41.3	> +12.7	
12310.0	33.4	-26.4	< 38.0	< 28.0	< 38.0	< 28.0	74.0	54.0	< 45.0	< 35.0	> +19.0	
19696.0	40.5	-42.7	< 50.0	< 40.0	< 50.0	< 40.0	74.0	54.0	< 47.8	< 37.8	> +16.2	
22158.0	40.6	-43.1	< 50.0	< 40.0	< 50.0	< 40.0	74.0	54.0	< 47.5	< 37.5	> +16.5	

Calculated result at 7311.0 MHz, as the worst point shown on underline:

Antenna Factor	=	29.9 dB(1/m)
Corr. Factor	=	-16.5 dB
+) Meter Reading	=	<28.0 dB(μV)
Result	=	<41.4 dB(μV/m)

Minimum Margin: 54.0 - <41.4 = >12.6 (dB)

NOTES

1. Test Distance : 3 m
2. The spectrum was checked from 1 GHz to 25 GHz (10th harmonic of the highest fundamental frequency).
3. The correction factor is shown as follows:
 - Corr. Factor [dB] = Cable Loss + 20dB Pad Att. - Pre-Amp. Gain [dB] (1.0 - 7.6GHz)
 - Corr. Factor [dB] = Cable Loss + 10dB Pad Att. - Pre-Amp. Gain [dB] (7.6 - 18.0GHz)
 - Corr. Factor [dB] = Cable Loss - Pre-Amp. Gain [dB] (over 18 GHz)
4. The symbol of "<" means "or less".
5. The symbol of ">" means "more than".
6. PK : Peak / AVE : Average

b) 2TX (Main+Sub)

Test Date: September 11, 2015

Temp.: 22 °C, Humi: 67 %

Frequency [MHz]	Antenna Factor [dB(1/m)]	Corr. Factor [dB]	Meter Readings [dB(μV)]				Limits [dB(μV/m)]		Results [dB(μV/m)]		Margin [dB]	Remarks
			Horizontal		Vertical		PK	AVE	PK	AVE		
			PK	AVE	PK	AVE						
Test condition : Tx Low Ch												
4824.0	27.3	-16.1	< 38.0	< 28.0	< 38.0	< 28.0	74.0	54.0	< 49.2	< 39.2	> +14.8	
12060.0	33.6	-25.8	< 38.0	< 28.0	< 38.0	< 28.0	74.0	54.0	< 45.8	< 35.8	> +18.2	
14472.0	37.0	-26.4	< 38.0	< 28.0	< 38.0	< 28.0	74.0	54.0	< 48.6	< 38.6	> +15.4	
19296.0	40.5	-42.6	< 50.0	< 40.0	< 50.0	< 40.0	74.0	54.0	< 47.9	< 37.9	> +16.1	
Test condition : TX Middle Ch												
4874.0	27.3	-16.0	< 38.0	< 28.0	< 38.0	< 28.0	74.0	54.0	< 49.3	< 39.3	> +14.7	
7311.0	29.9	-16.5	< 38.0	< 28.0	< 38.0	< 28.0	74.0	54.0	< 51.4	< 41.4	> +12.6	
12185.0	33.5	-26.1	< 38.0	< 28.0	< 38.0	< 28.0	74.0	54.0	< 45.4	< 35.4	> +18.6	
19496.0	40.5	-42.6	< 50.0	< 40.0	< 50.0	< 40.0	74.0	54.0	< 47.9	< 37.9	> +16.1	
Test condition : TX High Ch												
4924.0	27.3	-15.9	< 38.0	< 28.0	< 38.0	< 28.0	74.0	54.0	< 49.4	< 39.4	> +14.6	
7386.0	29.8	-16.5	< 38.0	< 28.0	< 38.0	< 28.0	74.0	54.0	< 51.3	< 41.3	> +12.7	
12310.0	33.4	-26.4	< 38.0	< 28.0	< 38.0	< 28.0	74.0	54.0	< 45.0	< 35.0	> +19.0	
19696.0	40.5	-42.7	< 50.0	< 40.0	< 50.0	< 40.0	74.0	54.0	< 47.8	< 37.8	> +16.2	
22158.0	40.6	-43.1	< 50.0	< 40.0	< 50.0	< 40.0	74.0	54.0	< 47.5	< 37.5	> +16.5	

Calculated result at 7311.0 MHz, as the worst point shown on underline:

Antenna Factor	=	29.9 dB(1/m)
Corr. Factor	=	-16.5 dB
+) Meter Reading	=	<28.0 dB(μV)
Result	=	<41.4 dB(μV/m)

Minimum Margin: 54.0 - <41.4 = >12.6 (dB)

NOTES

1. Test Distance : 3 m
2. The spectrum was checked from 1 GHz to 25 GHz (10th harmonic of the highest fundamental frequency).
3. The correction factor is shown as follows:
 - Corr. Factor [dB] = Cable Loss + 20dB Pad Att. - Pre-Amp. Gain [dB] (1.0 - 7.6GHz)
 - Corr. Factor [dB] = Cable Loss + 10dB Pad Att. - Pre-Amp. Gain [dB] (7.6 - 18.0GHz)
 - Corr. Factor [dB] = Cable Loss - Pre-Amp. Gain [dB] (over 18 GHz)
4. The symbol of "<" means "or less".
5. The symbol of ">" means "more than".
6. PK : Peak / AVE : Average

7.9.4.4.1.2 IEEE802.11g

a) 1TX (Main)

Test Date: September 11, 2015
 Temp.: 22 °C, Humi: 67 %

Frequency [MHz]	Antenna Factor [dB(1/m)]	Corr. Factor [dB]	Meter Readings [dB(μV)]				Limits [dB(μV/m)]		Results [dB(μV/m)]		Margin [dB]	Remarks
			Horizontal		Vertical		PK	AVE	PK	AVE		
			PK	AVE	PK	AVE						
Test condition : Tx Low Ch												
4824.0	27.3	-16.1	< 38.0	< 28.0	< 38.0	< 28.0	74.0	54.0	< 49.2	< 39.2	> +14.8	
12060.0	33.6	-25.8	< 38.0	< 28.0	< 38.0	< 28.0	74.0	54.0	< 45.8	< 35.8	> +18.2	
14472.0	37.0	-26.4	< 38.0	< 28.0	< 38.0	< 28.0	74.0	54.0	< 48.6	< 38.6	> +15.4	
19296.0	40.5	-42.6	< 50.0	< 40.0	< 50.0	< 40.0	74.0	54.0	< 47.9	< 37.9	> +16.1	
Test condition : TX Middle Ch												
4874.0	27.3	-16.0	< 38.0	< 28.0	< 38.0	< 28.0	74.0	54.0	< 49.3	< 39.3	> +14.7	
7311.0	29.9	-16.5	< 38.0	< 28.0	< 38.0	< 28.0	74.0	54.0	< 51.4	< 41.4	> +12.6	
12185.0	33.5	-26.1	< 38.0	< 28.0	< 38.0	< 28.0	74.0	54.0	< 45.4	< 35.4	> +18.6	
19496.0	40.5	-42.6	< 50.0	< 40.0	< 50.0	< 40.0	74.0	54.0	< 47.9	< 37.9	> +16.1	
Test condition : TX High Ch												
4924.0	27.3	-15.9	< 38.0	< 28.0	< 38.0	< 28.0	74.0	54.0	< 49.4	< 39.4	> +14.6	
7386.0	29.8	-16.5	< 38.0	< 28.0	< 38.0	< 28.0	74.0	54.0	< 51.3	< 41.3	> +12.7	
12310.0	33.4	-26.4	< 38.0	< 28.0	< 38.0	< 28.0	74.0	54.0	< 45.0	< 35.0	> +19.0	
19696.0	40.5	-42.7	< 50.0	< 40.0	< 50.0	< 40.0	74.0	54.0	< 47.8	< 37.8	> +16.2	
22158.0	40.6	-43.1	< 50.0	< 40.0	< 50.0	< 40.0	74.0	54.0	< 47.5	< 37.5	> +16.5	

Calculated result at 7311.0 MHz, as the worst point shown on underline:

Antenna Factor	=	29.9 dB(1/m)
Corr. Factor	=	-16.5 dB
+) Meter Reading	=	<28.0 dB(μV)
Result	=	<41.4 dB(μV/m)

Minimum Margin: 54.0 - <41.4 = >12.6 (dB)

NOTES

1. Test Distance : 3 m
2. The spectrum was checked from 1 GHz to 25 GHz (10th harmonic of the highest fundamental frequency).
3. The correction factor is shown as follows:
 - Corr. Factor [dB] = Cable Loss + 20dB Pad Att. - Pre-Amp. Gain [dB] (1.0 - 7.6GHz)
 - Corr. Factor [dB] = Cable Loss + 10dB Pad Att. - Pre-Amp. Gain [dB] (7.6 - 18.0GHz)
 - Corr. Factor [dB] = Cable Loss - Pre-Amp. Gain [dB] (over 18 GHz)
4. The symbol of "<" means "or less".
5. The symbol of ">" means "more than".
6. PK : Peak / AVE : Average

b) 2TX (Main+Sub)

Test Date: September 11, 2015
 Temp.: 22 °C, Humi: 67 %

Frequency [MHz]	Antenna Factor [dB(1/m)]	Corr. Factor [dB]	Meter Readings [dB(μV)]				Limits [dB(μV/m)]		Results [dB(μV/m)]		Margin [dB]	Remarks
			Horizontal		Vertical		PK	AVE	PK	AVE		
			PK	AVE	PK	AVE						
Test condition : Tx Low Ch												
4824.0	27.3	-16.1	< 38.0	< 28.0	< 38.0	< 28.0	74.0	54.0	< 49.2	< 39.2	> +14.8	
12060.0	33.6	-25.8	< 38.0	< 28.0	< 38.0	< 28.0	74.0	54.0	< 45.8	< 35.8	> +18.2	
14472.0	37.0	-26.4	< 38.0	< 28.0	< 38.0	< 28.0	74.0	54.0	< 48.6	< 38.6	> +15.4	
19296.0	40.5	-42.6	< 50.0	< 40.0	< 50.0	< 40.0	74.0	54.0	< 47.9	< 37.9	> +16.1	
Test condition : TX Middle Ch												
4874.0	27.3	-16.0	< 38.0	< 28.0	< 38.0	< 28.0	74.0	54.0	< 49.3	< 39.3	> +14.7	
7311.0	29.9	-16.5	< 38.0	< 28.0	< 38.0	< 28.0	74.0	54.0	< 51.4	< 41.4	> +12.6	
12185.0	33.5	-26.1	< 38.0	< 28.0	< 38.0	< 28.0	74.0	54.0	< 45.4	< 35.4	> +18.6	
19496.0	40.5	-42.6	< 50.0	< 40.0	< 50.0	< 40.0	74.0	54.0	< 47.9	< 37.9	> +16.1	
Test condition : TX High Ch												
4924.0	27.3	-15.9	< 38.0	< 28.0	< 38.0	< 28.0	74.0	54.0	< 49.4	< 39.4	> +14.6	
7386.0	29.8	-16.5	< 38.0	< 28.0	< 38.0	< 28.0	74.0	54.0	< 51.3	< 41.3	> +12.7	
12310.0	33.4	-26.4	< 38.0	< 28.0	< 38.0	< 28.0	74.0	54.0	< 45.0	< 35.0	> +19.0	
19696.0	40.5	-42.7	< 50.0	< 40.0	< 50.0	< 40.0	74.0	54.0	< 47.8	< 37.8	> +16.2	
22158.0	40.6	-43.1	< 50.0	< 40.0	< 50.0	< 40.0	74.0	54.0	< 47.5	< 37.5	> +16.5	

Calculated result at 7311.0 MHz, as the worst point shown on underline:

Antenna Factor	=	29.9 dB(1/m)
Corr. Factor	=	-16.5 dB
+) Meter Reading	=	<28.0 dB(μV)
Result	=	<41.4 dB(μV/m)

Minimum Margin: 54.0 - <41.4 = >12.6 (dB)

NOTES

1. Test Distance : 3 m
2. The spectrum was checked from 1 GHz to 25 GHz (10th harmonic of the highest fundamental frequency).
3. The correction factor is shown as follows:
 - Corr. Factor [dB] = Cable Loss + 20dB Pad Att. - Pre-Amp. Gain [dB] (1.0 - 7.6GHz)
 - Corr. Factor [dB] = Cable Loss + 10dB Pad Att. - Pre-Amp. Gain [dB] (7.6 - 18.0GHz)
 - Corr. Factor [dB] = Cable Loss - Pre-Amp. Gain [dB] (over 18 GHz)
4. The symbol of "<" means "or less".
5. The symbol of ">" means "more than".
6. PK : Peak / AVE : Average

7.9.4.4.1.3 IEEE802.11n

a) 1TX (Main)

Test Date: September 11, 2015
 Temp.: 22 °C, Humi: 67%

Frequency [MHz]	Antenna Factor [dB(1/m)]	Corr. Factor [dB]	Meter Readings [dB(μV)]				Limits [dB(μV/m)]		Results [dB(μV/m)]		Margin [dB]	Remarks
			Horizontal		Vertical		PK	AVE	PK	AVE		
			PK	AVE	PK	AVE						
Test condition : Tx Low Ch												
4824.0	27.3	-16.1	< 38.0	< 28.0	< 38.0	< 28.0	74.0	54.0	< 49.2	< 39.2	> +14.8	
12060.0	33.6	-25.8	< 38.0	< 28.0	< 38.0	< 28.0	74.0	54.0	< 45.8	< 35.8	> +18.2	
14472.0	37.0	-26.4	< 38.0	< 28.0	< 38.0	< 28.0	74.0	54.0	< 48.6	< 38.6	> +15.4	
19296.0	40.5	-42.6	< 50.0	< 40.0	< 50.0	< 40.0	74.0	54.0	< 47.9	< 37.9	> +16.1	
Test condition : TX Middle Ch												
4874.0	27.3	-16.0	< 38.0	< 28.0	< 38.0	< 28.0	74.0	54.0	< 49.3	< 39.3	> +14.7	
7311.0	29.9	-16.5	< 38.0	< 28.0	< 38.0	< 28.0	74.0	54.0	< 51.4	< 41.4	> +12.6	
12185.0	33.5	-26.1	< 38.0	< 28.0	< 38.0	< 28.0	74.0	54.0	< 45.4	< 35.4	> +18.6	
19496.0	40.5	-42.6	< 50.0	< 40.0	< 50.0	< 40.0	74.0	54.0	< 47.9	< 37.9	> +16.1	
Test condition : TX High Ch												
4924.0	27.3	-15.9	< 38.0	< 28.0	< 38.0	< 28.0	74.0	54.0	< 49.4	< 39.4	> +14.6	
7386.0	29.8	-16.5	< 38.0	< 28.0	< 38.0	< 28.0	74.0	54.0	< 51.3	< 41.3	> +12.7	
12310.0	33.4	-26.4	< 38.0	< 28.0	< 38.0	< 28.0	74.0	54.0	< 45.0	< 35.0	> +19.0	
19696.0	40.5	-42.7	< 50.0	< 40.0	< 50.0	< 40.0	74.0	54.0	< 47.8	< 37.8	> +16.2	
22158.0	40.6	-43.1	< 50.0	< 40.0	< 50.0	< 40.0	74.0	54.0	< 47.5	< 37.5	> +16.5	

Calculated result at 7311.0 MHz, as the worst point shown on underline:

Antenna Factor	=	29.9 dB(1/m)
Corr. Factor	=	-16.5 dB
+) Meter Reading	=	<28.0 dB(μV)
Result	=	<41.4 dB(μV/m)

Minimum Margin: 54.0 - <41.4 = >12.6 (dB)

NOTES

1. Test Distance : 3 m
2. The spectrum was checked from 1 GHz to 25 GHz (10th harmonic of the highest fundamental frequency).
3. The correction factor is shown as follows:
 - Corr. Factor [dB] = Cable Loss + 20dB Pad Att. - Pre-Amp. Gain [dB] (1.0 - 7.6GHz)
 - Corr. Factor [dB] = Cable Loss + 10dB Pad Att. - Pre-Amp. Gain [dB] (7.6 - 18.0GHz)
 - Corr. Factor [dB] = Cable Loss - Pre-Amp. Gain [dB] (over 18 GHz)
4. The symbol of "<" means "or less".
5. The symbol of ">" means "more than".
6. PK : Peak / AVE : Average

b) 2TX (Main+Sub)

Test Date: September 11, 2015
 Temp.: 22 °C, Humi: 67 %

Frequency [MHz]	Antenna Factor [dB(1/m)]	Corr. Factor [dB]	Meter Readings [dB(μV)]				Limits [dB(μV/m)]		Results [dB(μV/m)]		Margin [dB]	Remarks
			Horizontal		Vertical		PK	AVE	PK	AVE		
			PK	AVE	PK	AVE						
Test condition : Tx Low Ch												
4824.0	27.3	-16.1	< 38.0	< 28.0	< 38.0	< 28.0	74.0	54.0	< 49.2	< 39.2	> +14.8	
12060.0	33.6	-25.8	< 38.0	< 28.0	< 38.0	< 28.0	74.0	54.0	< 45.8	< 35.8	> +18.2	
14472.0	37.0	-26.4	< 38.0	< 28.0	< 38.0	< 28.0	74.0	54.0	< 48.6	< 38.6	> +15.4	
19296.0	40.5	-42.6	< 50.0	< 40.0	< 50.0	< 40.0	74.0	54.0	< 47.9	< 37.9	> +16.1	
Test condition : TX Middle Ch												
4874.0	27.3	-16.0	< 38.0	< 28.0	< 38.0	< 28.0	74.0	54.0	< 49.3	< 39.3	> +14.7	
7311.0	29.9	-16.5	< 38.0	< 28.0	< 38.0	< 28.0	74.0	54.0	< 51.4	< 41.4	> +12.6	
12185.0	33.5	-26.1	< 38.0	< 28.0	< 38.0	< 28.0	74.0	54.0	< 45.4	< 35.4	> +18.6	
19496.0	40.5	-42.6	< 50.0	< 40.0	< 50.0	< 40.0	74.0	54.0	< 47.9	< 37.9	> +16.1	
Test condition : TX High Ch												
4924.0	27.3	-15.9	< 38.0	< 28.0	< 38.0	< 28.0	74.0	54.0	< 49.4	< 39.4	> +14.6	
7386.0	29.8	-16.5	< 38.0	< 28.0	< 38.0	< 28.0	74.0	54.0	< 51.3	< 41.3	> +12.7	
12310.0	33.4	-26.4	< 38.0	< 28.0	< 38.0	< 28.0	74.0	54.0	< 45.0	< 35.0	> +19.0	
19696.0	40.5	-42.7	< 50.0	< 40.0	< 50.0	< 40.0	74.0	54.0	< 47.8	< 37.8	> +16.2	
22158.0	40.6	-43.1	< 50.0	< 40.0	< 50.0	< 40.0	74.0	54.0	< 47.5	< 37.5	> +16.5	

Calculated result at 7311.0 MHz, as the worst point shown on underline:

Antenna Factor	=	29.9 dB(1/m)
Corr. Factor	=	-16.5 dB
+) Meter Reading	=	<28.0 dB(μV)
Result	=	<41.4 dB(μV/m)

Minimum Margin: 54.0 - <41.4 = >12.6 (dB)

NOTES

1. Test Distance : 3 m
2. The spectrum was checked from 1 GHz to 25 GHz (10th harmonic of the highest fundamental frequency).
3. The correction factor is shown as follows:
 - Corr. Factor [dB] = Cable Loss + 20dB Pad Att. - Pre-Amp. Gain [dB] (1.0 - 7.6GHz)
 - Corr. Factor [dB] = Cable Loss + 10dB Pad Att. - Pre-Amp. Gain [dB] (7.6 - 18.0GHz)
 - Corr. Factor [dB] = Cable Loss - Pre-Amp. Gain [dB] (over 18 GHz)
4. The symbol of "<" means "or less".
5. The symbol of ">" means "more than".
6. PK : Peak / AVE : Average

7.9.4.4.1.4 Bluetooth Low Energy

Test Date: September 11, 2015
 Temp.: 22 °C, Humi: 67 %

Frequency [MHz]	Antenna Factor [dB(1/m)]	Corr. Factor [dB]	Meter Readings [dB(μV)]				Limits [dB(μV/m)]		Results [dB(μV/m)]		Margin [dB]	Remarks
			Horizontal		Vertical		PK	AVE	PK	AVE		
Test condition : Tx Low Ch												
4804.0	27.3	-16.1	< 38.0	< 28.0	< 38.0	< 28.0	74.0	54.0	< 49.2	< 39.2	> +14.8	
12010.0	33.6	-25.7	< 38.0	< 28.0	< 38.0	< 28.0	74.0	54.0	< 45.9	< 35.9	> +18.1	
19216.0	40.5	-42.7	< 50.0	< 40.0	< 50.0	< 40.0	74.0	54.0	< 47.8	< 37.8	> +16.2	
Test condition : TX Middle Ch												
4880.0	27.3	-16.0	< 38.0	< 28.0	< 38.0	< 28.0	74.0	54.0	< 49.3	< 39.3	> +14.7	
7320.0	29.9	-16.5	< 38.0	< 28.0	< 38.0	< 28.0	74.0	54.0	< 51.4	< 41.4	> +12.6	
12200.0	33.5	-26.1	< 38.0	< 28.0	< 38.0	< 28.0	74.0	54.0	< 45.4	< 35.4	> +18.6	
19520.0	40.4	-42.6	< 50.0	< 40.0	< 50.0	< 40.0	74.0	54.0	< 47.8	< 37.8	> +16.2	
Test condition : TX High Ch												
4960.0	27.3	-15.9	< 38.0	< 28.0	< 38.0	< 28.0	74.0	54.0	< 49.4	< 39.4	> +14.6	
7440.0	29.8	-16.5	< 38.0	< 28.0	< 38.0	< 28.0	74.0	54.0	< 51.3	< 41.3	> +12.7	
12400.0	33.6	-26.5	< 38.0	< 28.0	< 38.0	< 28.0	74.0	54.0	< 45.1	< 35.1	> +18.9	
19840.0	40.4	-42.8	< 50.0	< 40.0	< 50.0	< 40.0	74.0	54.0	< 47.6	< 37.6	> +16.4	
22320.0	40.6	-43.2	< 50.0	< 40.0	< 50.0	< 40.0	74.0	54.0	< 47.4	< 37.4	> +16.6	

Calculated result at 7320.0 MHz, as the worst point shown on underline:

Antenna Factor	=	29.9 dB(1/m)
Corr. Factor	=	-16.5 dB
+) Meter Reading	=	<28.0 dB(μV)
Result	=	<41.4 dB(μV/m)

Minimum Margin: 54.0 - <41.4 = >12.6 (dB)

NOTES

1. Test Distance : 3 m
2. The spectrum was checked from 1 GHz to 25 GHz (10th harmonic of the highest fundamental frequency).
3. The correction factor is shown as follows:
 - Corr. Factor [dB] = Cable Loss + 20dB Pad Att. - Pre-Amp. Gain [dB] (1.0 - 7.6GHz)
 - Corr. Factor [dB] = Cable Loss + 10dB Pad Att. - Pre-Amp. Gain [dB] (7.6 - 18.0GHz)
 - Corr. Factor [dB] = Cable Loss - Pre-Amp. Gain [dB] (over 18 GHz)
4. The symbol of "<" means "or less".
5. The symbol of ">" means "more than".
6. PK : Peak / AVE : Average

7.9.4.4.2 Mode of RX (WLAN)

Test Date: September 11, 2015
 Temp.: 22 °C, Humi: 67 %

Frequency [MHz]	Antenna Factor [dB(1/m)]	Corr. Factor [dB]	Meter Readings [dB(μV)]				Limits [dB(μV/m)]		Results [dB(μV/m)]		Margin [dB]	Remarks
			Horizontal		Vertical		PK	AVE	PK	AVE		
Test condition : RX Middle Ch												
2437.0	21.2	-18.6	< 38.0	< 28.0	< 38.0	< 28.0	74.0	54.0	< 40.6	< 30.6	> +23.4	
4874.0	27.3	-16.3	< 38.0	< 28.0	< 38.0	< 28.0	74.0	54.0	< 49.0	< 39.0	> +15.0	
7311.0	29.9	-16.8	< 38.0	< 28.0	< 38.0	< 28.0	74.0	54.0	< 51.1	< 41.1	> +12.9	

Calculated result at 4874.0 MHz, as the worst point shown on underline:

Antenna Factor	=	27.3 dB(1/m)
Corr. Factor	=	-16.3 dB
+) Meter Reading	=	<28.0 dB(μV)
Result	=	<39.0 dB(μV/m)

Minimum Margin: 54.0 - <39.0 = >12.9 (dB)

NOTES

1. Test Distance : 3 m
2. The spectrum was checked from 1 GHz to 7.5 GHz .
3. The correction factor is shown as follows:
 Corr. Factor [dB] = Cable Loss + 20dB Pad Att. - Pre-Amp. Gain [dB] (1.0 - 7.6GHz)
4. The symbol of "<" means "or less".
5. The symbol of ">" means "more than".
6. PK : Peak / AVE : Average

7.9.4.4.3 Mode of RX (Bluetooth Low Energy)

Test Date: September 11, 2015
 Temp.: 22 °C, Humi: 67 %

Frequency [MHz]	Antenna Factor [dB(1/m)]	Corr. Factor [dB]	Meter Readings [dB(μV)]				Limits [dB(μV/m)]		Results [dB(μV/m)]		Margin [dB]	Remarks
			Horizontal		Vertical		PK	AVE	PK	AVE		
Test condition : RX Middle Ch												
2440.0	21.2	-18.6	< 38.0	< 28.0	< 38.0	< 28.0	74.0	54.0	< 40.6	< 30.6	> +23.4	
4880.0	27.3	-16.3	< 38.0	< 28.0	< 38.0	< 28.0	74.0	54.0	< 49.0	< 39.0	> +15.0	
7320.0	29.9	-16.8	< 38.0	< 28.0	< 38.0	< 28.0	74.0	54.0	< 51.1	< 41.1	> +12.9	

Calculated result at 7320.0 MHz, as the worst point shown on underline:

Antenna Factor	=	29.9 dB(1/m)
Corr. Factor	=	-16.8 dB
+) Meter Reading	=	<28.0 dB(μV)
Result	=	<41.1 dB(μV/m)

Minimum Margin: 54.0 - <41.1 =>12.9 (dB)

NOTES

1. Test Distance : 3 m
2. The spectrum was checked from 1 GHz to 7.5 GHz .
3. The correction factor is shown as follows:
 Corr. Factor [dB] = Cable Loss + 20dB Pad Att. - Pre-Amp. Gain [dB] (1.0 - 7.6GHz)
4. The symbol of "<" means "or less".
5. The symbol of ">" means "more than".
6. PK : Peak / AVE : Average