

## TEST REPORT

**Applicant** : Sharp Corporation, Communication Systems Division  
**Address** : 2-13-1, Iida Hachihonmatsu, Higashi-Hiroshima City, Hiroshima,  
739-0192, JAPAN

**Products** : Smart Phone  
**Model No.** : SH-04G  
**SERIAL NO.** : 004401115451060  
004401115450807

**FCC ID** : APYHRO00223

**Test Standard** : CFR 47 FCC Rules and Regulations Part 15

**Test Results** : **Passed**

**Date of Test** : April 10 ~ 15, 2015



Kousei Shibata  
Manager  
Japan Quality Assurance Organization  
KITA-KANSAI Testing Center  
SAITO EMC Branch  
7-3-10, Saito-asagi, Ibaraki-shi, Osaka 567-0085, Japan



- The measurement values stated in Test Report was made with traceable to National Institute of Advanced Industrial Science and Technology (AIST) of Japan and National Institute of Information and Communications Technology (NICT) of Japan.
- The applicable standard, testing condition and testing method which were used for the tests are based on the request of the applicant.
- The test results presented in this report relate only to the offered test sample.
- The contents of this test report cannot be used for the purposes, such as advertisement for consumers.
- This test report shall not be reproduced except in full without the written approval of JQA.
- VLAC does not approve, certify or warrant the product by this test report.

**TABLE OF CONTENTS**

	<b>Page</b>
1 Description of the Equipment Under Test .....	3
2 Summary of Test Results .....	4
3 Test Procedure.....	5
4 Test Location .....	5
5 Recognition of Test Laboratory .....	5
6 Description of Test Setup .....	6
7 Test Requirements .....	9

**DEFINITIONS FOR ABBREVIATION AND SYMBOLS USED IN THIS TEST REPORT****EUT** : Equipment Under Test**AE** : Associated Equipment**N/A** : Not Applicable**N/T** : Not Tested**EMC** : Electromagnetic Compatibility**EMI** : Electromagnetic Interference**EMS** : Electromagnetic Susceptibility - indicates that the listed condition, standard or equipment is applicable for this report. - indicates that the listed condition, standard or equipment is not applicable for this report.

**1 Description of the Equipment Under Test**

1. Manufacturer : Sharp Corporation, Communication Systems Division  
2-13-1, Iida Hachihonmatsu, Higashi-Hiroshima City, Hiroshima,  
739-0192, JAPAN
2. Products : Smart Phone
3. Model No. : SH-04G
4. Serial No. : 004401115451060  
: 004401115450807
5. Product Type : Pre-production
6. Date of Manufacture : February, 2015
7. Power Rating : 4.0VDC (Lithium-ion Battery UBATIA263AFN1 2450mAh)
8. Grounding : None
9. Transmitting Frequency : WLAN: 2412.0 MHz(01CH) –2462.0MHz(11CH)  
: Bluetooth LE: 2402.0 MHz(00CH) – 2480.0MHz(39CH)
10. Receiving Frequency : WLAN: 2412.0 MHz(01CH) –2462.0MHz(11CH)  
: Bluetooth LE: 2402.0 MHz(00CH) – 2480.0MHz(39CH)
11. Max. RF Output Power : 17.21dBm(Measure Value of IEEE802.11b)  
: 21.08dBm(Measure Value of IEEE802.11g)  
: 20.42dBm(Measure Value of IEEE802.11n)  
: 5.47dBm(Measure Value of Bluetooth LE)
12. Antenna Type : Inverted-L Type Antenna (Integral)
13. Antenna Gain : 2.14 dBi
14. Category : DTS
15. EUT Authorization : Certification
16. Received Date of EUT : April 10, 2015

**17. Channel Plan****WLAN:**

The carrier spacing is 5 MHz.

The carrier frequency is designated by the absolute frequency channel number (ARFCN).

The carrier frequency is expressed in the equation shown as follows:

$$\text{Transmitting Frequency (in MHz)} = 2407.0 + 5*n$$

$$\text{Receiving Frequency (in MHz)} = 2407.0 + 5*n$$

where, n : channel number ( $1 \leq n \leq 11$ )

**Bluetooth Low Energy Mode:**

The carrier spacing is 2 MHz.

The carrier frequency is designated by the absolute frequency channel number (ARFCN).

The carrier frequency is expressed in the equation shown as follows:

$$\text{Transmitting Frequency (in MHz)} = 2402.0 + 2*n$$

$$\text{Receiving Frequency (in MHz)} = 2402.0 + 2*n$$

where, n : channel number ( $0 \leq n \leq 39$ )

## 2 Summary of Test Results

Applied Standard : CFR 47 FCC Rules and Regulations Part 15  
Subpart C – Intentional Radiators

The EUT described in clause 1 was tested according to the applied standard shown above.  
Details of the test configuration is shown in clause 6.

The conclusion for the test items of which are required by the applied standard is indicated under the test result.

- The test result was **passed** for the test requirements of the applied standard.
- The test result was **failed** for the test requirements of the applied standard.
- The test result was **not judged** the test requirements of the applied standard.

In the approval of test results,

- Determining compliance with the limits in this report was based on the results of the compliance measurement, not taking into account measurement instrumentation uncertainty.
- No deviations were employed from the applied standard.
- No modifications were conducted by JQA to achieve compliance to the limitations.

Reviewed by:

Tested by:



---

Shigeru Kinoshita  
Assistant Manager  
JQA KITA-KANSAI Testing Center  
SAITO EMC Branch



---

Shigeru Osawa  
Deputy Manager  
JQA KITA-KANSAI Testing Center  
SAITO EMC Branch

### 3 Test Procedure

Test Requirements : §15.247, §15.207 and §15.209

Test Procedure : ANSI C63.10–2009  
Testing unlicensed wireless devices.

KDB 558074 D01  
DTS Meas Guidance v03r02: June 5, 2014.

### 4 Test Location

Japan Quality Assurance Organization (JQA)  
KITA-KANSAI Testing Center  
7-7, Ishimaru, 1-chome, Minoh-shi, Osaka, 562-0027, Japan  
SAITO EMC Branch  
7-3-10, Saito-asagi, Ibaraki-shi, Osaka 567-0085, Japan

### 5 Recognition of Test Laboratory

JQA KITA-KANSAI Testing Center SAITO EMC Branch is accredited under ISO/IEC 17025 by following accreditation bodies and the test facility is registered by the following bodies.

VLAC Accreditation No. : VLAC-001-2 (Expiry date : March 30, 2016)  
VCCI Registration No. : A-0002 (Expiry date : March 30, 2016)  
BSMI Registration No. : SL2-IS-E-6006, SL2-IN-E-6006, SL2-R1/R2-E-6006, SL2-A1-E-6006  
(Expiry date : September 14, 2016)  
IC Registration No. : 2079E-3, 2079E-4 (Expiry date : July 16, 2017)

Accredited as conformity assessment body for Japan electrical appliances and material law by METI.  
(Expiry date : February 22, 2016)

## 6 Description of Test Setup

### 6.1 Test Configuration

The equipment under test (EUT) consists of :

	Item	Manufacturer	Model No.	Serial No.	FCC ID
A	Smart Phone	Sharp	SH-04G	004401115451060*1) 004401115450807*2)	APYHRO00223
B	AC Adapter	Fujitsu Corporation	05	XFA	N/A
C	Stereo Handsfree	Sharp	SHLDL1	--	N/A
D	DTV Antenna	Sharp	SH01	--	N/A

\*1) Used for AC Powerline Conducted Emission and Field Strength of Spurious Emission

\*2) Used for Antenna Conducted Emission

The auxiliary equipment used for testing :

None

Type of Cable:

No.	Description	Identification (Manu. etc.)	Connector Shielded	Cable Shielded	Ferrite Core	Length (m)
1	USB conversion cable	--	--	NO	YES	1.2
2	Handsfree Cable	--	--	NO	NO	1.5
3	DTV Antenna Cable	--	--	NO	NO	0.3

**6.2 Test Arrangement (Drawings)**

a) Single Unit

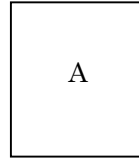

b) AC Adapter used

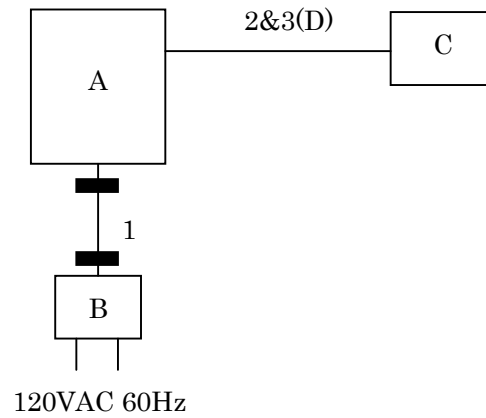

c) Earphone used

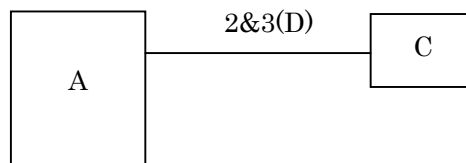
 : Ferrite Core

### 6.3 Operating Condition

#### Transmitting/Receiving

##### WLAN:

Transmitting frequency : 2412.0 MHz(1CH) – 2462.0 MHz(11CH)  
Receiver frequency : 2412.0 MHz(1CH) – 2462.0 MHz(11CH)

##### Bluetooth Low Energy Mode(Bluetooth 4.0 + EDR + LE):

Transmitting frequency : 2402.0 MHz(0CH) – 2480.0 MHz(39CH)  
Receiver frequency : 2402.0 MHz(0CH) – 2480.0 MHz(39CH)

#### Modulation Type

1. 802.11b : DSSS
2. 802.11g : OFDM
3. 802.11n : OFDM
4. LE Packet (Modulation Type : GFSK)

#### Other Clock Frequency

19.2MHz, 27.12MHz

The tests were performed in the following worst condition.

Mode	Condition
IEEE802.11b	11 Mbps
IEEE802.11g	18 Mbps
IEEE802.11n	MCS1 (13 Mbps)

Note: The worst condition was determined based on the test result of Maximum Peak Output Power(Mid channel).

The EUT was rotated through three orthogonal axis (X, Y and Z axis) in radiated measurement.  
The EUT with temporary antenna port was used in conducted measurement.



## 7 Test Requirements

### 7.0 Summary of the Test Results

Test Item	FCC Specification	Reference of the Test Report	Results	Remarks
Antenna Requirement	Section 15.203	Section 1.12	Passed	-
Channel Separation	Section 15.247(a)(1)	-	-	-
Minimum Hopping Channel	Section 15.247(a)(1)(iii)	-	-	-
Occupied Bandwidth	Section 15.247(a)(2)	Section 7.3	Passed	-
Dwell Time	Section 15.247(a)(1)(iii)	-	-	-
Peak Output Power (Conduction)	Section 15.247(b)(3)	Section 7.5	Passed	-
Peak Power Density (Conduction)	Section 15.247(e)	Section 7.6	Passed	-
Spurious Emissions (Conduction)	Section 15.247(d)	Section 7.7	Passed	-
AC Powerline Conducted Emission	Section 15.207	Section 7.8	Passed	-
Radiated Emission	Section 15.247(d)	Section 7.9	Passed	-

**7.1 Channel Separation**

For the requirements,  - Applicable  - Tested.  - Not tested by applicant request.]  
 - Not Applicable

For the limits,  - Passed  - Failed  - Not judged

**7.2 Minimum Hopping Channel**

For the requirements,  - Applicable  - Tested.  - Not tested by applicant request.]  
 - Not Applicable

For the limits,  - Passed  - Failed  - Not judged

**7.3 Occupied Bandwidth**

For the requirements,  - Applicable  - Tested.  - Not tested by applicant request.]  
 - Not Applicable

For the limits,  - Passed  - Failed  - Not judged

**7.3.1 Worst Point and Measurement Uncertainty**

The 99% Bandwidth of IEEE802.11b is	<u>13.036</u>	MHz	at	<u>2437.0</u>	MHz
The 99% Bandwidth of IEEE802.11g is	<u>16.503</u>	MHz	at	<u>2437.0</u>	MHz
The 99% Bandwidth of IEEE802.11n is	<u>17.676</u>	MHz	at	<u>2462.0</u>	MHz
The 99% Bandwidth of Bluetooth LE is	<u>1089.6</u>	kHz	at	<u>2402.0</u>	MHz
The 6dB Bandwidth of IEEE802.11b is	<u>8.869</u>	MHz	at	<u>2412.0</u>	MHz
The 6dB Bandwidth of IEEE802.11g is	<u>16.490</u>	MHz	at	<u>2462.0</u>	MHz
The 6dB Bandwidth of IEEE802.11n is	<u>17.731</u>	MHz	at	<u>2462.0</u>	MHz
The 6dB Bandwidth of Bluetooth LE is	<u>670.5</u>	kHz	at	<u>2480.0</u>	MHz

Uncertainty of Measurement Results +/-0.9 % (2σ)

Remarks : \_\_\_\_\_

**7.3.2 Test Instruments**

Shielded Room S4					
Type	Model	Manufacturer	ID No.	Last Cal.	Interval
Spectrum Analyzer	E4446A	Agilent	A-39	2014/9	1 Year
Attenuator	54A-10	Weinschel	D-28	2014/9	1 Year
RF Cable	SUCOFLEX102	SUHNER	C-52	2014/8	1 Year

**7.3.3 Test Method and Test Setup (Diagrammatic illustration)**

The test system is shown as follows:

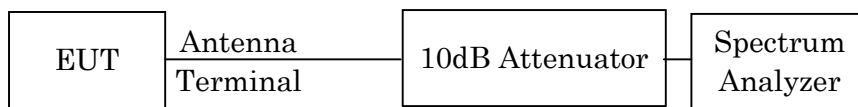

The setting of the spectrum analyzer are shown as follows:

	WLAN	Bluetooth
Res. Bandwidth	100 kHz	100 kHz
Video Bandwidth	300 kHz	300 kHz
Span	30 MHz	3 MHz
Sweep Time	AUTO	AUTO
Trace	Maxhold	Maxhold

7.3.4 Test Data

Mode of EUT : WLAN

Test Date : April 11, 2015

Temp.:21°C, Humi:48%

The resolution bandwidth was set to 100 kHz, -6dBc display line was placed on the screen (or 99% bandwidth), the occupied bandwidth is the delta frequency between the two points where the display line intersects the signal trace.

A) IEEE 802.11b

Channel	Frequency (MHz)	99% Bandwidth (MHz)	-6dBc Bandwidth (MHz)	Minimum -6dBc Bandwidth Limit (kHz)
01	2412.0	13.011	8.869	500
06	2437.0	13.036	7.573	500
11	2462.0	13.002	8.315	500

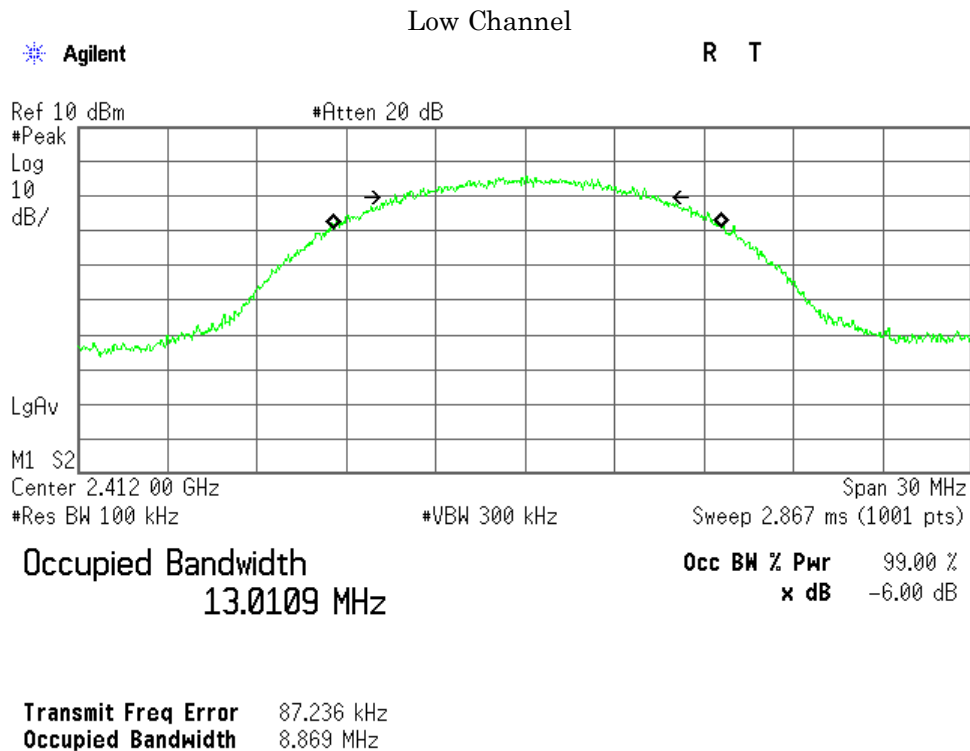

Middle Channel

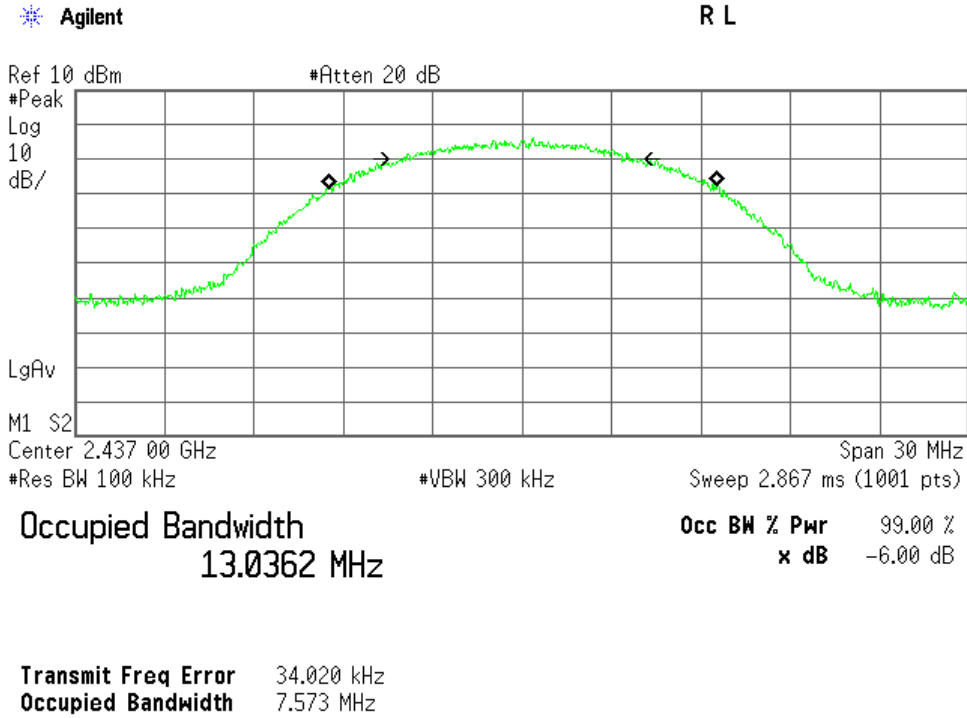

High Channel

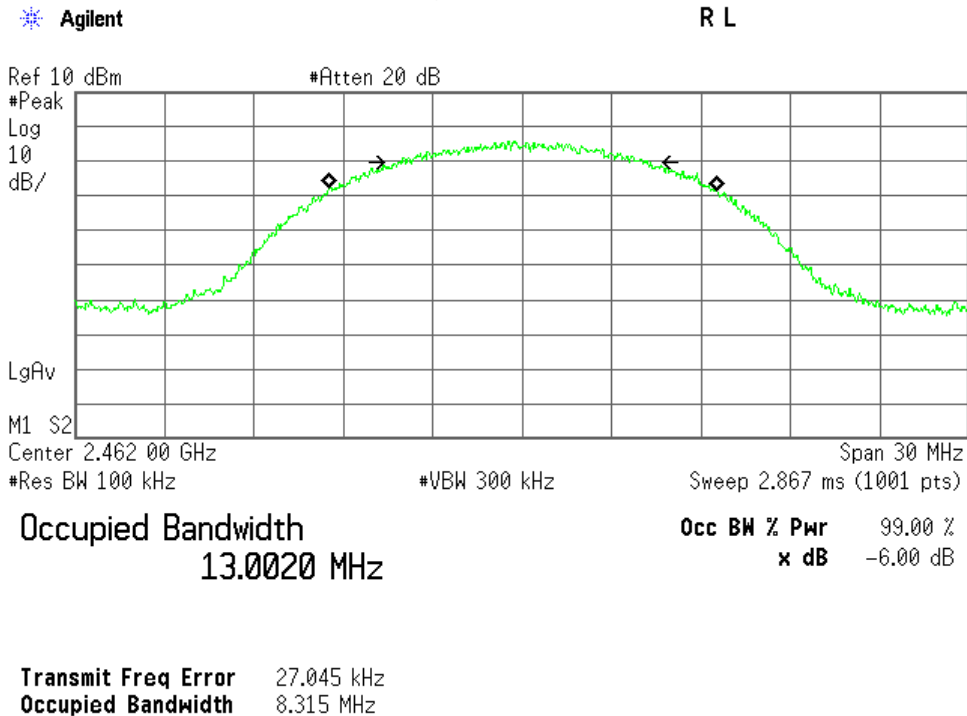

B) IEEE 802.11g

Channel	Frequency (MHz)	99% Bandwidth (MHz)	-6dBc Bandwidth (MHz)	Minimum -6dBc Bandwidth Limit (kHz)
01	2412.0	16.491	16.462	500
06	2437.0	16.503	16.475	500
11	2462.0	16.494	16.490	500

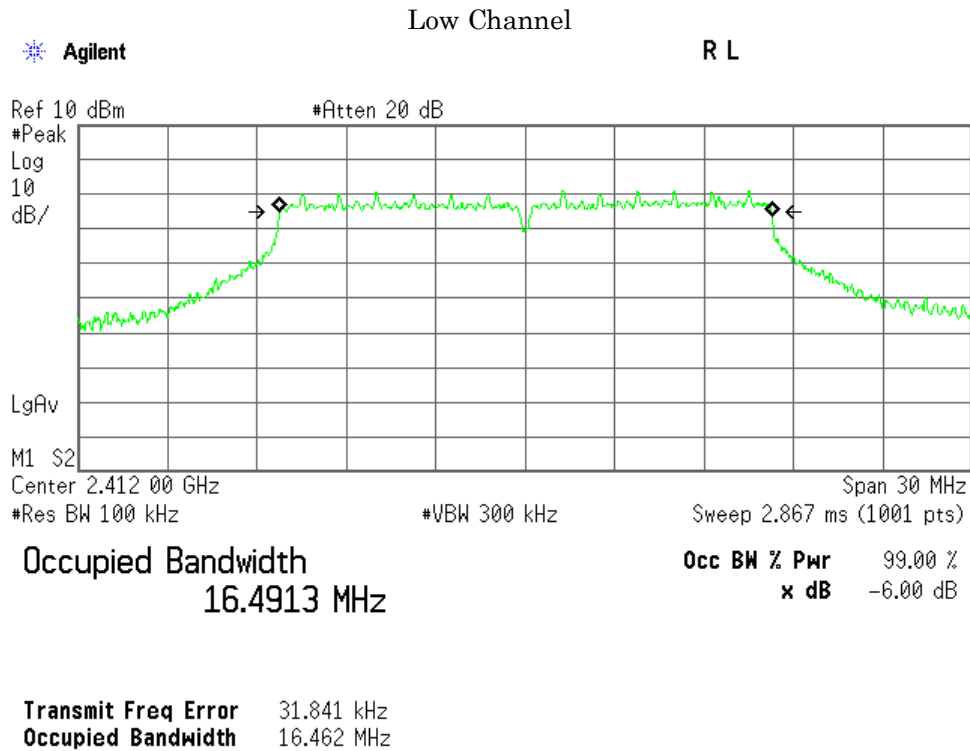

### Middle Channel

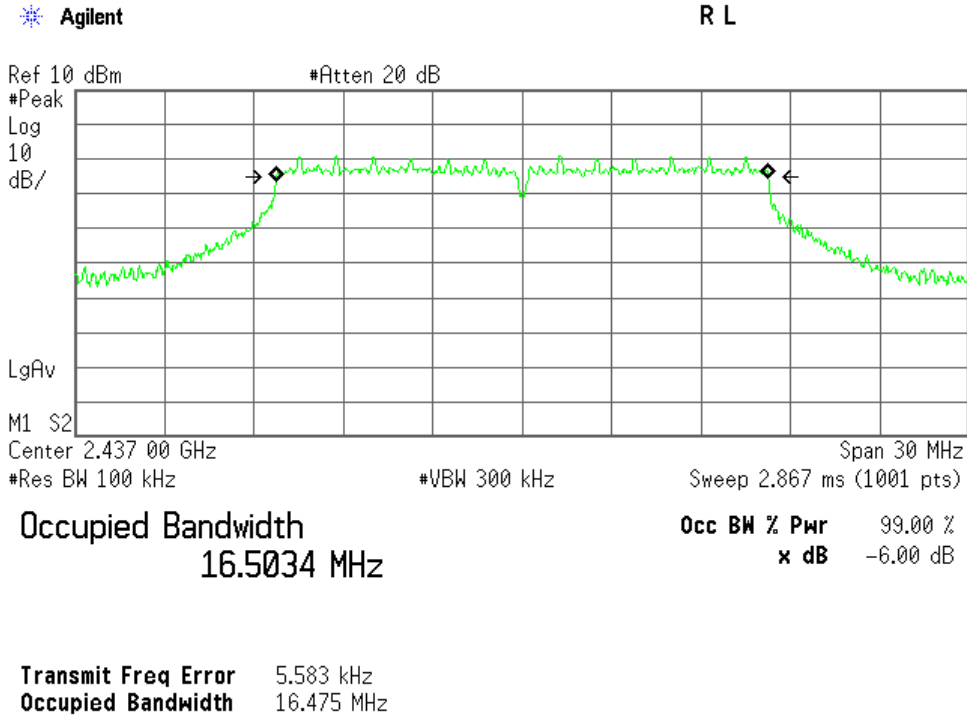

### High Channel

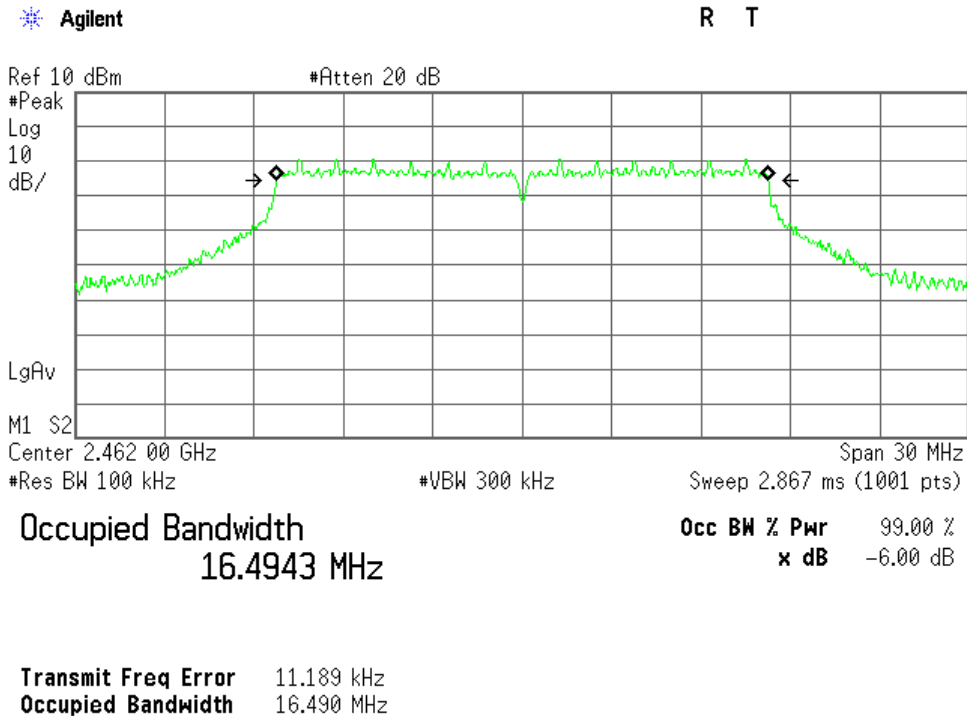

C) IEEE 802.11n

Channel	Frequency (MHz)	99% Bandwidth (MHz)	-6dBc Bandwidth (MHz)	Minimum -6dBc Bandwidth Limit (kHz)
01	2412.0	17.665	17.645	500
06	2437.0	17.673	17.711	500
11	2462.0	17.676	17.731	500

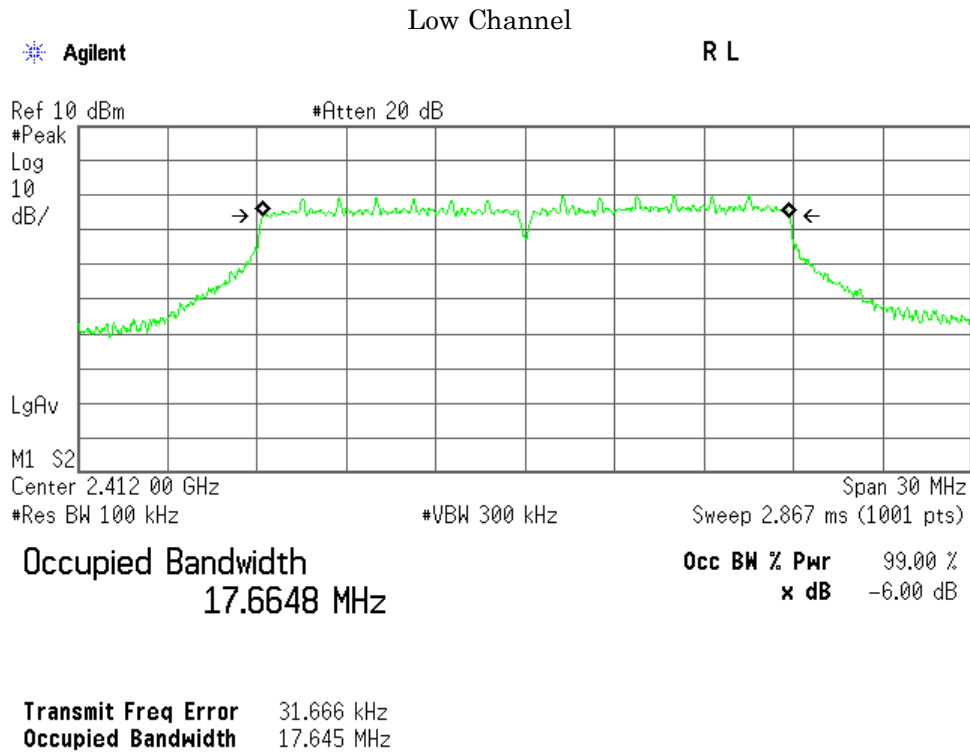



### Middle Channel

Agilent

R L

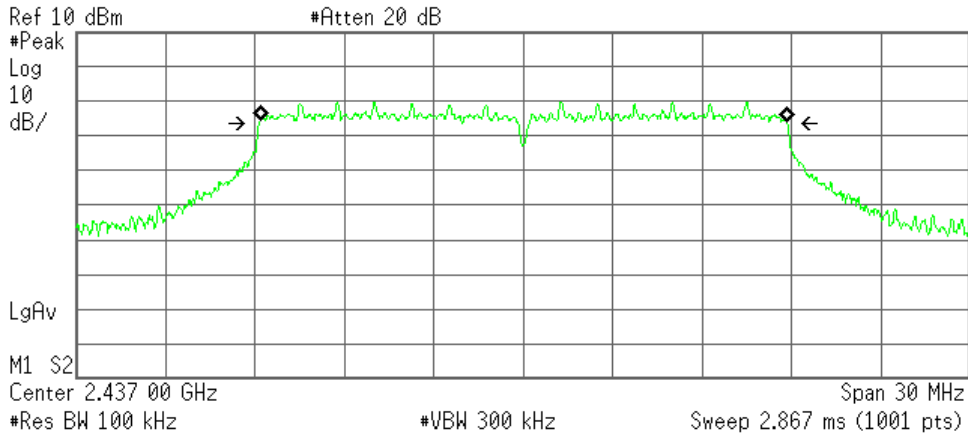

**Occupied Bandwidth**  
17.6727 MHz

**Occ BW % Pwr** 99.00 %  
**x dB** -6.00 dB

**Transmit Freq Error** 6.448 kHz  
**Occupied Bandwidth** 17.711 MHz

### High Channel

Agilent

R T

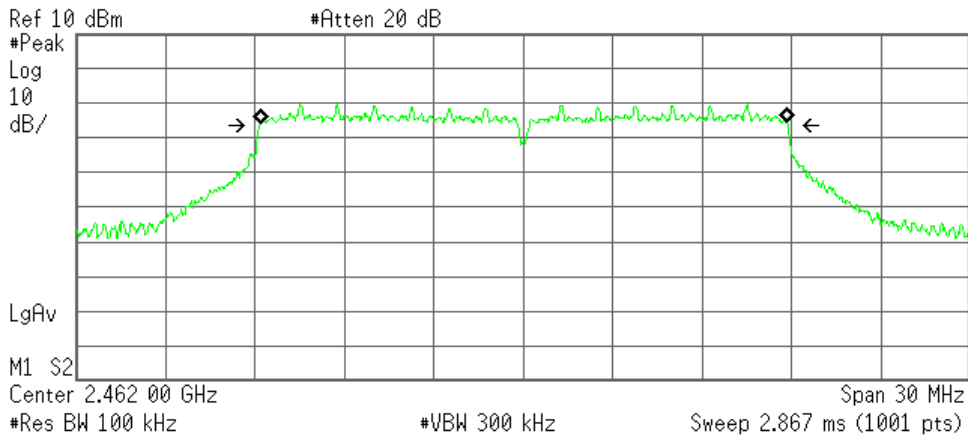

**Occupied Bandwidth**  
17.6763 MHz

**Occ BW % Pwr** 99.00 %  
**x dB** -6.00 dB

**Transmit Freq Error** 9.826 kHz  
**Occupied Bandwidth** 17.731 MHz

Mode of EUT : Bluetooth Low Energy

Test Date : April 13, 2015

Temp.:22°C, Humi:52%

The resolution bandwidth was set to 100 kHz, -6dBc display line was placed on the screen (or 99% bandwidth), the occupied bandwidth is the delta frequency between the two points where the display line intersects the signal trace.

1)Packet Setting : LE (Modulation type : GFSK)

Channel	Frequency (MHz)	99% Bandwidth (kHz)	-6dBc Bandwidth (kHz)	Minimum -6dBc Bandwidth Limit (kHz)
00	2402.0	1089.6	665.9	500
19	2440.0	1088.1	666.5	500
39	2480.0	1089.0	670.5	500

1)Packet Setting : LE (Modulation type : GFSK)

Low Channel

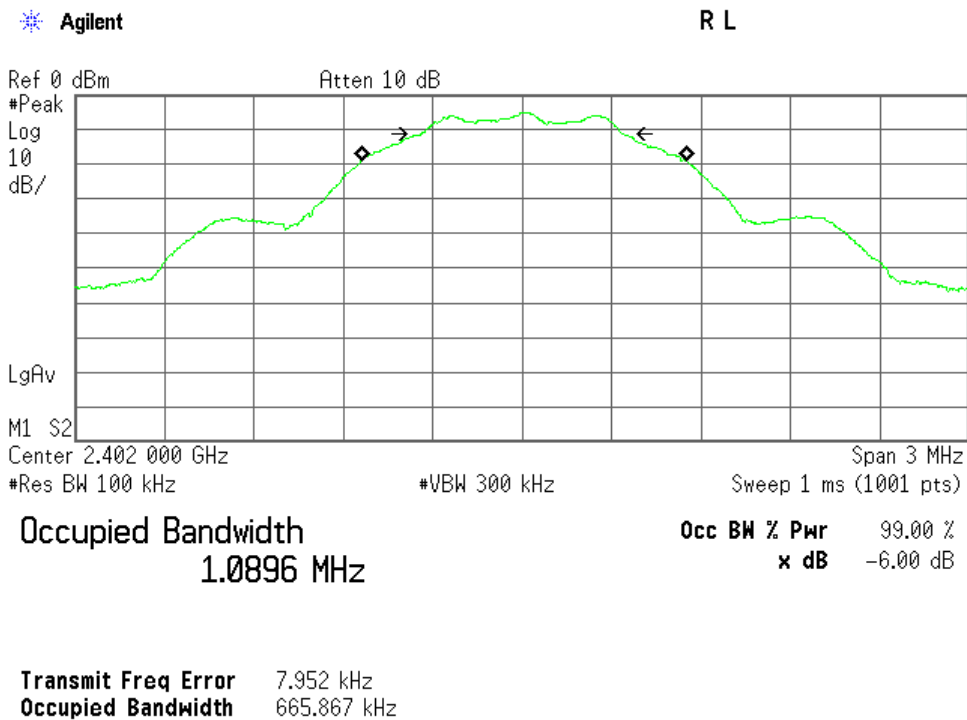

### Middle Channel

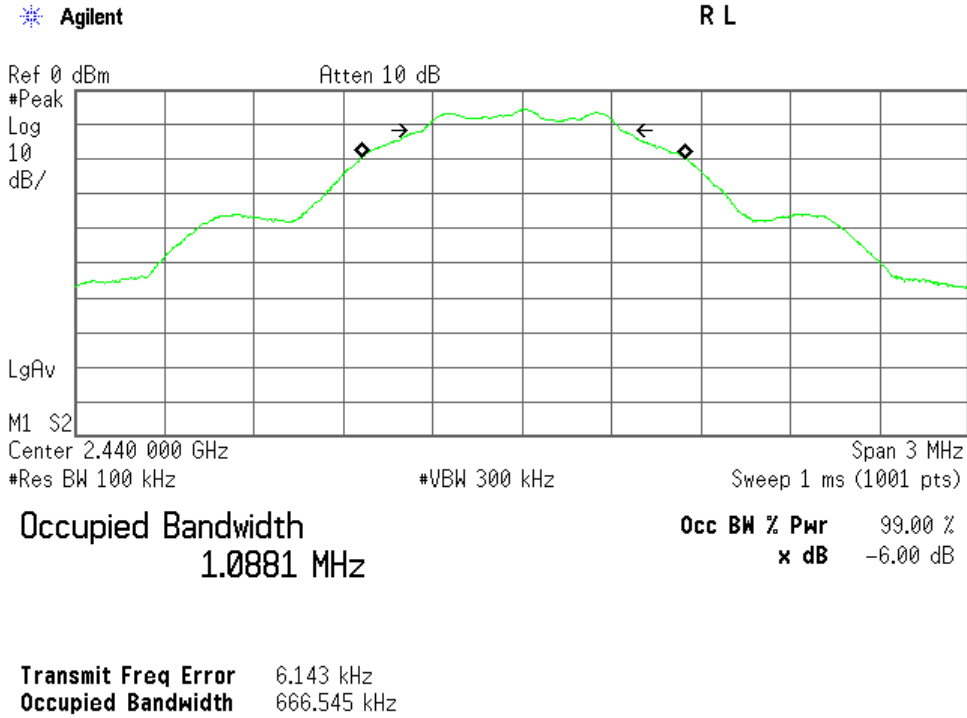

### High Channel

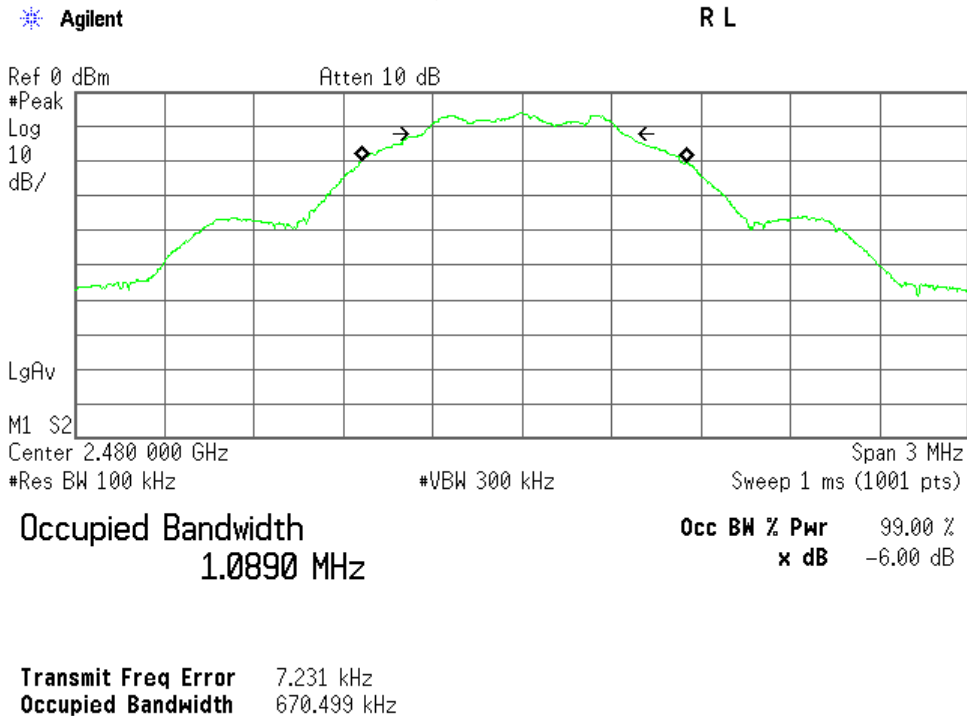

**7.4 Dwell Time**

For the requirements,  - Applicable  - Tested.  - Not tested by applicant request.]  
 - Not Applicable

For the limits,  - Passed  - Failed  - Not judged

**7.5 Peak Output Power(Conduction)**

For the requirements,  - Applicable  - Tested.  - Not tested by applicant request.]  
 - Not Applicable

For the limits,  - Passed  - Failed  - Not judged

**7.5.1 Worst Point and Measurement Uncertainty**

Peak Output Power of IEEE802.11b is	<u>17.21</u>	dBm	at	<u>2437.0/2462.0</u>	MHz
Peak Output Power of IEEE802.11g is	<u>21.08</u>	dBm	at	<u>2412.0</u>	MHz
Peak Output Power of IEEE802.11n is	<u>20.42</u>	dBm	at	<u>2462.0</u>	MHz
Peak Output Power of Bluetooth LE is	<u>5.47</u>	dBm	at	<u>2402.0</u>	MHz

Uncertainty of Measurement Results at Amplitude +/-0.9 dB(2 $\sigma$ )

Remarks : \_\_\_\_\_

**7.5.2 Test Instruments**

Shielded Room S4					
Type	Model	Manufacturer	ID No.	Last Cal.	Interval
Power Meter	N1911A	Agilent	B-63	2014/7	1 Year
Power Sensor	N1921A	Agilent	B-64	2014/7	1 Year
Attenuator	54A-10	Weinschel	D-28	2014/9	1 Year
RF Cable	SUCOFLEX102	SUHNER	C-52	2014/8	1 Year

**7.5.3 Test Method and Test Setup (Diagrammatic illustration)**

The Conducted RF Power Output was measured with a power meter, one 10dB attenuator and a short, low loss cable.

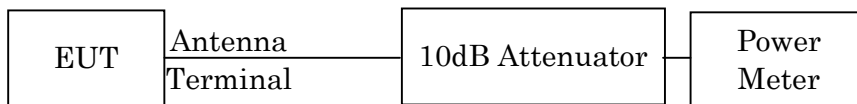

**7.5.4 Test Data**

1) IEEE 802.11b

Data Rate : 11Mbps

Test Date: April 10, 2015  
 Temp.: 21 °C, Humi: 60 %

CH	Transmitting Frequency [MHz]	Correction Factor [dB]	Meter Reading [dBm]	Conducted		Limits [dBm]	Margin [dB]
				Peak Output Power [dBm]	[mW]		
01	2412	10.34	6.79	17.13	51.64	30.00	+12.87
06	2437	10.34	6.87	17.21	52.60	30.00	+12.79
11	2462	10.35	6.86	17.21	52.60	30.00	+12.79

Calculated result at 2437.000 MHz, as the worst point shown on underline:

Correction Factor	=	10.34 dB
+ ) Meter Reading	=	6.87 dBm
Result	=	17.21 dBm = 52.60 mW

Minimum Margin: 30.00 - 17.21 = 12.79 (dB)

NOTES

- The correction factor shows the attenuation pad loss including the short, low loss cable or adapter.
- Setting of measuring instrument(s) :

Detector Function	Video B.W.
Peak	OFF

CH	[MHz]	Rate	Meter Reading [dBm]	Remark
06	2437			
		1Mbps	6.84	
		2Mbps	6.80	
		5.5Mbps	6.83	
		11Mbps	6.87	*

\* : Worst Rate

All comparison were performed on the same measurement condition.

2) IEEE 802.11g

Test Date: April 10, 2015  
Temp.: 21 °C, Humi: 60 %

Data Rate : 18Mbps

CH	Transmitting Frequency [MHz]	Correction Factor [dB]	Meter Reading [dBm]	Conducted Peak Output Power		Limits [dBm]	Margin [dB]
				[dBm]	[mW]		
01	2412	10.34	10.74	21.08	128.23	30.00	+ 8.92
06	2437	10.34	10.72	21.06	127.64	30.00	+ 8.94
11	2462	10.35	10.61	20.96	124.74	30.00	+ 9.04

Calculated result at 2412.000 MHz, as the worst point shown on underline:

Correction Factor	=	10.34 dB
+ ) Meter Reading	=	10.74 dBm
Result	=	21.08 dBm = 128.23 mW

Minimum Margin: 30.00 - 21.08 = 8.92 (dB)

NOTES

- The correction factor shows the attenuation pad loss including the short, low loss cable or adapter.
- Setting of measuring instrument(s) :

Detector Function	Video B.W.
Peak	OFF

CH	[MHz]	Rate	Meter Reading [dBm]	Remark
06	2437			
		6Mbps	10.54	
		9Mbps	10.53	
		12Mbps	10.46	
		18Mbps	10.72	*
		24Mbps	10.63	
		36Mbps	10.47	
		48Mbps	10.68	
		54Mbps	10.61	

\* : Worst Rate

All comparison were performed on the same measurement condition.

3) IEEE 802.11n

Data Rate : MCS1(13Mbps)

Test Date: April 10, 2015  
 Temp.: 21 °C, Humi: 60 %

CH	Transmitting Frequency [MHz]	Correction Factor [dB]	Meter Reading [dBm]	Conducted Peak Output Power		Limits [dBm]	Margin [dB]
				[dBm]	[mW]		
01	2412	10.34	9.96	20.30	107.15	30.00	+ 9.70
06	2437	10.34	10.02	20.36	108.64	30.00	+ 9.64
11	2462	10.35	10.07	20.42	110.15	30.00	+ 9.58

Calculated result at 2462.000 MHz, as the worst point shown on underline:

Correction Factor	=	10.35 dB
+ ) Meter Reading	=	10.07 dBm
Result	=	20.42 dBm = 110.15 mW

Minimum Margin: 30.00 - 20.42 = 9.58 (dB)

NOTES

- The correction factor shows the attenuation pad loss including the short, low loss cable or adapter.
- Setting of measuring instrument(s) :

Detector Function	Video B.W.
Peak	OFF

CH	[MHz]	Rate	Meter Reading [dBm]	Remark
06	2437			
		MCS0 ( 6.5Mbps )	9.80	
		MCS1 ( 13Mbps )	10.02	*
		MCS2 ( 19.5Mbps )	9.98	
		MCS3 ( 26Mbps )	9.89	
		MCS4 ( 39Mbps )	9.98	
		MCS5 ( 52Mbps )	10.01	
		MCS6 ( 58.5Mbps )	9.91	
		MCS7 ( 65Mbps )	9.97	

\* : Worst Rate

All comparison were performed on the same measurement condition.



4) Bluetooth LE(Modulation type : GFSK)

Test Date: April 13, 2015  
Temp.: 22 °C, Humi: 52 %

Transmitting Frequency		Correction Factor [dB]	Meter Reading [dBm]	Conducted Peak Output Power		Limits [dBm]	Margin [dB]
CH	[MHz]			[dBm]	[mW]		
00	2402	10.34	-4.87	5.47	3.52	30.00	+24.53
19	2440	10.35	-5.51	4.84	3.05	30.00	+25.16
39	2480	10.36	-5.73	4.63	2.90	30.00	+25.37

Calculated result at 2402.000 MHz, as the worst point shown on underline:

Correction Factor	=	10.34 dB
+ ) Meter Reading	=	-4.87 dBm
Result	=	5.47 dBm = 3.52 mW

Minimum Margin: 30.00 - 5.47 = 24.53 (dB)

NOTES

- The correction factor shows the attenuation pad loss including the short, low loss cable or adapter.
- Setting of measuring instrument(s) :

Detector Function	Video B.W.
Peak	Off

**7.6 Peak Power Density(Conduction)**

For the requirements,  - Applicable  - Tested.  - Not tested by applicant request.]  
 - Not Applicable

For the limits,  - Passed  - Failed  - Not judged

**7.6.1 Worst Point and Measurement Uncertainty**

Peak Power Density of IEEE802.11b is 2.23 dBm at 2462.0 MHz  
 Peak Power Density of IEEE802.11g is -3.02 dBm at 2437.0 MHz  
 Peak Power Density of IEEE802.11n is -4.71 dBm at 2437.0 MHz  
 Peak Power Density of Bluetooth LE is 2.22 dBm at 2402.0 MHz

Uncertainty of Measurement Results at Amplitude +/-1.7 dB(2σ)

Remarks : \_\_\_\_\_

**7.6.2 Test Instruments**

Shielded Room S4					
Type	Model	Manufacturer	ID No.	Last Cal.	Interval
Spectrum Analyzer	E4446A	Agilent	A-39	2014/9	1 Year
Attenuator	54A-10	Weinschel	D-28	2014/9	1 Year
RF Cable	SUCOFLEX102	SUHNER	C-52	2014/8	1 Year

**7.6.3 Test Method and Test Setup (Diagrammatic illustration)**

The Conducted RF Power Output was measured with a power meter, one 10dB attenuator and a short, low loss cable.

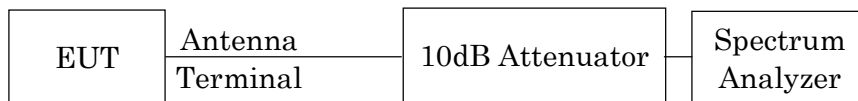

## 7.6.4 Test Data

### 1) IEEE 802.11b

Test Date: April 11, 2015  
 Temp.: 21 °C, Humi: 48 %

Data Rate : 11Mbps

CH	Transmitting Frequency [MHz]	Correction Factor [dB]	Meter Reading [dBm]	Conducted		Limits [dBm]	Margin [dB]
				Peak Power Density [dBm]	[mW]		
01	2412	10.34	-8.34	2.00	1.58	8.00	+ 6.00
06	2437	10.34	-8.76	1.58	1.44	8.00	+ 6.42
11	2462	10.35	-8.12	2.23	1.67	8.00	+ 5.77

Calculated result at 2462.000 MHz, as the worst point shown on underline:

Correction Factor	=	10.35 dB
+ ) Meter Reading	=	-8.12 dBm
Result	=	2.23 dBm = 1.67 mW

Minimum Margin: 8.00 - 2.23 = 5.77 (dB)

#### NOTES

- The peak power density complied with the limit using 30 kHz resolution bandwidth of Spectrum Analyzer.
- The correction factor shows the attenuation pad loss including the short, low loss cable or adapter.
- Setting of measuring instrument(s) :

Detector Function	RES B.W.	Video B.W.
Peak	30kHz	100kHz

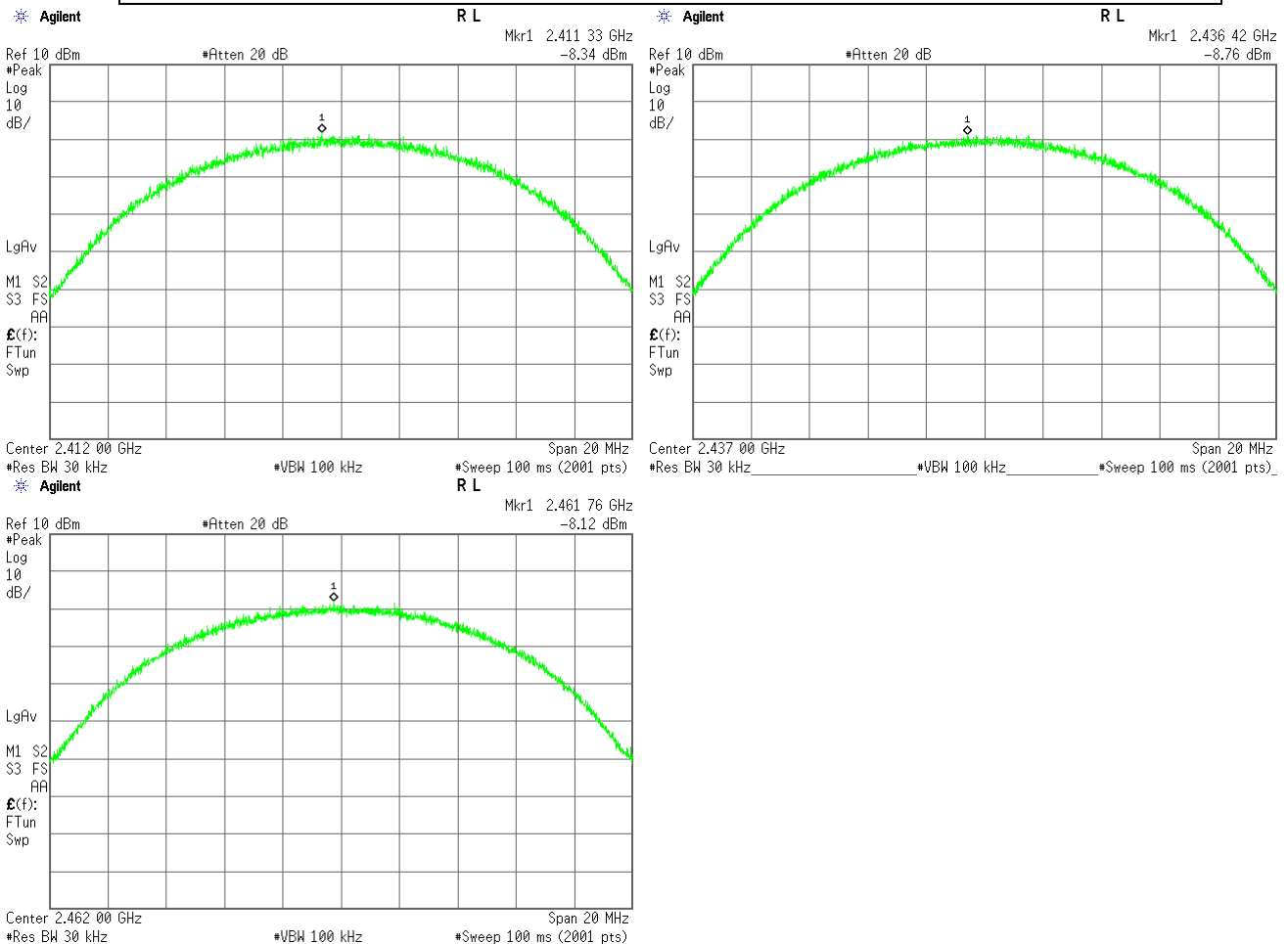

2) IEEE 802.11g

Test Date: April 11, 2015  
 Temp.: 21 °C, Humi: 48 %

Data Rate : 18Mbps

CH	Transmitting Frequency [MHz]	Correction Factor [dB]	Meter Reading [dBm]	Conducted Peak Power Density [dBm]	Conducted Peak Power Density [mW]	Limits [dBm]	Margin [dB]
01	2412	10.34	-14.27	-3.93	0.40	8.00	+11.93
06	2437	10.34	-13.36	-3.02	0.50	8.00	+11.02
11	2462	10.35	-14.04	-3.69	0.43	8.00	+11.69

Calculated result at 2437.000 MHz, as the worst point shown on underline:

Correction Factor	=	10.34 dB
+ ) Meter Reading	=	-13.36 dBm
Result	=	-3.02 dBm = 0.50 mW

Minimum Margin: 8.00 - -3.02 = 11.02 (dB)

NOTES

1. The peak power density complied with the limit using 30 kHz resolution bandwidth of Spectrum Analyzer.
2. The correction factor shows the attenuation pad loss including the short, low loss cable or adapter.
3. Setting of measuring instrument(s) :

Detector Function	RES B.W.	Video B.W.
Peak	30kHz	100kHz

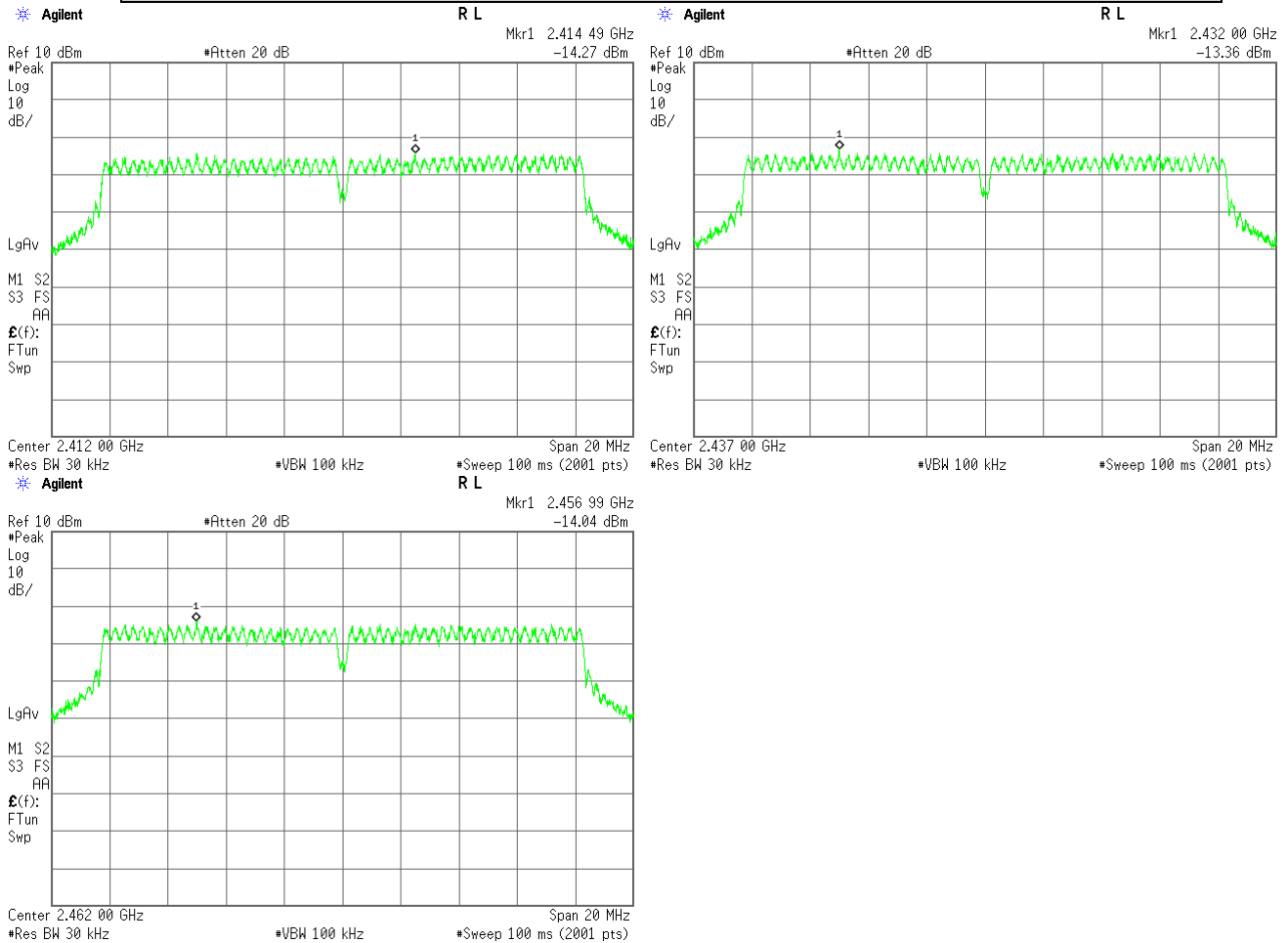

3) IEEE 802.11n

Test Date: April 11, 2015  
 Temp.: 21 °C, Humi: 48 %

Data Rate : MCS1(13Mbps)

CH	Transmitting Frequency [MHz]	Correction Factor [dB]	Meter Reading [dBm]	Conducted Peak Power Density [dBm]	Conducted Peak Power Density [mW]	Limits [dBm]	Margin [dB]
01	2412	10.34	-15.16	-4.82	0.33	8.00	+12.82
06	2437	10.34	-15.05	-4.71	0.34	8.00	+12.71
11	2462	10.35	-15.76	-5.41	0.29	8.00	+13.41

Calculated result at 2437.000 MHz, as the worst point shown on underline:

Correction Factor	=	10.34 dB
+ ) Meter Reading	=	-15.05 dBm
Result	=	-4.71 dBm = 0.34 mW

Minimum Margin: 8.00 - -4.71 = 12.71 (dB)

NOTES

- The peak power density complied with the limit using 30 kHz resolution bandwidth of Spectrum Analyzer.
- The correction factor shows the attenuation pad loss including the short, low loss cable or adapter.
- Setting of measuring instrument(s) :

Detector Function	RES B.W.	Video B.W.
Peak	30kHz	100kHz

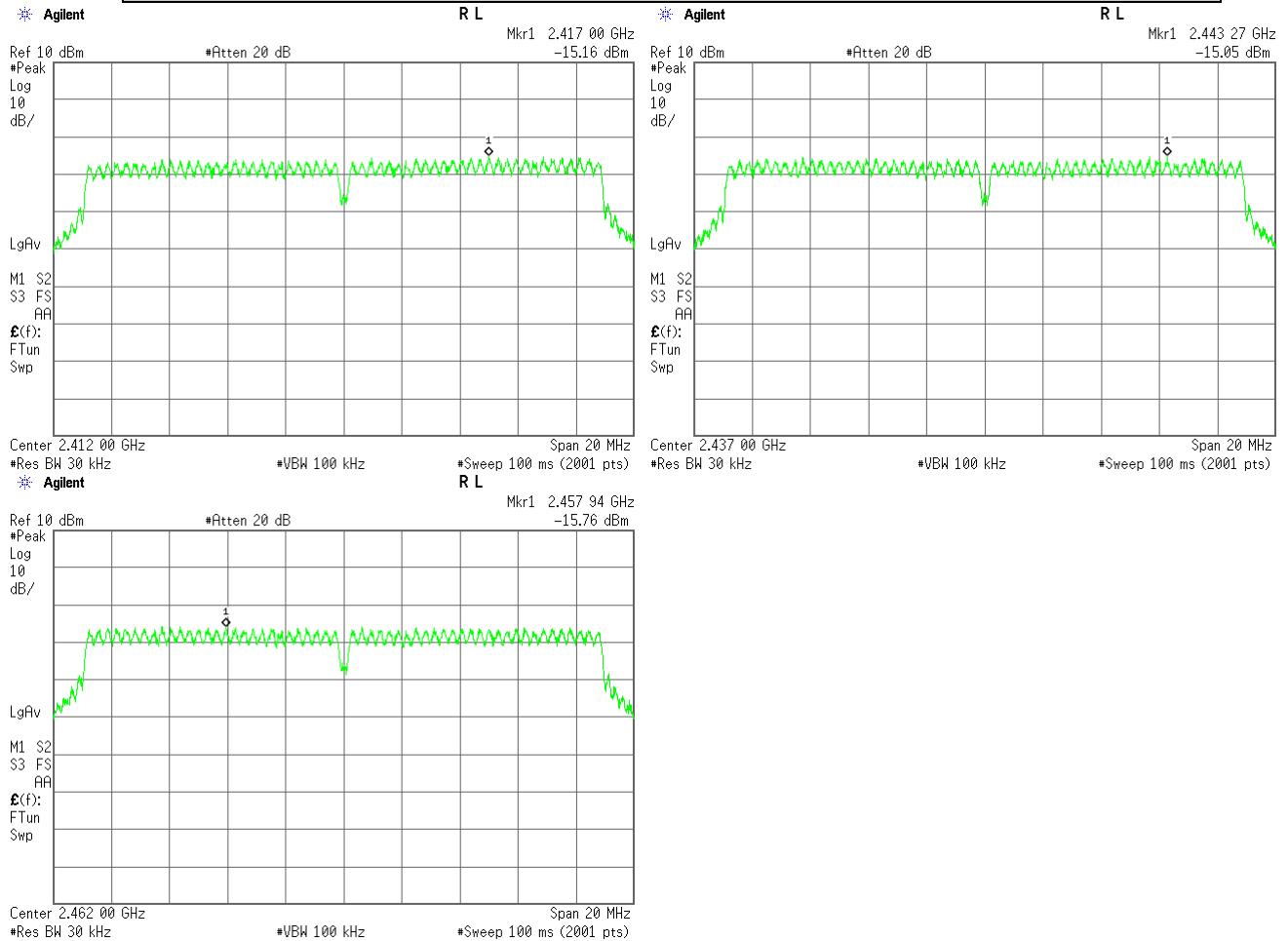

4) Bluetooth LE(Modulation type : GFSK)

Test Date: April 13, 2015  
 Temp.: 22 °C, Humi: 52 %

CH	Transmitting Frequency [MHz]	Correction Factor [dB]	Meter Reading [dBm]	Conducted Peak Power Density		Limits [dBm]	Margin [dB]
				[dBm]	[mW]		
00	2402	10.34	-8.12	2.22	1.67	8.00	+ 5.78
19	2440	10.35	-8.80	1.55	1.43	8.00	+ 6.45
39	2480	10.36	-8.97	1.39	1.38	8.00	+ 6.61

Calculated result at 2402.000 MHz, as the worst point shown on underline:

Correction Factor	=	10.34 dB
+ ) Meter Reading	=	-8.12 dBm
Result	=	2.22 dBm = 1.67 mW

Minimum Margin: 8.00 - 2.22 = 5.78 (dB)

NOTES

1. The peak power density complied with the limit using 30 kHz resolution bandwidth of Spectrum Analyzer.
2. The correction factor shows the attenuation pad loss including the short, low loss cable or adapter.
3. Setting of measuring instrument(s) :

Detector Function	RES B.W.	Video B.W.
Peak	30kHz	100kHz

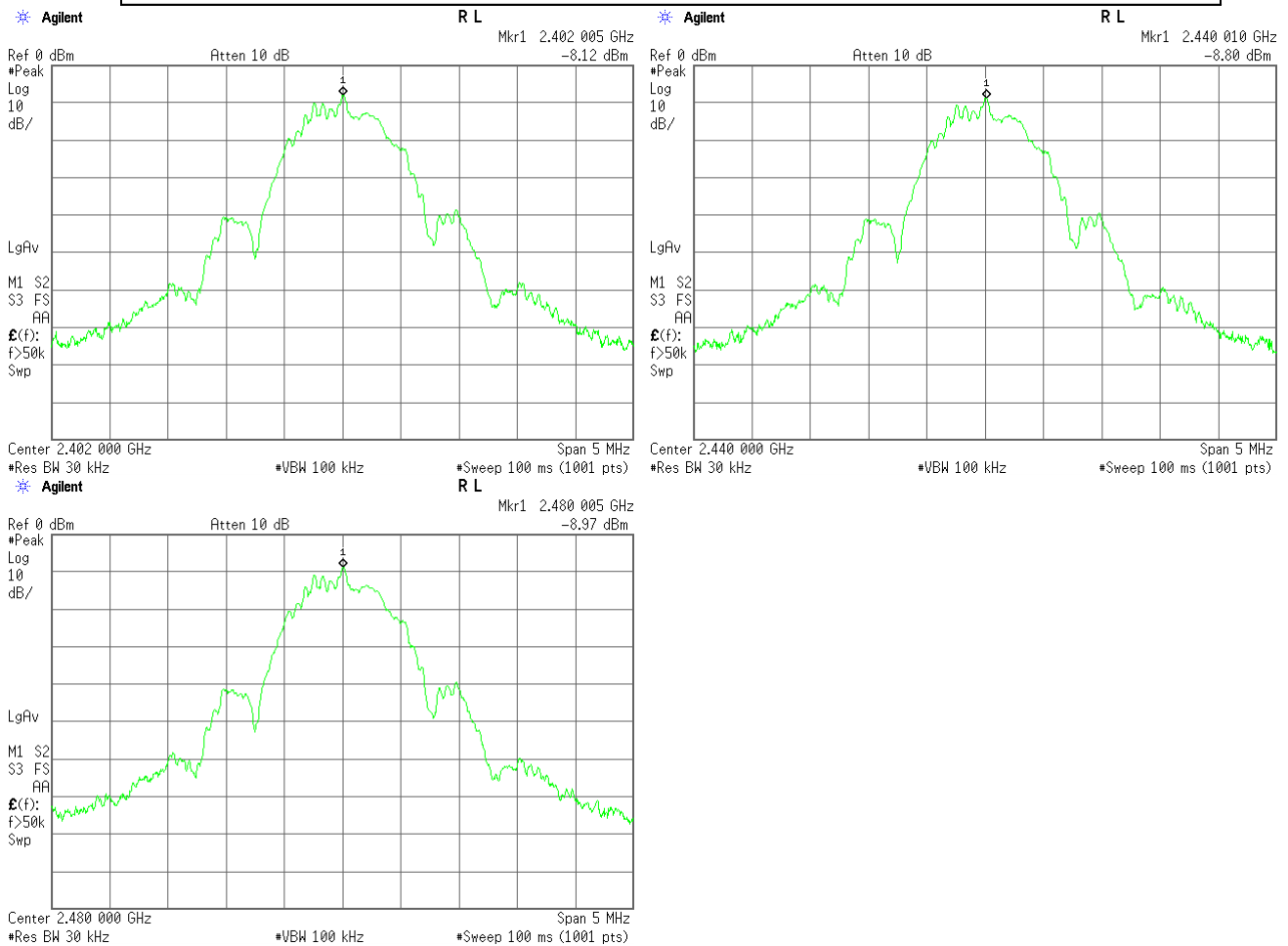

**7.7 Spurious Emissions(Conduction)**

For the requirements,  - Applicable  - Tested.  - Not tested by applicant request.]  
 - Not Applicable

For the limits,  - Passed  - Failed  - Not judged

**7.7.1 Worst Point and Measurement Uncertainty**

Uncertainty of Measurement Results

9 kHz – 1GHz	<u>+/-1.4</u>	dB(2σ)
1GHz – 18GHz	<u>+/-1.7</u>	dB(2σ)
18GHz – 40GHz	<u>+/-2.3</u>	dB(2σ)

Remarks : \_\_\_\_\_

**7.7.2 Test Instruments**

Shielded Room S4					
Type	Model	Manufacturer	ID No.	Last Cal.	Interval
Spectrum Analyzer	E4446A	Agilent	A-39	2014/9	1 Year
Attenuator	54A-10	Weinschel	D-28	2014/9	1 Year
RF Cable	SUCOFLEX102	SUHNER	C-52	2014/8	1 Year

**7.7.3 Test Method and Test Setup (Diagrammatic illustration)**

The test system is shown as follows:

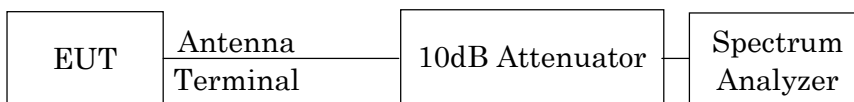

The setting of the spectrum analyzer are shown as follows:

Frequency Range	30 MHz - 25 GHz	Band-Edge
Res. Bandwidth	100 kHz	100 kHz
Video Bandwidth	300 kHz	300 kHz
Sweep Time	AUTO	AUTO
Trace	Maxhold	Maxhold

## 7.7.4 Test Data

Test Date : April 11, 2015

Temp.:21°C, Humi:48%

### 1) IEEE 802.11b

#### Low Channel

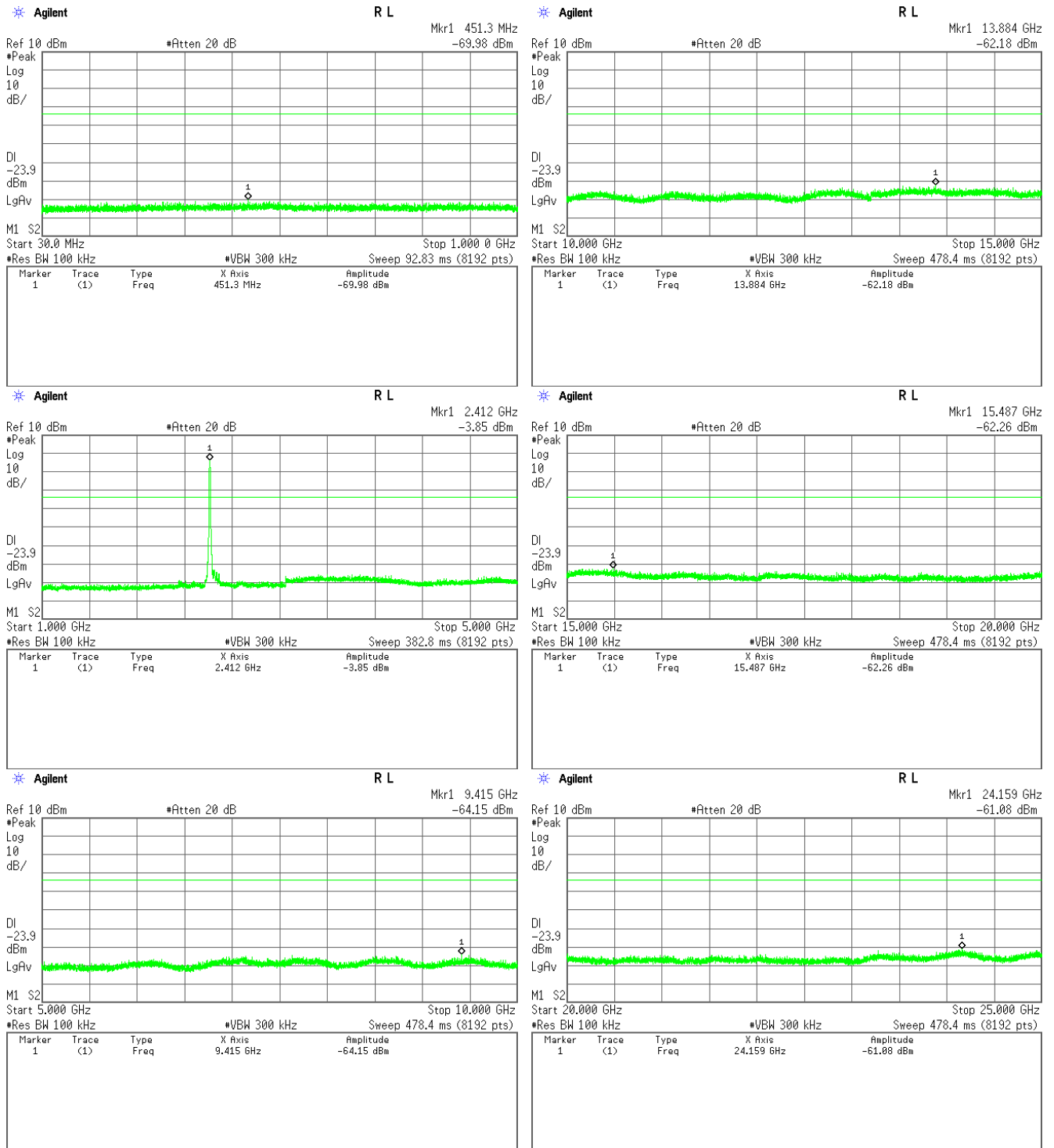



## Middle Channel

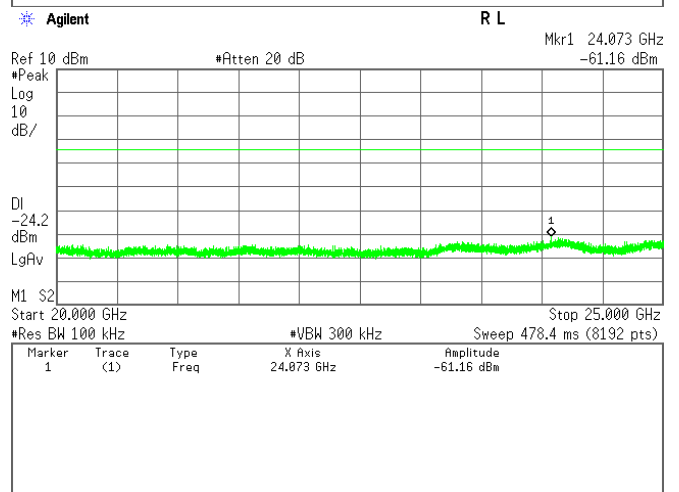
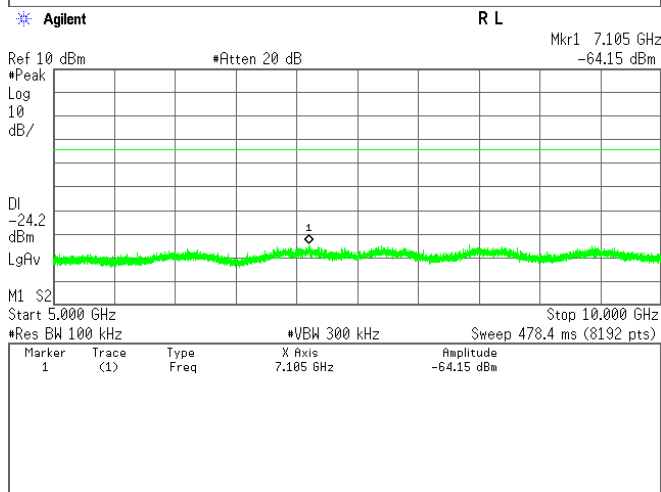
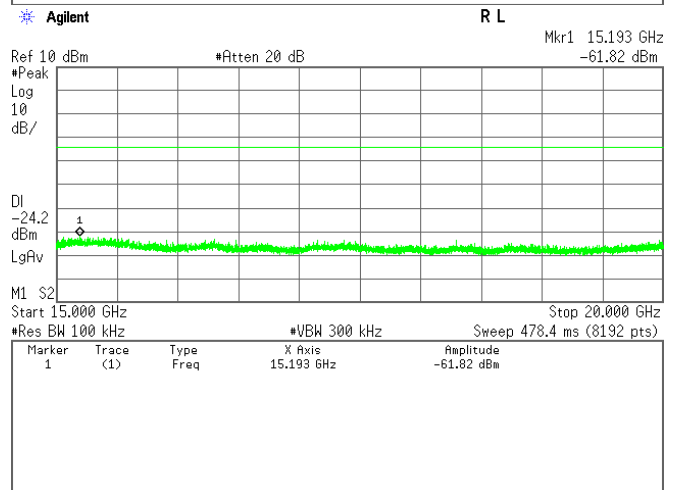
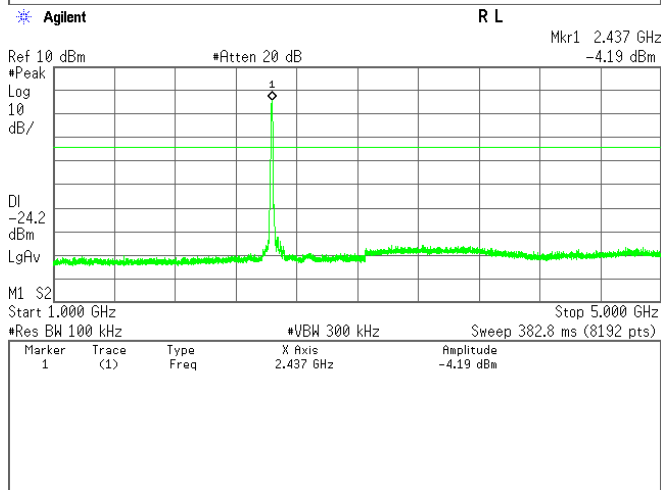
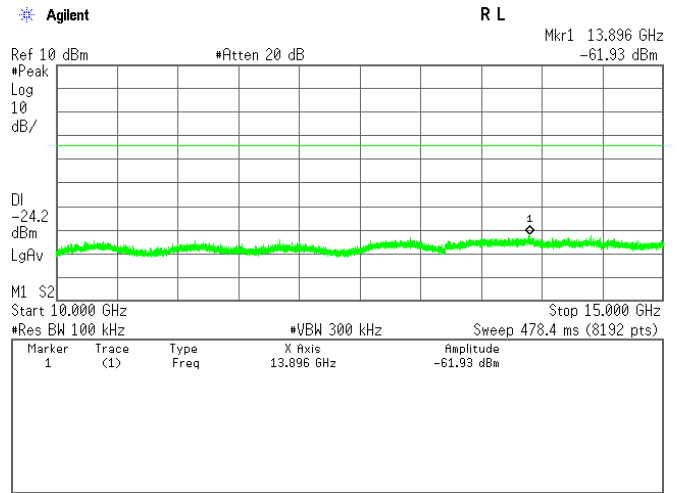
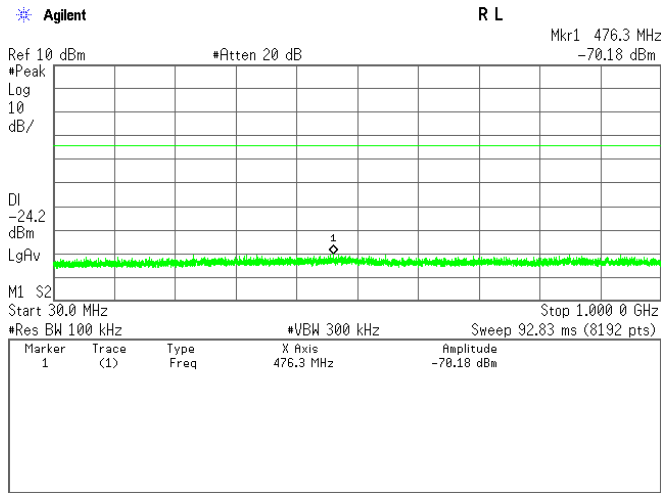

## High Channel

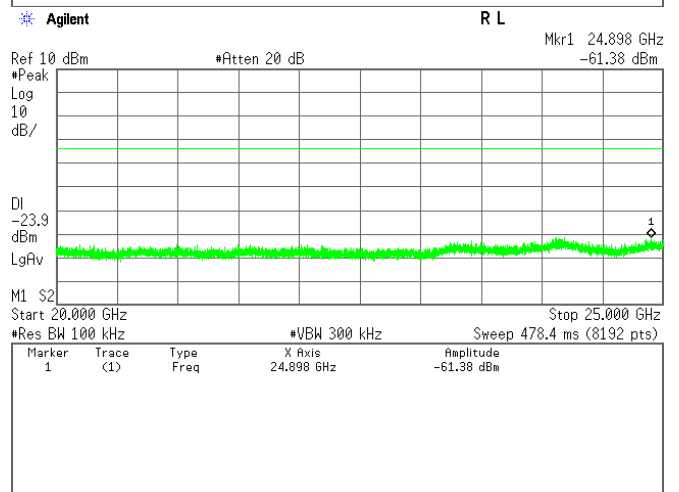
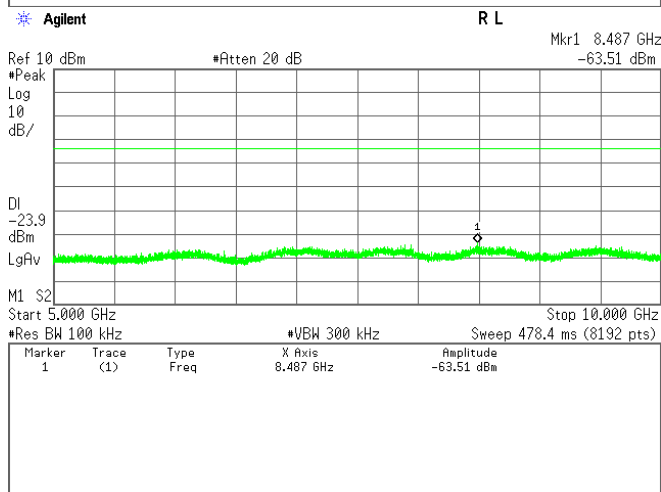
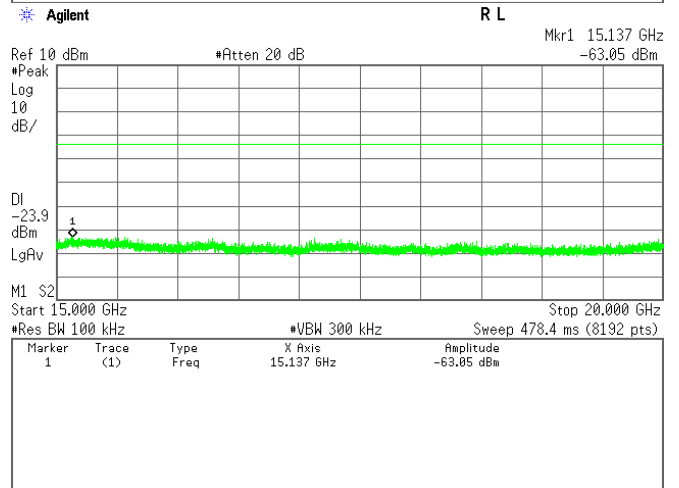
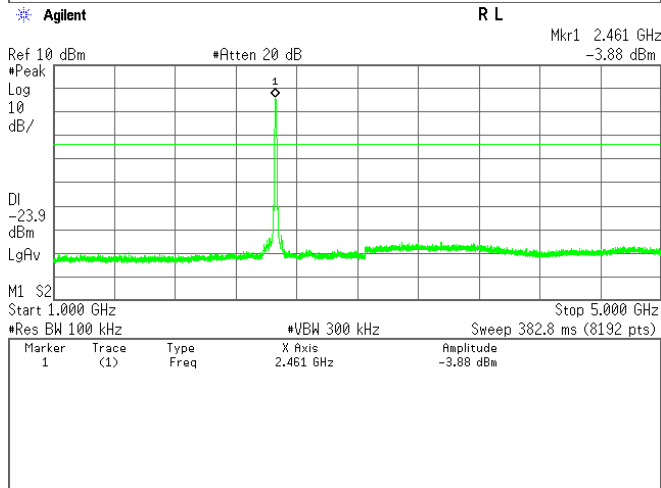
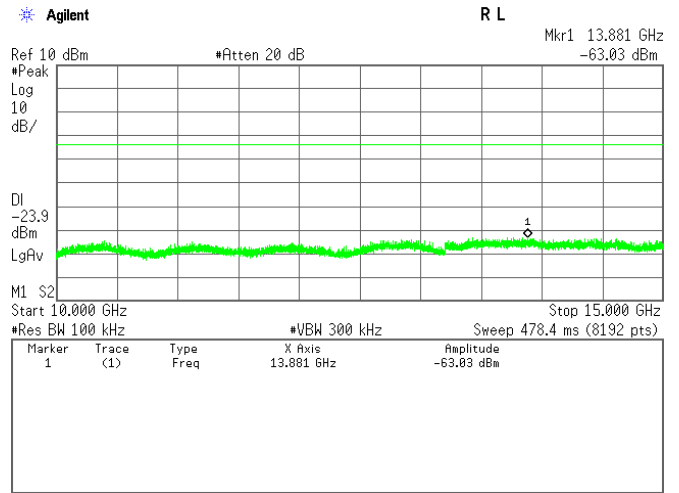
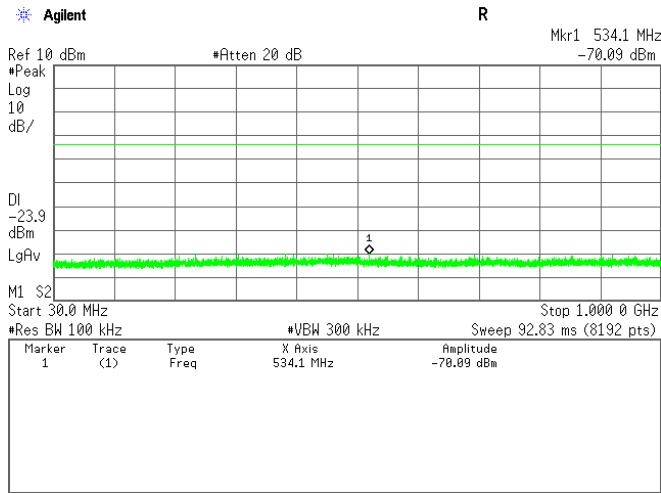

2) IEEE 802.11g

Low Channel

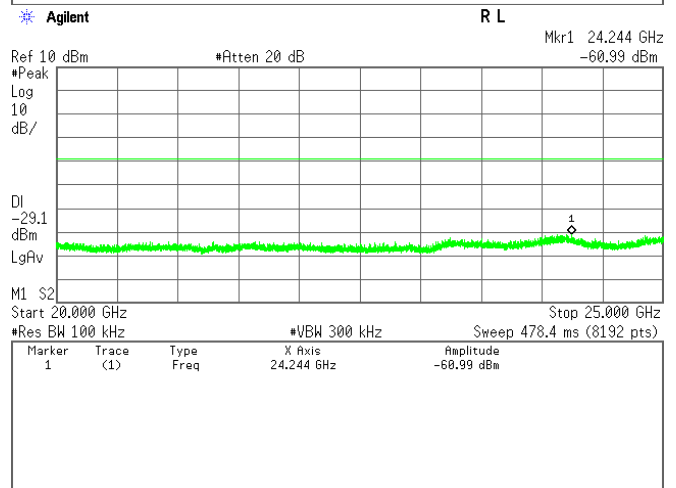
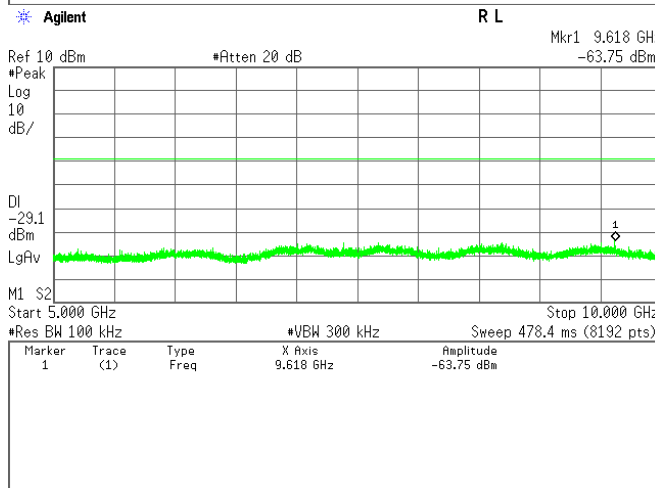
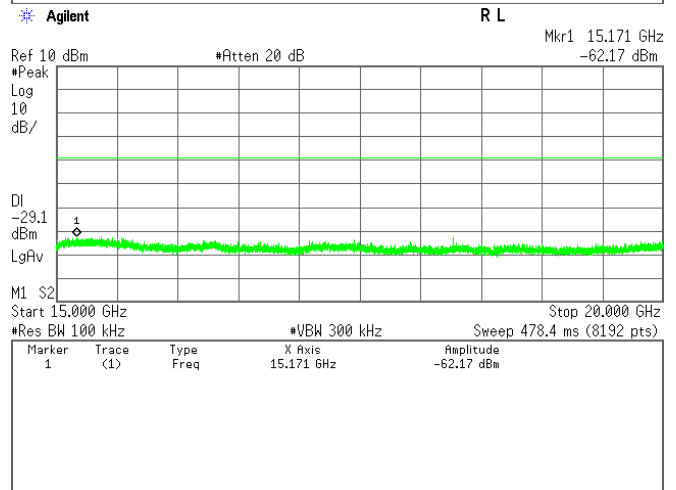
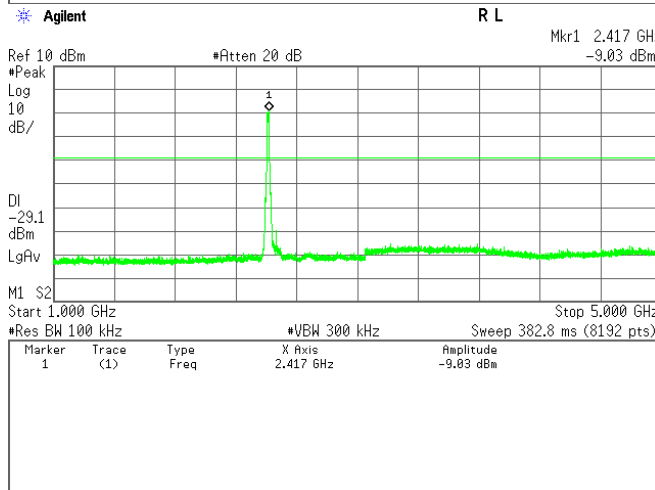
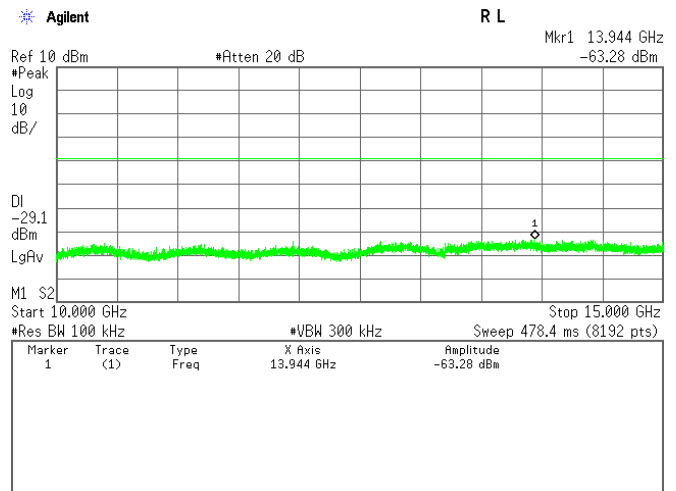
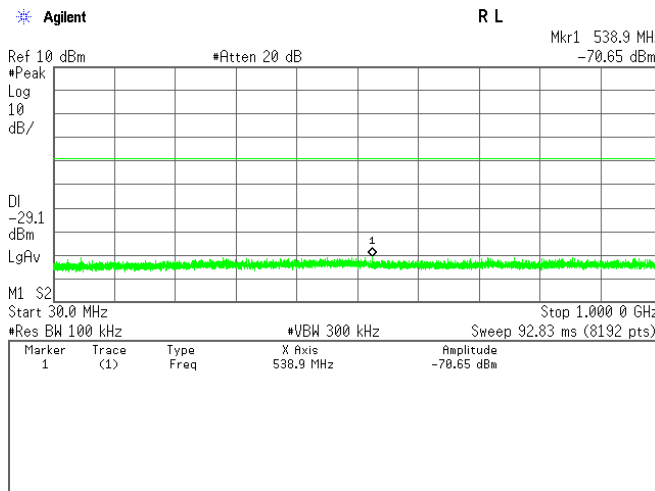

## Middle channel

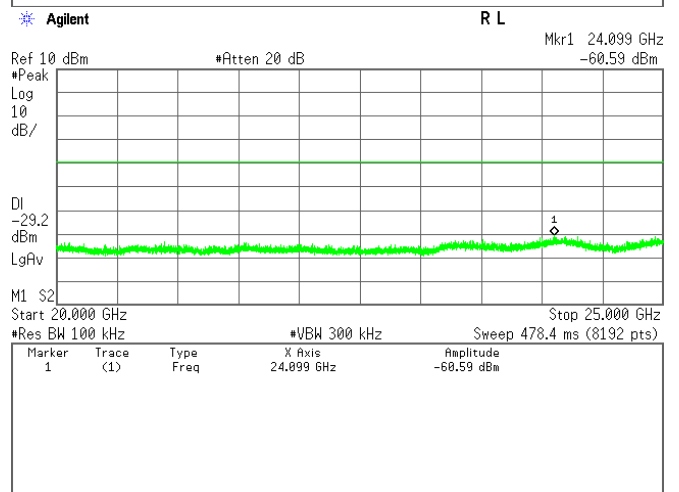
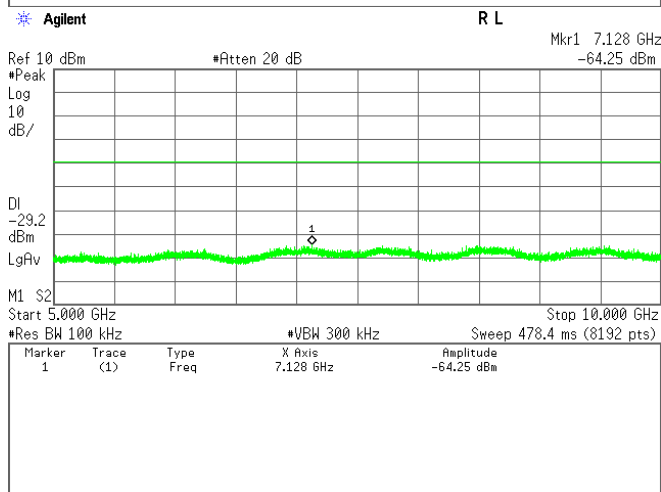
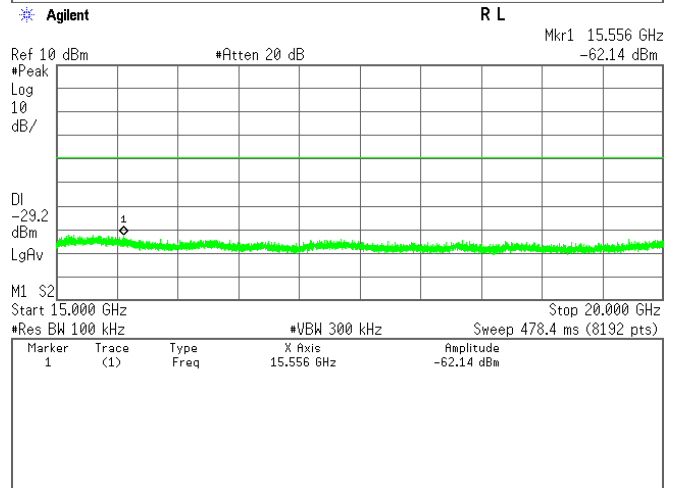
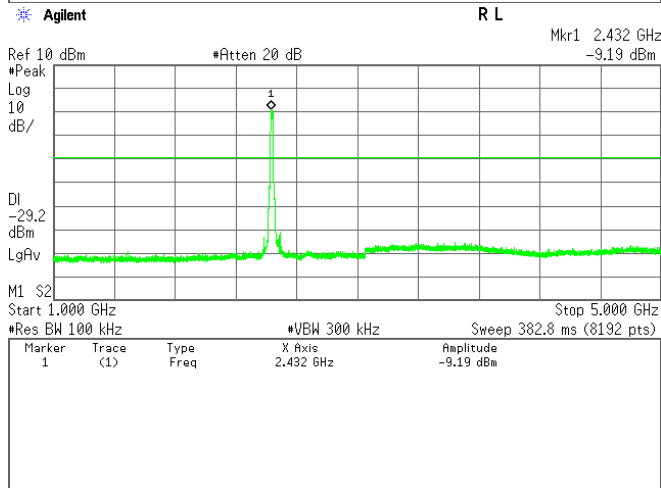
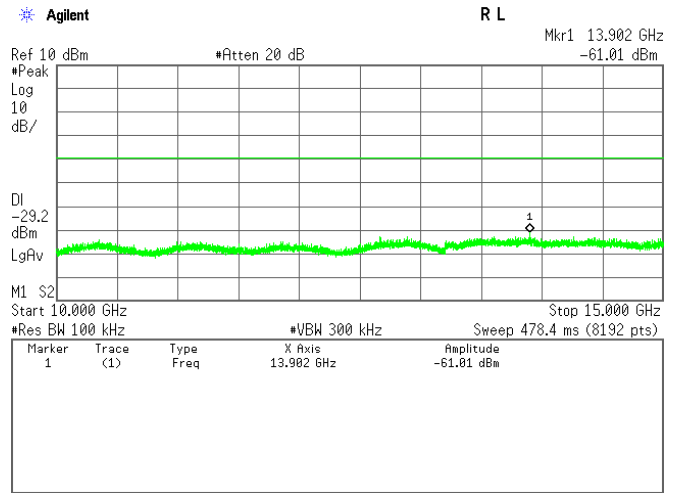
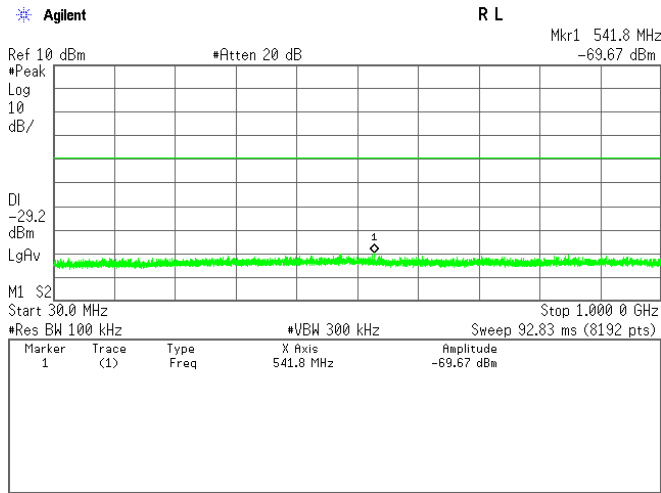

## High Channel

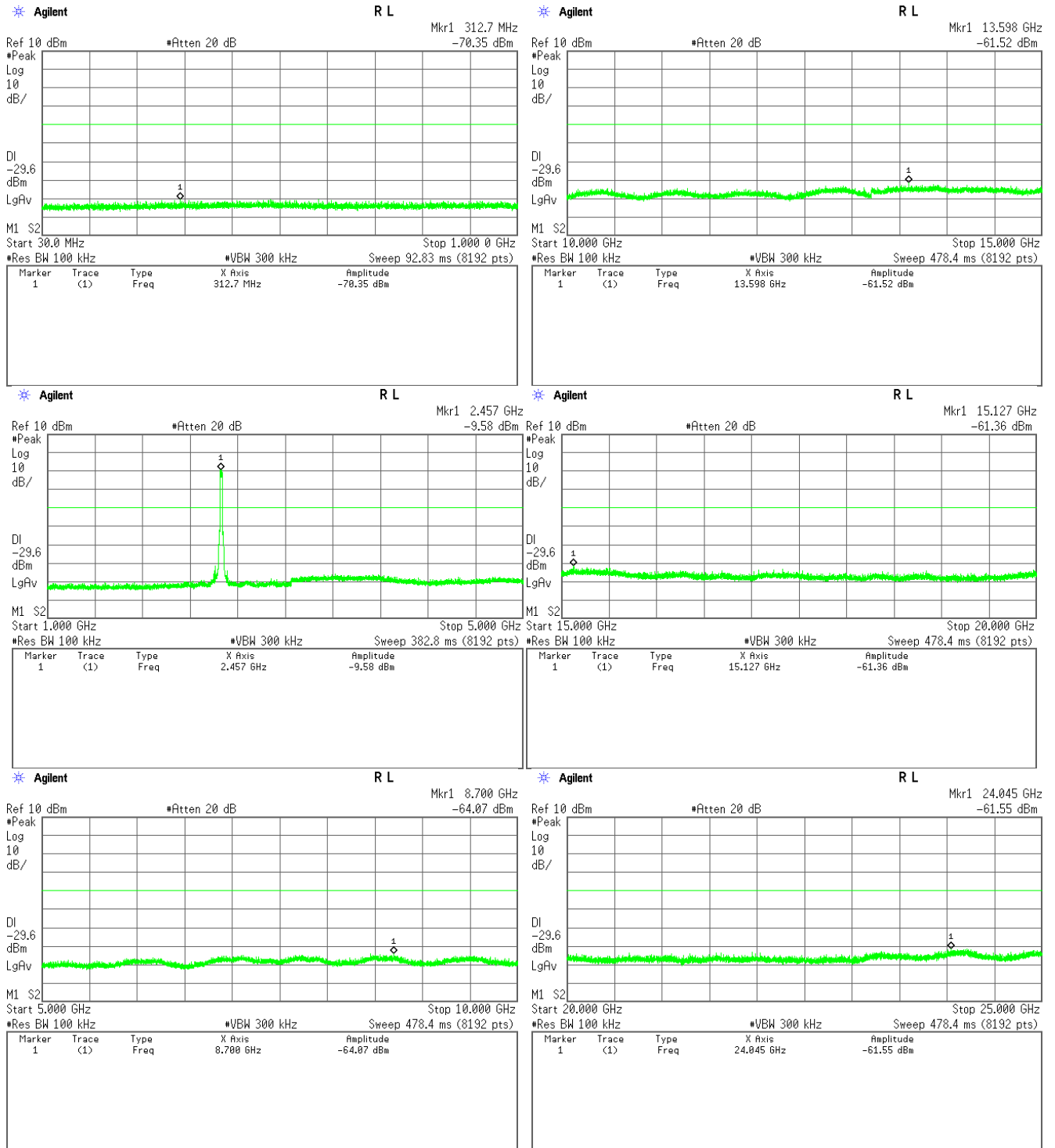

3) IEEE 802.11n

Low Channel

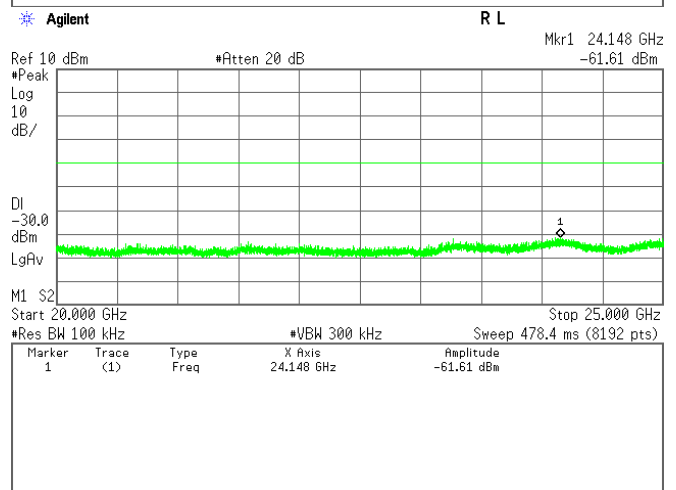
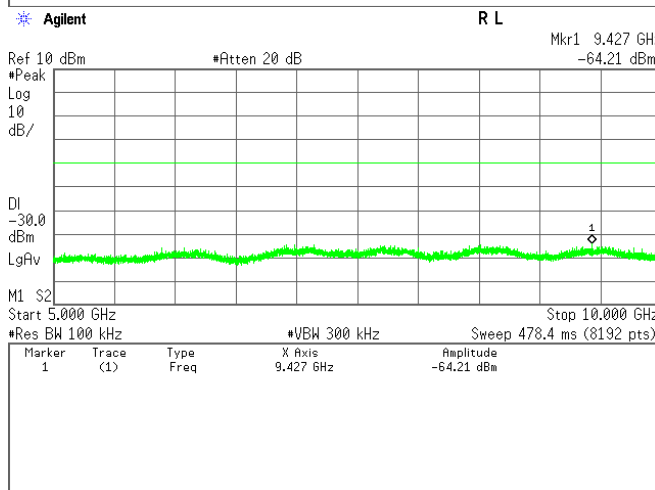
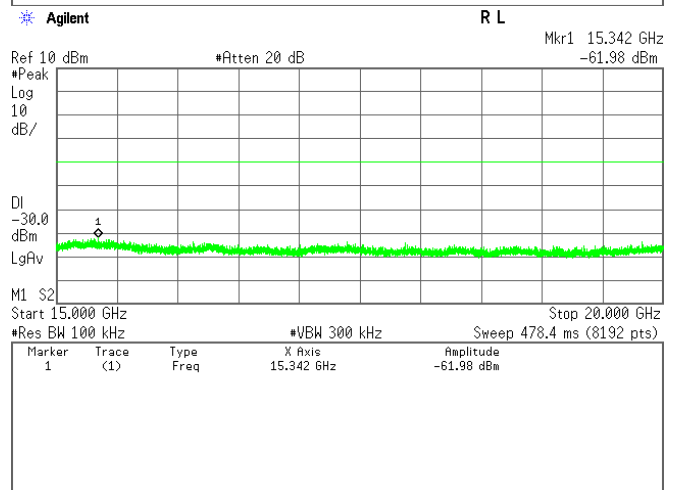
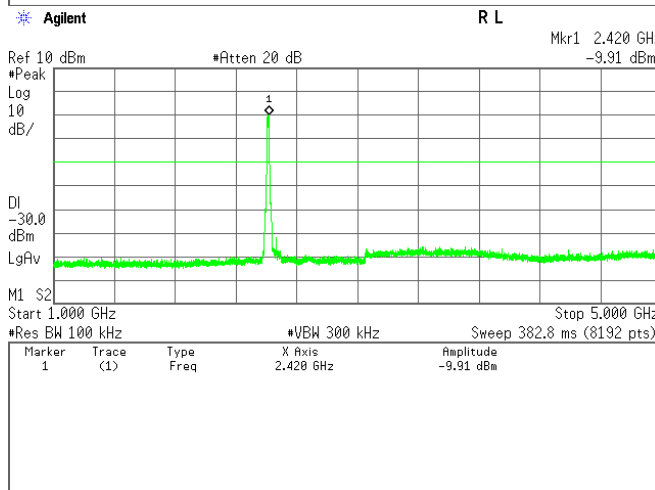
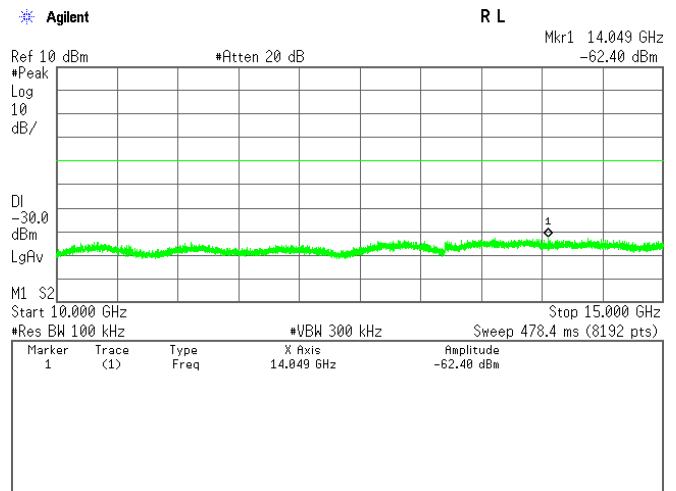
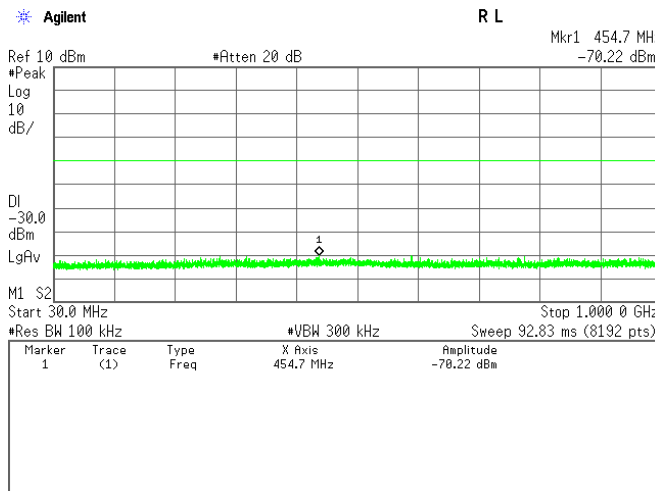

## Middle Channel

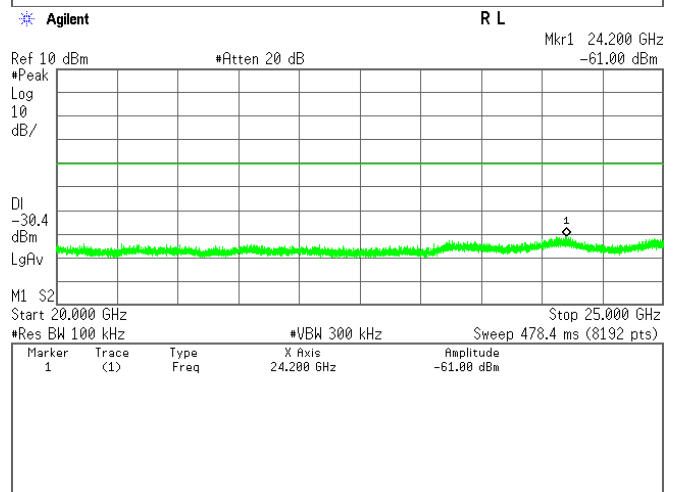
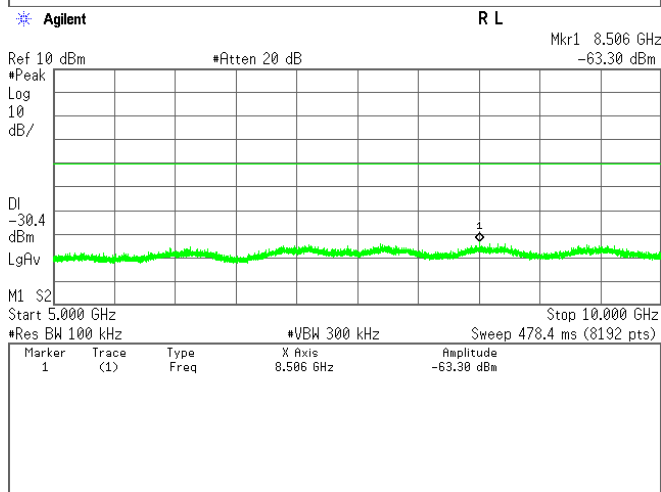
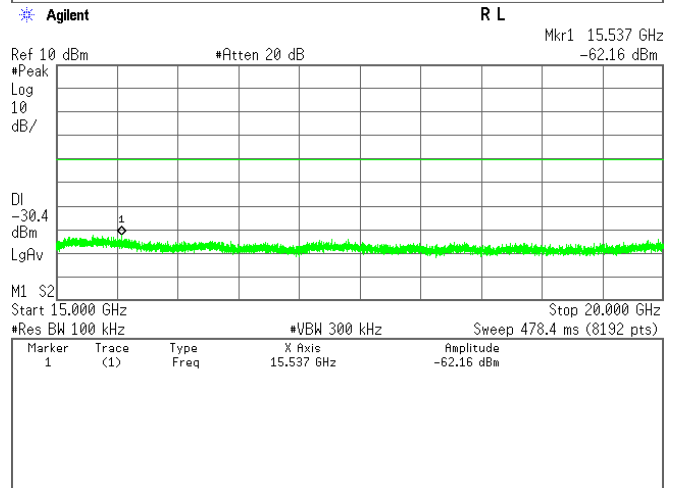
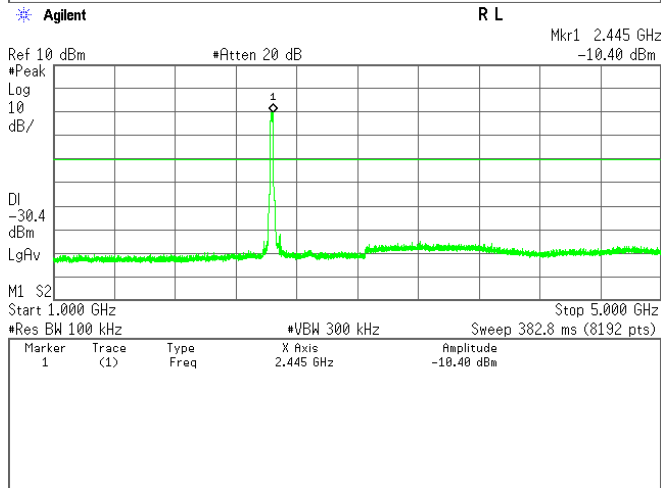
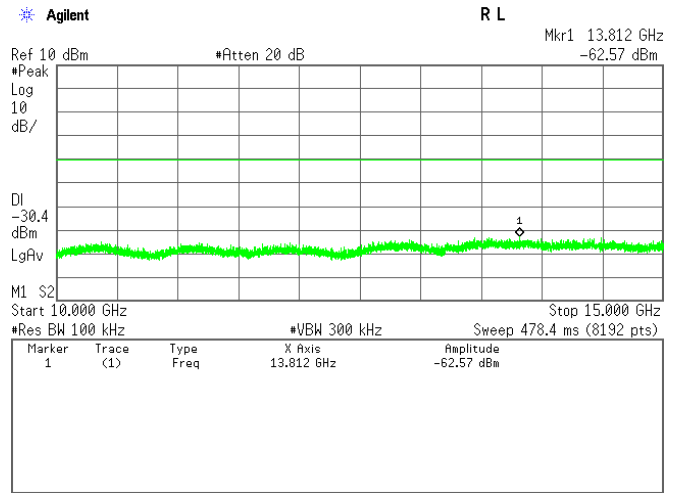
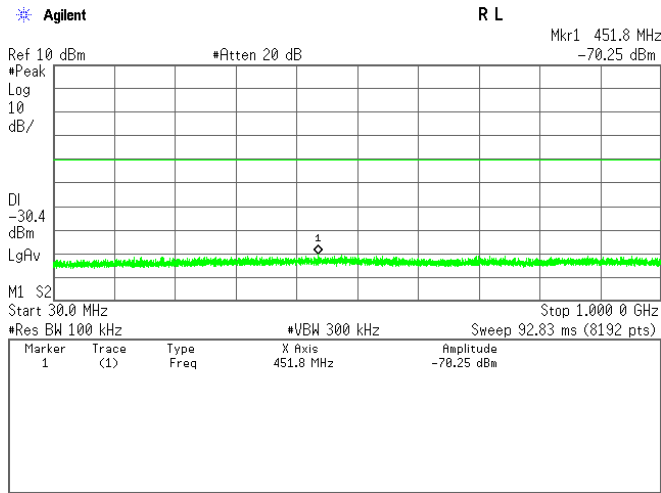

## High Channel

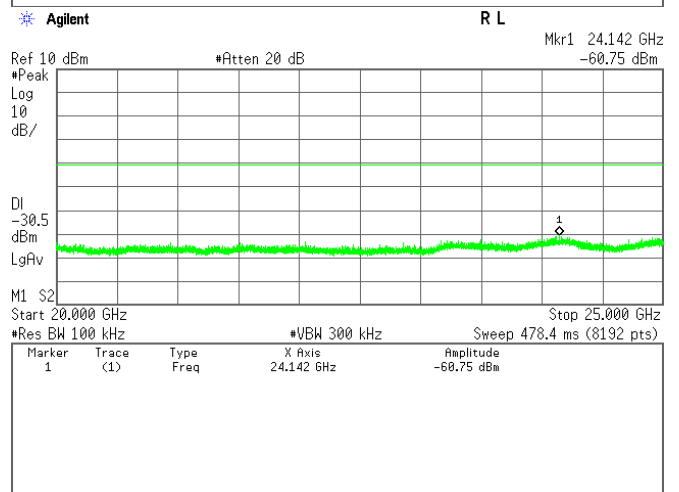
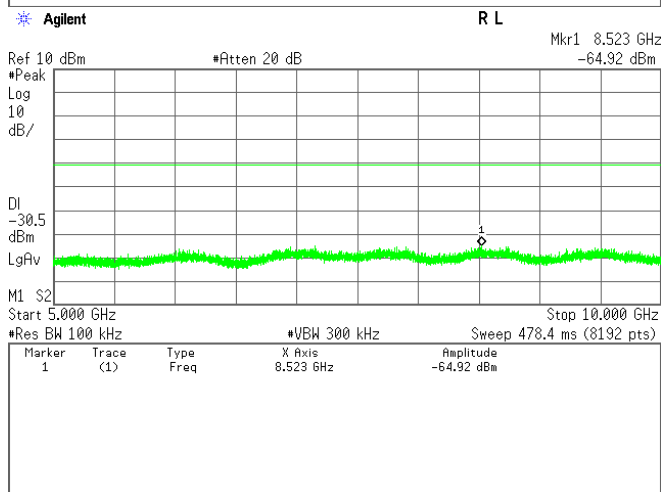
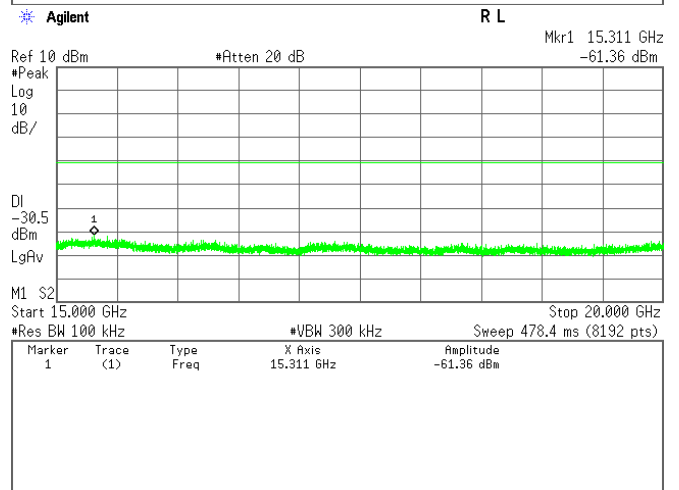
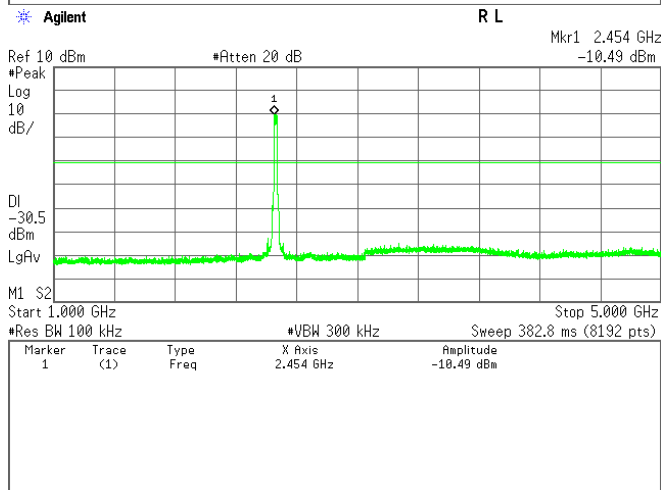
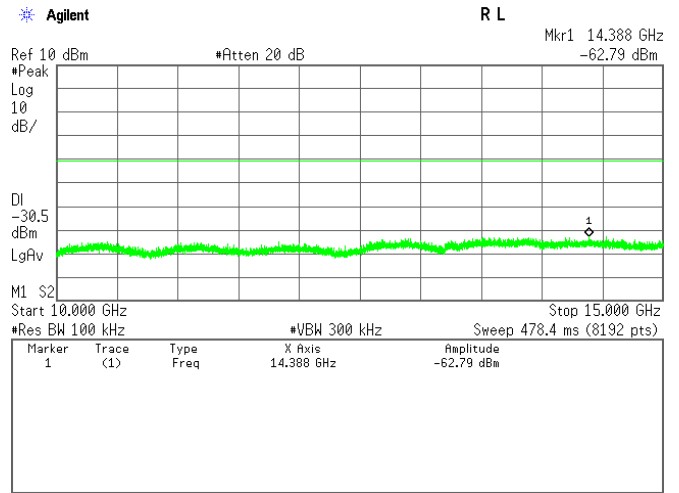
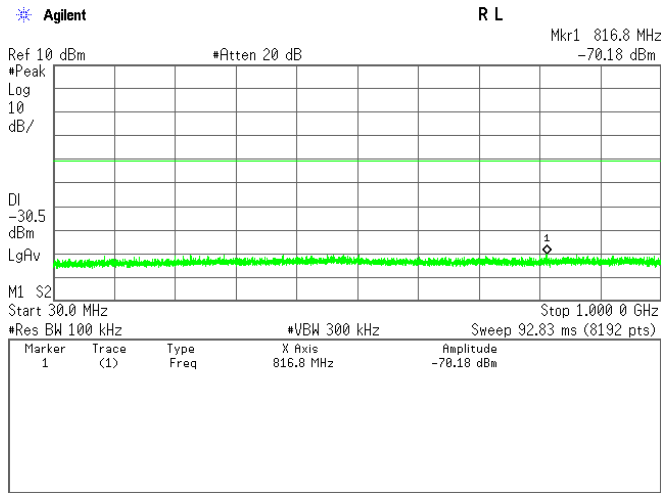



## 4) Bluetooth Low Energy

### Low Channel

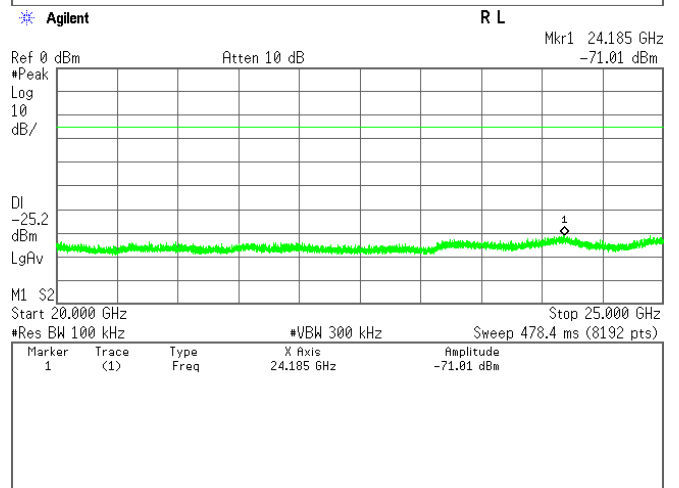
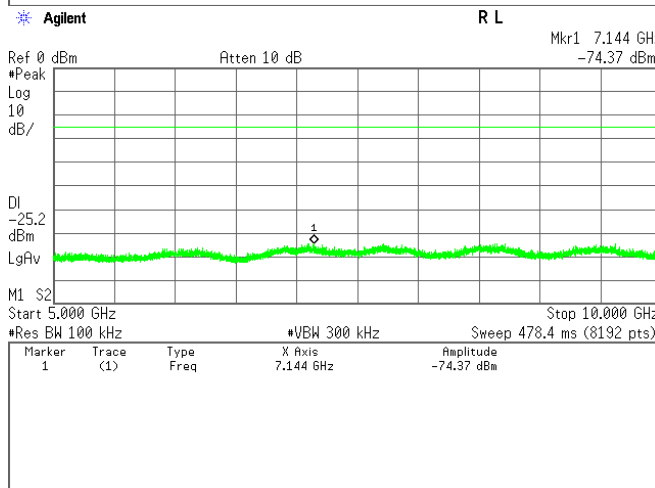
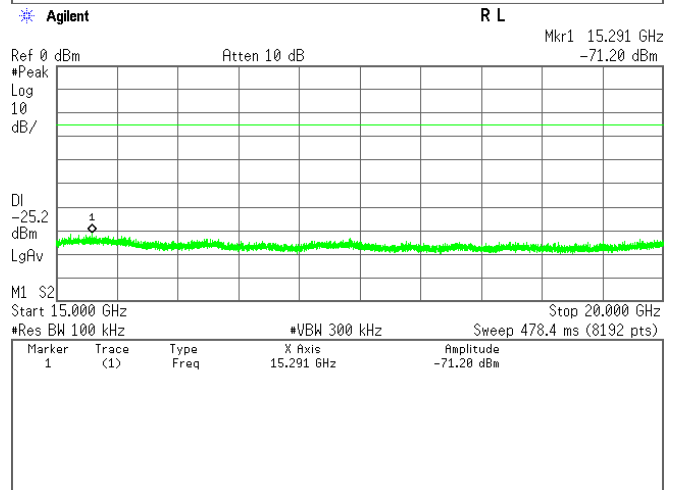
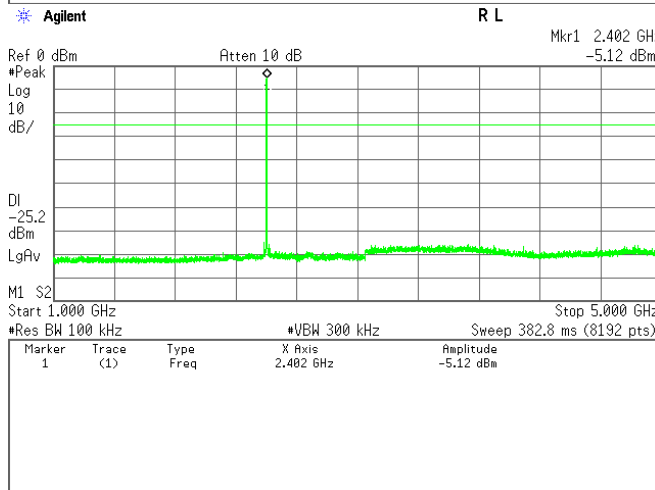
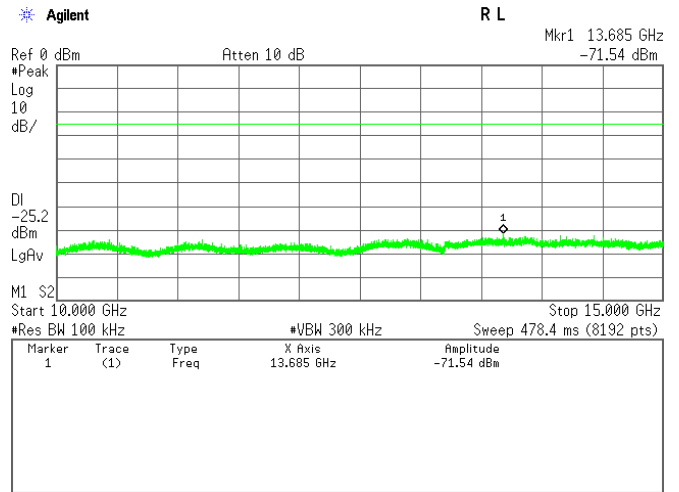
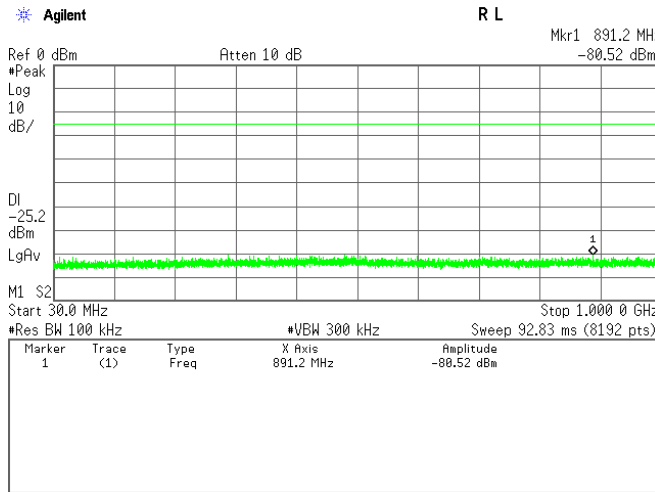

## Middle Channel

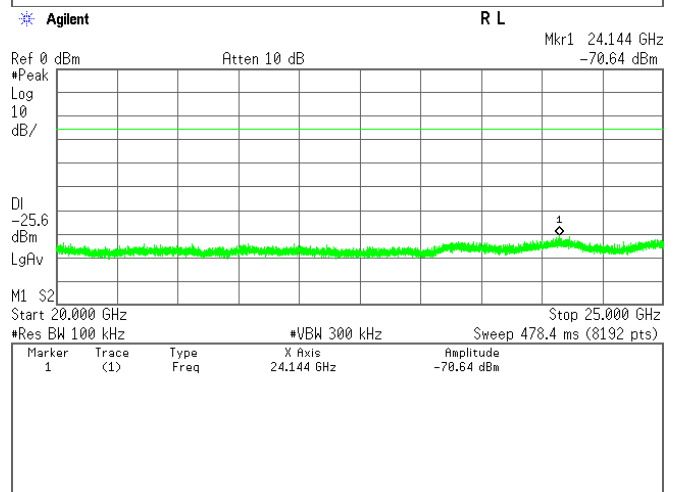
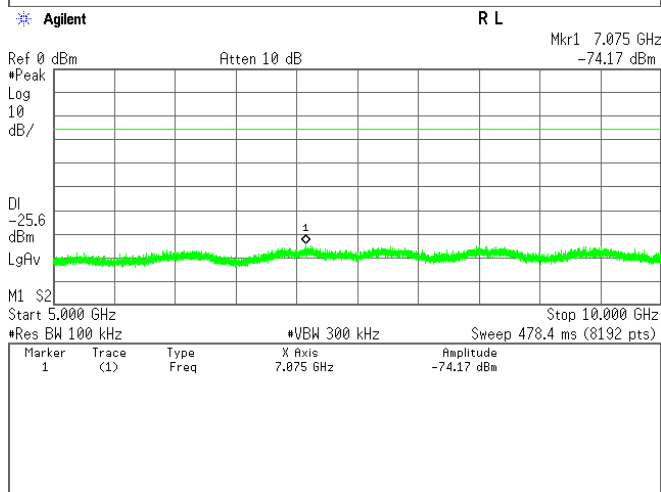
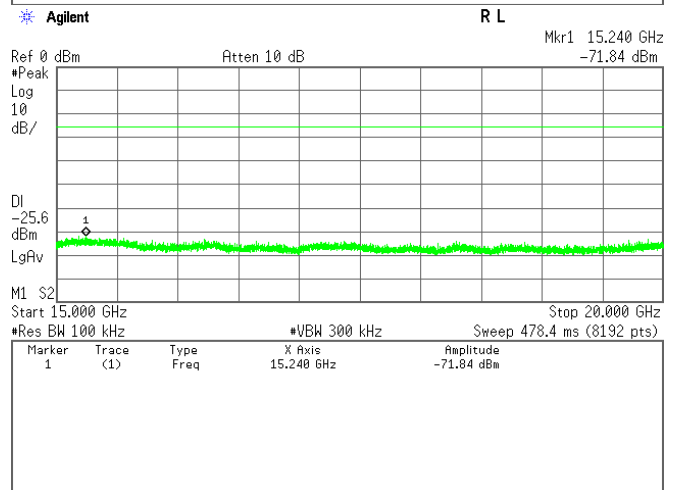
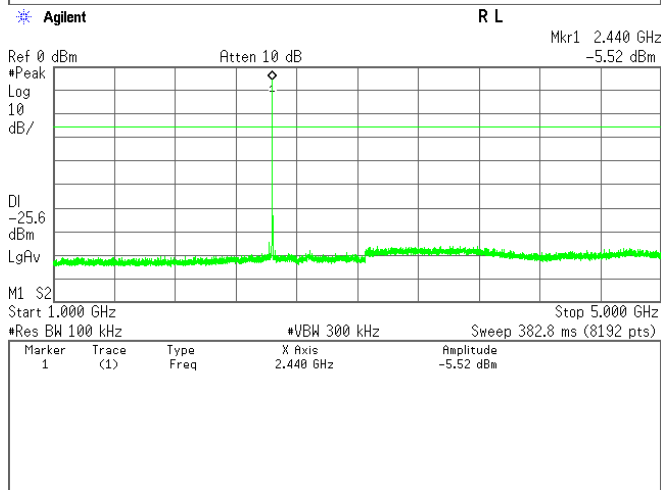
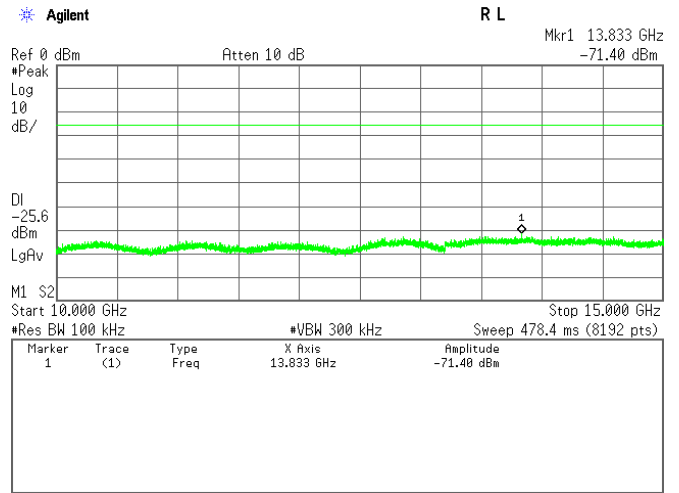
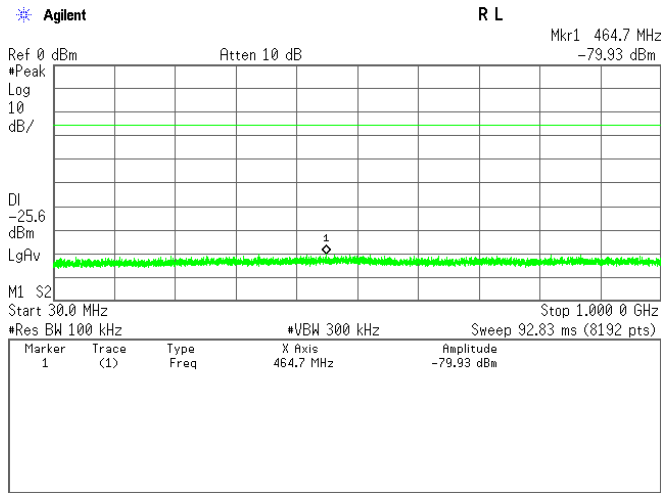

## High Channel

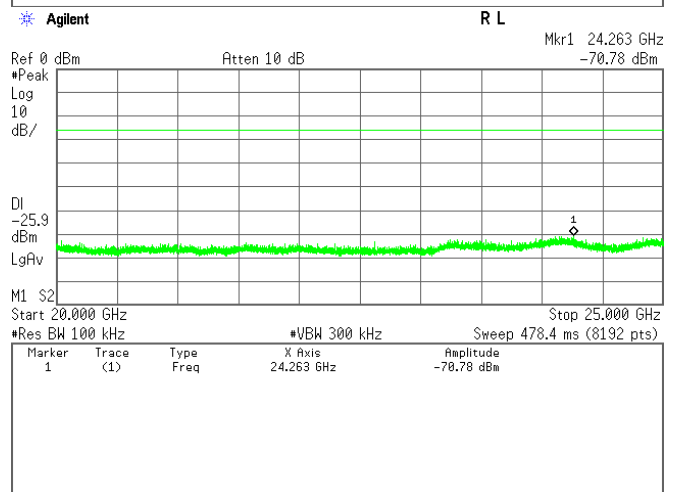
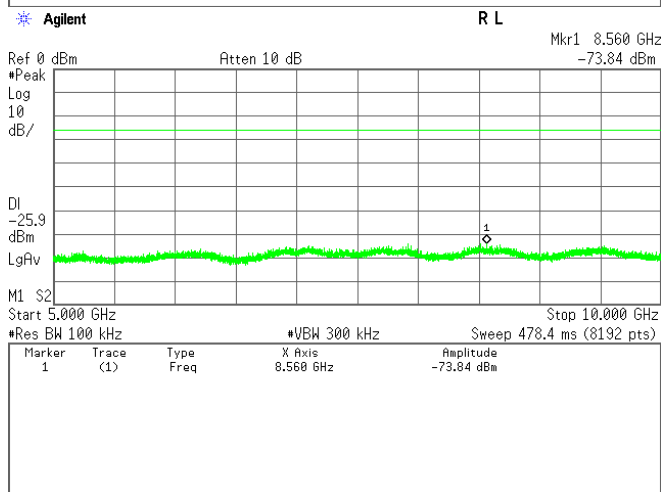
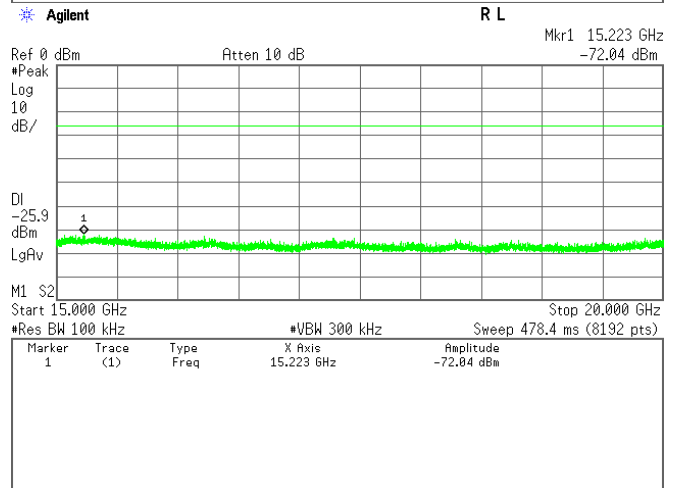
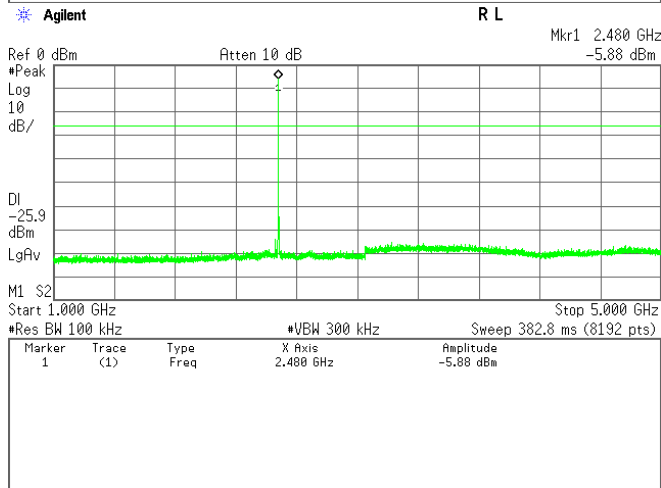
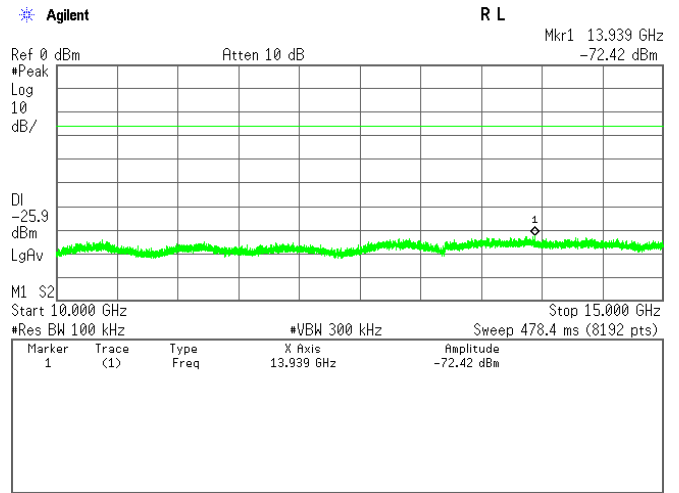
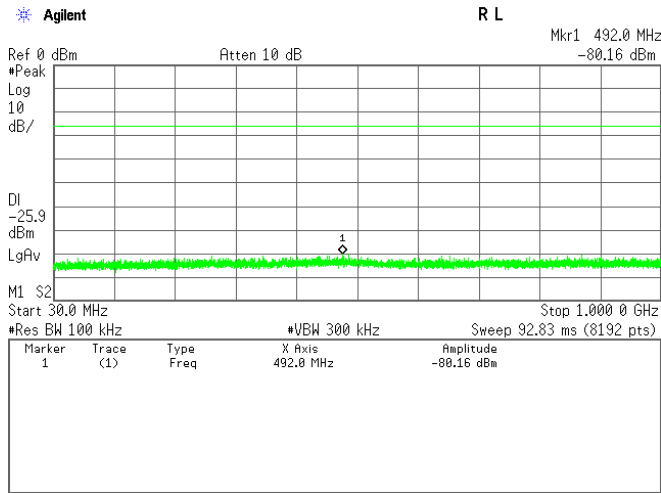

## Band-Edge Emission

1) IEEE 802.11b

### Low Channel

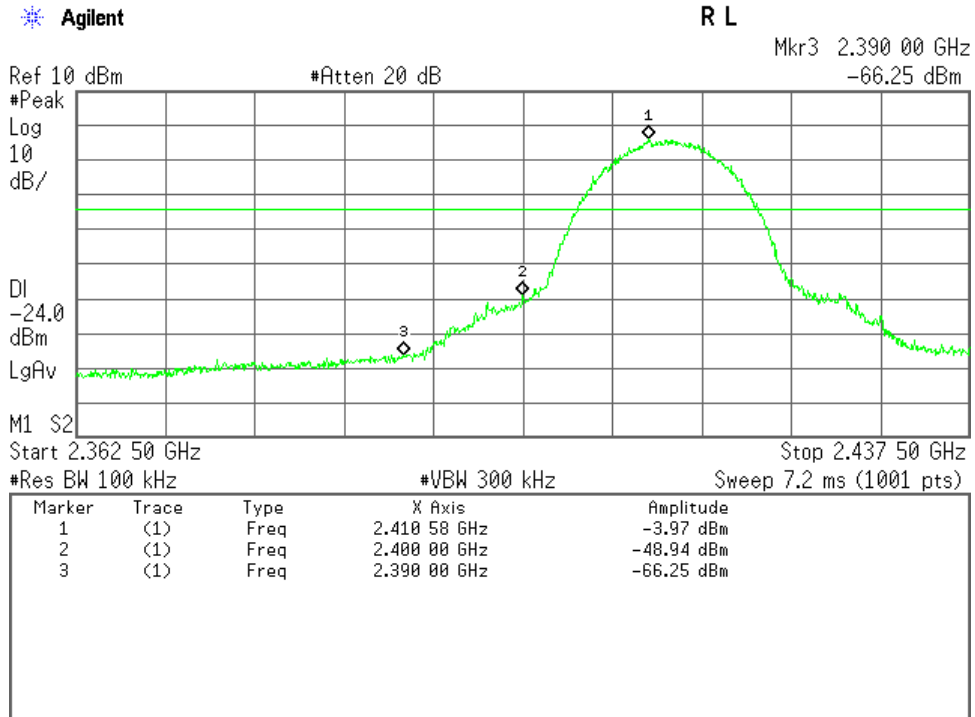

### High Channel

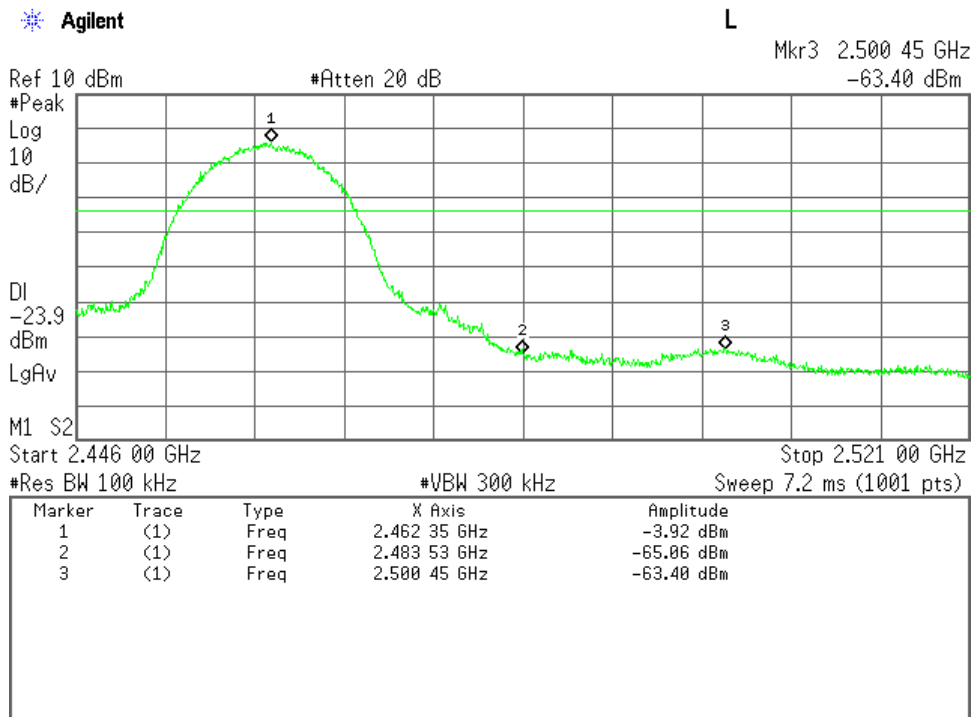

2) IEEE 802.11g

Low Channel

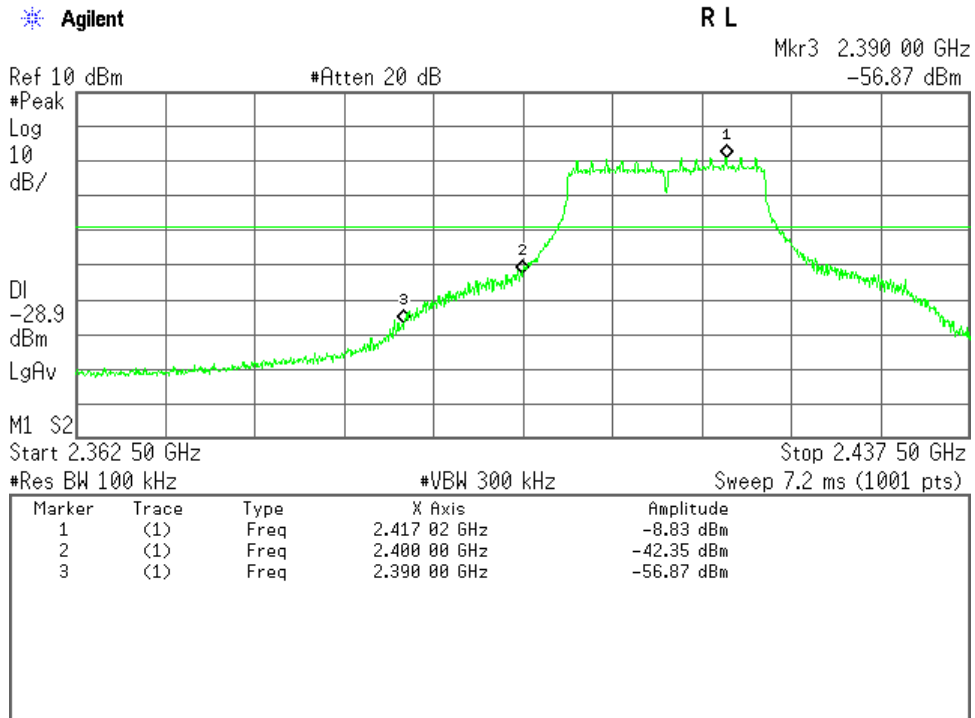

High Channel

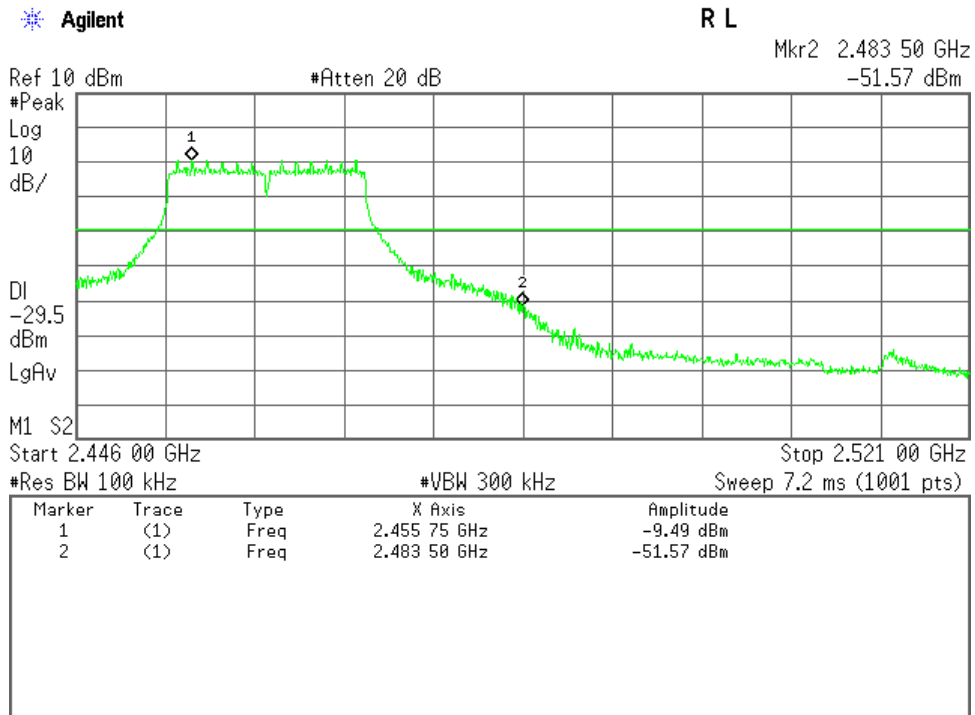

3) IEEE 802.11n

Low Channel

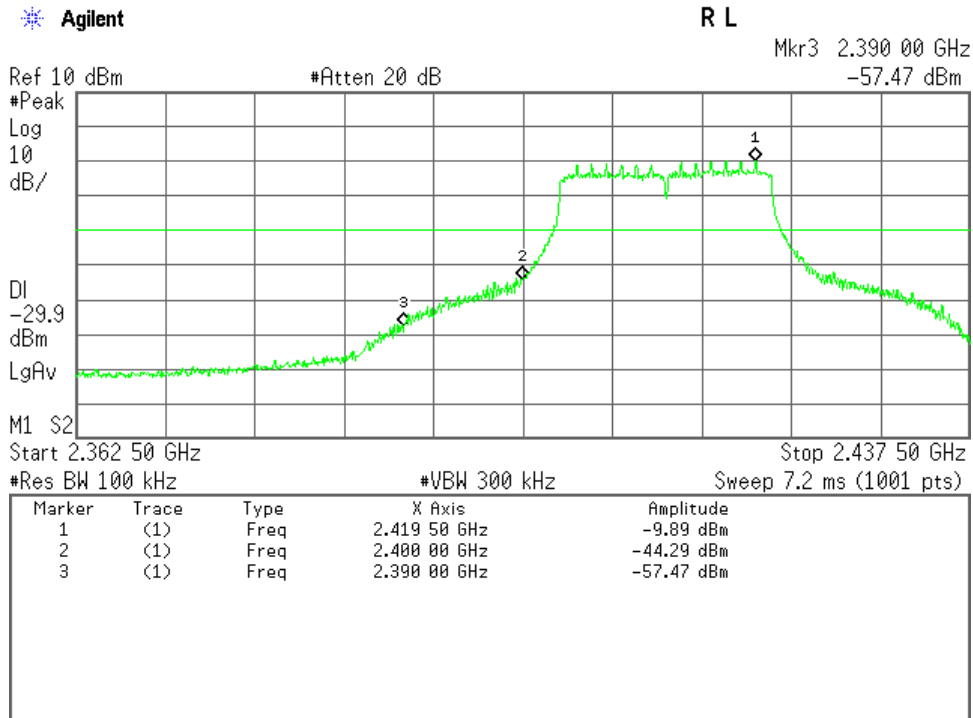

High Channel

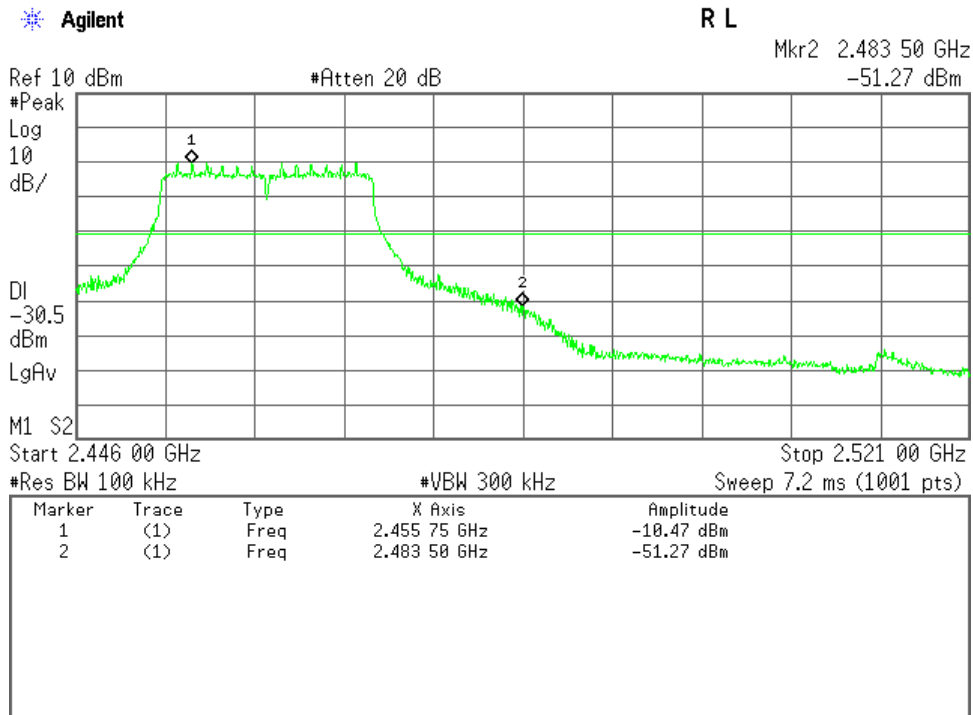

4) Bluetooth Low Energy

Low Channel

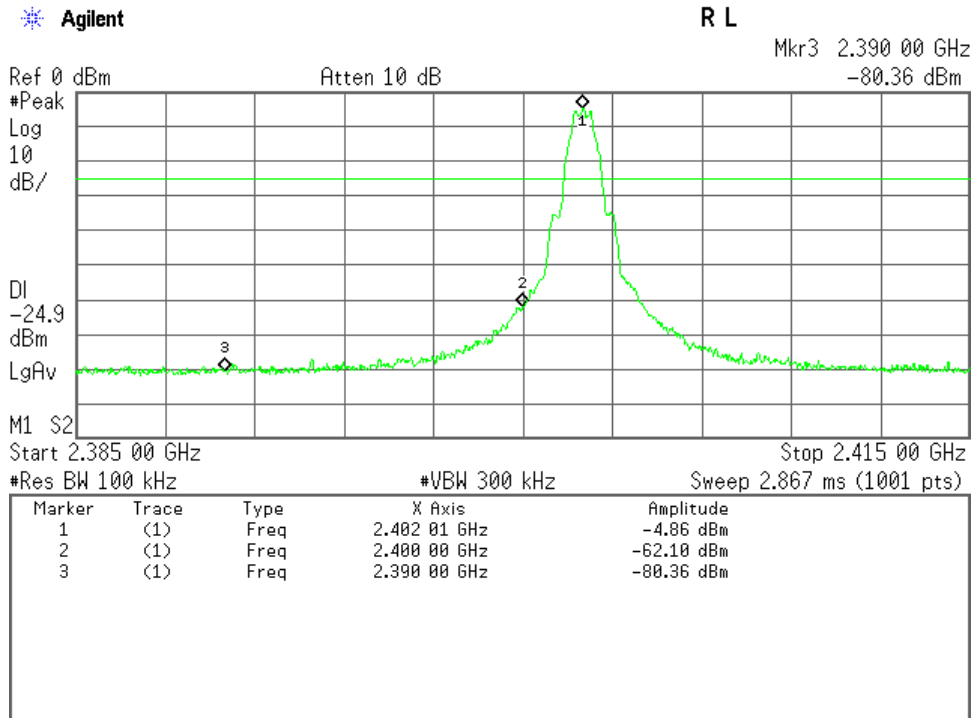

High Channel

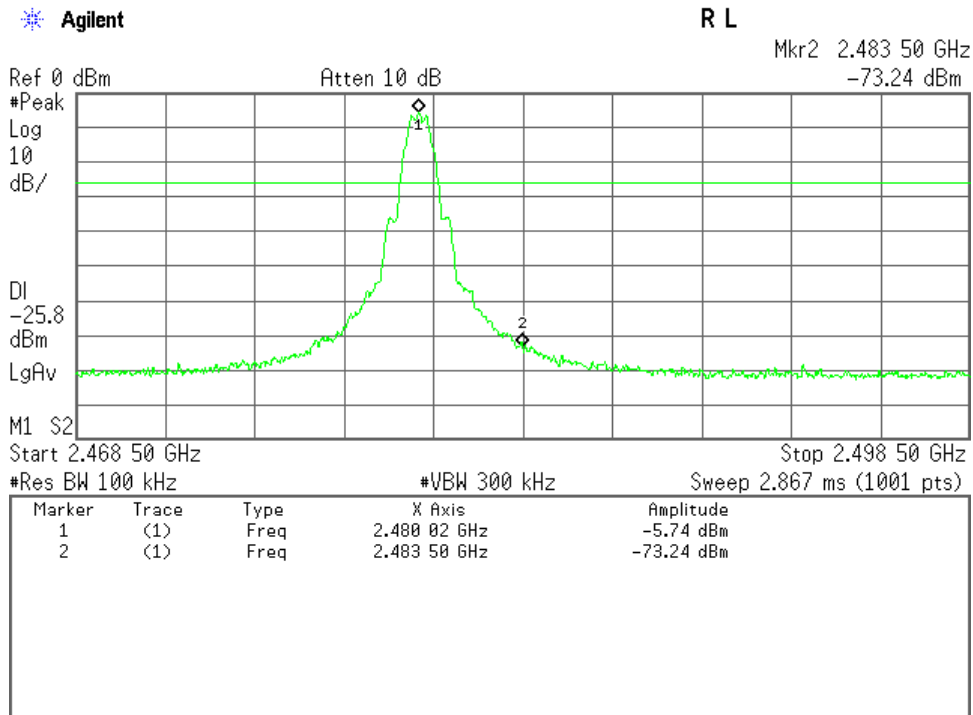

**7.8 AC Powerline Conducted Emission**

For the requirements,  - Applicable  - Tested.  - Not tested by applicant request.]  
 - Not Applicable

For the limits,  - Passed  - Failed  - Not judged

**7.8.1 Worst Point and Measurement Uncertainty**

Min. Limit Margin (Quasi-Peak) \_\_\_\_\_ 6.2 \_\_\_\_\_ dB at \_\_\_\_\_ 3.248 \_\_\_\_\_ MHz

Uncertainty of Measurement Results \_\_\_\_\_ +/-2.6 \_\_\_\_\_ dB(2σ)

Remarks : WLAN mode

**7.8.2 Test Instruments**

Measurement Room M2					
Type	Model	Manufacturer	ID No.	Last Cal.	Interval
Test Receiver	ESU 26	Rohde & Schwarz	A-6	2014/5	1 Year
AMN (main)	ESH3-Z5	Rohde & Schwarz	D-12	2014/8	1 Year
RF Cable	RG223/U	SUHNER	H-34	2014/6	1 Year



**7.8.3 Test Method and Test Setup (Diagrammatic illustration)**

The preliminary tests were performed using the scan mode of test receiver or spectrum analyzer to observe the emissions characteristics of the EUT.

The EUT configuration, cable configuration and mode of operation were determined for producing the maximum level of emissions.

This configurations was used for final tests.

– Side View –

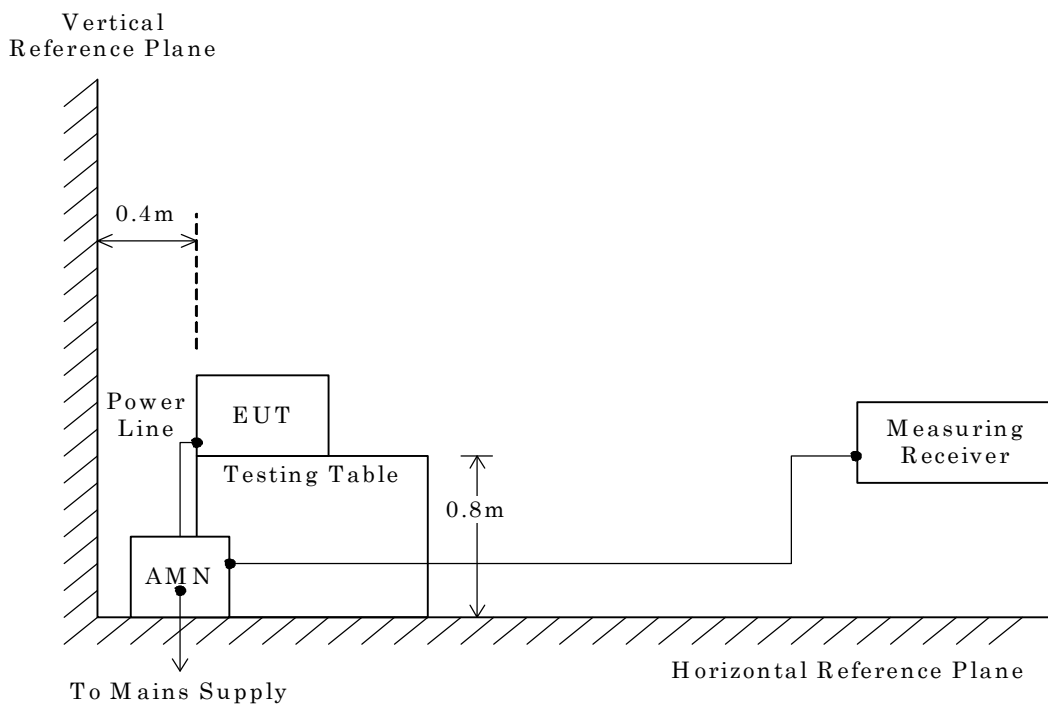

**NOTE**

AMN : Artificial Mains Network

### 7.8.4 Test Data

- 1) Mode of EUT : (WLAN) All modes have been investigated and the worst case mode for channel (06ch: 2437MHz / IEEE 802.11b, IEEE 802.11g and IEEE 802.11n) has been listed.

Test voltage : 120VAC 60Hz

Test Date: April 15, 2015  
Temp.: 21 °C, Humi.: 47 %

Measured phase : L1

Frequency [MHz]	Corr. Factor [dB]	Meter Readings [dB(μV)]		Limits [dB(μV)]		Results [dB(μV)]		Margin [dB]		Remarks
		QP	AVE	QP	AVE	QP	AVE	QP	AVE	
0.151	10.1	40.5	--	65.9	55.9	50.6	--	+15.3	--	-
0.200	10.1	36.6	--	63.6	53.6	46.7	--	+16.9	--	-
0.472	10.1	31.6	--	56.5	46.5	41.7	--	+14.8	--	-
0.523	10.2	34.0	--	56.0	46.0	44.2	--	+11.8	--	-
0.675	10.1	30.7	--	56.0	46.0	40.8	--	+15.2	--	-
1.053	10.3	30.5	--	56.0	46.0	40.8	--	+15.2	--	-
1.582	10.3	31.1	--	56.0	46.0	41.4	--	+14.6	--	-
2.688	10.3	36.8	16.5	56.0	46.0	47.1	26.8	+ 8.9	+19.2	-
3.248	10.3	39.5	20.0	56.0	46.0	49.8	30.3	+ 6.2	+15.7	-
4.323	10.3	28.1	--	56.0	46.0	38.4	--	+17.6	--	-

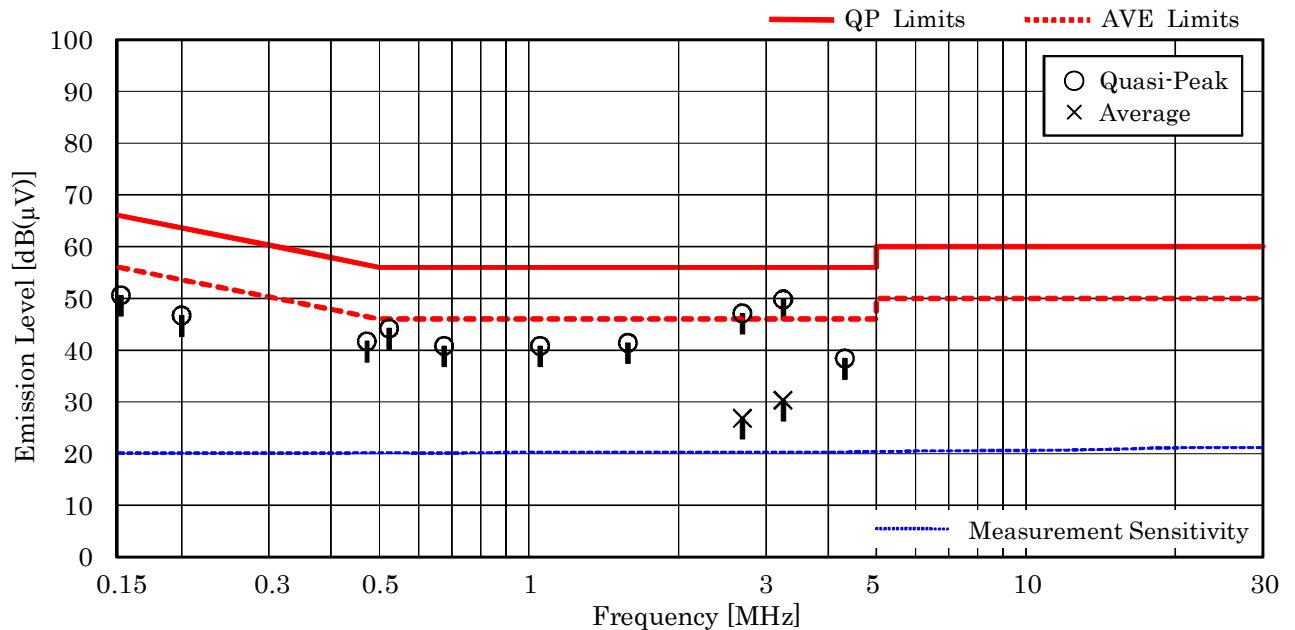

#### NOTES

1. The spectrum was checked from 0.15 MHz to 30 MHz.
2. The correction factor includes the AMN insertion loss and the cable loss.
3. The symbol of "<" means "or less".
4. The symbol of ">" means "more than".
5. The symbol of "--" means "not applicable".
6. Calculated result at 3.248 MHz, as the worst point shown on underline:  
 Correction Factor + Meter Reading (QP) = 10.3 + 39.5 = 49.8 dB(μV)
7. QP : Quasi-Peak Detector / AVE : Average Detector
8. Test receiver setting(s) : CISPR QP 9 kHz / Average 9 kHz

Test voltage : 120VAC 60Hz

Test Date: April 15, 2015  
Temp.: 21 °C, Humi.: 47 %

Measured phase : L2

Frequency [MHz]	Corr. Factor [dB]	Meter Readings [dB(μV)]		Limits [dB(μV)]		Results [dB(μV)]		Margin [dB]		Remarks
		QP	AVE	QP	AVE	QP	AVE	QP	AVE	
0.151	10.2	41.7	--	65.9	55.9	51.9	--	+14.0	--	-
0.200	10.1	38.1	--	63.6	53.6	48.2	--	+15.4	--	-
<u>0.472</u>	<u>10.2</u>	<u>35.6</u>	--	<u>56.5</u>	<u>46.5</u>	<u>45.8</u>	--	<u>+10.7</u>	--	-
0.523	10.1	33.7	--	56.0	46.0	43.8	--	+12.2	--	-
0.675	10.2	27.1	--	56.0	46.0	37.3	--	+18.7	--	-
1.053	10.3	23.3	--	56.0	46.0	33.6	--	+22.4	--	-
1.582	10.3	19.1	--	56.0	46.0	29.4	--	+26.6	--	-
2.688	10.3	29.2	--	56.0	46.0	39.5	--	+16.5	--	-
3.248	10.3	34.5	--	56.0	46.0	44.8	--	+11.2	--	-
4.323	10.4	30.6	--	56.0	46.0	41.0	--	+15.0	--	-

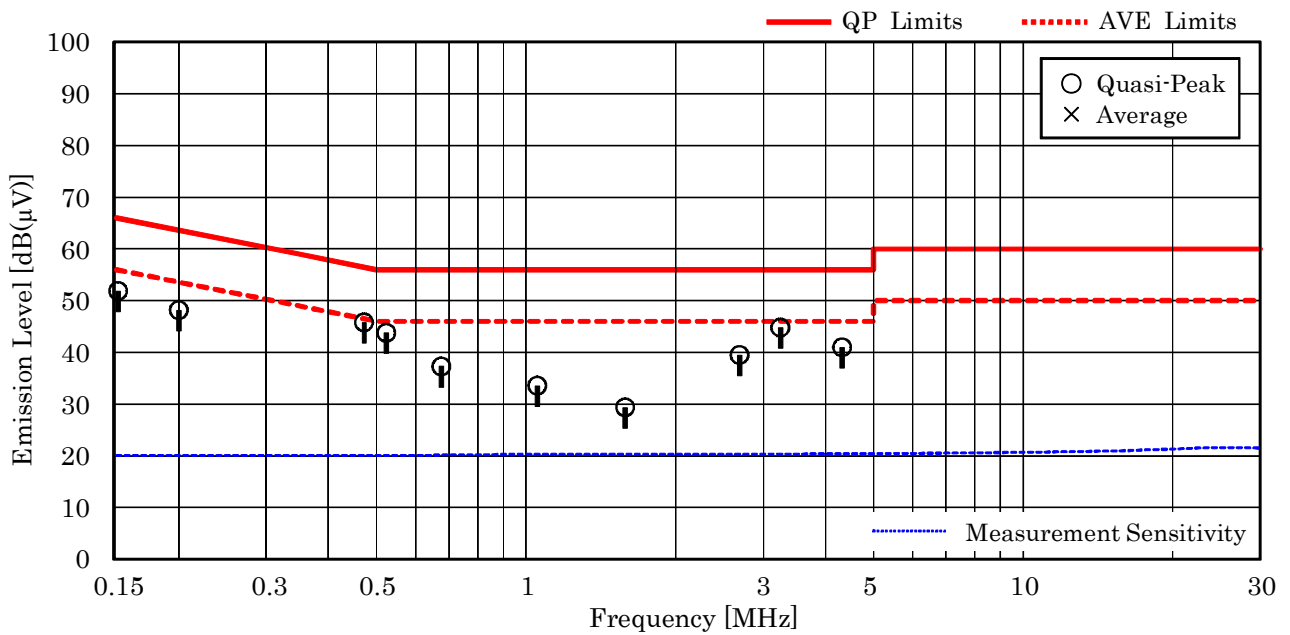

**NOTES**

1. The spectrum was checked from 0.15 MHz to 30 MHz.
2. The correction factor includes the AMN insertion loss and the cable loss.
3. The symbol of “<” means “or less”.
4. The symbol of “>” means “more than”.
5. The symbol of “-” means “not applicable”.
6. Calculated result at 0.472 MHz, as the worst point shown on underline:  
 Correction Factor + Meter Reading (QP) = 10.2 + 35.6 = 45.8 dB(μV)
7. QP : Quasi-Peak Detector / AVE : Average Detector
8. Test receiver setting(s) : CISPR QP 9 kHz / Average 9 kHz

2) Mode of EUT : Bluetooth Low Energy

Test voltage : 120VAC 60Hz

Test Date: April 15, 2015  
Temp.: 21 °C, Humi.: 47 %

Measured phase : L1

Frequency [MHz]	Corr. Factor [dB]	Meter Readings [dB(μV)]		Limits [dB(μV)]		Results [dB(μV)]		Margin [dB]		Remarks
		QP	AVE	QP	AVE	QP	AVE	QP	AVE	
0.151	10.1	40.5	--	65.9	55.9	50.6	--	+15.3	--	-
0.200	10.1	36.5	--	63.6	53.6	46.6	--	+17.0	--	-
0.472	10.1	31.5	--	56.5	46.5	41.6	--	+14.9	--	-
0.523	10.2	34.0	--	56.0	46.0	44.2	--	+11.8	--	-
0.675	10.1	30.9	--	56.0	46.0	41.0	--	+15.0	--	-
1.044	10.3	30.6	--	56.0	46.0	40.9	--	+15.1	--	-
1.582	10.3	30.3	--	56.0	46.0	40.6	--	+15.4	--	-
2.704	10.3	35.8	18.2	56.0	46.0	46.1	28.5	+ 9.9	+17.5	-
3.243	10.3	39.1	20.0	56.0	46.0	49.4	30.3	+ 6.6	+15.7	-
4.318	10.3	27.9	--	56.0	46.0	38.2	--	+17.8	--	-

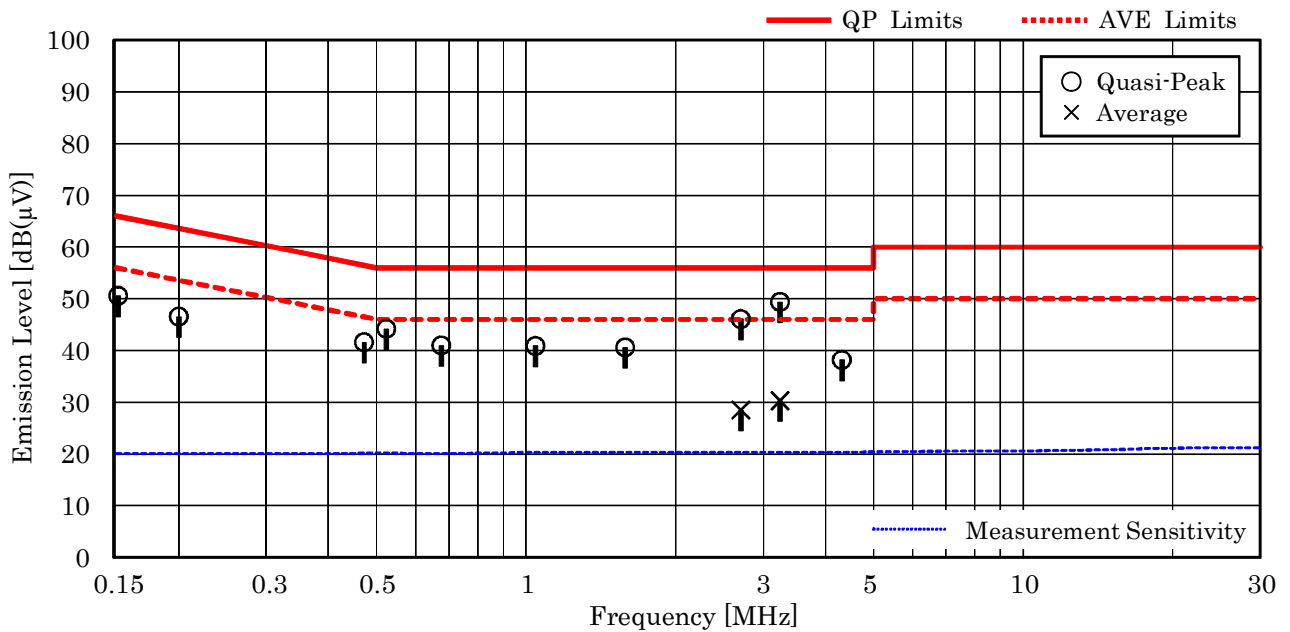

NOTES

1. The spectrum was checked from 0.15 MHz to 30 MHz.
2. The correction factor includes the AMN insertion loss and the cable loss.
3. The symbol of "<" means "or less".
4. The symbol of ">" means "more than".
5. The symbol of "--" means "not applicable".
6. Calculated result at 3.243 MHz, as the worst point shown on underline:  
 Correction Factor + Meter Reading (QP) = 10.3 + 39.1 = 49.4 dB(μV)
7. QP : Quasi-Peak Detector / AVE : Average Detector
8. Test receiver setting(s) : CISPR QP 9 kHz / Average 9 kHz

Test voltage : 120VAC 60Hz

Test Date: April 15, 2015  
Temp.: 21 °C, Humi.: 47 %

Measured phase : L2

Frequency [MHz]	Corr. Factor [dB]	Meter Readings [dB(μV)]		Limits [dB(μV)]		Results [dB(μV)]		Margin [dB]		Remarks
		QP	AVE	QP	AVE	QP	AVE	QP	AVE	
0.151	10.2	41.7	--	65.9	55.9	51.9	--	+14.0	--	-
0.200	10.1	38.0	--	63.6	53.6	48.1	--	+15.5	--	-
<u>0.472</u>	<u>10.2</u>	<u>35.6</u>	--	<u>56.5</u>	<u>46.5</u>	<u>45.8</u>	--	<u>+10.7</u>	--	-
0.523	10.1	33.7	--	56.0	46.0	43.8	--	+12.2	--	-
0.675	10.2	27.3	--	56.0	46.0	37.5	--	+18.5	--	-
1.044	10.3	22.3	--	56.0	46.0	32.6	--	+23.4	--	-
1.582	10.3	18.2	--	56.0	46.0	28.5	--	+27.5	--	-
2.704	10.3	26.9	--	56.0	46.0	37.2	--	+18.8	--	-
3.243	10.3	33.9	--	56.0	46.0	44.2	--	+11.8	--	-
4.318	10.4	30.1	--	56.0	46.0	40.5	--	+15.5	--	-

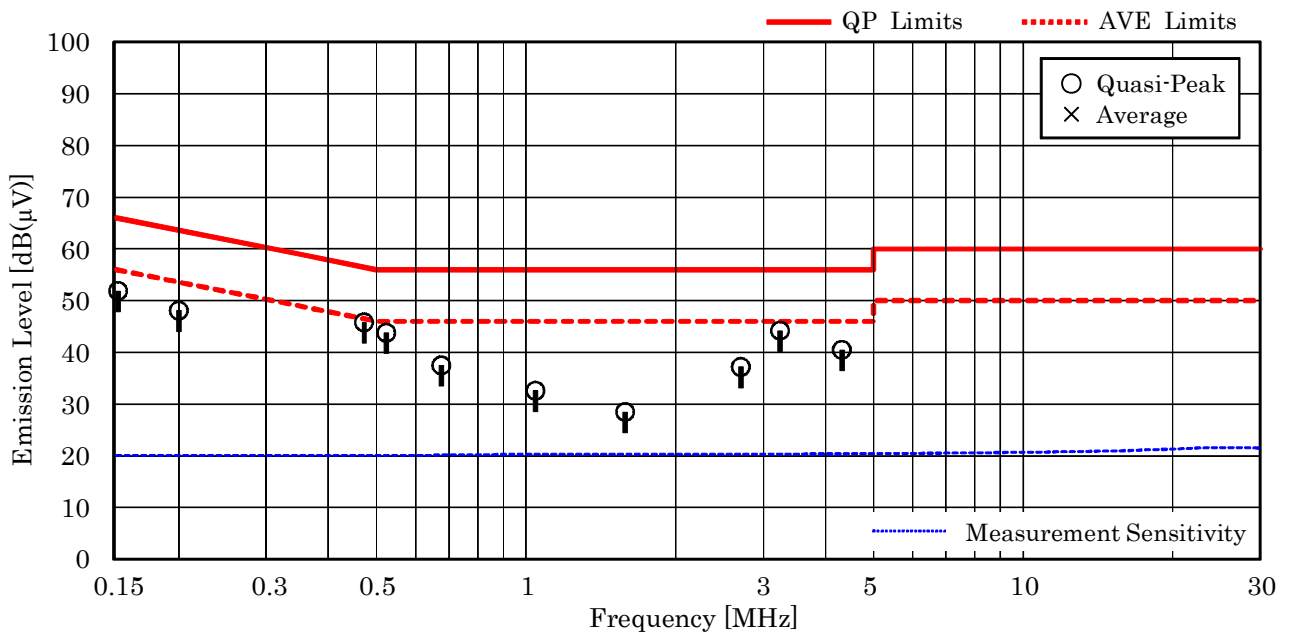

**NOTES**

1. The spectrum was checked from 0.15 MHz to 30 MHz.
2. The correction factor includes the AMN insertion loss and the cable loss.
3. The symbol of "<" means "or less".
4. The symbol of ">" means "more than".
5. The symbol of "--" means "not applicable".
6. Calculated result at 0.472 MHz, as the worst point shown on underline:  
 Correction Factor + Meter Reading (QP) = 10.2 + 35.6 = 45.8 dB(μV)
7. QP : Quasi-Peak Detector / AVE : Average Detector
8. Test receiver setting(s) : CISPR QP 9 kHz / Average 9 kHz

**7.9 Radiated Emission**

The requirements are  - Applicable  - Tested.  - Not tested by applicant request.]  
 - Not Applicable

- Passed  - Failed  - Not judged

**7.9.1 Worst Point and Measurement Uncertainty**

Min. Limit Margin (Peak) 5.3 dB at 2483.5 MHz

Uncertainty of Measurement Results	9 kHz – 30 MHz	<u>+/-3.0</u>	dB(2 $\sigma$ )
	30 MHz – 300 MHz	<u>+/-3.8</u>	dB(2 $\sigma$ )
	300 MHz – 1000 MHz	<u>+/-4.8</u>	dB(2 $\sigma$ )
	1 GHz – 6 GHz	<u>+/-4.7</u>	dB(2 $\sigma$ )
	6 GHz – 18 GHz	<u>+/-4.6</u>	dB(2 $\sigma$ )
	18 GHz – 40 GHz	<u>+/-5.5</u>	dB(2 $\sigma$ )

Remarks : IEEE802.11g mode, Z axis position.

## 7.9.2 Test Instruments

Anechoic Chamber A2					
Type	Model	Manufacturer	ID No.	Last Cal.	Interval
Test Receiver	ESU 26	Rohde & Schwarz	A-6	2014/5	1 Year
Loop Antenna	HFH2-Z2	Rohde & Schwarz	C-2	2014/8	1 Year
RF Cable	RG213/U	SUHNER	H-28	2014/8	1 Year
Biconical Antenna	VHA9103/BBA9106	Schwarzbeck	C-30	2014/5	1 Year
Log-periodic Antenna	UHALP9108-A1	Schwarzbeck	C-31	2014/5	1 Year
RF Cable	S 10162 B-11 etc.	SUHNER	H-4	2015/4	1 Year
Site Attenuation	--	----	H-15	2015/1	1 Year
Pre-Amplifier	TPA0118-36	TOYO	A-37	2014/5	1 Year
Pre-Amplifier	RP1826G-45H	EMCS	A-53	2014/7	1 Year
Horn Antenna	91888-2	EATON	C-41-1	2014/7	1 Year
Horn Antenna	91889-2	EATON	C-41-2	2014/7	1 Year
Horn Antenna	3160-04	EMCO	C-55	2014/6	1 Year
Horn Antenna	3160-05	EMCO	C-56	2014/6	1 Year
Horn Antenna	3160-06	EMCO	C-57	2014/6	1 Year
Horn Antenna	3160-07	EMCO	C-58	2014/6	1 Year
Horn Antenna	3160-08	EMCO	C-59	2014/6	1 Year
Horn Antenna	3160-09	EMCO	C-48	2014/7	1 Year
Attenuator	54A-10	Weinschel	D-29	2014/9	1 Year
Attenuator	2-10	Weinschel	D-79	2014/11	1 Year
Band Rejection Filter	BRM50701	MICRO-TRONICS	D-93	2015/2	1 Year
RF Cable	SUCOFLEX104	SUHNER	C-66	2015/1	1 Year
RF Cable	SUCOFLEX104	SUHNER	C-67	2015/1	1 Year
RF Cable	SUCOFLEX102EA	SUHNER	C-69	2015/1	1 Year
SVSWR	--	----	H-19	2015/2	1 Year
Pre-Amplifier	310N	SONOMA	A-17	2015/4	1 Year

**7.9.3 Test Method and Test Setup (Diagrammatic illustration)**

**7.9.3.1 Radiated Emission 9 kHz – 30 MHz**

The preliminary tests were performed at the measurement distance that specified for compliance to determine the emission characteristics of the EUT.

The EUT configuration(in X, Y and Z axis), cable configuration and mode of operation were determined for producing the maximum level of emissions.

This configurations was used for the final tests.

– Side View –

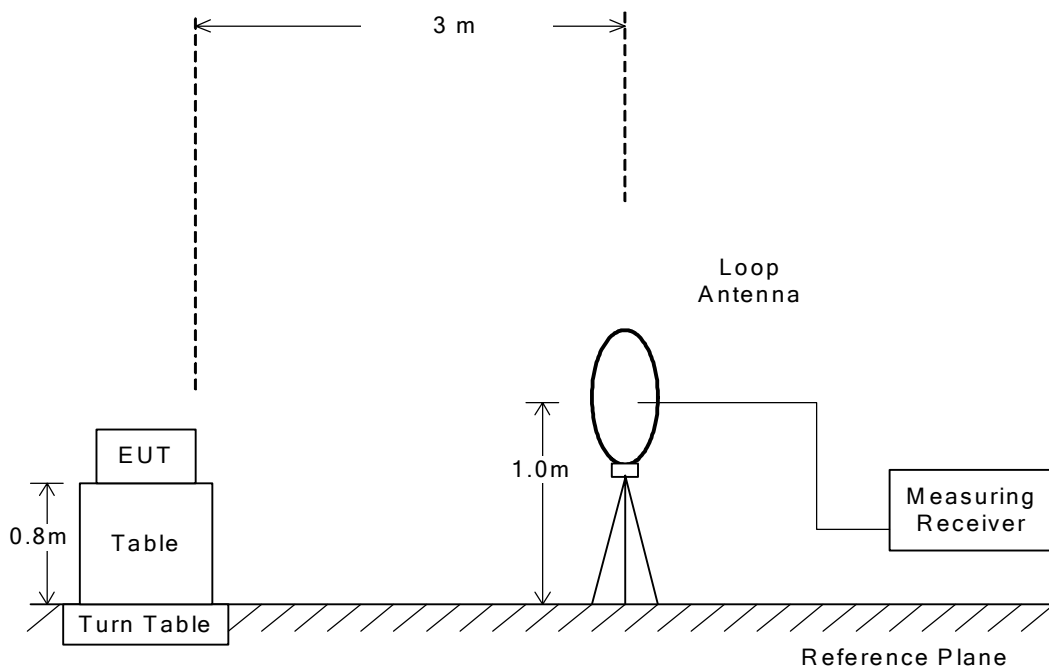



**7.9.3.2 Radiated Emission 30 MHz – 1000 MHz**

The preliminary tests were performed at the measurement distance that specified for compliance to determine the emission characteristics of the EUT.

The EUT configuration(in X, Y and Z axis), cable configuration and mode of operation were determined for producing the maximum level of emissions.

This configurations was used for the final tests.

– Side View –

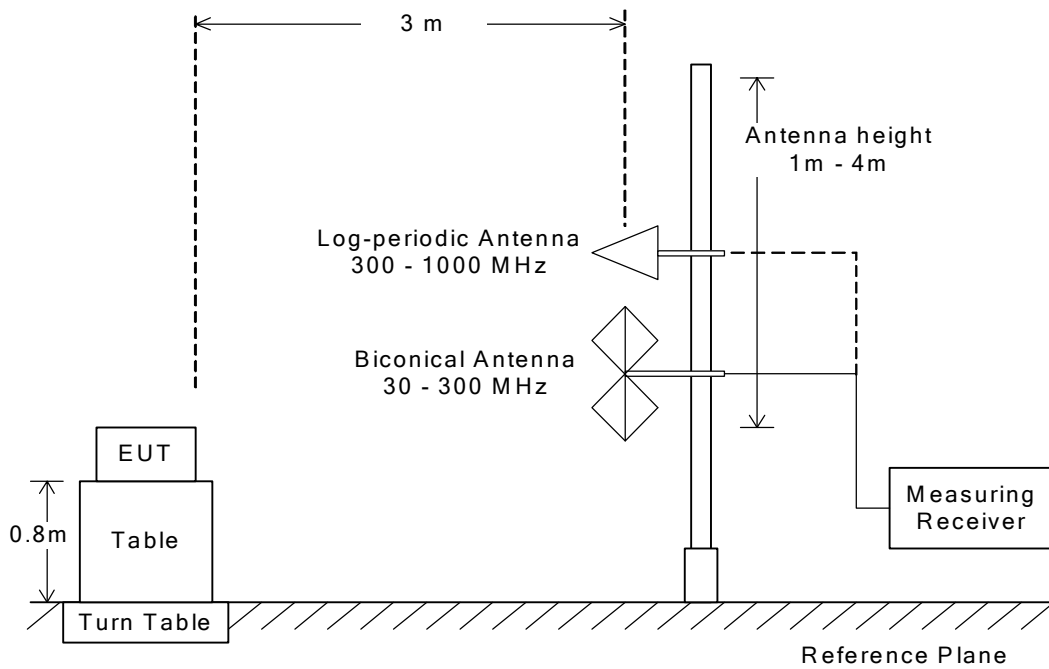

**7.9.3.3 Radiated Emission above 1 GHz**

The preliminary tests were performed at the measurement distance that specified for compliance to determine the emission characteristics of the EUT.

The EUT configuration(in X, Y and Z axis), cable configuration and mode of operation were determined for producing the maximum level of emissions.

This configurations was used for the final tests.

The setting of the measuring instruments are shown as follows:

Type	Peak	Average
Detector Function	Peak	Peak
Res. Bandwidth	1 MHz	1 MHz
Video Bandwidth	3 MHz	$\geq 1/T * 1$ )
Video Filtering	Linear Voltage	Linear Voltage
Sweep Time	AUTO	AUTO
Trace	Max Hold	Max Hold

Note: 1. T: Minimum transmission duration

– Side View –

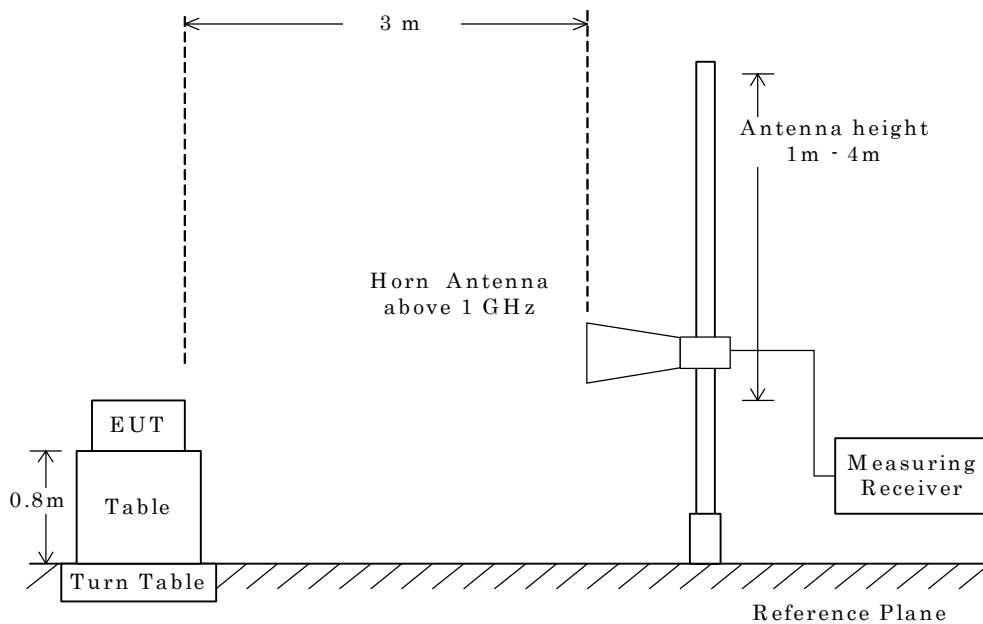

**NOTE**

The antenna height is scanned depending on the EUT's size and mounting height.

**7.9.4 Test Data**

**7.9.4.1 Band-edge Compliance**

Test Date : April 13, 2015

Temp.:21°C, Humi:58%

Mode of EUT : ( 1ch: 2412 MHz, (IEEE 802.11b))

Antenna Polarization : Horizontal

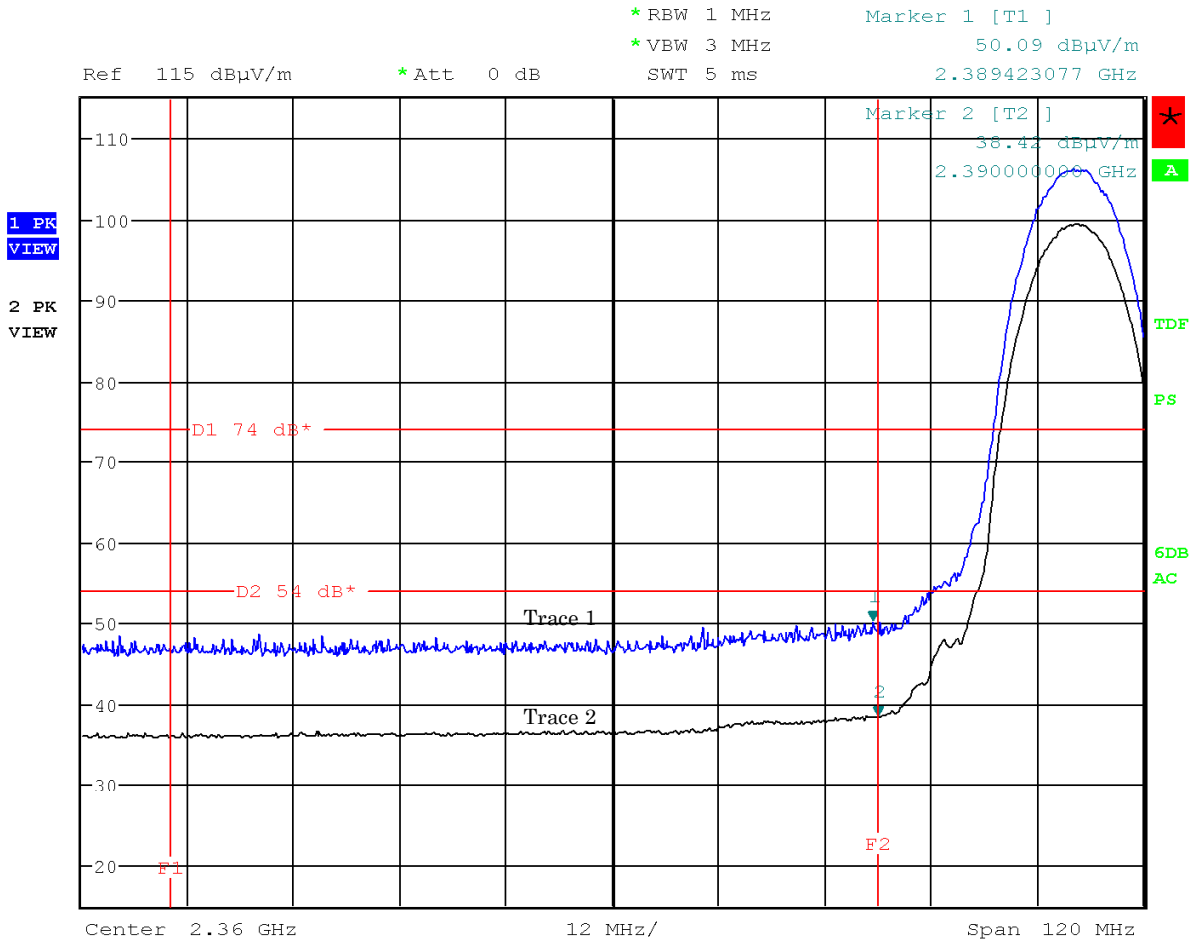

Note: The trace 1 is Peak . The trace 2 is Average.

Mode of EUT : ( 1ch: 2412 MHz, (IEEE 802.11b))

Antenna Polarization : Vertical

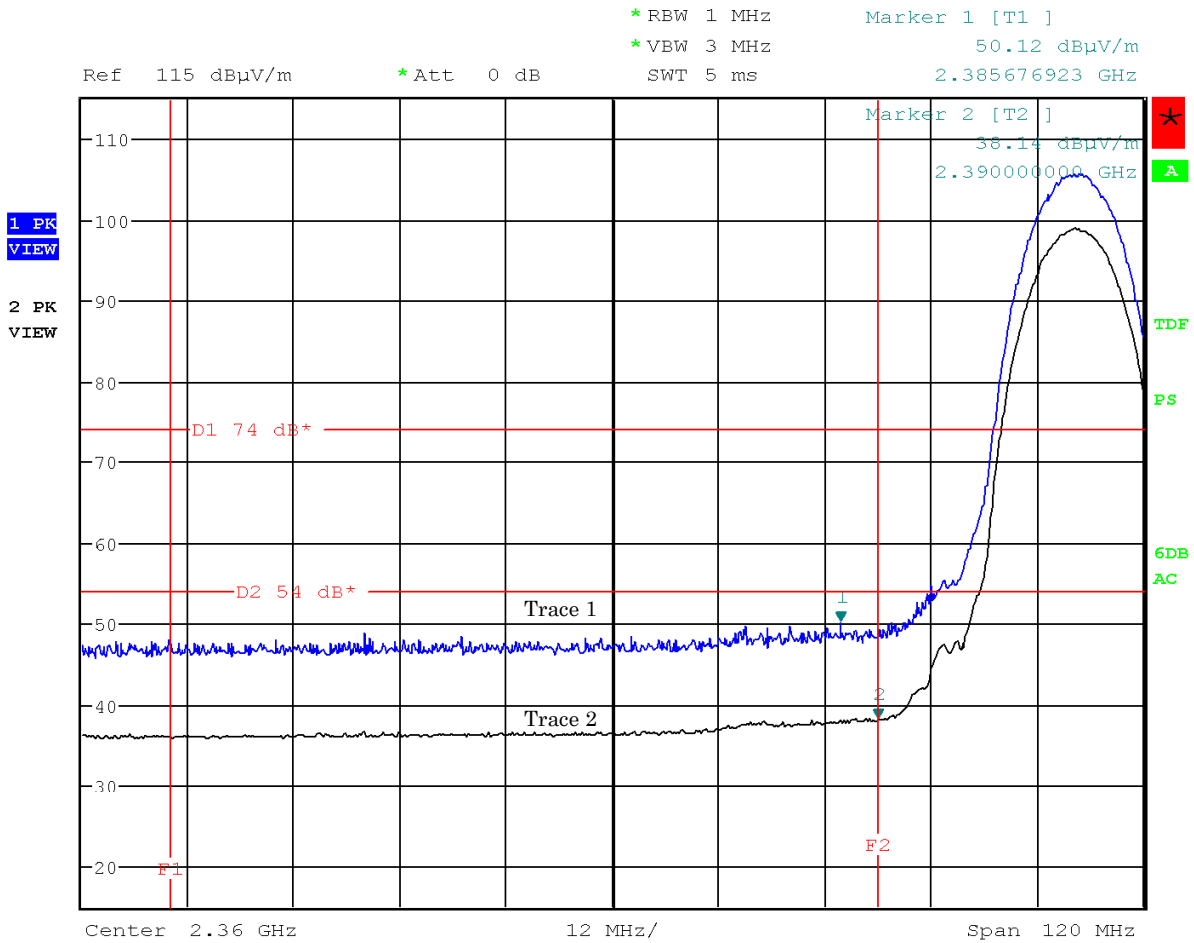

Note: The trace 1 is Peak . The trace 2 is Average.

Mode of EUT : ( 11ch: 2462 MHz, (IEEE 802.11b))

Antenna Polarization : Horizontal

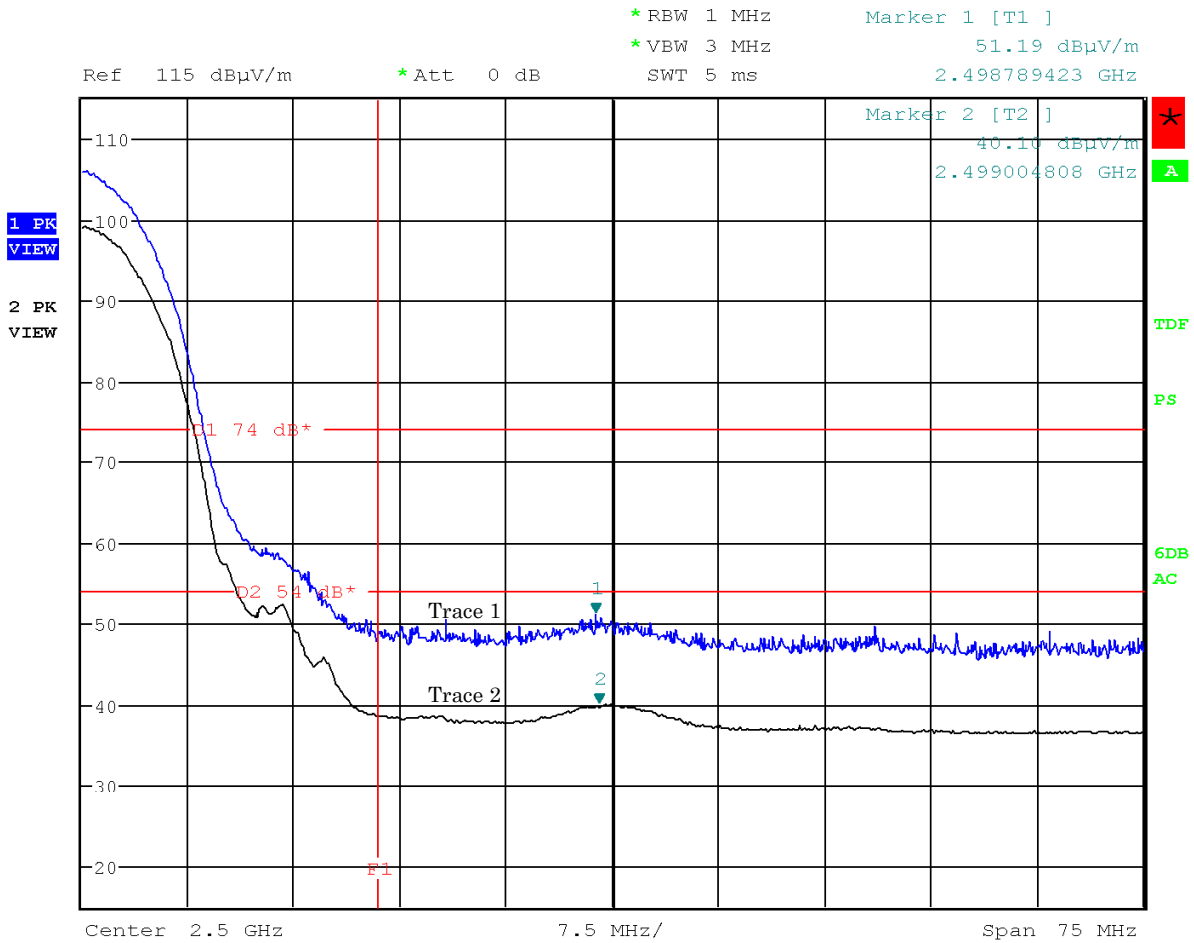

Note: The trace 1 is Peak . The trace 2 is Average.

Mode of EUT : ( 11ch: 2462 MHz, (IEEE 802.11b))

Antenna Polarization : Vertical

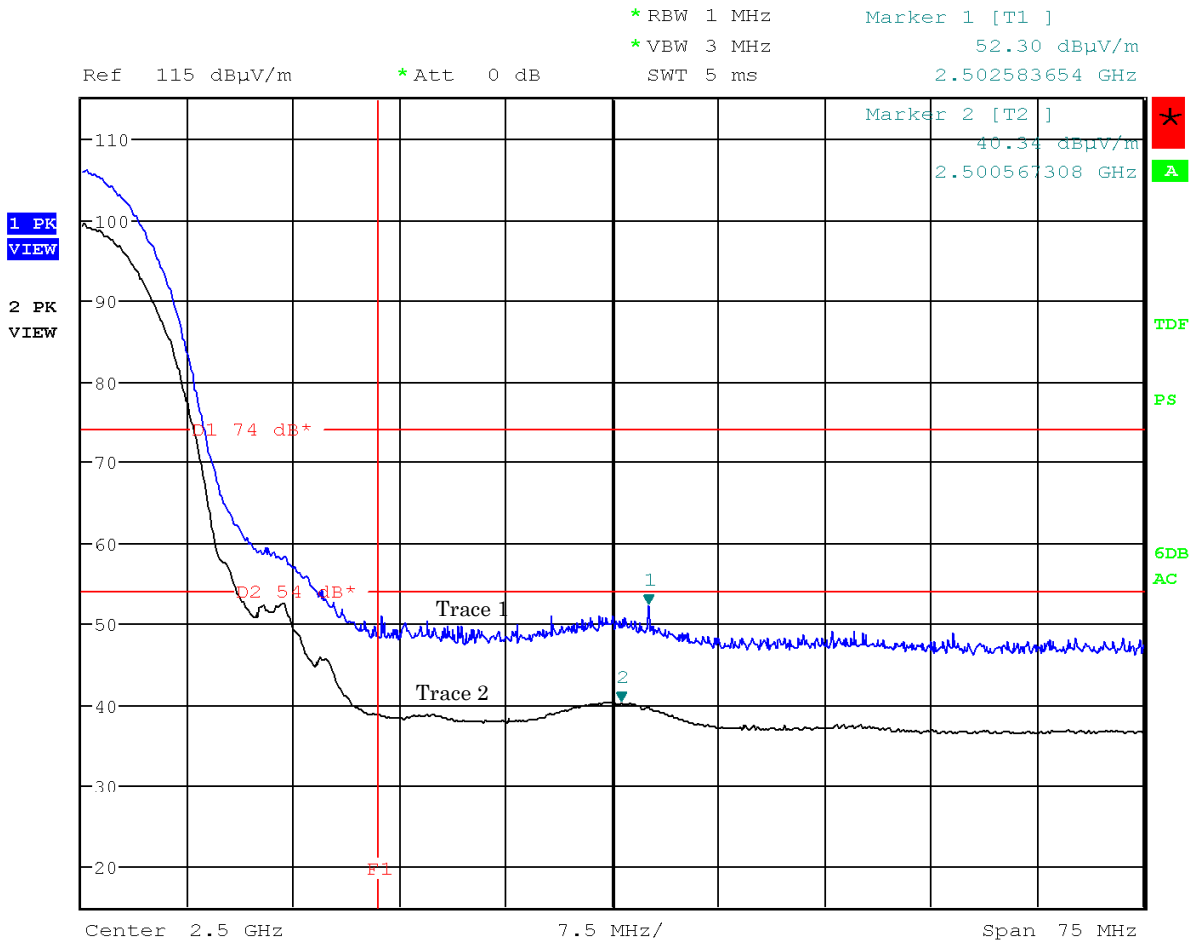

Note: The trace 1 is Peak . The trace 2 is Average.

Mode of EUT : ( 1ch: 2412 MHz, (IEEE 802.11g))

Antenna Polarization : Horizontal

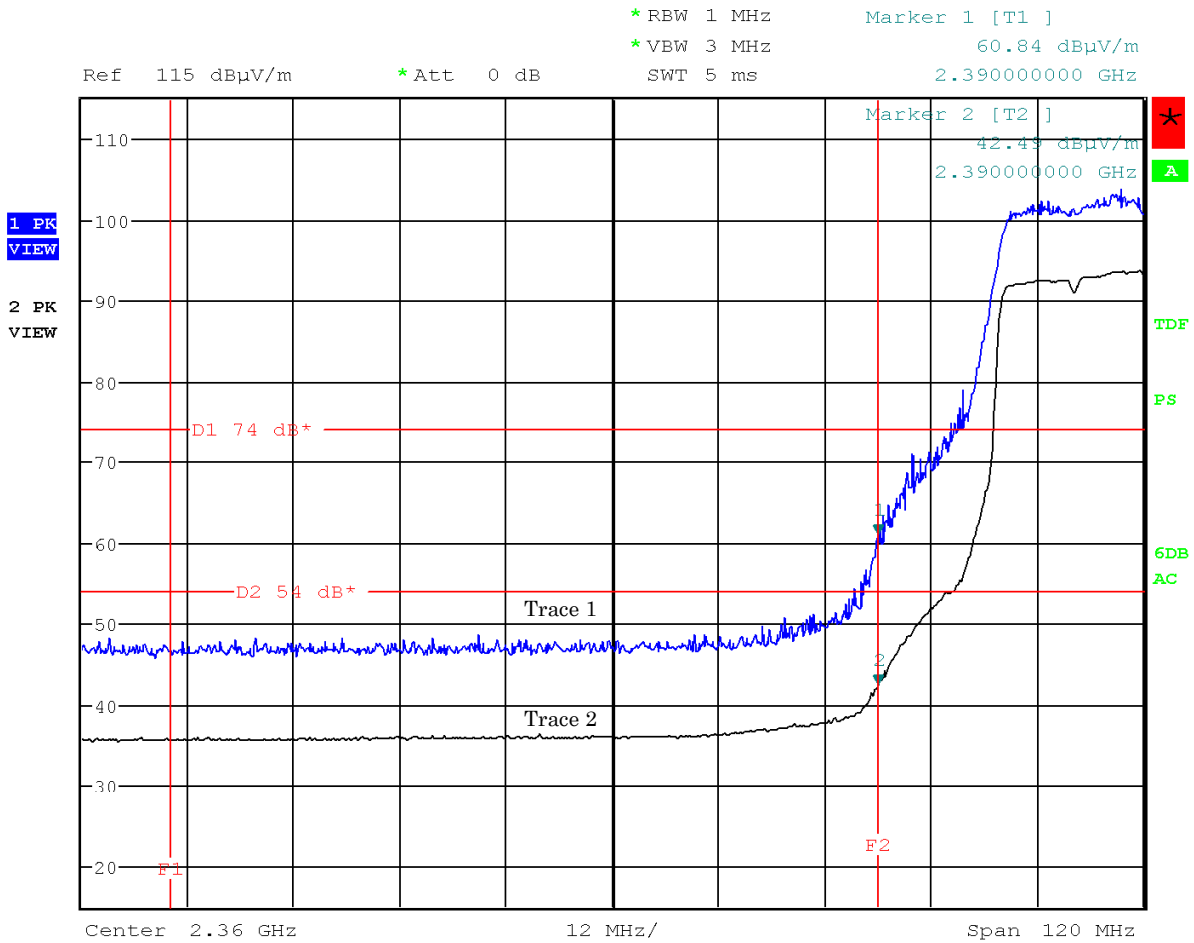

Note: The trace 1 is Peak . The trace 2 is Average.

Mode of EUT : ( 1ch: 2412 MHz, (IEEE 802.11g))

Antenna Polarization : Vertical

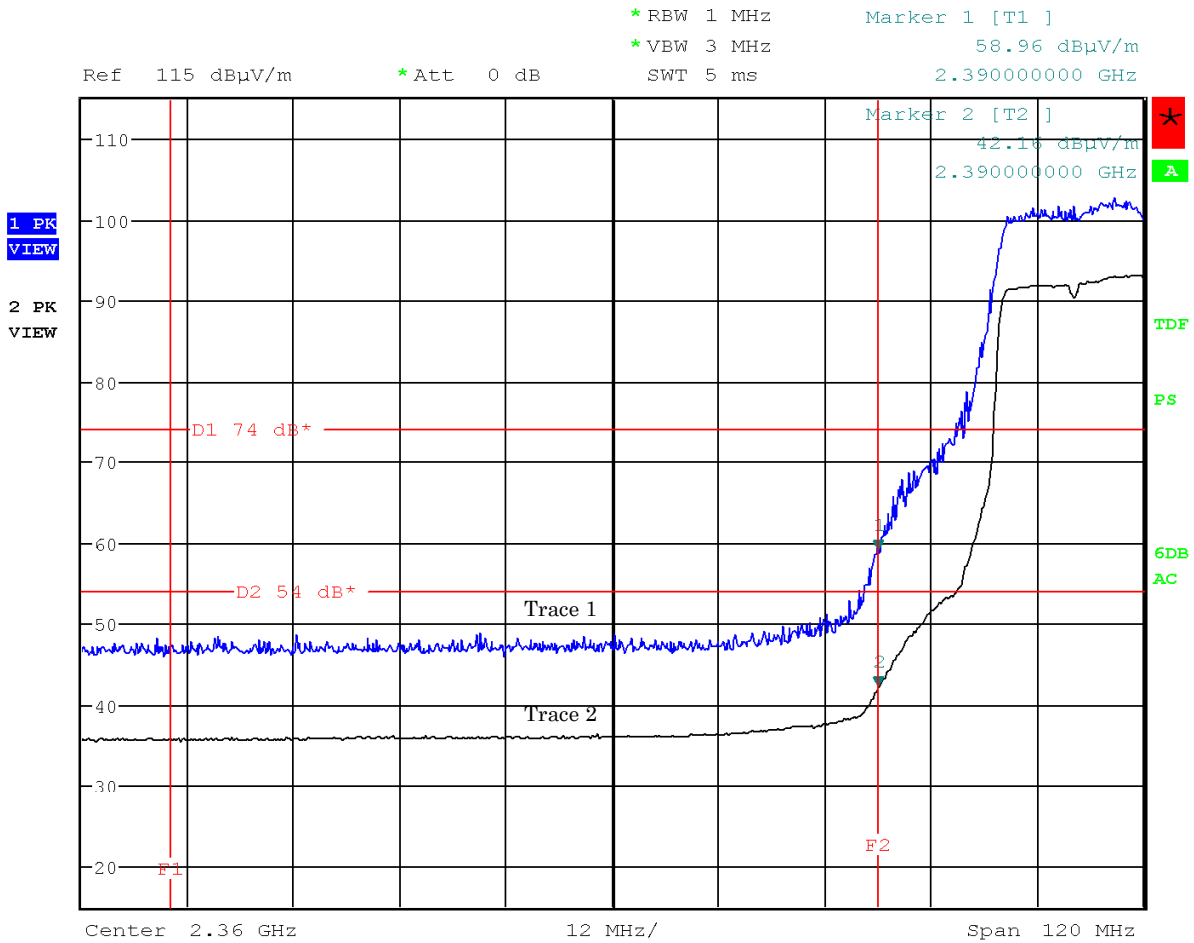

Note: The trace 1 is Peak . The trace 2 is Average.



Mode of EUT : ( 11ch: 2462 MHz, (IEEE 802.11g))

Antenna Polarization : Horizontal

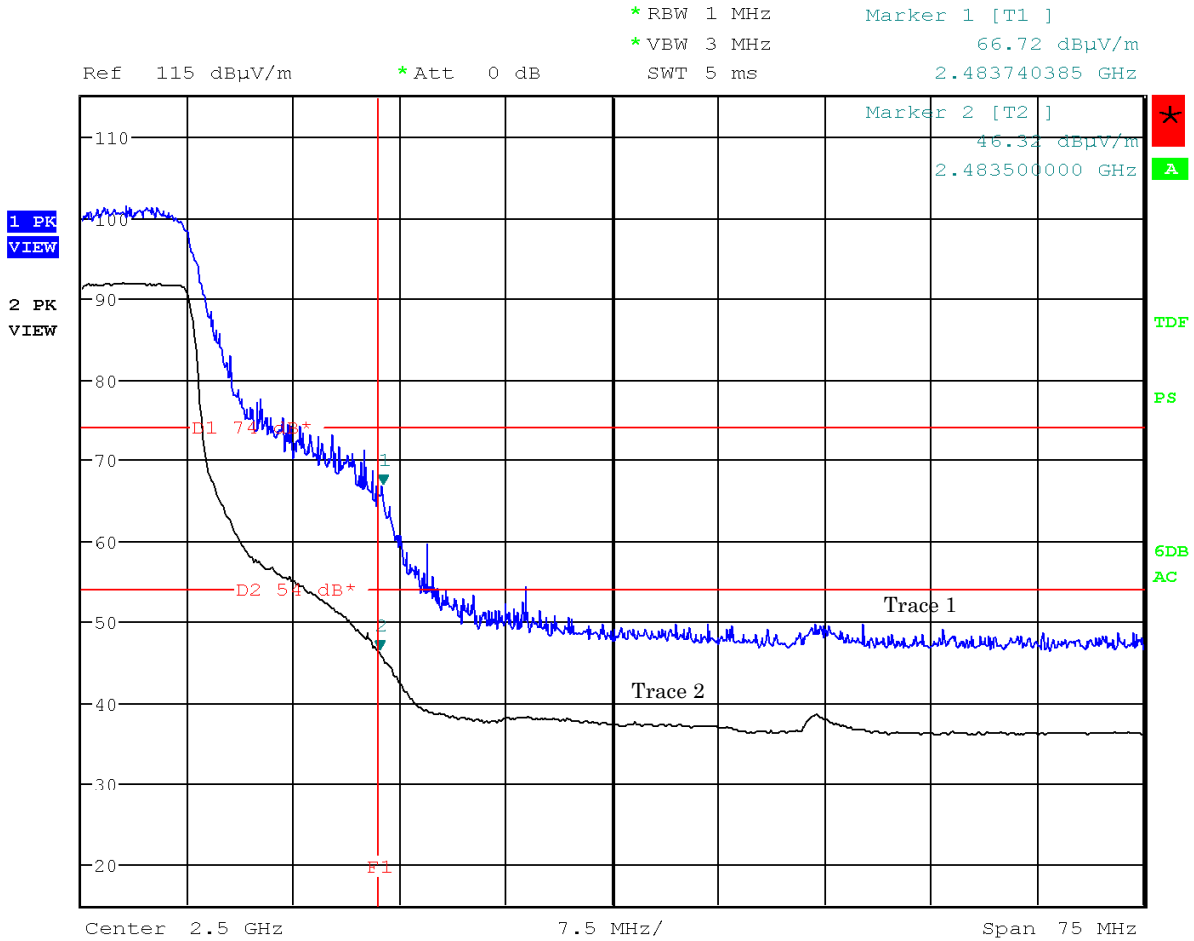

Note: The trace 1 is Peak . The trace 2 is Average.

Mode of EUT : ( 11ch: 2462 MHz, (IEEE 802.11g))

Antenna Polarization : Vertical

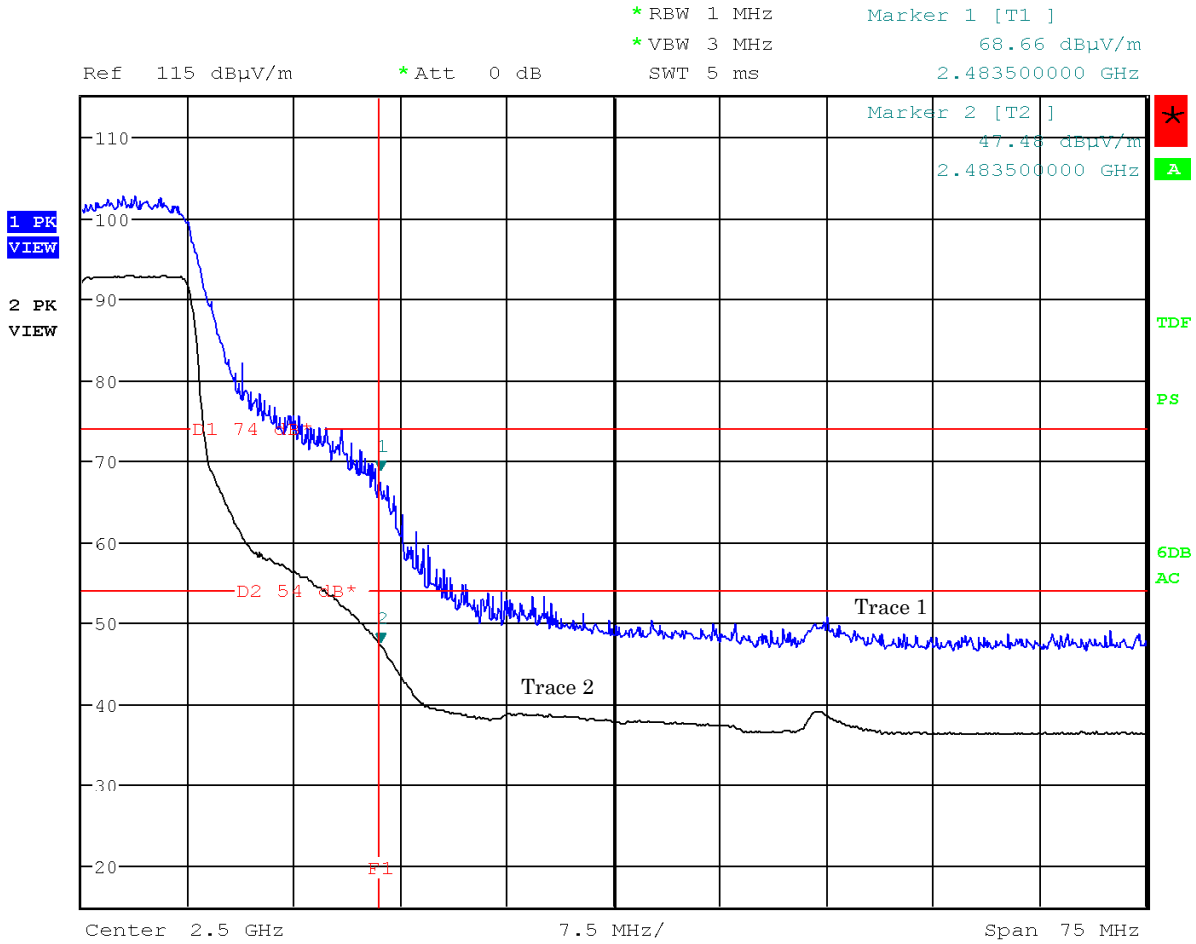

Note: The trace 1 is Peak . The trace 2 is Average.

Mode of EUT : ( 1ch: 2412 MHz, (IEEE 802.11n))

Antenna Polarization : Horizontal

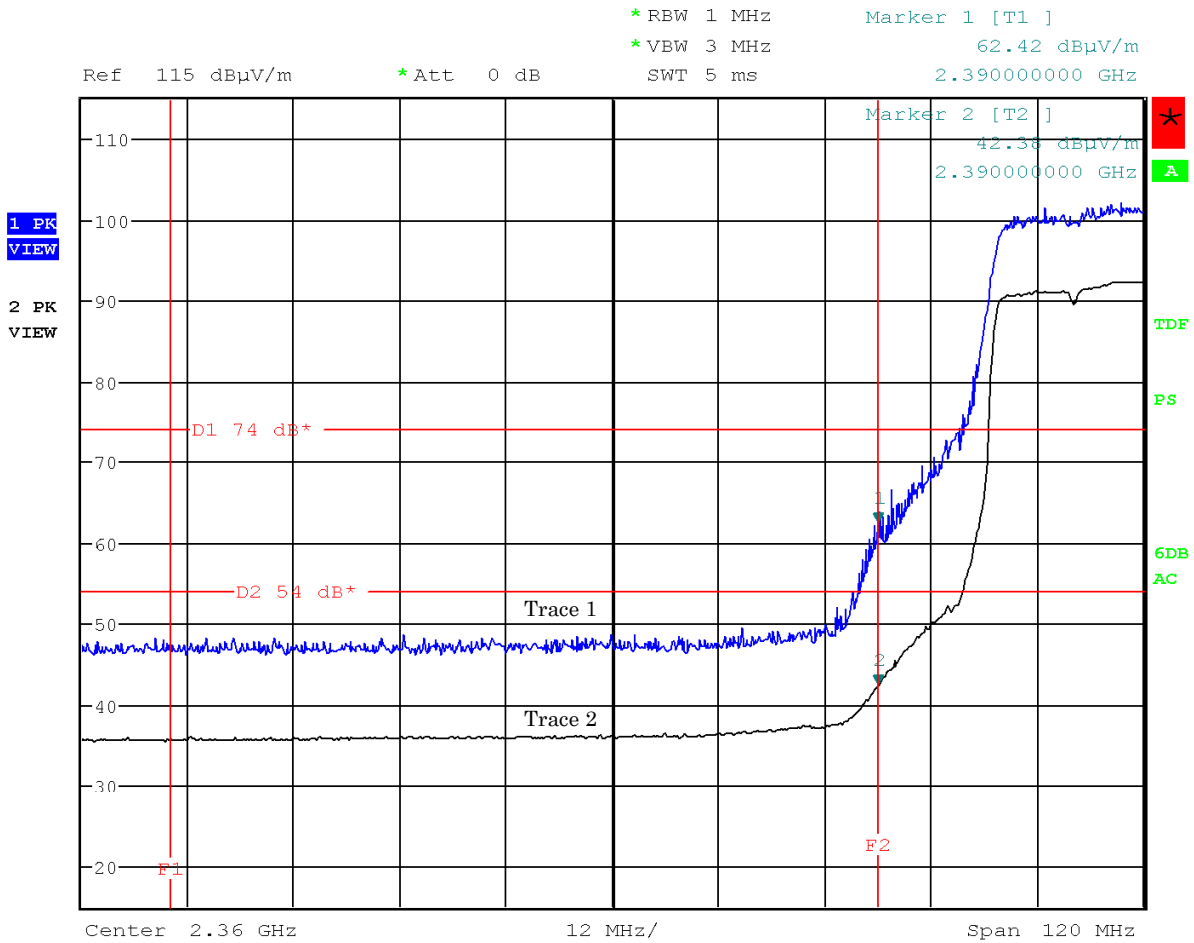

Note: The trace 1 is Peak . The trace 2 is Average.

Mode of EUT : ( 1ch: 2412 MHz, (IEEE 802.11n))

Antenna Polarization : Vertical

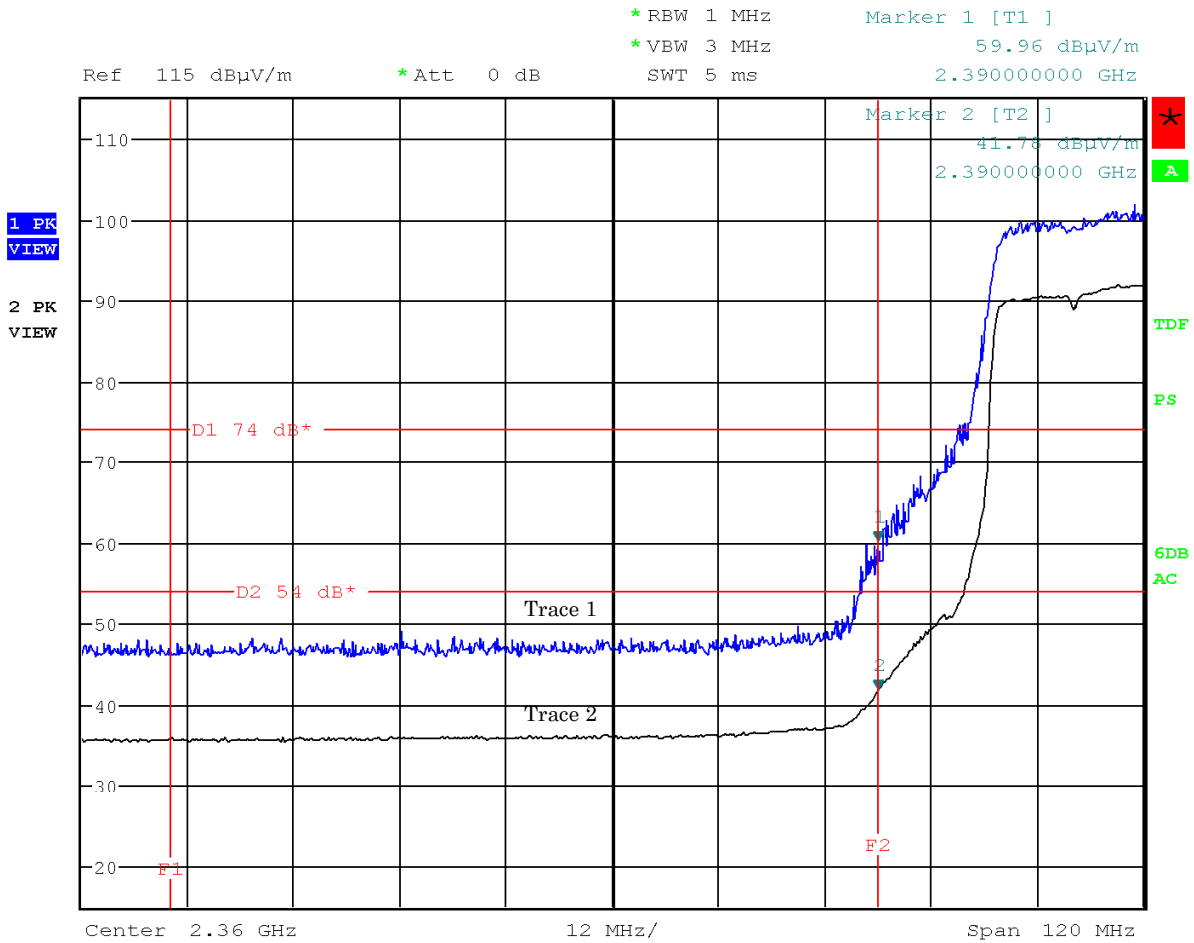

Note: The trace 1 is Peak . The trace 2 is Average.

Mode of EUT : ( 11ch: 2462 MHz, (IEEE 802.11n))

Antenna Polarization : Horizontal

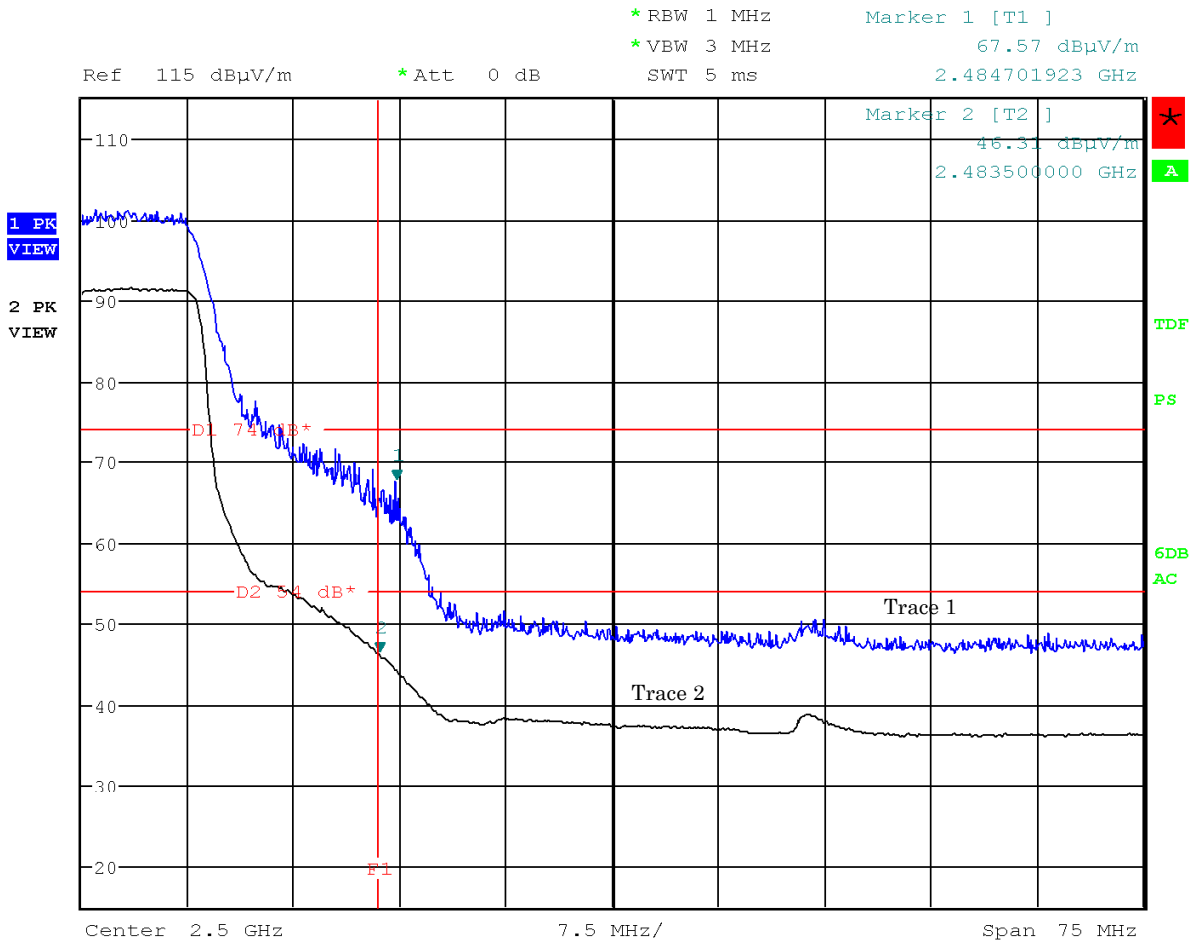

Note: The trace 1 is Peak . The trace 2 is Average.

Mode of EUT : ( 11ch: 2462 MHz, (IEEE 802.11n))

Antenna Polarization : Vertical

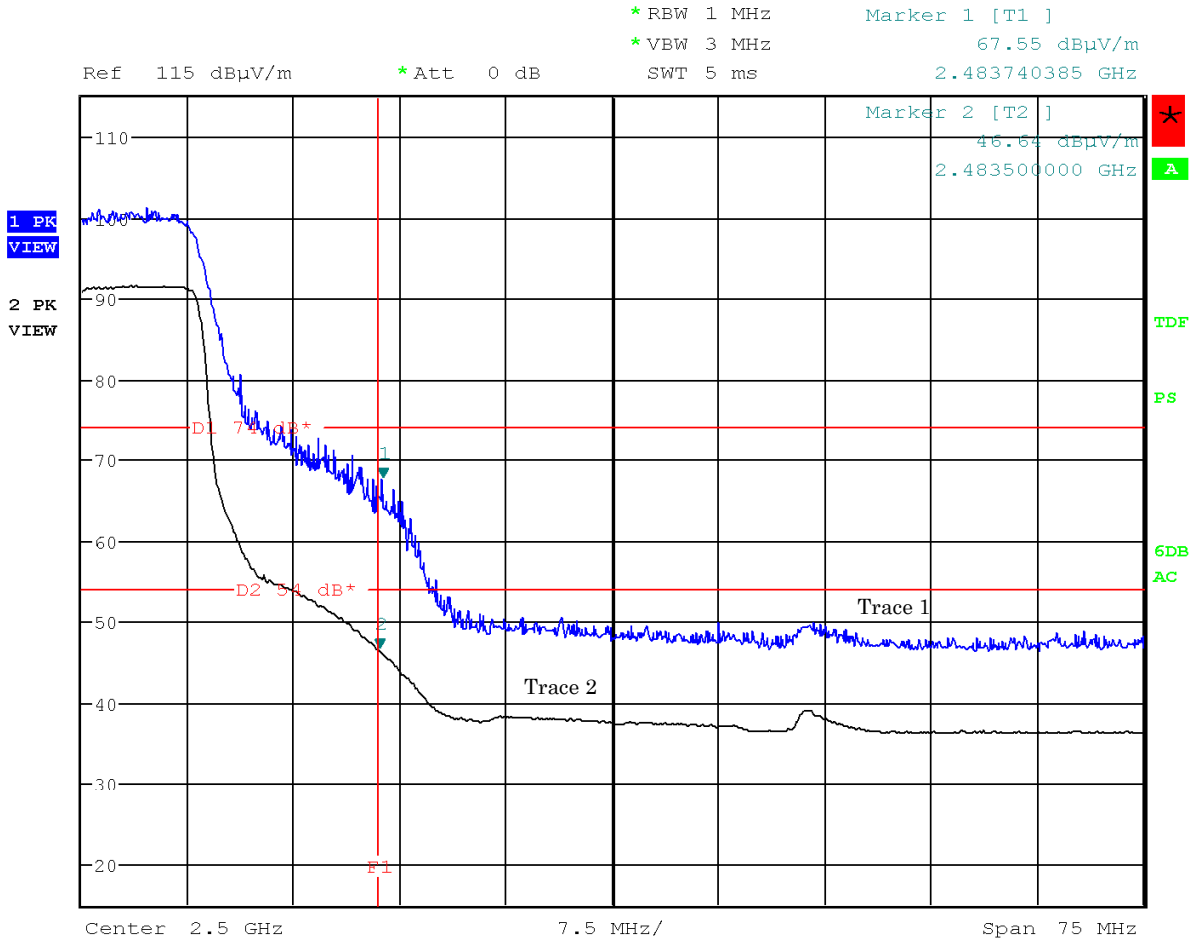

Note: The trace 1 is Peak . The trace 2 is Average.

Mode of EUT : Bluetooth Low Energy, Hopping off (0ch: 2402 MHz)

Antenna Polarization : Horizontal

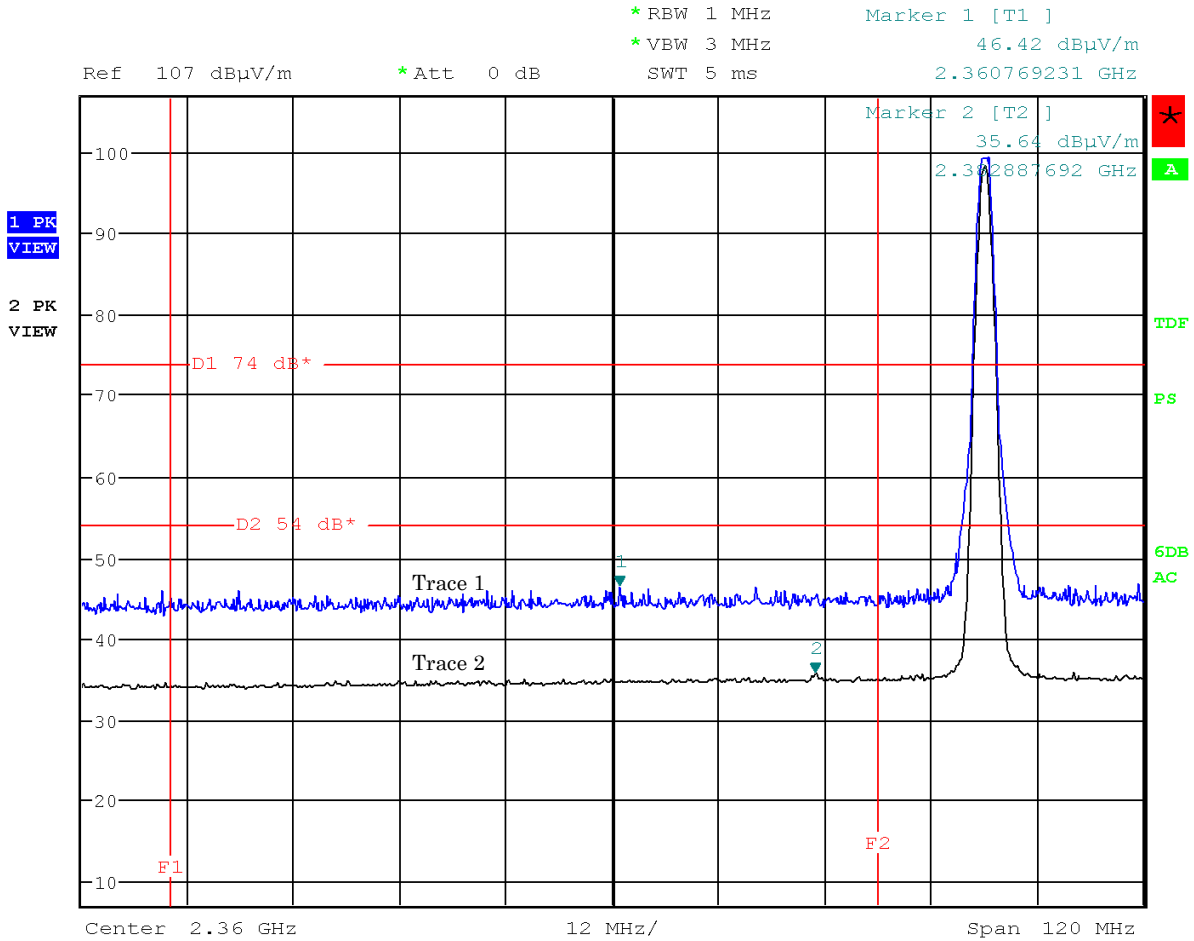

Note: The trace 1 is Peak . The trace 2 is Average.

Mode of EUT : Bluetooth Low Energy, Hopping off (Och: 2402 MHz)

Antenna Polarization : Vertical

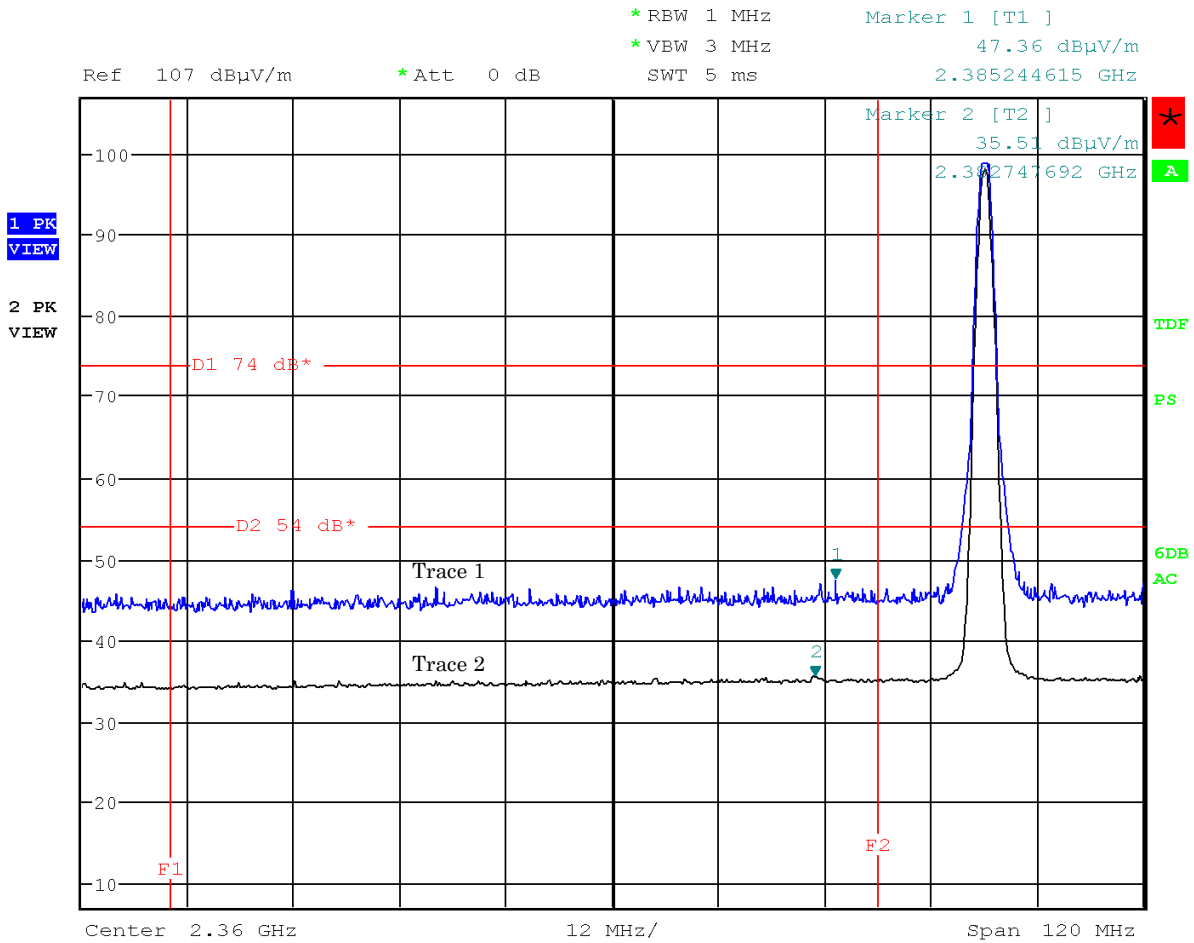

Note: The trace 1 is Peak . The trace 2 is Average.



Mode of EUT : Bluetooth Low Energy, Hopping off (39ch: 2480 MHz)

Antenna Polarization : Horizontal

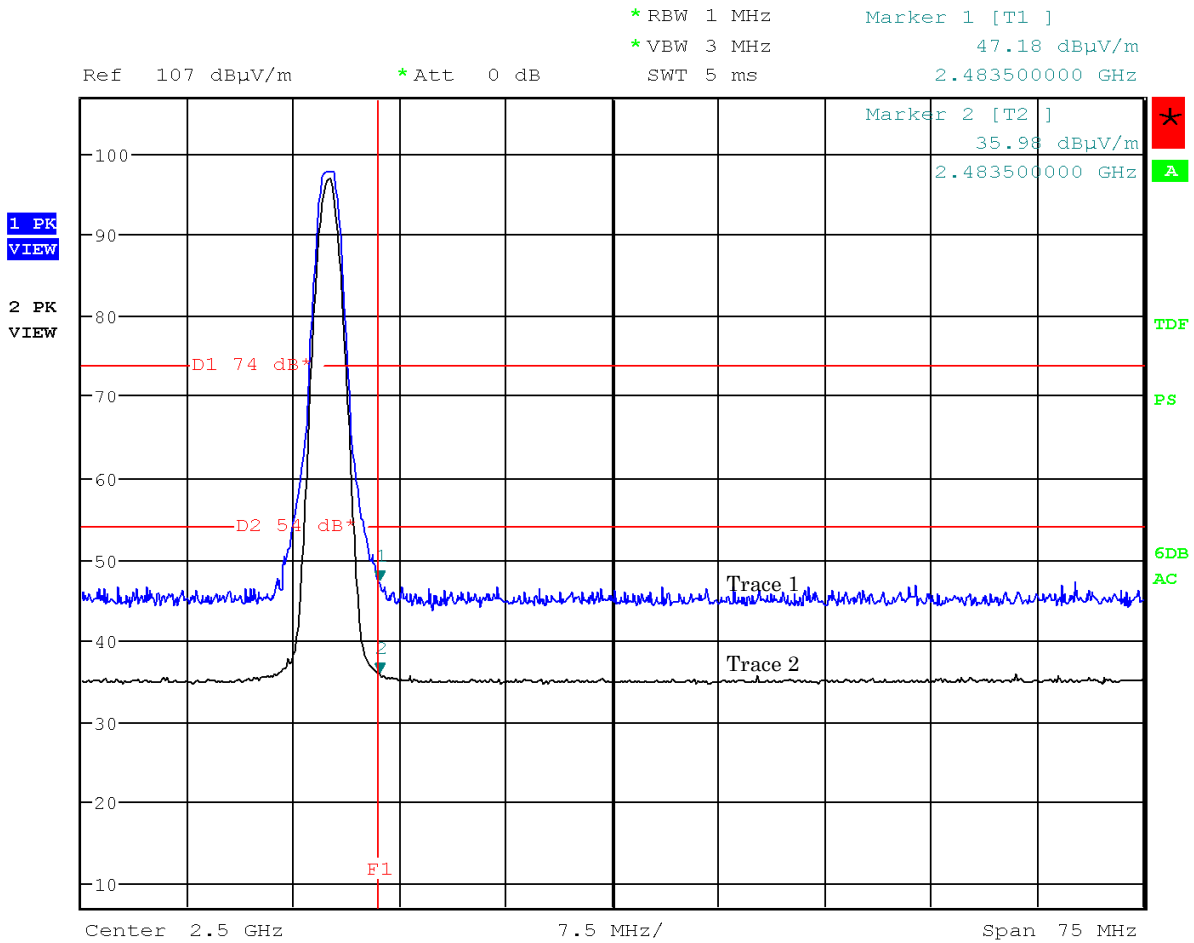

Note: The trace 1 is Peak . The trace 2 is Average.

Mode of EUT : Bluetooth Low Energy, Hopping off (39ch: 2480 MHz)

Antenna Polarization : Vertical

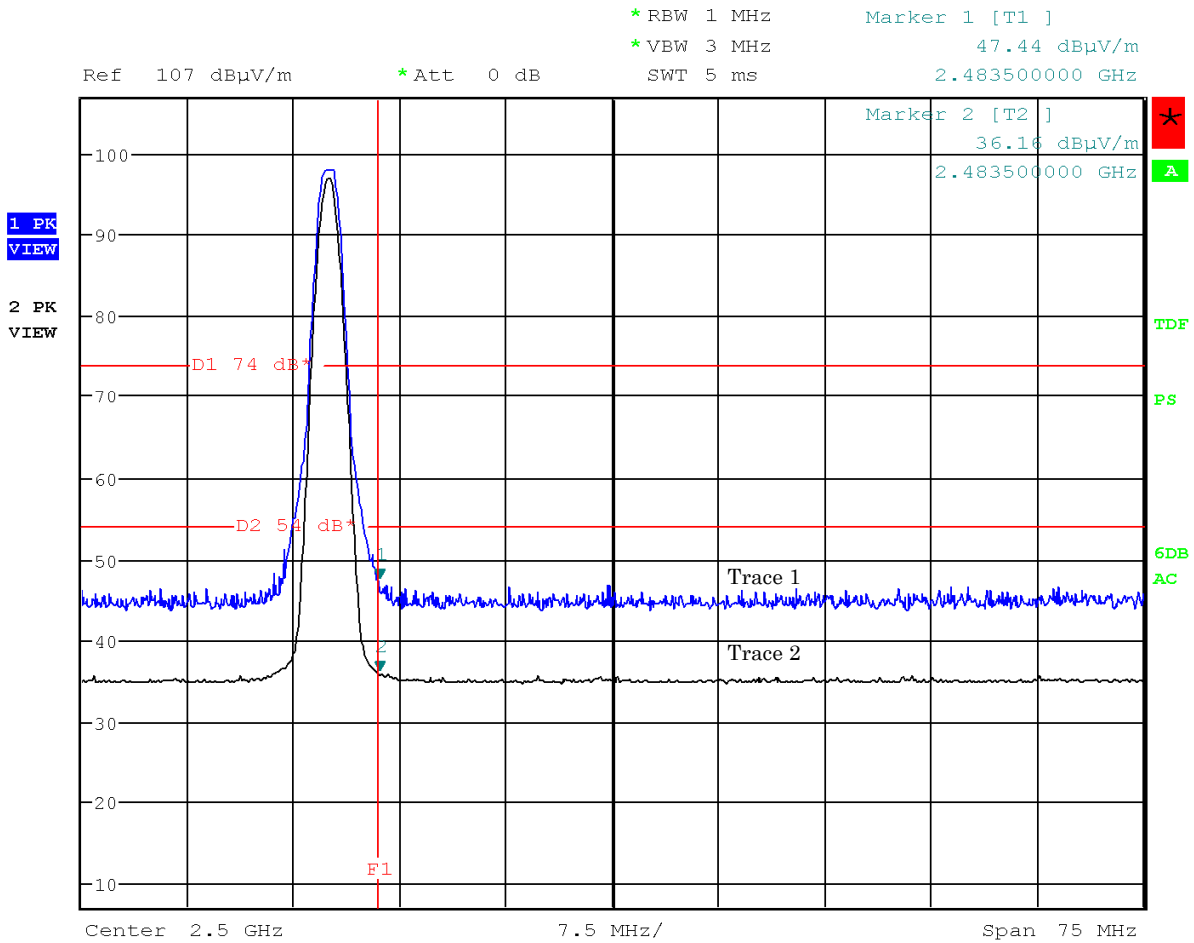

Note: The trace 1 is Peak . The trace 2 is Average.

**7.9.4.2 Other Spurious Emission (9kHz – 30MHz)**

Test Date : April 14, 2015

Temp.:21°C, Humi:70%

Mode of EUT : WLAN/Bluetooth LE

Results : No spurious emissions in the range 20dB below the limit.

**7.9.4.3 Other Spurious Emission (30MHz – 1000MHz)**

Mode of EUT : (WLAN) All modes have been investigated and the worst case mode for channel (06ch: 2437MHz / IEEE802.11b, IEEE802.11g and IEEE802.11n) has been listed.

Test Date: April 14, 2015  
Temp.: 21 °C, Humi: 70 %

Antenna pole : Horizontal

Frequency [MHz]	Antenna Factor [dB(1/m)]	Corr. Factor [dB]	Meter Readings [dB(μV)]	Limits [dB(μV/m)]	Results [dB(μV/m)]	Margin [dB]	Remarks
205.29	16.6	-25.8	29.0	43.5	19.8	+23.7	-
410.57	16.5	-24.6	30.3	46.0	22.2	+23.8	-

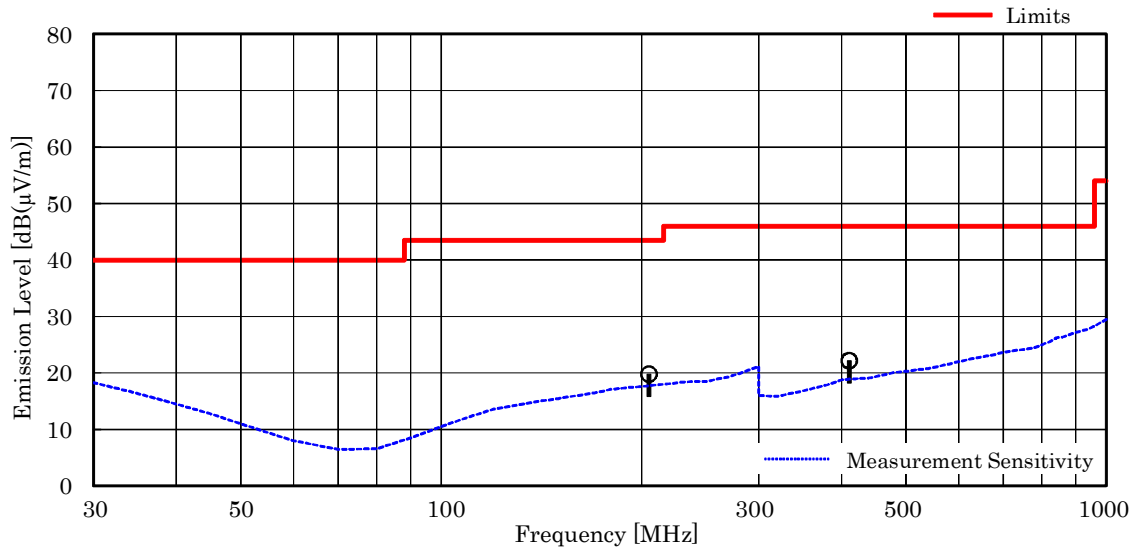

NOTES

1. Test Distance : 3 m
2. The spectrum was checked from 30 MHz to 1000 MHz.
3. The correction factor is composed of cable loss, pad attenuation and/or amplifier gain.
4. The symbol of “<” means “or less”.
5. The symbol of “>” means “more than”.
6. Calculated result at 205.29 MHz, as the worst point shown on underline:  
 Antenna Factor + Coorection Factor + Meter Reading = 16.6 + (-25.8) + 29.0 = 19.8 dB(μV/m)  
 Antenna Height : 1.67 m, Turntable Angle : 73 °
7. Test receiver setting(s) : CISPR QP 120 kHz (QP : Quasi-Peak)

Test Date: April 14, 2015  
 Temp.: 21 °C, Humi: 70 %

Antenna pole : Vertical

Frequency [MHz]	Antenna Factor [dB(1/m)]	Corr. Factor [dB]	Meter Readings [dB(μV)]	Limits [dB(μV/m)]	Results [dB(μV/m)]	Margin [dB]	Remarks
30.10	18.8	-27.5	30.7	40.0	22.0	+18.0	-
<u>45.26</u>	13.0	-27.3	39.3	40.0	25.0	+15.0	-
73.21	6.3	-26.9	36.9	40.0	16.3	+23.7	-

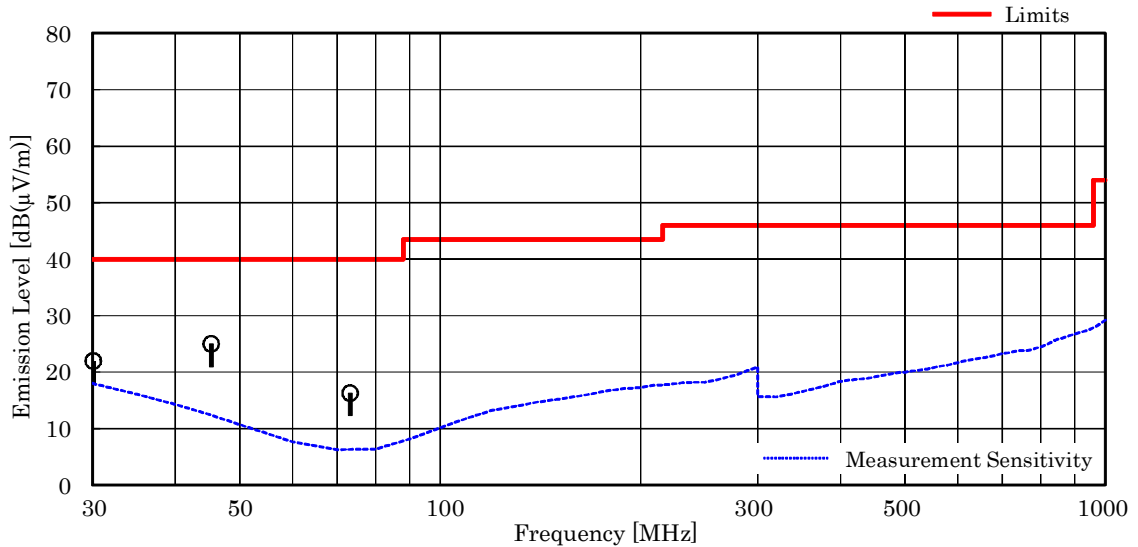

NOTES

1. Test Distance : 3 m
2. The spectrum was checked from 30 MHz to 1000 MHz.
3. The correction factor is composed of cable loss, pad attenuation and/or amplifier gain.
4. The symbol of "<" means "or less".
5. The symbol of ">" means "more than".
6. Calculated result at 45.26 MHz, as the worst point shown on underline:  
 Antenna Factor + Coorection Factor + Meter Reading = 13.0 + (-27.3) + 39.3 = 25.0 dB(μV/m)  
 Antenna Height : 1.00 m, Turntable Angle : 167 °
7. Test receiver setting(s) : CISPR QP 120 kHz (QP : Quasi-Peak)

Mode of EUT : Bluetooth Low Energy

Test Date: April 15, 2015  
 Temp.: 20 °C, Humi: 61 %

Antenna pole : Horizontal

Frequency [MHz]	Antenna Factor [dB(1/m)]	Corr. Factor [dB]	Meter Readings [dB(μV)]	Limits [dB(μV/m)]	Results [dB(μV/m)]	Margin [dB]	Remarks
205.29	16.6	-25.8	28.5	43.5	19.3	+24.2	-
410.58	16.5	-24.6	30.9	46.0	22.8	+23.2	-

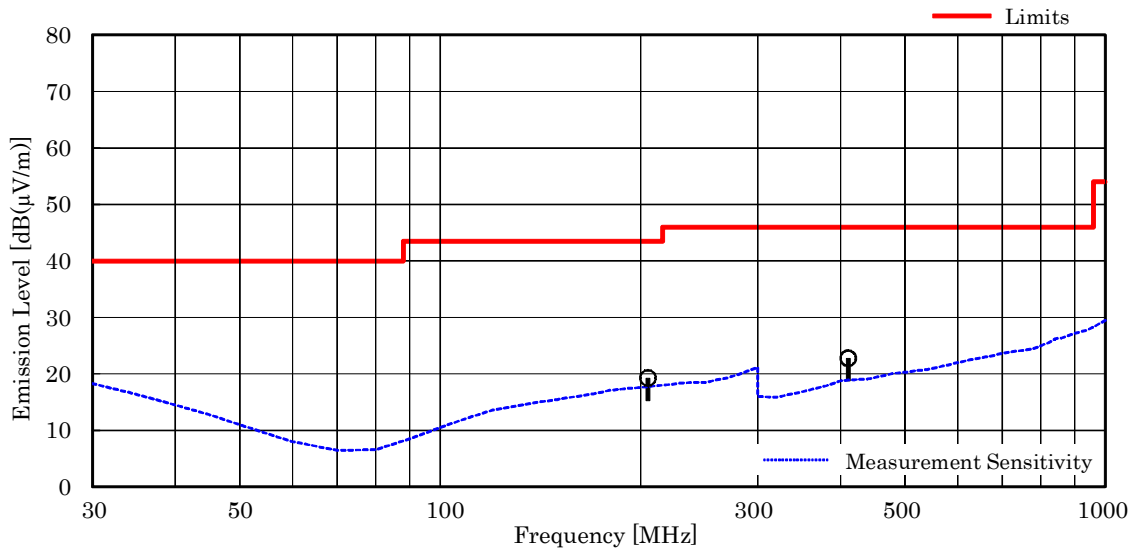

NOTES

1. Test Distance : 3 m
2. The spectrum was checked from 30 MHz to 1000 MHz.
3. The correction factor is composed of cable loss, pad attenuation and/or amplifier gain.
4. The symbol of "<" means "or less".
5. The symbol of ">" means "more than".
6. Calculated result at 410.58 MHz, as the worst point shown on underline:  
 Antenna Factor + Coorection Factor + Meter Reading = 16.5 + (-24.6) + 30.9 = 22.8 dB(μV/m)  
 Antenna Height : 1.00 m, Turntable Angle : 38 °
7. Test receiver setting(s) : CISPR QP 120 kHz (QP : Quasi-Peak)

Test Date: April 15, 2015  
Temp.: 20 °C, Humi: 61 %

Antenna pole : Vertical

Frequency [MHz]	Antenna Factor [dB(1/m)]	Corr. Factor [dB]	Meter Readings [dB(μV)]	Limits [dB(μV/m)]	Results [dB(μV/m)]	Margin [dB]	Remarks
75.08	6.3	-26.9	30.6	40.0	10.0	+30.0	-

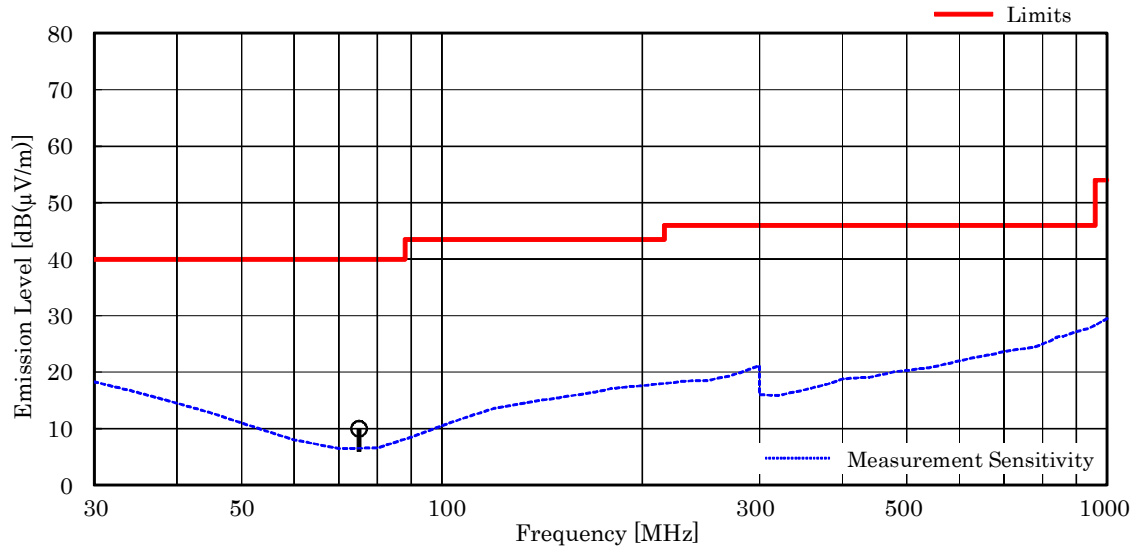

NOTES

1. Test Distance : 3 m
2. The spectrum was checked from 30 MHz to 1000 MHz.
3. The correction factor is composed of cable loss, pad attenuation and/or amplifier gain.
4. The symbol of "<" means "or less".
5. The symbol of ">" means "more than".
6. Calculated result at 75.08 MHz, as the worst point shown on underline:  
 $\text{Antenna Factor} + \text{Coorection Factor} + \text{Meter Reading} = 6.3 + (-26.9) + 30.6 = 10.0 \text{ dB}(\mu\text{V/m})$   
 Antenna Height : 1.28 m, Turntable Angle : 167 °
7. Test receiver setting(s) : CISPR QP 120 kHz (QP : Quasi-Peak)

**7.9.4.4 Other Spurious Emission (Above 1000MHz)**

**7.9.4.4.1 Mode of TX**

**7.9.4.4.1.1 IEEE802.11b**

Test Date: April 13, 2015  
 Temp.: 21 °C, Humi: 58 %

Frequency [MHz]	Antenna Factor [dB(1/m)]	Corr. Factor [dB]	Meter Readings [dB(μV)]				Limits [dB(μV/m)]		Results [dB(μV/m)]		Margin [dB]	Remarks
			Horizontal		Vertical		PK	AVE	PK	AVE		
			PK	AVE	PK	AVE	PK	AVE	PK	AVE		
<b>Test condition : Tx Low Ch</b>												
4824.0	27.3	-16.1	< 38.0	< 28.0	< 38.0	< 28.0	74.0	54.0	< 49.2	< 39.2	> +14.8	
12060.0	33.6	-25.9	< 38.0	< 28.0	< 38.0	< 28.0	74.0	54.0	< 45.7	< 35.7	> +18.3	
19296.0	40.5	-42.8	< 50.0	< 40.0	< 50.0	< 40.0	74.0	54.0	< 47.7	< 37.7	> +16.3	
<b>Test condition : TX Middle Ch</b>												
4874.0	27.3	-16.1	< 38.0	< 28.0	< 38.0	< 28.0	74.0	54.0	< 49.2	< 39.2	> +14.8	
<u>7311.0</u>	<u>29.8</u>	<u>-16.8</u>	< 38.0	< 28.0	< 38.0	< 28.0	74.0	54.0	< 51.0	< 41.0	> +13.0	
12185.0	33.5	-26.3	< 38.0	< 28.0	< 38.0	< 28.0	74.0	54.0	< 45.2	< 35.2	> +18.8	
19496.0	40.5	-42.8	< 50.0	< 40.0	< 50.0	< 40.0	74.0	54.0	< 47.7	< 37.7	> +16.3	
<b>Test condition : TX High Ch</b>												
4924.0	27.3	-16.0	< 38.0	< 28.0	< 38.0	< 28.0	74.0	54.0	< 49.3	< 39.3	> +14.7	
7386.0	29.8	-16.9	< 38.0	< 28.0	< 38.0	< 28.0	74.0	54.0	< 50.9	< 40.9	> +13.1	
12310.0	33.4	-26.6	< 38.0	< 28.0	< 38.0	< 28.0	74.0	54.0	< 44.8	< 34.8	> +19.2	
19696.0	40.5	-42.9	< 50.0	< 40.0	< 50.0	< 40.0	74.0	54.0	< 47.6	< 37.6	> +16.4	
22158.0	40.6	-43.3	< 50.0	< 40.0	< 50.0	< 40.0	74.0	54.0	< 47.3	< 37.3	> +16.7	

Calculated result at 7311.0 MHz, as the worst point shown on underline:

Antenna Factor	=	29.8 dB(1/m)
Corr. Factor	=	-16.8 dB
+ ) Meter Reading	=	<28.0 dB(μV)
Result	=	<41.0 dB(μV/m)

Minimum Margin: 54.0 - <41.0 = >13.0 (dB)

**NOTES**

1. Test Distance : 3 m
2. The spectrum was checked from 1 GHz to 25 GHz (10th harmonic of the highest fundamental frequency).
3. The correction factor is shown as follows:
  - Corr. Factor [dB] = Cable Loss + 20dB Pad Att. - Pre-Amp. Gain [dB] (1.0 - 7.6GHz)
  - Corr. Factor [dB] = Cable Loss + 10dB Pad Att. - Pre-Amp. Gain [dB] (7.6 - 18.0GHz)
  - Corr. Factor [dB] = Cable Loss - Pre-Amp. Gain [dB] (over 18 GHz)
4. The symbol of "<" means "or less".
5. The symbol of ">" means "more than".
6. PK : Peak / AVE : Average

7.9.4.4.1.2 IEEE802.11g

Test Date: April 13, 2015  
 Temp.: 21 °C, Humi: 58 %

Frequency [MHz]	Antenna Factor [dB(1/m)]	Corr. Factor [dB]	Meter Readings [dB(μV)]				Limits [dB(μV/m)]		Results [dB(μV/m)]		Margin [dB]	Remarks
			Horizontal		Vertical		PK	AVE	PK	AVE		
<b>Test condition : Tx Low Ch</b>												
4824.0	27.3	-16.1	< 38.0	< 28.0	< 38.0	< 28.0	74.0	54.0	< 49.2	< 39.2	> +14.8	
12060.0	33.6	-25.9	< 38.0	< 28.0	< 38.0	< 28.0	74.0	54.0	< 45.7	< 35.7	> +18.3	
19296.0	40.5	-42.8	< 50.0	< 40.0	< 50.0	< 40.0	74.0	54.0	< 47.7	< 37.7	> +16.3	
<b>Test condition : TX Middle Ch</b>												
4874.0	27.3	-16.1	< 38.0	< 28.0	< 38.0	< 28.0	74.0	54.0	< 49.2	< 39.2	> +14.8	
7311.0	29.8	-16.8	< 38.0	< 28.0	< 38.0	< 28.0	74.0	54.0	< 51.0	< 41.0	> +13.0	
12185.0	33.5	-26.3	< 38.0	< 28.0	< 38.0	< 28.0	74.0	54.0	< 45.2	< 35.2	> +18.8	
19496.0	40.5	-42.8	< 50.0	< 40.0	< 50.0	< 40.0	74.0	54.0	< 47.7	< 37.7	> +16.3	
<b>Test condition : TX High Ch</b>												
4924.0	27.3	-16.0	< 38.0	< 28.0	< 38.0	< 28.0	74.0	54.0	< 49.3	< 39.3	> +14.7	
7386.0	29.8	-16.9	< 38.0	< 28.0	< 38.0	< 28.0	74.0	54.0	< 50.9	< 40.9	> +13.1	
12310.0	33.4	-26.6	< 38.0	< 28.0	< 38.0	< 28.0	74.0	54.0	< 44.8	< 34.8	> +19.2	
19696.0	40.5	-42.9	< 50.0	< 40.0	< 50.0	< 40.0	74.0	54.0	< 47.6	< 37.6	> +16.4	
22158.0	40.6	-43.3	< 50.0	< 40.0	< 50.0	< 40.0	74.0	54.0	< 47.3	< 37.3	> +16.7	

Calculated result at 7311.0 MHz, as the worst point shown on underline:

Antenna Factor	=	29.8 dB(1/m)
Corr. Factor	=	-16.8 dB
+ ) Meter Reading	=	<28.0 dB(μV)
Result	=	<41.0 dB(μV/m)

Minimum Margin: 54.0 - <41.0 = >13.0 (dB)

NOTES

1. Test Distance : 3 m
2. The spectrum was checked from 1 GHz to 25 GHz (10th harmonic of the highest fundamental frequency).
3. The correction factor is shown as follows:
  - Corr. Factor [dB] = Cable Loss + 20dB Pad Att. - Pre-Amp. Gain [dB] (1.0 - 7.6GHz)
  - Corr. Factor [dB] = Cable Loss + 10dB Pad Att. - Pre-Amp. Gain [dB] (7.6 - 18.0GHz)
  - Corr. Factor [dB] = Cable Loss - Pre-Amp. Gain [dB] (over 18 GHz)
4. The symbol of "<" means "or less".
5. The symbol of ">" means "more than".
6. PK : Peak / AVE : Average



7.9.4.4.1.3 IEEE802.11n

Test Date: April 13, 2015  
Temp.: 21 °C, Humi: 58 %

Frequency [MHz]	Antenna Factor [dB(1/m)]	Corr. Factor [dB]	Meter Readings [dB(μV)]				Limits [dB(μV/m)]		Results [dB(μV/m)]		Margin [dB]	Remarks
			Horizontal		Vertical		PK	AVE	PK	AVE		
<b>Test condition : Tx Low Ch</b>												
4824.0	27.3	-16.1	< 38.0	< 28.0	< 38.0	< 28.0	74.0	54.0	< 49.2	< 39.2	> +14.8	
12060.0	33.6	-25.9	< 38.0	< 28.0	< 38.0	< 28.0	74.0	54.0	< 45.7	< 35.7	> +18.3	
19296.0	40.5	-42.8	< 50.0	< 40.0	< 50.0	< 40.0	74.0	54.0	< 47.7	< 37.7	> +16.3	
<b>Test condition : TX Middle Ch</b>												
4874.0	27.3	-16.1	< 38.0	< 28.0	< 38.0	< 28.0	74.0	54.0	< 49.2	< 39.2	> +14.8	
7311.0	29.8	-16.8	< 38.0	< 28.0	< 38.0	< 28.0	74.0	54.0	< 51.0	< 41.0	> +13.0	
12185.0	33.5	-26.3	< 38.0	< 28.0	< 38.0	< 28.0	74.0	54.0	< 45.2	< 35.2	> +18.8	
19496.0	40.5	-42.8	< 50.0	< 40.0	< 50.0	< 40.0	74.0	54.0	< 47.7	< 37.7	> +16.3	
<b>Test condition : TX High Ch</b>												
4924.0	27.3	-16.0	< 38.0	< 28.0	< 38.0	< 28.0	74.0	54.0	< 49.3	< 39.3	> +14.7	
7386.0	29.8	-16.9	< 38.0	< 28.0	< 38.0	< 28.0	74.0	54.0	< 50.9	< 40.9	> +13.1	
12310.0	33.4	-26.6	< 38.0	< 28.0	< 38.0	< 28.0	74.0	54.0	< 44.8	< 34.8	> +19.2	
19696.0	40.5	-42.9	< 50.0	< 40.0	< 50.0	< 40.0	74.0	54.0	< 47.6	< 37.6	> +16.4	
22158.0	40.6	-43.3	< 50.0	< 40.0	< 50.0	< 40.0	74.0	54.0	< 47.3	< 37.3	> +16.7	

Calculated result at 7311.0 MHz, as the worst point shown on underline:

Antenna Factor	=	29.8 dB(1/m)
Corr. Factor	=	-16.8 dB
+ ) Meter Reading	=	<28.0 dB(μV)
Result	=	<41.0 dB(μV/m)

Minimum Margin: 54.0 - <41.0 = >13.0 (dB)

NOTES

1. Test Distance : 3 m
2. The spectrum was checked from 1 GHz to 25 GHz (10th harmonic of the highest fundamental frequency).
3. The correction factor is shown as follows:
  - Corr. Factor [dB] = Cable Loss + 20dB Pad Att. - Pre-Amp. Gain [dB] (1.0 - 7.6GHz)
  - Corr. Factor [dB] = Cable Loss + 10dB Pad Att. - Pre-Amp. Gain [dB] (7.6 - 18.0GHz)
  - Corr. Factor [dB] = Cable Loss - Pre-Amp. Gain [dB] (over 18 GHz)
4. The symbol of "<" means "or less".
5. The symbol of ">" means "more than".
6. PK : Peak / AVE : Average

7.9.4.4.1.4 Bluetooth Low Energy

Test Date: April 13, 2015  
 Temp.: 21 °C, Humi: 58 %

Frequency [MHz]	Antenna Factor [dB(1/m)]	Corr. Factor [dB]	Meter Readings [dB(μV)]				Limits [dB(μV/m)]		Results [dB(μV/m)]		Margin [dB]	Remarks
			Horizontal		Vertical		PK	AVE	PK	AVE		
<b>Test condition : Tx Low Ch</b>												
4804.0	27.3	-16.1	< 38.0	< 28.0	< 38.0	< 28.0	74.0	54.0	< 49.2	< 39.2	> +14.8	
12010.0	33.7	-25.8	< 38.0	< 28.0	< 38.0	< 28.0	74.0	54.0	< 45.9	< 35.9	> +18.1	
19216.0	40.5	-42.9	< 50.0	< 40.0	< 50.0	< 40.0	74.0	54.0	< 47.6	< 37.6	> +16.4	
<b>Test condition : TX Middle Ch</b>												
4880.0	27.3	-16.0	< 38.0	< 28.0	< 38.0	< 28.0	74.0	54.0	< 49.3	< 39.3	> +14.7	
7320.0	29.8	-16.8	< 38.0	< 28.0	< 38.0	< 28.0	74.0	54.0	< 51.0	< 41.0	> +13.0	
12200.0	33.5	-26.3	< 38.0	< 28.0	< 38.0	< 28.0	74.0	54.0	< 45.2	< 35.2	> +18.8	
19520.0	40.4	-42.8	< 50.0	< 40.0	< 50.0	< 40.0	74.0	54.0	< 47.6	< 37.6	> +16.4	
<b>Test condition : TX High Ch</b>												
4960.0	27.3	-16.0	< 38.0	< 28.0	< 38.0	< 28.0	74.0	54.0	< 49.3	< 39.3	> +14.7	
7440.0	29.8	-17.0	< 38.0	< 28.0	< 38.0	< 28.0	74.0	54.0	< 50.8	< 40.8	> +13.2	
12400.0	33.5	-26.8	< 38.0	< 28.0	< 38.0	< 28.0	74.0	54.0	< 44.7	< 34.7	> +19.3	
19840.0	40.4	-43.0	< 50.0	< 40.0	< 50.0	< 40.0	74.0	54.0	< 47.4	< 37.4	> +16.6	
22320.0	40.6	-43.4	< 50.0	< 40.0	< 50.0	< 40.0	74.0	54.0	< 47.2	< 37.2	> +16.8	

Calculated result at 7320.0 MHz, as the worst point shown on underline:

Antenna Factor	=	29.8 dB(1/m)
Corr. Factor	=	-16.8 dB
+ ) Meter Reading	=	<28.0 dB(μV)
Result	=	<41.0 dB(μV/m)

Minimum Margin: 54.0 - <41.0 = >13.0 (dB)

NOTES

1. Test Distance : 3 m
2. The spectrum was checked from 1 GHz to 25 GHz (10th harmonic of the highest fundamental frequency).
3. The correction factor is shown as follows:
  - Corr. Factor [dB] = Cable Loss + 20dB Pad Att. - Pre-Amp. Gain [dB] (1.0 - 7.6GHz)
  - Corr. Factor [dB] = Cable Loss + 10dB Pad Att. - Pre-Amp. Gain [dB] (7.6 - 18.0GHz)
  - Corr. Factor [dB] = Cable Loss - Pre-Amp. Gain [dB] (over 18 GHz)
4. The symbol of "<" means "or less".
5. The symbol of ">" means "more than".
6. PK : Peak / AVE : Average

7.9.4.4.2 Mode of RX (WLAN)

Test Date: April 13, 2015  
 Temp.: 21 °C, Humi: 58 %

Frequency [MHz]	Antenna Factor [dB(1/m)]	Corr. Factor [dB]	Meter Readings [dB(μV)]				Limits [dB(μV/m)]		Results [dB(μV/m)]		Margin [dB]	Remarks
			Horizontal		Vertical		PK	AVE	PK	AVE		
<b>Test condition : RX Middle Ch</b>												
2437.0	21.5	-18.8	< 38.0	< 28.0	< 38.0	< 28.0	74.0	54.0	< 40.7	< 30.7	> +23.3	
4874.0	27.3	-16.4	< 38.0	< 28.0	< 38.0	< 28.0	74.0	54.0	< 48.9	< 38.9	> +15.1	
7311.0	29.8	-17.1	< 38.0	< 28.0	< 38.0	< 28.0	74.0	54.0	< 50.7	< 40.7	> +13.3	

Calculated result at 4874.0 MHz, as the worst point shown on underline:

Antenna Factor	=	27.3 dB(1/m)
Corr. Factor	=	-16.4 dB
+ ) Meter Reading	=	<28.0 dB(μV)
Result	=	<38.9 dB(μV/m)

Minimum Margin: 54.0 - <38.9 = >13.3 (dB)

NOTES

1. Test Distance : 3 m
2. The spectrum was checked from 1 GHz to 7.5 GHz .
3. The correction factor is shown as follows:  
 Corr. Factor [dB] = Cable Loss + 20dB Pad Att. - Pre-Amp. Gain [dB] (1.0 - 7.6GHz)
4. The symbol of "<" means "or less".
5. The symbol of ">" means "more than".
6. PK : Peak / AVE : Average

**7.9.4.4.3 Mode of RX (Bluetooth Low Energy)**

Test Date: April 13, 2015  
Temp: 21 °C, Humi: 58 %

Frequency [MHz]	Antenna Factor [dB(1/m)]	Corr. Factor [dB]	Meter Readings [dB(μV)]				Limits [dB(μV/m)]		Results [dB(μV/m)]		Margin [dB]	Remarks
			Horizontal		Vertical		PK	AVE	PK	AVE		
<b>Test condition : RX Middle Ch</b>												
2440.0	21.5	-18.8	< 38.0	< 28.0	< 38.0	< 28.0	74.0	54.0	< 40.7	< 30.7	> +23.3	
4880.0	27.3	-16.3	< 38.0	< 28.0	< 38.0	< 28.0	74.0	54.0	< 49.0	< 39.0	> +15.0	
7320.0	29.8	-17.1	< 38.0	< 28.0	< 38.0	< 28.0	74.0	54.0	< 50.7	< 40.7	> +13.3	

Calculated result at 7320.0 MHz, as the worst point shown on underline:

Antenna Factor	=	29.8 dB(1/m)
Corr. Factor	=	-17.1 dB
+ ) Meter Reading	=	<28.0 dB(μV)
Result	=	<40.7 dB(μV/m)

Minimum Margin: 54.0 - <40.7 = >13.3 (dB)

**NOTES**

1. Test Distance : 3 m
2. The spectrum was checked from 1 GHz to 7.5 GHz .
3. The correction factor is shown as follows:  
 Corr. Factor [dB] = Cable Loss + 20dB Pad Att. - Pre-Amp. Gain [dB] (1.0 - 7.6GHz)
4. The symbol of "<" means "or less".
5. The symbol of ">" means "more than".
6. PK : Peak / AVE : Average