

TEST REPORT

Applicant : Sharp Corporation, Communication Systems Division
Address : 2-13-1, Iida Hachihonmatsu, Higashi-Hiroshima City, Hiroshima,
739-0192, JAPAN

Products : Smart Phone
Model No. : SH-04G
Serial No. : 004401115451136

FCC ID : APYHRO00223

Test Standard : CFR 47 FCC Rules and Regulations Part 15

Test Results : **Passed**

Date of Test : April 10 ~ 16, 2015



A handwritten signature in black ink, appearing to read 'K. Shibata', is written over a horizontal line.

Kousei Shibata
Manager
Japan Quality Assurance Organization
KITA-KANSAI Testing Center
SAITO EMC Branch
7-3-10, Saito-asagi, Ibaraki-shi, Osaka 567-0085, Japan

-
- The measurement values stated in Test Report was made with traceable to National Institute of Advanced Industrial Science and Technology (AIST) of Japan and National Institute of Information and Communications Technology (NICT) of Japan.
 - The applicable standard, testing condition and testing method which were used for the tests are based on the request of the applicant.
 - The test results presented in this report relate only to the offered test sample.
 - The contents of this test report cannot be used for the purposes, such as advertisement for consumers.
 - This test report shall not be reproduced except in full without the written approval of JQA.
 - VLAC does not approve, certify or warrant the product by this test report.

TABLE OF CONTENTS

	Page
1 Description of the Equipment Under Test	3
2 Summary of Test Results	4
3 Test Procedure.....	5
4 Test Location	5
5 Recognition of Test Laboratory	5
6 Description of Test Setup	6
7 Test Requirements	7

DEFINITIONS FOR ABBREVIATION AND SYMBOLS USED IN THIS TEST REPORT**EUT** : Equipment Under Test**AE** : Associated Equipment**N/A** : Not Applicable**N/T** : Not Tested**EMC** : Electromagnetic Compatibility**EMI** : Electromagnetic Interference**EMS** : Electromagnetic Susceptibility - indicates that the listed condition, standard or equipment is applicable for this report. - indicates that the listed condition, standard or equipment is not applicable for this report.

1 Description of the Equipment Under Test

1. Manufacturer : Sharp Corporation, Communication Systems Division
2-13-1, Iida Hachihonmatsu, Higashi-Hiroshima City, Hiroshima,
739-0192, JAPAN
2. Products : Smart Phone
3. Model No. : SH-04G
4. Serial No. : 004401115451136
5. Product Type : Pre-production
6. Date of Manufacture : February, 2015
7. Power Rating : 4.0VDC(Lithium-ion Battery UBATIA263AFN1 2450mAh)
8. Grounding : None
9. Transmitting Frequency : 13.560 MHz
10. Receiving Frequency : 13.560 MHz
11. Antenna Type : Internal Antenna (Integral)
12. EUT Authorization : Certification
13. Received Date of EUT : April 10, 2015

2 Summary of Test Results

Applied Standard : CFR 47 FCC Rules and Regulations Part 15
Subpart C – Intentional Radiators

The EUT described in clause 1 was tested according to the applied standard shown above.
Details of the test configuration is shown in clause 6.

The conclusion for the test items of which are required by the applied standard is indicated under the test result.

- The test result was **passed** for the test requirements of the applied standard.
- The test result was **failed** for the test requirements of the applied standard.
- The test result was **not judged** the test requirements of the applied standard.

In the approval of test results,

- Determining compliance with the limits in this report was based on the results of the compliance measurement, not taking into account measurement instrumentation uncertainty.
- No deviations were employed from the applied standard.
- No modifications were conducted by JQA to achieve compliance to the limitations.

Reviewed by:

Tested by:



Shigeru Kinoshita
Assistant Manager
JQA KITA-KANSAI Testing Center
SAITO EMC Branch



Shigeru Osawa
Deputy Manager
JQA KITA-KANSAI Testing Center
SAITO EMC Branch

3 Test Procedure

Test Requirements : §15.225, §15.207 and §15.209

Test Procedure : ANSI C63.4-2003

4 Test Location

Japan Quality Assurance Organization (JQA)
KITA-KANSAI Testing Center
7-7, Ishimaru, 1-chome, Minoh-shi, Osaka, 562-0027, Japan
SAITO EMC Branch
7-3-10, Saito-asagi, Ibaraki-shi, Osaka 567-0085, Japan

5 Recognition of Test Laboratory

JQA KITA-KANSAI Testing Center SAITO EMC Branch is accredited under ISO/IEC 17025 by following accreditation bodies and the test facility is registered by the following bodies.

VLAC Accreditation No. : VLAC-001-2 (Expiry date : March 30, 2016)
VCCI Registration No. : A-0002 (Expiry date : March 30, 2016)
BSMI Registration No. : SL2-IS-E-6006, SL2-IN-E-6006, SL2-R1/R2-E-6006, SL2-A1-E-6006
(Expiry date : September 14, 2016)
IC Registration No. : 2079E-3, 2079E-4 (Expiry date : July 16, 2017)

Accredited as conformity assessment body for Japan electrical appliances and material law by METI.
(Expiry date : February 22, 2016)

6 Description of Test Setup

6.1 Test Configuration

The equipment under test (EUT) consists of :

	Item	Manufacturer	Model No.	Serial No.	FCC ID
A	Smart Phone	Sharp	SH-04G	004401115451136	APYHRO00223

The auxiliary equipment used for testing :

None

Type of Cable:

None

6.2 Test Arrangement (Drawings)

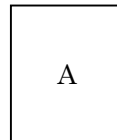

6.3 Operating Condition

The test were carried under 4 mode shown as follows:

1. Felica (Modulation Type : ASK)
2. ISO/IEC14443 Type A (Modulation Type : ASK)
3. ISO/IEC14443 Type B (Modulation Type : ASK)
4. ISO/IEC15693 Type V (Modulation Type : ASK)

The Radiated Emission test were carried under 1 test configurations shown in clause 6.2.
In all tests, the fully charged battery is used for the EUT.

Detailed Transmitter portion:

Transmitter frequency : 13.560 MHz

Detailed Receiver portion:

Receiver frequency : 13.560 MHz

Other Clock Frequency

19.2MHz, 27.12MHz

The EUT was rotated through three orthogonal axis (X, Y and Z axis) in radiated measurement.

7 Test Requirements

7.0 Summary of the Test Results

Test Item	FCC Specification	Reference of the Test Report	Results	Remarks
Antenna Requirement	Section 15.203	Section 1.11	Passed	-
AC Powerline Conducted Emission	Section 15.207	Section 7.1	N/A *1)	-
Radiated Emission	Section 15.225(a)(b)(c)(d)	Section 7.2	Passed	-
Occupied Bandwidth	Section 15.215(c)	Section 7.3	Passed	-
Frequency Stability	Section 15.225(e)	Section 7.4	Passed	-

Note: 1) See Section 7.1.

7.1 AC Powerline Conducted Emission

The requirements are - Applicable - Tested. - Not tested by applicant request.]
 - Not Applicable

- Passed - Failed - Not judged

Remarks : When the smart phone is connected to the AC Charger or Earpbone, the RF(13.56MHz) communicating function is not available.

7.2 Radiated Emission**7.2.1.1 Radiated Emission (§15.225(a)(b)(c))**The requirements are - Applicable - Tested. - Not tested by applicant request.] - Not Applicable - Passed - Failed - Not judged**7.2.1.2 Worst Point and Measurement Uncertainty**Min. Limit Margin (Quasi-Peak) 55.9 dB at 13.567 MHzUncertainty of Measurement Results 9 kHz – 30 MHz +/-3.0 dB(2 σ)Remarks : The Radited Emission at 30m of 13.567 MHz is -5.4 dB(uV/m). ISO/IEC15693 Type V mode, Y axis position.**7.2.2.1 Radiated Emission (§15.225(d))**The requirements are - Applicable - Tested. - Not tested by applicant request.] - Not Applicable - Passed - Failed - Not judged**7.2.2.2 Worst Point and Measurement Uncertainty**Min. Limit Margin (Quasi-Peak) 19.1 dB at 81.36 MHzUncertainty of Measurement Results
9 kHz – 30 MHz +/-3.0 dB(2 σ)
30 MHz – 300 MHz +/-3.8 dB(2 σ)
300 MHz – 1000 MHz +/-4.8 dB(2 σ)
above 1 GHz _____ dB(2 σ)Remarks : ISO/IEC15693 Type V mode, Y axis position. When the smart phone is connected to the AC Charger or Earphone, the RF(13.56MHz) communicating function is not available.

7.2.3 Test Instruments

Anechoic Chamber A2					
Type	Model	Manufacturer	ID No.	Last Cal.	Interval
Test Receiver	ESU26	Rohde & Schwarz	A-6	2014/5	1 Year
Loop Antenna	HFH2-Z2	Rohde & Schwarz	C-2	2014/8	1 Year
RF Cable	RG213/U	SUHNER	H-28	2014/8	1 Year
Biconical Antenna	VHA9103/BBA9106	Schwarzbeck	C-30	2014/5	1 Year
Log-periodic Antenna	UHALP9108-A1	Schwarzbeck	C-31	2014/5	1 Year
RF Cable	S 10162 B-11 etc.	SUHNER	H-4	2015/4	1 Year
Site Attenuation	--	----	H-15	2015/1	1 Year
Pre-Amplifier	310N	SONOMA	A-17	2015/4	1 Year

7.2.4 Test Method and Test Setup (Diagrammatic illustration)

7.2.4.1 Radiated Emission 9 kHz – 30 MHz

The preliminary tests were performed at the measurement distance that specified for compliance to determine the emission characteristics of the EUT.

The EUT configuration(in X, Y and Z axis), cable configuration and mode of operation were determined for producing the maximum level of emissions.

This configurations was used for the final tests.

– Side View –

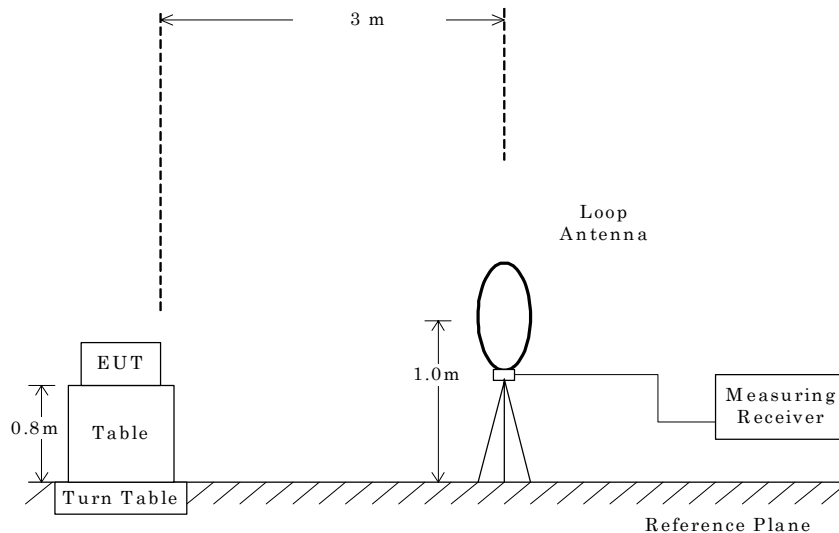

7.2.4.2 Radiated Emission 30 MHz – 1000 MHz

The preliminary tests were performed at the measurement distance that specified for compliance to determine the emission characteristics of the EUT.

The EUT configuration(in X, Y and Z axis), cable configuration and mode of operation were determined for producing the maximum level of emissions.

This configurations was used for the final tests.

– Side View –

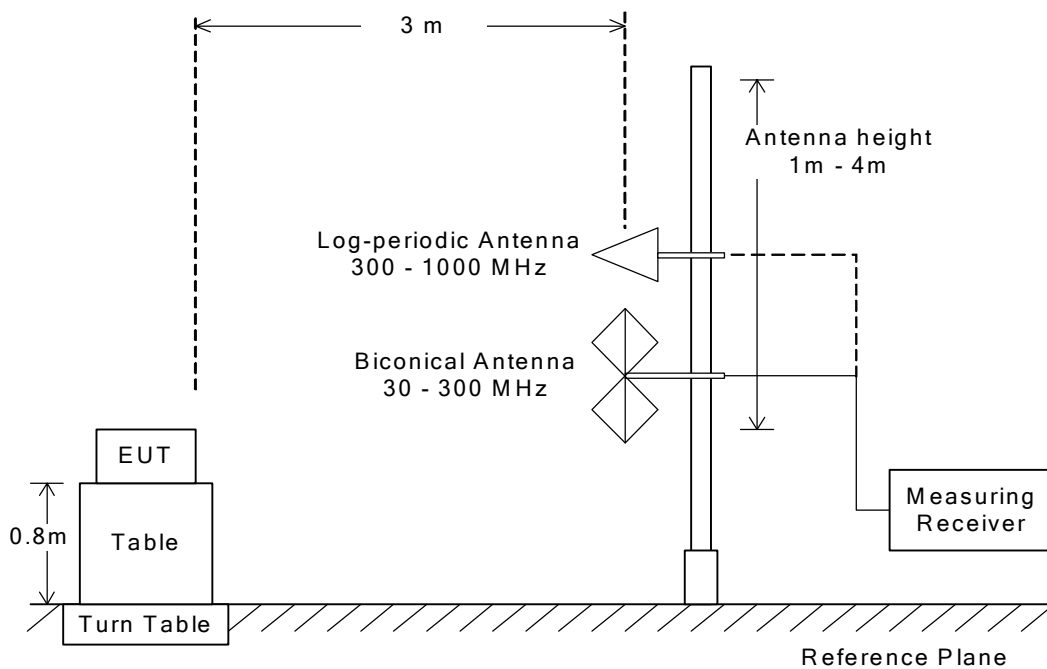

7.2.5 Test Data

7.2.5.1 Radiated Emission (§15.225(a)(b)(c) & §15.209(a))

Test Mode : Felica

Test condition : Transmitting(Felica)							Test Date: April 15, 2015 Temp.: 20 °C, Humi: 61 %	
Frequency [MHz]	Correction Factor [dB(1/m)]	Meter Readings at 3 m [dB(μV)]	Limits [dB(μV/m)]	Specified Distance [m]	Extrapolated Results [dB(μV/m)]	Margin [dB]	Remarks	
13.410	19.8	< 10.0	40.5	30.0	< -10.2	> +50.7	-	
13.553	19.8	13.1	50.5	30.0	- 7.1	+57.6	-	
13.560	19.8	27.8	84.0	30.0	7.6	+76.4	-	
13.567	19.8	14.7	50.5	30.0	- 5.5	+56.0	-	
13.710	19.8	< 10.0	40.5	30.0	< -10.2	> +50.7	-	
27.120	22.1	< 10.0	29.5	30.0	< - 7.9	> +37.4	-	

NOTES

1. Test Distance : 3 m
2. The correction factor includes the antenna factor and the cable loss.
3. The symbol of "<" means "or less".
4. The symbol of ">" means "more than".
5. The testing loop antenna was rotated at the vertical and horizontal axis to maximize received emissions.
The above Meter Reading was maximum emission level.
6. Calculation:
For fundamental, the measured field strength was extrapolated to distance 30m, using the formula that field strength using the formula that field strength aries as the inverse distance square(40 dB per decade of distance).

Fundamental : Correction Factor + Meter Reading = 19.8 + 27.8 = 47.6 dB(μV/m)
 Result at 30 m = -40 + 47.6 = 7.6 dB(μV/m) (Conversion Factor : 40dB/decade)
 Limits for 13.553-13.567MHz(§15.225(a)) = 20log10(15848) = 84.0 dBμV/m
 Limits for 13.410-13.553,13.567-13.710MHz(§15.225(b)) = 20log10(334) = 50.5 dBμV/m
 Limits for 13.110-13.410,13.710-14.010MHz (§15.225(c)) = 20log10(106) = 40.5 dBμV/m
 Harmonics : Correction Factor + Meter Reading = 22.1 + <10.0 = <32.1 dB(μV/m)
 Result at 30 m = -40 + <32.1 = <-7.9 dB(μV/m) (Conversion Factor : 40dB/decade)
 Limits for Harmonics(§15.209(a)) = 20log10(30) = 29.5 dBμV/m

7. Test receiver setting(s) :
 Quasi-Peak Detector IF Bandwidth: 9kHz or 200Hz(Except for 9 kHz -90 kHz, 110 kHz -490 kHz)
 Average Detector, IF Bandwidth: 9kHz or 200Hz(9 kHz -90 kHz, 110 kHz -490 kHz)

Test Mode : ISO/IEC14443 Type A

Test Date: April 15, 2015
 Temp.: 20 °C. Humi: 61 %

Test condition : Transmitting(Type A)

Frequency [MHz]	Correction Factor [dB(1/m)]	Meter Readings at 3 m [dB(μV)]	Limits [dB(μV/m)]	Specified Distance [m]	Extrapolated Results [dB(μV/m)]	Margin [dB]	Remarks
13.410	19.8	< 10.0	40.5	30.0	< -10.2	> +50.7	-
13.553	19.8	12.1	50.5	30.0	- 8.1	+58.6	-
13.560	19.8	26.8	84.0	30.0	6.6	+77.4	-
13.567	19.8	13.8	50.5	30.0	- 6.4	+56.9	-
13.710	19.8	< 10.0	40.5	30.0	< -10.2	> +50.7	-
27.120	22.1	< 10.0	29.5	30.0	< - 7.9	> +37.4	-

NOTES

1. Test Distance : 3 m
2. The correction factor includes the antenna factor and the cable loss.
3. The symbol of “<” means “or less”.
4. The symbol of “>” means “more than”.
5. The testing loop antenna was rotated at the vertical and horizontal axis to maximize received emissions.
The above Meter Reading was maximum emission level.

6. Calculation:

For fundamental, the measured field strength was extrapolated to distance 30m, using the formula that field strength using the formula that field strength aries as the inverse distance square(40 dB per decade of distance).

Fundamental : Correction Factor + Meter Reading = 19.8 + 26.8 = 46.6 dB(μV/m)

Result at 30 m = -40 + 46.6 = 6.6 dB(μV/m) (Conversion Factor : 40dB/decade)

Limits for 13.553-13.567MHz(§15.225(a)) = 20log10(15848) = 84.0 dBμV/m

Limits for 13.410-13.553,13.567-13.710MHz(§15.225(b)) = 20log10(334) = 50.5 dBμV/m

Limits for 13.110-13.410,13.710-14.010MHz (§15.225(c)) = 20log10(106) = 40.5 dBμV/m

Harmonics : Correction Factor + Meter Reading = 22.1 + <10.0 = <32.1 dB(μV/m)

Result at 30 m = -40 + <32.1 = <-7.9 dB(μV/m) (Conversion Factor : 40dB/decade)

Limits for Harmonics(§15.209(a)) = 20log10(30) = 29.5 dBμV/m

7. Test receiver setting(s) :

Quasi-Peak Detector IF Bandwidth: 9kHz or 200Hz(Except for 9 kHz -90 kHz, 110 kHz -490 kHz)

Average Detector, IF Bandwidth: 9kHz or 200Hz(9 kHz -90 kHz, 110 kHz -490 kHz)

Test Mode : ISO/IEC14443 Type B

Test Date: April 15, 2015
 Temp.: 20 °C. Humi: 61 %

Test condition : Transmitting(Type B)

Frequency [MHz]	Correction Factor [dB(1/m)]	Meter Readings at 3 m [dB(μV)]	Limits [dB(μV/m)]	Specified Distance [m]	Extrapolated Results [dB(μV/m)]	Margin [dB]	Remarks
13.410	19.8	< 10.0	40.5	30.0	< -10.2	> +50.7	-
13.553	19.8	12.3	50.5	30.0	- 7.9	+58.4	-
13.560	19.8	26.9	84.0	30.0	6.7	+77.3	-
13.567	19.8	13.8	50.5	30.0	- 6.4	+56.9	-
13.710	19.8	< 10.0	40.5	30.0	< -10.2	> +50.7	-
27.120	22.1	< 10.0	29.5	30.0	< - 7.9	> +37.4	-

NOTES

1. Test Distance : 3 m
2. The correction factor includes the antenna factor and the cable loss.
3. The symbol of "<" means "or less".
4. The symbol of ">" means "more than".
5. The testing loop antenna was rotated at the vertical and horizontal axis to maximize received emissions.
The above Meter Reading was maximum emission level.

6. Calculation:

For fundamental, the measured field strength was extrapolated to distance 30m, using the formula that field strength using the formula that field strength aries as the inverse distance square(40 dB per decade of distance).

Fundamental : Correction Factor + Meter Reading = 19.8 + 26.9 = 46.7 dB(μV/m)

Result at 30 m = -40 + 46.7 = 6.7 dB(μV/m) (Conversion Factor : 40dB/decade)

Limits for 13.553-13.567MHz(§15.225(a)) = 20log10(15848) = 84.0 dBμV/m

Limits for 13.410-13.553,13.567-13.710MHz(§15.225(b)) = 20log10(334) = 50.5 dBμV/m

Limits for 13.110-13.410,13.710-14.010MHz (§15.225(c)) = 20log10(106) = 40.5 dBμV/m

Harmonics : Correction Factor + Meter Reading = 22.1 + <10.0 = <32.1 dB(μV/m)

Result at 30 m = -40 + <32.1 = <-7.9 dB(μV/m) (Conversion Factor : 40dB/decade)

Limits for Harmonics(§15.209(a)) = 20log10(30) = 29.5 dBμV/m

7. Test receiver setting(s) :

Quasi-Peak Detector IF Bandwidth: 9kHz or 200Hz(Except for 9 kHz -90 kHz, 110 kHz -490 kHz)

Average Detector, IF Bandwidth: 9kHz or 200Hz(9 kHz -90 kHz, 110 kHz -490 kHz)

Test Mode : ISO/IEC15693 Type V

Test Date: April 15, 2015
 Temp.: 20 °C. Humi: 61 %

Test condition : Transmitting(Type V)

Frequency [MHz]	Correction Factor [dB(1/m)]	Meter Readings at 3 m [dB(μV)]	Limits [dB(μV/m)]	Specified Distance [m]	Extrapolated Results [dB(μV/m)]	Margin [dB]	Remarks
13.410	19.8	< 10.0	40.5	30.0	< -10.2	> +50.7	-
13.553	19.8	13.2	50.5	30.0	- 7.0	+57.5	-
13.560	19.8	27.9	84.0	30.0	7.7	+76.3	-
13.567	19.8	14.8	50.5	30.0	- 5.4	+55.9	-
13.710	19.8	< 10.0	40.5	30.0	< -10.2	> +50.7	-
27.120	22.1	< 10.0	29.5	30.0	< - 7.9	> +37.4	-

NOTES

1. Test Distance : 3 m
2. The correction factor includes the antenna factor and the cable loss.
3. The symbol of “<” means “or less”.
4. The symbol of “>” means “more than”.
5. The testing loop antenna was rotated at the vertical and horizontal axis to maximize received emissions.
The above Meter Reading was maximum emission level.

6. Calculation:

For fundamental, the measured field strength was extrapolated to distance 30m, using the formula that field strength using the formula that field strength aries as the inverse distance square(40 dB per decade of distance).

Fundamental : Correction Factor + Meter Reading = 19.8 + 27.9 = 47.7 dB(μV/m)

Result at 30 m = -40 + 47.7 = 7.7 dB(μV/m) (Conversion Factor : 40dB/decade)

Limits for 13.553-13.567MHz(§15.225(a)) = 20log10(15848) = 84.0 dBμV/m

Limits for 13.410-13.553,13.567-13.710MHz(§15.225(b)) = 20log10(334) = 50.5 dBμV/m

Limits for 13.110-13.410,13.710-14.010MHz (§15.225(c)) = 20log10(106) = 40.5 dBμV/m

Harmonics : Correction Factor + Meter Reading = 22.1 + <10.0 = <32.1 dB(μV/m)

Result at 30 m = -40 + <32.1 = <-7.9 dB(μV/m) (Conversion Factor : 40dB/decade)

Limits for Harmonics(§15.209(a)) = 20log10(30) = 29.5 dBμV/m

7. Test receiver setting(s) :

Quasi-Peak Detector IF Bandwidth: 9kHz or 200Hz(Except for 9 kHz -90 kHz, 110 kHz -490 kHz)

Average Detector, IF Bandwidth: 9kHz or 200Hz(9 kHz -90 kHz, 110 kHz -490 kHz)

7.2.5.2 Radiated Emission (§15.209(a))(9kHz – 30MHz)

Test Mode: All mode

Test condition : Transmitting

Test Date: April 15, 2015
 Temp.: 20 °C, Humi: 61 %

Frequency [MHz]	Correction Factor [dB(1/m)]	Meter Readings at 3 m [dB(μV)]	Limits [dB(μV/m)]	Specified Distance [m]	Extrapolated Results [dB(μV/m)]	Margin [dB]	Remarks
0.009	29.6	< 15.0	48.5	300.0	< -35.4	> +83.9	-
0.01	29.2	< 15.0	47.6	300.0	< -35.8	> +83.4	-
0.05	21.2	< 15.0	33.6	300.0	< -43.8	> +77.4	-
0.10	20.3	< 15.0	27.6	300.0	< -44.7	> +72.3	-
0.50	19.8	< 10.0	33.6	30.0	< -10.2	> +43.8	-
1.00	19.7	< 10.0	27.6	30.0	< -10.3	> +37.9	-
5.00	19.6	< 10.0	29.5	30.0	< -10.4	> +39.9	-
10.00	19.6	< 10.0	29.5	30.0	< -10.4	> +39.9	-
20.00	20.9	< 10.0	29.5	30.0	< - 9.1	> +38.6	-
30.00	22.5	< 10.0	29.5	30.0	< - 7.5	> +37.0	-

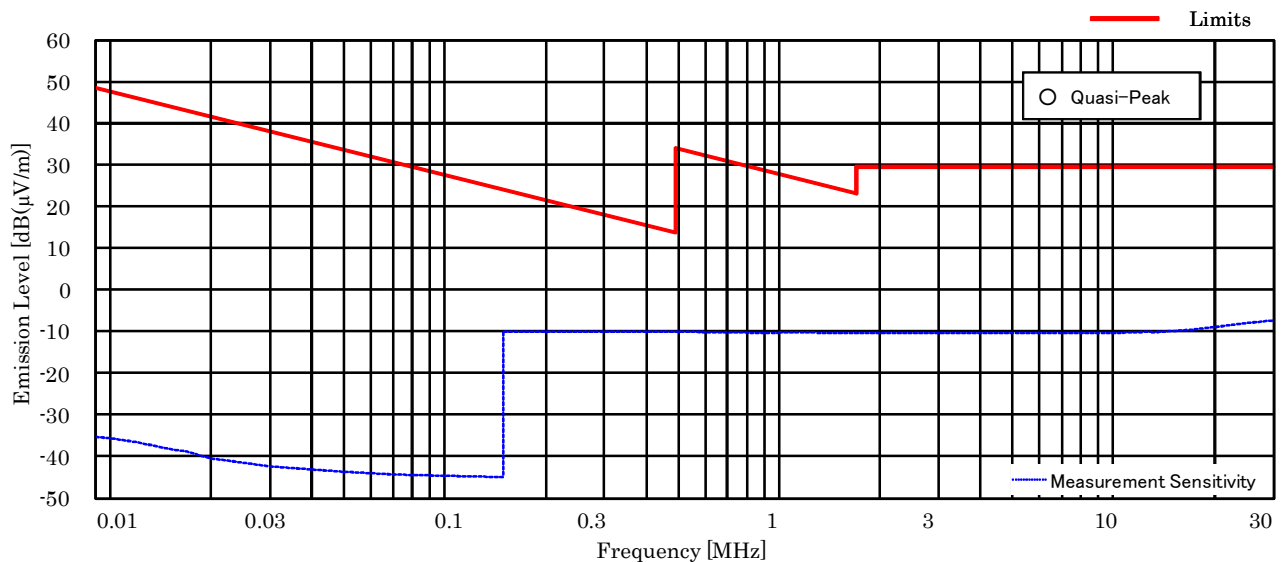

NOTES

1. Test Distance : 3 m
2. The spectrum was checked from 9 kHz to 30 MHz.
3. The correction factor includes the antenna factor and the cable loss.
4. The symbol of “<” means “or less”.
5. The symbol of “>” means “more than”.
6. Calculated result at 30.00 MHz, as the worst point shown on underline:
 Correction Factor + Meter Reading = 22.5 + <10.0 = <32.5 dB(μV/m)
 Result at 30 m = -40.0 + <32.5 = <-7.5 dB(μV/m) (Conversion Factor : 40dB/decade)
7. Test receiver setting(s) :
 Quasi-Peak Detector, IF Bandwidth: 9kHz or 200Hz(Except for 9 kHz -90 kHz, 110 kHz -490 kHz)
 Average Detector, IF Bandwidth: 9kHz or 200Hz(9 kHz -90 kHz, 110 kHz -490 kHz)

7.2.5.3 Radiated Emission (§15.209(a))(30MHz – 1000MHz)

Test Mode : ISO/IEC15693 Type V (Worst case)

Test Date: April 15, 2015
Temp.: 20 °C, Humi: 61 %

Antenna pole : Horizontal

Frequency [MHz]	Antenna Factor [dB(1/m)]	Corr. Factor [dB]	Meter Readings [dB(μV)]	Limits [dB(μV/m)]	Results [dB(μV/m)]	Margin [dB]	Remarks
<u>81.36</u>	6.6	-26.8	41.1	40.0	20.9	+19.1	-
94.92	9.1	-26.7	35.6	43.5	18.0	+25.5	-
122.04	13.2	-26.4	31.0	43.5	17.8	+25.7	-
135.60	14.0	-26.3	29.5	43.5	17.2	+26.3	-
149.16	14.7	-26.2	29.4	43.5	17.9	+25.6	-
189.84	16.3	-25.9	29.8	43.5	20.2	+23.3	-
203.40	16.5	-25.8	29.5	43.5	20.2	+23.3	-
216.96	16.8	-25.7	29.9	46.0	21.0	+25.0	-

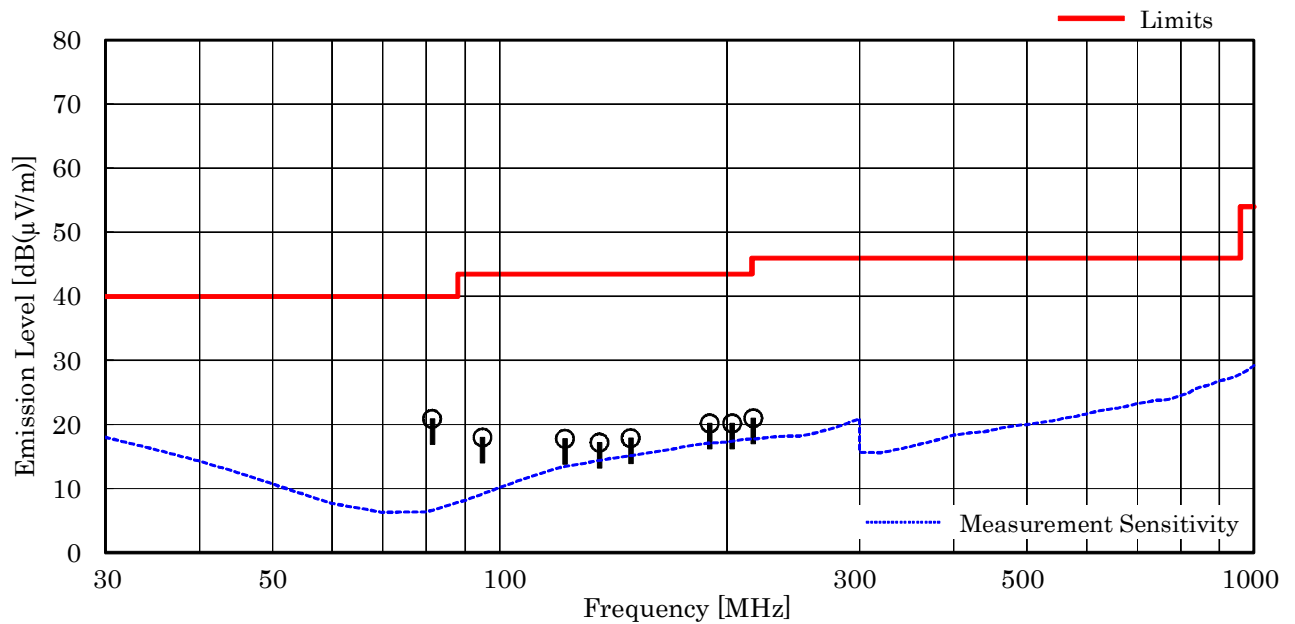

NOTES

1. Test Distance : 3 m
2. The spectrum was checked from 30 MHz to 1000 MHz.
3. The correction factor is composed of cable loss, pad attenuation and/or amplifier gain.
4. The symbol of "<" means "or less".
5. The symbol of ">" means "more than".
6. Calculated result at 81.36 MHz, as the worst point shown on underline:
 Antenna Factor + Coorection Factor + Meter Reading = 6.6 + (-26.8) + 41.1 = 20.9 dB(μV/m)
 Antenna Height : 2.27 m, Turntable Angle : 250 °
7. Test receiver setting(s) : CISPR QP 120 kHz (QP : Quasi-Peak)

Test Date: April 15, 2015
Temp.: 20 °C, Humi: 61 %

Antenna pole : Vertical

Frequency [MHz]	Antenna Factor [dB(1/m)]	Corr. Factor [dB]	Meter Readings [dB(μV)]	Limits [dB(μV/m)]	Results [dB(μV/m)]	Margin [dB]	Remarks
40.68	14.7	-27.3	29.1	40.0	16.5	+23.5	-
81.36	6.6	-26.8	37.4	40.0	17.2	+22.8	-
94.92	9.1	-26.7	33.2	43.5	15.6	+27.9	-
122.04	13.2	-26.4	28.9	43.5	15.7	+27.8	-
135.60	14.0	-26.3	28.3	43.5	16.0	+27.5	-
149.16	14.7	-26.2	29.1	43.5	17.6	+25.9	-

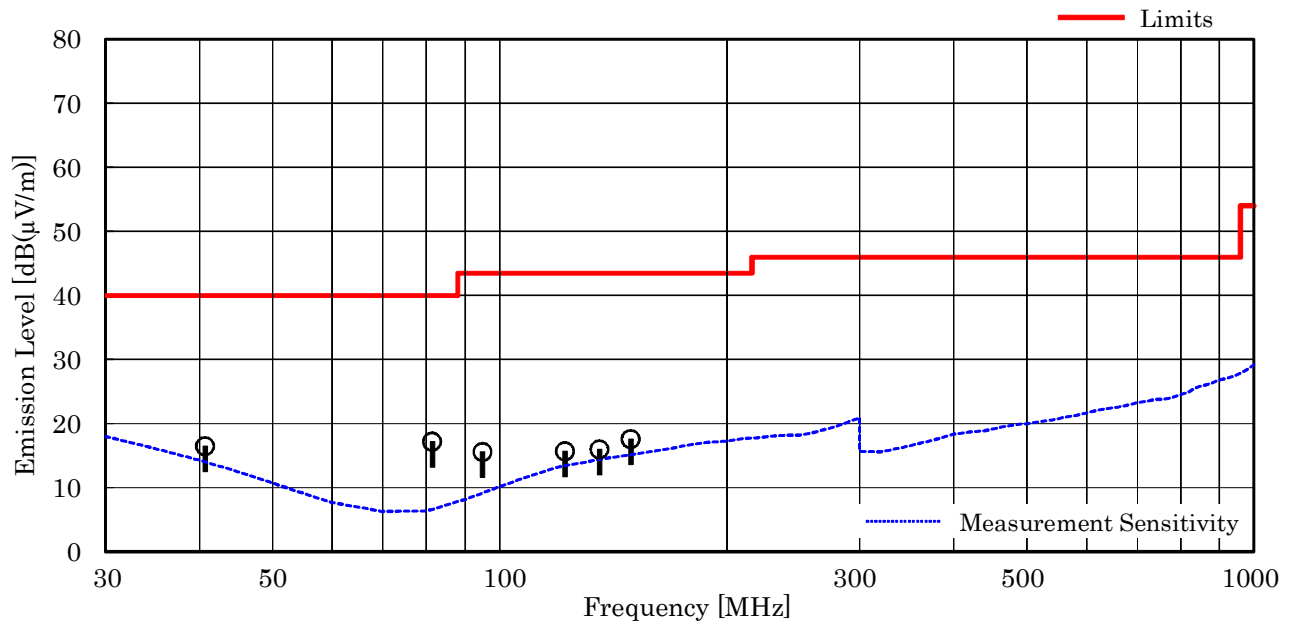

NOTES

1. Test Distance : 3 m
2. The spectrum was checked from 30 MHz to 1000 MHz.
3. The correction factor is composed of cable loss, pad attenuation and/or amplifier gain.
4. The symbol of “<” means “or less”.
5. The symbol of “>” means “more than”.
6. Calculated result at 81.36 MHz, as the worst point shown on underline:
 Antenna Factor + Coorection Factor + Meter Reading = 6.6 + (-26.8) + 37.4 = 17.2 dB(μV/m)
 Antenna Height : 1.65 m, Turntable Angle : 185 °
7. Test receiver setting(s) : CISPR QP 120 kHz (QP : Quasi-Peak)

7.3 Occupied Bandwidth

For the requirements, - Applicable - Tested. - Not tested by applicant request.]
 - Not Applicable

For the limits, - Passed - Failed - Not judged

7.3.1 Worst Point and Measurement Uncertainty

Uncertainty of Measurement Results +/-0.9 %(2 σ)

Remarks : _____

7.3.2 Test Instruments

Shielded Room S4					
Type	Model	Manufacturer	ID No.	Last Cal.	Interval
Spectrum Analyzer	E4446A	Agilent	A-39	2014/9	1 Year
Loop Antenna	LU-100A	TEXIO	C-33	N/A	N/A

7.3.3 Test Method and Test Setup (Diagrammatic illustration)

The test system is shown as follows:

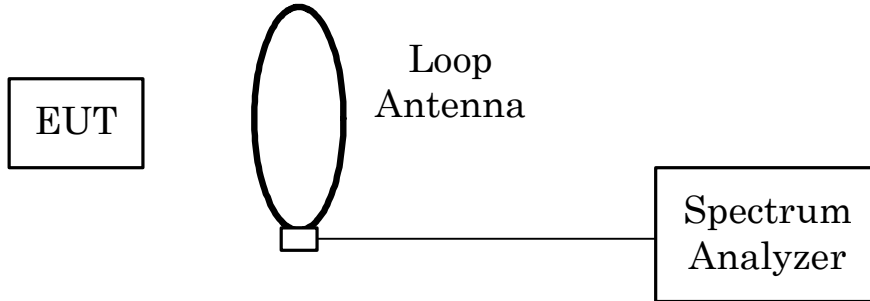

The setting of the spectrum analyzer are shown as follows:

Res. Bandwidth	1 kHz
Video Bandwidth	3 kHz
Span	100 kHz
Sweep Time	AUTO
Trace	Maxhold

7.3.4 Test Data

Test Date : April 10, 2015

Temp.:21°C, Humi:60%

Test Mode : Felica

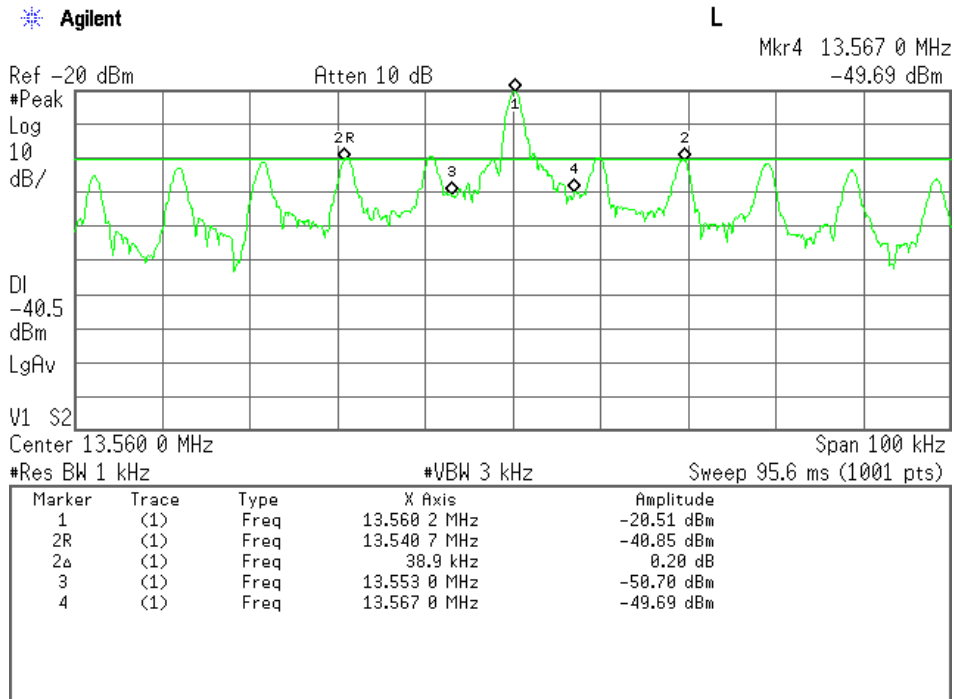

Test Mode : ISO/IEC14443 Type A

✳ Agilent

L

▲ Mkr2 38.9 kHz
0.08 dB

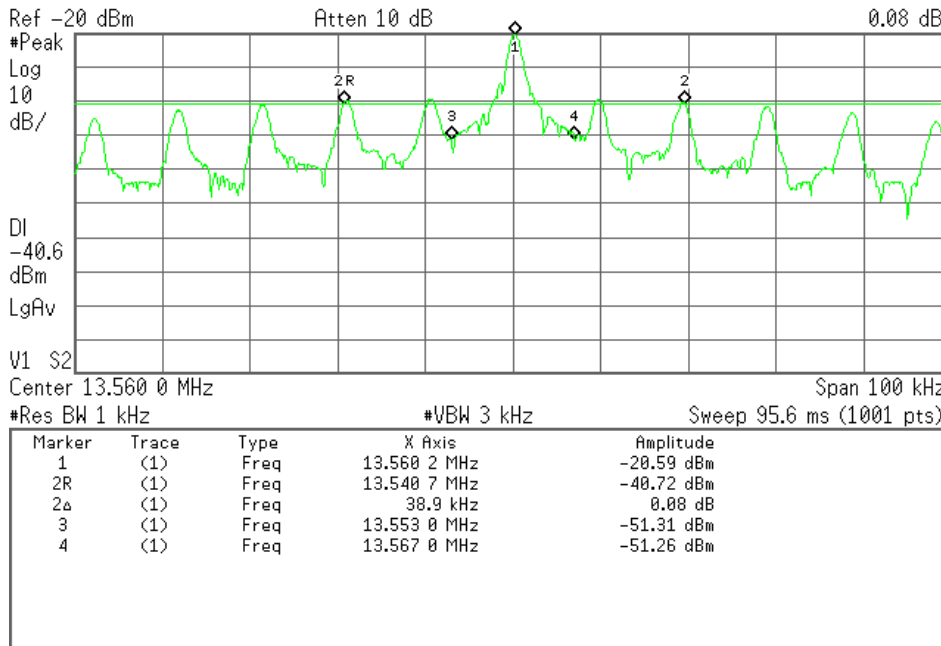

Test Mode : ISO/IEC14443 Type B

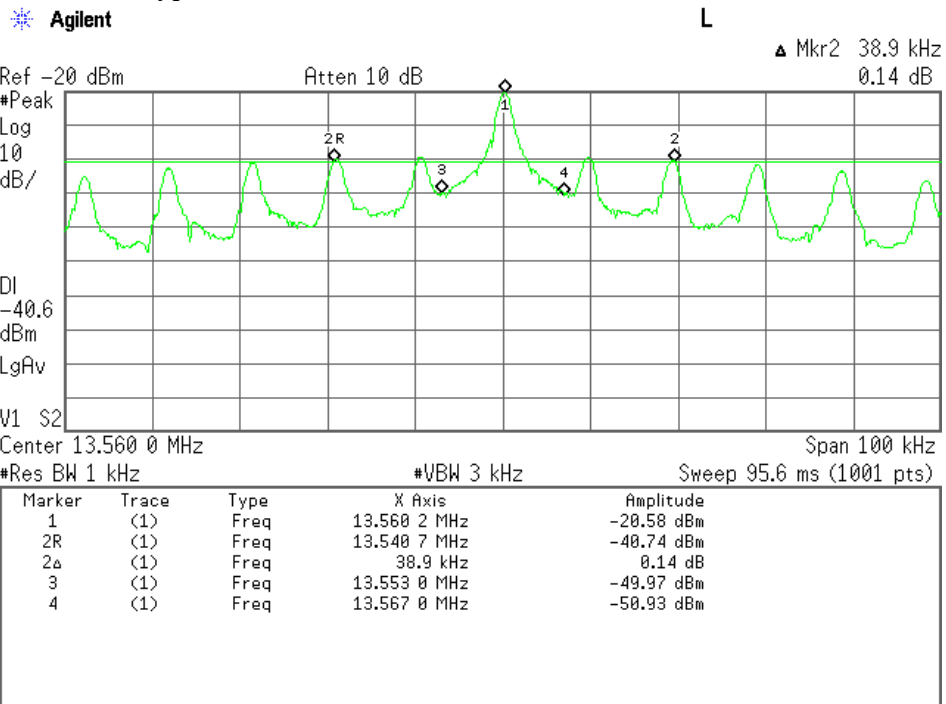

Test Mode : ISO/IEC15693 Type V

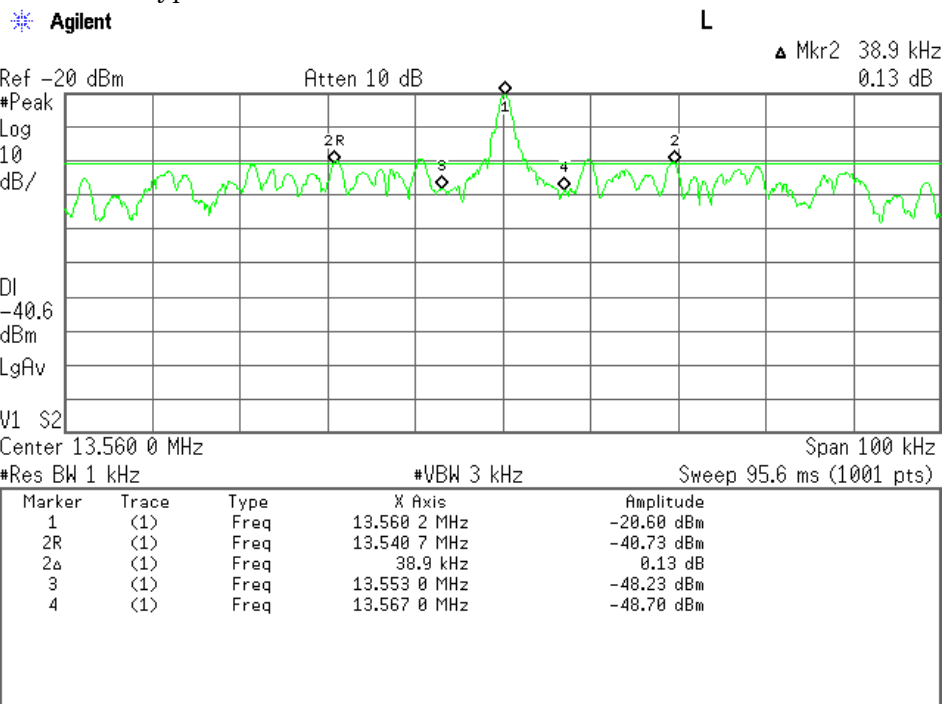

7.4 Frequency Stability

For the requirements, - Applicable - Tested. - Not tested by applicant request.]
 - Not Applicable

For the limits, - Passed - Failed - Not judged

7.4.1 Worst Point and Measurement Uncertainty

The Frequency Stability level is +0.001836 % at 13.560 MHz

Min. Limit Margin +0.008164 % at 13.560 MHz

Uncertainty of Measurement Results +/-1.3 ppm(2 σ)

Remarks : _____

7.4.2 Test Instruments

Shielded Room S4					
Type	Model	Manufacturer	ID No.	Last Cal.	Interval
Spectrum Analyzer	E4446A	Agilent	A-39	2014/9	1 Year
Loop Antenna	LU-100A	TEXIO	C-33	N/A	N/A
DC Voltage Meter	2011-39	YEW	B-33	2014/6	1 Year
Environmental Chamber	SH-641	ESPEC	F-32	2014/7	1 Year

7.4.3 Test Method and Test Setup (Diagrammatic illustration)

Frequency Stability versus Temperature

The EUT was placed in an environmental chamber and was tested in the range from -30 to +50 degrees Celsius. The EUT was stabilized at each temperature. The power (4.0VDC) supplied was applied to the transmitter and allowed to stabilize for 10 minutes. The transmitting frequency was measured at startup and 2 minutes, 5 minutes and 10 minutes after startup. This procedure was repeated from -20, +20 and +50 degrees Celsius.

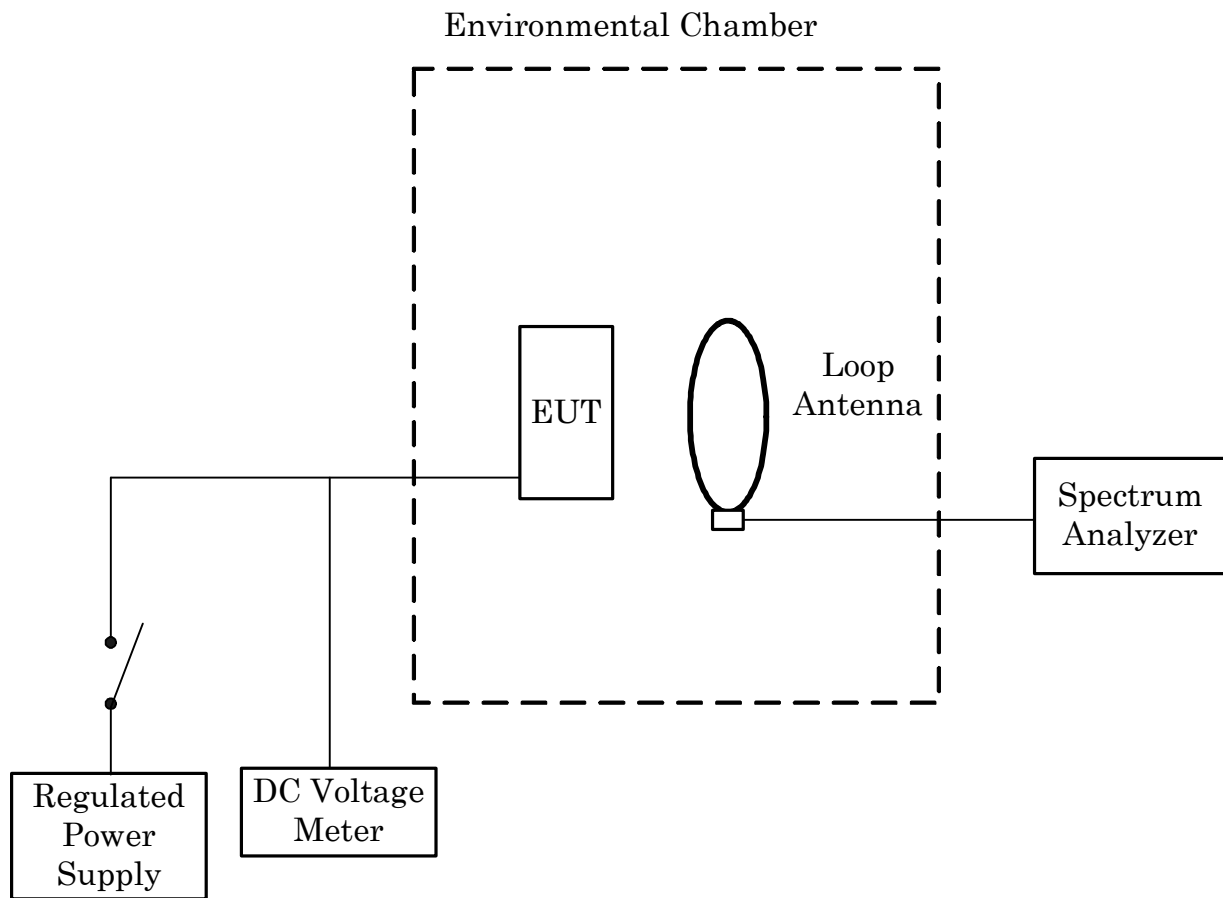

7.4.4 Test Data

Frequency Stability Measurement

Test Date: April 16, 2015

Transmitting Frequency : 13.560 MHz
 DC Supply Voltage : 4.0 VDC

Ambient Temperature [°C]	Startup	Frequency with time elapse [MHz]			Limits [%]	Margin [%]
		2 minutes	5 minutes	10 minutes		
-20	13.560049	13.560066	13.560064	13.560062	0.01	+ 0.009513
20	13.560249	13.560247	13.560246	13.560243	0.01	+ 0.008164
50	13.560162	13.560161	13.560159	13.560157	0.01	+ 0.008805

Ambient Temperature [°C]	Startup	Diviation with time elapse [%]			Limits [%]	Margin [%]
		2 minutes	5 minutes	10 minutes		
-20	+ 0.000361	+ 0.000487	+ 0.000472	+ 0.000457	0.01	+ 0.009513
20	+ 0.001836	+ 0.001822	+ 0.001814	+ 0.001792	0.01	+ 0.008164
50	+ 0.001195	+ 0.001187	+ 0.001173	+ 0.001158	0.01	+ 0.008805

Sample of calculated result at 13.560 MHz, as the Minimum Margin point:
 Ambient Temperature : 20 °C / Startup
 DC Supply Voltage : 4.0V

Minimum Margin: 0.010000 - 0.001836 = 0.008164 (%)
 The point shown on " _____ " is the Minimum Margin Point. The Maximum Deviation Point is shown on a thick letter.

Note: The measurement were made after all of components of the oscillator sufficiently stabilized at each temperature.