

TEST REPORT (SAR EVALUATION)

Applicant : Sharp Corporation, Communication Systems Division
Address : 2-13-1, Iida, Hachihonmatsu, Higashi-Hiroshima City, Hiroshima,
739-0192, Japan

Products : Hand Held Mini Phablet
Model No. : SH-06F
Serial No. : 004401115115202
FCC ID : APYHRO00208

Test Standard : CFR 47 FCC Rules and Regulations Part 2

Test Results : **Passed**

Date of Test : April 2 ~ 22, 2014



Kousei Shibata
Manager
Japan Quality Assurance Organization
KITA-KANSAI Testing Center
SAITO EMC Branch
7-3-10, Saito-asagi, Ibaraki-shi, Osaka 567-0085, Japan

-
- The measurement values stated in Test Report was made with traceable to National Institute of Advanced Industrial Science and Technology (AIST) of Japan, National Institute of Information and Communications Technology (NICT) of Japan , and Laboratory for EMF and Microwave Electronics at the Swiss Federal Institute of Technology (ETH) in Zürich, Switzerland.
 - The applicable standard, testing condition and testing method which were used for the tests are based on the request of the applicant.
 - The test results presented in this report relate only to the offered test sample.
 - The contents of this test report cannot be used for the purposes, such as advertisement for consumers.
 - This test report shall not be reproduced except in full without the written approval of JQA.
 - VLAC does not approve, certify or warrant the product by this test report.

TABLE OF CONTENTS

	Page
1 Description of the Device Under Test (DUT)	3
2 Summary of Test Results	4
3 Test Procedure.....	5
4 Test Location	5
5 Recognition of Test Laboratory	5
6 Measurement System Diagram.....	6
7 System Components	7
8 Measurement Process.....	10
9 Measurement Uncertainties.....	11
10 Test Arrangement	13
11 Tissue Verification.....	16
12 System Performance Check.....	21
13 RF Output Power Measurements.....	23
14 SAR Measurements.....	31
15 Test Setup Photographs	54
16 Test Instruments.....	59
17 Appendix.....	60

1 Description of the Device Under Test (DUT)

1. Manufacturer : Sharp Corporation, Communication Systems Division
2-13-1, Iida, Hachihonmatsu, Higashi-Hiroshima City, Hiroshima,
739-0192, Japan
2. Products : Hand Held Mini Phablet
3. Model No. : SH-06F
4. Serial No. : 004401115115202
5. Product Type : Pre-production
6. Date of Manufacture : March, 2014
7. Transmitting Frequency : GSM 850 (824 MHz – 849 MHz)
PCS 1900 (1850 MHz – 1910 MHz)
WCDMA Band V (824 MHz – 849 MHz)
WLAN 2.4 GHz (DTS : 2412 MHz – 2462 MHz)
WLAN 5 GHz (U-NII 1 : 5150 MHz – 5250 MHz)
WLAN 5 GHz (U-NII 2A : 5250 MHz – 5350 MHz)
WLAN 5 GHz (U-NII 2C : 5470 MHz – 5725 MHz)
Bluetooth (2402 MHz – 2480 MHz)
8. Battery Option : Lithium-ion Battery Pack UBATIA247AFZZ (4200mAh)
9. Power Rating : 4.0VDC
10. EUT Grounding : None
11. Device Category : Portable Device (§2.1093)
12. Exposure Category : General Population/Uncontrolled Exposure
13. FCC Rule Part(s) : 22(H), 24(E), 15.247, 15.407
14. EUT Authorization : Certification
15. Received Date of DUT : April 2, 2014

2 Summary of Test Results

Applied Standard : CFR 47 FCC Rules and Regulations Part 2 – Frequency Allocations and Radio Treaty Matters; General Rules and Regulations

Test Configuration	Reported 1 g SAR (W/kg)			Limit (W/kg)
	Licensed	DTS	U-NII	
Head	< 0.10	< 0.10	< 0.10	1.6
Body-worn Accessory	1.36	1.23	1.47	
Tablet	1.34	1.20	1.47	
Simultaneous Transmission	1.09	0.58	1.09	

The test results are **passed** for exposure limits specified in ANSI/IEEE Std. C95.1–1991.

In the approval of test results,

- Determining compliance with the limits in this report was based on the results of the compliance measurement, not taking into account measurement instrumentation uncertainty.
- No deviations were employed from the applied standard.
- No modifications were conducted by JQA to achieve compliance to the limitations.

Reviewed by:



Shigeru Kinoshita
Deputy Manager
JQA KITA-KANSAI Testing Center
SAITO EMC Branch

Tested by:



Yasuhisa Sakai
Deputy Manager
JQA KITA-KANSAI Testing Center
SAITO EMC Branch

3 Test Procedure

The tests documented in this report were performed in accordance with CFR 47 FCC Parts 1 and 2, IEEE Std.1528–2013 and the following KDB Procedures.

- # 248227 D01 SAR meas for 802 11 a b g v01r02
- # 447498 D01 General RF Exposure Guidance v05r02
- # 616217 D04 SAR for laptop and tablets v01r01
- # 648474 D04 SAR Handset SAR v01r02
- # 865664 D01 SAR Measurement 100 MHz to 6 GHz v01r03
- # 865664 D02 RF Exposure Reporting v01r01
- # 941225 D01 SAR test for 3G devices v02
- # 941225 D02 HSPA and 1x Advanced v02r02
- # 941225 D03 SAR Test Reduction GSM GPRS EDGE v01

4 Test Location

Japan Quality Assurance Organization (JQA)
KITA-KANSAI Testing Center
7-7, Ishimaru, 1-chome, Minoh-shi, Osaka, 562-0027, Japan
SAITO EMC Branch
7-3-10, Saito-asagi, Ibaraki-shi, Osaka 567-0085, Japan

5 Recognition of Test Laboratory

JQA KITA-KANSAI Testing Center SAITO EMC Branch is accredited under ISO/IEC 17025 by following accreditation bodies and the test facility is registered by the following bodies.

- VLAC Accreditation No. : VLAC-001-2 (Expiry date : March 30, 2016)
- VCCI Registration No. : A-0002 (Expiry date : March 30, 2016)
- BSMI Registration No. : SL2-IS-E-6006, SL2-IN-E-6006, SL2-R1/R2-E-6006, SL2-A1-E-6006
(Expiry date : September 14, 2016)
- IC Registration No. : 2079E-3, 2079E-4 (Expiry date : July 20, 2014)

Accredited as conformity assessment body for Japan electrical appliances and material law by METI.
(Expiry date : February 22, 2016)

6 Measurement System Diagram

These measurements are performed using the DASY5 automated dosimetric assessment system (manufactured by Schmid & Partner Engineering AG (SPEAG) in Zürich, Switzerland). It consists of high precision robotics system, cell controller system, DASY5 measurement server, personal computer with DASY5 software, data acquisition electronic (DAE) circuit, the Electro-optical converter (EOC), near-field probe, and the twin SAM phantom containing the equivalent tissue. The robot is a six-axis industrial robot performing precise movements to position the probe to the location (points) of maximum electromagnetic field (EMF).

The Robot is connected to the cell controller to allow software manipulation of the robot. The DAE is connected to the EOC. The DAE performs the signal amplification, signal multiplexing, A/D conversion, offset measurements, mechanical surface detection, collision detection, etc. The EOC performs the conversion from the optical into digital electric signal of the DAE and transfers data to the DASY5 measurement server.

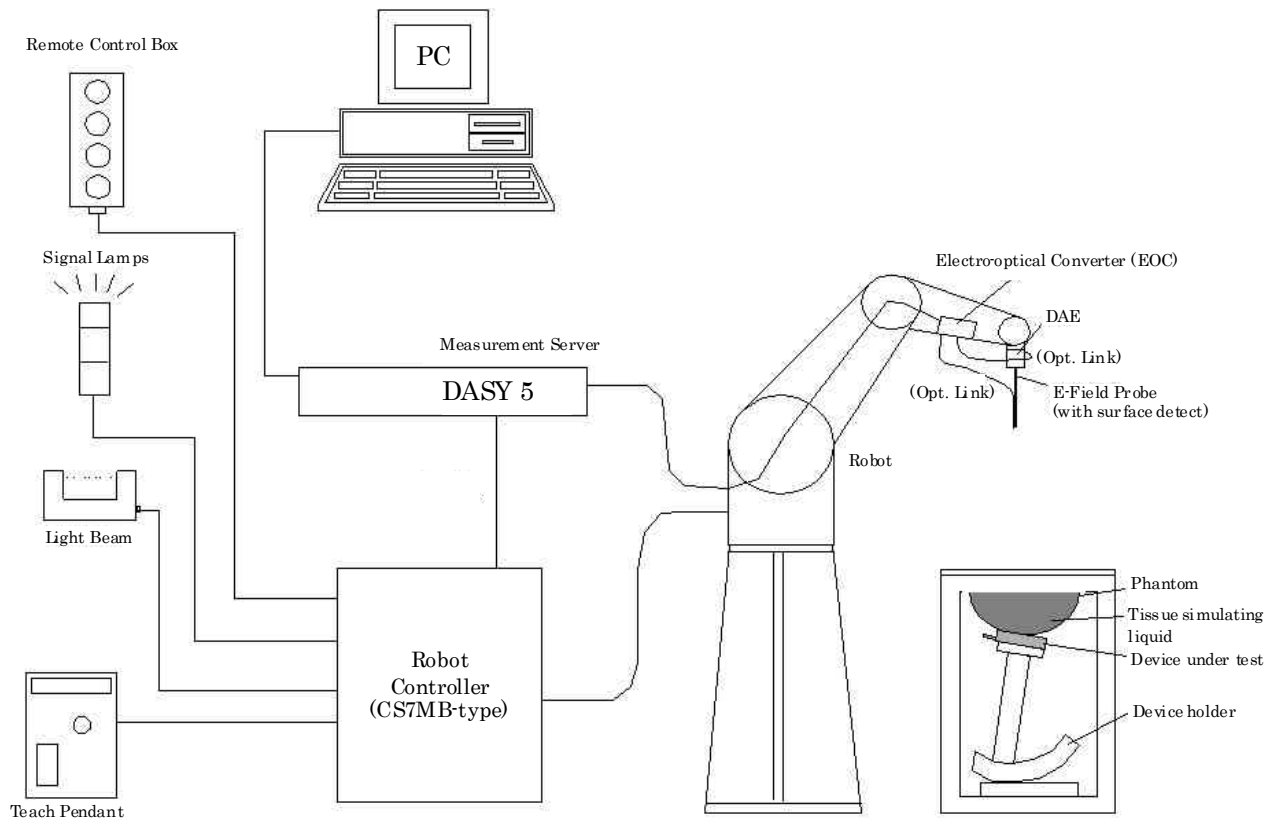

7 System Components

7.1 Probe Specification ET3DV6

Construction	: Symmetrical design with triangular core Built-in optical fiber for surface detection system Built-in shielding against static charges PEEK enclosure material (resistant to organic solvents, e.g., DGBE)	
Calibration	: In air form 10 MHz to 2.3 GHz In head tissue simulating liquid (HSL) and muscle tissue simulating liquid 835 MHz (accuracy $\pm 12.0\%$; k=2) 900 MHz (accuracy $\pm 12.0\%$; k=2) 1450 MHz (accuracy $\pm 12.0\%$; k=2) 1750 MHz (accuracy $\pm 12.0\%$; k=2) 1900 MHz (accuracy $\pm 12.0\%$; k=2) 1950 MHz (accuracy $\pm 12.0\%$; k=2)	
Frequency	: 10 MHz to 2.3 GHz Linearity: ± 0.2 dB (30 MHz to 2.3 GHz)	
Directivity	: ± 0.2 dB in HSL (rotation around probe axis) ± 0.4 dB in HSL (rotation normal to probe axis)	
Dynamic Range	: $5 \mu\text{W/g}$ to $>100 \text{ mW/g}$; Linearity: ± 0.2 dB	
Surface Detection	: ± 0.2 mm repeatability in air and clear liquids over diffuse reflecting surfaces	
Dimensions	: Overall length 337 mm Tip length 16 mm Body diameter 12 mm Tip diameter 6.8 mm Distance from probe tip to dipole centers 2.7 mm	

7.2 Probe Specification EX3DV4

- Construction : Symmetrical design with triangular core
Built-in shielding against static charges
PEEK enclosure material (resistant to organic solvents, e.g., DGBE)
- Calibration : In air form 10 MHz to 6 GHz
In head tissue simulating liquid (HSL) and muscle tissue simulating liquid
2450 MHz (accuracy $\pm 12.0\%$; k=2)
2600 MHz (accuracy $\pm 12.0\%$; k=2)
5200 MHz (accuracy $\pm 13.1\%$; k=2)
5300 MHz (accuracy $\pm 13.1\%$; k=2)
5500 MHz (accuracy $\pm 13.1\%$; k=2)
5600 MHz (accuracy $\pm 13.1\%$; k=2)
5800 MHz (accuracy $\pm 13.1\%$; k=2)
- 
- Frequency : 10 MHz to 6 GHz
Linearity: ± 0.2 dB (30 MHz to 6 GHz)
- Directivity : ± 0.3 dB in HSL (rotation around probe axis)
 ± 0.5 dB in tissue material (rotation normal to probe axis)
- Dynamic Range : 10 μ W/g to >100 mW/g; Linearity: ± 0.2 dB (noise: typically < 1 μ W/g)
- Dimensions : Overall length 337 mm
Tip length 20 mm
Body diameter 12 mm
Tip diameter 2.5 mm
Distance from probe tip to dipole centers 1 mm

7.3 Twin SAM Phantom

The shell corresponds to the specifications of the Specific Anthropomorphic Mannequin (SAM) phantom defined in IEEE 1528 and IEC 62209-1. It enables the dosimetric evaluation of left and right hand phone usage as well as body mounted usage at the flat phantom region. A cover prevents evaporation of the liquid. Reference markings on the phantom allow the complete setup of all predefined phantom positions and measurement grids by teaching three points with the robot.



Shell Thickness : 2 ± 0.2 mm; Center ear point: 6 ± 0.2 mm
Filling Volume : Volume Approx. 25 liters
Dimensions : $810 \times 1000 \times 500$ mm (H \times L \times W)

7.4 ELI4 Flat Phantom

Phantom for compliance testing of handheld and body-mounted wireless devices in the frequency range of 30 MHz to 6 GHz. ELI is fully compatible with the IEC 62209-2 standard and all known tissue simulating liquids. ELI has been optimized regarding its performance and can be integrated into our standard phantom tables. A cover prevents evaporation of the liquid. Reference markings on the phantom allow installation of the complete setup, including all predefined phantom positions and measurement grids, by teaching three points. The phantom is compatible with all SPEAG dosimetric probes and dipoles.

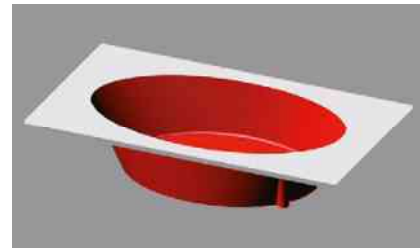

Shell Thickness : 2 ± 0.2 mm (sagging: <1%)
Filling Volume : Volume Approx. 30 liters
Dimensions : Major ellipse axis : 600 mm
Minor axis : 400 mm

7.5 Mounting Device for Transmitters

In combination with the Twin SAM Phantom V4.0/V4.0c or ELI4, the Mounting Device enables the rotation of the mounted transmitter device in spherical coordinates. Rotation point is the ear opening point. Transmitter devices can be easily and accurately positioned according to IEC, IEEE, CENELEC, FCC or other specifications. The device holder can be locked for positioning at different phantom sections (left head, right head, flat point).



8 Measurement Process

Step 1 : Power Reference Measurement

The power reference job measures the field at a specified reference position, at a selectable distance from the phantom surface. The reference position can be either the selected section's grid reference point or a user point in this section. The reference job projects the selected point onto the phantom surface, orients the probe perpendicularly to the surface, and approaches the surface using the selected detection method. The minimum distance of probe sensors to surface set to 4 mm for an ET3DV6 probe, or 2 mm for EX3DV4 probe. This distance cannot be smaller than the distance of sensor calibration points to probe tip as defined in the probe properties.

Step 2 : Area Scan

The area scan is used as a fast scan in two dimensions to find the area of high field values, before doing a fine measurement around the hot spot. The sophisticated interpolation routines implemented in DASY software can find the maximum locations in relatively coarse grids. When an area scan has measured all reachable points, it computes the field maximal found in the scanned area, within a range of the global maximum. If only one zoom scan follows the area scan, then only the absolute maximum will be taken as reference. For cases where multiple maxima within 2 dB of the maximum SAR value are detected, the number of zoom scans has to be increased accordingly.

Step 3 : Zoom Scan

Zoom scans are used to assess the peak spatial SAR values within a cubic averaging volume containing 1 g and 10 g of simulated tissue. The zoom scan measures points specified in standards within a cube whose base faces are centered on the maxima found in a preceding area scan job within the same procedure.

Step 4 : Z Scan

The Z scan measures points along a vertical straight line. The line runs along the Z axis of a one-dimensional grid. In order to get a reasonable extrapolation, the extrapolated distance should not be larger than the step size in Z-direction.

Step 5 : Power Drift Measurement

The power drift measurement measures the field at the same location as the most recent power reference measurement job within the same procedure, and with the same settings. The power drift measurement gives the field difference in dB from the reading conducted within the last power reference measurement. The power reference measurement and power drift measurement are for monitoring the power drift of the device under test in the batch process.

9 Measurement Uncertainties

9.1 300 MHz to 3 GHz

Uncertainty Component	Tol. (± %)	Prob. Dist.	Div.	c_i (1g)	c_i (10g)	Std. Unc. (± %)		ν_i
						1g	10g	
Measurement System								
Probe calibration	6.0	N	1	1	1	6.0	6.0	∞
Axial isotropy	4.7	R	$\sqrt{3}$	0.7	0.7	1.9	1.9	∞
Hemispherical isotropy	9.6	R	$\sqrt{3}$	0.7	0.7	3.9	3.9	∞
Boundary effects	1.0	R	$\sqrt{3}$	1	1	0.6	0.6	∞
Linearity	4.7	R	$\sqrt{3}$	1	1	2.7	2.7	∞
System detection limits	1.0	R	$\sqrt{3}$	1	1	0.6	0.6	∞
Modulation response	2.4	R	$\sqrt{3}$	1	1	1.4	1.4	∞
Readout electronics	0.3	N	1	1	1	0.3	0.3	∞
Response time	0.8	R	$\sqrt{3}$	1	1	0.5	0.5	∞
Integration time	2.6	R	$\sqrt{3}$	1	1	1.5	1.5	∞
RF ambient conditions – noise	3.0	R	$\sqrt{3}$	1	1	1.7	1.7	∞
RF ambient conditions – reflections	3.0	R	$\sqrt{3}$	1	1	1.7	1.7	∞
Probe positioner mechanical tolerance	0.4	R	$\sqrt{3}$	1	1	0.2	0.2	∞
Probe positioning with respect to phantom shell	2.9	R	$\sqrt{3}$	1	1	1.7	1.7	∞
Extrapolation, interpolation and integration algorithms for max. SAR evaluation	2.0	R	$\sqrt{3}$	1	1	1.2	1.2	∞
Test Sample Related								
Device holder uncertainty	2.9	N	1	1	1	2.9	2.9	5
Test sample positioning	3.4	N	1	1	1	3.4	3.4	23
Output power variation – SAR drift measurement	5.0	R	$\sqrt{3}$	1	1	2.9	2.9	∞
Power Scaling	0.0	R	$\sqrt{3}$	1	1	0.0	0.0	∞
Phantom and Tissue Parameters								
Phantom uncertainty	6.1	R	$\sqrt{3}$	1	1	3.5	3.5	∞
Algorithms for correcting SAR for deviations	1.9	R	$\sqrt{3}$	1	0.84	1.1	0.9	∞
Liquid Conductivity – measurement uncertainty	3.2	N	1	0.78	0.71	2.5	2.3	5
Liquid Permittivity – measurement uncertainty	3.0	N	1	0.26	0.26	0.8	0.8	5
Liquid Conductivity – temperature uncertainty	5.2	R	$\sqrt{3}$	0.78	0.71	2.3	2.1	∞
Liquid Permittivity – temperature uncertainty	0.8	R	$\sqrt{3}$	0.23	0.26	0.1	0.1	∞
Combined Standard Uncertainty						11.5	11.4	
Expanded Uncertainty (95% Confidence Interval)						22.9	22.7	
NOTES 1. Tol. : tolerance in influence quantity 2. Prob. Dist. : probability distributions 3. N, R : normal, rectangular 4. Div. : divisor used to obtain standard uncertainty 5. c_i : sensitivity coefficient 6. Std. Unc. : standard uncertainty 7. Measurement uncertainties are according to IEEE Std.1528 and IEC 62209-1.								

9.2 3 GHz to 6 GHz

Uncertainty Component	Tol. (± %)	Prob. Dist.	Div.	c_i (1g)	c_i (10g)	Std. Unc. (± %)		v_i
						1g	10g	
Measurement System								
Probe calibration	6.6	N	1	1	1	6.6	6.6	∞
Axial isotropy	4.7	R	√3	0.7	0.7	1.9	1.9	∞
Hemispherical isotropy	9.6	R	√3	0.7	0.7	3.9	3.9	∞
Boundary effects	2.0	R	√3	1	1	1.2	1.2	∞
Linearity	4.7	R	√3	1	1	2.7	2.7	∞
System detection limits	1.0	R	√3	1	1	0.6	0.6	∞
Modulation response	2.4	R	√3	1	1	1.4	1.4	∞
Readout electronics	0.3	N	1	1	1	0.3	0.3	∞
Response time	0.8	R	√3	1	1	0.5	0.5	∞
Integration time	2.6	R	√3	1	1	1.5	1.5	∞
RF ambient conditions – noise	3.0	R	√3	1	1	1.7	1.7	∞
RF ambient conditions – reflections	3.0	R	√3	1	1	1.7	1.7	∞
Probe positioner mechanical tolerance	0.8	R	√3	1	1	0.5	0.5	∞
Probe positioning with respect to phantom shell	6.7	R	√3	1	1	3.9	3.9	∞
Extrapolation, interpolation and integration algorithms for max. SAR evaluation	4.0	R	√3	1	1	2.3	2.3	∞
Test Sample Related								
Device holder uncertainty	2.9	N	1	1	1	2.9	2.9	5
Test sample positioning	3.4	N	1	1	1	3.4	3.4	23
Output power variation – SAR drift measurement	5.0	R	√3	1	1	2.9	2.9	∞
Power Scaling	0.0	R	√3	1	1	0.0	0.0	∞
Phantom and Tissue Parameters								
Phantom uncertainty	6.6	R	√3	1	1	3.8	3.8	∞
Algorithms for correcting SAR for deviations	1.9	R	√3	1	0.84	1.1	0.9	∞
Liquid Conductivity – measurement uncertainty	3.2	N	1	0.78	0.71	2.5	2.3	5
Liquid Permittivity – measurement uncertainty	3.0	N	1	0.26	0.26	0.8	0.8	5
Liquid Conductivity – temperature uncertainty	3.4	R	√3	0.78	0.71	1.5	1.4	∞
Liquid Permittivity – temperature uncertainty	0.4	R	√3	0.23	0.26	0.1	0.1	∞
Combined Standard Uncertainty			RSS			12.5	12.4	
Expanded Uncertainty (95% Confidence Interval)			k=2			24.9	24.8	
NOTES 1. Tol. : tolerance in influence quantity 2. Prob. Dist. : probability distributions 3. N, R : normal, rectangular 4. Div. : divisor used to obtain standard uncertainty 5. c_i : sensitivity coefficient 6. Std. Unc. : standard uncertainty 7. Measurement uncertainties are according to IEEE Std.1528 and IEC 62209-1.								

10 Test Arrangement

10.1 Head Exposure Conditions

10.1.1 Cheek-Touch Position

1. Position the device with the vertical center line of the body of the device and the horizontal line crossing the center of the ear piece in a plane parallel to the sagittal plane of the phantom.
2. While maintaining the device in this plane, align the vertical center line with the reference plane containing the three ear and mouth reference points (M, RE and LE) and align the center of the ear piece with the line RE-LE.
3. Translate the mobile phone box towards the phantom with the ear piece aligned with the line RE-LE until the phone touches the ear.
4. While maintaining the device in the reference plane and maintaining the phone contact with the ear, move the bottom of the box until any point on the front side is in contact with the cheek of the phantom or until contact with the ear is lost.

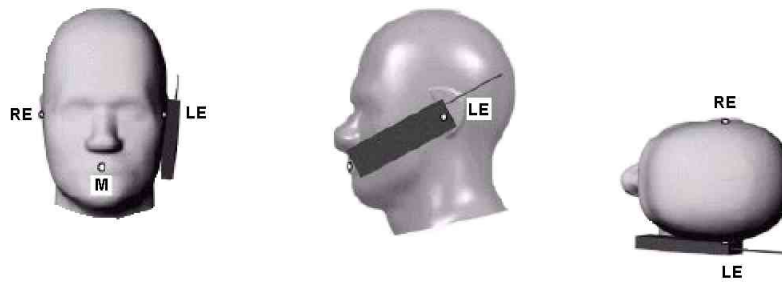
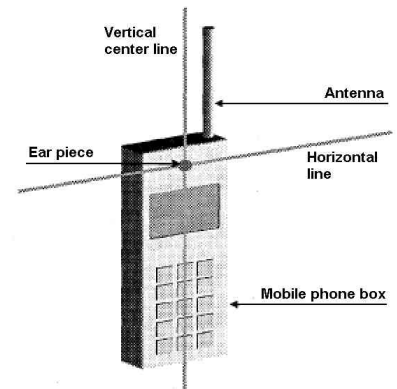

10.1.2 Ear-Tilt Position

1. Position the device in the “Cheek-Touch Position”.
2. While maintaining the device in the reference plane and pivoting against the ear, move it outward away from the mouth by an angle of 15 degrees or until contact with the ear is lost.

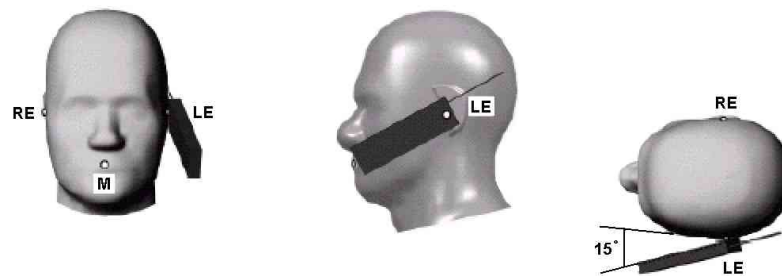

10.2 Body-worn Accessory Exposure Conditions

Body-worn operating configurations should be tested with the belt-clips and holsters attached to the device and positioned against a flat phantom in normal use configurations. Both the physical spacing to the body of the user as dictated by the accessory and the materials used in an accessory affect the SAR produced by the transmitting device. For purpose of determining test requirements, accessories may be divided into two categories: those that do not contain metallic components and those that do.

When multiple accessories that do not contain metallic components are supplied with the device, the device may be tested with only the accessory that dictates the closest spacing to the body. When multiple accessories that contain metallic components are supplied with the device, the device must be tested with each accessory that contains a unique metallic component. If multiple accessories share an identical metallic component (e.g., the same metallic belt-clip used with different holsters with no other metallic components), only the accessory that dictates the closest spacing to the body must be tested.

Body-worn accessories may not always be supplied or available as options for some devices that are intended to be authorized for body-worn use. A separation distance of 1.5 cm between the surface of the device and a flat phantom is recommended for testing body-worn SAR compliance under such circumstances. Other separation distances may be used, but they should not exceed 2.5 cm. In these cases, the device may use body-worn accessories that provide a separation distance greater than that tested for the device provided however that the accessory contains no metallic components.

When the reported SAR for a body-worn accessory, measured without a headset connected to the handset, is > 1.2 W/kg, the highest reported SAR configuration for that wireless mode and frequency band should be repeated for that body-worn accessory with a headset attached to the handset.

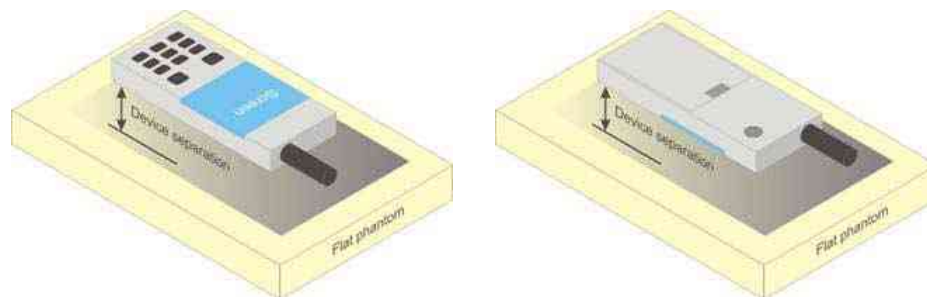

10.3 Hotspot Mode Exposure Conditions

For cell phones that support hotspot mode operations, with wireless router capabilities and various web browsing functions, the relevant hand and body exposure conditions are tested according to the hotspot SAR procedures in KDB 941225. A test separation distance of 10 mm is required between the phantom and all surfaces and edges with a transmitting antenna located within 25 mm from that surface or edge. When the form factor of a handset is smaller than 9 cm × 5 cm, a test separation distance of 5 mm (instead of 10 mm) is required for testing hotspot mode. When the separation distance required for body-worn accessory testing is larger than or equal to that tested for hotspot mode, in the same wireless mode and for the same surface of the phone, the hotspot mode SAR data may be used to support body-worn accessory SAR compliance for that particular configuration (surface).

10.4 RF Exposure Conditions

Handsets are tested for SAR compliance in head, body-worn accessory and other use configurations according to the procedures described in KDB 648474 D04.

10.4.1 Head Exposure Conditions

Test Position	SAR Required	Note
Left Touch	YES	
Left Tilt (15°)	YES	
Right Touch	YES	
Right Tilt (15°)	YES	

10.4.2 Body-worn Accessory Exposure Conditions

Test Position	SAR Required	Note
Rear	YES	Tablet mode SAR data (0mm separation distance) is used to support SAR compliance.
Front	YES	

10.4.3 Phablet SAR test considerations

The normally required head and body-worn accessory SAR test procedures for handsets are applied. The normal tablet procedures in KDB 616217 are required because the over diagonal dimension of the device is > 20.0 cm. Therefore, hotspot mode SAR is not required. Extremity 10-g SAR is also not required for the front surface.

11 Tissue Verification

11.1 Tissue Verification Measurement Condition

The tissue dielectric parameters must be measured before the tissue-equivalent medium is used in a series of SAR measurements. The parameters should be re-measured after each 3 – 4 days of use, or earlier if dielectric parameters can become out of tolerance; for example, when the parameters are marginal at the beginning of the measurement series.

The temperature of the tissue-equivalent medium used during measurement must be within 18°C to 25°C and within ± 2°C of the temperature when the tissue parameters are characterized.

It is verified by using the dielectric probe and the network analyzer.

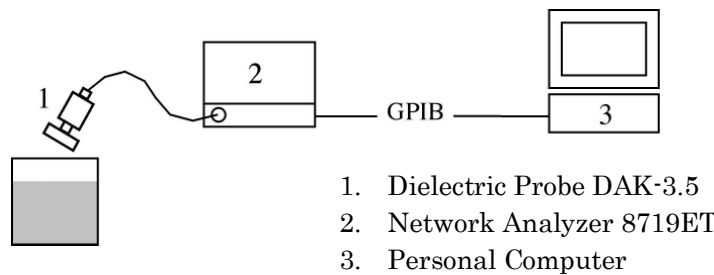

11.2 Tissue Dielectric Properties

The tissue dielectric properties are specified in KDB 865664 D01.

Target Frequency [MHz]	Head		Body	
	Permittivity (ϵ_r)	Conductivity (σ)	Permittivity (ϵ_r)	Conductivity (σ)
150	52.3	0.76	61.9	0.80
300	45.3	0.87	58.2	0.92
450	43.5	0.87	56.7	0.94
835	41.5	0.90	55.2	0.97
900	41.5	0.97	55.0	1.05
915	41.5	0.98	55.0	1.06
1450	40.5	1.20	54.0	1.30
1610	40.3	1.29	53.8	1.40
1800 – 2000	40.0	1.40	53.3	1.52
2450	39.2	1.80	52.7	1.95
3000	38.5	2.40	52.0	2.73
5800	35.3	5.27	48.2	6.00

For tissue dielectric properties at other frequencies within the range, a linear interpolation method shall be used.

11.4 Tissue Verification Results

Tissue dielectric parameters are measured at the low, middle and high frequency of each operating frequency range of the test device.

Date	Liquid	Frequency [MHz]	Parameters	Target	Measured	Deviation [%]	Limit [%]
4/3/2014	Body	1850	Permittivity (ϵ_r)	53.3	52.28	-1.91	± 5
			Conductivity (σ)	1.52	1.514	-0.39	± 5
		1900	Permittivity (ϵ_r)	53.3	52.13	-2.20	± 5
			Conductivity (σ)	1.52	1.570	+3.29	± 5
		1910	Permittivity (ϵ_r)	53.3	52.11	-2.23	± 5
			Conductivity (σ)	1.52	1.581	+4.01	± 5
4/8/2014	Head	1850	Permittivity (ϵ_r)	40.0	39.55	-1.13	± 5
			Conductivity (σ)	1.40	1.385	-1.07	± 5
		1900	Permittivity (ϵ_r)	40.0	39.35	-1.63	± 5
			Conductivity (σ)	1.40	1.436	+2.57	± 5
		1910	Permittivity (ϵ_r)	40.0	39.32	-1.70	± 5
			Conductivity (σ)	1.40	1.446	+3.29	± 5
4/8/2014	Body	1850	Permittivity (ϵ_r)	53.3	52.29	-1.89	± 5
			Conductivity (σ)	1.52	1.512	-0.53	± 5
		1900	Permittivity (ϵ_r)	53.3	52.18	-2.10	± 5
			Conductivity (σ)	1.52	1.565	+2.96	± 5
		1910	Permittivity (ϵ_r)	53.3	52.15	-2.16	± 5
			Conductivity (σ)	1.52	1.577	+3.75	± 5
4/10/2014	Head	820	Permittivity (ϵ_r)	41.6	42.10	+1.20	± 5
			Conductivity (σ)	0.90	0.915	+1.67	± 5
		835	Permittivity (ϵ_r)	41.5	41.94	+1.06	± 5
			Conductivity (σ)	0.90	0.928	+3.11	± 5
		850	Permittivity (ϵ_r)	41.5	41.80	+0.72	± 5
			Conductivity (σ)	0.92	0.944	+2.61	± 5
4/10/2014	Body	820	Permittivity (ϵ_r)	55.3	55.00	-0.54	± 5
			Conductivity (σ)	0.97	0.987	+1.75	± 5
		835	Permittivity (ϵ_r)	55.2	54.89	-0.56	± 5
			Conductivity (σ)	0.97	1.002	+3.30	± 5
		850	Permittivity (ϵ_r)	55.2	54.81	-0.71	± 5
			Conductivity (σ)	0.99	1.018	+2.83	± 5
4/11/2014	Body	820	Permittivity (ϵ_r)	55.3	55.12	-0.33	± 5
			Conductivity (σ)	0.97	0.986	+1.65	± 5
		835	Permittivity (ϵ_r)	55.2	54.99	-0.38	± 5
			Conductivity (σ)	0.97	1.001	+3.20	± 5
		850	Permittivity (ϵ_r)	55.2	54.85	-0.63	± 5
			Conductivity (σ)	0.99	1.018	+2.83	± 5

Tissue Verification Results (continued)

Date	Liquid	Frequency [MHz]	Parameters	Target	Measured	Deviation [%]	Limit [%]
4/13/2014	Head	820	Permittivity (ϵ_r)	41.6	42.61	+2.43	± 5
			Conductivity (σ)	0.90	0.906	+0.67	± 5
		835	Permittivity (ϵ_r)	41.5	42.43	+2.24	± 5
			Conductivity (σ)	0.90	0.922	+2.44	± 5
		850	Permittivity (ϵ_r)	41.5	42.26	+1.83	± 5
			Conductivity (σ)	0.92	0.935	+1.63	± 5
4/15/2014	Body	2410	Permittivity (ϵ_r)	52.8	51.65	-2.18	± 5
			Conductivity (σ)	1.91	1.881	-1.52	± 5
		2450	Permittivity (ϵ_r)	52.7	51.51	-2.26	± 5
			Conductivity (σ)	1.95	1.934	-0.82	± 5
		2465	Permittivity (ϵ_r)	52.7	51.46	-2.35	± 5
			Conductivity (σ)	1.97	1.957	-0.66	± 5
4/15/2014	Head	2410	Permittivity (ϵ_r)	39.3	38.67	-1.60	± 5
			Conductivity (σ)	1.76	1.820	+3.41	± 5
		2450	Permittivity (ϵ_r)	39.2	38.49	-1.81	± 5
			Conductivity (σ)	1.80	1.865	+3.61	± 5
		2465	Permittivity (ϵ_r)	39.2	38.44	-1.94	± 5
			Conductivity (σ)	1.82	1.886	+3.63	± 5
4/16/2014	Body	5180	Permittivity (ϵ_r)	49.0	48.25	-1.53	± 5
			Conductivity (σ)	5.28	5.401	+2.29	± 5
		5200	Permittivity (ϵ_r)	49.0	48.19	-1.65	± 5
			Conductivity (σ)	5.30	5.418	+2.23	± 5
		5240	Permittivity (ϵ_r)	49.0	48.15	-1.73	± 5
			Conductivity (σ)	5.35	5.470	+2.24	± 5
4/17/2014	Body	5260	Permittivity (ϵ_r)	48.9	48.08	-1.68	± 5
			Conductivity (σ)	5.37	5.488	+2.20	± 5
		5300	Permittivity (ϵ_r)	48.9	48.05	-1.74	± 5
			Conductivity (σ)	5.42	5.512	+1.70	± 5
		5320	Permittivity (ϵ_r)	48.9	48.00	-1.84	± 5
			Conductivity (σ)	5.44	5.525	+1.56	± 5
4/17/2014	Body	5500	Permittivity (ϵ_r)	48.6	47.65	-1.95	± 5
			Conductivity (σ)	5.65	5.802	+2.69	± 5
		5600	Permittivity (ϵ_r)	48.5	47.50	-2.06	± 5
			Conductivity (σ)	5.77	5.937	+2.89	± 5
		5700	Permittivity (ϵ_r)	48.3	47.33	-2.01	± 5
			Conductivity (σ)	5.88	6.073	+3.28	± 5

Tissue Verification Results (continued)

Date	Liquid	Frequency [MHz]	Parameters	Target	Measured	Deviation [%]	Limit [%]
4/18/2014	Body	5500	Permittivity (ϵ_r)	48.6	47.44	-2.39	± 5
			Conductivity (σ)	5.65	5.837	+3.31	± 5
		5600	Permittivity (ϵ_r)	48.5	47.26	-2.56	± 5
			Conductivity (σ)	5.77	5.970	+3.47	± 5
		5700	Permittivity (ϵ_r)	48.3	47.09	-2.51	± 5
			Conductivity (σ)	5.88	6.100	+3.74	± 5
4/19/2014	Head	5180	Permittivity (ϵ_r)	36.0	36.53	+1.47	± 5
			Conductivity (σ)	4.63	4.501	-2.79	± 5
		5200	Permittivity (ϵ_r)	36.0	36.48	+1.33	± 5
			Conductivity (σ)	4.66	4.524	-2.92	± 5
		5240	Permittivity (ϵ_r)	35.9	36.46	+1.56	± 5
			Conductivity (σ)	4.70	4.535	-3.51	± 5
4/19/2014	Head	5260	Permittivity (ϵ_r)	35.9	36.31	+1.14	± 5
			Conductivity (σ)	4.72	4.561	-3.37	± 5
		5300	Permittivity (ϵ_r)	35.9	36.28	+1.06	± 5
			Conductivity (σ)	4.76	4.576	-3.87	± 5
		5320	Permittivity (ϵ_r)	35.8	36.28	+1.34	± 5
			Conductivity (σ)	4.78	4.603	-3.70	± 5
4/20/2014	Head	5500	Permittivity (ϵ_r)	35.6	35.39	-0.59	± 5
			Conductivity (σ)	4.96	4.761	-4.01	± 5
		5600	Permittivity (ϵ_r)	35.5	35.27	-0.65	± 5
			Conductivity (σ)	5.07	4.864	-4.06	± 5
		5700	Permittivity (ϵ_r)	35.4	35.13	-0.76	± 5
			Conductivity (σ)	5.17	4.971	-3.85	± 5
4/22/2014	Head	1850	Permittivity (ϵ_r)	40.0	39.02	-2.45	± 5
			Conductivity (σ)	1.40	1.369	-2.21	± 5
		1900	Permittivity (ϵ_r)	40.0	38.79	-3.03	± 5
			Conductivity (σ)	1.40	1.420	+1.43	± 5
		1910	Permittivity (ϵ_r)	40.0	38.74	-3.15	± 5
			Conductivity (σ)	1.40	1.430	+2.14	± 5

12 System Performance Check

12.1 System Performance Check Measurement Condition

The power meter PM1 (including Attenuator) measures the forward power at the location of the validation dipole connector. The signal generator is adjusted for 250 mW at the dipole connector and the power meter PM2 is read at that level. After connecting the cable to the dipole, the signal generator is readjusted for the same reading at power meter PM2.

The dipole antenna is matched to be used near flat phantom filled with tissue simulating solution. A specific distance holder is used in the positioning of the antenna to ensure correct spacing between the phantom and the dipole.

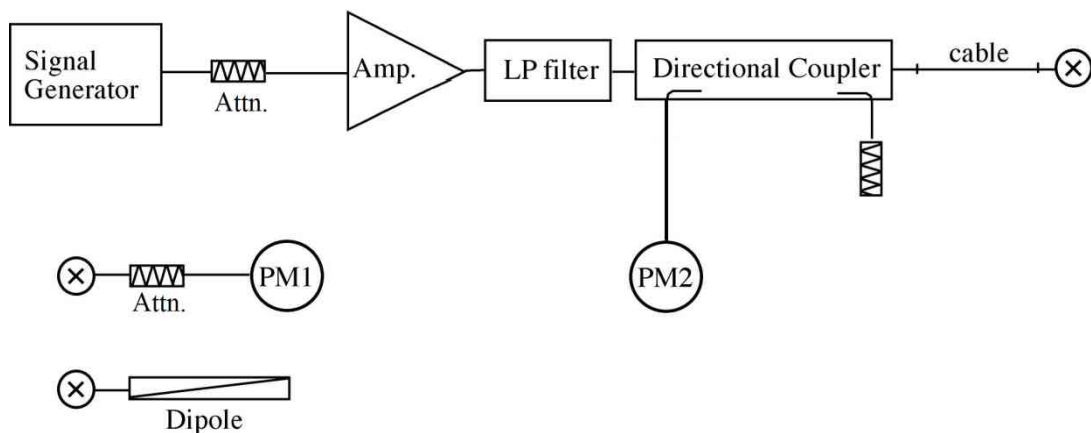

12.2 Target SAR Values for System Performance Check

The target SAR values can be obtained from the calibration certificate of system validation dipoles.

System Dipole		Cal. Date	Frequency [MHz]	Target SAR Values [W/kg]		
Type	Serial			1g/10g	Head	Body
D835V2	4d081	8/15/2013	835	1g	9.48	9.40
				10g	6.16	6.20
D1900V2	5d112	8/22/2013	1900	1g	40.6	41.1
				10g	21.3	21.8
D2450V2	714	11/14/2013	2450	1g	52.8	49.8
				10g	24.6	23.3
D5GHzV2	1111	9/19/2013	5200	1g	78.8	74.2
				10g	22.4	20.8
			5300	1g	81.6	76.4
				10g	23.3	21.4
			5600	1g	80.1	79.4
				10g	22.8	22.0

12.3 System Performance Check Results

The SAR measured with a system validation dipole, using the required tissue-equivalent medium at the test frequency, must be within 10 % of the manufacturer calibrated dipole SAR target.

Date	System Dipole		Liquid	Measured SAR [W/kg] (Normalized to 1 W)		Target	Deviation [%]	Limit [%]
	Type	Serial						
4/3/2014	D1900V2	5d112	Body	1 g	37.92	41.1	-7.74	± 10
				10 g	20.36	21.8	-6.61	± 10
4/8/2014	D1900V2	5d112	Head	1 g	38.84	40.6	-4.33	± 10
				10 g	20.60	21.3	-3.29	± 10
4/8/2014	D1900V2	5d112	Body	1 g	38.84	41.1	-5.50	± 10
				10 g	20.88	21.8	-4.22	± 10
4/10/2014	D835V2	4d081	Head	1 g	9.96	9.48	+5.06	± 10
				10 g	6.52	6.16	+5.84	± 10
4/10/2014	D835V2	4d081	Body	1 g	10.24	9.40	+8.94	± 10
				10 g	6.76	6.20	+9.03	± 10
4/11/2014	D835V2	4d081	Body	1 g	10.20	9.40	+8.51	± 10
				10 g	6.76	6.20	+9.03	± 10
4/13/2014	D835V2	4d081	Head	1 g	9.68	9.48	+2.11	± 10
				10 g	6.32	6.16	+2.60	± 10
4/15/2014	D2450V2	714	Body	1 g	51.60	49.8	+3.61	± 10
				10 g	24.40	23.3	+4.72	± 10
4/15/2014	D2450V2	714	Head	1 g	52.80	52.8	+0.00	± 10
				10 g	24.28	24.6	-1.30	± 10
4/16/2014	D5GHzV2 (5.2GHz)	1111	Body	1 g	79.20	74.2	+6.74	± 10
				10 g	22.36	20.8	+7.50	± 10
4/17/2014	D5GHzV2 (5.3GHz)	1111	Body	1 g	77.60	76.4	+1.57	± 10
				10 g	22.28	21.4	+4.11	± 10
4/17/2014	D5GHzV2 (5.6GHz)	1111	Body	1 g	81.20	79.4	+2.27	± 10
				10 g	22.56	22.0	+2.55	± 10
4/18/2014	D5GHzV2 (5.6GHz)	1111	Body	1 g	84.00	79.4	+5.79	± 10
				10 g	23.28	22.0	+5.82	± 10
4/19/2014	D5GHzV2 (5.2GHz)	1111	Head	1 g	73.60	78.8	-6.60	± 10
				10 g	21.40	22.4	-4.46	± 10
4/19/2014	D5GHzV2 (5.3GHz)	1111	Head	1 g	78.00	81.6	-4.41	± 10
				10 g	22.24	23.3	-4.55	± 10
4/20/2014	D5GHzV2 (5.6GHz)	1111	Head	1 g	79.60	80.1	-0.62	± 10
				10 g	22.52	22.8	-1.23	± 10
4/22/2014	D1900V2	5d112	Head	1 g	38.84	40.6	-4.33	± 10
				10 g	20.64	21.3	-3.10	± 10

13 RF Output Power Measurements

13.1 GSM

Settings	Mode	Parameter	
General Settings	Band Indicator	GSM 850	PCS 1900
	Power Control Level	5 (33 dBm)	0 (30 dBm)
GPRS Specific Settings	Connection Type	Test Mode A	
	Multi Slot Class	12 (4 down / 4 up / 5 sum)	
	Coding Scheme	CS1 (GMSK)	

13.1.1 GSM 850

Mode		Conducted Average Power (dBm)					
		128 ch (824.2 MHz)		189 ch (836.4 MHz)		251 ch (848.8 MHz)	
		Burst	Frame	Burst	Frame	Burst	Frame
GSM	Voice	26.69	17.66	26.75	17.72	26.77	17.74
GPRS	1 slot	26.69	17.66	26.75	17.72	26.77	17.74
	2 slots	24.52	18.50	24.57	18.55	24.75	18.73
	3slots	23.01	18.75	23.26	19.00	23.33	19.07
	4 slots	22.23	19.22	22.10	19.09	22.35	19.34

Note(s):

KDB 941225 D03 – The worst-case configuration for SAR testing is determined to be as follows.

1. Body : GPRS mode with 4 time slots, based on the output power above
2. Head : Same mode as Body SAR testing (VoIP applicable using GPRS multi-slot)

13.1.2 PCS 1900

Mode		Conducted Average Power (dBm)					
		512 ch (1850.2 MHz)		661 ch (1880.0 MHz)		810 ch (1909.8 MHz)	
		Burst	Frame	Burst	Frame	Burst	Frame
GSM	Voice	21.54	12.51	21.45	12.42	21.31	12.28
GPRS	1 slot	21.54	12.51	21.45	12.42	21.31	12.28
	2 slots	19.03	13.01	18.84	12.82	19.04	13.02
	3slots	17.60	13.34	17.56	13.30	17.62	13.36
	4 slots	16.73	13.72	16.66	13.65	16.67	13.66

Note(s):

KDB 941225 D03 – The worst-case configuration for SAR testing is determined to be as follows.

1. Body : GPRS mode with 4 time slots, based on the output power above
2. Head : Same mode as Body SAR testing (VoIP applicable using GPRS multi-slot)

13.2 WCDMA

The following tests were completed according to the test requirements outlined in section 5.2 of the 3GPP TS34.121-1 specification.

Release 99 WCDMA

Settings	Release 99	
Loopback Mode	Mode 1	OFF
Channel Coding	12.2k / 64k / 144k / 384kbps RMC	Voice AMR
TPC Bit Pattern	All 1	
Power Tolerance (dB)	+1.7/-3.7	

HSDPA

Settings	Release 8 HSDPA			
Sub-test	1	2	3	4
Loopback Mode	Mode 1			
Channel Coding	Fixed Reference Channel (QPSK)			
TPC Algorithm	2			
TPC Bit Pattern	All 1			
Beta C	2	11	15	15
Beta D	15	15	8	4
Delta ACK	8			
Delta NACK	8			
Delta CQI	8			
CQI Feedback Cycle	4 ms			
Ack-Nack Repetition Factor	3			
CQI Repetition Factor	2			
MPR (dB)	0	0	0.5	0.5
Power Tolerance (dB)	+1.7/-3.7	+1.7/-3.7	+2.7/-3.7	+3.7/-3.7

HSPA (HSDPA & HSUPA)

Settings	Release 8 HSPA				
Sub-test	1	2	3	4	5
Loopback Mode	Mode 1				
Channel Coding	E-DCH RF Test with TTI 10ms (QPSK)				
TPC Algorithm	2				1
TPC Bit Pattern	Inner Loop Power Control				All 1
Beta C	10	6	15	2	15
Beta D	15	15	9	15	0
Delta ACK	8				0
Delta NACK	8				0
Delta CQI	8				0
CQI Feedback Cycle	4 ms				
Ack-Nack Repetition Factor	3				
CQI Repetition Factor	2				
Delta E-DPCCH	6	8	8	5	0
Absolute Grant Value	20	12	15	17	12
E-TFCI	75	67	92	71	67
MPR (dB)	0	2	1	2	0
Power Tolerance (dB)	+1.7/-6.7	+3.7/-5.2	+2.7/-5.2	+3.7/-5.2	+1.7/-3.7

Band V

Mode		Conducted Average Power (dBm)		
		4132 ch (826.4 MHz)	4182 ch (836.4 MHz)	4233 ch (846.6 MHz)
WCDMA	12.2 kbps RMC	17.58	17.54	17.46
	64 kbps RMC	17.58	17.54	17.46
	144 kbps RMC	17.57	17.53	17.45
	384 kbps RMC	17.57	17.53	17.45
	Voice AMR	17.58	17.54	17.45
HSDPA	Sub-test 1	16.65	16.34	16.49
	Sub-test 2	16.66	16.35	16.45
	Sub-test 3	16.08	15.85	15.96
	Sub-test 4	16.07	15.86	15.96
HSPA	Sub-test 1	16.41	16.28	16.38
	Sub-test 2	15.43	15.31	15.28
	Sub-test 3	14.93	14.78	14.87
	Sub-test 4	16.15	15.90	15.98
	Sub-test 5	16.66	16.33	16.50

Note(s):

1. KDB 941225 D01 – SAR in voice and data modes is measured using a 12.2 kbps RMC. SAR in voice AMR configurations and for other spreading codes are not required when the maximum average output of each channel is less than ¼ dB higher than that measured in 12.2 kbps RMC.
2. KDB 941225 D01 – Body SAR for HSDPA is not required when the maximum average output with HSDPA active is less than ¼ dB higher than that measured without HSDPA using 12.2 kbps RMC and the maximum SAR for 12.2 kbps RMC is ≤ 75% of the SAR limit.
3. KDB 941225 D01 – Body SAR for HSPA (HSDPA/HSUPA) is not required when the maximum average output with HSPA active is less than ¼ dB higher than that measured without HSPA using 12.2 kbps RMC and the maximum SAR for 12.2 kbps RMC is ≤ 75% of the SAR limit.
4. KDB 941225 D01 – Head SAR for HSPA (VoIP applicable) is not required when the maximum average output with HSPA active is less than ¼ dB higher than that measured without HSPA using 12.2 kbps RMC.

13.3 WLAN (DTS Band)

Band	Mode	Channel	Frequency (MHz)	Average Power (dBm)
2.4 GHz (DTS)	802.11b	1	2412	13.36
		6	2437	12.88
		11	2462	13.37
	802.11g	1	2412	13.25
		6	2437	13.04
		11	2462	13.33
	802.11n [HT20]	1	2412	13.46
		6	2437	12.98
		11	2462	13.45

Note(s):

KDB 248227 D01 – SAR is not required for 802.11g/n channels when the maximum average output power is less than ¼ dB higher than that measured on the corresponding 802.11b channels.

13.4 WLAN (U-NII Band)

5.2 GHz Band (U-NII 1)

Band	Mode	Channel	Frequency (MHz)	Average Power (dBm)
5.2 GHz (U-NII 1)	802.11a	36	5180	9.00
		40	5200	8.97
		44	5220	8.88
		48	5240	8.93
	802.11n [HT20]	36	5180	9.00
		44	5220	8.93
		48	5240	8.94
	802.11n [HT40]	38	5190	8.78
		46	5230	8.81
	802.11ac [VHT80]	42	5210	8.99

5.3 GHz Band (U-NII 2A)

Band	Mode	Channel	Frequency (MHz)	Average Power (dBm)
5.3 GHz (U-NII 2A)	802.11a	52	5260	8.83
		56	5280	8.99
		60	5300	9.07
		64	5320	9.06
	802.11n [HT20]	52	5260	9.03
		60	5300	8.87
		64	5320	9.02
	802.11n [HT40]	54	5270	8.86
		62	5310	9.05
	802.11ac [VHT80]	58	5290	9.02

5.6 GHz Band (U-NII 2C)

Band	Mode	Channel	Frequency (MHz)	Average Power (dBm)
5.6 GHz (U-NII 2C)	802.11a	100	5500	8.91
		104	5520	8.93
		108	5540	9.04
		112	5560	8.93
		116	5580	9.08
		120	5600	9.06
		124	5620	9.01
		128	5640	8.87
		132	5660	9.07
		136	5680	8.90
	802.11n [HT20]	100	5500	9.06
		120	5600	9.09
		140	5700	8.98
	802.11n [HT40]	102	5510	9.07
		118	5590	8.92
		134	5670	9.11
	802.11ac [VHT80]	106	5530	8.99
		122	5610	9.16

Note(s):

KDB 248227 D01 – SAR is not required for 802.11n/ac channels when the maximum average output power is less than ¼ dB higher than that measured on the corresponding 802.11a channels.

13.5 Bluetooth

Maximum tune-up tolerance limit is 7.0 dBm from the rated nominal maximum output power.
 This power level qualifies for exclusion of SAR testing.

13.6 Standalone SAR Test Exclusion Considerations (KDB 447498 D01)

13.6.1 SAR Test Exclusion for antenna ≤ 50 mm from the user

The 1 g SAR test exclusion thresholds for 100 MHz to 6 GHz at *test separation distances* ≤ 50 mm are determined by;

$[(\text{max. power of channel, including tune-up tolerance, mW}) / (\text{min. test separation distance, mm})] \cdot [\sqrt{f_{\text{(GHz)}}}] \leq 3.0$, where

- $f_{\text{(GHz)}}$ is the RF channel transmit frequency in GHz.
- Power and distance are rounded to the nearest mW and mm before calculation.
- The result is rounded to one decimal place for comparison.
- When the minimum test separation distance is < 5 mm, a distance of 5 mm is applied.

Phone mode

Band	Frequency (MHz)	Max. Power		Test Position	Distance (mm)	Threshold	Test Exclusion
		(dBm)	(mW)				
WLAN 2.4 GHz	2462	14.0	25	Head	< 5	7.8	NO
				Body	10	3.9	NO
WLAN 5 GHz	5700	10.0	10	Head	< 5	4.8	NO
				Body	10	2.4	YES
Bluetooth	2480	7.0	5	Head	< 5	1.6	YES
				Body	10	0.8	YES

Tablet mode for WWAN

Band	Frequency (MHz)	Max. Power		Test Position	Distance (mm)	Threshold	Test Exclusion
		(dBm)	(mW)				
GSM 850 (GPRS 4slots)	848.8	22.6	182	Rear	< 5	33.5	NO
				Bottom	< 5	33.5	NO
				Left	32	5.2	NO
				Right	22	7.6	NO
PCS 1900 (GPRS 4slots)	1909.8	17.8	60	Rear	< 5	16.6	NO
				Bottom	< 5	16.6	NO
				Left	32	2.6	YES
				Right	22	3.8	NO
WCDMA Band V	846.6	18.5	71	Rear	< 5	13.1	NO
				Bottom	< 5	13.1	NO
				Left	32	2.0	YES
				Right	22	3.0	NO

Tablet mode for WLAN and Bluetooth

Band	Frequency (MHz)	Max. Power		Test Position	Distance (mm)	Threshold	Test Exclusion
		(dBm)	(mW)				
WLAN 2.4 GHz	2462	14.0	25	Rear	< 5	7.8	NO
				Top	25	1.6	YES
				Right	< 5	7.8	NO
WLAN 5 GHz	5700	10.0	10	Rear	< 5	4.8	NO
				Top	25	1.0	YES
				Right	< 5	4.8	NO
Bluetooth	2480	7.0	5	Rear	< 5	1.6	YES
				Top	25	0.3	YES
				Right	< 5	1.6	YES

13.6.2 SAR Test Exclusion for antenna > 50 mm from the user

At 100 MHz to 6 GHz and for *test separation distances* > 50 mm, the SAR test exclusion threshold is determined according to the following;

$[(\text{Power allowed at numeric threshold for 50 mm}) + (\text{test separation distance} - 50 \text{ mm}) \cdot (f_{\text{(MHz)}}/150)]$ mW, at 100 MHz to 1500 MHz

$[(\text{Power allowed at numeric threshold for 50 mm}) + (\text{test separation distance} - 50 \text{ mm}) \cdot 10]$ mW, at > 1500 MHz and ≤ 6 GHz

Tablet mode for WWAN

Band	Frequency (MHz)	Max. Power		Test Position	Distance (mm)	Threshold (mW)	Test Exclusion
		(dBm)	(mW)				
GSM 850 (GPRS 4slots)	848.8	22.6	182	Top	167	825	YES
PCS 1900 (GPRS 4slots)	1909.8	17.8	60	Top	167	1279	YES
WCDMA Band V	846.6	18.5	71	Top	167	823	YES

Tablet mode for WLAN and Bluetooth

Band	Frequency (MHz)	Max. Power		Test Position	Distance (mm)	Threshold (mW)	Test Exclusion
		(dBm)	(mW)				
WLAN 2.4 GHz	2462	14.0	25	Bottom	128	876	YES
				Left	100	596	YES
WLAN 5 GHz	5700	10.0	10	Bottom	128	843	YES
				Left	100	563	YES
Bluetooth	2480	7.0	5	Bottom	128	875	YES
				Left	100	595	YES

14 SAR Measurements

14.1 GSM 850

Head

GPRS 4 slots (CS1) – Duty Cycle 48.0%							
Test Position	Ch#	Freq. [MHz]	Power [dBm]		1 g SAR [W/kg]		Plot No.
			Tune-up Limit	Meas.	Meas.	Scaled	
Left Touch	189	836.4	22.6	22.10	0.049	0.055	1
Left Tilt	189	836.4	22.6	22.10	0.020	0.022	
Right Touch	189	836.4	22.6	22.10	0.029	0.033	
Right Tilt	189	836.4	22.6	22.10	0.021	0.024	

Body-worn Accessory & Tablet mode

GPRS 4 slots (CS1) – Duty Cycle 48.0%								
Test Position	Dist. [mm]	Ch#	Freq. [MHz]	Power [dBm]		1 g SAR [W/kg]		Plot No.
				Tune-up Limit	Meas.	Meas.	Scaled	
Rear	0	128	824.2	22.6	22.23	1.110	1.209	
		189	836.4	22.6	22.10	1.190	1.335	2
		251	848.8	22.6	22.35	1.160	1.229	
Rear w/headset	0	189	836.4	22.6	22.10	1.210	1.358	3
Rear w/headset (repeat #1)	0	189	836.4	22.6	22.10	1.180	1.324	
Front	10	189	836.4	22.6	22.10	0.196	0.220	
Bottom Edge	0	189	836.4	22.6	22.10	0.589	0.661	
Left Edge	0	189	836.4	22.6	22.10	0.091	0.102	
Right Edge	0	189	836.4	22.6	22.10	0.070	0.079	

Note(s):

- KDB 447498 D01 – Testing of other required channels within the operating mode of a frequency band is not required when the reported 1 g SAR for the mid-band or highest output power channel is:
 - ≤ 0.8 W/kg when the transmission band is ≤ 100 MHz
 - ≤ 0.6 W/kg when the transmission band is between 100 MHz and 200 MHz
 - ≤ 0.4 W/kg when the transmission band is ≥ 200 MHz
- KDB 648474 D04 – When the reported SAR for a body-worn accessory, measured without a headset connected to the handset, is > 1.2 W/kg, the highest reported SAR configuration for that wireless mode and frequency band is repeated for that body-worn accessory with a headset attached to the handset.

14.2 PCS 1900

Head

GPRS 4 slots (CS1) – Duty Cycle 48.0%							
Test Position	Ch#	Freq. [MHz]	Power [dBm]		1 g SAR [W/kg]		Plot No.
			Tune-up Limit	Meas.	Meas.	Scaled	
Left Touch	661	1880.0	17.8	16.66	0.006	0.008	4
Left Tilt	661	1880.0	17.8	16.66	0.003	0.004	
Right Touch	661	1880.0	17.8	16.66	0.004	0.005	
Right Tilt	661	1880.0	17.8	16.66	0.003	0.004	

Body-worn Accessory & Tablet mode

GPRS 4 slots (CS1) – Duty Cycle 48.0%								
Test Position	Dist. [mm]	Ch#	Freq. [MHz]	Power [dBm]		1 g SAR [W/kg]		Plot No.
				Tune-up Limit	Meas.	Meas.	Scaled	
Rear	0	512	1850.2	17.8	16.73	0.654	0.837	5
		661	1880.0	17.8	16.66	0.613	0.808	
		810	1909.8	17.8	16.67	0.603	0.782	
Front	10	661	1880.0	17.8	16.66	0.088	0.116	
Bottom Edge	0	512	1850.2	17.8	16.73	0.935	1.196	
		661	1880.0	17.8	16.66	0.893	1.161	
		810	1909.8	17.8	16.67	0.908	1.178	
Bottom Edge (repeat #1)	0	512	1850.2	17.8	16.73	0.958	1.226	6
Right Edge	0	661	1880.0	17.8	16.66	0.010	0.013	

Note(s):

- KDB 447498 D01 – Testing of other required channels within the operating mode of a frequency band is not required when the reported 1 g SAR for the mid-band or highest output power channel is:
 - ≤ 0.8 W/kg when the transmission band is ≤ 100 MHz
 - ≤ 0.6 W/kg when the transmission band is between 100 MHz and 200 MHz
 - ≤ 0.4 W/kg when the transmission band is ≥ 200 MHz

14.3 WCDMA Band V

Head

R99 12.2kbps RMC – Duty Cycle 100%							
Test Position	Ch#	Freq. [MHz]	Power [dBm]		1 g SAR [W/kg]		Plot No.
			Tune-up Limit	Meas.	Meas.	Scaled	
Left Touch	4182	836.4	18.5	17.54	0.049	0.061	7
Left Tilt	4182	836.4	18.5	17.54	0.021	0.026	
Right Touch	4182	836.4	18.5	17.54	0.029	0.036	
Right Tilt	4182	836.4	18.5	17.54	0.019	0.024	

Body-worn Accessory & Tablet mode

R99 12.2kbps RMC – Duty Cycle 100%								
Test Position	Dist. [mm]	Ch#	Freq. [MHz]	Power [dBm]		1 g SAR [W/kg]		Plot No.
				Tune-up Limit	Meas.	Meas.	Scaled	
Rear	0	4132	826.4	18.5	17.58	0.903	1.116	
		4182	836.4	18.5	17.54	0.945	1.179	8
		4233	846.6	18.5	17.46	0.916	1.164	
Front	10	4182	836.4	18.5	17.54	0.208	0.259	
Bottom Edge	0	4182	836.4	18.5	17.54	0.576	0.718	
Right Edge	0	4182	836.4	18.5	17.54	0.077	0.096	

Note(s):

1. KDB 447498 D01 – Testing of other required channels within the operating mode of a frequency band is not required when the reported 1 g SAR for the mid-band or highest output power channel is:
 - ≤ 0.8 W/kg when the transmission band is ≤ 100 MHz
 - ≤ 0.6 W/kg when the transmission band is between 100 MHz and 200 MHz
 - ≤ 0.4 W/kg when the transmission band is ≥ 200 MHz

14.4 WLAN (DTS Band)

Head

802.11b (1 Mbps) – Duty Cycle 100%							
Test Position	Ch#	Freq. [MHz]	Power [dBm]		1 g SAR [W/kg]		Plot No.
			Tune-up Limit	Meas.	Meas.	Scaled	
Left Touch	11	2462	14.0	13.37	0.036	0.042	9
Left Tilt	11	2462	14.0	13.37	0.027	0.031	
Right Touch	11	2462	14.0	13.37	0.013	0.015	
Right Tilt	11	2462	14.0	13.37	0.010	0.012	

Body-worn Accessory & Tablet mode

802.11b (1 Mbps) – Duty Cycle 100%								
Test Position	Dist. [mm]	Ch#	Freq. [MHz]	Power [dBm]		1 g SAR [W/kg]		Plot No.
				Tune-up Limit	Meas.	Meas.	Scaled	
Rear	0	1	2412	14.0	13.36	0.997	1.155	
		6	2437	14.0	12.88	0.894	1.157	
		11	2462	14.0	13.37	1.030	1.191	
Rear (repeat #1)	0	11	2462	14.0	13.37	1.040	1.202	10
Rear w/headset	0	11	2462	14.0	13.37	1.060	1.225	11
Front	10	11	2462	14.0	13.37	0.012	0.014	
Right Edge	0	11	2462	14.0	13.37	0.415	0.480	

Note(s):

- KDB 447498 D01 – Testing of other required channels within the operating mode of a frequency band is not required when the reported 1 g SAR for the mid-band or highest output power channel is:
 - ≤ 0.8 W/kg when the transmission band is ≤ 100 MHz
 - ≤ 0.6 W/kg when the transmission band is between 100 MHz and 200 MHz
 - ≤ 0.4 W/kg when the transmission band is ≥ 200 MHz
- KDB 648474 D04 – When the reported SAR for a body-worn accessory, measured without a headset connected to the handset, is > 1.2 W/kg, the highest reported SAR configuration for that wireless mode and frequency band is repeated for that body-worn accessory with a headset attached to the handset.

14.5 WLAN (U-NII Band)

14.5.1 5.2 GHz Band (U-NII 1)

Head

802.11a (6 Mbps) – Duty Cycle 100%							
Test Position	Ch#	Freq. [MHz]	Power [dBm]		1 g SAR [W/kg]		Plot No.
			Tune-up Limit	Meas.	Meas.	Scaled	
Left Touch	36	5180	10.0	9.00	< 0.001	< 0.001	
Left Tilt	36	5180	10.0	9.00	< 0.001	< 0.001	
Right Touch	36	5180	10.0	9.00	< 0.001	< 0.001	
Right Tilt	36	5180	10.0	9.00	< 0.001	< 0.001	

Body-worn Accessory & Tablet mode

802.11a (6 Mbps) – Duty Cycle 100%								
Test Position	Dist. [mm]	Ch#	Freq. [MHz]	Power [dBm]		1 g SAR [W/kg]		Plot No.
				Tune-up Limit	Meas.	Meas.	Scaled	
Rear	0	36	5180	10.0	9.00	0.935	1.177	12
		48	5240	10.0	8.93	0.721	0.922	
Rear (repeat #1)	0	36	5180	10.0	9.00	0.872	1.098	
Right Edge	0	36	5180	10.0	9.00	0.298	0.375	

Note(s):

- KDB 447498 D01 – Testing of other required channels within the operating mode of a frequency band is not required when the reported 1 g SAR for the mid-band or highest output power channel is:
 - ≤ 0.8 W/kg when the transmission band is ≤ 100 MHz
 - ≤ 0.6 W/kg when the transmission band is between 100 MHz and 200 MHz
 - ≤ 0.4 W/kg when the transmission band is ≥ 200 MHz

14.5.2 5.3 GHz Band (U-NII 2A)

Head

802.11a (6 Mbps) – Duty Cycle 100%							
Test Position	Ch#	Freq. [MHz]	Power [dBm]		1 g SAR [W/kg]		Plot No.
			Tune-up Limit	Meas.	Meas.	Scaled	
Left Touch	60	5300	10.0	9.07	< 0.001	< 0.001	
Left Tilt	60	5300	10.0	9.07	< 0.001	< 0.001	
Right Touch	60	5300	10.0	9.07	< 0.001	< 0.001	
Right Tilt	60	5300	10.0	9.07	< 0.001	< 0.001	

Body-worn Accessory & Tablet mode

802.11a (6 Mbps) – Duty Cycle 100%								
Test Position	Dist. [mm]	Ch#	Freq. [MHz]	Power [dBm]		1 g SAR [W/kg]		Plot No.
				Tune-up Limit	Meas.	Meas.	Scaled	
Rear	0	52	5260	10.0	8.83	1.090	1.427	
		60	5300	10.0	9.07	0.990	1.226	
Rear w/headset	0	52	5260	10.0	8.83	1.070	1.401	
Rear (repeat #1)	0	52	5260	10.0	8.83	1.120	1.466	13
Right Edge	0	60	5300	10.0	9.07	0.352	0.436	

Note(s):

- KDB 447498 D01 – Testing of other required channels within the operating mode of a frequency band is not required when the reported 1 g SAR for the mid-band or highest output power channel is:
 - ≤ 0.8 W/kg when the transmission band is ≤ 100 MHz
 - ≤ 0.6 W/kg when the transmission band is between 100 MHz and 200 MHz
 - ≤ 0.4 W/kg when the transmission band is ≥ 200 MHz
- KDB 648474 D04 – When the reported SAR for a body-worn accessory, measured without a headset connected to the handset, is > 1.2 W/kg, the highest reported SAR configuration for that wireless mode and frequency band is repeated for that body-worn accessory with a headset attached to the handset.

14.5.3 5.6 GHz Band (U-NII 2C)

Head

802.11a (6 Mbps) – Duty Cycle 100%							
Test Position	Ch#	Freq. [MHz]	Power [dBm]		1 g SAR [W/kg]		Plot No.
			Tune-up Limit	Meas.	Meas.	Scaled	
Left Touch	116	5580	10.0	9.08	< 0.001	< 0.001	
Left Tilt	116	5580	10.0	9.08	< 0.001	< 0.001	
Right Touch	116	5580	10.0	9.08	< 0.001	< 0.001	
Right Tilt	116	5580	10.0	9.08	< 0.001	< 0.001	

Body-worn Accessory & Tablet mode

802.11a (6 Mbps) – Duty Cycle 100%								
Test Position	Dist. [mm]	Ch#	Freq. [MHz]	Power [dBm]		1 g SAR [W/kg]		Plot No.
				Tune-up Limit	Meas.	Meas.	Scaled	
Rear	0	104	5520	10.0	8.93	0.978	1.251	14
		116	5580	10.0	9.08	0.603	0.745	
		124	5620	10.0	9.01	0.706	0.887	
		136	5680	10.0	8.90	0.409	0.527	
Rear w/headset	0	104	5520	10.0	8.93	1.010	1.292	15
Rear w/headset (repeat #1)	0	104	5520	10.0	8.93	0.986	1.261	
Right Edge	0	104	5520	10.0	8.93	0.775	0.992	
		116	5580	10.0	9.08	0.616	0.761	
		124	5620	10.0	9.01	0.573	0.720	
		136	5680	10.0	8.90	0.448	0.577	

Note(s):

- KDB 447498 D01 – Testing of other required channels within the operating mode of a frequency band is not required when the reported 1 g SAR for the mid-band or highest output power channel is:
 - ≤ 0.8 W/kg when the transmission band is ≤ 100 MHz
 - ≤ 0.6 W/kg when the transmission band is between 100 MHz and 200 MHz
 - ≤ 0.4 W/kg when the transmission band is ≥ 200 MHz
- KDB 648474 D04 – When the reported SAR for a body-worn accessory, measured without a headset connected to the handset, is > 1.2 W/kg, the highest reported SAR configuration for that wireless mode and frequency band is repeated for that body-worn accessory with a headset attached to the handset.

14.6 SAR Measurement Variability

In accordance with the KDB 865664 D01, these additional measurements are repeated after the completion of all measurements requiring the same head or body tissue-equivalent medium in a frequency band. The DUT should be returned to ambient conditions (normal room temperature) with the battery fully charged before it is re-mounted on the device holder for the repeated measurement(s) to minimize any unexpected variations in the repeated results.

- 1) Repeated measurement is not required when the original highest measured SAR is < 0.80 W/kg; steps 2) through 4) do not apply.
- 2) When the original highest measured SAR is ≥ 0.80 W/kg, repeat that measurement once.
- 3) Perform a 2nd repeated measurement only if the ratio of largest to smallest SAR for the original and first repeated measurements is > 1.20 or when the original or repeated measurement is ≥ 1.45 W/kg (~ 10% from the 1-g SAR limit).
- 4) Perform a 3rd repeated measurement only if the original, first or second repeated measurement is ≥ 1.5 W/kg and the ratio of largest to smallest SAR for the original, first and second repeated measurements is > 1.20.

14.6.1 Highest Measured SAR Configuration in Each Frequency Band

Frequency Band [MHz]	Air Interface	Standalone SAR [W/kg]	
		Head	Body
850	GSM 850	0.049	1.210
	WCDMA Band V	0.049	0.945
1900	PCS 1900	0.006	0.935
2450	WLAN 802.11b	0.036	1.030
5200	WLAN 802.11a	--	0.935
5300	WLAN 802.11a	--	1.090
5600	WLAN 802.11a	--	1.010

14.6.2 Repeated SAR Measurement Results

Band	Test Position	Ch#	Frequency [MHz]	Measured SAR [W/kg]		Largest to Smallest SAR Ratio
				Original	Repeated	
GSM 850	Rear	189	836.4	1.210	1.180	1.03
PCS 1900	Bottom Edge	512	1850.2	0.935	0.958	1.02
WLAN 2.4 GHz	Rear	11	2462	1.030	1.040	1.01
WLAN 5.2 GHz	Rear	36	5180	0.935	0.872	1.07
WLAN 5.3 GHz	Rear	52	5260	1.090	1.120	1.03
WLAN 5.6 GHz	Rear	104	5520	1.010	0.986	1.02

14.7 Simultaneous Transmission SAR Analysis (KDB 447498 D01)

14.7.1 Simultaneous Transmission Condition

WWAN can transmit simultaneously with WLAN/Bluetooth.

WLAN in 2.4 GHz and 5 GHz bands cannot transmit simultaneously with Bluetooth.

No.	Conditions	Phone		Tablet
		Head	Body	
1	GSM 850 + WLAN 2.4 GHz	YES	YES	YES
2	PCS 1900 + WLAN 2.4 GHz	YES	YES	YES
3	WCDMA Band V + WLAN 2.4 GHz	YES	YES	YES
4	GSM 850 + WLAN 5 GHz	YES	YES	YES
5	PCS 1900 + WLAN 5 GHz	YES	YES	YES
6	WCDMA Band V + WLAN 5 GHz	YES	YES	YES
7	GSM 850 + Bluetooth	YES	YES	YES
8	PCS 1900 + Bluetooth	YES	YES	YES
9	WCDMA Band V + Bluetooth	YES	YES	YES

14.7.2 Standalone SAR Estimation

When standalone SAR test exclusion applies to an antenna that transmits simultaneously with other antennas, the standalone SAR must be estimated according to following to determine simultaneous transmission SAR test exclusion:

$[(\text{max. power of channel, including tune-up tolerance, mW}) / (\text{min. test separation distance, mm})] \cdot [\sqrt{f_{\text{GHz}}} / 7.5]$ W/kg for 1 g SAR, test separation distances ≤ 50 mm, or

0.4 W/kg for 1 g SAR, test separation distances > 50 mm

When the minimum test separation distance is < 5 mm, a distance of 5 mm is applied.

Phone mode

Band	Frequency (MHz)	Max. Power		Test Position	Distance (mm)	Estimated SAR (W/kg)
		(dBm)	(mW)			
WLAN 5 GHz	5700	10.0	10	Body	10	0.318
Bluetooth	2480	7.0	5	Head	< 5	0.210
				Body	10	0.105

Tablet mode (WWAN)

Band	Frequency (MHz)	Max. Power		Test Position	Distance (mm)	Estimated SAR (W/kg)
		(dBm)	(mW)			
GSM 850 (GPRS 4slots)	848.8	22.6	182	Top	167	0.400
PCS 1900 (GPRS 4slots)	1909.8	17.8	60	Top	167	0.400
				Left	32	0.345
WCDMA Band V	846.6	18.5	71	Top	167	0.400
				Left	32	0.272

Tablet mode (WLAN and Bluetooth)

Band	Frequency (MHz)	Max. Power		Test Position	Distance (mm)	Estimated SAR (W/kg)
		(dBm)	(mW)			
WLAN 2.4 GHz	2462	14.0	25	Top	25	0.209
				Bottom	128	0.400
				Left	100	0.400
WLAN 5 GHz	5700	10.0	10	Top	25	0.127
				Bottom	128	0.400
				Left	100	0.400
Bluetooth	2480	7.0	5	Top	25	0.042
				Bottom	128	0.400
				Left	100	0.400

The test positions for Top edge and Left edge (except for GSM 850 band) are inherently compliant as it consists of only estimated SAR values for all applicable transmitters and consequently will always have sum of SAR values < 1.2 W/kg.

Simultaneous transmission SAR analysis was therefore not performed for this test position.

14.7.3 SAR to Peak Location Separation Ratio (SPLSR) Calculation

When the sum of SAR is larger than the limit, SAR test exclusion is determined by the SAR to peak location separation ratio. The simultaneous transmitting antennas in each operating mode and exposure condition combination must be considered one pair at a time to determine the SAR to peak location separation ratio to qualify for test exclusion. The ratio is determined by $(SAR_1 + SAR_2)^{1.5}/R_i$, rounded to two decimal digits, and must be ≤ 0.04 for all antenna pairs in the configuration to qualify for 1-g SAR test exclusion. When 10-g SAR applies, the ratio must be ≤ 0.10 . SAR_1 and SAR_2 are the highest reported or estimated SAR for each antenna in the pair, and R_i is the separation distance between the peak SAR locations for the antenna pair in mm.

14.7.4 Sum of the SAR for GSM 850 + WLAN & Bluetooth

14.7.4.1 Head

Test Position	Simultaneous Transmission Scenario				Σ 1 g SAR (W/kg)
	GSM 850	WLAN DTS Band	WLAN U-NII Band	Bluetooth	
Left Touch	0.055	0.042			0.097
	0.055		0.000		0.055
	0.055			0.210	0.265
Left Tilt	0.022	0.031			0.053
	0.022		0.000		0.022
	0.022			0.210	0.232
Right Touch	0.033	0.015			0.048
	0.033		0.000		0.033
	0.033			0.210	0.243
Right Tilt	0.024	0.012			0.036
	0.024		0.000		0.024
	0.024			0.210	0.234

SAR to Peak Location Separation Ratio (SPLSR)

As the sum of the 1 g SAR is < 1.6 W/kg, SPLSR assessment is not required.

Conclusion:

Simultaneous transmission SAR measurement (Volume Scan) is not required because the sum of the 1 g SAR is < 1.6 W/kg.

14.7.4.2 Body-worn Accessory and Tablet mode

Test Position	Simultaneous Transmission Scenario				Σ 1 g SAR (W/kg)
	GSM 850	WLAN DTS Band	WLAN U-NII Band	Bluetooth	
Rear	1.358	1.225			2.583
	1.358		1.466		2.824
	1.358			0.210	1.568
Front	0.220	0.014			0.234
	0.220		0.318		0.538
	0.220			0.105	0.325
Bottom Edge	0.661	0.400			1.061
	0.661		0.400		1.061
	0.661			0.400	1.061
Left Edge	0.102	0.400			0.502
	0.102		0.400		0.502
	0.102			0.400	0.502
Right Edge	0.079	0.480			0.559
	0.079		0.992		1.071
	0.079			0.210	0.289

SAR to Peak Location Separation Ratio (SPLSR)

Test Position	Worst-case combination				Σ 1 g SAR (W/kg)	Distance [mm]	SPLSR	Fig. No.
	GSM 850	WLAN DTS	WLAN U-NII	Bluetooth				
Rear	1.358	1.225			2.583	151.4	0.028	1
	1.358		1.466		2.824	148.3	0.032	2

Conclusion:

Simultaneous transmission SAR measurement (Volume Scan) is not required because the either sum of the 1 g SAR is < 1.6 W/kg or the SPLSR is < 0.04 for all circumstances that require SPLSR calculation.

Figure 1

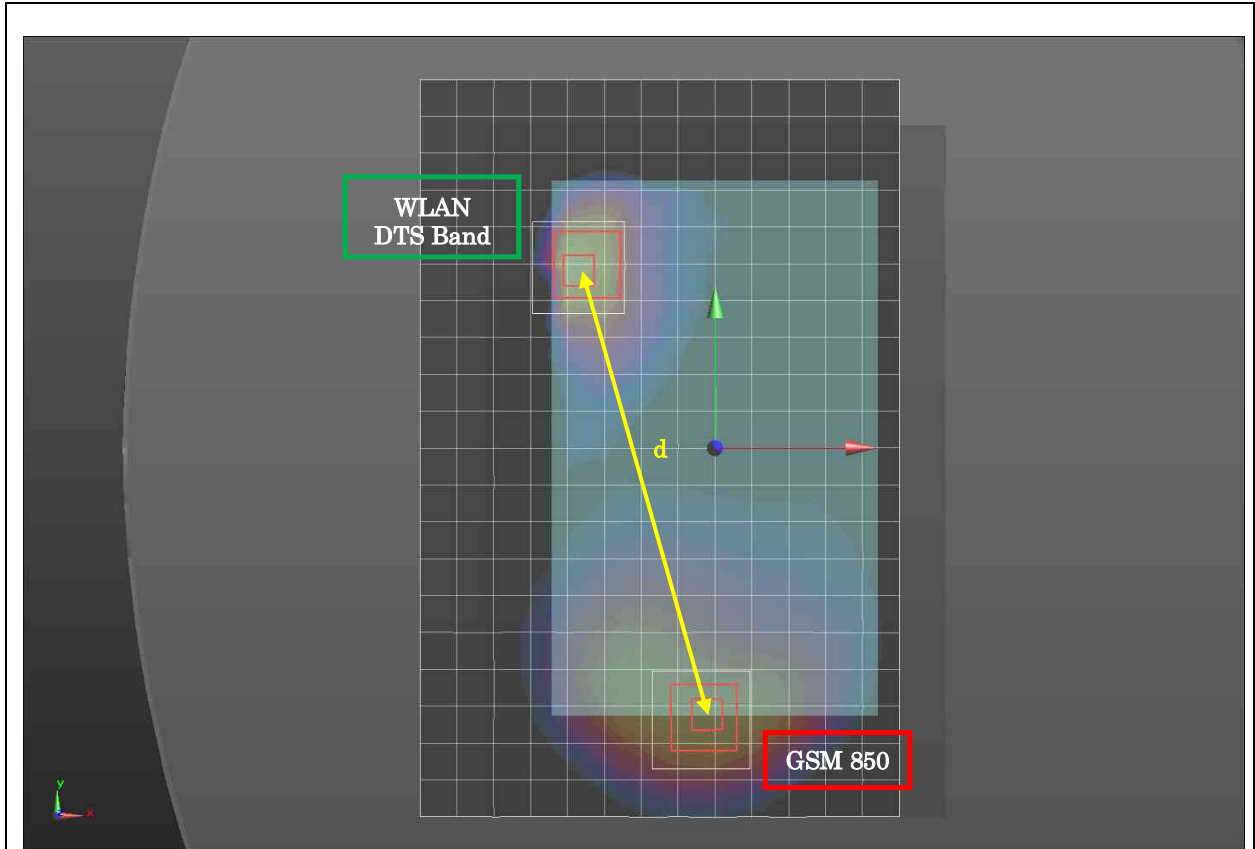

Band	x (m)	y (m)	z (m)
GSM 850	0.0067	-0.0837	-0.0003
WLAN DTS Band	-0.0444	0.0588	0.0002

Calculated Distance : d (mm)	151.4
------------------------------	-------

Note(s):

The peak location separation distance is computed by the square root of $[(x_1-x_2)^2+(y_1-y_2)^2+(z_1-z_2)^2]$.

Figure 2

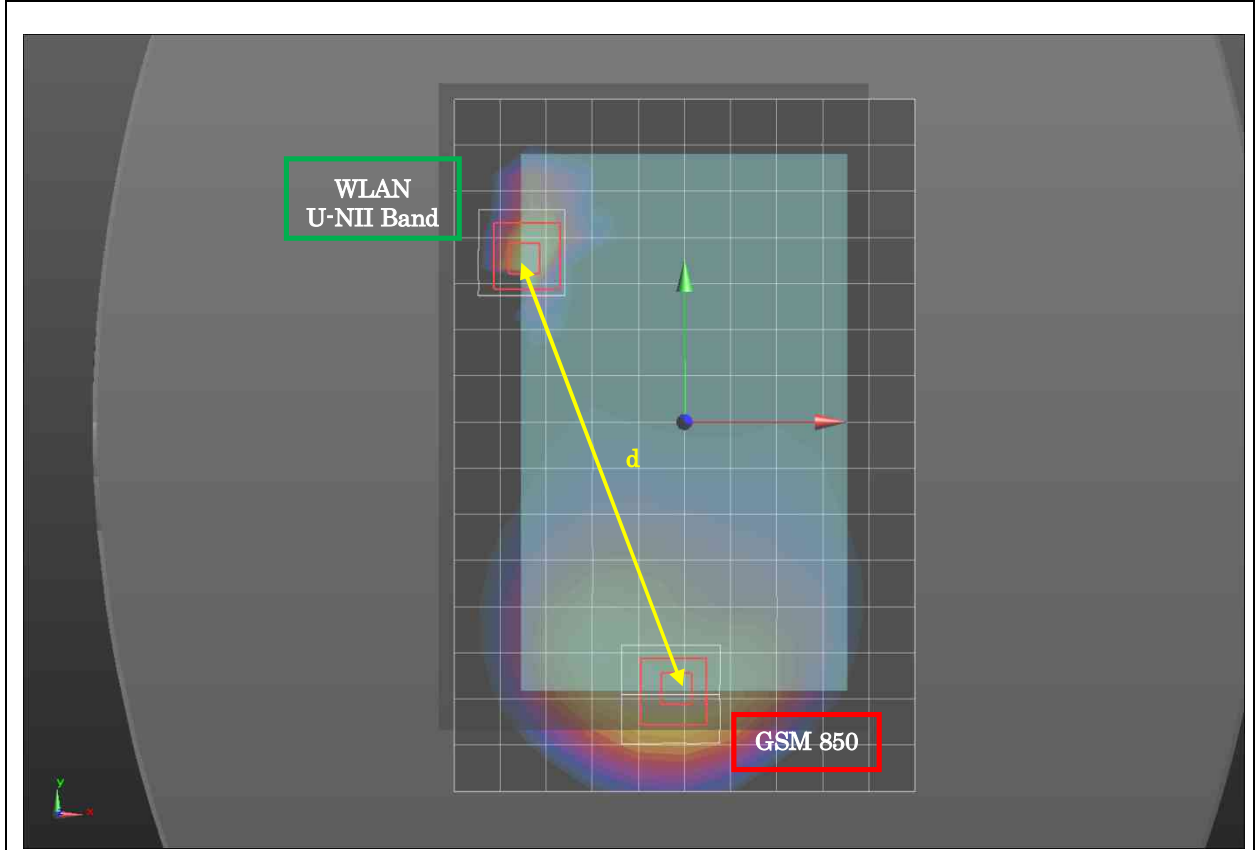

Band	x (m)	y (m)	z (m)
GSM 850	0.0067	-0.0837	-0.0003
WLAN U-NII Band	-0.0526	0.0522	0.0004

Calculated Distance : d (mm)	148.3
------------------------------	-------

Note(s):

The peak location separation distance is computed by the square root of $[(x_1-x_2)^2+(y_1-y_2)^2+(z_1-z_2)^2]$.

14.7.5 Sum of the SAR for PCS 1900 + WLAN & Bluetooth

14.7.5.1 Head

Test Position	Simultaneous Transmission Scenario				Σ 1 g SAR (W/kg)
	PCS 1900	WLAN DTS Band	WLAN U-NII Band	Bluetooth	
Left Touch	0.009	0.042			0.051
	0.009		0.000		0.009
	0.009			0.210	0.219
Left Tilt	0.004	0.031			0.035
	0.004		0.000		0.004
	0.004			0.210	0.214
Right Touch	0.005	0.015			0.020
	0.005		0.000		0.005
	0.005			0.210	0.215
Right Tilt	0.004	0.012			0.016
	0.004		0.000		0.004
	0.004			0.210	0.214

SAR to Peak Location Separation Ratio (SPLSR)

As the sum of the 1 g SAR is < 1.6 W/kg, SPLSR assessment is not required.

Conclusion:

Simultaneous transmission SAR measurement (Volume Scan) is not required because the sum of the 1 g SAR is < 1.6 W/kg.

14.7.5.2 Body-worn Accessory and Tablet mode

Test Position	Simultaneous Transmission Scenario				Σ 1 g SAR (W/kg)
	PCS 1900	WLAN DTS Band	WLAN U-NII Band	Bluetooth	
Rear	0.837	1.225			2.062
	0.837		1.466		2.303
	0.837			0.210	1.047
Front	0.116	0.014			0.130
	0.116		0.318		0.434
	0.116			0.105	0.221
Bottom Edge	1.226	0.400			1.626
	1.226		0.400		1.626
	1.226			0.400	1.626
Right Edge	0.013	0.480			0.493
	0.013		0.992		1.005
	0.013			0.210	0.223

SAR to Peak Location Separation Ratio (SPLSR)

Test Position	Worst-case combination				Σ 1 g SAR (W/kg)	Distance [mm]	SPLSR	Fig. No.
	PCS 1900	WLAN DTS	WLAN U-NII	Bluetooth				
Rear	0.837	1.225			2.062	152.0	0.020	1
	0.837		1.466		2.303	148.6	0.024	2
Bottom Edge	1.226	0.400			1.626	146.0	0.014	3
	1.226		0.400		1.626	146.0	0.014	
	1.226			0.400	1.626	146.0	0.014	

Conclusion:

Simultaneous transmission SAR measurement (Volume Scan) is not required because the either sum of the 1 g SAR is < 1.6 W/kg or the SPLSR is < 0.04 for all circumstances that require SPLSR calculation.

Figure 1

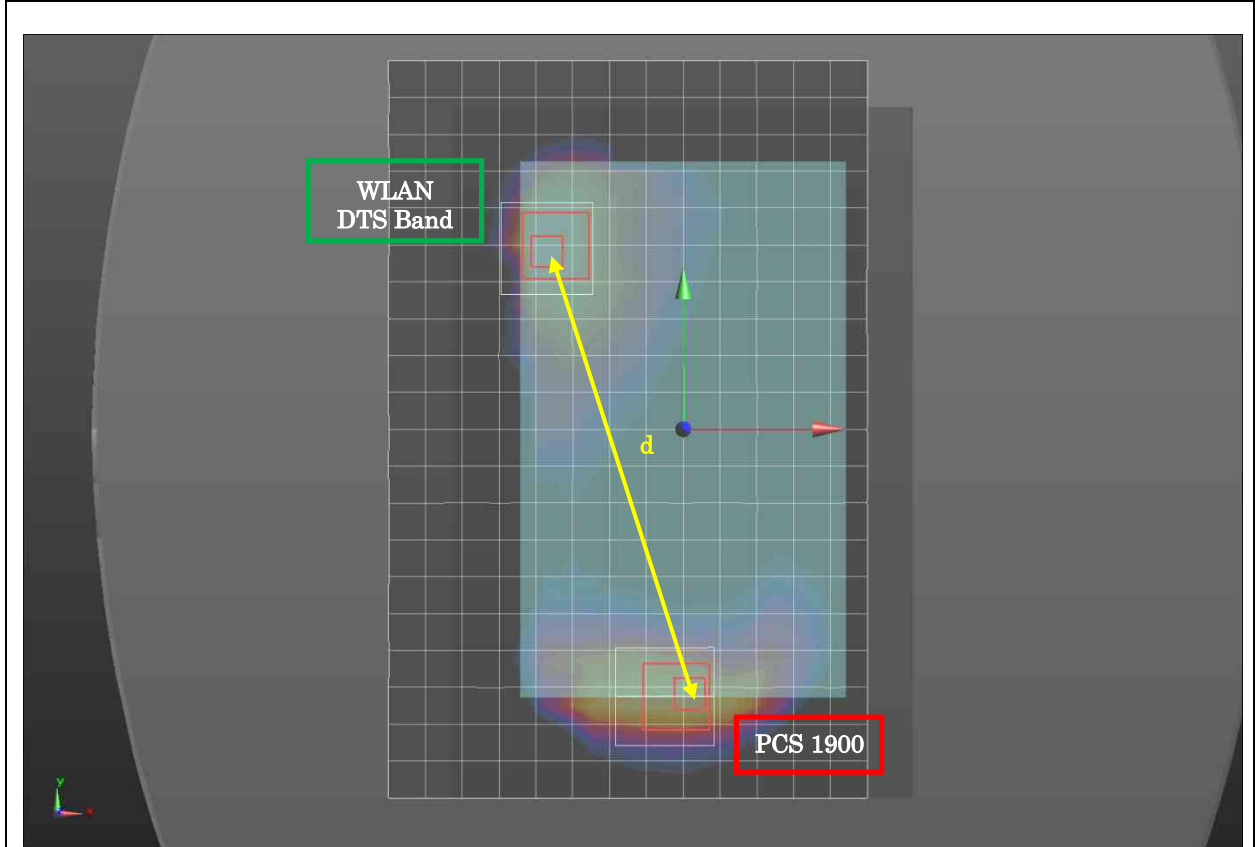

Band	x (m)	y (m)	z (m)
PCS 1900	0.0036	-0.0854	0.0010
WLAN DTS Band	-0.0444	0.0588	0.0002

Calculated Distance : d (mm)	152.0
------------------------------	-------

Note(s):

The peak location separation distance is computed by the square root of $[(x_1-x_2)^2+(y_1-y_2)^2+(z_1-z_2)^2]$.

Figure 2

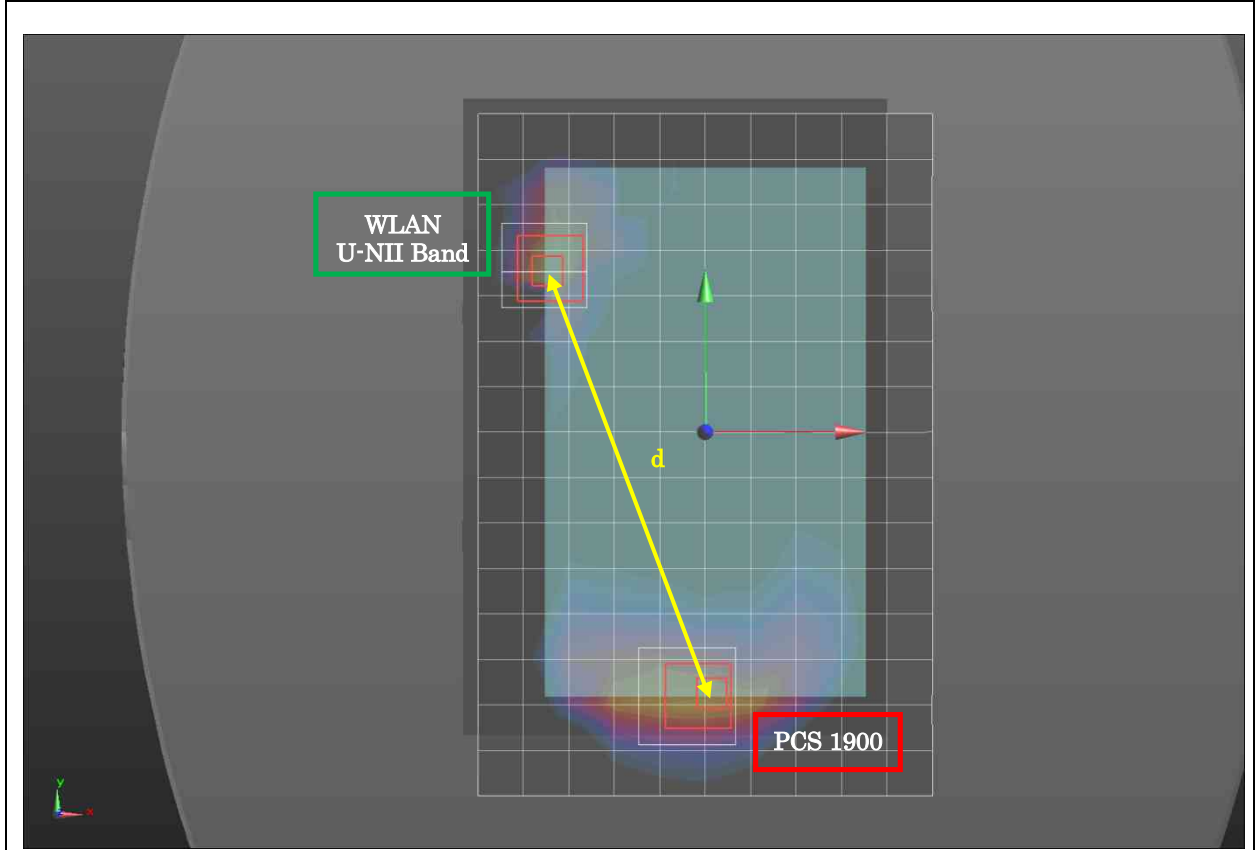

Band	x (m)	y (m)	z (m)
PCS 1900	0.0036	-0.0854	0.0010
WLAN U-NII Band	-0.0526	0.0522	0.0004

Calculated Distance : d (mm)	148.6
------------------------------	-------

Note(s):

The peak location separation distance is computed by the square root of $[(x_1-x_2)^2+(y_1-y_2)^2+(z_1-z_2)^2]$.

Figure 3

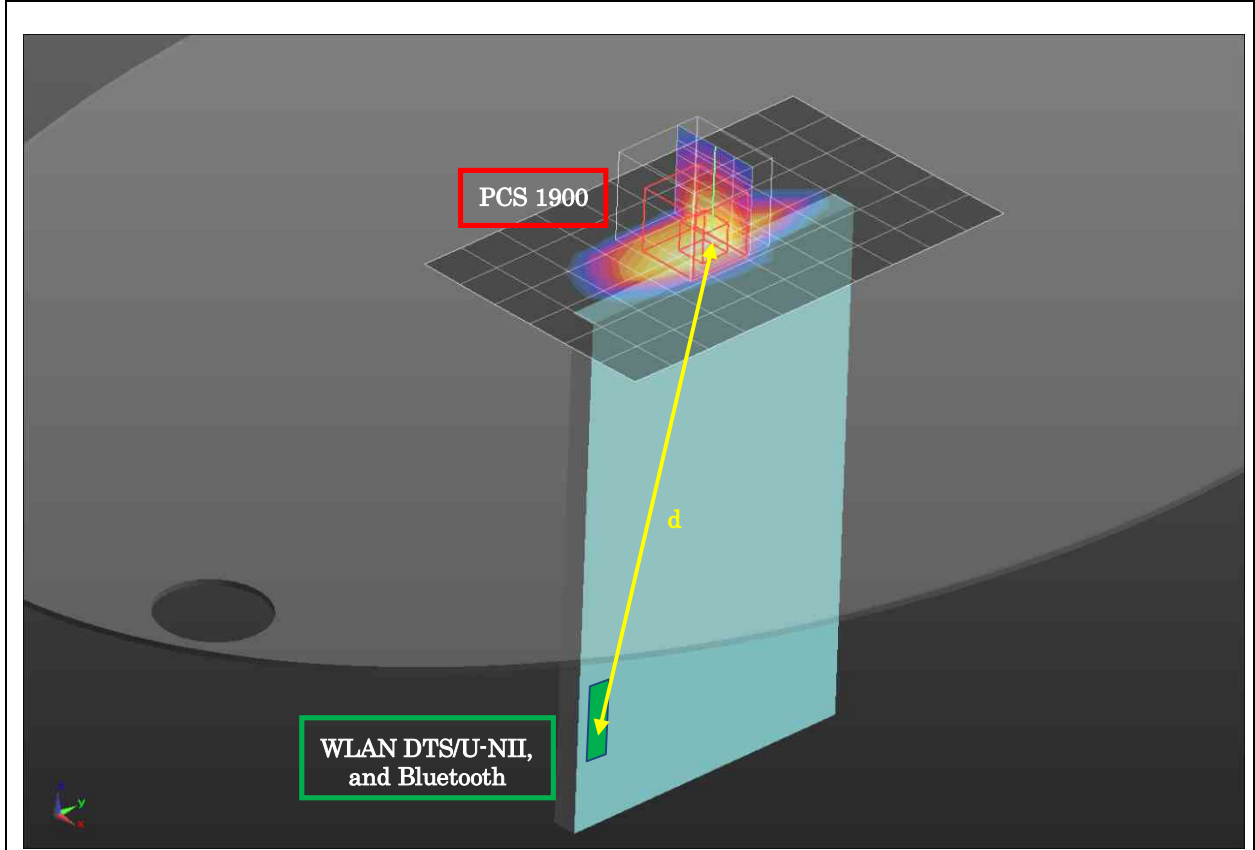

Band	x (m)	y (m)	z (m)
PCS 1900	-0.0030	0.0004	-0.0007
WLAN DTS/U-NII Band, and Bluetooth	-0.0021	-0.0485	-0.1383

Calculated Distance : d (mm)	146.0
------------------------------	-------

Note(s):

The peak location separation distance is computed by the square root of $[(x_1-x_2)^2+(y_1-y_2)^2+(z_1-z_2)^2]$. When SAR is estimated, the peak location is assumed to be at the feed-point or geometric center of the antenna.

14.7.6 Sum of the SAR for WCDMA Band V + WLAN & Bluetooth

14.7.6.1 Head

Test Position	Simultaneous Transmission Scenario				Σ 1 g SAR (W/kg)
	WCDMA Band V	WLAN DTS Band	WLAN U-NII Band	Bluetooth	
Left Touch	0.061	0.042			0.103
	0.061		0.000		0.061
	0.061			0.210	0.271
Left Tilt	0.026	0.031			0.057
	0.026		0.000		0.026
	0.026			0.210	0.236
Right Touch	0.036	0.015			0.051
	0.036		0.000		0.036
	0.036			0.210	0.246
Right Tilt	0.024	0.012			0.036
	0.024		0.000		0.024
	0.024			0.210	0.234

SAR to Peak Location Separation Ratio (SPLSR)

As the sum of the 1 g SAR is < 1.6 W/kg, SPLSR assessment is not required.

Conclusion:

Simultaneous transmission SAR measurement (Volume Scan) is not required because the sum of the 1 g SAR is < 1.6 W/kg.

14.7.6.2 Body-worn Accessory and Tablet mode

Test Position	Simultaneous Transmission Scenario				Σ 1 g SAR (W/kg)
	WCDMA Band V	WLAN DTS Band	WLAN U-NII Band	Bluetooth	
Rear	1.179	1.225			2.404
	1.179		1.466		2.645
	1.179			0.210	1.389
Front	0.259	0.014			0.273
	0.259		0.318		0.577
	0.259			0.105	0.364
Bottom Edge	0.718	0.400			1.118
	0.718		0.400		1.118
	0.718			0.400	1.118
Right Edge	0.096	0.480			0.576
	0.096		0.992		1.088
	0.096			0.210	0.306

SAR to Peak Location Separation Ratio (SPLSR)

Test Position	Worst-case combination				Σ 1 g SAR (W/kg)	Distance [mm]	SPLSR	Fig. No.
	WCDMA Band V	WLAN DTS	WLAN U-NII	Bluetooth				
Rear	1.179	1.225			2.404	150.0	0.025	1
	1.179		1.466		2.645	146.6	0.029	2

Conclusion:

Simultaneous transmission SAR measurement (Volume Scan) is not required because the either sum of the 1 g SAR is < 1.6 W/kg or the SPLSR is < 0.04 for all circumstances that require SPLSR calculation.

Figure 1



Band	x (m)	y (m)	z (m)
WCDMA Band V	0.0025	-0.0837	-0.0003
WLAN DTS Band	-0.0444	0.0588	0.0002

Calculated Distance : d (mm)	150.0
------------------------------	-------

Note(s):

The peak location separation distance is computed by the square root of $[(x_1-x_2)^2+(y_1-y_2)^2+(z_1-z_2)^2]$.

Figure 2

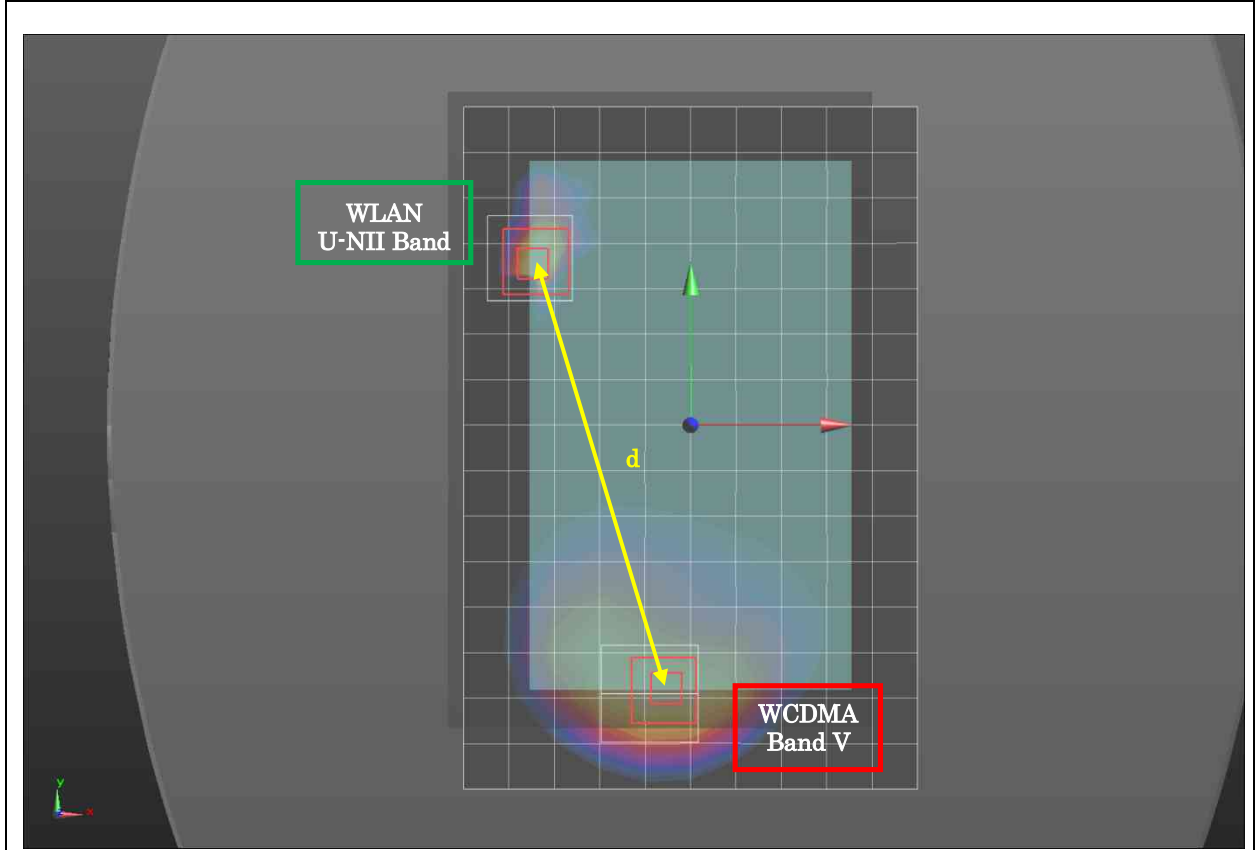

Band	x (m)	y (m)	z (m)
WCDMA Band V	0.0025	-0.0837	-0.0003
WLAN U-NII Band	-0.0526	0.0522	0.0004

Calculated Distance : d (mm)	146.6
------------------------------	-------

Note(s):

The peak location separation distance is computed by the square root of $[(x_1-x_2)^2+(y_1-y_2)^2+(z_1-z_2)^2]$.

16 Test Instruments

Shielded Room S3					
Type	Model	Manufacturer	ID No.	Last Cal.	Interval
E-Field Probe	ET3DV6	SPEAG	S-2	2013/8	1 Year
E-Field Probe	EX3DV4	SPEAG	S-17	2013/9	1 Year
DAE	DAE4	SPEAG	S-3	2013/11	1 Year
Robot	RX60L	Stäubli	S-7	-----	N/A
Probe Alignment Unit	LB5/80	SPEAG	S-13	-----	N/A
Network Analyzer	8719ET	Agilent	B-53	2013/9	1 Year
Dielectric Probe	DAK-3.5	SPEAG	S-32	2013/7	1 Year
835MHz Dipole	D835V2	SPEAG	S-23	2013/8	1 Year
1900MHz Dipole	D1900V2	SPEAG	S-25	2013/8	1 Year
2450MHz Dipole	D2450V2	SPEAG	S-6	2013/11	1 Year
5GHz Dipole	D5GHzV2	SPEAG	S-31	2013/9	1 Year
Signal Generator	MG3681A	Anritsu	B-3	2013/9	1 Year
Signal Generator	MG3710A	Anritsu	B-41	2013/9	1 Year
RF Power Amplifier	CGA020M602-2633R	R&K	A-51	-----	N/A
Directional Coupler	4226-20	Narda	D-87	-----	N/A
Radio Communication Analyzer	MT8820C	Anritsu	B-5	2014/2	1 Year
Power Meter	E4417A	Agilent	B-51	2013/11	1 Year
Power Sensor	E9323A	Agilent	B-59	2013/6	1 Year
Power Meter	N1911A	Agilent	B-63	2013/7	1 Year
Power Sensor	N1921A	Agilent	B-64	2013/7	1 Year
Attenuator	54A-10	Weinschel	D-28	2013/10	1 Year
Attenuator	2-20	Weinschel	D-36	2013/10	1 Year

17 Appendix

Refer to separated files for the following appendixes.

Appendix 1 – System Performance Check Plots

Appendix 2 – Highest SAR Test Plots

Appendix 3 – Dosimetric E-Field Probe Calibration Data

Appendix 4 – System Validation Dipole Calibration Data