

TEST REPORT

APPLICANT : Sharp Corporation, Communication Systems Group
ADDRESS : 2-13-1, Iida Hachihonmatsu, Higashi-Hiroshima City, Hiroshima,
739-0192, JAPAN

PRODUCTS : Cellular Phone

MODEL NO. : 006SH
SERIAL NO. : 004401/11/322122/6
FCC ID : APYHRO00143

TEST STANDARD : CFR 47 FCC Rules and Regulations Part 15

TESTING LOCATION : Japan Quality Assurance Organization
KITA-KANSAI Testing Center
1-7-7, Ishimaru, Minoh-shi, Osaka 562-0027, Japan

TEST RESULTS : **Passed**

DATE OF TEST : March 29, 2011 ~ April 7, 2011

This report must not be used by the client to claim product endorsement by NVLAP or NIST or any agency of the U.S. Government.



Kousei Shibata
Manager
Japan Quality Assurance Organization
KITA-KANSAI Testing Center
Testing Dept. SAITO EMC Branch
7-3-10, Saito-asagi, Ibaraki-shi, Osaka 567-0085, Japan

- The measurement values stated in Test Report was made with traceable to National Institute of Advanced Industrial Science and Technology (AIST) of Japan and National Institute of Information and Communications Technology (NICT) of Japan.
- The applicable standard, testing condition and testing method which were used for the tests are based on the request of the applicant.
- The test results presented in this report relate only to the offered test sample.
- The contents of this test report cannot be used for the purposes, such as advertisement for consumers.
- This test report shall not be reproduced except in full without the written approval of JQA.

TABLE OF CONTENTS**Page**

Documentation	3
1 Test Regulation.....	3
2 Test Location.....	3
3 Recognition of Test Laboratory.....	3
4 Description of the Equipment Under Test.....	4
5 Test Condition.....	5
6 Preliminary Test and Test Setup	7
7 Equipment Under Test Modification.....	12
8 Responsible Party.....	12
9 Deviation from Standard.....	12
10 Test Results.....	13
11 Summary.....	16
12 Operating Condition.....	17
13 Test Configuration.....	17
14 Equipment Under Test Arrangement (Drawings)	17
Appendix A: Test Data.....	18
Appendix B: Test Arrangement (Photographs).....	24
Appendix C: Test Instruments.....	26

DEFINITIONS FOR ABBREVIATION AND SYMBOLS USED IN THIS TEST REPORT

EUT : Equipment Under Test	EMC : Electromagnetic Compatibility
AE : Associated Equipment	EMI : Electromagnetic Interference
N/A : Not Applicable	EMS : Electromagnetic Susceptibility
N/T : Not Tested	

- indicates that the listed condition, standard or equipment is applicable for this report.

- indicates that the listed condition, standard or equipment is not applicable for this report.

Documentation**1 Test Regulation**

Applied Standard : CFR 47 FCC Rules and Regulations Part 15
Subpart C – Intentional Radiators

Test Requirements : §15.225, §15.207 and §15.209

Test Procedure : ANSI C63.4–2003

2 Test Location

Japan Quality Assurance Organization (JQA)
KITA-KANSAI Testing Center Testing Department SAITO EMC Branch
7-3-10, Saito-asagi, Ibaraki-shi, Osaka 567-0085, Japan
MINOH Test Site (KITA-KANSAI Testing Center) KITA-KANSAI Testing Center
7-7, Ishimaru, 1-chome, Minoh-shi, Osaka, 562-0027, Japan
KAMEOKA EMC Branch
9-1, Ozaki, Inukanno, Nishibetsuin-cho, Kameoka-shi, Kyoto 621-0126, Japan

3 Recognition of Test Laboratory

JQA KITA-KANSAI Testing Center Testing Dept. SAITO EMC Branch is accredited under ISO/IEC 17025 by following accreditation bodies and the test facility of Testing Division is registered by the following bodies.

VLAC Code : VLAC-001-2 (Effective through : March 30, 2012)
NVLAP Lab Code : 200191-0 (Effective through : June 30, 2011)
BSMI Recognition No. : SL2-IS-E-6006, SL2-IN-E-6006, SL2-AI-E-6006
(Effective through : September 14, 2013)

VCCI Registration No. : R-008, C-006, C-007, C-1674, C-2143, C-3685, T-1418, T-1419, T-1819, T-1820,
T-1821, G-172, G-173
(Effective through : March 30, 2012)

IC Registration No. : 2079E-1, 2079E-2 (Effective through : January 25, 2014)

Accredited as conformity assessment body for Japan electrical appliances and material law by METI.
(Effective through : February 22, 2012)

4 Description of the Equipment Under Test

4.1 General Information

1. Manufacturer : Sharp Corporation, Communication Systems Group
2-13-1, Iida Hachihonmatsu, Higashi-Hiroshima City, Hiroshima,
739-0192, JAPAN
2. Products : Cellular Phone
3. Model No. : 006SH
4. Serial No. : 004401/11/322122/6
5. Product Type : Pre-production
6. Date of Manufacture : March, 2011
7. Transmitting Frequency : 13.560 MHz
8. Receiving Frequency : 13.560 MHz
9. Power Rating : 4.0VDC (Lithium-ion Battery Pack SHBDT1 1240mAh)
10. EUT Grounding : None
11. EUT Authorization : Certification
12. Receive Date of EUT : March 25, 2011

5 Test Condition

5.1 AC Powerline Conducted Emission

The requirements are - Applicable - Tested. - Not tested by applicant request.]
 - Not Applicable

Test site : KITA-KANSAI - Shielded room - Anechoic chamber
KAMEOKA - Shielded room - Conducted emission facility
 - 1st open site

Test instruments : Refer to Appendix C.

5.2 Radiated Emission

5.2.1 Radiated Emission 9 kHz – 30 MHz

The requirements are - Applicable - Tested. - Not tested by applicant request.]
 - Not Applicable

Test site : - KAMEOKA 1st open site - 3 m - 10 m
 - KAMEOKA 2nd open site - 3 m - 10 m

Test instruments : Refer to Appendix C.

5.2.2 Radiated Emission 30 MHz – 1000 MHz

The requirements are - Applicable - Tested. - Not tested by applicant request.]
 - Not Applicable

Test site : - KAMEOKA 1st open site - 3 m - 10 m
 - KAMEOKA 2nd open site - 3 m - 10 m

Test instruments : Refer to Appendix C.

5.2.3 Radiated Emission above 1 GHz

The requirements are - Applicable - Tested. - Not tested by applicant request.]
 - Not Applicable

Test site : - KAMEOKA 1st open site - 3 m - 10 m
 - KAMEOKA 2nd open site - 3 m - 10 m

Test instruments : Refer to Appendix C.

5.3 Occupied Bandwidth

The requirements are - Applicable - Tested. - Not tested by applicant request.]
 - Not Applicable

Test site : KITA-KANSAI - Shielded room - 2nd Shielded room
KAMEOKA - Shielded room - Conducted emission facility

Test instruments : Refer to Appendix C.

5.4 Band-Edge Emission

The requirements are - Applicable - Tested. - Not tested by applicant request.]
 - Not Applicable

Test site : KITA-KANSAI - Shielded room - 2nd Shielded room
KAMEOKA - Shielded room - Conducted emission facility

Test instruments : Refer to Appendix C.

5.5 Frequency Stability

The requirements are - Applicable - Tested. - Not tested by applicant request.]
 - Not Applicable

Test site : KITA-KANSAI Environment Testing Room

Test instruments : Refer to Appendix C.

6 Preliminary Test and Test Setup

6.1 AC Powerline Conducted Emission

Not Applicable

6.2 Radiated Emission

6.2.1 Radiated Emission 9 kHz – 30 MHz

The preliminary tests were performed at the measurement distance that specified for compliance to determine the emission characteristics of the EUT.

The EUT configuration(in X, Y and Z axis), cable configuration and mode of operation were determined for producing the maximum level of emissions.

This configurations was used for the final tests.

– Side View –

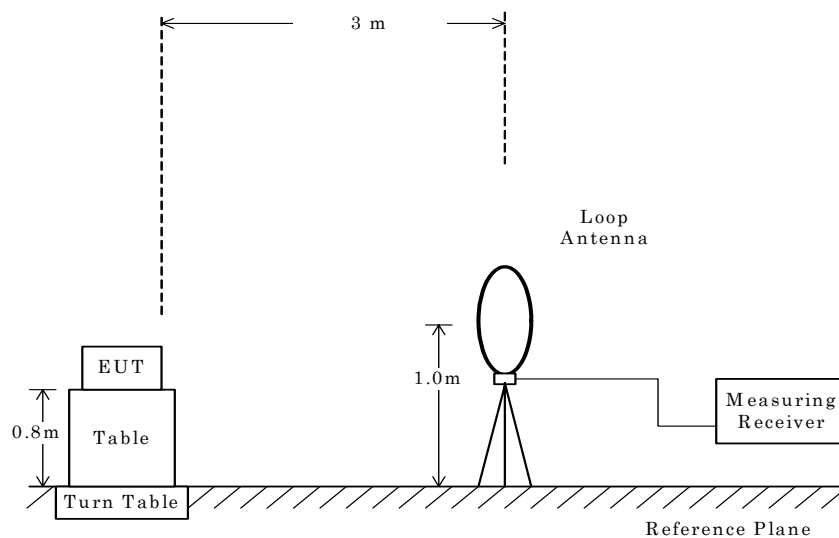

6.2.2 Radiated Emission 30 MHz – 1000 MHz

The preliminary tests were performed at the measurement distance that specified for compliance to determine the emission characteristics of the EUT.

The EUT configuration(in X, Y and Z axis), cable configuration and mode of operation were determined for producing the maximum level of emissions.

This configurations was used for the final tests.

– Side View –

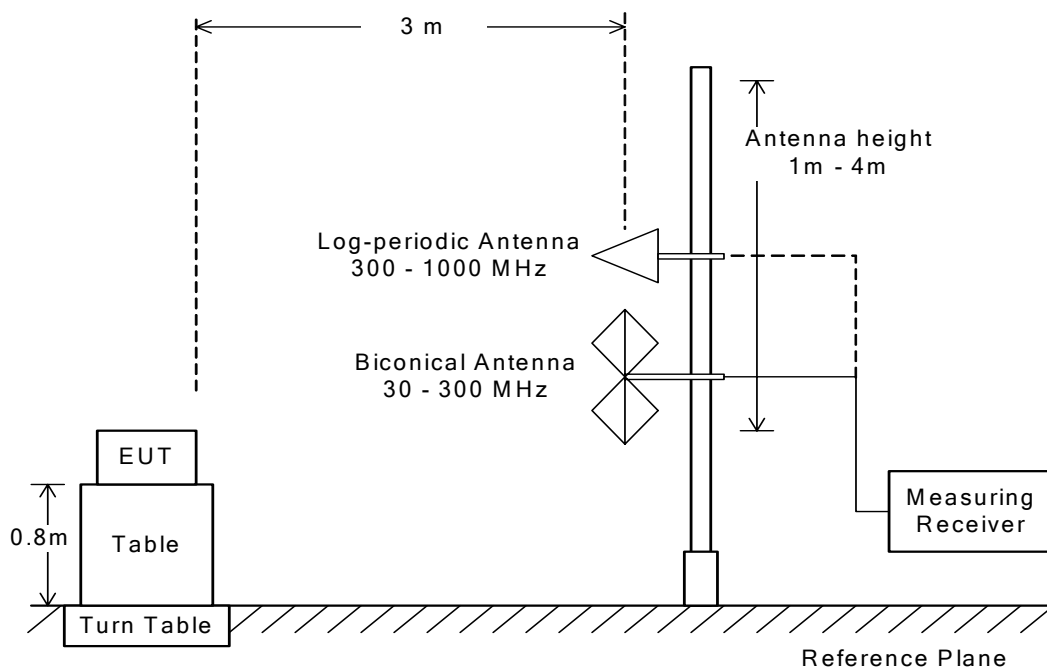

6.2.3 Radiated Emission above 1 GHz

Not Applicable

6.3 Occupied Bandwidth

The test system is shown as follows:

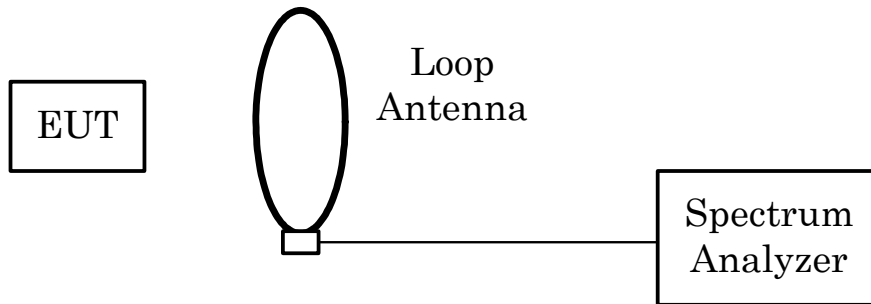

The setting of the spectrum analyzer are shown as follows:

Res. Bandwidth	1 kHz
Video Bandwidth	3 kHz
Span	30 kHz
Sweep Time	AUTO
Trace	Maxhold

6.4 Band-Edge Emission

The test system is shown as follows:

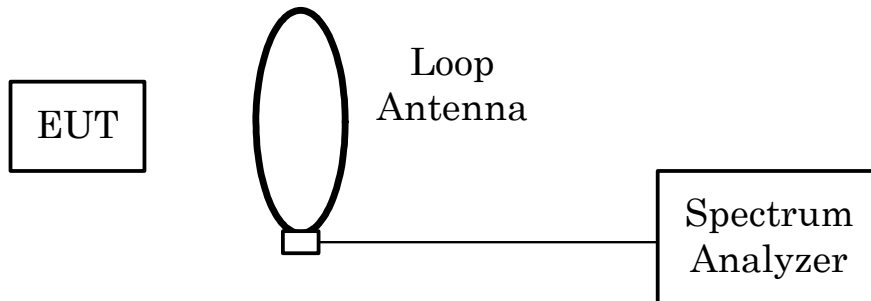

The setting of the spectrum analyzer are shown as follows:

TX Frequency	13.560 MHz
Band-Edge Frequency	13.110 MHz / 14.010 MHz
Res. Bandwidth	10 kHz
Video Bandwidth	10 kHz
Span	1 MHz
Sweep Time	AUTO
Trace	Maxhold

6.5 Frequency Stability

Frequency Stability versus Temperature

The EUT was placed in an environmental chamber and was tested in the range from -30 to $+50$ degrees Celsius. The EUT was stabilized at each temperature. The power (4.0VDC) supplied was applied to the transmitter and allowed to stabilize for 10 minutes. The transmitting frequency was measured at startup and 2 minutes, 5 minutes and 10 minutes after startup. This procedure was repeated from -20 , $+20$ and $+50$ degrees Celsius.

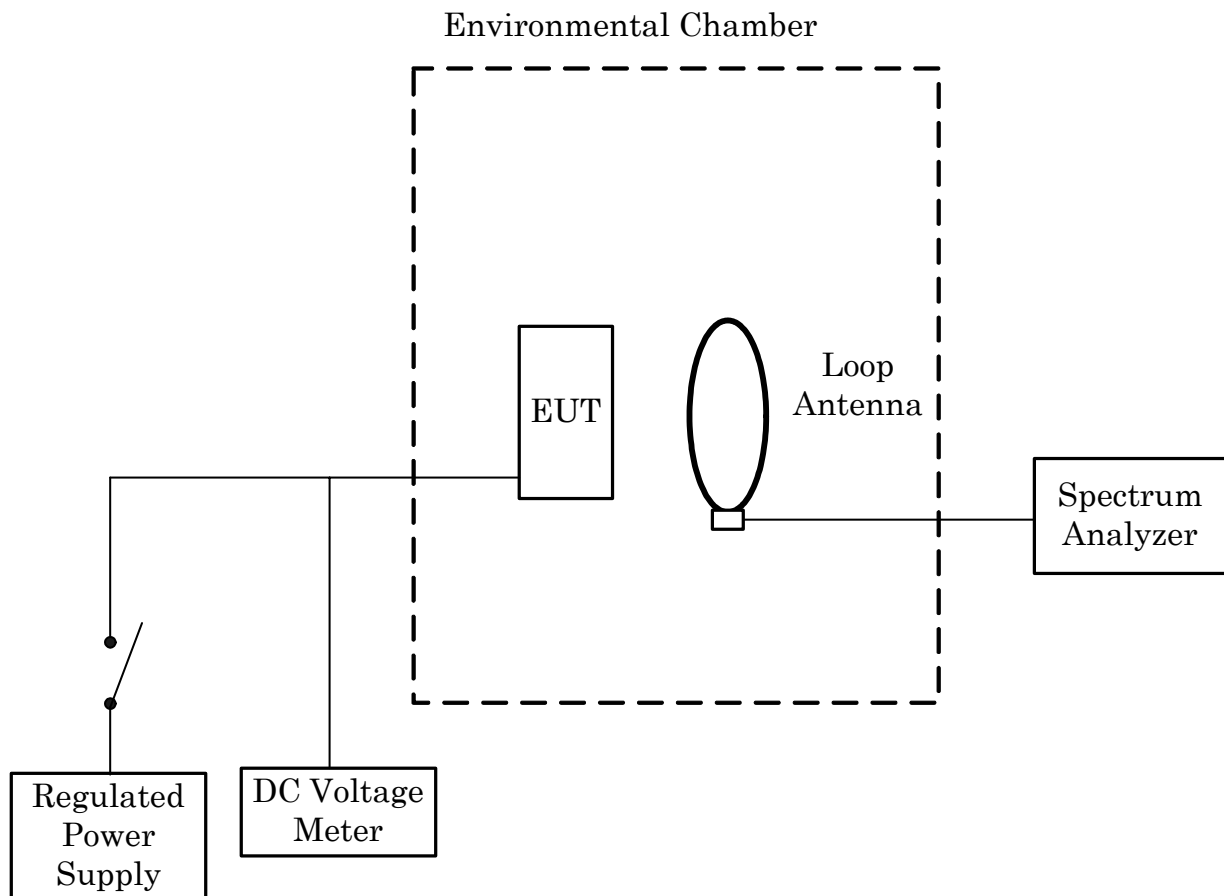

7 Equipment Under Test Modification

- No modifications were conducted by JQA to achieve compliance to the limitations.
 - To achieve compliance to the limitations, the following changes were made by JQA during the compliance test.

The modifications will be implemented in all production models of this equipment.

Applicant : Not Applicable

Date : Not Applicable

Typed Name : Not Applicable

Position : Not Applicable

Signatory : Not Applicable

8 Responsible PartyResponsible Party of Test Item (Product)

Responsible Party :

Contact Person :

Signatory

9 Deviation from Standard

- No deviations from the standard described in clause 1.
 - The following deviations were employed from the standard described in clause 1.
-

10 Test Results**10.1 AC Powerline Conducted Emission**

The requirements are - Applicable - Tested. - Not tested by applicant request.]
 - Not Applicable

- Passed - Failed - Not judged

Min. Limit Margin (Quasi-Peak) _____ dB at _____ MHz

Max. Limit Exceeding (Quasi-Peak) _____ dB at _____ MHz

Uncertainty of Measurement Results _____ dB(2 σ)

Remarks : When the cellular phone is connected to the AC Charger and Stereo Handsfree, the RF(13.56MHz) communicating function is not available.

10.2 Radiated Emission**10.2.1 Radiated Emission (§15.225(a)(b)(c))**

The requirements are - Applicable - Tested. - Not tested by applicant request.]
 - Not Applicable

- Passed - Failed - Not judged

Max. Limit Margin (Quasi-Peak) 72.5 dB at 13.560 MHz

Max. Limit Exceeding (Quasi-Peak) _____ dB at _____ MHz

Uncertainty of Measurement Results 9 kHz – 30 MHz +/-1.7 dB(2 σ)

Remarks : The Radited Emission at 30m of 13.560 MHz is 11.5dB(uV/m).

10.2.2 Radiated Emission (§15.225(d))

The requirements are - Applicable - Tested. - Not tested by applicant request.]
 - Not Applicable

- Passed - Failed - Not judged

Min. Limit Margin (Quasi-Peak) 7.6 dB at 461.0 MHz

Max. Limit Exceeding (Quasi-Peak) _____ dB at _____ MHz

Uncertainty of Measurement Results

9 kHz – 30 MHz	<u>+/-1.7</u>	dB(2 σ)
30 MHz – 300 MHz	<u>+/-4.3</u>	dB(2 σ)
300 MHz – 1000 MHz	<u>+/-4.5</u>	dB(2 σ)
above 1 GHz	_____	dB(2 σ)

Remarks : When the cellular phone is connected to the AC Charger and Stereo Handsfree, the RF(13.56MHz) communicating function is not available.

10.3 Occupied Bandwidth

The requirements are - Applicable - Tested. - Not tested by applicant request.]
 - Not Applicable

- Passed - Failed - Not judged

Uncertainty of Measurement Results +/-0.9 %(2 σ)

Remarks : _____

10.4 Band-Edge Emission

The requirements are - Applicable - Tested. - Not tested by applicant request.]
 - Not Applicable

- Passed - Failed - Not judged

Uncertainty of Measurement Results +/-1.0 dB(2 σ)

Remarks : _____

10.5 Frequency Stability

The requirements are - Applicable - Tested. - Not tested by applicant request.]
 - Not Applicable

The Frequency Stability level is + 0.002417 % at 13.560 MHz

Min. Limit Margin + 0.007583 % at 13.560 MHz

Max. Limit Exceeding _____ % at _____ MHz

Uncertainty of Measurement Results +/-1.6 ppm(2 σ)

Remarks : _____

11 Summary**General Remarks :**

The EUT was tested according to the requirements of the following standard.

CFR 47 FCC Rules and Regulations Part 15

The test configuration is shown in clause 12 to 14.

The conclusion for the test items of which are required by the applied regulation is indicated under the test results.

Determining compliance with the limits in this report was based on the results of the compliance measurement, not taking into account measurement instrumentation uncertainty.

Test Results :

The "as received" sample;

- fulfill the test requirements of the regulation mentioned on clause 1.
- doesn't fulfill the test requirements of the regulation mentioned on clause 1.

Reviewed by:

Tested by:



Shigeru Kinoshita
Deputy Manager
JQA KITA-KANSAI Testing Center
Testing Dept. SAITO EMC Branch

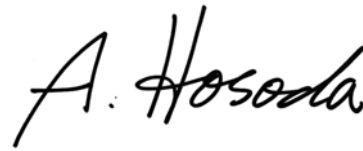

Akio Hosoda
Advisor
JQA KITA-KANSAI Testing Center
Testing Dept. SAITO EMC Branch

12 Operating Condition

The test were carried under one modulation type shown as follows:

Modulation : ASK

The Radiated Emission test were carried under one test configuration shown in clause 14.

In all tests, the fully charged battery is used for the EUT.

Detailed Transmitter portion:

Transmitter frequency : 13.560 MHz

Detailed Receiver portion:

Receiver frequency : 13.560 MHz

Other Clock Frequency

19.2MHz, 32.768kHz, 24.576MHz

13 Test Configuration

The equipment under test (EUT) consists of :

	Item	Manufacturer	Model No.	Serial No.	FCC ID
A	Cellular Phone	Sharp	006SH	004401/11/322122/ 6	APYHRO00143
B	Lithium-ion Battery	Sharp	Battery Pack SHBDT1	--	N/A

The auxiliary equipment used for testing :

None

Type of Cable:

None

14 Equipment Under Test Arrangement (Drawings)

a) Single Unit

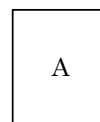

Appendix A: Test Data

A.1 AC Powerline Conducted Emission

Not Applicable

A.2 Radiated Emission

A.2.1 Radiated Emission (§15.225(a)(b)(c) & §15.209(a))

Test condition : Transmitting Test Date: April 3, 2011
Temp.: 16 °C, Humi: 34 %

Frequency [MHz]	Correction Factor [dB(1/m)]	Meter Readings at 3 m [dB(μV)]	Limits [dB(μV/m)]	Specified Distance [m]	Extrapolated Results [dB(μV/m)]	Margin [dB]	Remarks
13.560	0.2	51.3	84.0	30.0	11.5	+72.5	-
27.12	2.3	< 30.0	29.5	30.0	< - 7.7	> +37.2	-

NOTES

1. Test Distance : 3 m
2. The correction factor includes the antenna factor and the cable loss.
3. The symbol of “<” means “or less”.
4. The symbol of “>” means “more than”.
5. The testing loop antenna was rotated at the vertical and horizontal axis to maximize received emissions.
The above Meter Reading was maximum emission level.
6. Calculation:

For fundamental, the measured field strength was extrapolated to distance 30m, using the formula that field strength using the formula that field strength aries as the inverse distance square(40 dB per decade of distance).

Fundamental : Correction Factor + Meter Reading = 0.2 + 51.3 = 51.5 dB(μV/m)

Result at 30 m = -40 + 51.5 = 11.5 dB(μV/m) (Conversion Factor : 40dB/decade)

Limits for fundamental(§15.225(a)) = 20log10(15848) = 84.0 dBμV/m

Harmonic : Correction Factor + Meter Reading = 2.3 + <30.0 = <32.3 dB(μV/m)

Result at 30 m = -40 + <32.3 = <-7.7 dB(μV/m) (Conversion Factor : 40dB/decade)

Limits for fundamental(§15.209(a)) = 20log10(30) = 29.5 dBμV/m

8. Test receiver setting(s) :

Quasi-Peak Detector IF Bandwidth: 9kHz or 200Hz(9 kHz -90 kHz, 110 kHz -490 kHz)

Average Detector, IF Bandwidth: 9kHz or 200Hz(Except for 9 kHz -90 kHz, 110 kHz -490 kHz)

A.2.2.1 Radiated Emission (§15.209(a))(9kHz – 30MHz)

Test condition : Transmitting

Test Date: April 3, 2011
Temp.: 16 °C, Humi: 34 %

Frequency [MHz]	Correction Factor [dB(1/m)]	Meter Readings at 3 m [dB(μV)]	Limits [dB(μV/m)]	Specified Distance [m]	Extrapolated Results [dB(μV/m)]	Margin [dB]	Remarks
0.009	-0.1	< 35.0	48.5	300.0	< -45.1	> +93.6	-
0.01	-0.1	< 35.0	47.6	300.0	< -45.1	> +92.7	-
0.05	-0.4	< 35.0	33.6	300.0	< -45.4	> +79.0	-
0.10	-0.3	< 35.0	27.6	300.0	< -45.3	> +72.9	-
0.50	-0.4	< 30.0	33.6	30.0	< -10.4	> +44.0	-
1.00	-0.2	< 30.0	27.6	30.0	< -10.2	> +37.8	-
5.00	-0.1	< 30.0	29.5	30.0	< -10.1	> +39.6	-
10.00	0.0	< 30.0	29.5	30.0	< -10.0	> +39.5	-
20.00	1.1	< 30.0	29.5	30.0	< - 8.9	> +38.4	-
30.00	2.5	< 30.0	29.5	30.0	< - 7.5	> +37.0	-

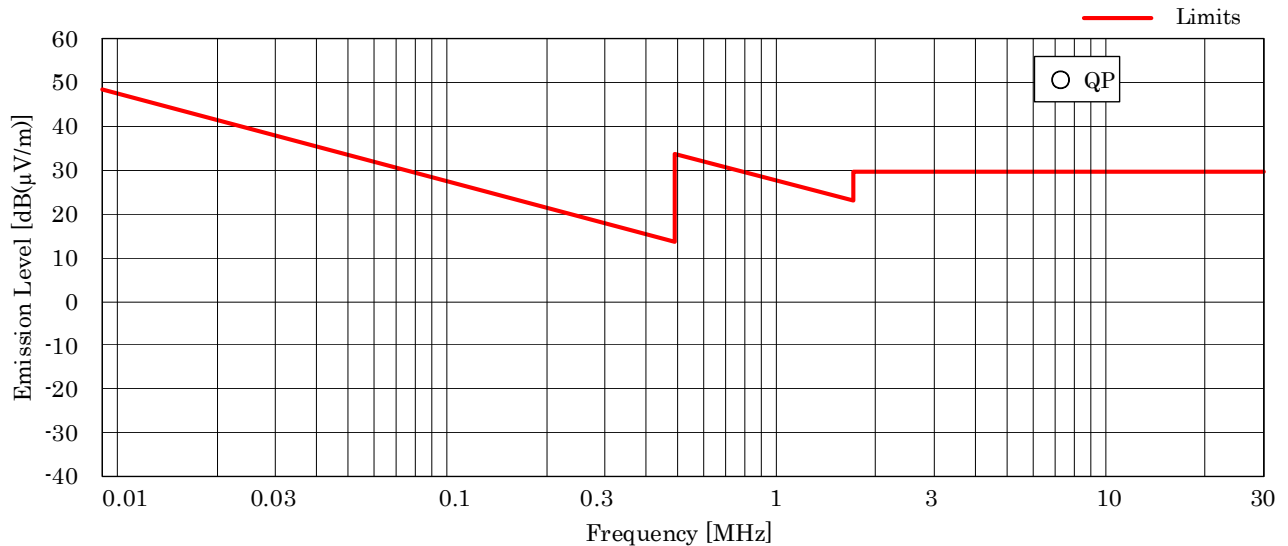

NOTES

1. Test Distance : 3 m
2. The spectrum was checked from 9 kHz to 30 MHz.
3. The correction factor includes the antenna factor and the cable loss.
4. The symbol of “<” means “or less”.
5. The symbol of “>” means “more than”.
6. Calculated result at 30.00 MHz, as the worst point shown on underline:
Correction Factor + Meter Reading = 2.5 + <30.0 = <32.5 dB(μV/m)
Result at 30 m = -40.0 + <32.5 = <-7.5 dB(μV/m) (Conversion Factor : 40dB/decade)
7. Test receiver setting(s) :
Quasi-Peak Detector, IF Bandwidth: 9kHz or 200Hz(9 kHz -90 kHz, 110 kHz -490 kHz)
Average Detector, IF Bandwidth: 9kHz or 200Hz(Except for 9 kHz -90 kHz, 110 kHz -490 kHz)

A.2.2.2 Radiated Emission (§15.209(a))(30MHz – 1000MHz)

Test Date: April 3, 2011
Temp.: 16 °C, Humi: 34 %

Frequency [MHz]	Antenna Factor [dB(1/m)]	Cable Loss [dB]	Meter Readings [dB(μV)]		Limits [dB(μV/m)]	Results [dB(μV/m)]		Margin [dB]	Remarks
			Hori.	Vert.		Hori.	Vert.		
54.2	9.7	1.3	6.2	9.6	40.0	17.2	20.6	+19.4	-
406.8	16.5	4.1	7.4	4.3	46.0	28.0	24.9	+18.0	-
433.9	16.5	4.3	12.8	10.5	46.0	33.6	31.3	+12.4	-
447.5	16.8	4.4	10.8	9.4	46.0	32.0	30.6	+14.0	-
<u>461.0</u>	<u>17.1</u>	<u>4.5</u>	<u>16.8</u>	<u>14.8</u>	<u>46.0</u>	<u>38.4</u>	<u>36.4</u>	<u>+ 7.6</u>	-
474.6	17.3	4.6	7.3	5.9	46.0	29.2	27.8	+16.8	-
488.2	17.4	4.7	5.4	3.6	46.0	27.5	25.7	+18.5	-
637.3	19.5	5.3	1.9	0.5	46.0	26.7	25.3	+19.3	-
664.4	19.8	5.4	8.9	6.3	46.0	34.1	31.5	+11.9	-
678.0	20.0	5.5	4.2	2.7	46.0	29.7	28.2	+16.3	-
691.6	20.2	5.6	5.0	3.2	46.0	30.8	29.0	+15.2	-
705.1	20.3	5.6	2.2	0.9	46.0	28.1	26.8	+17.9	-
786.5	20.6	6.0	1.7	< 0.0	46.0	28.3	< 26.6	+17.7	-
813.6	21.2	6.1	1.7	0.6	46.0	29.0	27.9	+17.0	-
840.7	21.6	6.2	0.3	< 0.0	46.0	28.1	< 27.8	+17.9	-

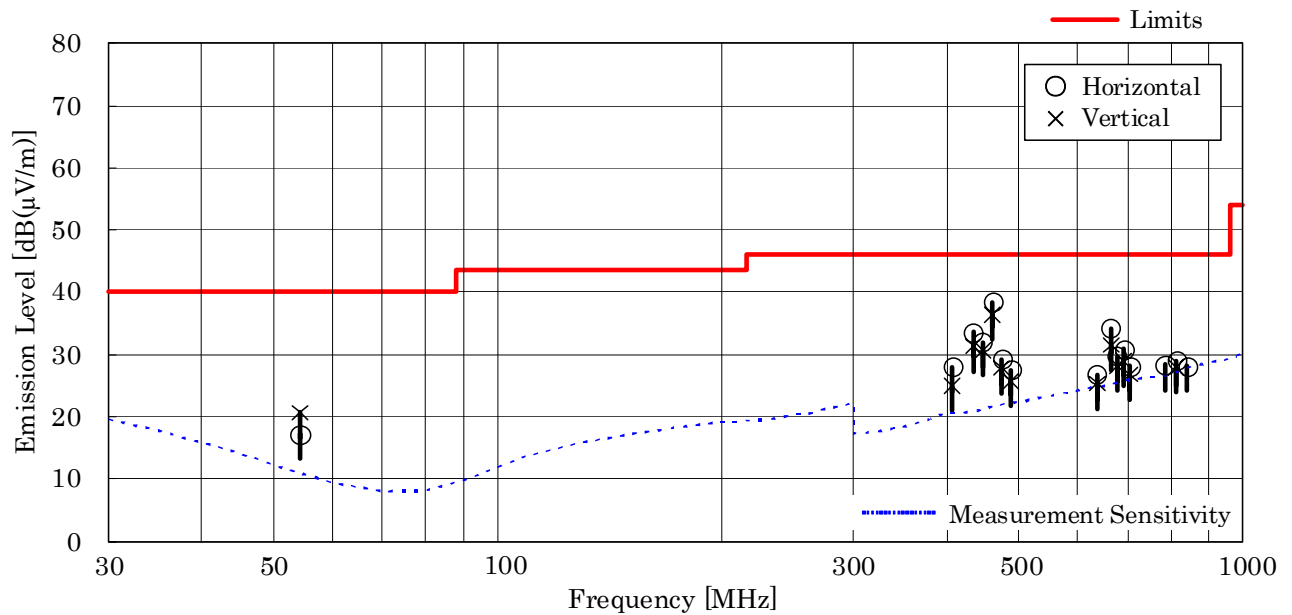

NOTES

1. Test Distance : 3 m
2. The spectrum was checked from 30 MHz to 1000 MHz.
3. The symbol of "<" means "or less".
4. The symbol of ">" means "more than".
5. Calculated result at 461.0 MHz, as the worst point shown on underline:
 Antenna Factor + Cable Loss + Meter Reading = 17.1 + 4.5 + 16.8 = 38.4 dB(μV/m)
6. Test receiver setting(s) : CISPR QP 120 kHz (QP : Quasi-Peak)

A.3 Occupied Bandwidth

Test Date : March 29, 2011

Temp.:19°C, Humi:34%

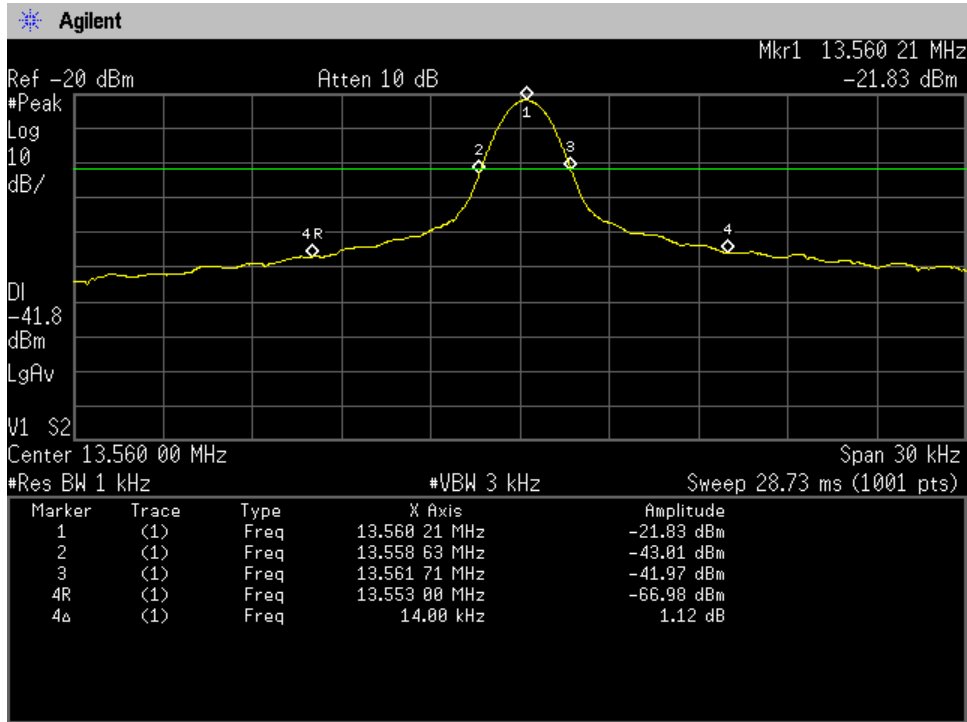

A.4 Band-Edge Emission

Test Date : March 29, 2011

Temp.:19°C, Humi:34%

Band-Edge Emission

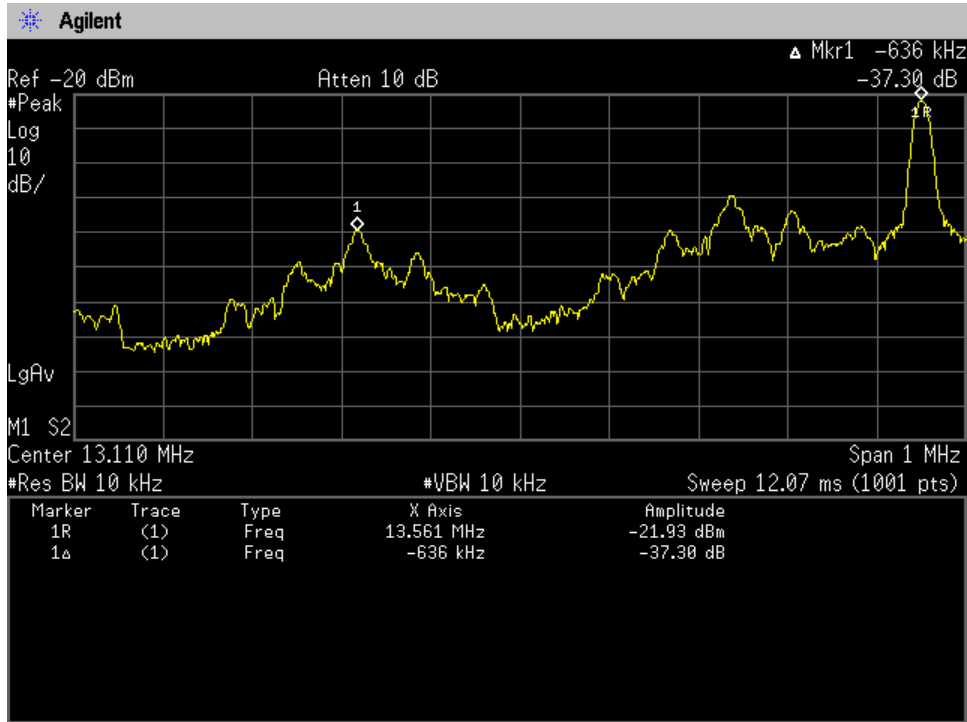

Band-Edge Emission

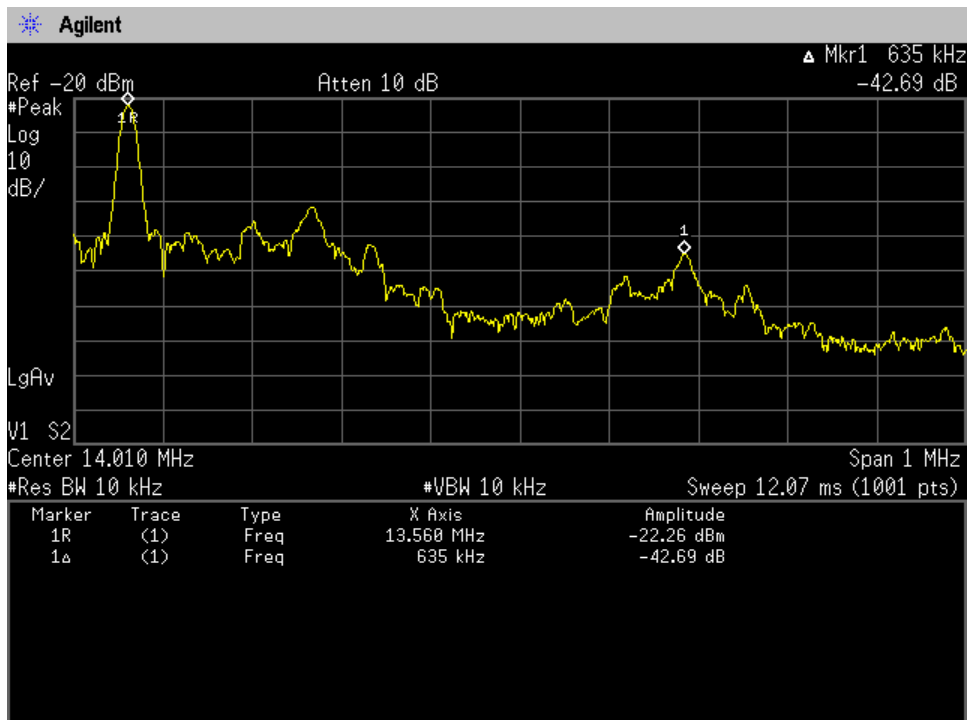

A.5 Frequency Stability

Test Date: April 7, 2011

Transmitting Frequency : 13.560 MHz
 DC Supply Voltage : 4.0 VDC

Ambient Temperature [°C]	Startup	Frequency with time elapse[MHz]			Limits [%]	Margin [%]
		2 minutes	5 minutes	10 minutes		
-20	13.560328	13.560324	13.560318	13.560311		
20	13.560260	13.560251	13.560250	13.560249		
50	13.560098	13.560070	13.560055	13.560043		

Ambient Temperature [°C]	Startup	Diviation with time elapse[%]			Limits [%]	Margin [%]
		2 minutes	5 minutes	10 minutes		
-20	+ 0.002417	+ 0.002390	+ 0.002348	+ 0.002297	0.01	+ 0.007583
20	+ 0.001919	+ 0.001847	+ 0.001843	+ 0.001837	0.01	+ 0.008081
50	+ 0.000724	+ 0.000519	+ 0.000406	+ 0.000317	0.01	+ 0.009276

Sample of calculated result at 13.560 MHz, as the Minimum Margin point:
 Ambient Temperature : -20 °C / Startup
 DC Supply Voltage : 4.0V
 Minimum Margin: 0.010000 - 0.002417 = 0.007583 (%)
 The point shown on “ **_____** ” is the Minimum Margin Point. The Maximum Deviation Point is shown on a thick letter.

Note: The measurement were made after all of components of the oscillator sufficiently stabilized at each temperature.

Appendix B: Test Arrangement (Photographs)**B.1 AC Powerline Conducted Emission**

Not Applicable

B.2 Radiated Emission

This page is CONFIDENTIAL.

This page is CONFIDENTIAL.

Appendix C: Test Instruments

C.1 AC Powerline Conducted Emission

Not Applicable

C.2 Radiated Emission

C.2.1 Radiated Emission 9 kHz – 30 MHz

Type	Model	Manufacturer	ID No.	Last Cal.	Interval
Test Receiver	ESCS 30	Rohde & Schwarz	A-1	2011/2	1 Year
Loop Antenna	HFH2-Z2	Rohde & Schwarz	C-3	2010/8	1 Year
RF Cable	RG213/U	Rohde & Schwarz	H-29	2010/8	1 Year

C.2.2 Radiated Emission 30MHz – 1000 MHz

Type	Model	Manufacturer	ID No.	Last Cal.	Interval
Test Receiver	ESCS 30	Rohde & Schwarz	A-1	2011/2	1 Year
Biconical Antenna	VHA9103/BBA9106	Schwarzbeck	C-30	2010/5	1 Year
Log-periodic Antenna	UHALP9108-A1	Schwarzbeck	C-31	2010/5	1 Year
RF Cable	--	----	H-1	2010/5	1 Year
Site Attenuation	--	----	H-11	2010/11	1 Year

C.3 Modulation Characteristics

Not Applicable

C.3 Occupied Bandwidth

Type	Model	Manufacturer	ID No.	Last Cal.	Interval
Spectrum Analyzer	E4446A	Agilent	A-39	2010/9	1 Year
Loop Antenna	LU-100A	TEXIO	C-33	N/A	N/A

C.4 Band-Edge Emission

Type	Model	Manufacturer	ID No.	Last Cal.	Interval
Spectrum Analyzer	E4446A	Agilent	A-39	2010/9	1 Year
Loop Antenna	LU-100A	TEXIO	C-33	N/A	N/A

C.5 Frequency Stability

Type	Model	Manufacturer	ID No.	Last Cal.	Interval
Spectrum Analyzer	FSL3	Rohde & Schwarz	A-40	2011/2	1 Year
Loop Antenna	LU-100A	TEXIO	C-33	N/A	N/A
DC Voltage Meter	2011-39	YEW	B-33	2010/4	1 Year
Environmental Chamber	PL-4KPH (S/N:14007470)	TABAI ESPEC	--	N/A	N/A
Temperature Recorder	SRF106AS00000M11 (S/N:01400909)	TABAI ESPEC	--	2010/8	1 Year