

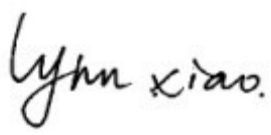



## TEST REPORT

<b>Report No.:</b>	EM201300221-5	<b>Application No.:</b>	ZJ00028648
<b>Client:</b>	Harman International Industries, Incorporated		
<b>Address:</b>	8500 Balboa Blvd, Northridge, CA 91329, UNITED STATES		
<b>Sample Description:</b>	Wireless stereo speaker		
<b>Model:</b>	JBL SPARK		
<b>Adding Model:</b>	/		
<b>FCC ID</b>	APISPARK		
<b>Test Specification:</b>	FCC Part 15,Subpart C:2013		
<b>Test Date:</b>	2013-04-23 to 2013-05-10		
<b>Issue Date:</b>	2013-05-13		
<b>Test Result:</b>	Pass.		
<b>Prepared By:</b>	<b>Reviewed By:</b>	<b>Approved By:</b>	
Lynn Xiao / Test Engineer	Jane Cao / Test Engineer	Gavin Wu / Manager	
			
Date:2013-05-13	Date:2013-05-13	Date:2013-05-13	
<b>Other Aspects:</b>			
/			
<b>Abbreviations:</b> ok / P = passed; fail / F = failed; n.a. / N = not applicable			
The test result in this test report refers exclusively to the presented test sample. This report shall not be reproduced except in full, without the written approval of GRGT.			

## **DIRECTIONS OF TEST**

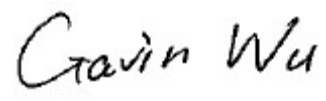
1. This station carries out test task according to the national regulation of verifications which can be traced to National Primary Standards and BIPM.
2. The test report merely corresponds to the test sample. It is not permitted to copy extracts of these test result without the written permission of the test laboratory.
3. If there is any objection concerning the test, the client should inform the laboratory within 15 days from the date of receiving the test report.

## Table of Contents

- 1. TEST RESULT SUMMARY ..... 5**
- 2. GENERAL DESCRIPTION OF EUT..... 6**
  - 2.1 APPLICANT ..... 6
  - 2.2 MANUFACTURER ..... 6
  - 2.3 BASIC DESCRIPTION OF EQUIPMENT UNDER TEST ..... 6
- 3. LABORATORY AND ACCREDITATIONS..... 7**
  - 3.1 LABORATORY ..... 7
  - 3.2 ACCREDITATIONS ..... 7
  - 3.3 MEASUREMENT UNCERTAINTY ..... 7
  - 3.4 LIST OF USED TEST EQUIPMENT AT GRGT ..... 8
- 4. TEST RESULTS ..... 9**
  - 4.1 E.U.T. TEST CONDITIONS ..... 9
  - 4.2 ANTENNA REQUIREMENT ..... 11
  - 4.3 OCCUPIED BANDWIDTH ..... 11
    - 4.3.1 LIMITS..... 11
    - 4.3.2 TEST PROCEDURES..... 11
    - 4.3.3 TEST SETUP ..... 11
    - 4.3.4 TEST RESULTS ..... 11
  - 4.4 CARRIER FREQUENCIES SEPARATED ..... 16
    - 4.4.1 LIMITS..... 16
    - 4.4.2 TEST PROCEDURES..... 16
    - 4.4.3 TEST SETUP ..... 16
    - 4.4.4 TEST RESULTS ..... 16
  - 4.5 HOPPING CHANNEL NUMBER ..... 20
    - 4.5.1 LIMITS..... 20
    - 4.5.2 TEST PROCEDURES..... 20
    - 4.5.3 TEST SETUP ..... 20
    - 4.5.4 TEST RESULTS ..... 20
  - 4.6 DWELL TIME..... 22
    - 4.6.1 LIMITS..... 22
    - 4.6.2 TEST PROCEDURES..... 22
    - 4.6.3 TEST SETUP ..... 22
    - 4.6.4 TEST RESULTS ..... 22
  - 4.7 CONDUCTED EMISSION MEASUREMENT ..... 39
    - 4.7.1 LIMITS..... 39
    - 4.7.2 TEST PROCEDURES..... 39
    - 4.7.3 TEST SETUP ..... 40
    - 4.7.4 TEST RESULTS ..... 41
  - 4.8 MAXIMUM PEAK OUTPUT POWER ..... 43
    - 4.8.1 LIMITS..... 43
    - 4.8.2 TEST PROCEDURES..... 43
    - 4.8.3 TEST SETUP ..... 43
    - 4.8.4 TEST RESULTS ..... 43
- FUNDAMENTAL FREQUENCY (GHZ) ..... 43**
  - 4.9 CONDUCTED SPURIOUS EMISSIONS..... 47
    - 4.9.1 LIMITS..... 47
    - 4.9.2 TEST PROCEDURES..... 47
    - 4.9.3 TEST SETUP ..... 47
    - 4.9.4 TEST RESULTS ..... 47
  - 4.10 RADIATED SPURIOUS EMISSIONS ..... 57
    - 4.10.1 LIMITS..... 57
    - 4.10.2 TEST PROCEDURES..... 57
    - 4.10.3 TEST SETUP ..... 58
    - 4.10.4 TEST RESULTS ..... 60
  - 4.11 BAND EDGES REQUIREMENT ..... 64

*4.11.1 LIMITS*..... 64  
*4.11.2 TEST PROCEDURES*..... 64  
*4.11.3 TEST SETUP* ..... 64  
*4.11.4 TEST RESULTS*..... 64  
*4.11.5 Radiated Emissions which fall in the restricted bands*..... 67

**1. TEST RESULT SUMMARY**

<b>Section B of FCC Part 15.247:2013</b>			
<b>Standard</b>	<b>Item</b>	<b>Limit / Severity</b>	<b>Result</b>
FCC Part 15,Subpart C (15.247)	Antenna Requirement	Section 15.247 (c)	PASS
	Occupied Bandwidth	Section 15.247 (a1)	PASS
	Carrier Frequencies Separated	Section 15.247(a)(1)	PASS
	Hopping Channel Number	Section 15.247(a)(1)(iii)	PASS
	Dwell Time	Section 15.247(a)(1)(iii)	PASS
	Maximum Peak Output Power	Section 15.247(b)(1)	PASS
	Conducted Emission	Section 15.207	PASS
	Conducted Spurious Emission (30MHz to 25GHz)	Section 15.209 &15.247(d)	PASS
	Radiated Spurious Emission (30MHz to 25GHz)	Section 15.209 &15.247(d)	PASS
	Band Edges Measurement	Section 15.247 (d) &15.205	PASS

## 2. GENERAL DESCRIPTION OF EUT

### 2.1 APPLICANT

Name: Harman International Industries, Incorporated  
Address: 8500 Balboa Blvd, Northridge, CA 91329, UNITED STATES

### 2.2 MANUFACTURER

Name: Harman International Industries, Incorporated  
Address: 8500 Balboa Blvd, Northridge, CA 91329, UNITED STATES

### 2.3 BASIC DESCRIPTION OF EQUIPMENT UNDER TEST

Equipment: Wireless stereo speaker  
Model No.: JBL SPARK  
Trade Name: JBL  
Power supply  
Model : F13V-1.7C-DC  
AC Adapter : Input : AC 100-240V,50/60Hz,0.8A MAX  
Output : DC 13V 1.7A  
Frequency Range 2402MHz~2480MHz  
Type of Modulation GFSK, 8DPSK, Pi/4 QPSK  
Channels: Channels with 1MHz step  
Antenna Type Integral

### 3. LABORATORY AND ACCREDITATIONS

#### 3.1 LABORATORY

The tests and measurements refer to this report were performed by Guangzhou GRG Metrology and Test CO., LTD.

Add. : 163 Pingyun Rd, West of Huangpu Ave, Guangzhou, 510656, P. R. China

Telephone: +86-20-38699959, 38699960, 38699961

Fax : +86-20-38695185

#### 3.2 ACCREDITATIONS

Our laboratories are accredited and approved by the following approval agencies according to ISO/IEC 17025.

<b>USA</b>	FCC Listed Lab (No. 688188)
<b>China</b>	CNAS ( No.L0446 )
<b>China</b>	DILAC (No.DL175)
<b>Canada</b>	Registration No.:8355A-1

#### 3.3 MEASUREMENT UNCERTAINTY

Where relevant, the following measurement uncertainty levels have been estimated for tests performed on the EUT as specified in CISPR 16-4-2:

Measurement		Frequency	Uncertainty
Radiated Emission	Horizontal	30MHz ~ 1000MHz	4.2dB
		1GHz ~ 26.5GHz	4.2dB
	Vertical	30MHz ~ 1000MHz	4.4dB
		1GHz ~ 26.5GHz	4.4dB
Conducted Emission		9kHz ~ 30MHz	3.1 dB

This uncertainty represents an expanded uncertainty factor of  $k=2$ .

**3.4 LIST OF USED TEST EQUIPMENT AT GRGT**

Name of Equipment	Manufacturer	Model	Serial Number	Calibration Due
<b>Conducted Emissions</b>				
EMI Receiver	R&S	ESU40	100529	2014-01-24
L.I.S.N	SCHWARZBECK	NSLK 8127	8127450	2013-08-05
<b>Spurious Emissions at Antenna Port</b>				
Receiver	R&S	ESU40	100106	2014-01-24
<b>Restricted Bands</b>				
Receiver	R&S	ESU40	100106	2014-01-24
<b>Spurious Emissions</b>				
Receiver	R&S	ESU40	100106	2014-01-24
Signal Generator	R&S	SML03	103002	2013-11-13
Biconical Log-periodic Antenna	ETS.LINDGREN	3142C	00075971	2013-05-26
Horn antenna	SCHWARZBECK	BBHA9120D	D752	2013-10-14
<b>6 dB Bandwidth</b>				
Receiver	R&S	ESU40	100106	2014-01-24
<b>Maximum Peak Output Power</b>				
Receiver	R&S	ESU40	100106	2014-01-24
<b>100kHz Bandwidth of Frequency Band Edge</b>				
Receiver	R&S	ESU40	100106	2014-01-24
<b>Power Spectral Density</b>				
Receiver	R&S	ESU40	100106	2014-01-24

**NOTE:** The calibration interval of the above test instruments is 12 months.

## 4. TEST RESULTS

### 4.1 E.U.T. TEST CONDITIONS

Type of antenna: Integral

Temperature: 22.0 °C

Humidity: 54 % RH

Atmospheric Pressure: 1011 mbar

Test frequencies: According to the 15.31(m) Measurements on intentional radiators or receivers, other than TV broadcast receivers, shall be performed and, if required, reported for each band in which the device can be operated with the device operating at the number of frequencies in each band specified in the following table:

Frequency range over which device operates	Number of frequencies	Location in the range of operation
1 MHz or less	1	Middle
1 to 10 MHz	2	1 near top and 1 near bottom
More than 10 MHz	3	1 near top, 1 near middle and 1 near bottom

EUT channels and frequencies list:

Channel	Frequency (MHz)	Channel	Frequency (MHz)	Channel	Frequency (MHz)
0	2402	14	2416	28	2430
1	2403	15	2417	29	2431
2	2404	16	2418	30	2432
3	2405	17	2419	31	2433
4	2406	18	2420	32	2434
5	2407	19	2421	33	2435
6	2408	20	2422	34	2436
7	2409	21	2423	35	2437
8	2410	22	2424	36	2438
9	2411	23	2425	37	2439
10	2412	24	2426	38	2440
11	2413	25	2427	39	2441
12	2414	26	2428	40	2442
13	2415	27	2429	41	2443

<b>Channel</b>	<b>Frequency (MHz)</b>	<b>Channel</b>	<b>Frequency (MHz)</b>	<b>Channel</b>	<b>Frequency (MHz)</b>
42	2444	55	2457	68	2470
43	2445	56	2458	69	2471
44	2446	57	2459	70	2472
45	2447	58	2460	71	2473
46	2448	59	2461	72	2474
47	2449	60	2462	73	2475
48	2450	61	2463	74	2476
49	2451	62	2464	75	2477
50	2452	63	2465	76	2478
51	2453	64	2466	77	2479
52	2454	65	2467	78	2480
53	2455	66	2468		
54	2456	67	2469		

Test frequency is the lowest channel: 0 channel(2402MHz), middle channel: 39 channel(2441MHz) and highest channel: 78 channel(2480MHz)

## 4.2 ANTENNA REQUIREMENT

The EUT antenna is PCB Printed antenna. Antenna gain is 3dBi .which accordance 15.203.is considered sufficient to comply with the provisions of this section

## 4.3 OCCUPIED BANDWIDTH

### 4.3.1 LIMITS

Frequency hopping systems operating in the 2400-2483.5 MHz band may have hopping channel carrier frequencies that are separated by 25 kHz or two-thirds of the 20 dB bandwidth of the hopping channel, whichever is greater, provided the systems operate with an output power no greater than 125 mW.

### 4.3.2 TEST PROCEDURES

1. Remove the antenna from the EUT and then connect a low RF cable from the antenna port to the spectrum;
2. Set the spectrum analyzer: Span = approximately 2 to 3 times the 20dB bandwidth, center on a hopping channel;
3. Set the spectrum analyzer: RBW  $\geq$  1% of the 20dB bandwidth (set 10kHz). VBW  $\geq$  RBW. Sweep = auto; Detector Function = Peak. Trace = Max Hold.
4. Mark the peak frequency and -20dB bandwidth.
5. bandwidth value is OBW value.

Remark:

**Pre-test the 3 modulation to find GFSK and 8DPSK is worse case, so only record GFSK and 8DPSK test data.**

### 4.3.3 TEST SETUP

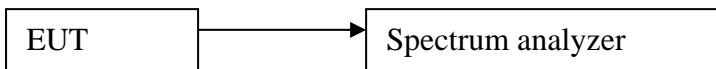

### 4.3.4 TEST RESULTS

**For GFSK**

Frequency (GHz)	Test Channel	bandwidth
2.402	Lowest	1.150MHz
2.441	Middle	1.135MHz
2.480	Highest	1.135MHz

**For 8DPSK**

Frequency (GHz)	Test Channel	bandwidth
2.402	Lowest	1.315MHz
2.441	Middle	1.320MHz
2.480	Highest	1.325MHz

Result plot as follows:

**GFSK Lowest Channel :**

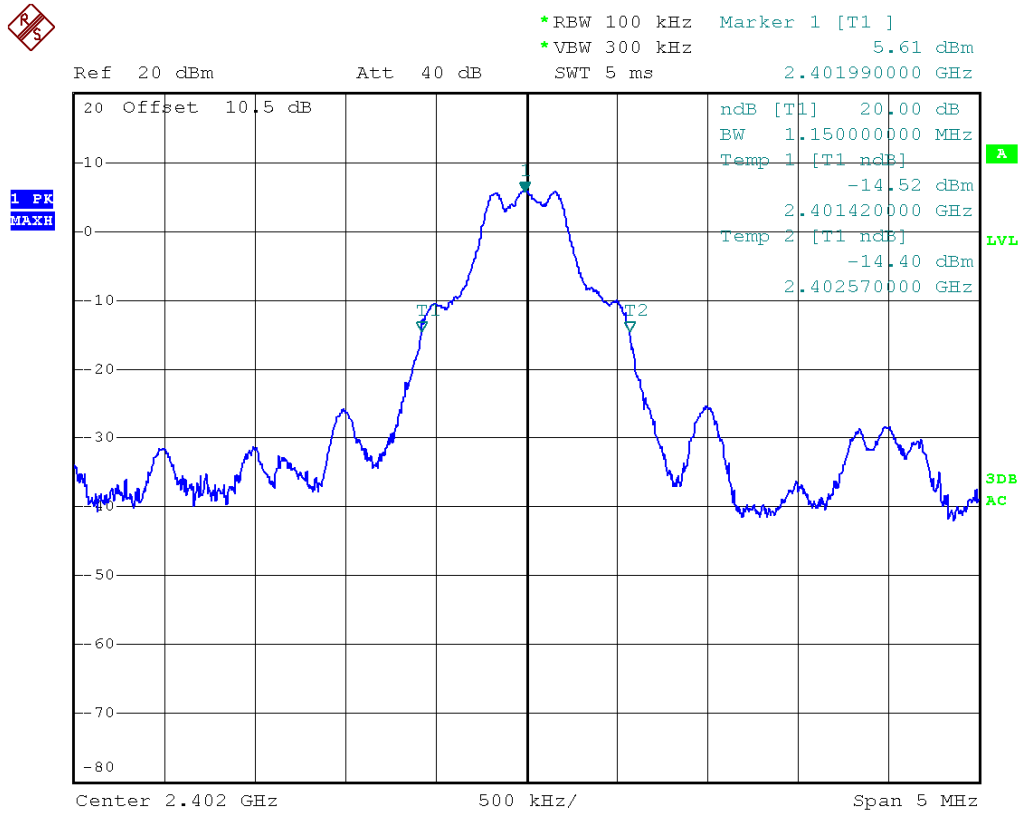

**GFSK Middle Channel :**

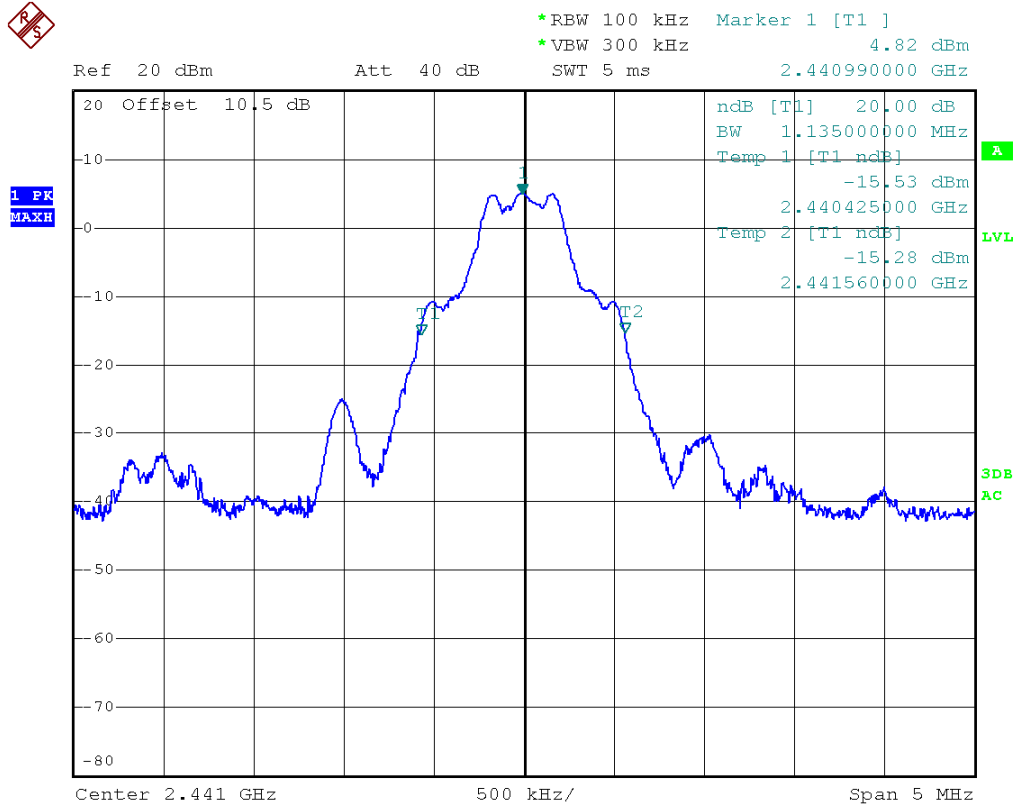

**GFSK Highest Channel :**

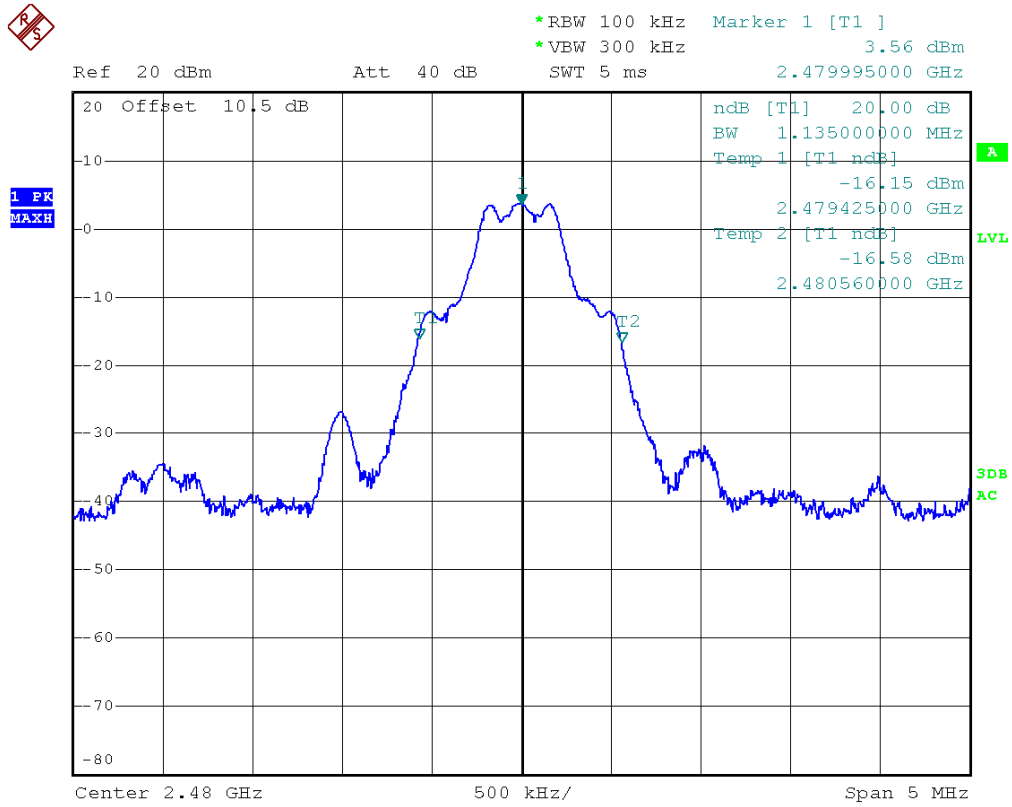

**8DPSK Lowest Channel :**

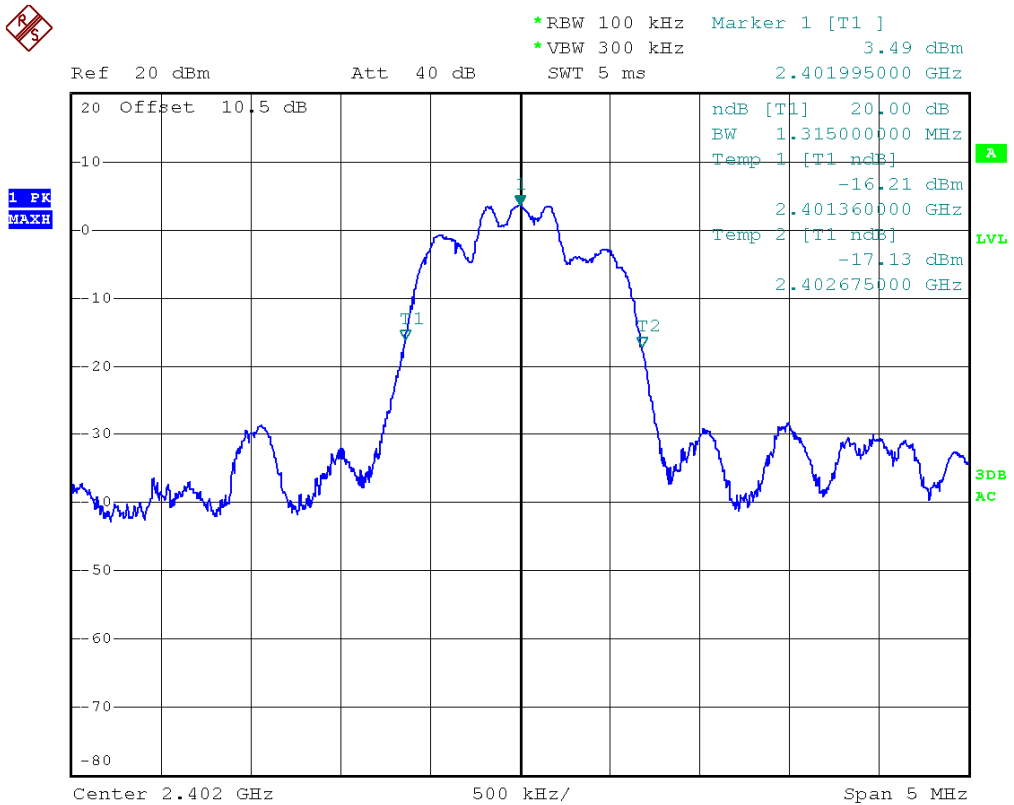

### 8DPSK Middle Channel :

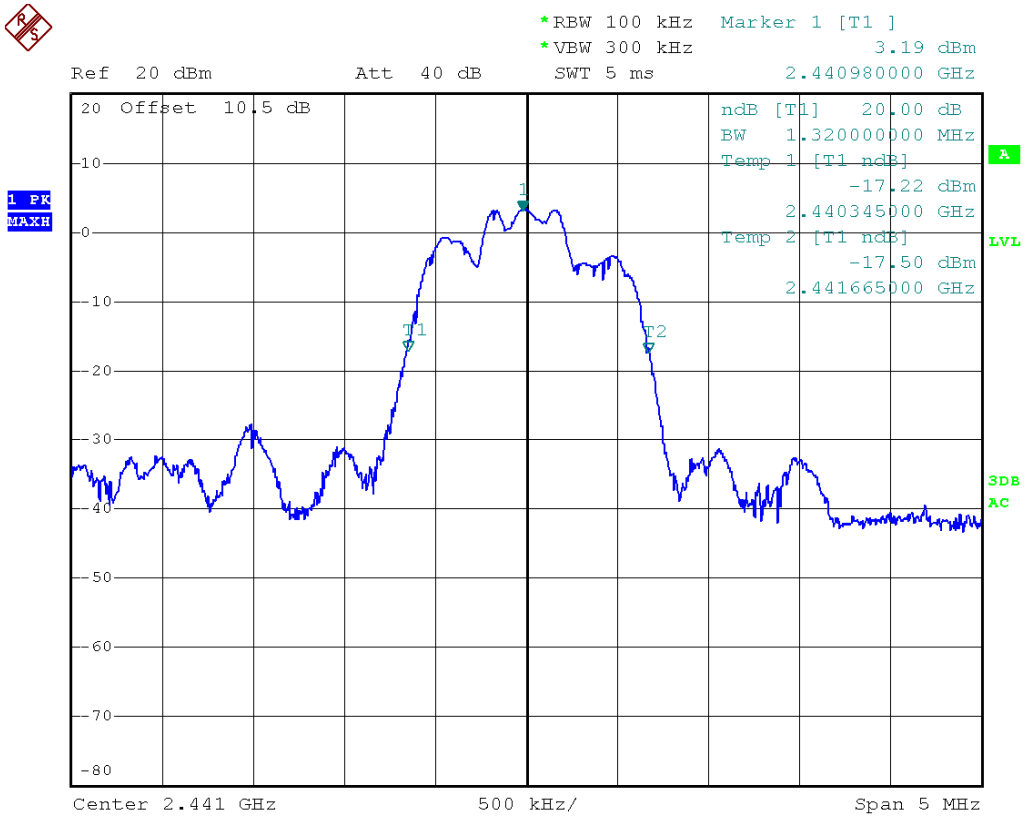

### 8DPSK Highest Channel :

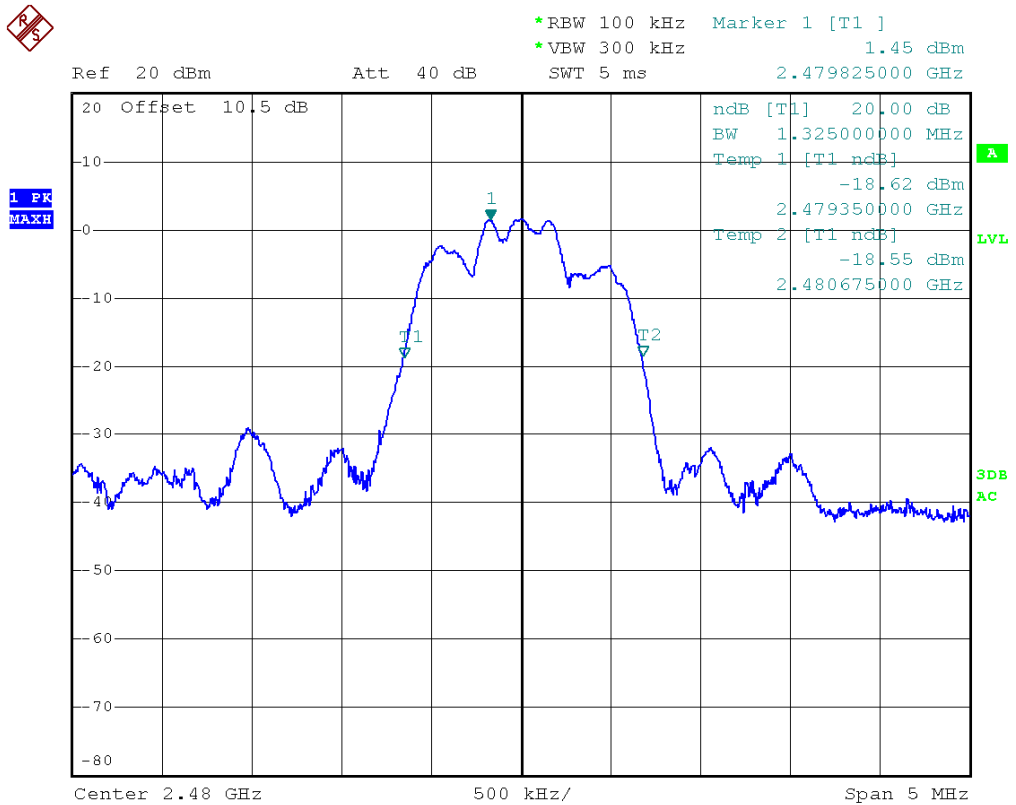

### 4.4 CARRIER FREQUENCIES SEPARATED

#### 4.4.1 LIMITS

Frequency hopping systems operating in the 2400-2483.5 MHz band may have hopping channel carrier frequencies that are separated by 25 kHz or two-thirds of the 20 dB bandwidth of the hopping channel, whichever is greater, provided the systems operate with an output power no greater than 125 mW.

#### 4.4.2 TEST PROCEDURES

1. Remove the antenna from the EUT and then connect a low RF cable from the antenna port to the spectrum.
2. Set the spectrum analyzer: RBW  $\geq$  1% of the span (set 100 kHz). VBW  $\geq$  RBW , Span = 6MHz. Sweep = auto; Detector Function = Peak. Trace = Max,hold.
3. Allow the trace to stabilize. Use the marker-delta function to determine the separation between the peaks of the adjacent channels. The limit is specified in one of the subparagraphs of this Section. Submit this plot.

Remark :

**Pre-test the 3 modulation to find GFSK and 8DPSK is worse case, so only record GFSK and 8DPSK test data.**

#### 4.4.3 TEST SETUP

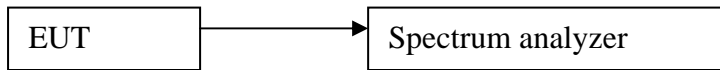

#### 4.4.4 TEST RESULTS

Mode	Test Channel	Carrier Frequencies Separated	2/3 20 dB bandwidth	PASS/FAIL
GFSK	Lower Channels (channel 0 and channel 1)	1.008MHz	0.767	Pass
	Middle Channels (channel 39 and channel 40)	1.008MHz	0.757	Pass
	Upper Channels (channel 77 and channel 78)	1.008MHz	0.757	Pass
8DPSK	Lower Channels (channel 0 and channel 1)	1.020MHz	0.877	Pass
	Middle Channels (channel 39 and channel 40)	1.008MHz	0.880	Pass
	Upper Channels (channel 77 and channel 78)	1.008MHz	0.883	Pass

Result plot as follows:

GFSK Lowest Channels:

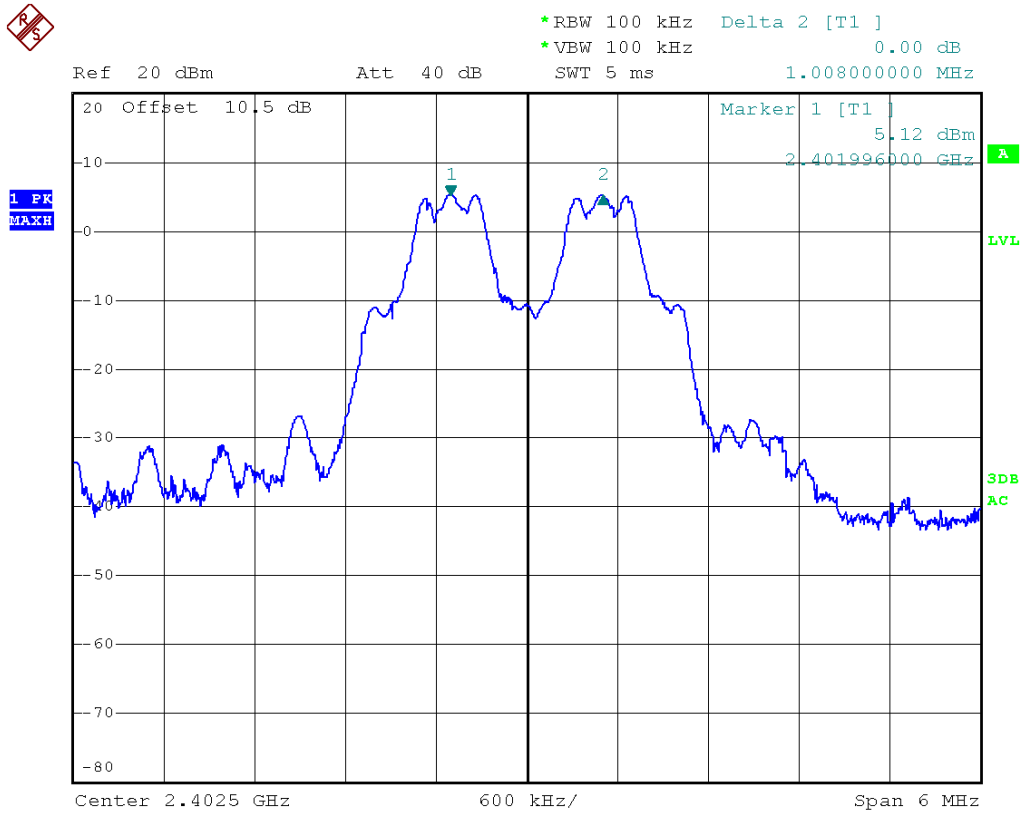

GFSK Middle Channels:

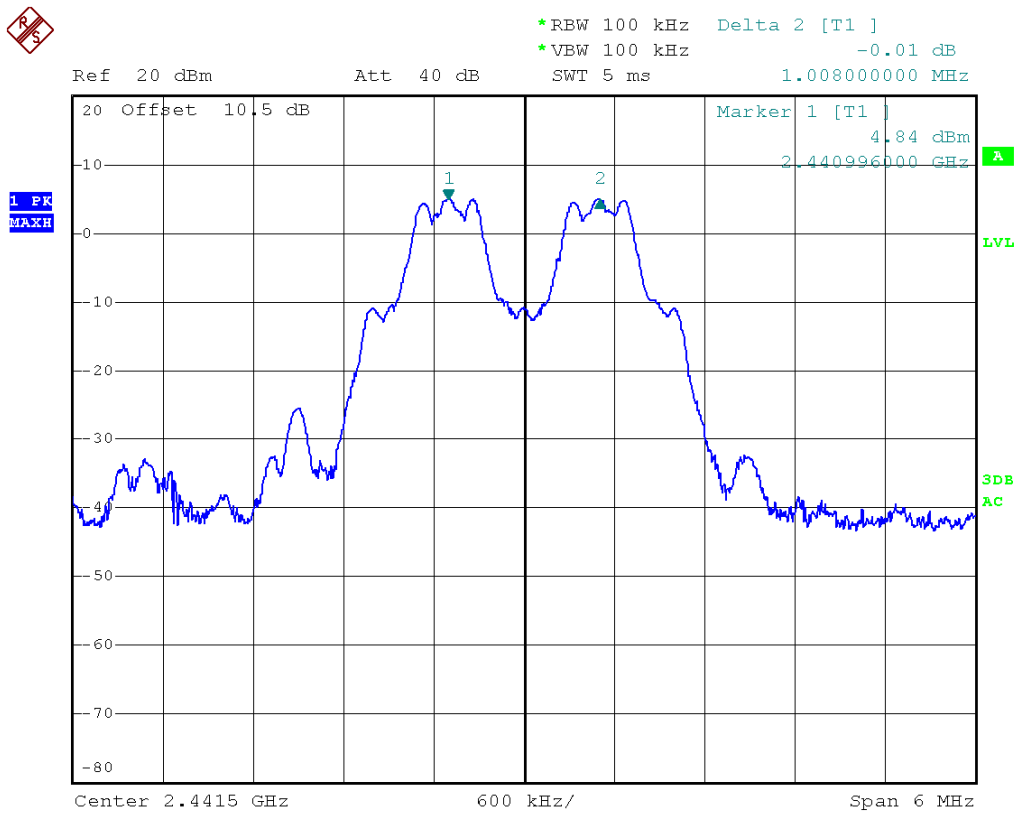

GFSK Highest Channels:

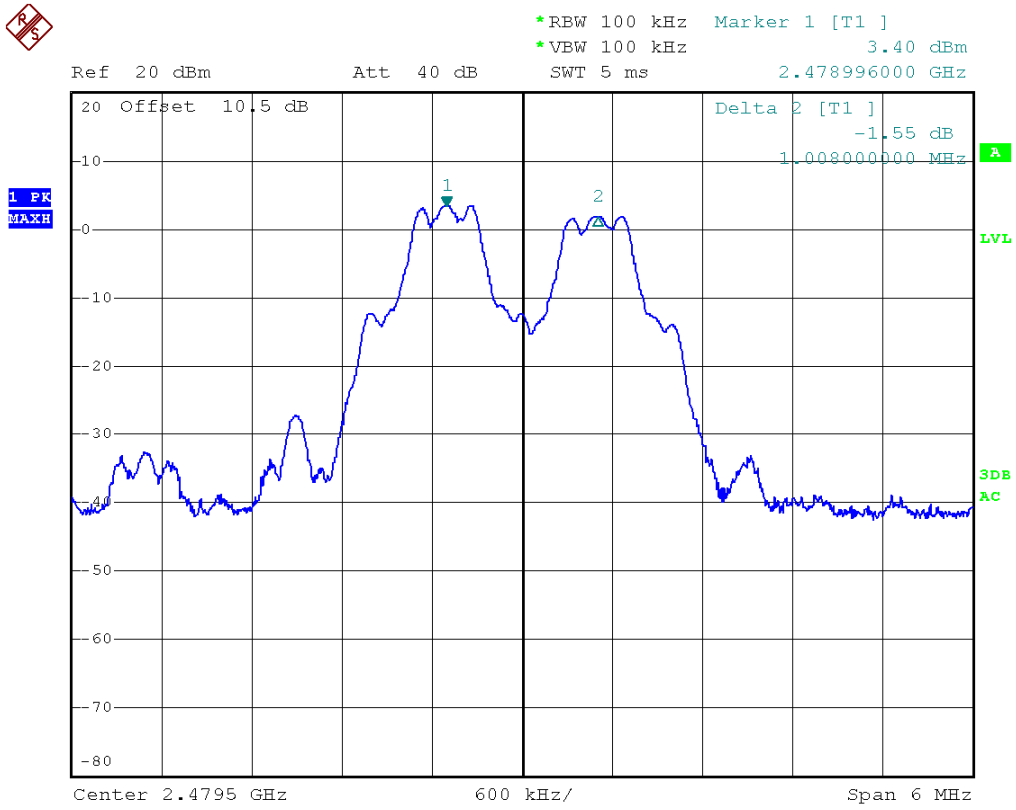

8DPSK Lowest Channels:

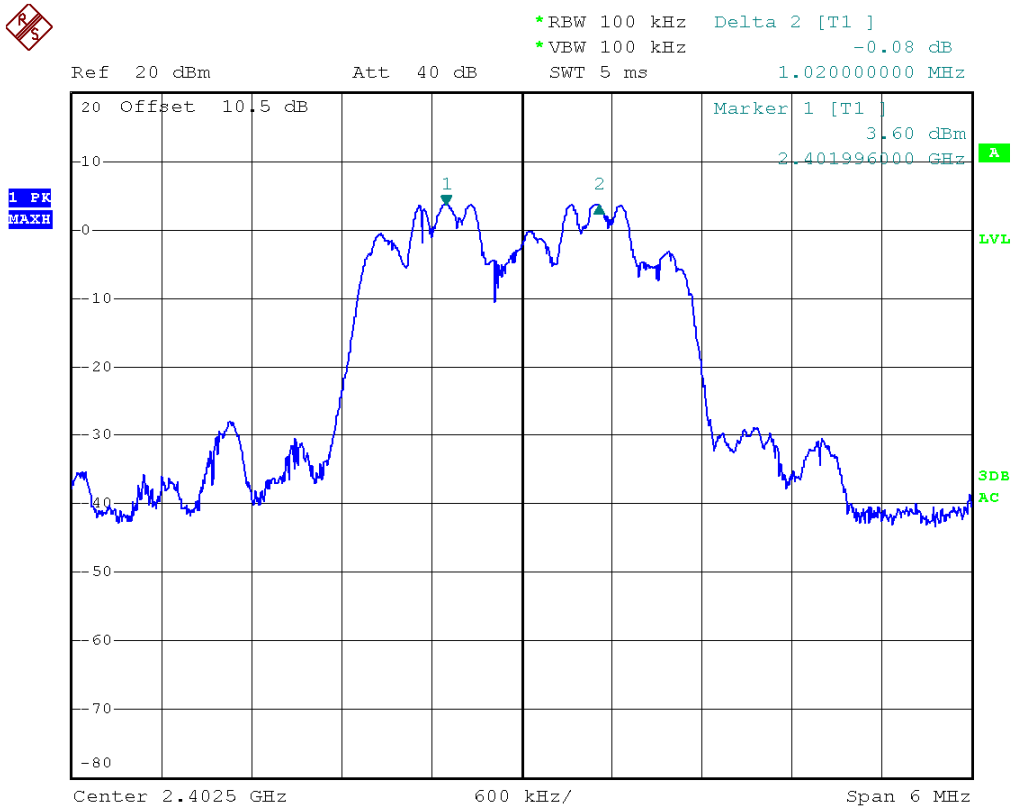

8DPSK Middle Channels:

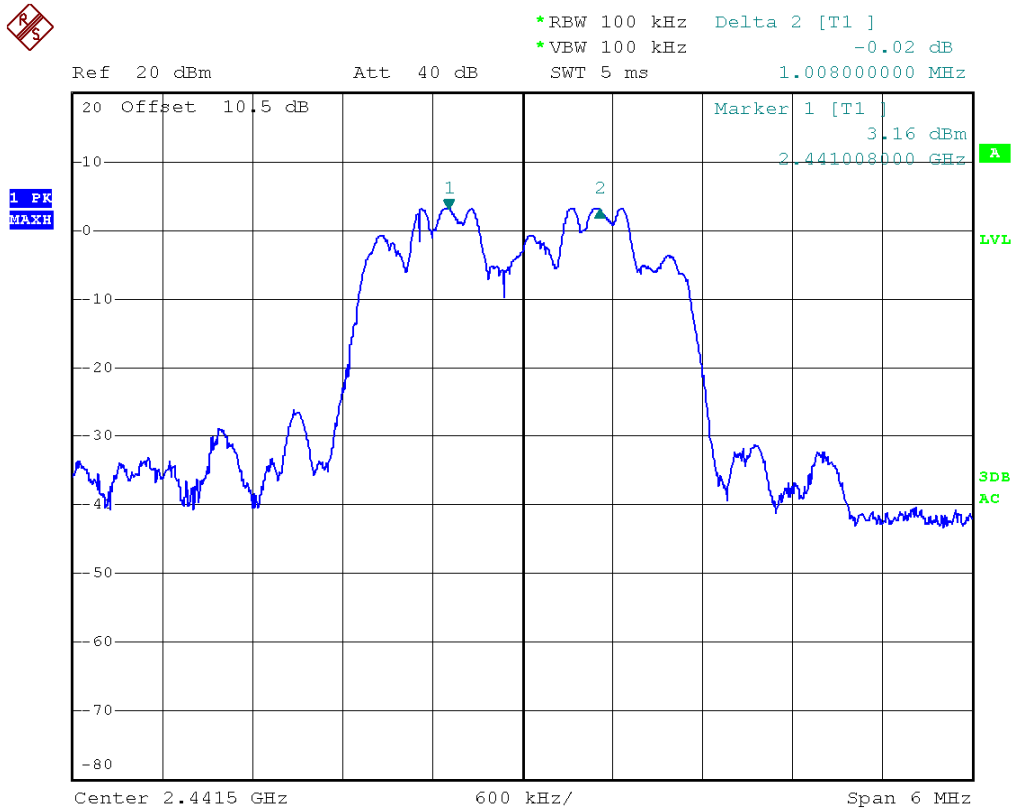

8DPSK Highest Channels:

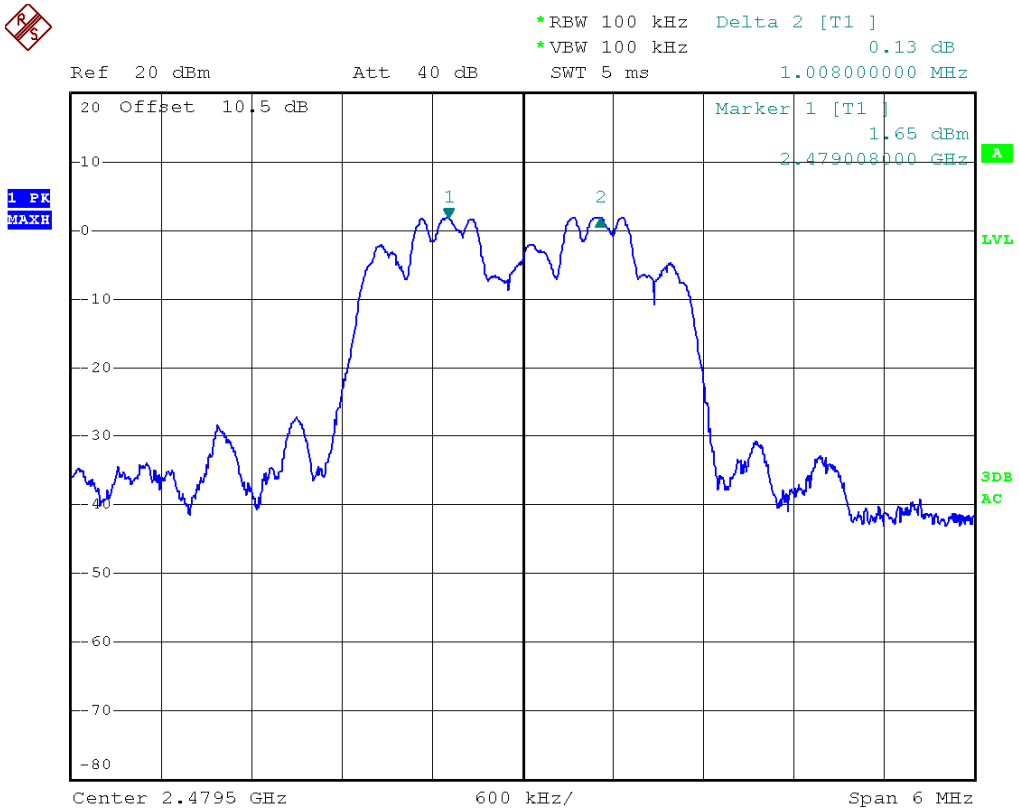

**Test result: The unit does meet the FCC requirements.**

## 4.5 HOPPING CHANNEL NUMBER

### 4.5.1 LIMITS

Regulation 15.247 (a) (1)(iii) Frequency hopping systems in the 2400-2483.5 MHz band shall use at least 15 channels.

### 4.5.2 TEST PROCEDURES

1. Remove the antenna from the EUT and then connect a low RF cable from the antenna port to the spectrum.
2. Set the spectrum analyzer: RBW = 100 kHz. VBW = 300 kHz. Sweep = auto; Detector Function = Peak. Trace = Max hold.
3. Allow the trace to stabilize. It may prove necessary to break the span up to sections. in order to clearly show all of the hopping frequencies. The limit is specified in one of the subparagraphs of this Section.
4. Set the spectrum analyzer: start frequency = 2400MHz. stop frequency = 2483.5MHz. Submit the test result graph.

### 4.5.3 TEST SETUP

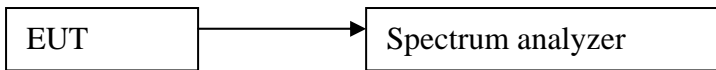

### 4.5.4 TEST RESULTS

**Test result:** Total channels are 79 channels.

Result plot as follows:

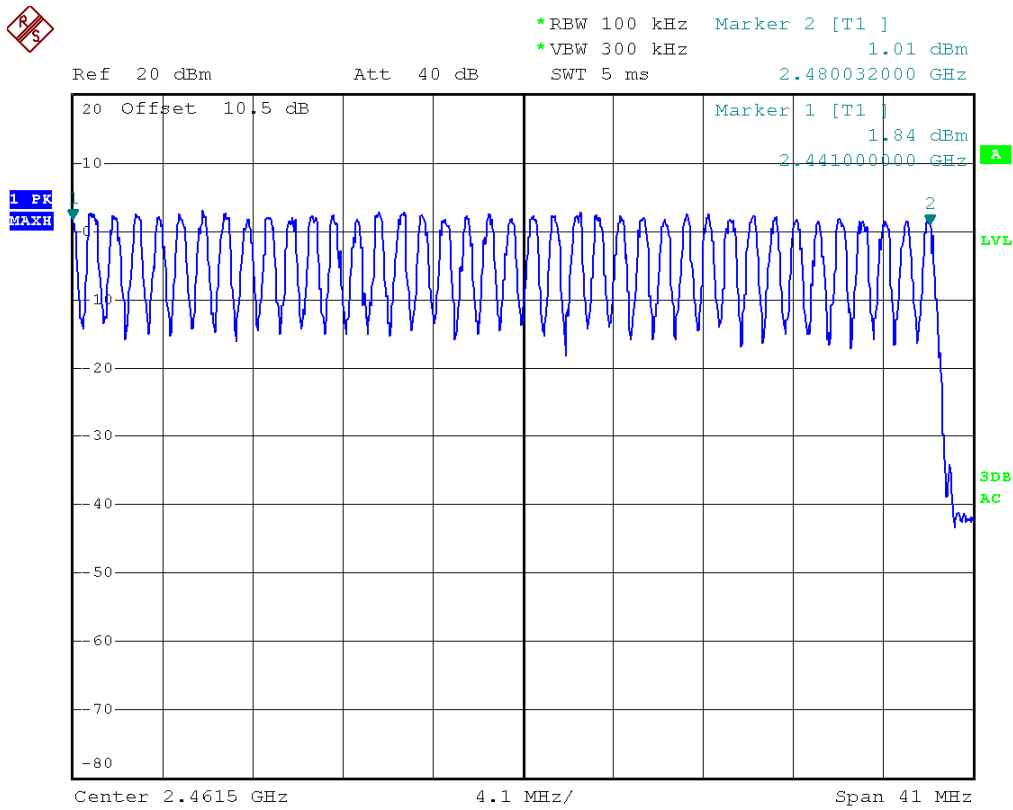
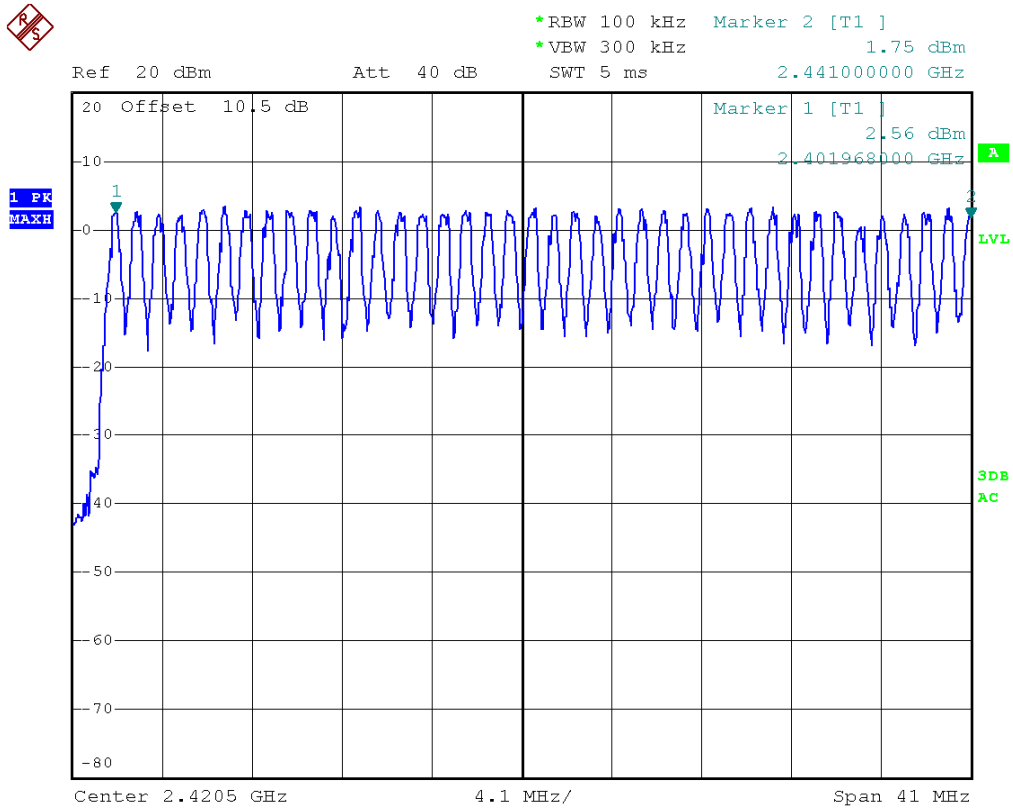

**Test result: The unit does meet the FCC requirements.**

## 4.6 DWELL TIME

### 4.6.1 LIMITS

Regulation 15.247(a)(1)(iii) Frequency hopping systems in the 2400-2483.5 MHz band shall use at least 15 channels. The average time of occupancy on any channel shall not be greater than 0.4 seconds within a period of 0.4 seconds multiplied by the number of hopping channels employed. Frequency hopping systems may avoid or suppress transmissions on a particular hopping frequency provided that a minimum of 15 channels are used.

### 4.6.2 TEST PROCEDURES

1. Remove the antenna from the EUT and then connect a low RF cable from the antenna port to the spectrum.
2. Set spectrum analyzer span = 0. centered on a hopping channel;
3. Set RBW = 1MHz and VBW = 3MHz.Sweep = as necessary to capture the entire dwell time per hopping channel. Detector Function = Peak. Trace = Max hold;
4. Use the marker-delta function to determine the dwell time. If this value varies with different modes of operation (e.g., data rate, modulation format, etc.). repeat this test for each variation. The limit is specified in one of the subparagraphs of this Section. Submit this plot(s). An oscilloscope may be used instead of a spectrum analyzer.

### 4.6.3 TEST SETUP

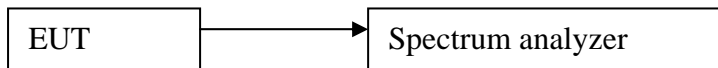

### 4.6.4 TEST RESULTS

The test period:  $T = 0.4 \text{ Second/Channel} \times 79 \text{ Channel} = 31.6 \text{ s}$

#### 1. Channel 0: 2.402GHz

DH1 time slot =  $0.387 \text{ (ms)} \times (1600/(2*79)) \times 31.6 = 123.840 \text{ ms}$

DH3 time slot =  $1.651 \text{ (ms)} \times (1600/(4*79)) \times 31.6 = 264.160 \text{ ms}$

DH5 time slot =  $2.918 \text{ (ms)} \times (1600/(6*79)) \times 31.6 = 311.253 \text{ ms}$

2DH1 time slot =  $0.411 \text{ (ms)} \times (1600/(2*79)) \times 31.6 = 131.520 \text{ ms}$

2DH3 time slot =  $1.659 \text{ (ms)} \times (1600/(4*79)) \times 31.6 = 265.440 \text{ ms}$

2DH5 time slot =  $1.707 \text{ (ms)} \times (1600/(6*79)) \times 31.6 = 182.080 \text{ ms}$

3DH1 time slot =  $0.409 \text{ (ms)} \times (1600/(2*79)) \times 31.6 = 130.880 \text{ ms}$

3DH3 time slot =  $1.673 \text{ (ms)} \times (1600/(4*79)) \times 31.6 = 267.680 \text{ ms}$

3DH5 time slot =  $2.921 \text{ (ms)} \times (1600/(6*79)) \times 31.6 = 311.573 \text{ ms}$

**2. Channel 39: 2.441GHz**

$$\text{DH1 time slot} = 0.392 \text{ (ms)} * (1600/(2*79)) * 31.6 = 125.440 \text{ ms}$$

$$\text{DH3 time slot} = 1.656 \text{ (ms)} * (1600/(4*79)) * 31.6 = 264.960 \text{ ms}$$

$$\text{DH5 time slot} = 2.920 \text{ (ms)} * (1600/(6*79)) * 31.6 = 311.467 \text{ ms}$$

$$2\text{DH1 time slot} = 0.409 \text{ (ms)} * (1600/(2*79)) * 31.6 = 130.880 \text{ ms}$$

$$2\text{DH3 time slot} = 1.689 \text{ (ms)} * (1600/(4*79)) * 31.6 = 263.040 \text{ ms}$$

$$2\text{DH5 time slot} = 1.721 \text{ (ms)} * (1600/(6*79)) * 31.6 = 183.573 \text{ ms}$$

$$3\text{DH1 time slot} = 0.411 \text{ (ms)} * (1600/(2*79)) * 31.6 = 131.520 \text{ ms}$$

$$3\text{DH3 time slot} = 1.675 \text{ (ms)} * (1600/(4*79)) * 31.6 = 268.000 \text{ ms}$$

$$3\text{DH5 time slot} = 2.923 \text{ (ms)} * (1600/(6*79)) * 31.6 = 311.787 \text{ ms}$$

**3. Channel 78: 2.480GHz**

$$\text{DH1 time slot} = 0.397 \text{ (ms)} * (1600/(2*79)) * 31.6 = 127.040 \text{ ms}$$

$$\text{DH3 time slot} = 1.669 \text{ (ms)} * (1600/(4*79)) * 31.6 = 271.840 \text{ ms}$$

$$\text{DH5 time slot} = 2.886 \text{ (ms)} * (1600/(6*79)) * 31.6 = 307.840 \text{ ms}$$

$$2\text{DH1 time slot} = 0.396 \text{ (ms)} * (1600/(2*79)) * 31.6 = 126.720 \text{ ms}$$

$$2\text{DH3 time slot} = 1.644 \text{ (ms)} * (1600/(4*79)) * 31.6 = 263.040 \text{ ms}$$

$$2\text{DH5 time slot} = 1.708 \text{ (ms)} * (1600/(6*79)) * 31.6 = 182.186 \text{ ms}$$

$$3\text{DH1 time slot} = 0.403 \text{ (ms)} * (1600/(2*79)) * 31.6 = 128.960 \text{ ms}$$

$$3\text{DH3 time slot} = 1.651 \text{ (ms)} * (1600/(4*79)) * 31.6 = 264.160 \text{ ms}$$

$$3\text{DH5 time slot} = 2.915 \text{ (ms)} * (1600/(6*79)) * 31.6 = 310.933 \text{ ms}$$

**The results are not greater than 0.4 seconds.**

**The unit does meet the requirements.**

Please refer the graph as below:

1. Lowest channel (2.402 GHz):

DH1

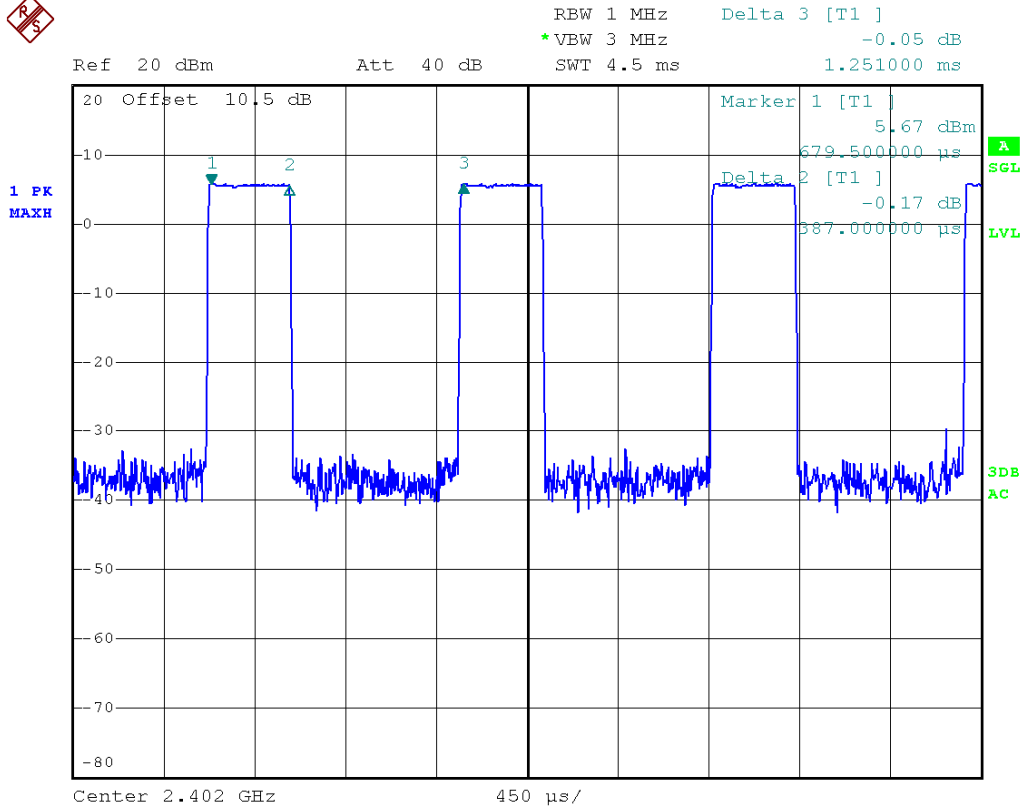

DH3:

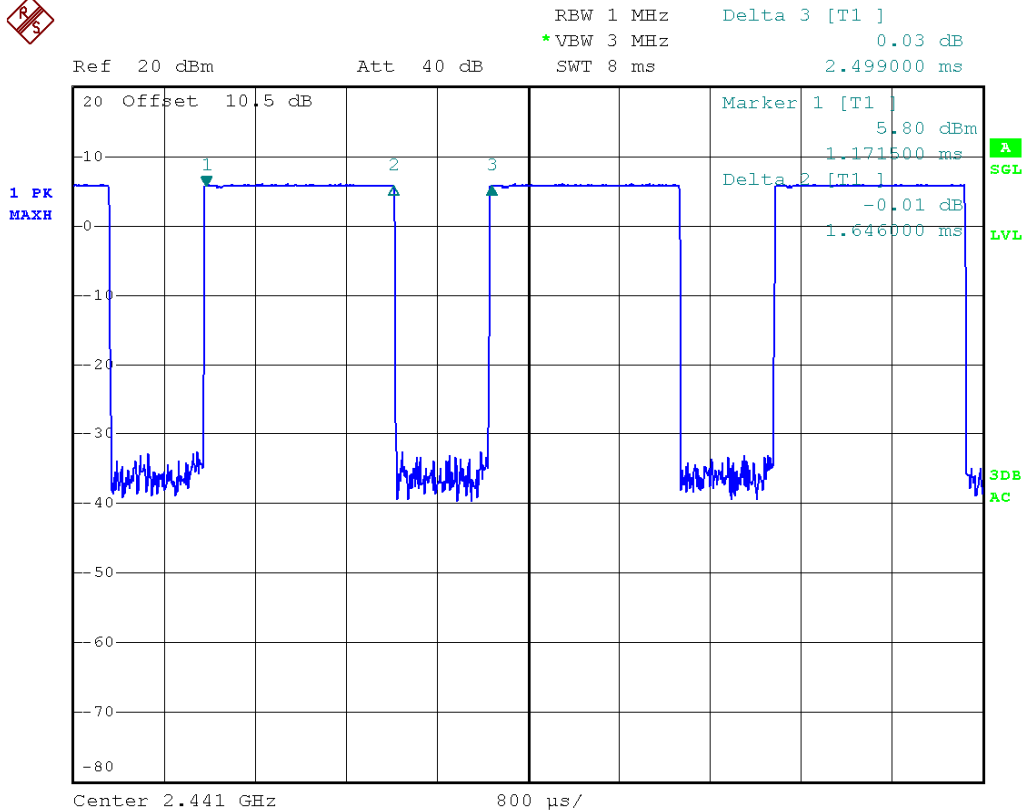

DH5:



RBW 1 MHz    Delta 3 [T1 ]  
\*VBW 3 MHz    0.03 dB  
SWT 8 ms    3.763000 ms

Ref 20 dBm    Att 40 dB

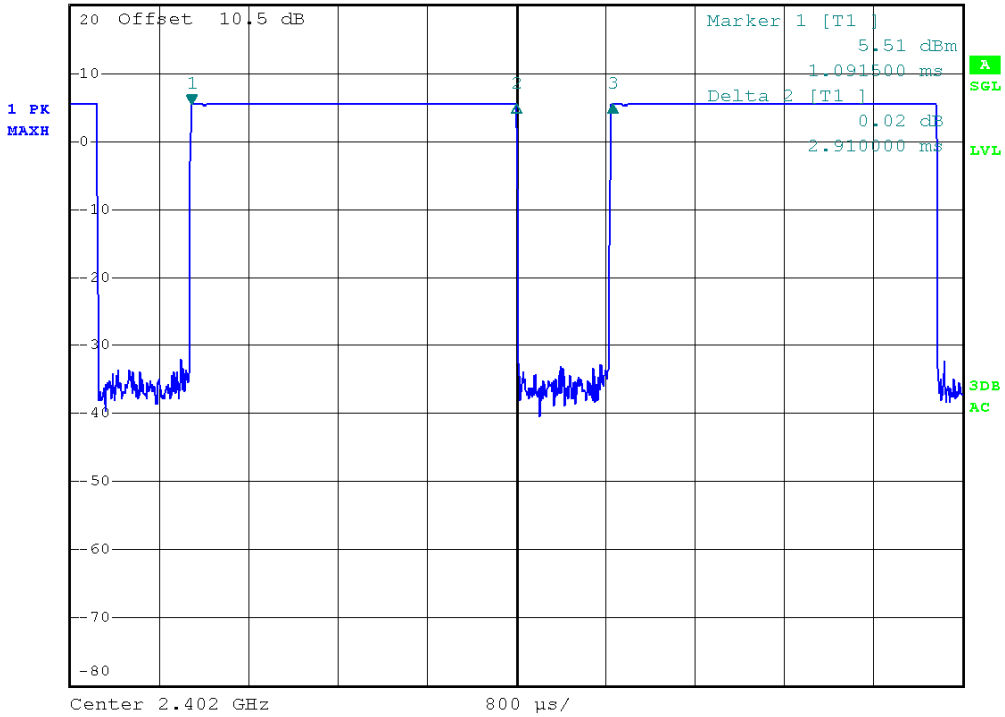

2DH1



RBW 1 MHz    Delta 3 [T1 ]  
\*VBW 3 MHz    0.03 dB  
SWT 4.5 ms    1.251000 ms

Ref 20 dBm    Att 40 dB

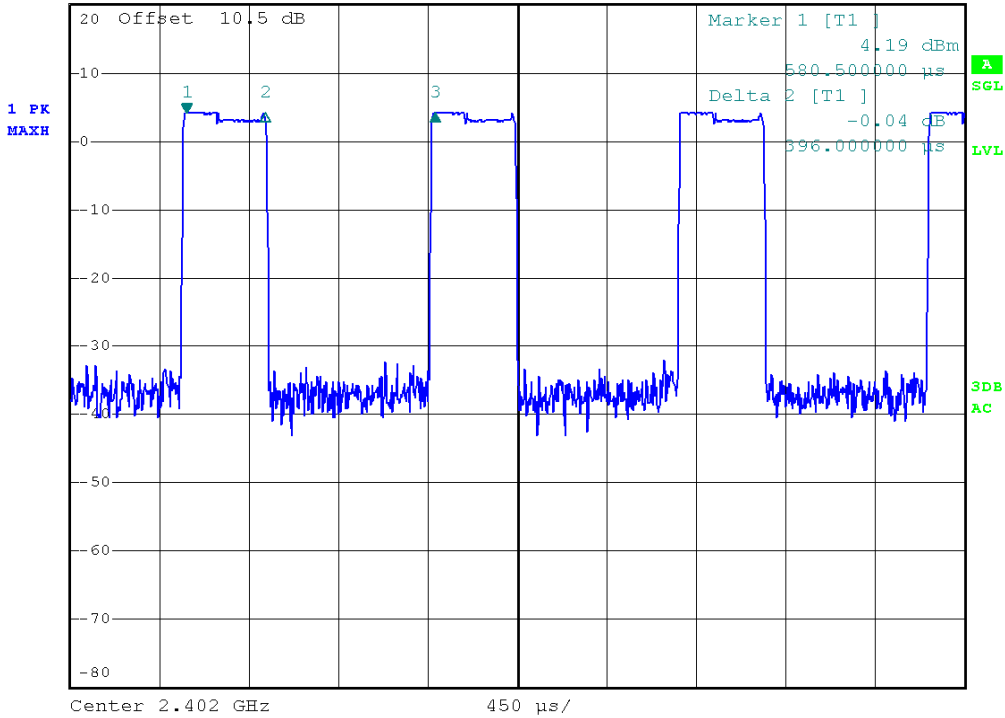

2DH3

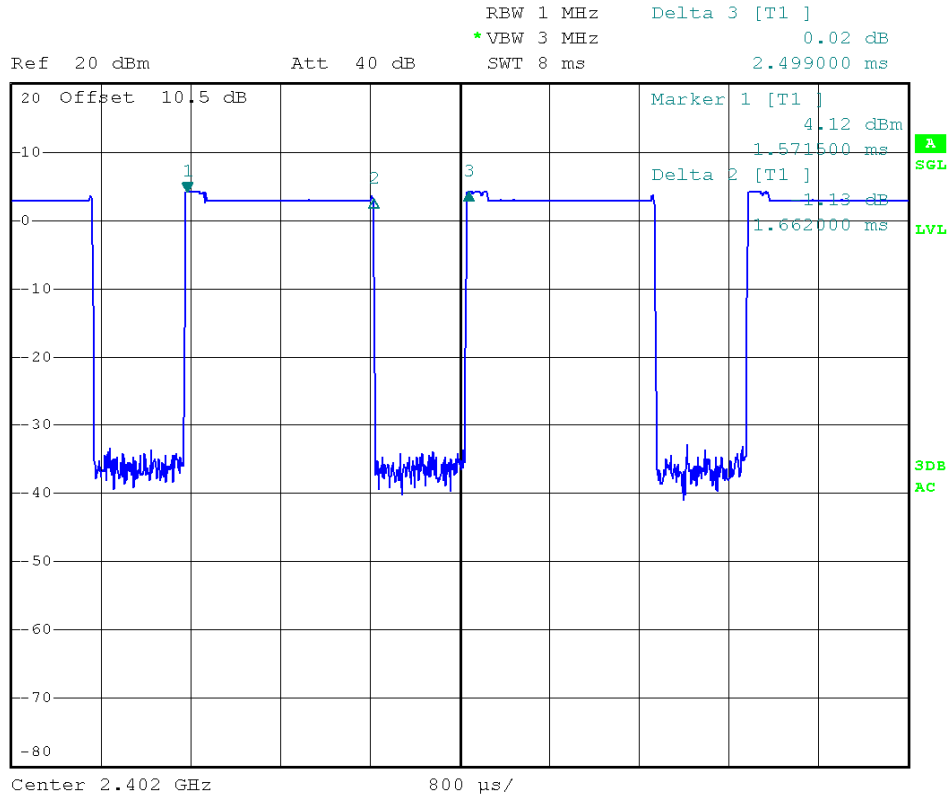

2DH5

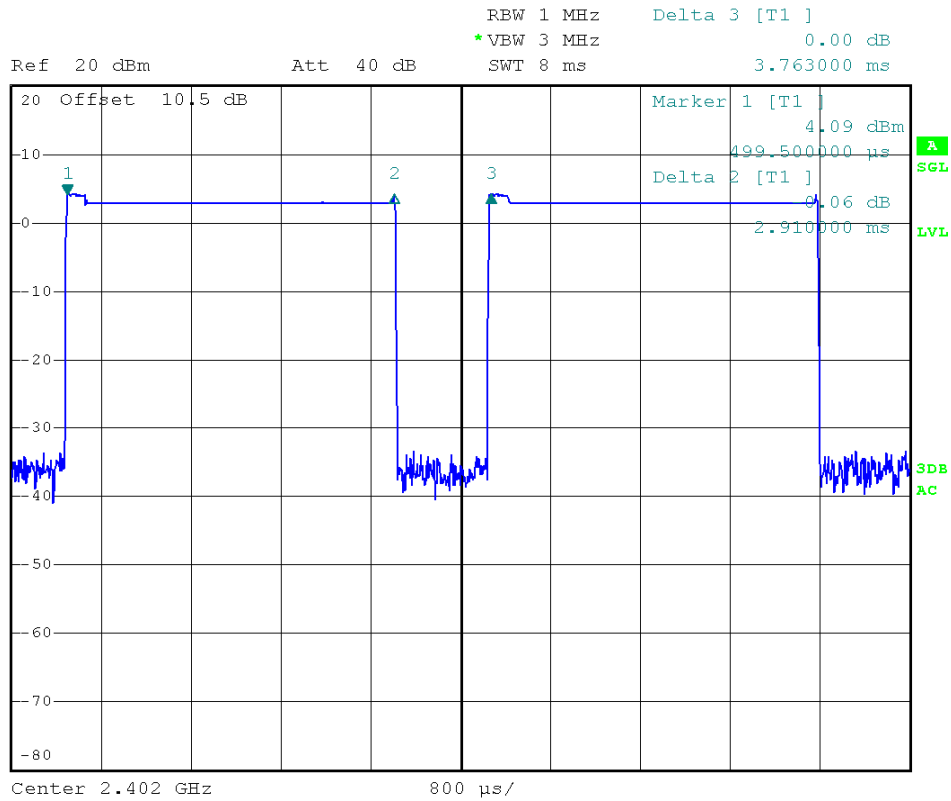

3DH1

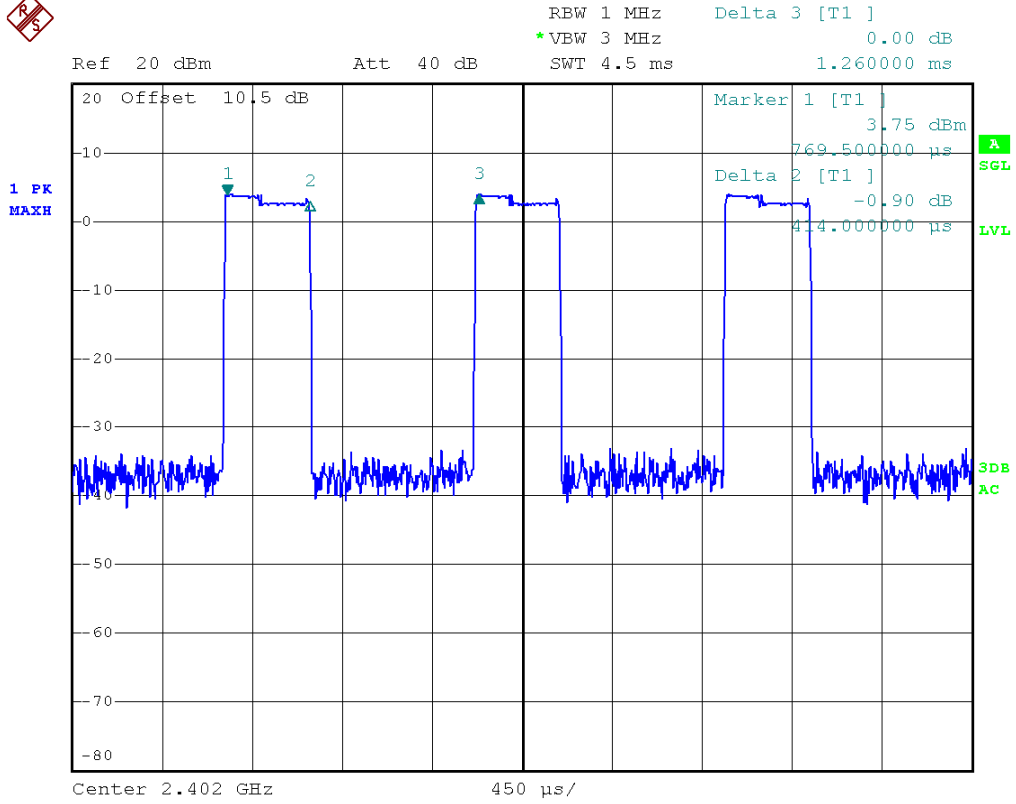

3DH3

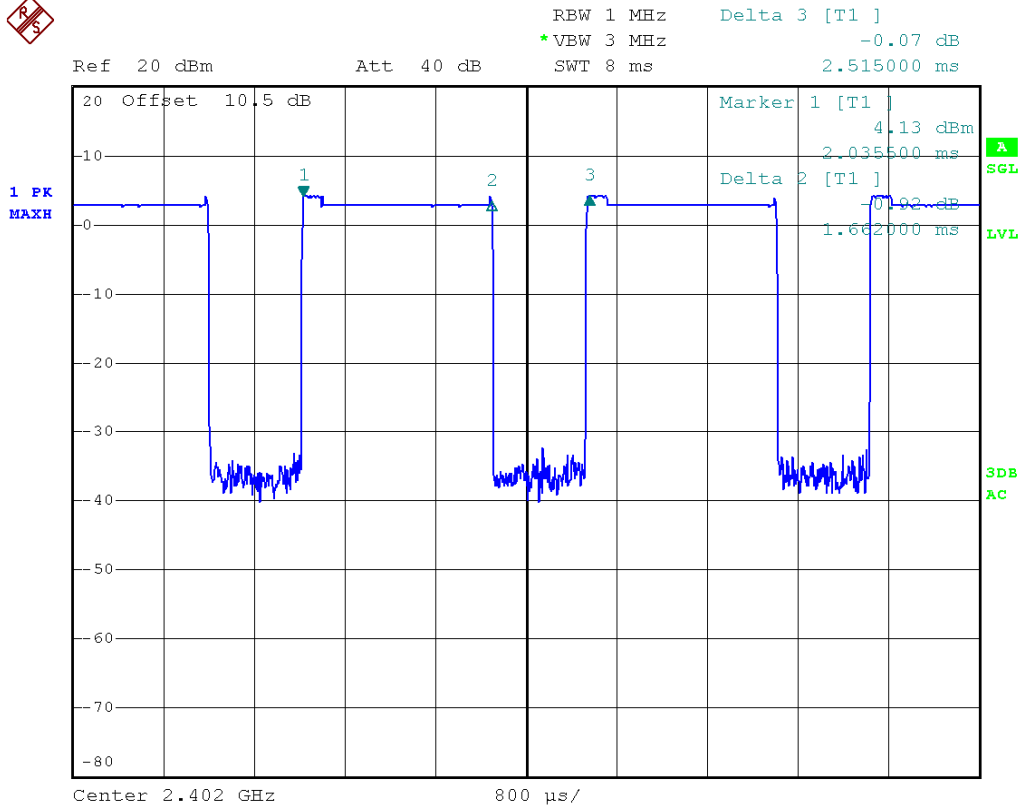

3DH5



RBW 1 MHz Delta 3 [T1 ]  
\*VBW 3 MHz -0.01 dB  
SWT 8 ms 3.763000 ms

Ref 20 dBm

Att 40 dB

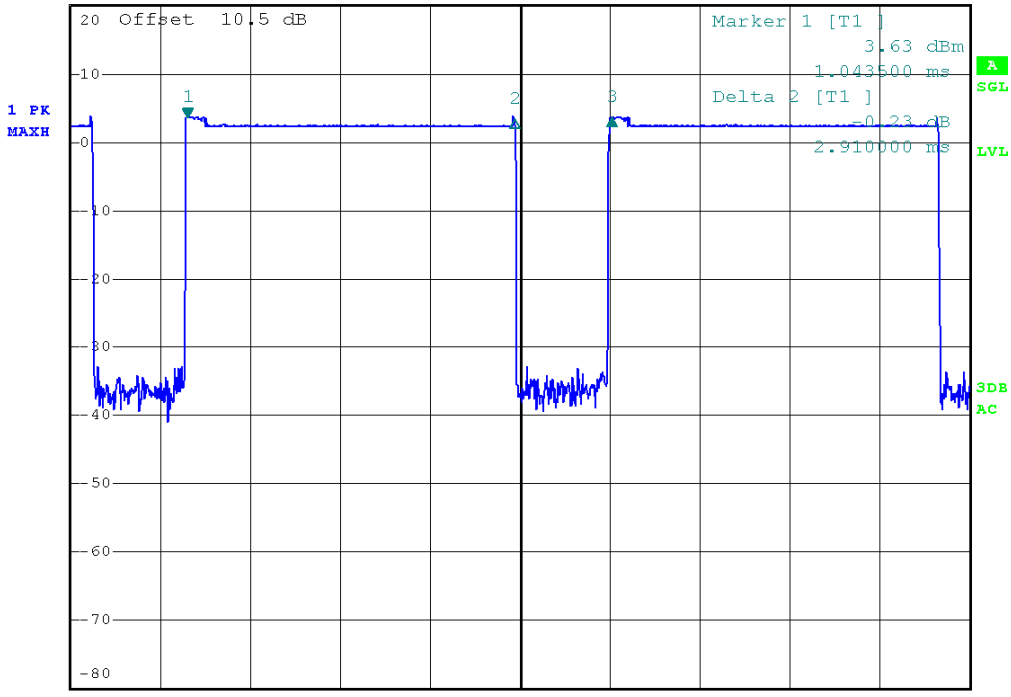

Center 2.402 GHz

800 μs/

### 2. Middle Channel (2.441GHz)

DH1



RBW 1 MHz      Delta 3 [T1 ]  
\*VBW 3 MHz      -0.07 dB  
SWT 4.5 ms      1.251000 ms

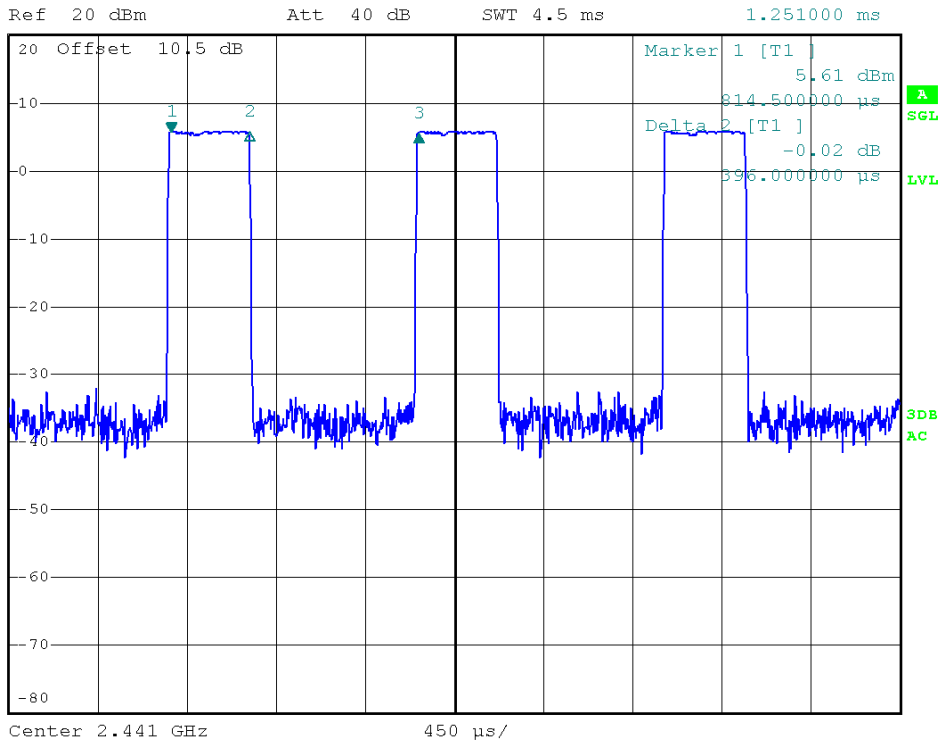

DH3



RBW 1 MHz      Delta 3 [T1 ]  
\*VBW 3 MHz      0.03 dB  
SWT 8 ms      2.499000 ms

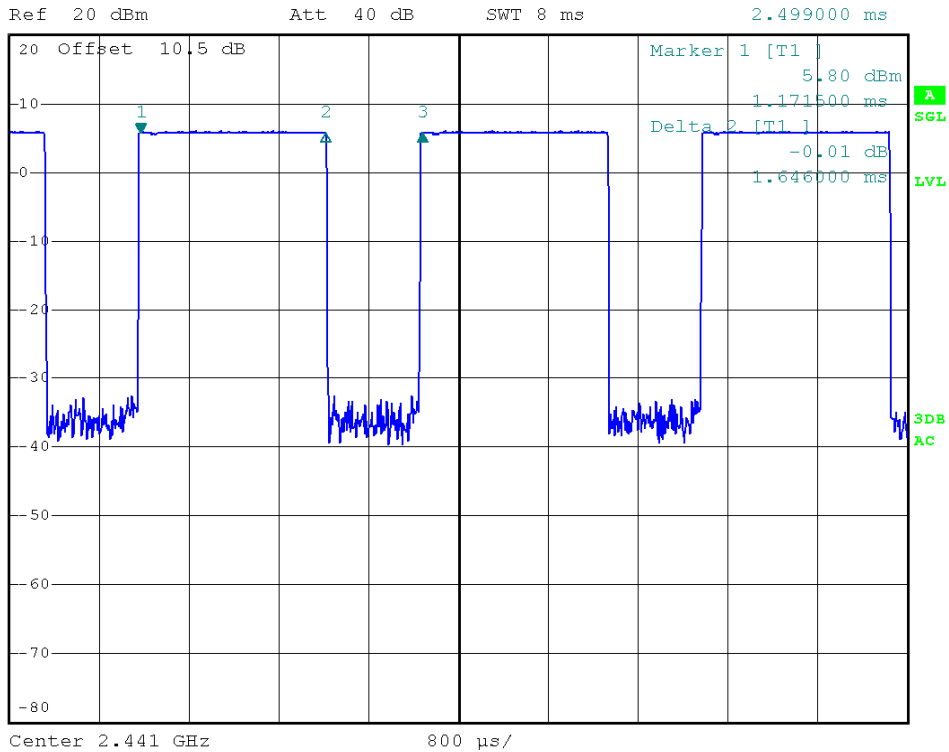

DH5

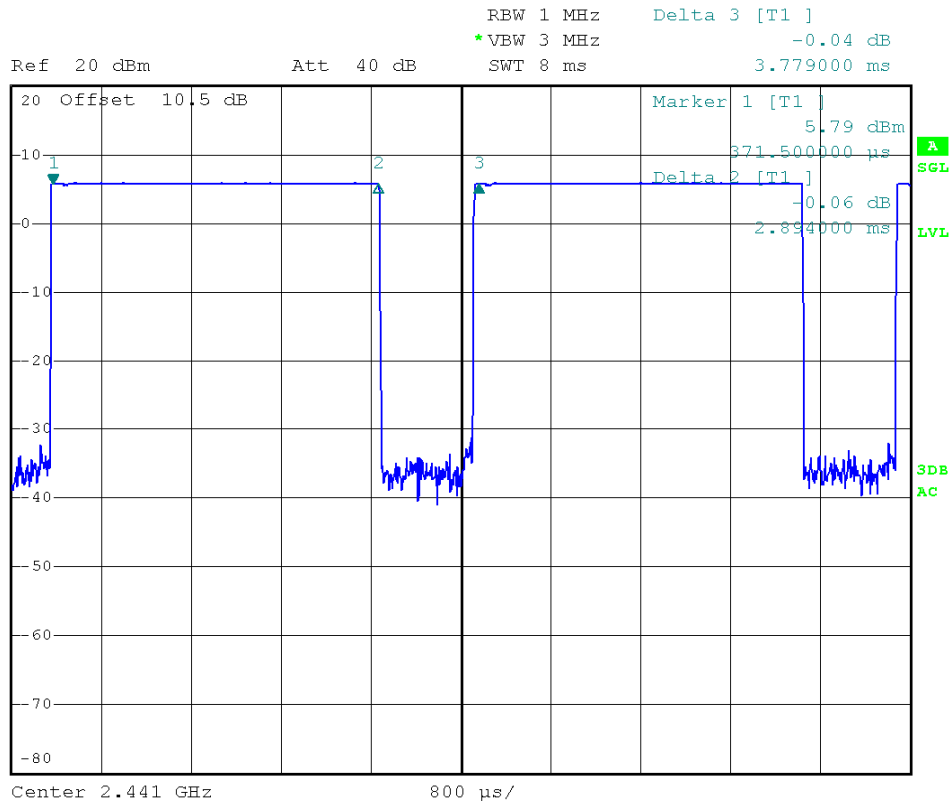

2DH1

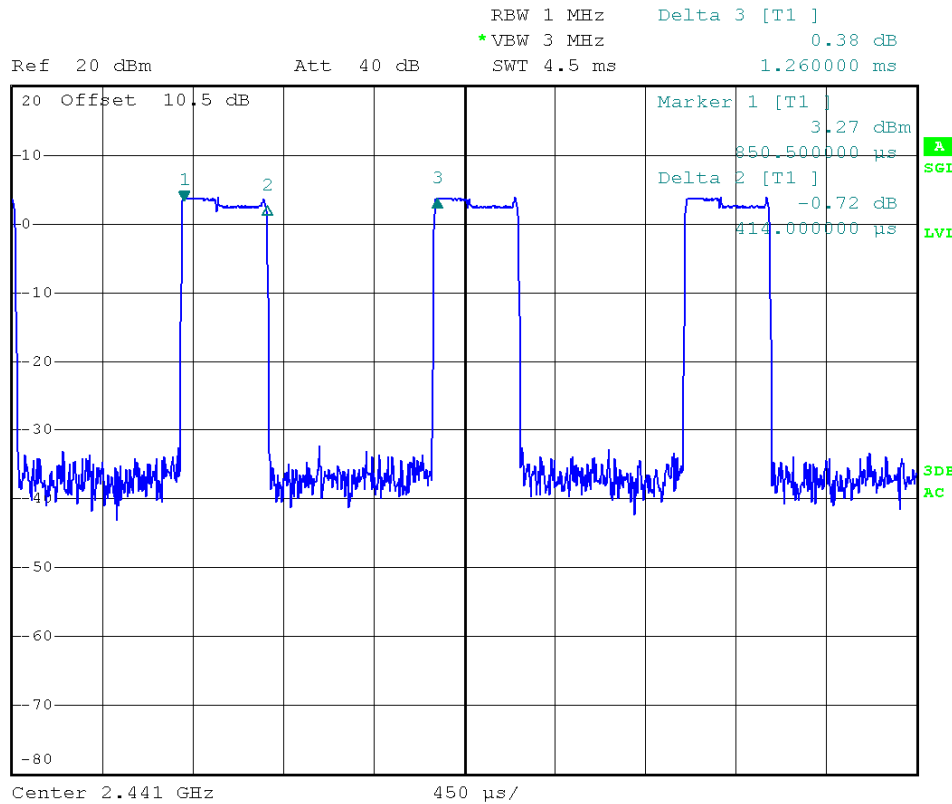

2DH3

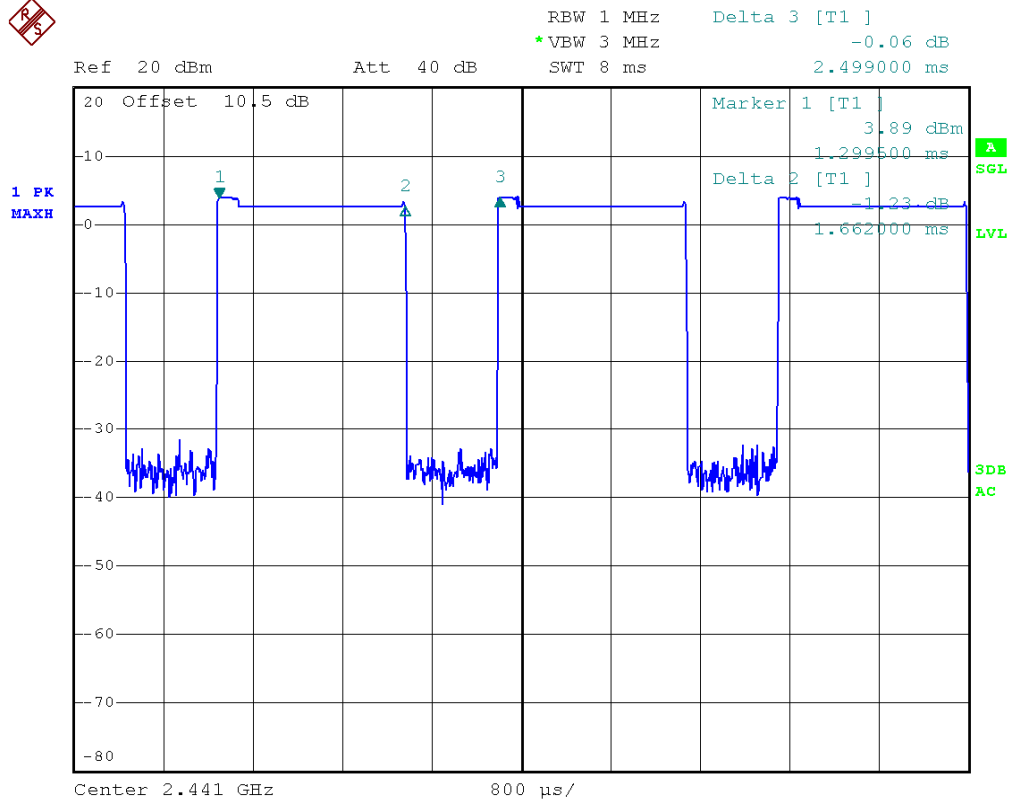

2DH5

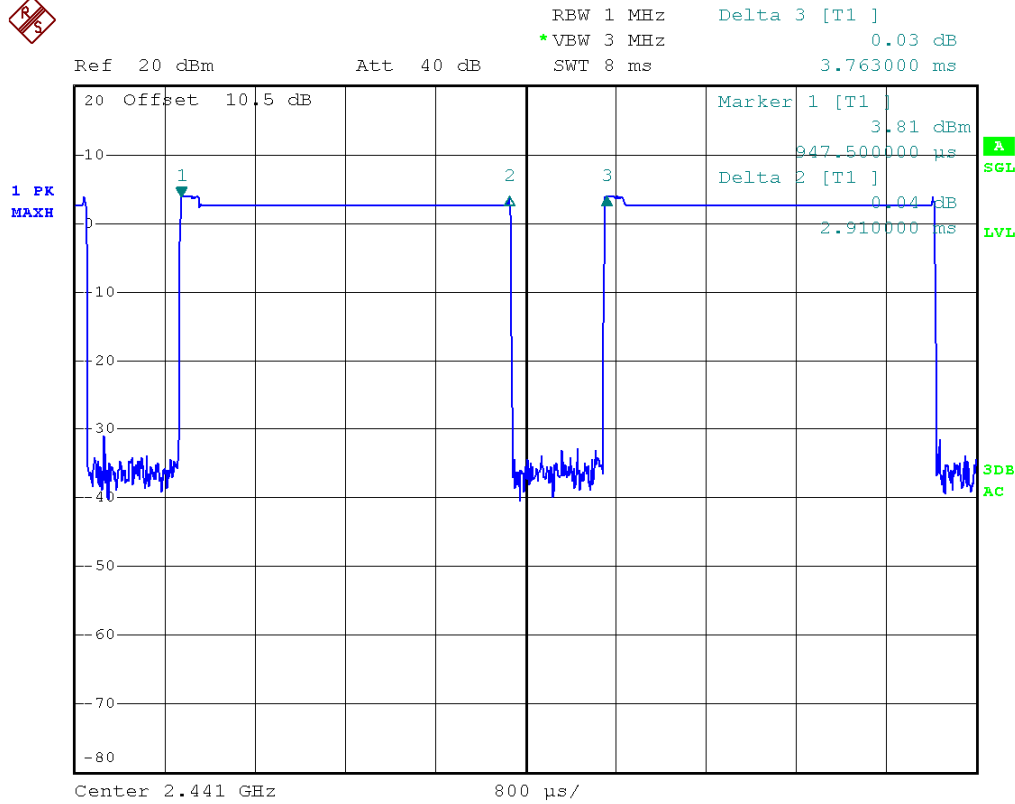

3DH1

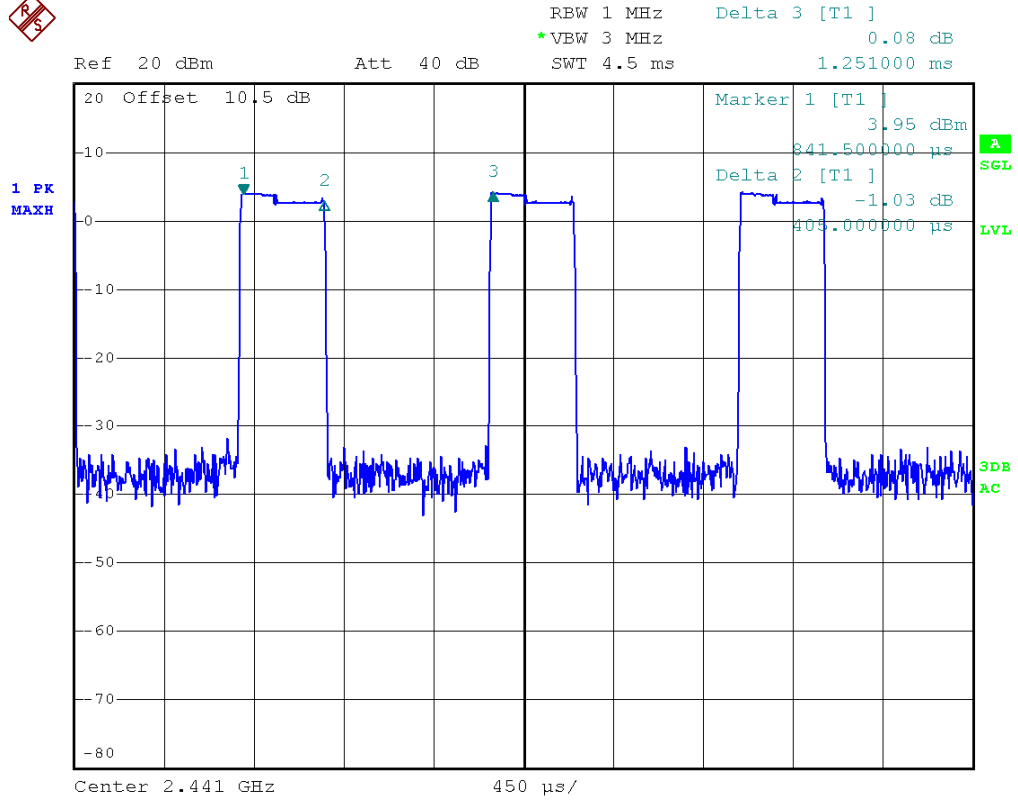

3DH3

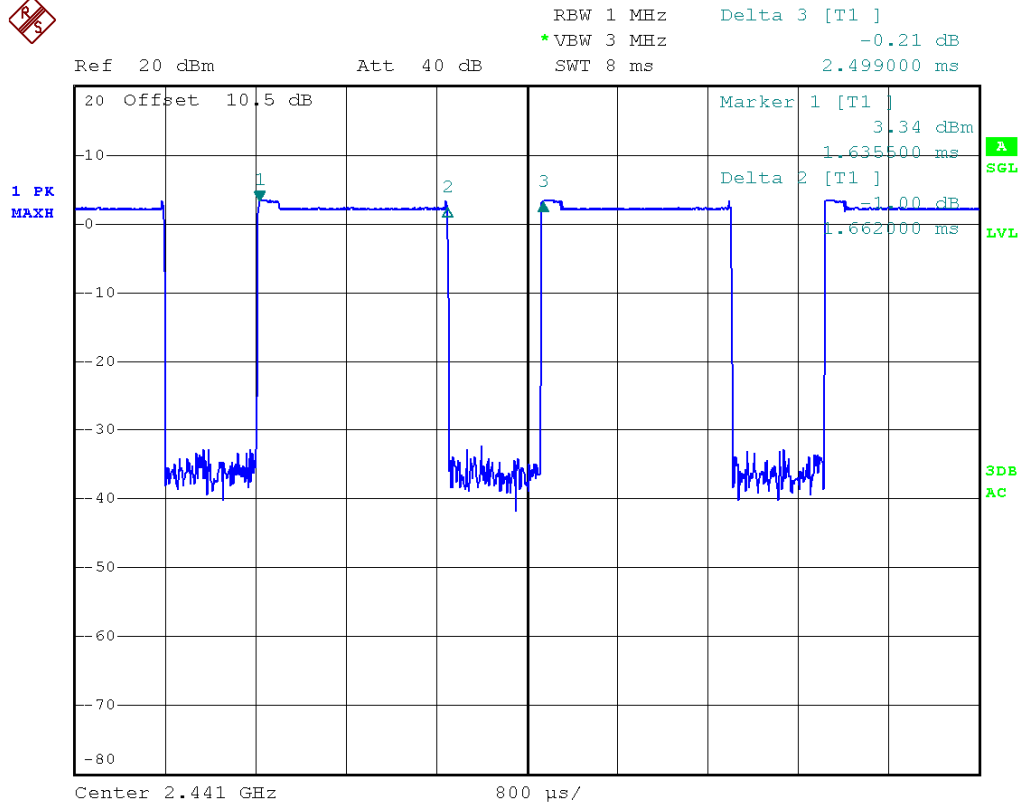

3DH5



RBW 1 MHz    Delta 3 [T1 ]  
\*VBW 3 MHz    0.27 dB  
SWT 8 ms    3.763000 ms

Ref 20 dBm

Att 40 dB

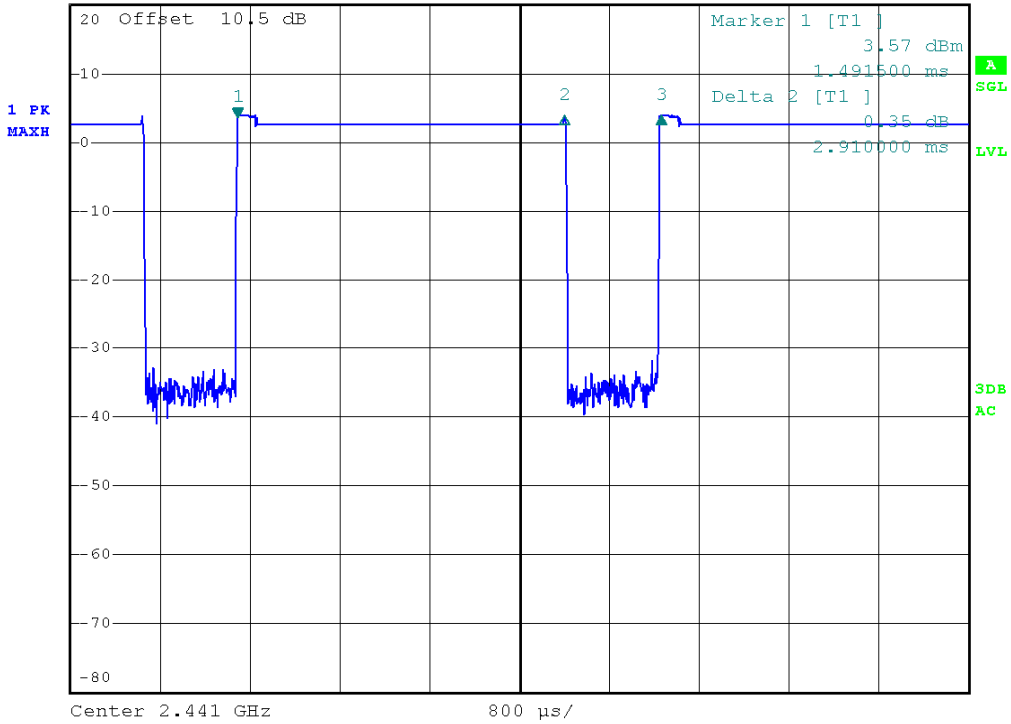

### 3. Highest channel (2.480GHz)

DH1

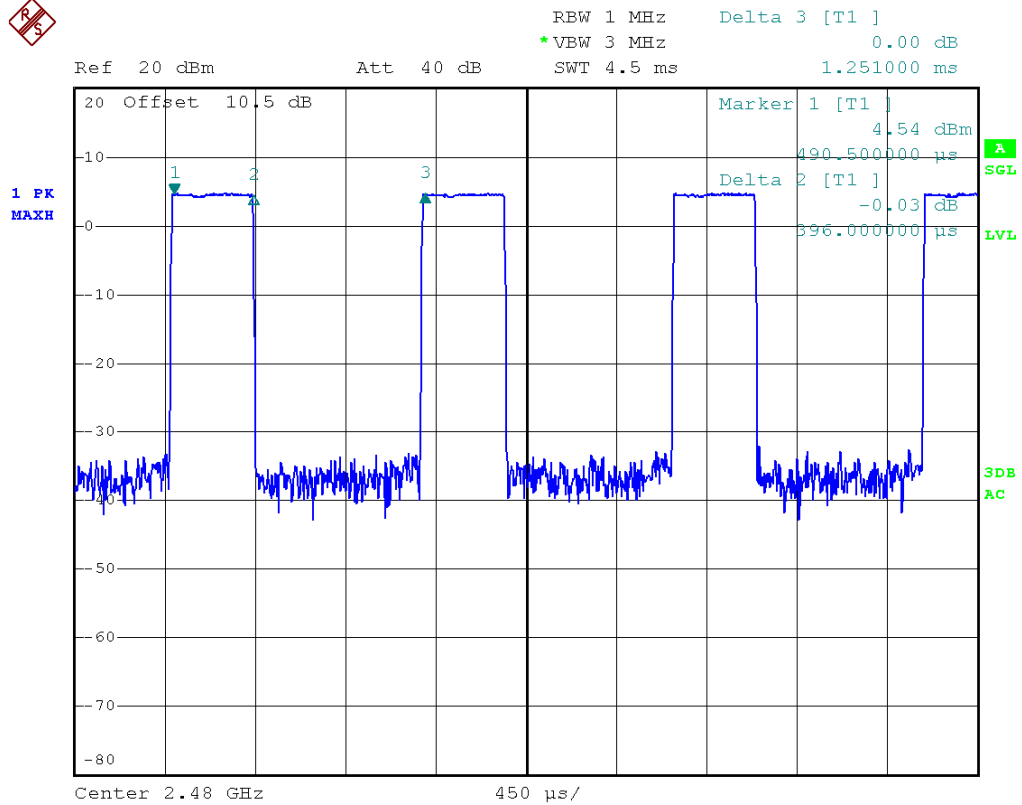

DH3

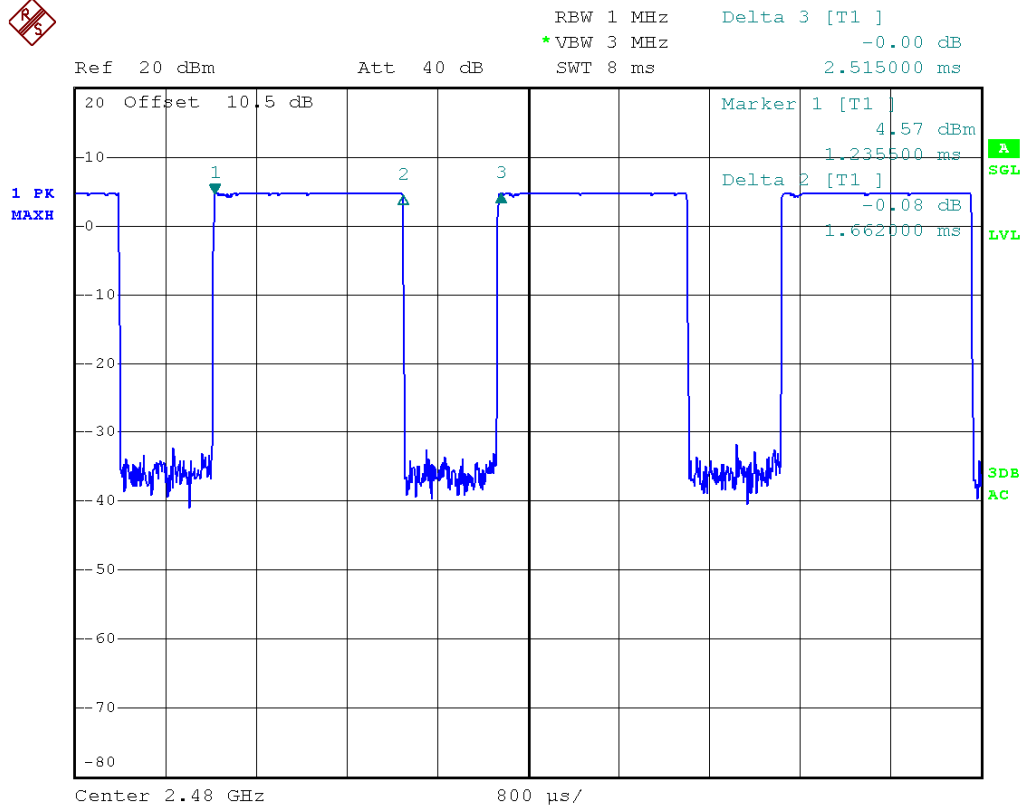

DH5

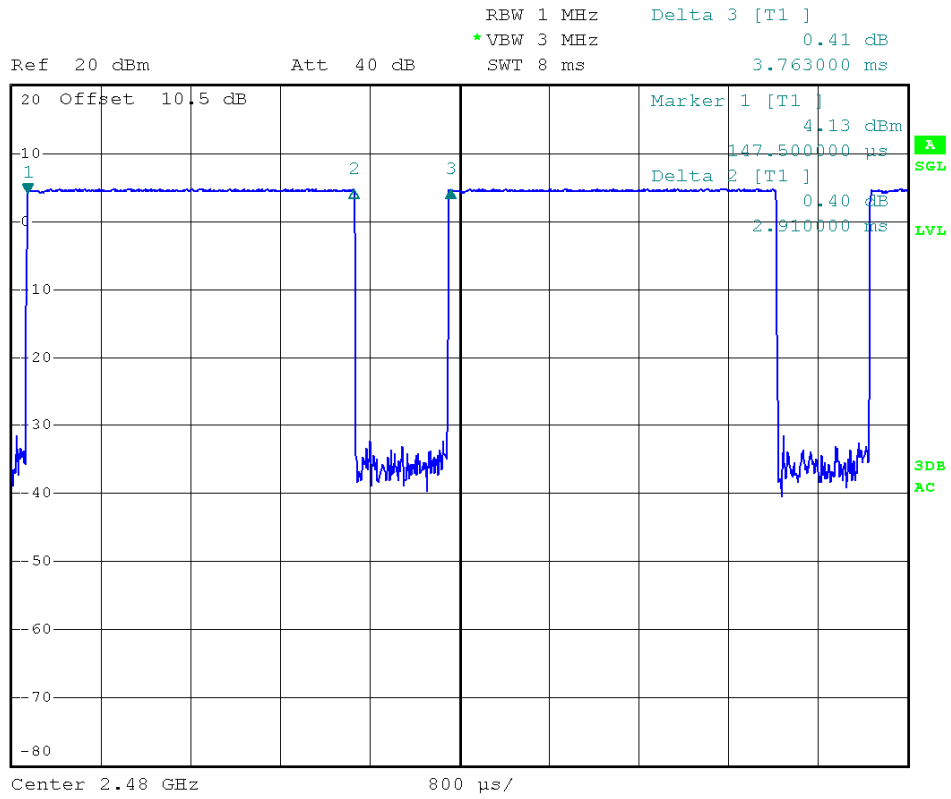

2DH1

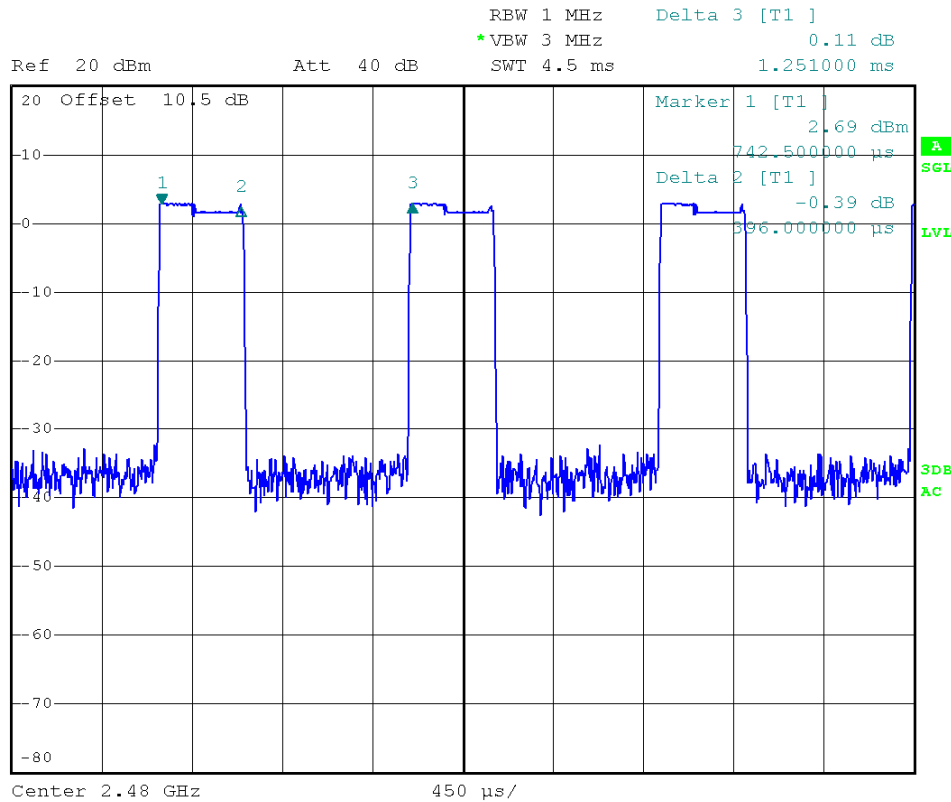

2DH3

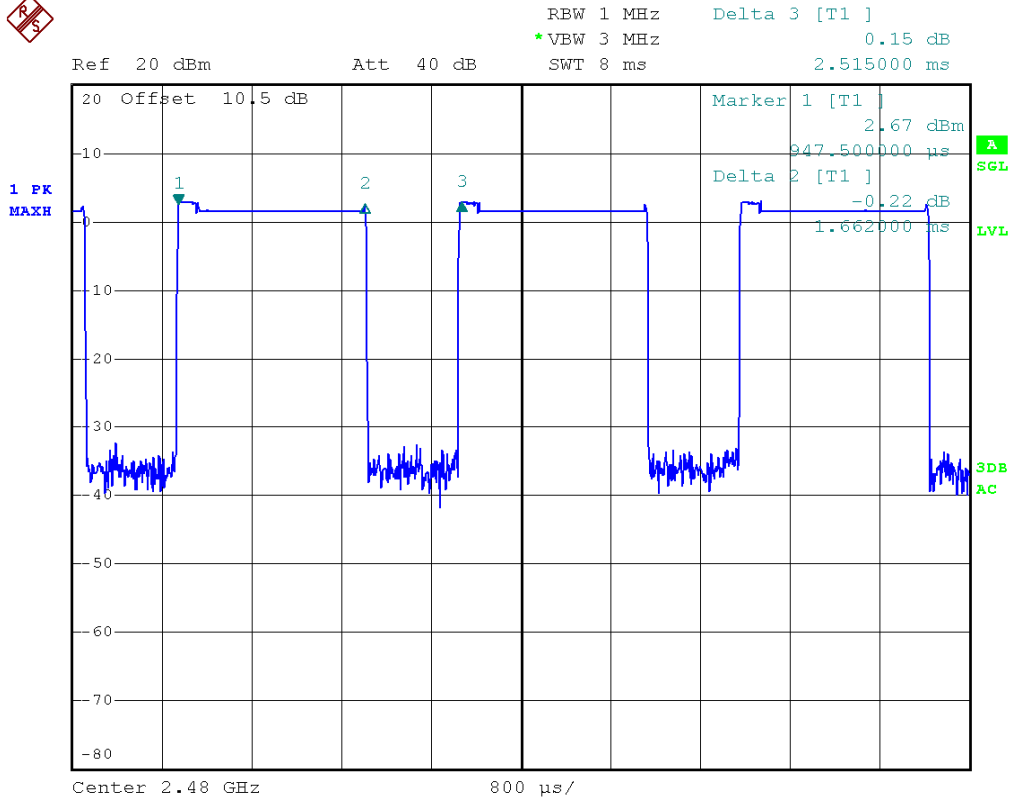

2DH5

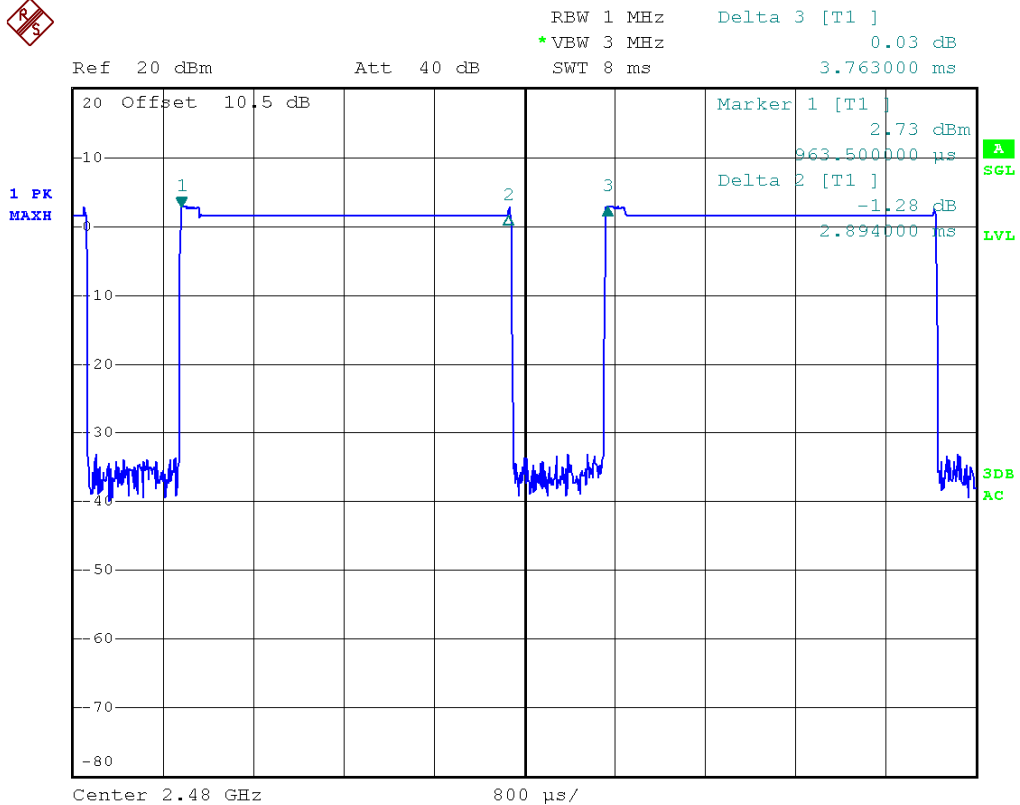

3DH1

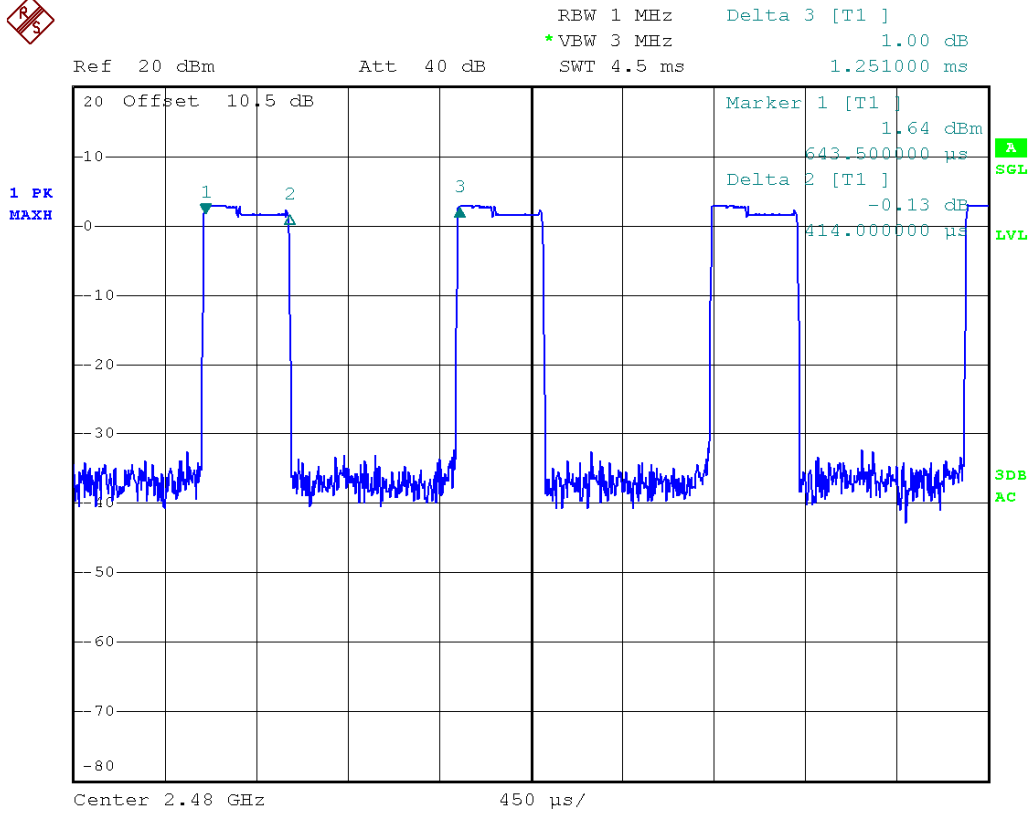

3DH3

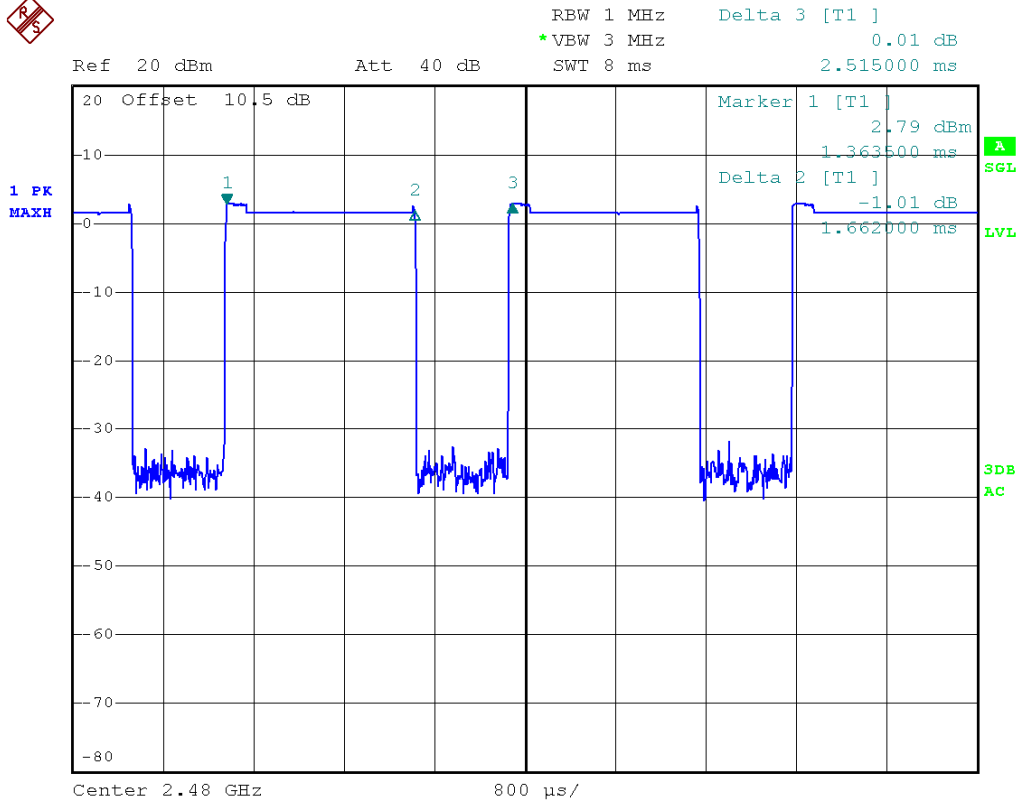

3DH5



RBW 1 MHz    Delta 3 [T1 ]  
\*VBW 3 MHz    -0.11 dB  
SWT 8 ms    3.747000 ms

Ref 20 dBm

Att 40 dB

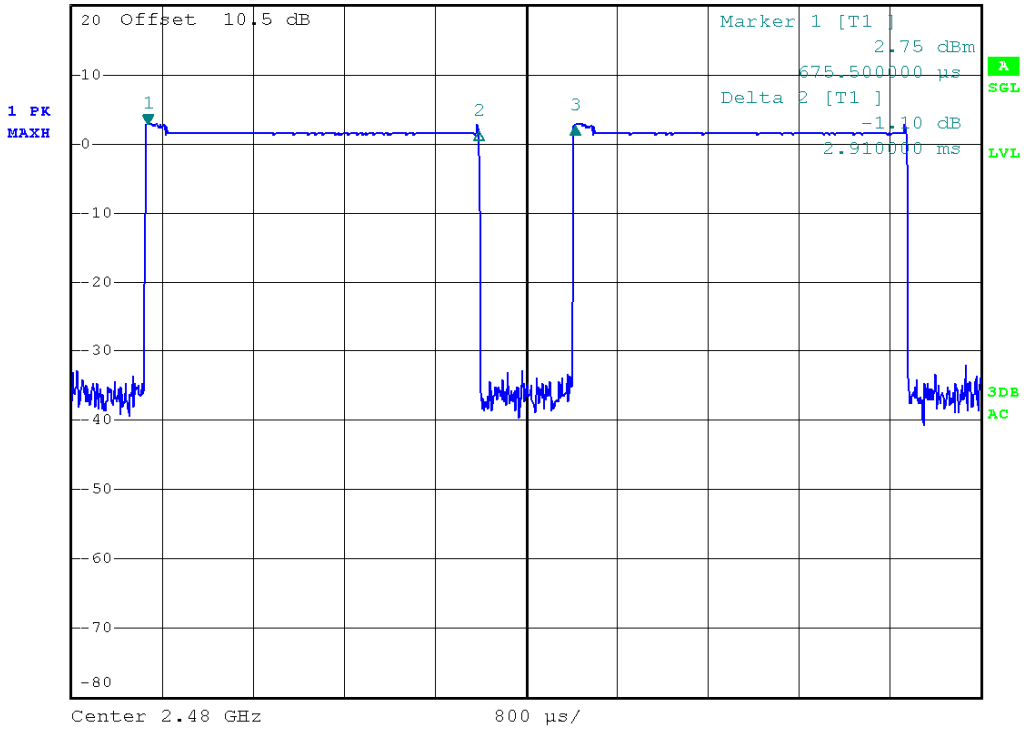

## 4.7 CONDUCTED EMISSION MEASUREMENT

### 4.7.1 LIMITS

Frequency range	Limits (dB $\mu$ V)	
	Quasi-peak	Average
150kHz ~ 0.5MHz	66 ~ 56	56 ~ 46
0.5 MHz ~ 5 MHz	56	46
5 MHz ~ 30 MHz	60	50

### 4.7.2 TEST PROCEDURES

#### Procedure of Preliminary Test

For measurement of the disturbance voltage the equipment under test (EUT) is connected to the power supply mains and any other extended network via one or more artificial network(s). An EUT, whether intended to be grounded or not, and which is to be used on a table is configured as follows:

- Either the bottom or the rear of the EUT shall be at a controlled distance of 40 cm from a reference ground plane. This ground plane is normally the wall or floor of a shielded room. It may also be a grounded metal plane of at least 2 m by 2 m. This is physically accomplished as follows:

- 1) place the EUT on a table of non-conducting material which is at least 80 cm high. Place the EUT so that it is 40 cm from the wall of the shielded room, or

- 2) place the EUT on a table of non-conducting material which is 40 cm high so that the bottom of the EUT is 40 cm above the ground plane;

- All other conductive surfaces of the EUT shall be at least 80 cm from the reference ground plane;

- The EUT are placed on the floor that one side of the housings is 40 cm from the vertical reference ground plane and other metallic parts;

- Interconnecting cables that hang closer than 40 cm to the ground plane shall be folded back and forth forming a bundle 30 cm to 40 cm long, hanging approximately in the middle between the ground plane and the table.

- I/O cables that are connected to a peripheral shall be bundled in the centre. The end of the cable may be terminated if required using correct terminating impedance. The total length shall not exceed 1 m.

The test mode(s) described in Item 2.4 were scanned during the preliminary test. After the preliminary scan, we found the test mode described in Item 2.4 producing the highest emission level. The EUT configuration and cable configuration of the above highest emission levels were recorded for reference of the final test.

#### Procedure of Final Test

EUT and support equipment were set up on the test bench as per the configuration with highest emission level in the preliminary test. A scan was taken on both power lines, recording at least the six highest emissions. Emission frequency and amplitude were recorded into a computer in which correction factors were used to calculate the emission level and compare reading to the applicable limit. The test data of the worst-case condition(s) was recorded.

### 4.7.3 TEST SETUP

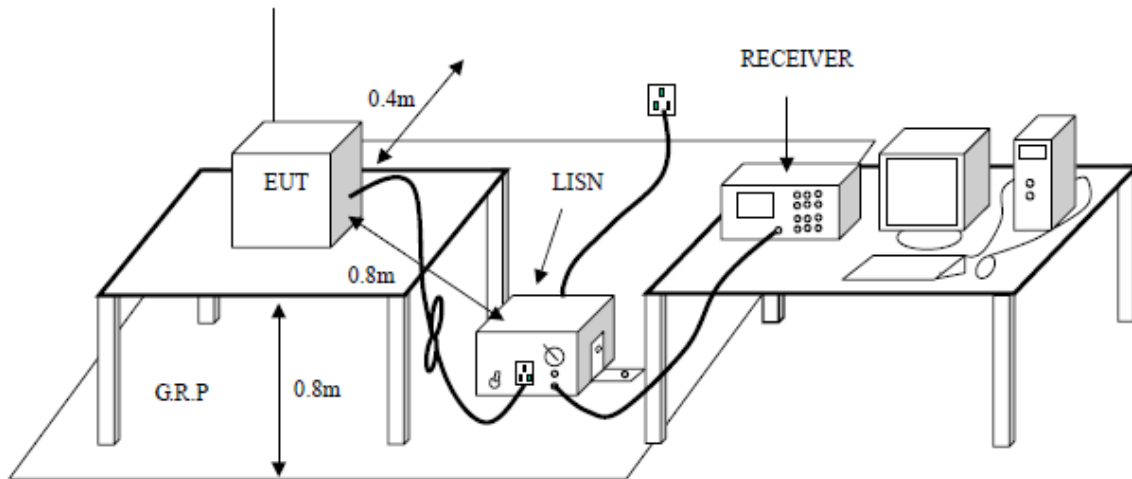

### 4.7.4 TEST RESULTS

<b>Project No.:</b>	<b>ZJ00028648</b>	<b>Probe:</b>	<b>L1</b>
<b>Standard:</b>	<b>(CE)FCC PART 15 class B_QP</b>	<b>Power Source:</b>	<b>AC 120V/60Hz</b>
<b>Test item:</b>	<b>Conduction Test</b>	<b>Date:</b>	<b>2013-5-7</b>
<b>Temp./Hum.(%RH):</b>	<b>21/53%RH</b>	<b>Time:</b>	<b>14:00:16</b>
<b>EUT:</b>	<b>JBL Wireless Speaker</b>	<b>Test Result:</b>	<b>Pass</b>
<b>Model:</b>	<b>JBL SPARK</b>		
<b>Note:</b>			

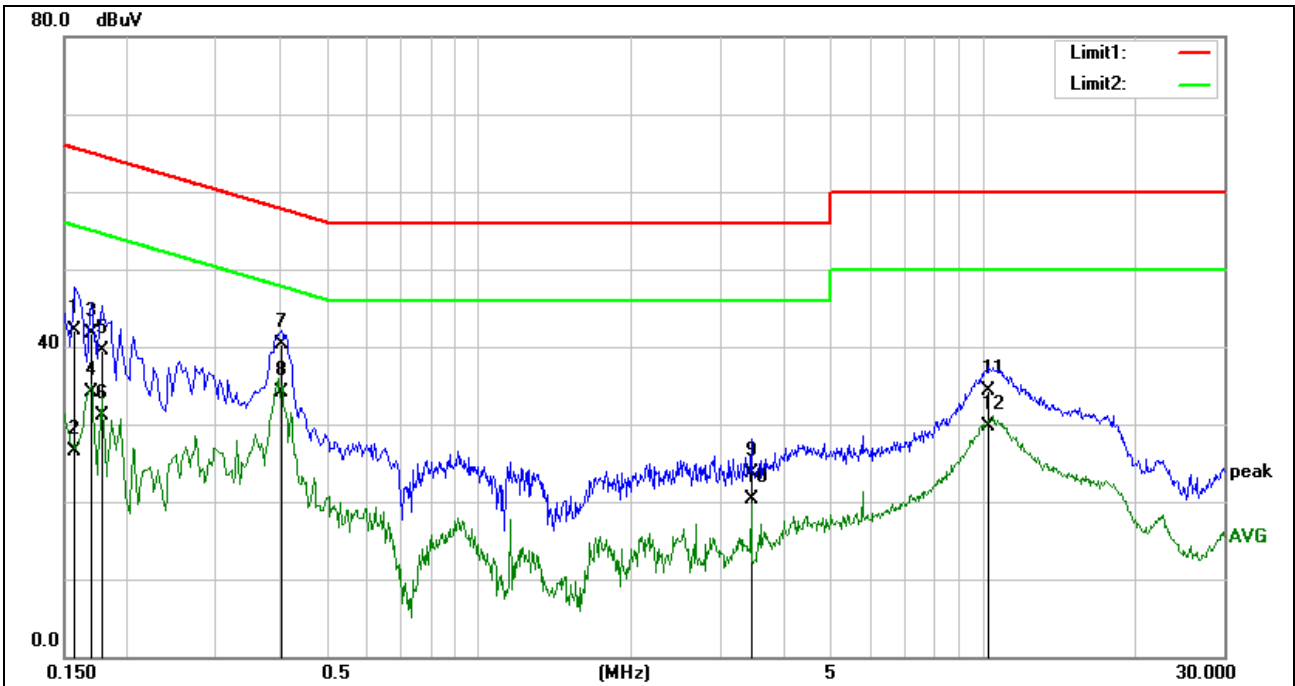

No.	Frequency (MHz)	Reading (dBuV)	Correct Factor(dB)	Result (dBuV)	Limit (dBuV)	Margin (dB)	Remark
1	0.1580	38.60	3.50	42.10	65.56	-23.46	QP
2	0.1580	23.00	3.50	26.50	55.56	-29.06	AVG
3	0.1700	38.26	3.54	41.80	64.96	-23.16	QP
4	0.1700	30.56	3.54	34.10	54.96	-20.86	AVG
5	0.1779	36.07	3.53	39.60	64.58	-24.98	QP
6	0.1779	27.67	3.53	31.20	54.58	-23.38	AVG
7	0.4060	36.79	3.51	40.30	57.73	-17.43	QP
8	0.4060	30.69	3.51	34.20	47.73	-13.53	AVG
9	3.4580	20.16	3.64	23.80	56.00	-32.20	QP
10	3.4580	16.66	3.64	20.30	46.00	-25.70	AVG
11	10.2500	30.55	3.75	34.30	60.00	-25.70	QP
12	10.2500	25.95	3.75	29.70	50.00	-20.30	AVG

<b>Project No.:</b>	<b>ZJ00028648</b>	<b>Probe:</b>	<b>N</b>
<b>Standard:</b>	<b>(CE)FCC PART 15 class B_QP</b>	<b>Power Source:</b>	<b>AC 120V/60Hz</b>
<b>Test item:</b>	<b>Conduction Test</b>	<b>Date:</b>	<b>2013-5-7</b>
<b>Temp./Hum.(%RH):</b>	<b>21/53%RH</b>	<b>Time:</b>	<b>13:53:21</b>
<b>EUT:</b>	<b>JBL Wireless Speaker</b>	<b>Test Result:</b>	<b>Pass</b>
<b>Model:</b>	<b>JBL SPARK</b>		
<b>Note:</b>			

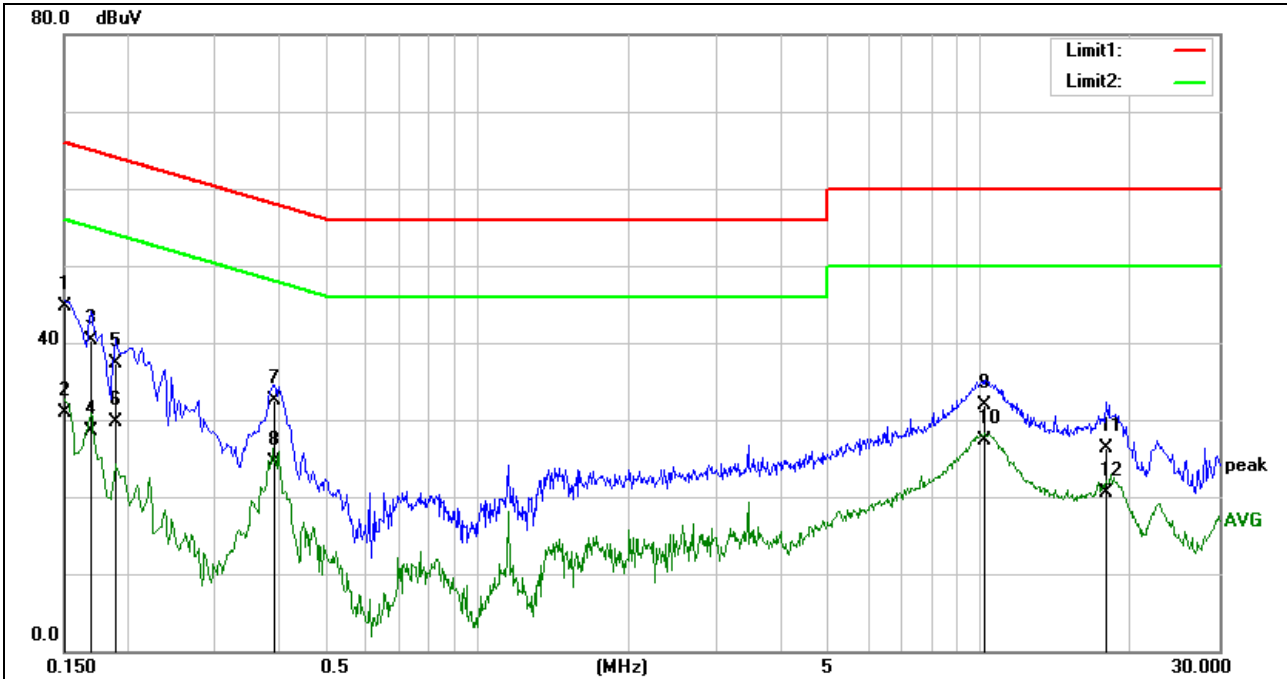

No.	Frequency (MHz)	Reading (dBuV)	Correct Factor(dB)	Result (dBuV)	Limit (dBuV)	Margin (dB)	Remark
1	0.1500	41.22	3.48	44.70	65.99	-21.29	QP
2	0.1500	27.42	3.48	30.90	55.99	-25.09	AVG
3	0.1700	36.76	3.54	40.30	64.96	-24.66	QP
4	0.1700	24.96	3.54	28.50	54.96	-26.46	AVG
5	0.1900	33.79	3.51	37.30	64.03	-26.73	QP
6	0.1900	26.29	3.51	29.80	54.03	-24.23	AVG
7	0.3940	28.99	3.51	32.50	57.98	-25.48	QP
8	0.3940	21.09	3.51	24.60	47.98	-23.38	AVG
9	10.1980	28.25	3.75	32.00	60.00	-28.00	QP
10	10.1980	23.55	3.75	27.30	50.00	-22.70	AVG
11	17.9220	22.26	4.04	26.30	60.00	-33.70	QP
12	17.9220	16.46	4.04	20.50	50.00	-29.50	AVG

## 4.8 MAXIMUM PEAK OUTPUT POWER

### 4.8.1 LIMITS

Regulation 15.247 (b)(1) For frequency hopping systems operating in the 2400-2483.5 MHz band employing at least 75 non-overlapping hopping channels, and all frequency hopping systems in the 5725-5850 MHz band: 1 watt. For all other frequency hopping systems in the 2400-2483.5 MHz band: 0.125 watts. Refer to the result “Hopping channel number” of this document. The 1 watt (30.0dBm) limit applies.

### 4.8.2 TEST PROCEDURES

- 1 . Remove the antenna from the EUT and then connect a low RF cable from the antenna port to the spectrum.
- 2 . Set the spectrum analyzer: RBW = 1 MHz. VBW = 3 MHz. Sweep = auto; Detector Function = Peak.
- 3 . Keep the EUT in transmitting at lowest, medium and highest channel individually. Record the max value.

**Remark:**

1. Pre-test the 3 modulation to find GFSK and 8DPSK is worse case, so only record GFSK and 8DPSK test data.
2. Cable loss = 0.5dB , the receiver offset loss 0.5dB

### 4.8.3 TEST SETUP

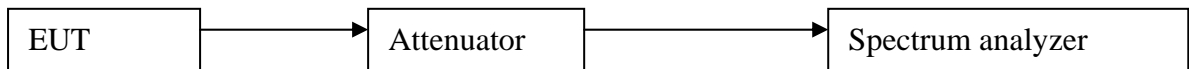

### 4.8.4 TEST RESULTS

For GFSK:

Test Channel	Fundamental Frequency (GHz)	Max Output Power(dBm)	Antenna Gain(dBi)	e. r.p. (dBm)	Limit (dBm)	Pass/Fail
Lowest	2.402	5.64	-2	3.64	30.0	Pass
Middle	2.441	5.39	-2	3.39	30.0	Pass
Highest	2.480	3.78	-2	1.78	30.0	Pass

For 8DPSK:

Test Channel	Fundamental Frequency (GHz)	Max Output Power(dBm)	Antenna Gain(dBi)	e. r.p. (dBm)	Limit (dBm)	Pass/Fail
Lowest	2.402	4.27	-2	2.27	30.0	Pass
Middle	2.441	3.91	-2	2.91	30.0	Pass
Highest	2.480	2.68	-2	0.68	30.0	Pass

Test result: The unit does meet the FCC requirements.

Test result plot as follows:

GFSK Lowest Channel:

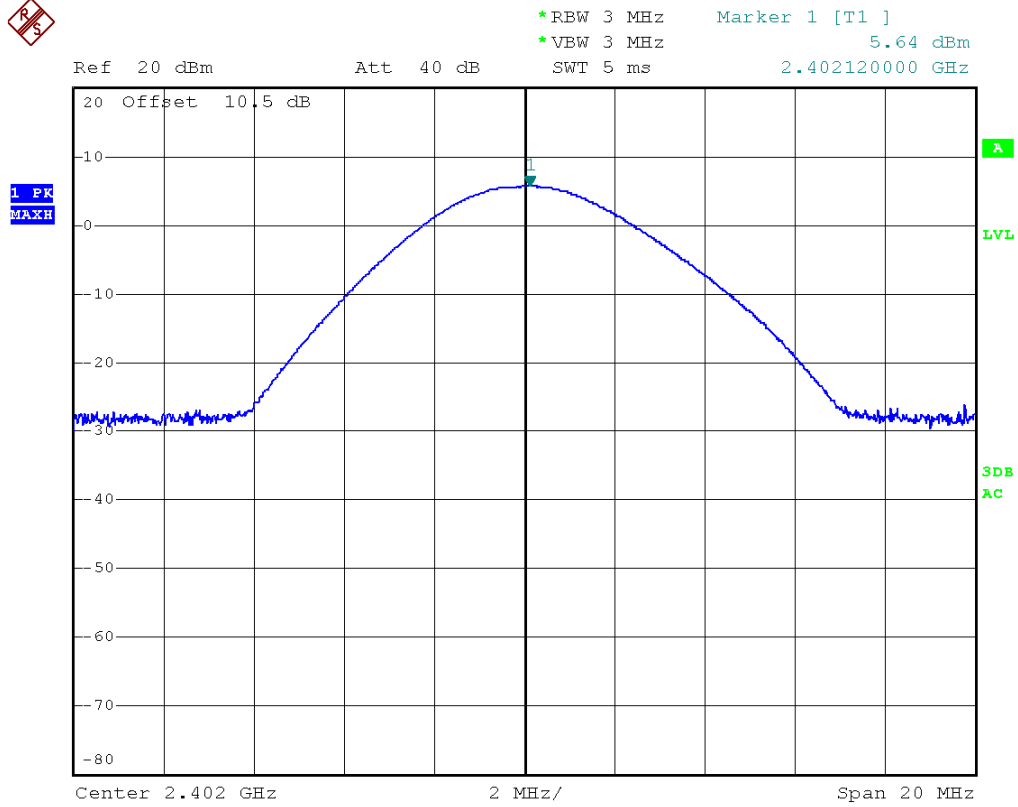

GFSK Middle Channel:

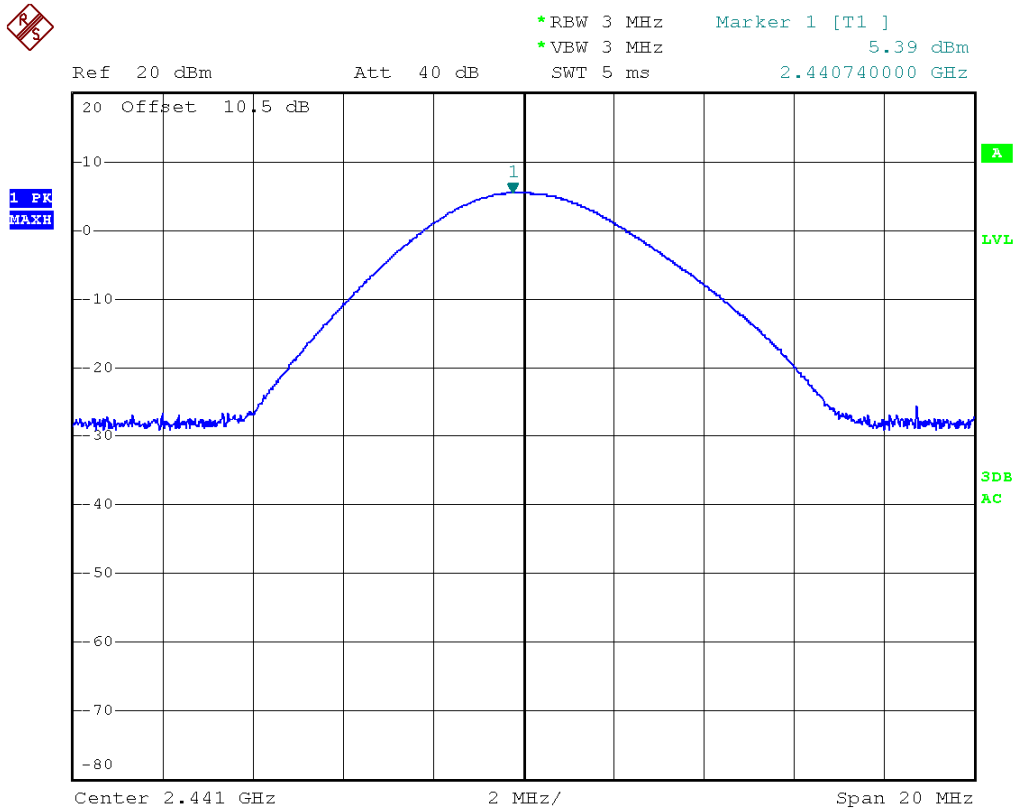

GFSK Highest Channel:

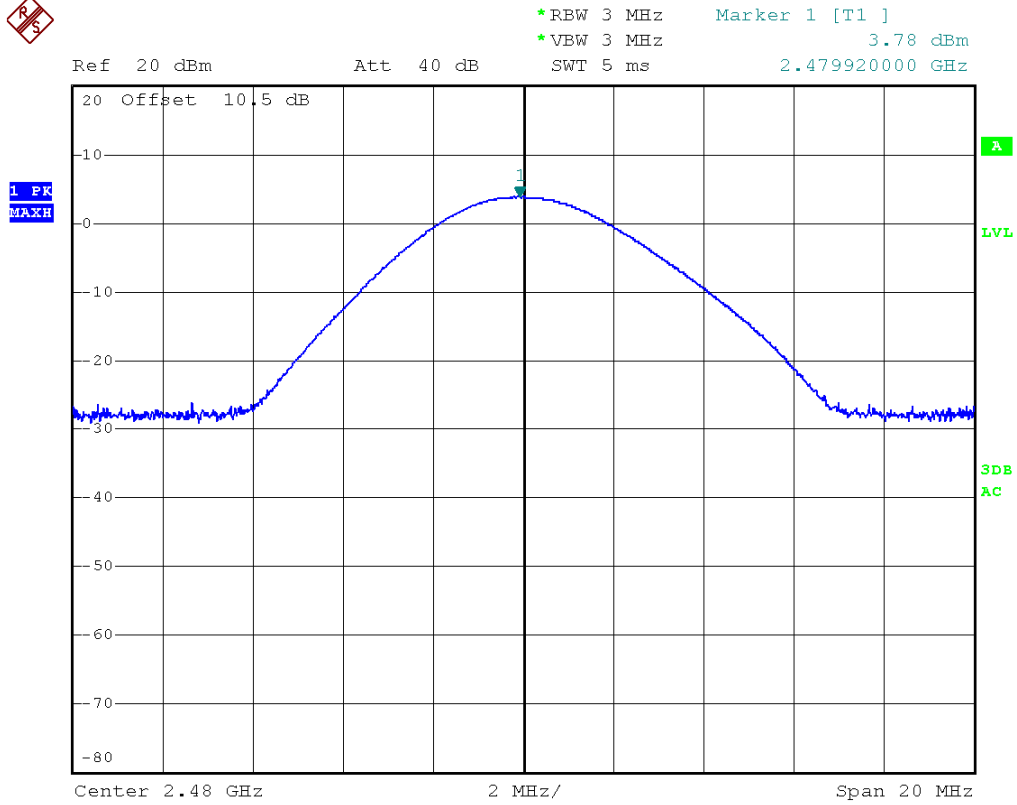

8DPSK Lowest Channel:

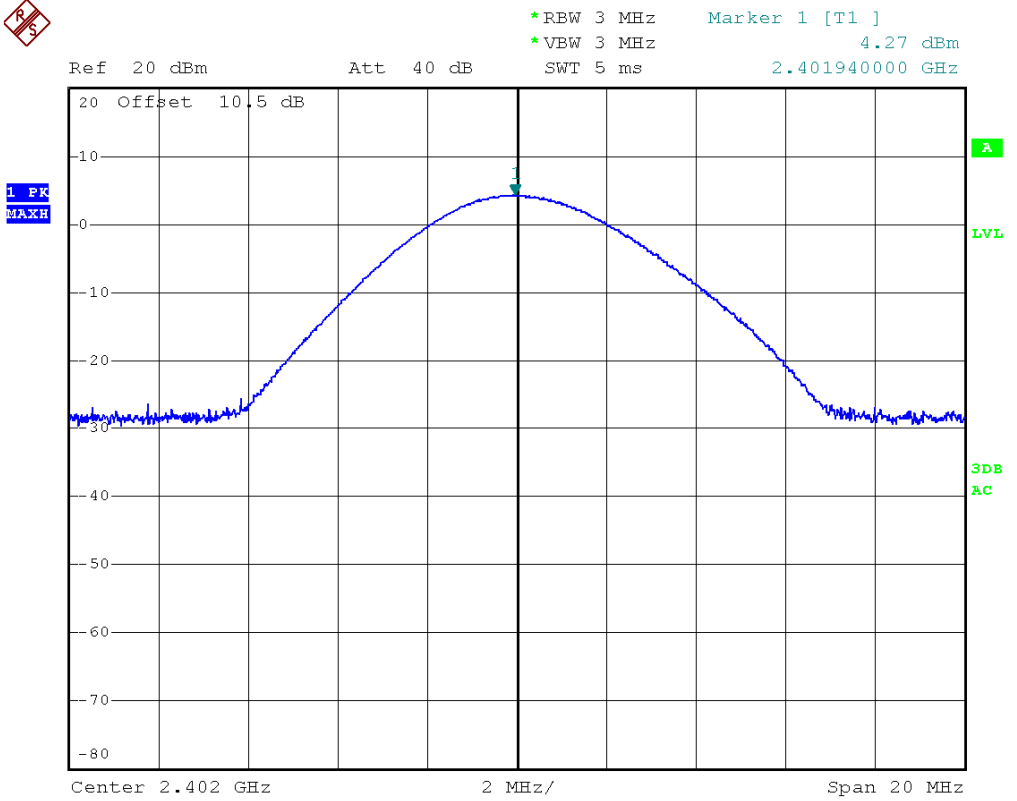

8DPSK Middle Channel:

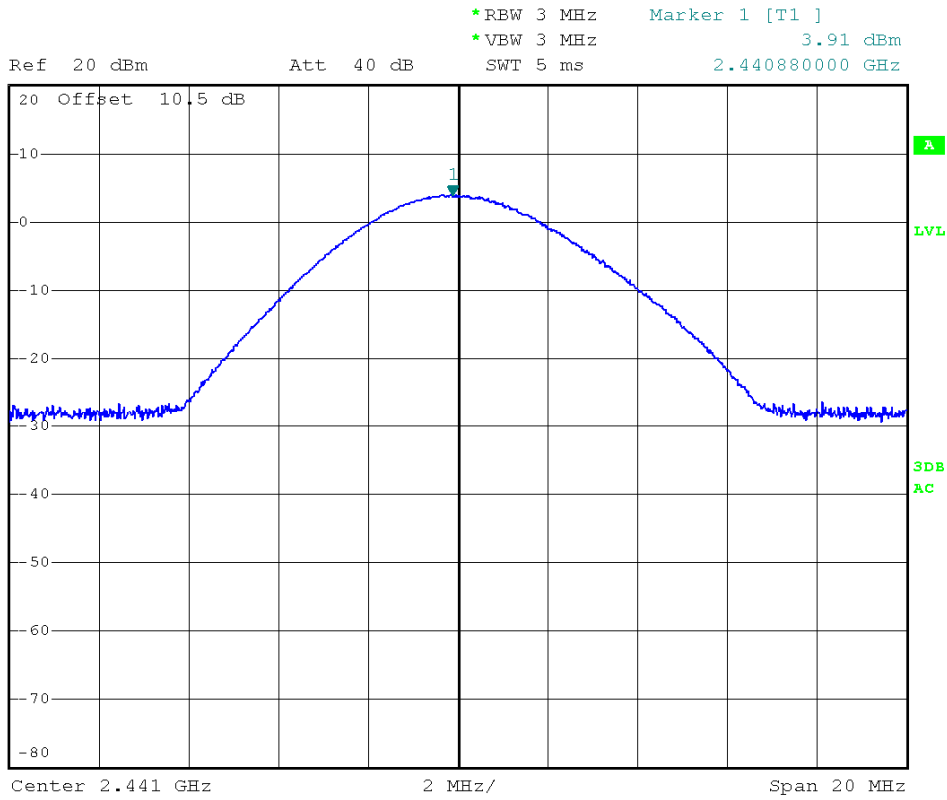

8DPSK Highest Channel:

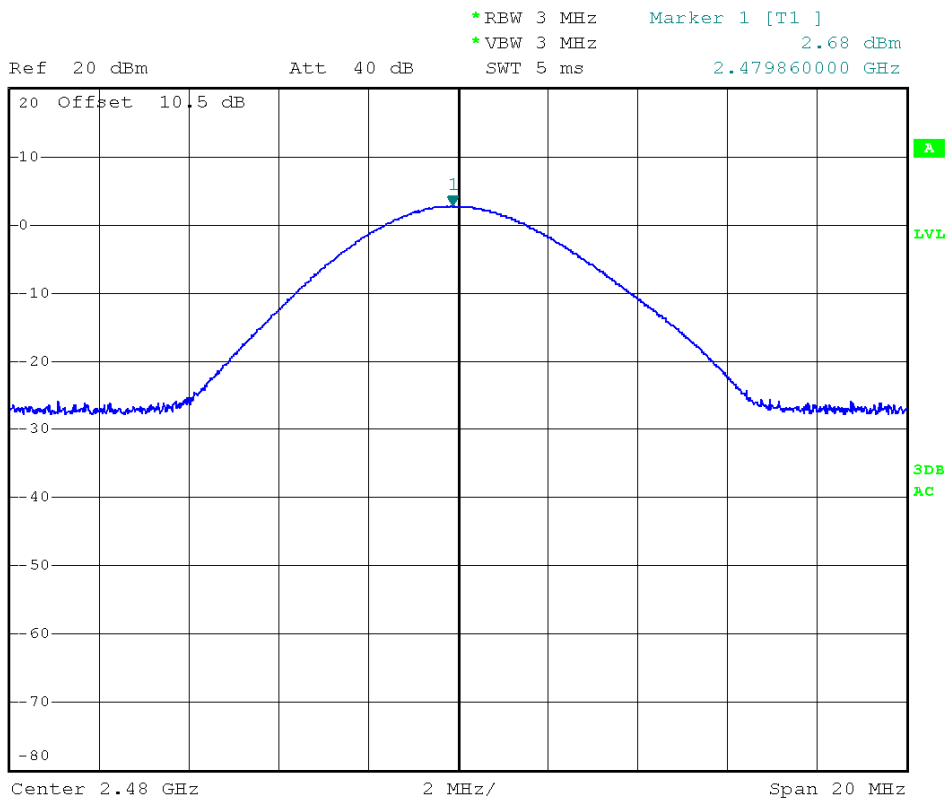

## 4.9 CONDUCTED SPURIOUS EMISSIONS

### 4.9.1 LIMITS

(d) In any 100 kHz bandwidth outside the frequency band in which the spread spectrum or digitally modulated intentional radiator is operating. The radio frequency power that is produced by the intentional radiator shall be at least 20 dB below that in the 100 kHz bandwidth within the band that contains the highest level of the desired power. based on either an RF conducted or a radiated measurement. Provided the transmitter demonstrates compliance with the peak conducted power limits.

### 4.9.2 TEST PROCEDURES

Remove the antenna from the EUT and then connect a low attenuation cable from the antenna port to the spectrum.

Below 1GHz Set the spectrum analyzer: RBW =100KHz VBW  $\geq$  RBW, Span = enough to catch the trace. Sweep = auto; Detector Function = Peak. Trace = Max,hold.

Above 1GHz Set the spectrum analyzer: RBW =1MHz VBW  $\geq$  RBW , Span = enough to catch the trace. Sweep = auto; Detector Function = Peak. Trace = Max,hold.

### 4.9.3 TEST SETUP

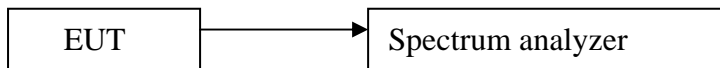

### 4.9.4 TEST RESULTS

**The unit does meet the FCC requirements.**

Test result plot as follows:

For GFSK

Lowest Channel:

30M to 1GHz

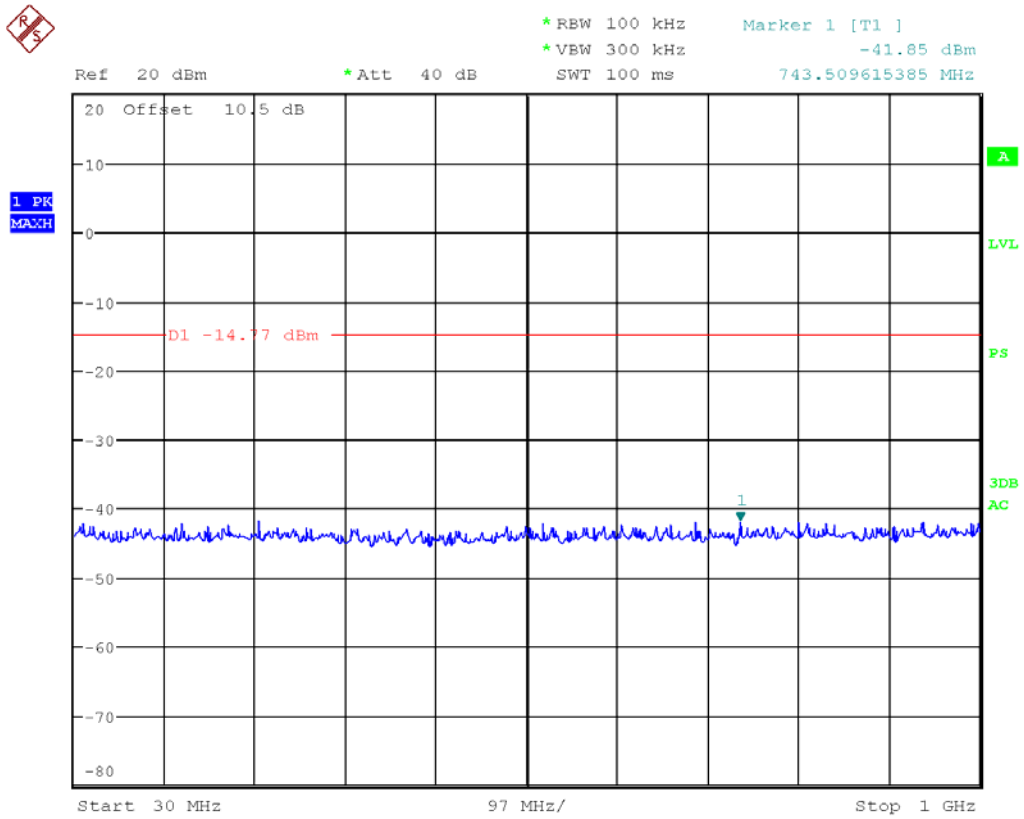

1G to 10GHz

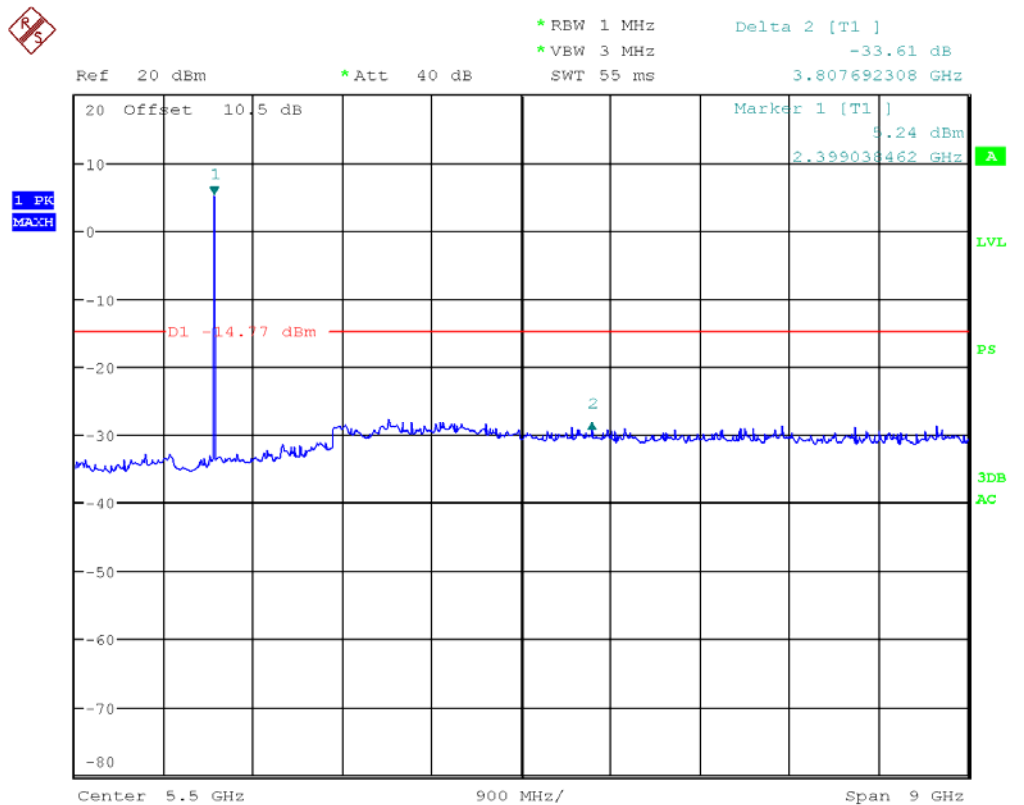

10G to 25GHz

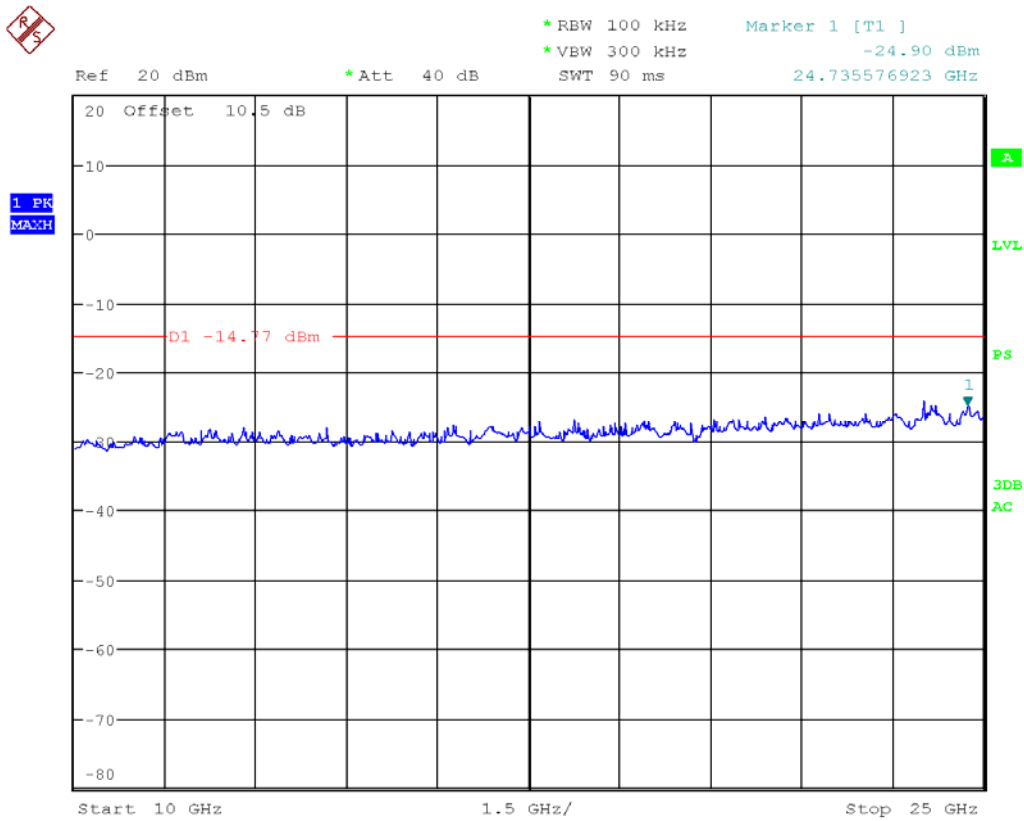

Middle Channel:

30M to 1GHz

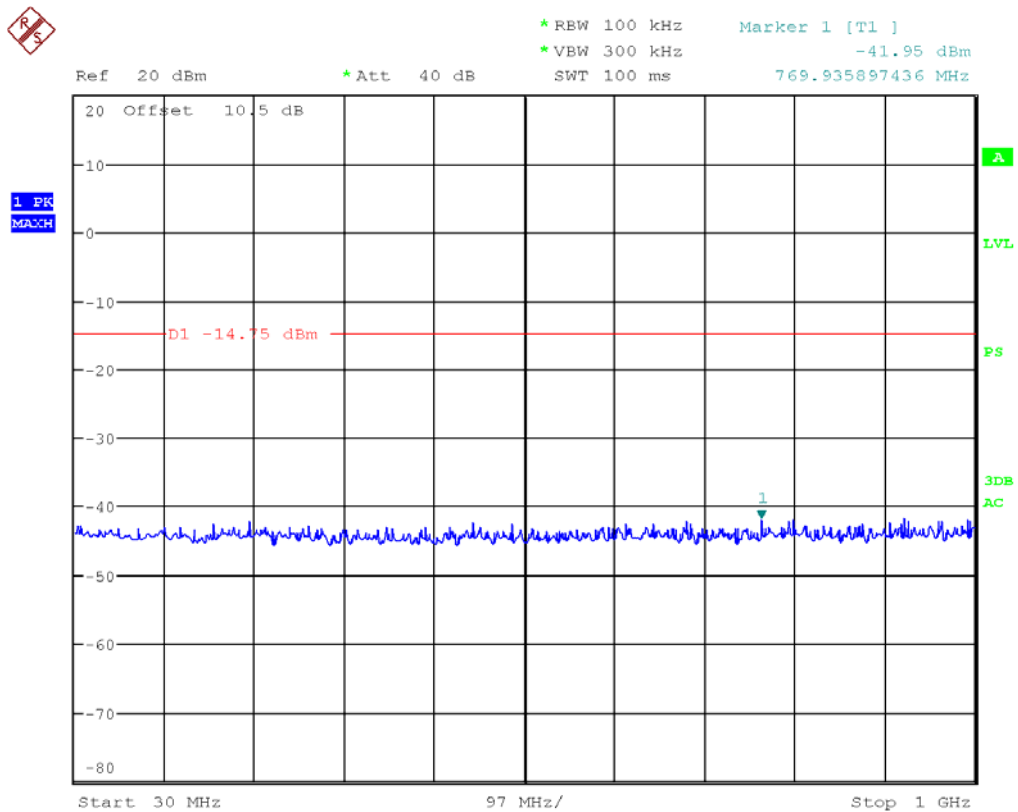

1G to 10GHz

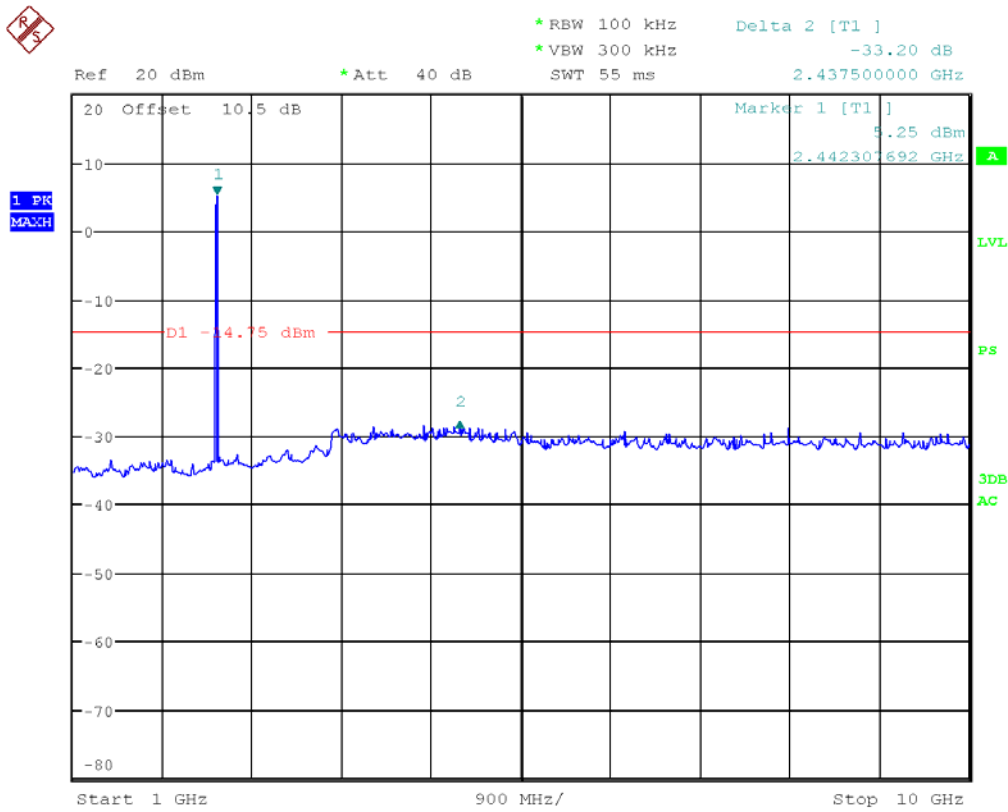

10G to 25GHz

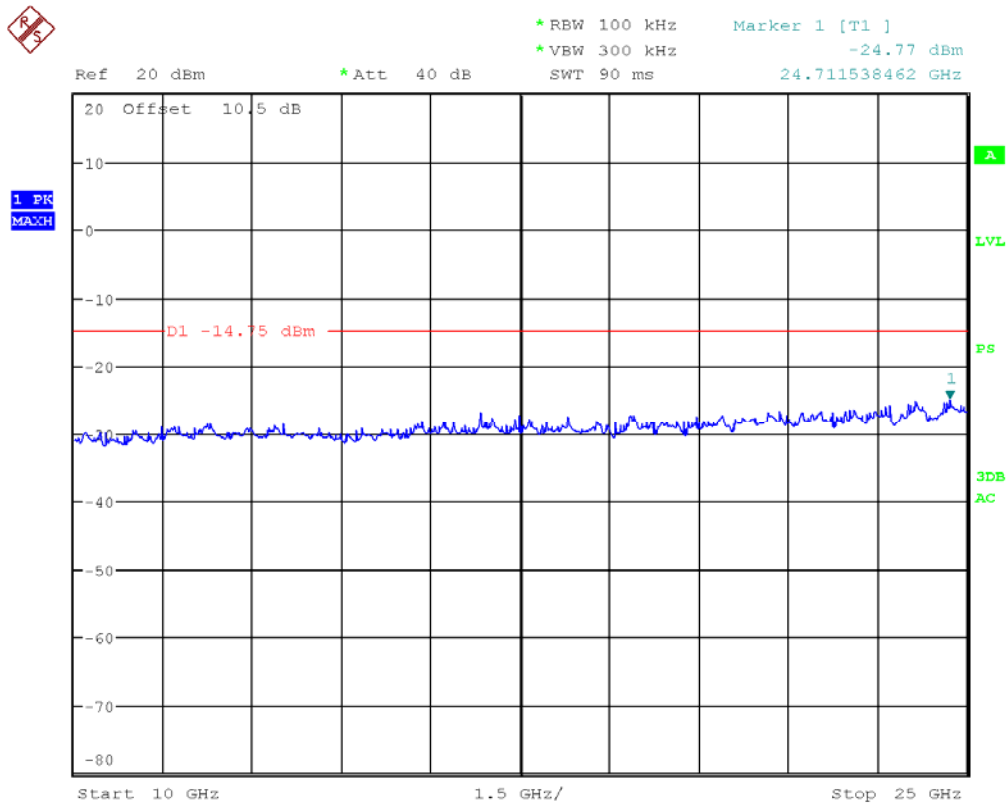

### Highest Channel

### 30M to 1GHz

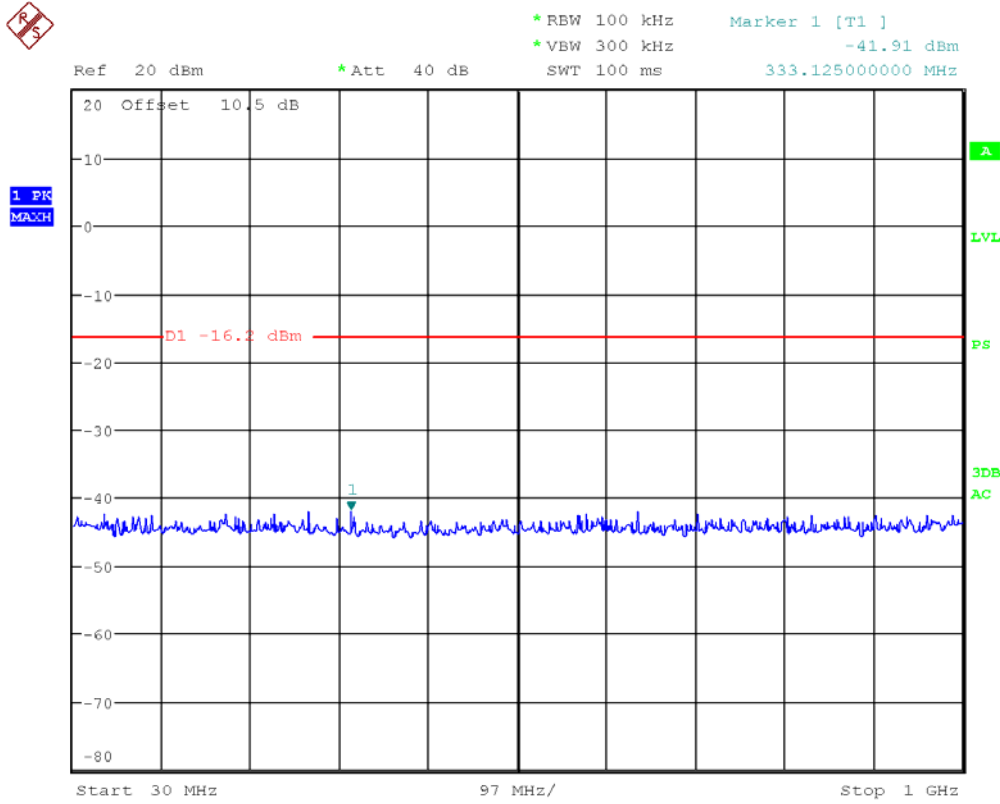

### 1G to 10GHz

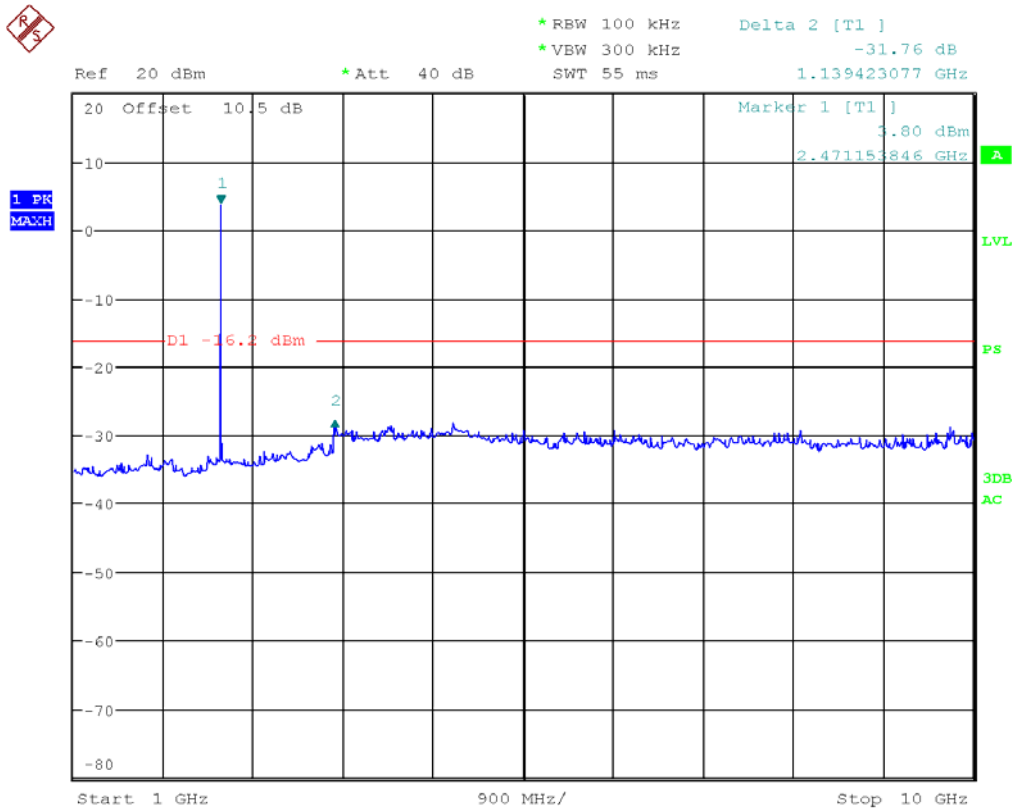

10G to 25GHz

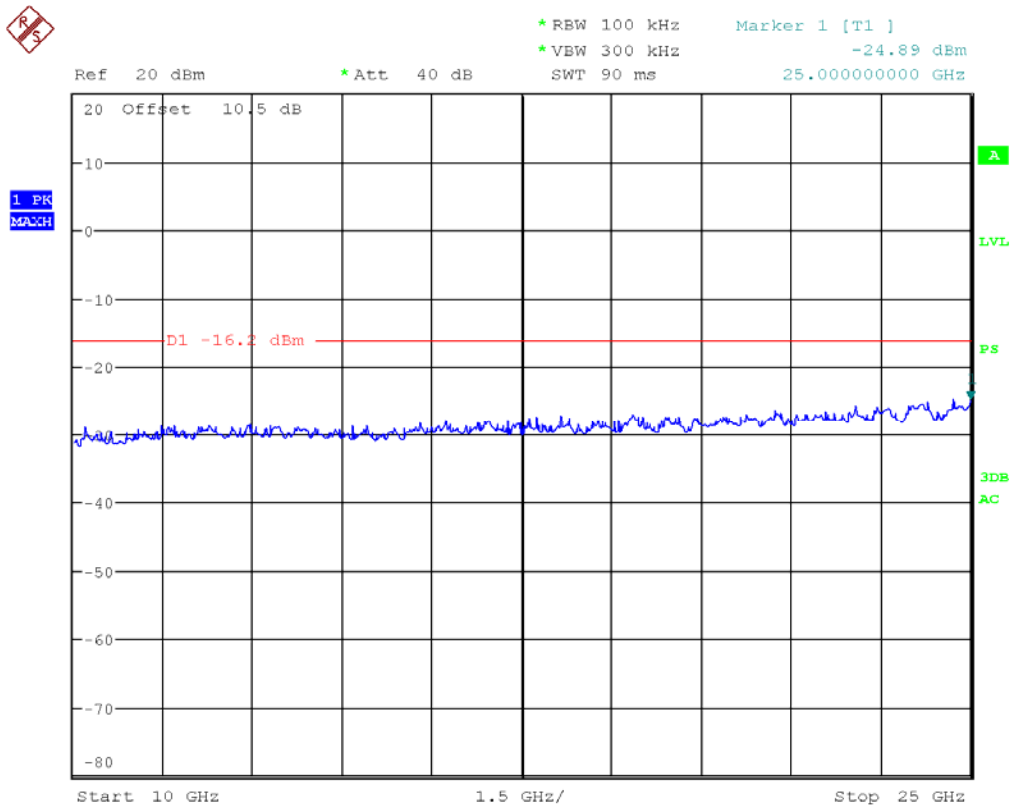

For 8DPSK

Lowest Channel:

30M to 1GHz

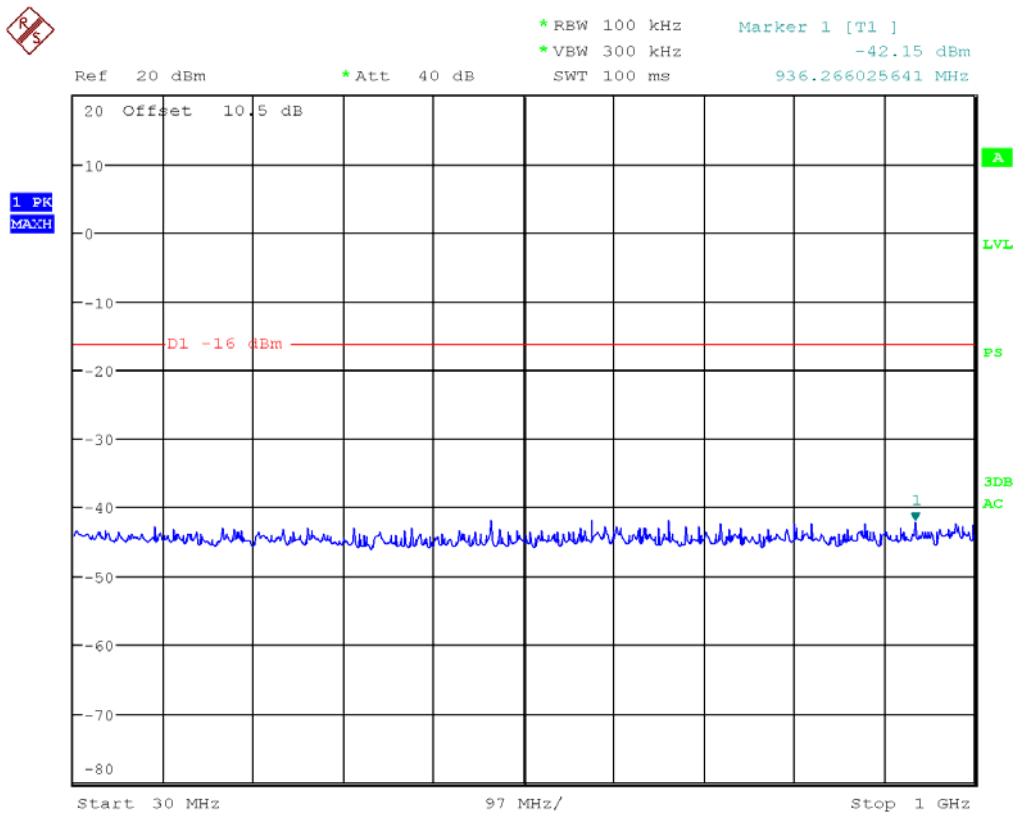

1G to 10GHz

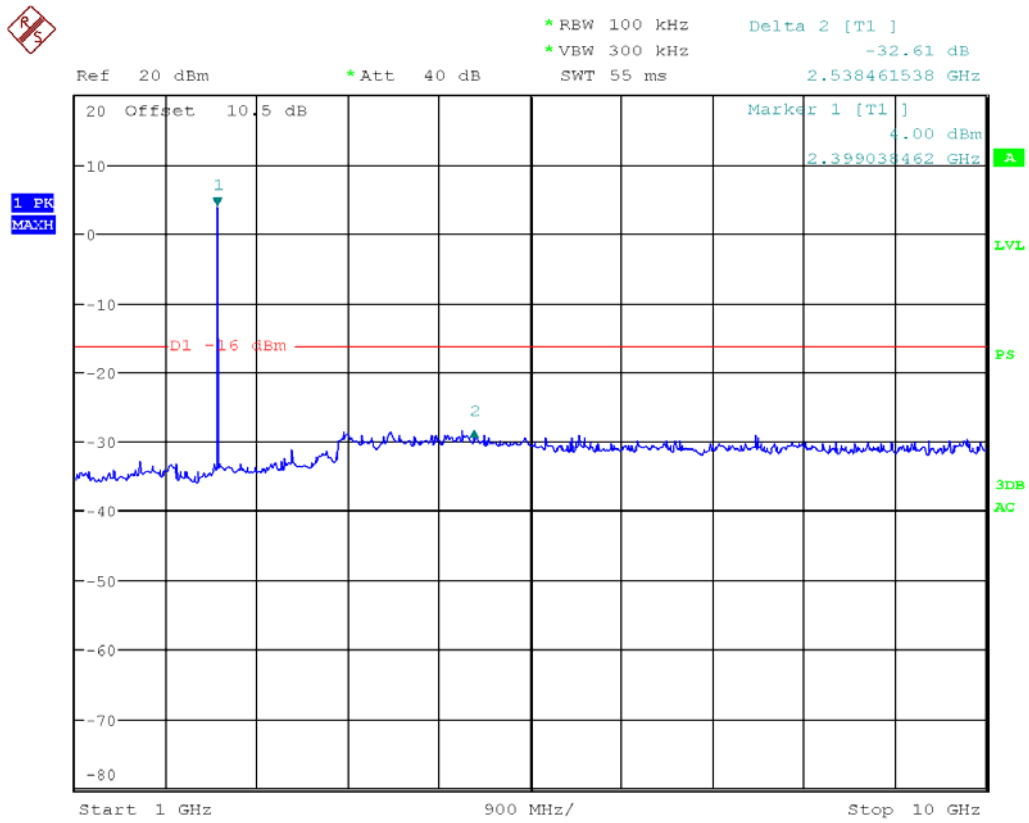

10G to 25GHz

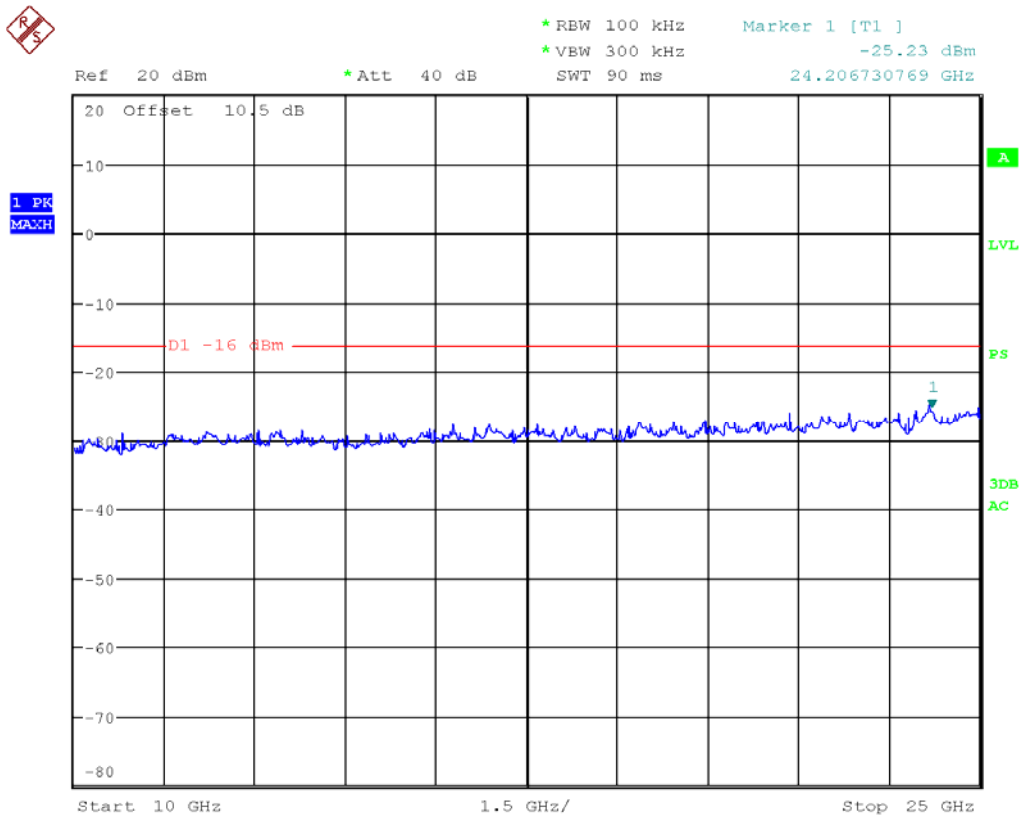

Middle Channel:

30M to 1GHz

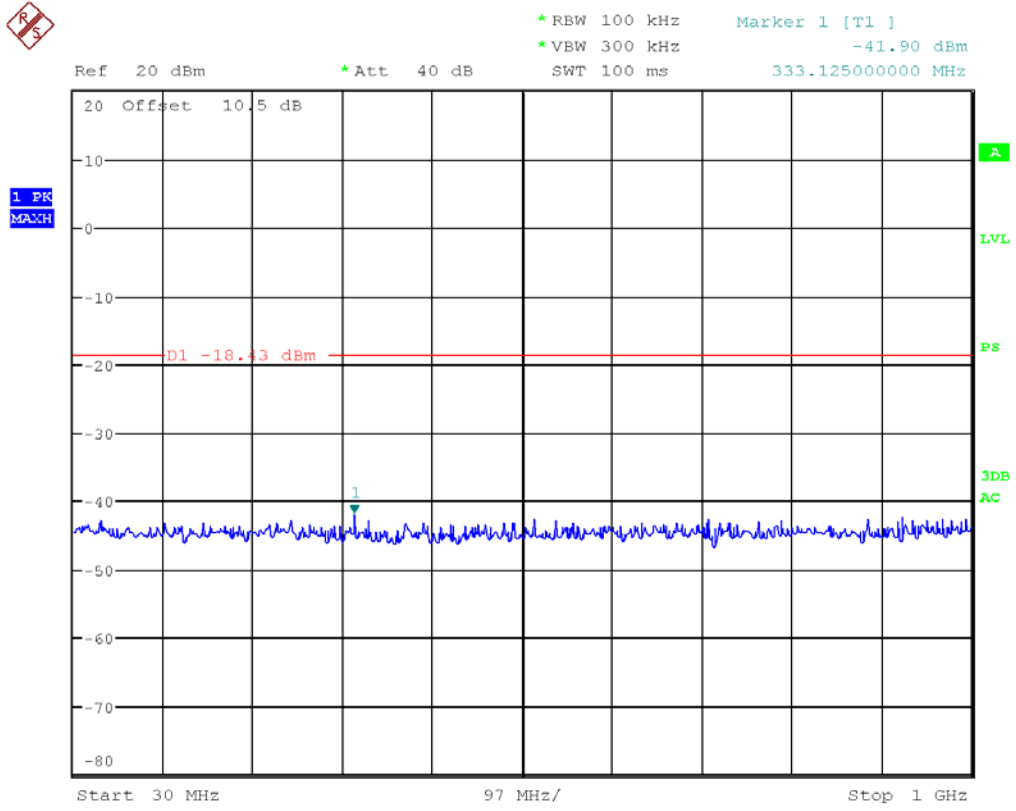

1G to 10GHz

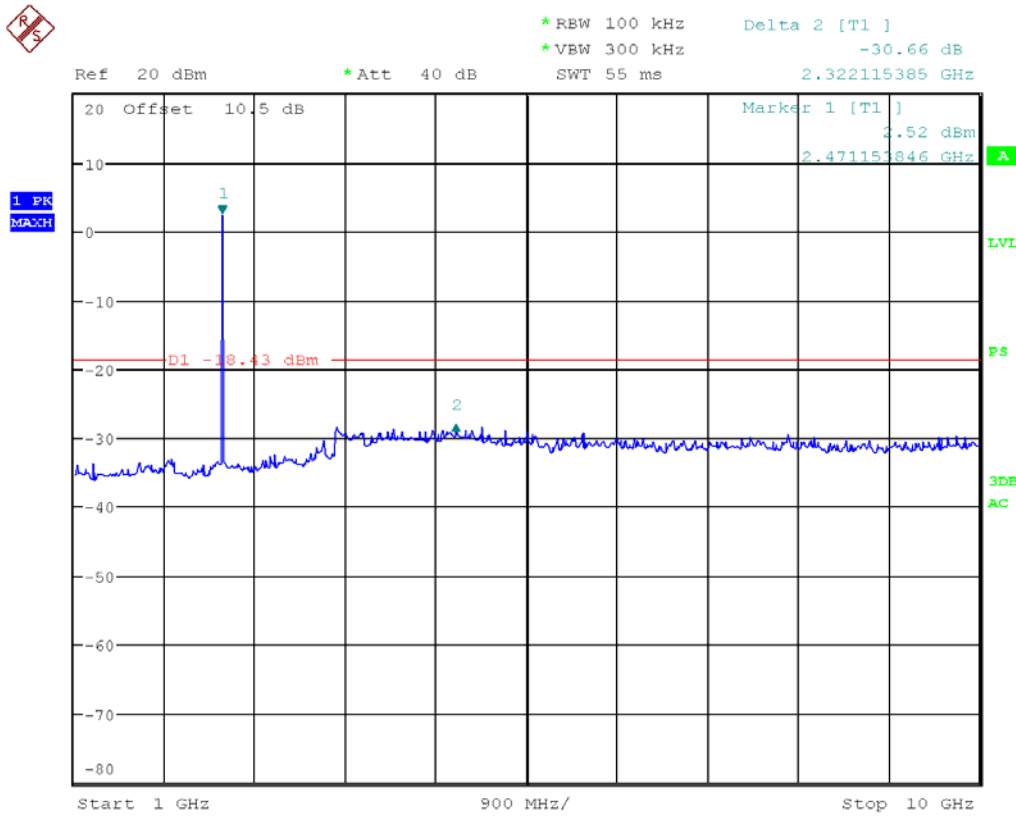

### 10G to 25GHz

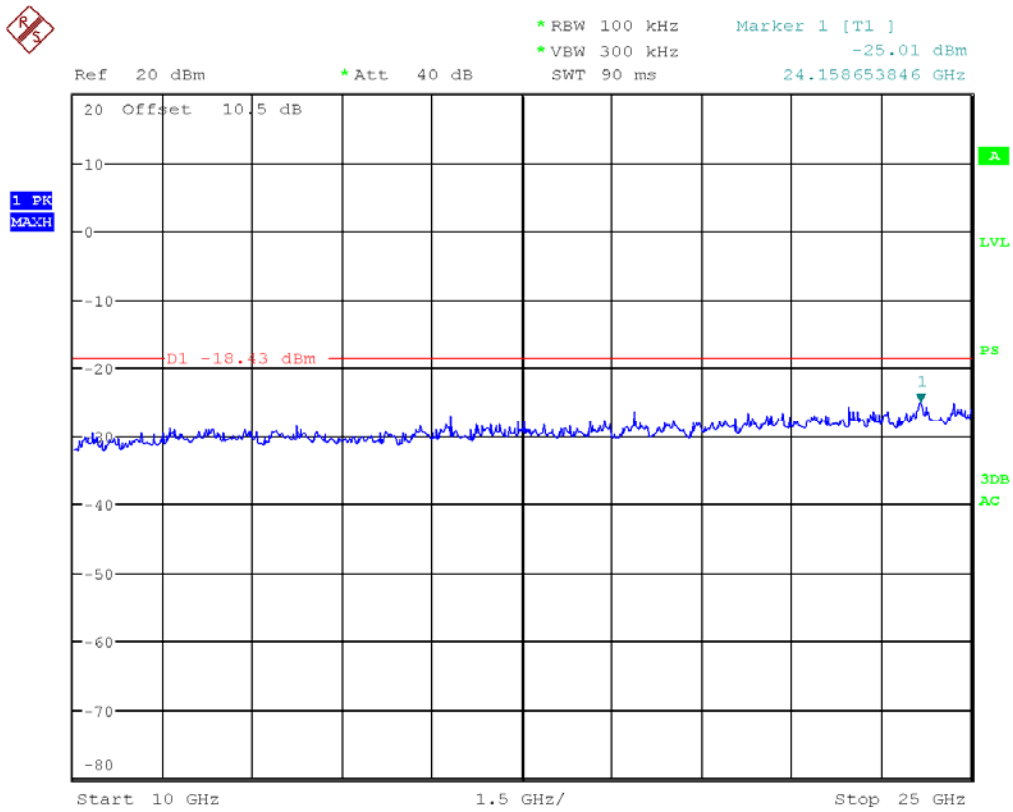

### Highest Channel

### 30M to 1GHz

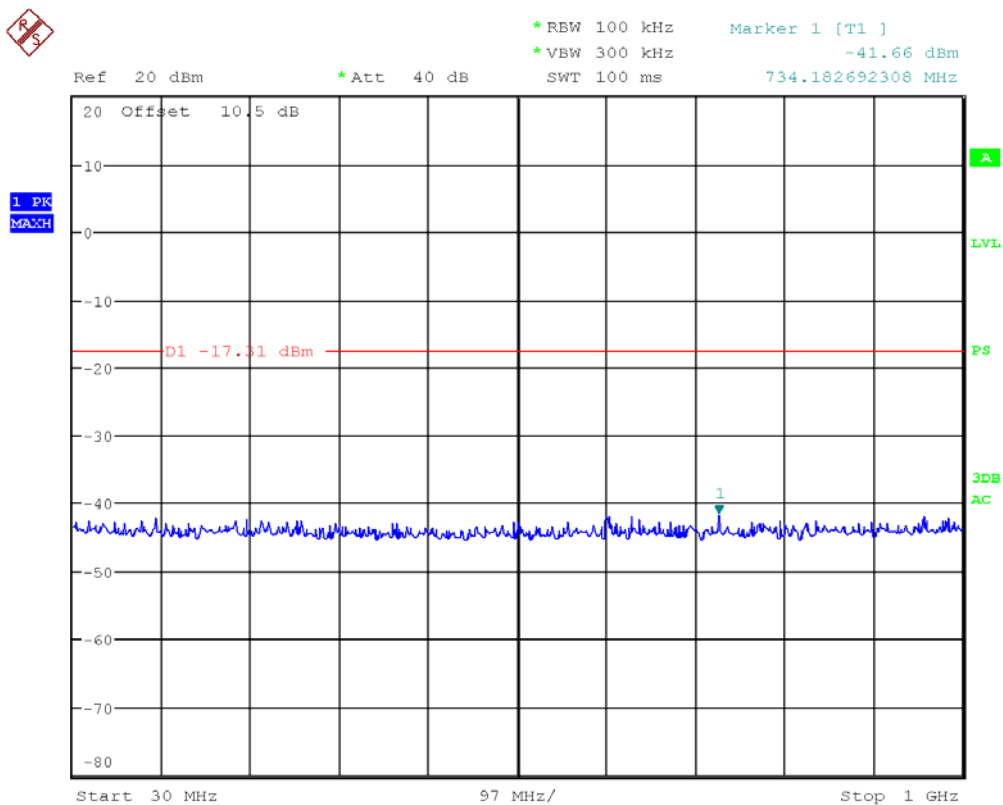

1G to 10GHz

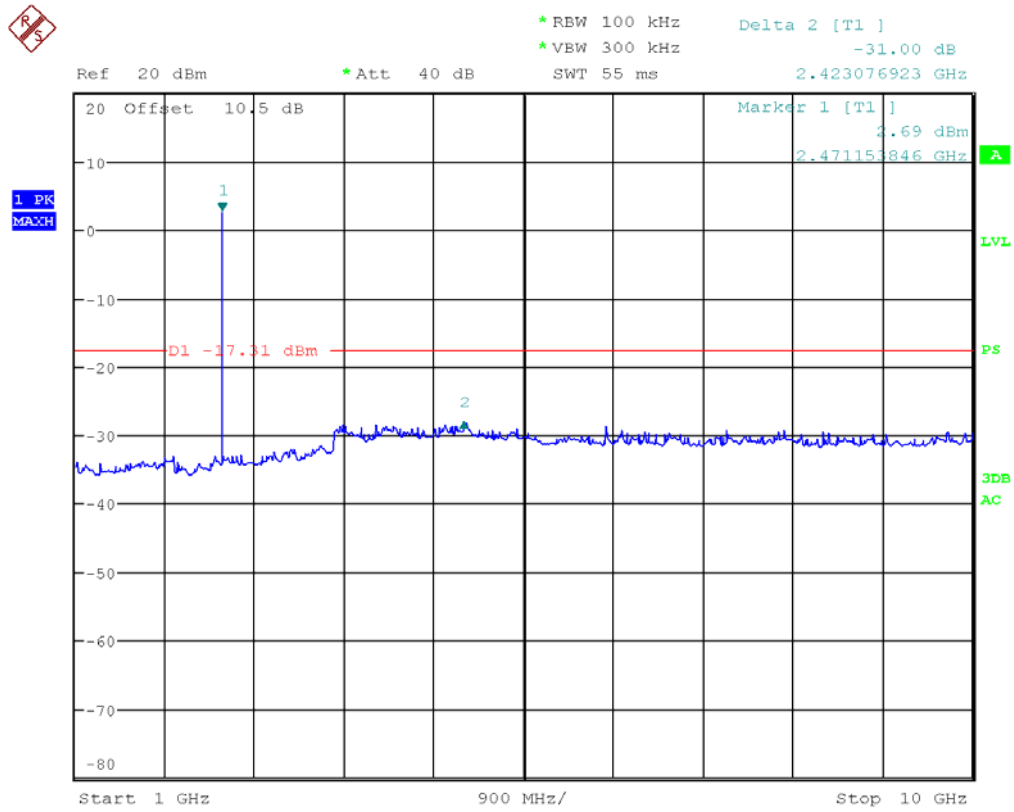

10G to 25GHz

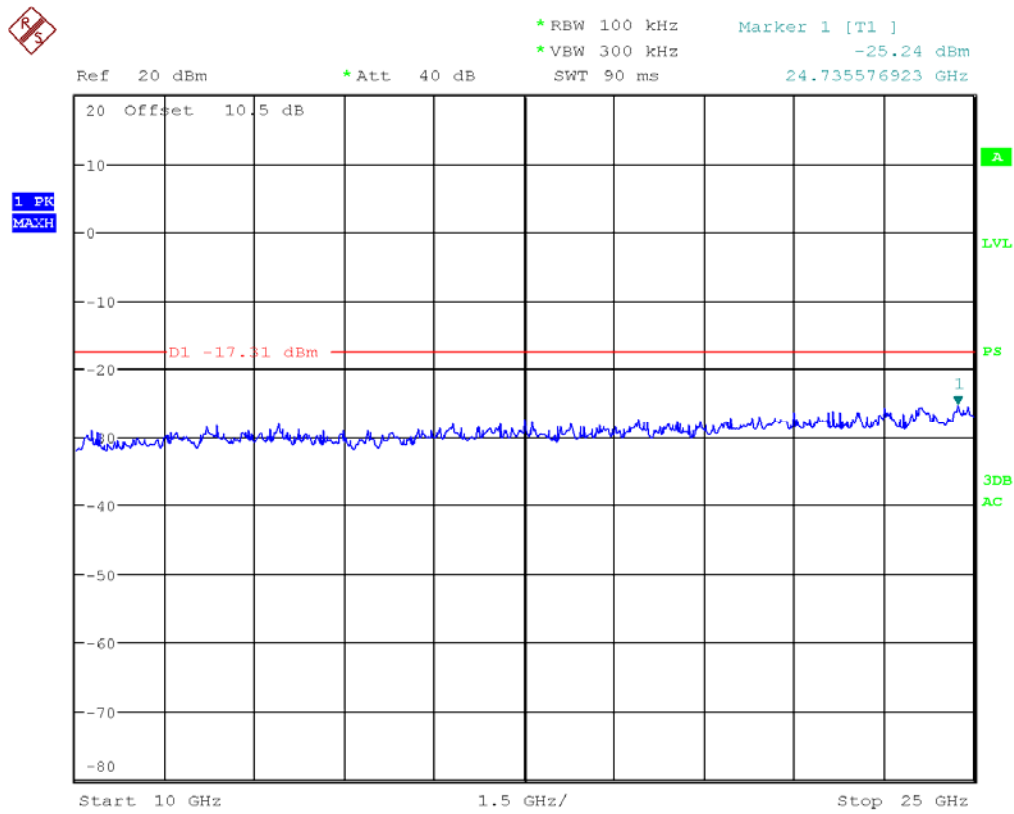

## 4.10 RADIATED SPURIOUS EMISSIONS

### 4.10.1 LIMITS

Frequency (MHz)	Quasi-peak(dB $\mu$ V/m)
30 ~ 88	40
88~216	43.5
216 ~ 960	46
Above 960	54

NOTE: (1) The lower limit shall apply at the transition frequencies.

Frequency (GHz)	Quasi-peak(dB $\mu$ V/m)
1 ~ 26.5	74
1~ 26.5	54

### 4.10.2 TEST PROCEDURES

#### Procedure of Preliminary Test

Radiated emission tests shall be made with the receive or transmit antenna located at a horizontal distance of 3 m plus half of the maximum width of the EUT being tested, measured from the centre of the EUT. The tests shall be performed with the equipment configured as closely as possible to its typical, practical operation. Unless stated otherwise, cables and wiring shall be as specified by the manufacturer and the equipment shall be in its housing (or cabinet) with all covers and access panels in place. Any deviation from normal EUT operating conditions shall be included in the test report.

The EUT (on a non-conductive support structure, where applicable) shall be placed on a remotely operated turntable, to allow the EUT to be rotated. The height of the EUT above the ground plane shall be according to the following requirements.

- Table-top equipment is placed on a non-conductive set-up table with height  $0,8 \text{ m} \pm 0,01 \text{ m}$ , ANSI C63.4 specifies the method to determine the impact of the non-conductive set-up table on test results.
- Floor-standing equipment is placed on a non-conductive support, as specified in the applicable product standard. If there are no EUT height placement requirements in the product standard, the EUT shall be placed on a non-conductive support at a height of 5 cm to 15 cm above the ground plane.

Interface cables, loads, and devices should be connected to at least one of each type of the interface ports of the EUT and, where practical, each cable shall be terminated in a device typical for its actual use. Where there are multiple interface ports of the same type, a typical number of these devices shall be connected to devices or loads. It is sufficient to connect only one of the loads, provided that it can be shown, for example by preliminary testing, that the connection of further ports would not significantly increase the level of disturbance (that is, more than 2 dB) or significantly degrade the immunity level.

The test mode(s) described in Item 2.4 were scanned during the preliminary test. After the preliminary scan, we found the test mode described in Item 2.4 producing the highest emission level. The EUT and cable configuration, antenna position, polarization and turntable position of the above highest emission level were recorded for the final test.

#### Procedure of Final Test

EUT and support equipment were set up on the turntable as per the configuration with highest

emission level in the preliminary test. The Analyzer / Receiver scanned from 30MHz to 1000MHz. Emissions were scanned and measured rotating the EUT to 360 degrees, varying cable placement and positioning the antenna 1 to 4 meters above the ground plane, in both the vertical and the horizontal polarization, to maximize the emission reading level. Record at least six highest emissions. Emission frequency, amplitude, antenna position, polarization and turntable position were recorded into a computer in which correction factors were used to calculate the emission level and compare reading to the applicable limit and only QP reading is presented. The test data of the worst-case condition(s) was recorded.

### Procedure of Final Test

EUT and support equipment were set up on the test bench as per the configuration with highest emission level in the preliminary test. A scan was taken on both power lines, recording at least the six highest emissions. Emission frequency and amplitude were recorded into a computer in which correction factors were used to calculate the emission level and compare reading to the applicable limit. The test data of the worst-case condition(s) was recorded.

Below 1GHz Set the spectrum analyzer: RBW =100KHz VBW  $\geq$  RBW , Span = enough to catch the trace. Sweep = auto; Detector Function = Peak. Trace = Max,hold.

Above 1GHz Set the spectrum analyzer: RBW =1MHz VBW  $\geq$  RBW , Span = enough to catch the trace. Sweep = auto; Detector Function = Peak. Trace = Max,hold.

Pre-test for normal mode and EDR mode, to find the EDR is the worst case.

The worst case emissions were reported.

### 4.10.3 TEST SETUP

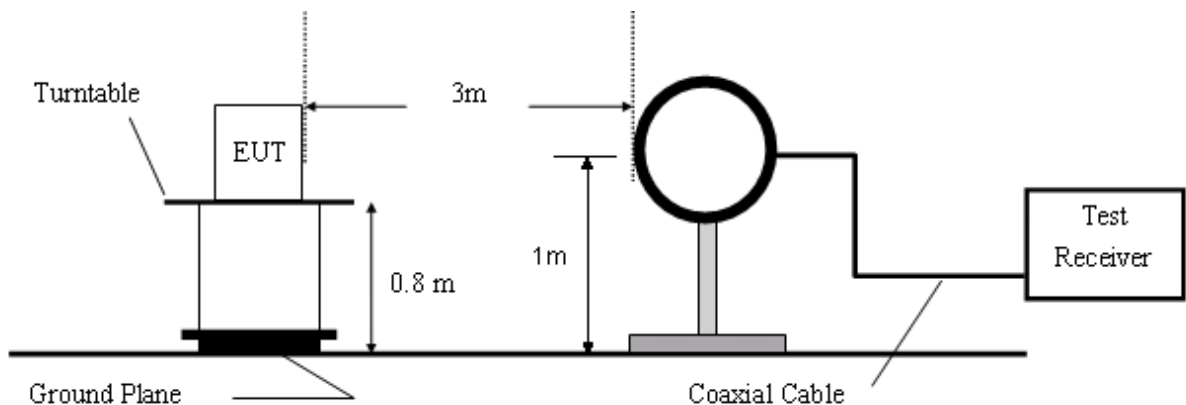

Figure 1. 9KHz to 30MHz radiated emissions test configuration

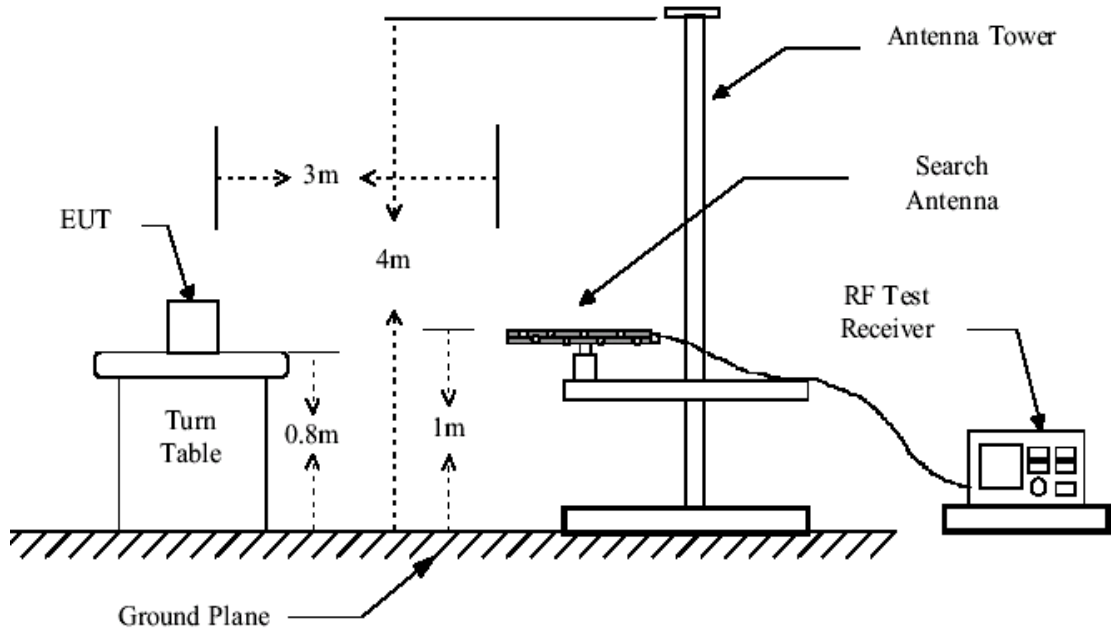

Figure 2. 30MHz to 1GHz radiated emissions test configuration

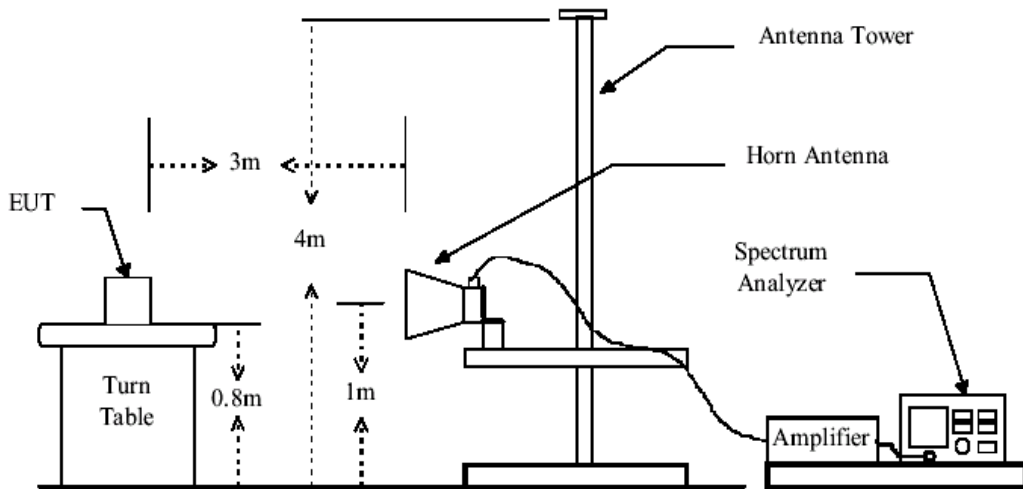

Figure 3. Above 1GHz radiated emissions test configuration

## 4.10.4 TEST RESULTS

### 1. Low Frequency 2402MHz

#### 30MHz~1GHz Spurious Emissions .Quasi-Peak Measurement

No.	Frequency (MHz)	Reading (dBuV/m)	Correct Factor(dB/m)	Result (dBuV/m)	Limit (dBuV/m)	Over Limit (dB)	Antenna polarization
1	30.0000	9.47	19.43	28.90	40.00	-11.10	Vertical
2	33.3803	10.23	17.37	27.60	40.00	-12.40	Vertical
3	43.9619	21.67	11.93	33.60	40.00	-6.40	Vertical
4	82.9571	16.52	8.88	25.40	40.00	-14.60	Vertical
5	92.3046	18.40	9.70	28.10	43.50	-15.40	Vertical
6	263.9970	9.18	14.02	23.20	46.00	-22.80	Vertical
7	41.5596	3.03	12.77	15.80	40.00	-24.20	Horizontal
8	82.0300	16.02	8.78	24.80	40.00	-15.20	Horizontal
9	103.8662	10.00	9.80	19.80	43.50	-23.70	Horizontal
10	191.6416	11.15	11.45	22.60	43.50	-20.90	Horizontal
11	231.9889	10.11	12.99	23.10	46.00	-22.90	Horizontal
12	367.7808	2.62	17.58	20.20	46.00	-25.80	Horizontal

#### 1~25 GHz Harmonics & Spurious Emissions. Peak & Average Measurement

##### Peak Measurement:

No.	Frequency (MHz)	Reading (dBuV/m)	Correct Factor(dB/m)	Result (dBuV/m)	Limit (dBuV/m)	Over Limit (dB)	Antenna polarization
1	15235.368	30.26	31.52	61.78	74.00	-12.22	Vertical
2	16869.777	30.43	35.22	65.65	74.00	-8.35	Vertical
3	13695.720	28.22	29.38	57.60	74.00	-16.40	Horizontal
4	15737.456	28.19	32.52	60.71	74.00	-13.29	Horizontal
5	16869.777	29.77	35.22	64.99	74.00	-9.01	Horizontal

##### AV Measurement:

No.	Frequency (MHz)	Reading (dBuV/m)	Correct Factor(dB/m)	Result (dBuV/m)	Limit (dBuV/m)	Over Limit (dB)	Antenna polarization
1	8756.039	14.56	24.22	46.08	54.00	-7.92	Vertical
2	9357.371	15.27	24.67	50.49	54.00	-3.51	Vertical
3	22514.450	15.81	25.67	45.19	54.00	-8.81	Vertical
4	9254.355	15.36	24.54	47.88	54.00	-6.12	Horizontal
5	9853.482	15.69	25.45	50.91	54.00	-3.09	Horizontal

The field strength is calculated by adding the Antenna Factor. Correct Factor.

The basic equation with a sample calculation is as follows:

Final Test Level =Receiver Reading + Correct Factor

## 2. Middle Frequency 2441MHz

## 30MHz~1GHz Spurious Emissions .Quasi-Peak Measurement

No.	Frequency (MHz)	Reading (dBuV/m)	Correct Factor(dB/m)	Result (dBuV/m)	Limit (dBuV/m)	Over Limit (dB)	Antenna polarization
1	34.3316	12.80	16.80	29.60	40.00	-10.40	Vertical
2	42.5042	19.75	12.45	32.20	40.00	-7.80	Vertical
3	45.4694	26.13	11.37	37.50	40.00	-2.50	Vertical
4	50.8779	15.82	9.58	25.40	40.00	-14.60	Vertical
5	92.3046	19.20	9.70	28.90	43.50	-14.60	Vertical
6	268.4853	5.68	14.12	19.80	46.00	-26.20	Vertical
7	42.5042	9.65	12.45	22.10	40.00	-17.90	Horizontal
8	78.8659	18.04	8.46	26.50	40.00	-13.50	Horizontal
9	103.8662	9.90	9.80	19.70	43.50	-23.80	Horizontal
10	229.3962	8.69	12.91	21.60	46.00	-24.40	Horizontal
11	256.6826	17.65	13.85	31.50	46.00	-14.50	Horizontal
12	365.7199	14.76	17.54	32.30	46.00	-13.70	Horizontal

## 1~25 GHz Harmonics &amp; Spurious Emissions. Peak &amp; Average Measurement

## Peak Measurement:

No.	Frequency (MHz)	Reading (dBuV/m)	Correct Factor(dB/m)	Result (dBuV/m)	Limit (dBuV/m)	Over Limit (dB)	Antenna polarization
1	15306.102	29.26	31.60	60.86	74.00	-13.14	Vertical
2	17185.254	29.95	35.66	65.61	74.00	-8.39	Vertical
3	17834.018	29.85	35.94	65.79	74.00	-8.21	Vertical
4	15883.925	26.17	32.96	59.13	74.00	-14.87	Horizontal
5	16869.777	30.02	35.22	65.24	74.00	-8.76	Horizontal

## AV Measurement:

No.	Frequency (MHz)	Reading (dBuV/m)	Correct Factor(dB/m)	Result (dBuV/m)	Limit (dBuV/m)	Over Limit (dB)	Antenna polarization
1	15306.102	14.51	31.60	46.11	54.00	-7.89	Vertical
2	17185.254	14.97	35.66	50.63	54.00	-3.37	Vertical
3	17834.018	15.01	35.94	50.95	54.00	-3.05	Vertical
4	15883.925	14.72	32.96	47.68	54.00	-6.32	Horizontal
5	16869.777	15.41	35.22	50.63	54.00	-3.37	Horizontal

The field strength is calculated by adding the Antenna Factor. Correct Factor.

The basic equation with a sample calculation is as follows:

Final Test Level =Receiver Reading + Correct Factor

## 3. High Frequency 2480MHz

## 30MHz~1GHz Spurious Emissions .Quasi-Peak Measurement

No.	Frequency (MHz)	Reading (dBuV/m)	Correct Factor(dB/m)	Result (dBuV/m)	Limit (dBuV/m)	Over Limit (dB)	Antenna polarization
1	33.3803	12.93	17.37	30.30	40.00	-9.70	Vertical
2	41.0951	17.57	12.93	30.50	40.00	-9.50	Vertical
3	45.2146	24.23	11.47	35.70	40.00	-4.30	Vertical
4	92.3046	18.20	9.70	27.90	43.50	-15.60	Vertical
5	215.6456	11.15	12.25	23.40	43.50	-20.10	Vertical
6	256.6826	11.65	13.85	25.50	46.00	-20.50	Vertical
7	42.0293	6.48	12.62	19.10	40.00	-20.90	Horizontal
8	77.9845	16.82	8.38	25.20	40.00	-14.80	Horizontal
9	191.6416	9.35	11.45	20.80	43.50	-22.70	Horizontal
10	215.6456	11.15	12.25	23.40	43.50	-20.10	Horizontal
11	261.0465	12.55	13.95	26.50	46.00	-19.50	Horizontal
12	343.7977	10.01	17.09	27.10	46.00	-18.90	Horizontal

## 1~25 GHz Harmonics &amp; Spurious Emissions. Peak &amp; Average Measurement

## Peak Measurement:

No.	Frequency (MHz)	Reading (dBuV/m)	Correct Factor(dB/m)	Result (dBuV/m)	Limit (dBuV/m)	Over Limit (dB)	Antenna polarization
1	16948.099	30.09	35.54	65.63	74.00	-8.37	Vertical
2	17669.566	30.07	35.73	65.80	74.00	-8.20	Vertical
3	2596.575	50.89	6.56	57.45	74.00	-16.55	Horizontal
4	16106.189	27.49	33.39	60.88	74.00	-13.12	Horizontal
5	16869.777	30.26	35.22	65.48	74.00	-8.52	Horizontal

## AV Measurement:

No.	Frequency (MHz)	Reading (dBuV/m)	Correct Factor(dB/m)	Result (dBuV/m)	Limit (dBuV/m)	Over Limit (dB)	Antenna polarization
1	16948.099	15.01	35.54	50.55	54.00	-3.45	Vertical
2	17669.566	14.67	35.73	50.4	54.00	-3.60	Vertical
3	2596.575	38.99	6.56	45.55	54.00	-8.45	Horizontal
4	16106.189	15.62	33.39	49.01	54.00	-4.99	Horizontal
5	16869.777	15.31	35.22	50.53	54.00	-3.47	Horizontal

**Remark:**

- 1). No any other emissions level which are attenuated less than 20dB below the limit.  
According to 15.31(o), The amplitude of spurious emissions from intentional radiators and emissions from unintentional radiators which are attenuated more than 20 dB below the permissible value need not be reported unless specifically required elsewhere in this Part.  
Hence there no other emissions have been reported.
- 2). As shown in Section, for frequencies above 1000 MHz. the above field strength limits are based on average limits. However, the peak field strength of any emission shall not exceed the maximum permitted average limits specified above by more than 20 dB under any condition of modulation.
- 3). The test only perform the EUT in transmitting status since the test frequencies were over 1GHz only required transmitting status.

**Test result: The unit does meet the requirements.**

## 4.11 BAND EDGES REQUIREMENT

### 4.11.1 LIMITS

Section 15.247 (d) In any 100 kHz bandwidth outside the frequency band in which the spread spectrum or digitally modulated intentional radiator is operating, the radio frequency power that is produced by the intentional radiator shall be at least 20 dB below that in the 100 kHz bandwidth within the band that contains the highest level of the desired power, based on either an RF conducted or a radiated measurement, provided the transmitter demonstrates compliance with the peak conducted power limits. If the transmitter complies with the conducted power limits based on the use of RMS averaging over a time interval, as permitted under paragraph (b)(3) of this section, the attenuation required under this paragraph shall be 30 dB instead of 20 dB. Attenuation below the general limits specified in Section 15.209(a) is not required.

### 4.11.2 TEST PROCEDURES

1. Check the calibration of the measuring instrument using either an internal calibrator or a known signal from an external generator.
2. Position the EUT without connection to measurement instrument. Turn on the EUT and connect its antenna terminal to measurement instrument via a low loss cable. Then set it to any one measured frequency within its operating range, and make sure the instrument is operated in its linear range.
3. Set RBW to 100 kHz and VBW of spectrum analyzer to 300 kHz with a convenient frequency span including 100 kHz bandwidth from band edge.  
**Note:** For Restricted Band  
RBW=100 kHz  
VBW=300 kHz
4. Measure the highest amplitude appearing on spectral display and set it as a reference level. Plot the graph with marking the highest point and edge frequency.

Repeat above procedures until all measured frequencies were complete.

### 4.11.3 TEST SETUP

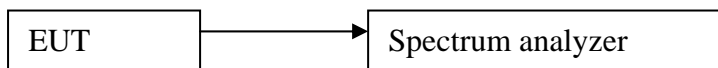

### 4.11.4 TEST RESULTS

**The unit does meet the FCC requirements.**

Test result plot as follows:

For GFSK

Lowest Channel

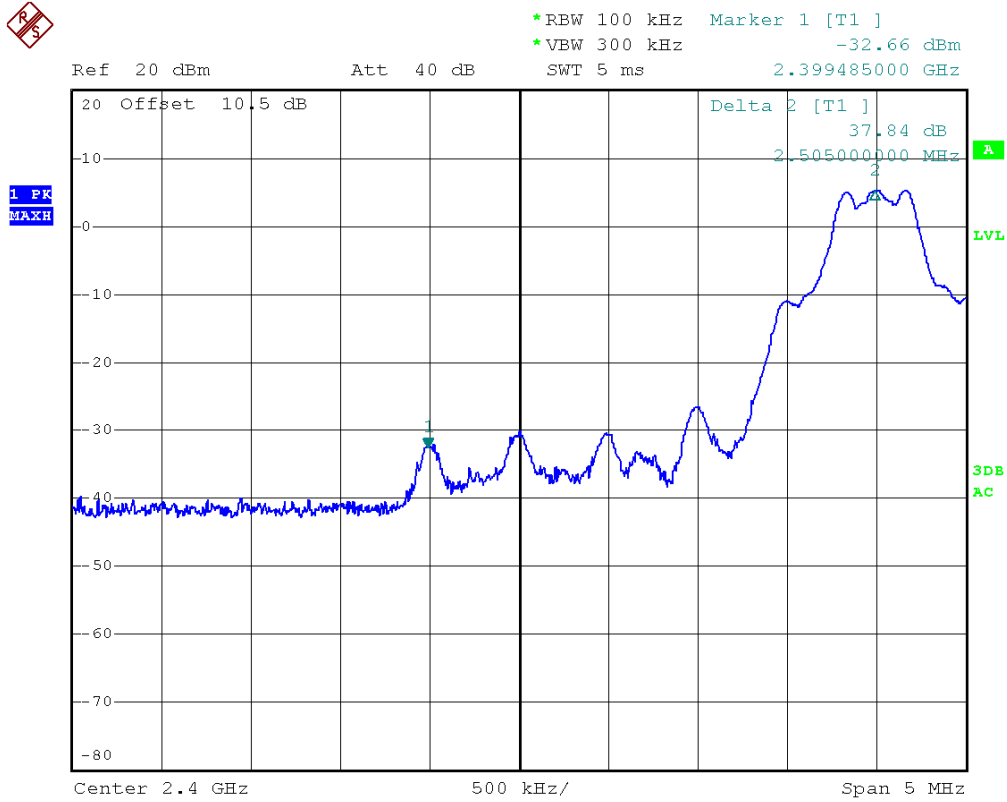

Highest Channel

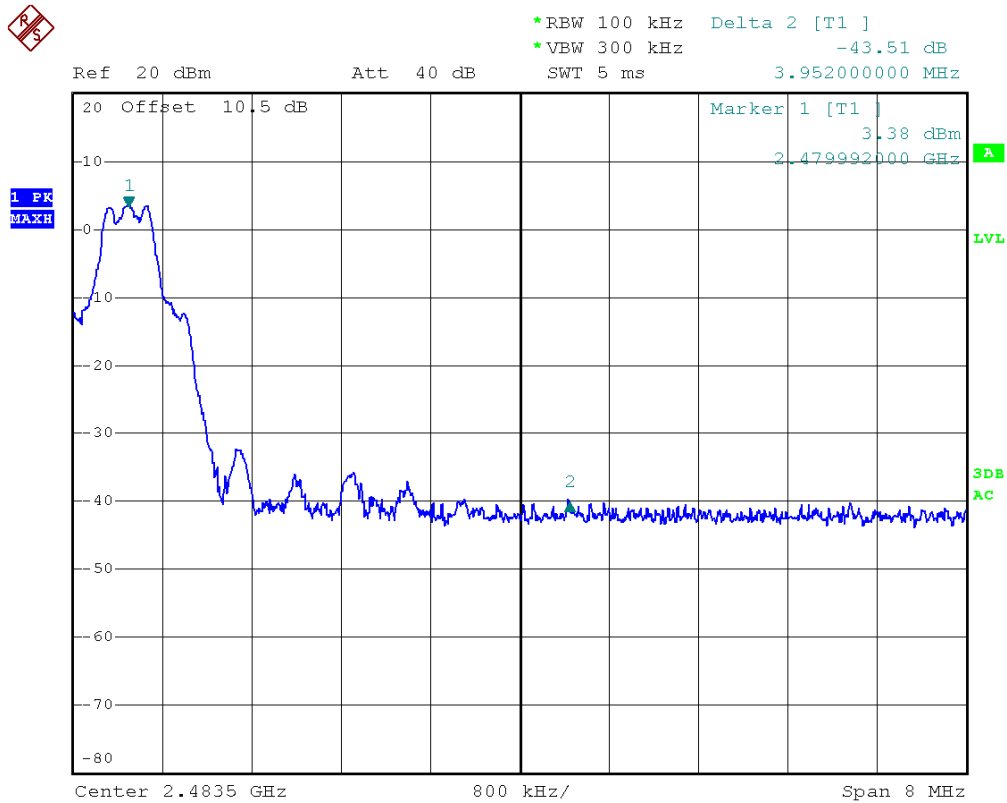

For 8DPSK

Lowest Channel

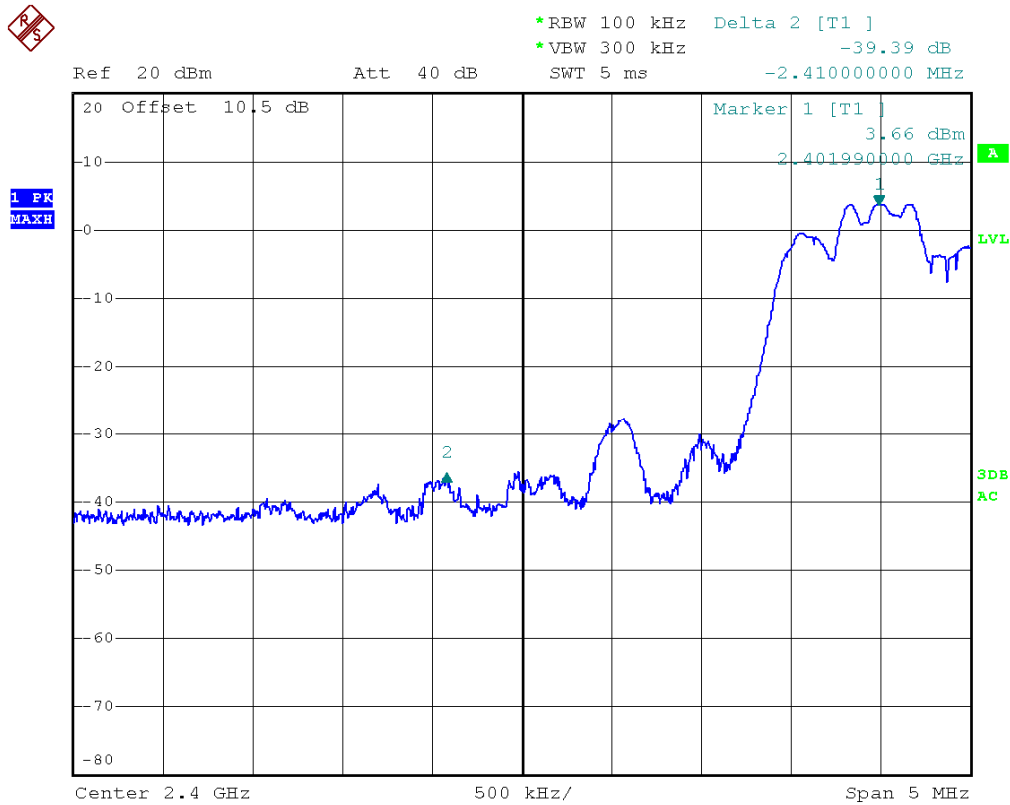

Highest Channel

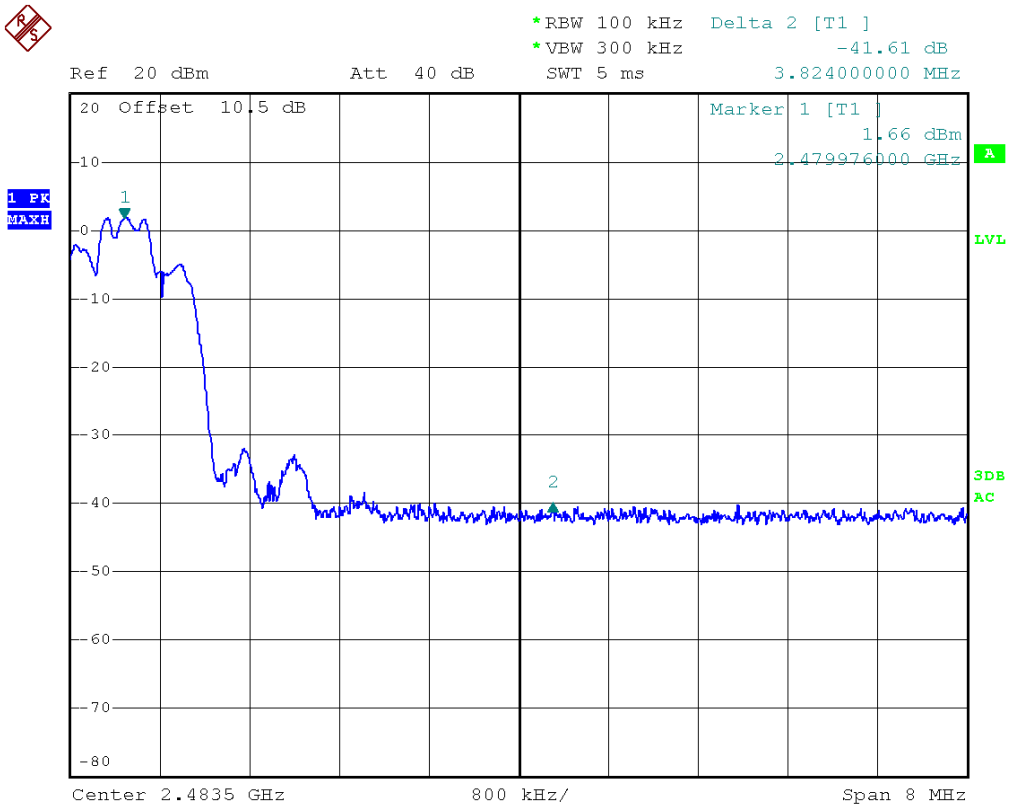

**4.11.5 Radiated Emissions which fall in the restricted bands**

Section 15.247(d) In addition, radiated emissions which fall in the restricted bands, as defined in Section 15.205(a), must also comply with the radiated emission limits specified in Section 15.209(a) (see Section 15.205(c)).

Section 15.205 Restricted bands of operation.

(a) Except as shown in paragraph (d) of this section, only spurious emissions are permitted in any of the frequency bands listed below:

MHz	MHz	MHz	GHz
0.090 - 0.110	16.42 - 16.423	399.9 - 410	4.5 - 5.15
0.495 - 0.505	16.69475 -	608 - 614	5.35 - 5.46
2.1735 - 2.1905	16.69525	960 - 1240	7.25 - 7.75
4.125 - 4.128	16.80425 -	1300 - 1427	8.025 - 8.5
4.17725 - 4.17775	16.80475	1435 - 1626.5	9.0 - 9.2
4.20725 - 4.20775	25.5 - 25.67	1645.5 - 1646.5	9.3 - 9.5
6.215 - 6.218	37.5 - 38.25	1660 - 1710	10.6 - 12.7
6.26775 - 6.26825	73 - 74.6	1718.8 - 1722.2	13.25 - 13.4
6.31175 - 6.31225	74.8 - 75.2	2200 - 2300	14.47 - 14.5
8.291 - 8.294	108 - 121.94	2310 - 2390	15.35 - 16.2
8.362 - 8.366	123 - 138	2483.5 - 2500	17.7 - 21.4
8.37625 - 8.38675	149.9 - 150.05	2655 - 2900	22.01 - 23.12
8.41425 - 8.41475	156.52475 -	3260 - 3267	23.6 - 24.0
12.29 - 12.293	156.52525	3332 - 3339	31.2 - 31.8
12.51975 -	156.7 - 156.9	3345.8 - 3358	36.43 - 36.5
12.52025	162.0125 - 167.17	3600 - 4400	
12.57675 -	167.72 - 173.2		
12.57725	240 - 285		
13.36 - 13.41	322 - 335.4		

Pretest the Bluetooth normal mode and EDR mode , record EDR mode date  
 The field strength was measured with an EMI measuring receiver and 1 MHz RBW / VBW for peak and with 1MHz RBW / 10Hz VBW for average at a distance of 3m.

**Test Result:**

**Channel Low**

No.	Freq MHz	Reading dBuV	Factor dB	Level dBuV/m	Limit dBuV/m	Over Limit dB	Remark	Pol V/H
1	2388.00	35.18	5.24	40.42	74.00	-33.58	Peak	VERTICAL
2	2388.00	30.15	5.24	35.39	74.00	-38.61	Avg	VERTICAL
3	2390.00	36.91	5.25	42.16	74.00	-31.84	Peak	VERTICAL
4	2390.00	29.31	5.25	34.56	74.00	-39.44	Avg	VERTICAL
1	2388.00	35.18	5.24	40.42	74.00	-33.58	Peak	HORIZONTAL
2	2388.00	28.17	5.24	33.41	74.00	-40.59	Avg	HORIZONTAL
3	2390.00	36.91	5.25	42.16	74.00	-31.84	Peak	HORIZONTAL
4	2390.00	30.39	5.25	35.64	74.00	-38.36	Avg	HORIZONTAL

**Channel High**

No.	Freq MHz	Reading dBuV	Factor dB	Level dBuV/m	Limit dBuV/m	Over Limit dB	Remark	Pol V/H
1	2483.50	35.11	5.60	40.71	74.00	-33.29	Peak	VERTICAL
2	2483.50	29.05	5.60	34.65	74.00	-39.35	Avg	VERTICAL
3	2500.00	35.44	5.66	41.10	74.00	-32.90	Peak	VERTICAL
4	2500.00	29.49	5.66	35.15	74.00	-38.85	Avg	VERTICAL
1	2483.50	34.59	5.60	40.19	74.00	-33.81	Peak	HORIZONTAL
2	2483.50	29.11	5.60	34.71	74.00	-39.29	Avg	HORIZONTAL
3	2500.00	35.66	5.66	41.32	74.00	-32.68	Peak	HORIZONTAL
4	2500.00	29.44	5.66	35.10	74.00	-38.90	Avg	HORIZONTAL

Remark: Max field strength in 3m distance. No any other emission which falls in restricted bands can be detected and be reported.

-----**This is the last page of the report.**-----