



FCC 47 CFR PART 15 SUBPART C

TEST REPORT

For

POWERED SOUNDBAR SPEAKER SYSTEM CENTER

Model: JBL CINEMA SB350 CENTER

Brand: JBL

Test Report Number:

C140326Z03-RP1

Prepared for

Harman International Industries, Inc.

8500 Balboa Blvd, Northridge, CA 91329, UNITED STATES

Prepared by

COMPLIANCE CERTIFICATION SERVICES (SHENZHEN) INC.

**No.10-1, Mingkeda Logistics Park, No.18, Huanguan South Rd.,
Guan Lan Town, Baoan District, Shenzhen China**

TEL: 86-755-28055000

FAX: 86-755-28055221

Issued Date: May 13, 2014



Note: This report shall not be reproduced except in full, without the written approval of Compliance Certification Services Inc. This document may be altered or revised by Compliance Certification Services Inc. personnel only, and shall be noted in the revision section of the document. The client should not use it to claim product endorsement by TAF, A2LA, NVLAP, NIST or any government agencies. The test result of this report relate only to the tested sample identified in this report.



Revision History

| Rev. | Issue No. | Revisions | Effect Page | Revised By |
|------|----------------|---------------|-------------|--------------|
| 00 | C140326Z03-RP1 | Initial Issue | ALL | Sabrina Wang |
| | | | | |
| | | | | |
| | | | | |



TABLE OF CONTENTS

1. TEST RESULT CERTIFICATION4

2. EUT DESCRIPTION..... 5

3. TEST METHODOLOGY..... 6

 3.1 DESCRIPTION OF TEST MODES..... 6

4. FACILITIES AND ACCREDITATIONS 7

 4.1 FACILITIES..... 7

 4.2 ACCREDITATIONS 7

 4.3 MEASUREMENT UNCERTAINTY 7

5. SETUP OF EQUIPMENT UNDER TEST 8

 5.1 SETUP CONFIGURATION OF EUT 8

 5.2 SUPPORT EQUIPMENT 8

6. FCC PART 15.247 REQUIREMENTS 9

 6.1 20dB BANDWIDTH..... 9

 6.2 PEAK POWER..... 14

 6.3 PEAK POWER SPECTRAL DENSITY 15

 6.4 BAND EDGES MEASUREMENT 21

 6.5 FREQUENCY SEPARATION 31

 6.6 NUMBER OF HOPPING FREQUENCY 32

 6.7 TIME OF OCCUPANCY (DWELL TIME)..... 35

 6.8 SPURIOUS EMISSIONS..... 44

 6.9 POWERLINE CONDUCTED EMISSIONS 55



1. TEST RESULT CERTIFICATION

| | |
|----------------------|---|
| Product: | POWERED SOUNDBAR SPEAKER SYSTEM CENTER |
| Model: | JBL CINEMA SB350 CENTER |
| Brand: | JBL |
| Tested: | March 26 ~ May 12, 2014 |
| Applicant: | Harman International Industries, Inc. 8500 Balboa Blvd, Northridge, CA 91329, UNITED STATES |
| Manufacturer: | Harman International Industries, Inc. 8500 Balboa Blvd, Northridge, CA 91329, UNITED STATES |
| Factory: | Shenzhen 3nod Digital Technology Co., Ltd. Building D Park 8# Road Tangxiayong Village, Industrial Zone Songgang Town, Baoan District, Shenzhen City, China |

| APPLICABLE STANDARDS | |
|------------------------------|-------------------------|
| STANDARD | TEST RESULT |
| FCC 47 CFR Part 15 Subpart C | No non-compliance noted |

We hereby certify that:

The above equipment was tested by Compliance Certification Services Inc. The test data, data evaluation, test procedures, and equipment configurations shown in this report were made in accordance with the procedures given in ANSI C63.4:2009 and the energy emitted by the sample EUT tested as described in this report is in compliance with conducted and radiated emission limits of FCC Rules Part 15.207, 15.209 and 15.247.

The test results of this report relate only to the tested sample EUT identified in this report.

Approved by:

Sunday Hu
Supervisor of EMC Dept.
Compliance Certification Service Inc.

Reviewed by:

Ruby Zhang
Supervisor of Report Dept.
Compliance Certification Service Inc.



2. EUT DESCRIPTION

| | |
|------------------------------|---|
| Product | POWERED SOUNDBAR SPEAKER SYSTEM CENTER |
| Model Number | JBL CINEMA SB350 CENTER |
| Brand | JBL |
| Model Discrepancy | N/A |
| Identify Number | C140326Z03-RP1 |
| Power Supply | AC100-240V 50/60Hz |
| Received Date | March 26, 2014 |
| Frequency Range | 2402 ~ 2480 MHz |
| Transmit Power | GFSK : 6.26dBm 8DPSK : 4.92dBm |
| Modulation Technique | FHSS (GFSK for 1Mbps, $\pi/4$ -DQPSK for 2Mbps, 8DPSK for 3Mbps) |
| Number of Channels | 79 Channels |
| Antenna Specification | PCB antenna with 3.46dBi gain (Max) |
| Temperature Range | 0°C ~ +40°C |
| Hardware Version | DV2 |
| Software Version | V017 |

Note: This submittal(s) (test report) is intended for FCC ID: APISB350C filing to comply with Section 15.207, 15.209 and 15.247 of the FCC Part 15, Subpart C Rules.



3. TEST METHODOLOGY

3.1 DESCRIPTION OF TEST MODES

The EUT has been tested under operating condition.

Test program used to control the EUT for staying in continuous transmitting and receiving mode is programmed.

The following test mode(s) were scanned during the preliminary test below 1G:

| Test Item | Test mode | Worse mode |
|--------------------|-------------------------|-------------------------------------|
| Conducted Emission | Mode 1: Aux Play | <input checked="" type="checkbox"/> |
| Radiated Emission | Mode 1: TX | <input checked="" type="checkbox"/> |

Above 1G, Channel Low (2402MHz) · Mid (2441MHz) and High (2480MHz) were chosen for full testing for GFSK and 8DPSK.



4. FACILITIES AND ACCREDITATIONS

4.1 FACILITIES

All measurement facilities used to collect the measurement data are located at

No.10-1, Mingkeda Logistics Park, No.18, Huanguan South Rd., Guan Lan Town, Baoan District, Shenzhen, China

The sites are constructed in conformance with the requirements of ANSI C63.4:2009, ANSI C63.7 and CISPR Publication 22. All receiving equipment conforms to CISPR Publication 16-1, "Radio Interference Measuring Apparatus and Measurement Methods."

4.2 ACCREDITATIONS

Our laboratories are accredited and approved by the following accreditation body according to ISO/IEC 17025.

| | |
|--------------|------|
| USA | A2LA |
| China | CNAS |

The measuring facility of laboratories has been authorized or registered by the following approval agencies.

| | |
|---------------|------------------------------------|
| USA | FCC |
| Japan | VCCI(C-3478, R-3135, T-652, G-624) |
| Canada | INDUSTRY CANADA |
| Taiwan | BSMI |

Copies of granted accreditation certificates are available for downloading from our web site, <http://www.ccsrf.com>

4.3 MEASUREMENT UNCERTAINTY

Where relevant, the following measurement uncertainty levels have been estimated for tests performed on the EUT as specified in CISPR 16-4-2:

| Parameter | Uncertainty |
|--|--------------------|
| Radiated Emission, 30 to 200 MHz Test Site : 966(2) | +/-3.6880dB |
| Radiated Emission, 200 to 1000 MHz Test Site : 966(2) | +/-3.6695dB |
| Radiated Emission, 1 to 8 GHz | +/-5.1782dB |
| Radiated Emission, 8 to 18 GHz | +/-5.2173dB |
| Conducted Emissions | +/-3.6836dB |
| Band Width | 178kHz |
| Peak Output Power MU | +/-1.906dB |
| Band Edge MU | +/-0.182dB |
| Channel Separation MU | 416.178Hz |
| Duty Cycle MU | 0.054ms |
| Frequency Stability MU | 226Hz |

This uncertainty represents an expanded uncertainty expressed at approximately the 95% confidence level using a coverage factor of k=2.

The measured result is above (below) the specification limit by a margin less than the measurement uncertainty; it is therefore not possible to state compliance based on the 95% level of confidence. However, the result indicates that compliance (non-compliance) is more probable than non-compliance) with the specification limit.



5. SETUP OF EQUIPMENT UNDER TEST

5.1 SETUP CONFIGURATION OF EUT

See test photographs attached in Appendix 1 for the actual connections between EUT and support equipment.

5.2 SUPPORT EQUIPMENT

| No. | Equipment | Model No. | Serial No. | FCC ID | Trade Name | Data Cable | Power Cord |
|-----|--|--|----------------|---------------|------------|-------------------|---------------------|
| 1 | Monitor | 12LA6200-CN | 309NDFV1H179 | N/A | LG | N/A | Unshielded 1.50m |
| 2 | DVD | DV-410V-G | HKKD010577CN | N/A | PIONEER | N/A | Unshielded 2.00m |
| 3 | Disk | HX-MU032D C/GB2 | E269J90B313481 | N/A | SAMSUNG | Shielded 0.50m | N/A |
| 4 | NOTEBOOK | B475 | WB04861612 | N/A | LENOVO | N/A | Unshielded 2.50m |
| 5 | POWERED SOUNDBAR SPEAKER SYSTEM CENTER | JBL CINEMA SB350 CENTER Subwoofer | | APISB35 0S | JBL | N/A | Unshielded 1.40m |

Notes:

Grounding was established in accordance with the manufacturer's requirements and conditions for the intended use.



6. FCC PART 15.247 REQUIREMENTS

6.1 20dB BANDWIDTH

None; for reporting purpose only.

MEASUREMENT EQUIPMENT USED

| Name of Equipment | Manufacturer | Model | Serial Number | Last Calibration | Due Calibration |
|-------------------|--------------|--------|---------------|------------------|-----------------|
| Spectrum Analyzer | Agilent | E4446A | US44300399 | 03/01/2014 | 03/01/2015 |

Remark: Each piece of equipment is scheduled for calibration once a year.

TEST CONFIGURATION

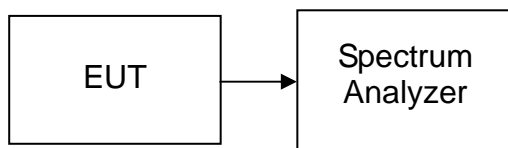

TEST PROCEDURE

1. Place the EUT on the table and set it in the transmitting mode.
2. Remove the antenna from the EUT, then connect a low loss RF cable from antenna port to the spectrum analyzer.
3. Set the spectrum analyzer as RBW=30kHz, VBW=100kHz, Span=3MHz, Sweep = auto.
4. Mark the peak frequency and 20dB (upper and lower) frequency.
5. Repeat until all the test channels are investigated.

TEST RESULTS

No non-compliance noted



Test plot

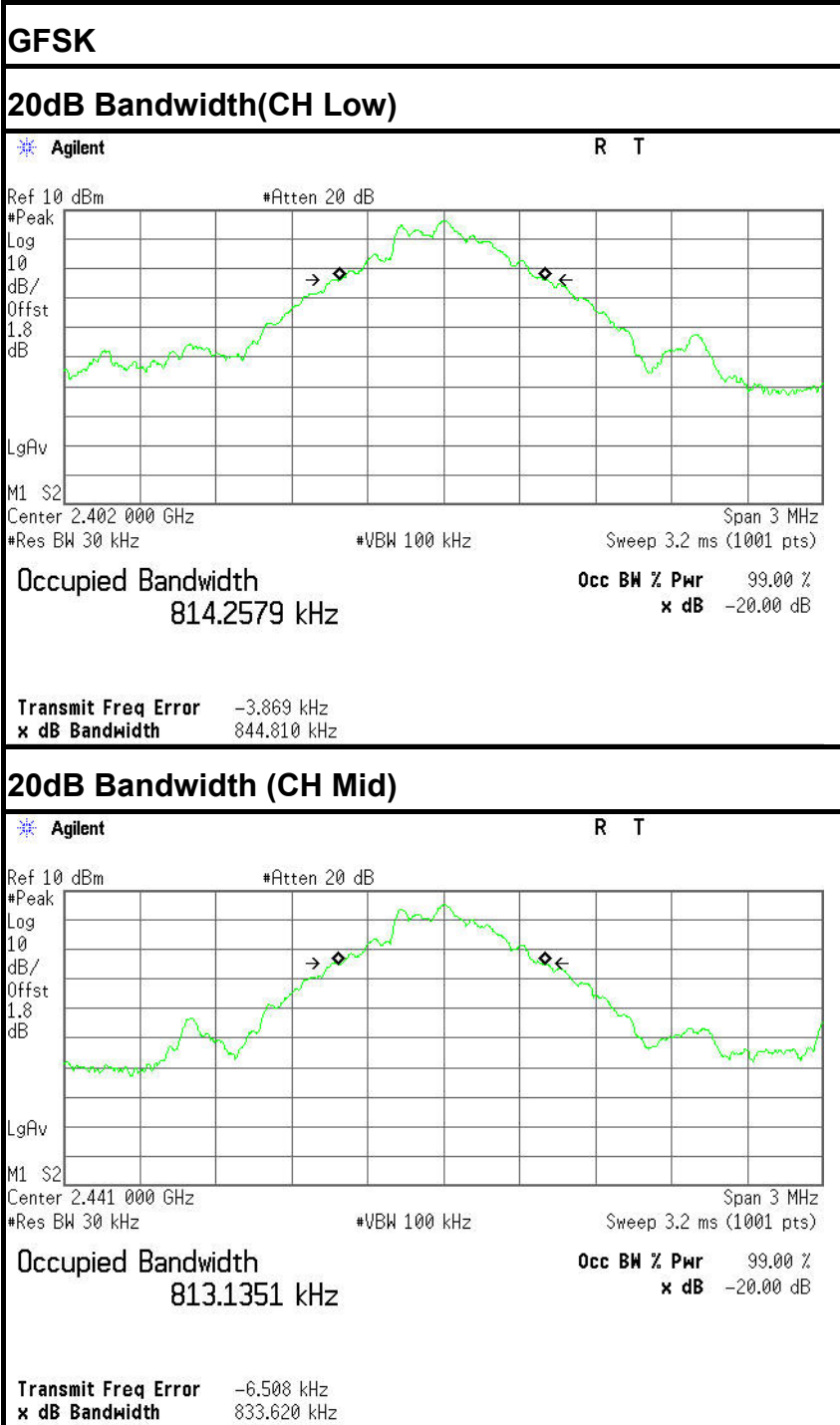



20dB Bandwidth (CH High)

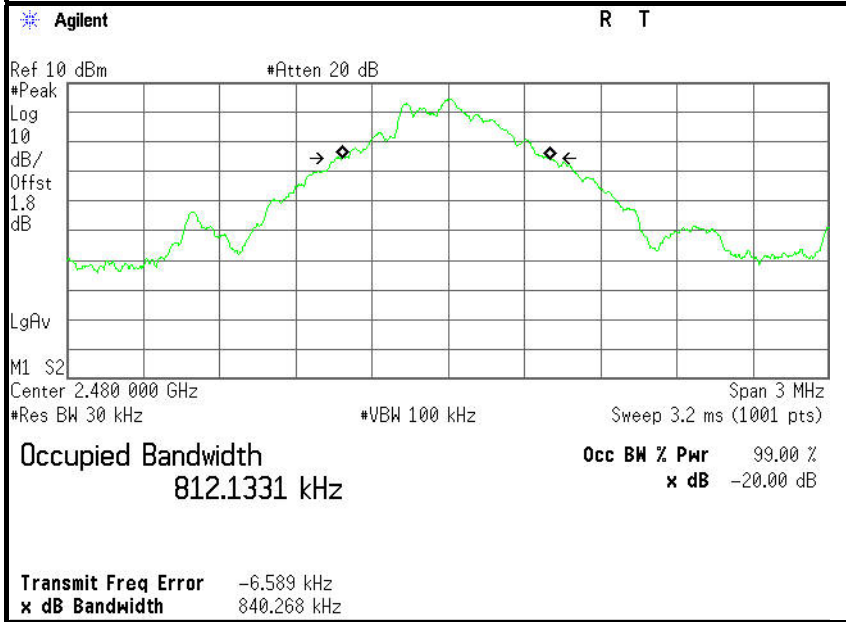



Test plot

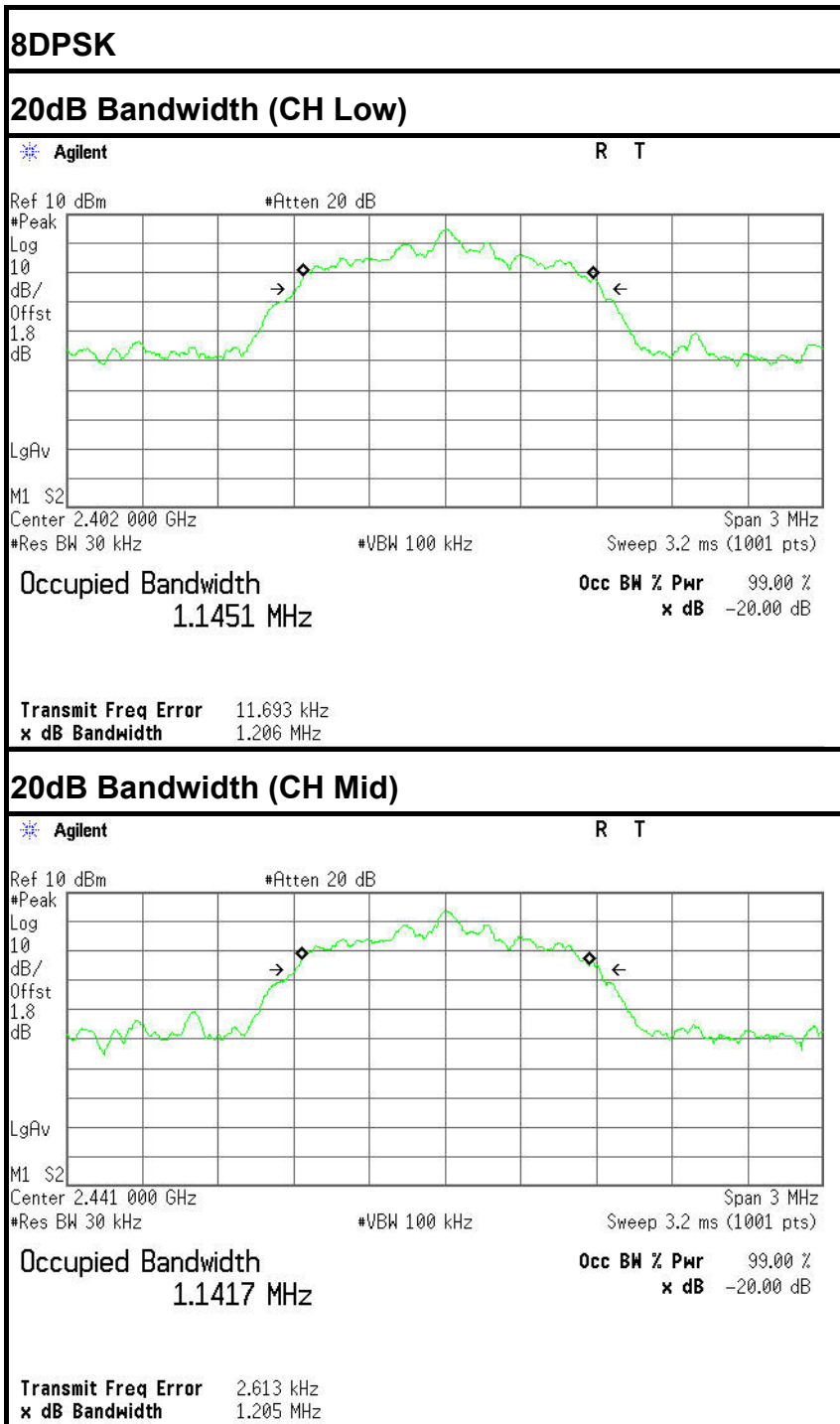

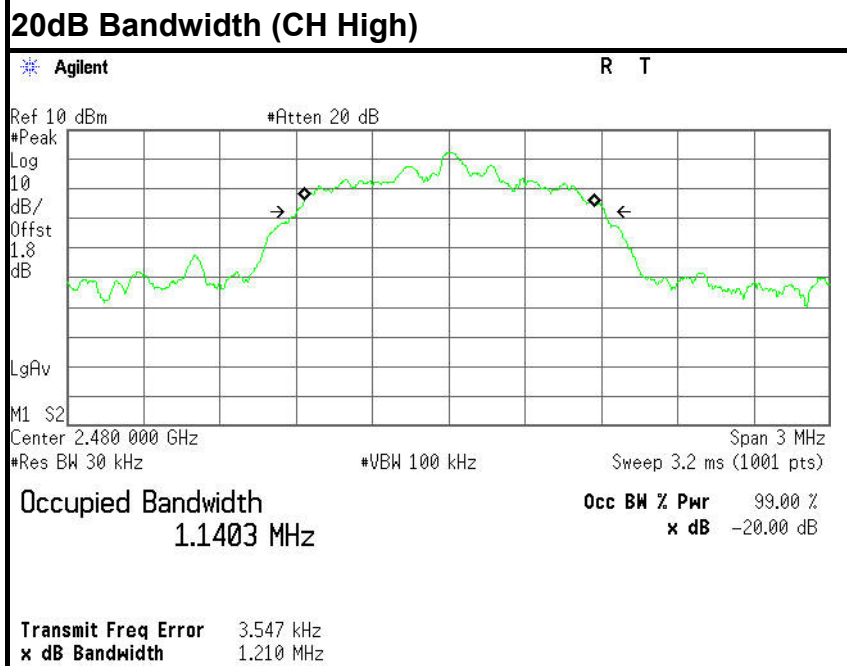



6.2 PEAK POWER

LIMIT

The maximum peak output power of the intentional radiator shall not exceed the following:

1. For frequency hopping systems operating in the 2400-2483.5 MHz band employing at least 75 non-overlapping hopping channels, and all frequency hopping systems in the 5725-5850 MHz band: 1 watt. For all other frequency hopping systems in the 2400-2483.5 MHz band: 0.125 watts.
2. Except as shown in paragraphs (b)(3) (i), (ii) and (iii) of this section, if transmitting antennas of directional gain greater than 6dBi are used the peak output power from the intentional radiator shall be reduced below the stated values in paragraphs (b)(1) or (b)(2) of this section, as appropriate, by the amount in dB that the directional gain of the antenna exceeds 6dBi.
3. The conducted output power limit specified in paragraph (b) of this section is based on the use of antennas with directional gains that do not exceed 6 dBi. Except as shown in paragraph (c) of this section, if transmitting antennas of directional gain greater than 6 dBi are used, the conducted output power from the intentional radiator shall be reduced below the stated values in paragraphs (b)(1), (b)(2), and (b)(3) of this section, as appropriate, by the amount in dB that the directional gain of the antenna exceeds 6 dBi.

MEASUREMENT EQUIPMENT USED

| Name of Equipment | Manufacturer | Model | Serial Number | Last Calibration | Due Calibration |
|-------------------|--------------|---------|---------------|------------------|-----------------|
| Power Meter | Anritsu | ML2495A | 1204003 | 03/01/2014 | 03/01/2015 |
| Spectrum Analyzer | Agilent | E4446A | US44300399 | 03/01/2014 | 03/01/2015 |

Remark: Each piece of equipment is scheduled for calibration once a year.

Test Configuration

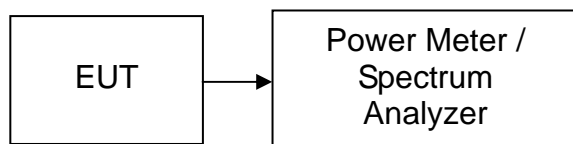

TEST PROCEDURE

The transmitter output is connected to the RF Power Meter. The RF Power Meter is set to the peak power detection.



TEST RESULTS

No non-compliance noted

Test Data

GFSK

| Channel | Frequency (MHz) | Reading Power (dBm) | Factor (dB) | Output Power (dBm) | Output Power (W) | Limit (W) | Result |
|---------|-----------------|---------------------|-------------|--------------------|------------------|-----------|--------|
| Low | 2402 | 2.76 | 3.50 | 6.26 | 0.00423 | 1 | PASS |
| Mid | 2441 | 1.73 | 3.50 | 5.23 | 0.00333 | | PASS |
| High | 2480 | 0.93 | 3.50 | 4.43 | 0.00277 | | PASS |

8DPSK

| Channel | Frequency (MHz) | Reading Power (dBm) | Factor (dB) | Output Power (dBm) | Output Power (W) | Limit (W) | Result |
|---------|-----------------|---------------------|-------------|--------------------|------------------|-----------|--------|
| Low | 2402 | 1.42 | 3.50 | 4.92 | 0.00310 | 1 | PASS |
| Mid | 2441 | 0.31 | 3.50 | 3.81 | 0.00240 | | PASS |
| High | 2480 | -0.62 | 3.50 | 2.88 | 0.00194 | | PASS |



Test plot

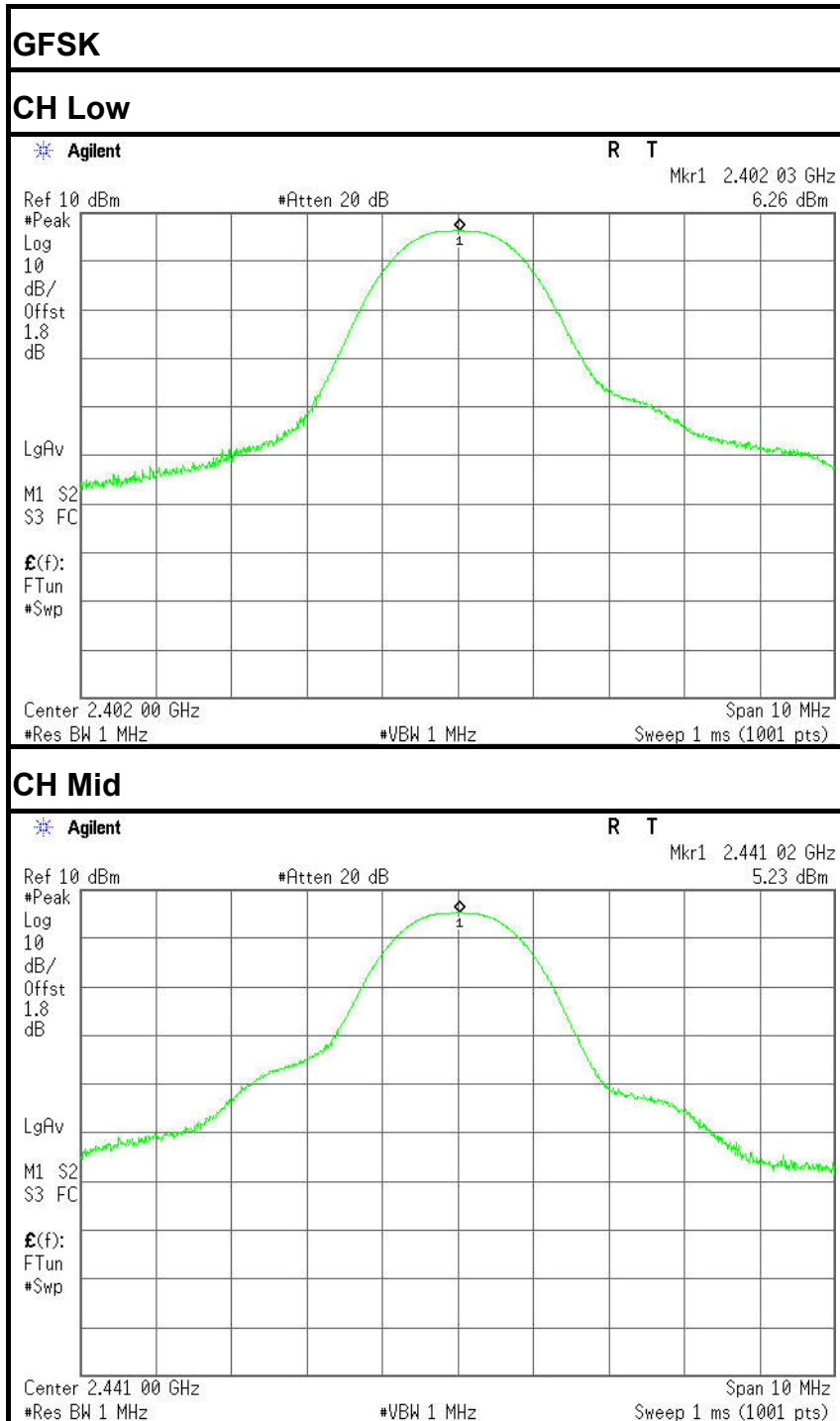

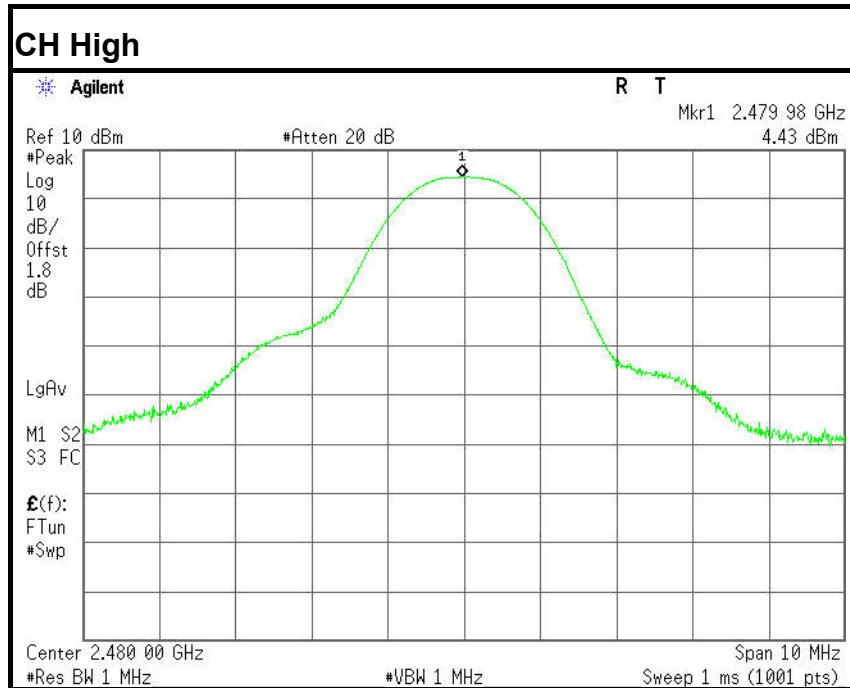

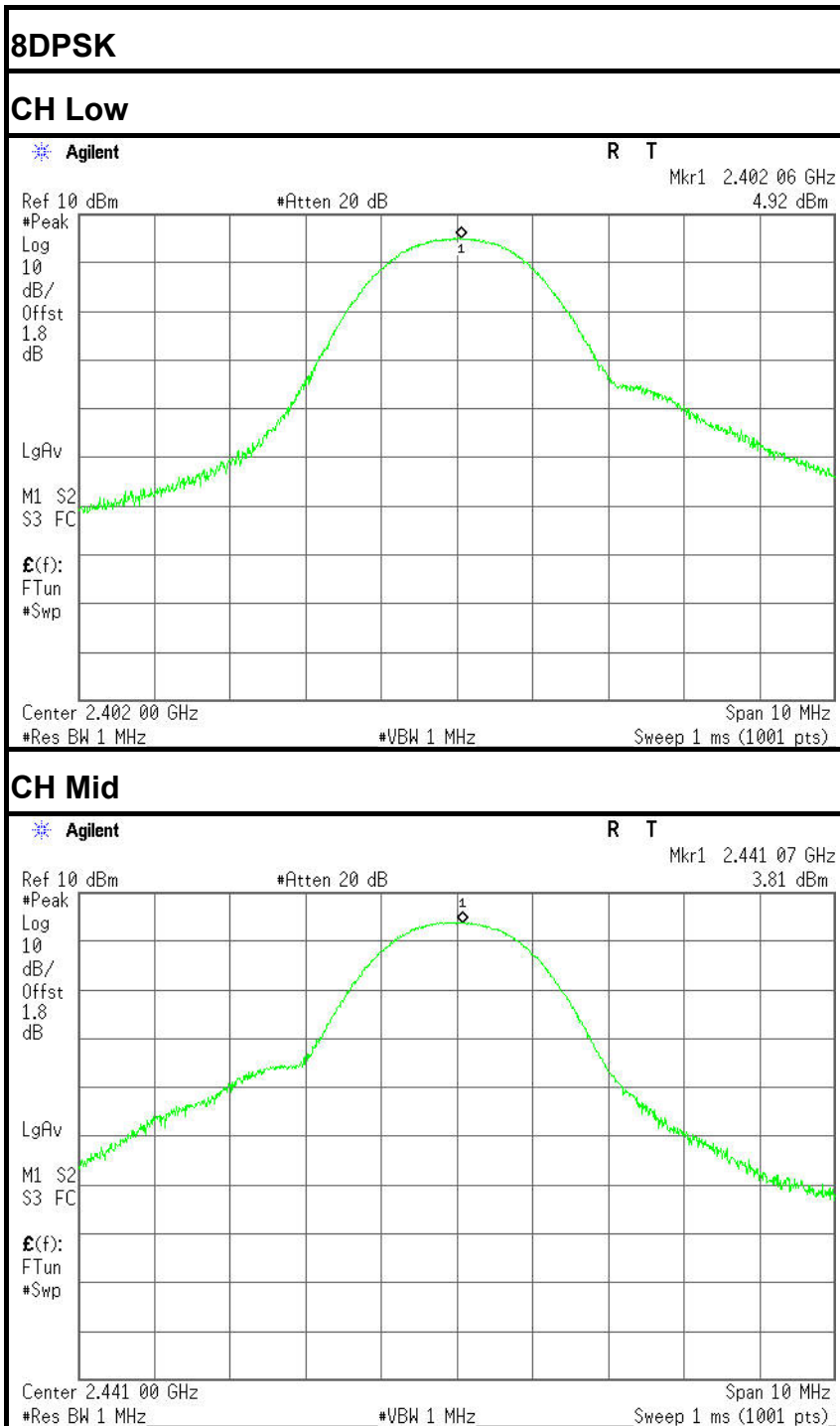

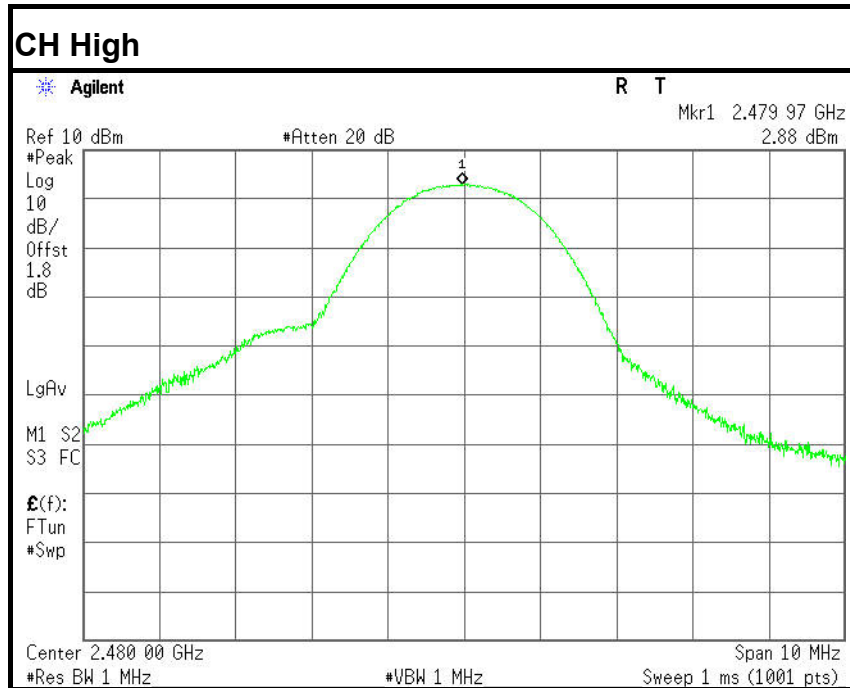



6.3 PEAK POWER SPECTRAL DENSITY

LIMIT

1. For direct sequence systems, the peak power spectral density conducted from the intentional radiator to the antenna shall not be greater than 8dBm in any 3kHz band during any time interval of continuous transmission.
2. The direct sequence operating of the hybrid system, with the frequency hopping operation turned off, shall comply with the power density requirements of paragraph (d) of this section.

MEASUREMENT EQUIPMENT USED

| Name of Equipment | Manufacturer | Model | Serial Number | Last Calibration | Due Calibration |
|-------------------|--------------|--------|---------------|------------------|-----------------|
| Spectrum Analyzer | Agilent | E4446A | US44300399 | 03/01/2014 | 03/01/2015 |

Remark: Each piece of equipment is scheduled for calibration once a year.

Test Configuration

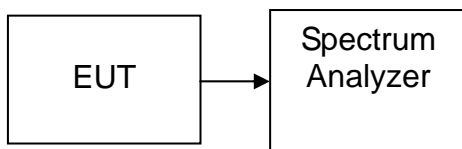

TEST PROCEDURE

1. Set analyzer center frequency to DTS channel center frequency.
2. Set the span to 1.5 times the DTS bandwidth.
3. Set the RBW to: 3 kHz \leq RBW \leq 100 kHz.
4. Set the VBW \geq 3xRBW.
5. Detector = peak.
6. Sweep time = auto couple.
7. Trace mode = max hold.
8. Allow trace to fully stabilize.
9. Use the peak marker function to determine the maximum amplitude level within the RBW.
10. If measured value exceeds limit, reduce RBW (no less than 3 kHz) and repeat.

TEST RESULTS

Not applicable. Since EUT is the Bluetooth device.



6.4 BAND EDGES MEASUREMENT

LIMIT

According to §15.247(c), in any 100 kHz bandwidth outside the frequency bands in which the spread spectrum intentional radiator is operating, the radio frequency power that is produced by the intentional radiator shall be at least 20dB below that in the 100kHz bandwidth within the band that contains the highest level of the desired power. In addition, radiated emissions which fall in the restricted bands, as defined in §15.205(a), must also comply with the radiated emission limits specified in 15.209(a).

MEASUREMENT EQUIPMENT USED

| Radiated Emission Test Site 966 (2) | | | | | | |
|-------------------------------------|----------------|--------------------|---------------|------------------|-----------------|--|
| Name of Equipment | Manufacturer | Model Number | Serial Number | Last Calibration | Due Calibration | |
| PSA Series Spectrum Analyzer | Agilent | E4446A | US44300399 | 03/01/2014 | 03/01/2015 | |
| EMI TEST RECEIVER | ROHDE&SCHWARZ | ESCI | 100783 | 03/09/2014 | 03/08/2015 | |
| Amplifier | MITEQ | AM-1604-3000 | 1123808 | 03/18/2015 | 03/18/2015 | |
| High Noise Amplifier | Agilent | 8449B | 3008A01838 | 03/18/2015 | 03/18/2015 | |
| Board-Band Horn Antenna | Schwarzbeck | BBHA 9170 | 9170-497 | 07/10/2013 | 07/09/2014 | |
| Bilog Antenna | SCHAFFNER | CBL6143 | 5082 | 03/01/2014 | 03/01/2015 | |
| Horn Antenna | SCHWARZBECK | BBHA9120 | D286 | 03/01/2014 | 03/01/2015 | |
| Loop Antenna | A, R, A | PLA-1030/B | 1029 | 09/27/2013 | 09/26/2014 | |
| Turn Table | N/A | N/A | N/A | N.C.R | N.C.R | |
| Controller | Sunol Sciences | SC104V | 022310-1 | N.C.R | N.C.R | |
| Controller | CT | N/A | N/A | N.C.R | N.C.R | |
| Temp. / Humidity Meter | Anymetre | JR913 | N/A | 02/28/2014 | 02/28/2015 | |
| Antenna Tower | SUNOL | TLT2 | N/A | N.C.R | N.C.R | |
| Test S/W | FARAD | LZ-RF / CCS-SZ-3A2 | | | | |

Test Configuration

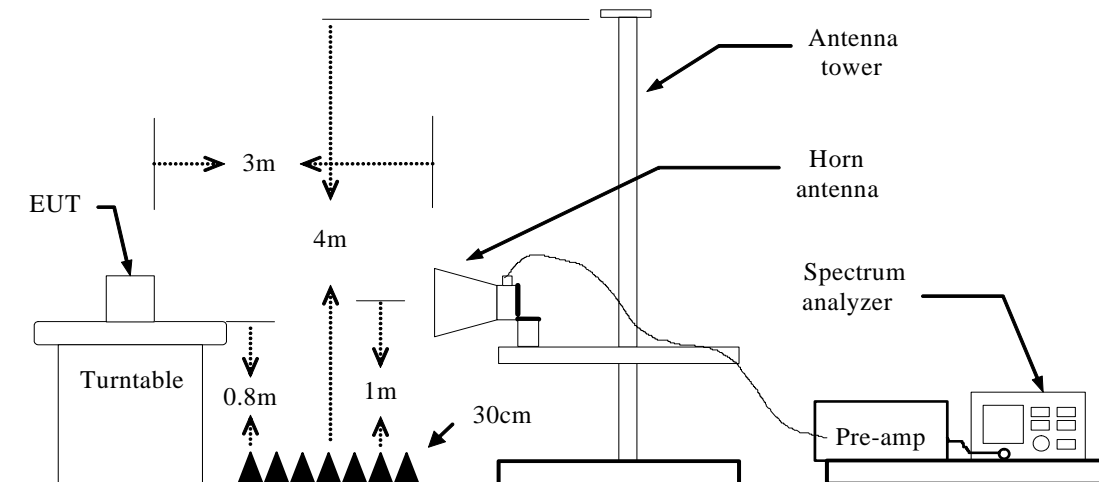



TEST PROCEDURE

1. The EUT is placed on a turntable, which is 0.8m above the ground plane.
2. The turntable shall be rotated for 360 degrees to determine the position of maximum emission level.
3. EUT is set 3m away from the receiving antenna, which is varied from 1m to 4m to find out the highest emission.
4. Set the spectrum analyzer in the following setting in order to capture the lower and upper band-edges of the emission:
 - (a) PEAK: RBW=VBW=1MHz / Sweep=AUTO
 - (b) AVERAGE: RBW=1MHz / VBW=2kHz / Sweep=AUTO
5. Repeat the procedures until all the PEAK and AVERAGE versus POLARIZATION are measured.

TEST RESULTS

Refer to attach spectrum analyzer data chart.



Test Data (GFSK)

Band Edges (CH-Low)

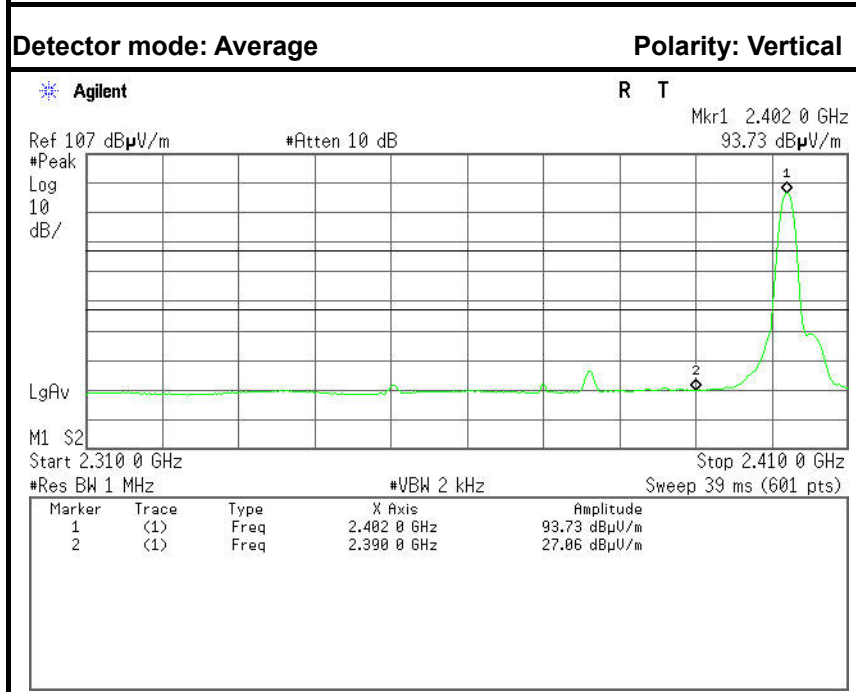
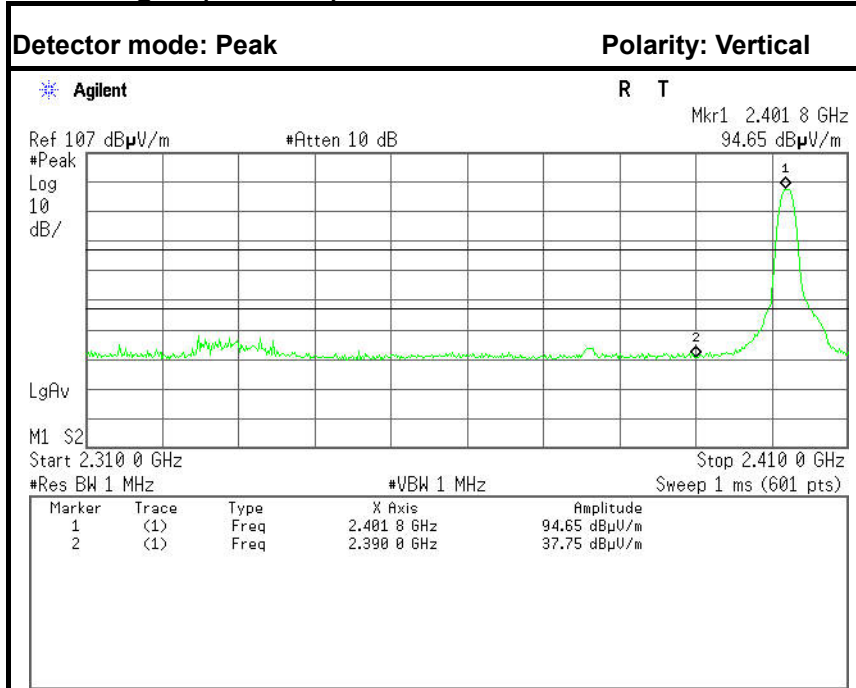

| No. | Frequency (MHz) | Reading (dBuV) | Corrected (dB) | Result (dBuV) | Limit (dBuV) | Margin (dB) | Detector | Antenna Pole |
|-----|-----------------|----------------|----------------|---------------|--------------|-------------|----------|--------------|
| 1 | 2390.0000 | 31.15 | -6.60 | 37.75 | 74.00 | -36.25 | Peak | Vertical |
| 2 | 2390.0000 | 20.46 | -6.60 | 27.06 | 54.00 | -26.94 | Average | Vertical |

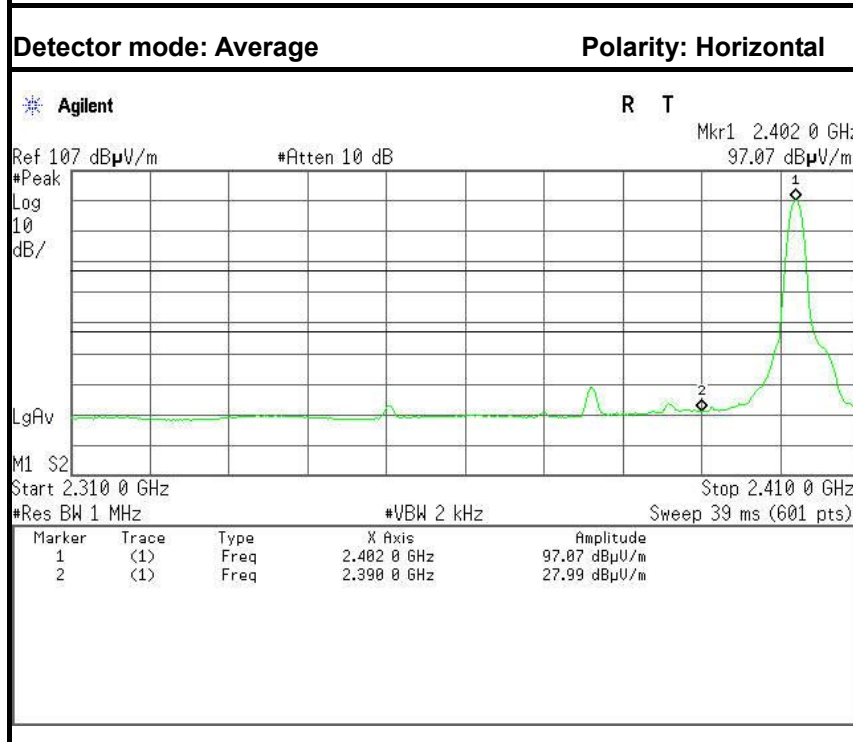
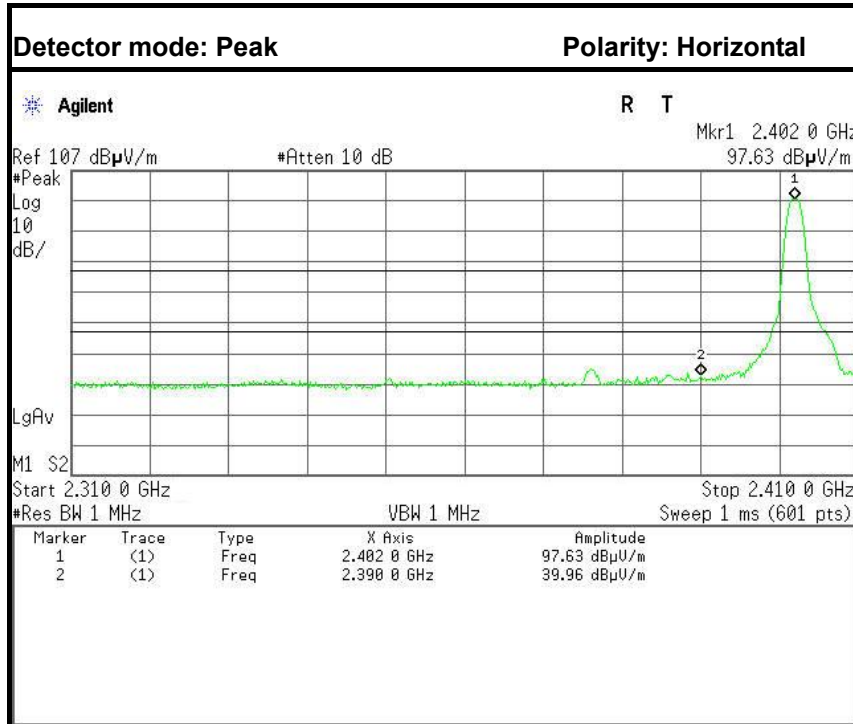

| No. | Frequency (MHz) | Reading (dB μ V) | Corrected (dB) | Result (dB μ V) | Limit (dB μ V) | Margin (dB) | Detector | Antenna Pole |
|-----|-----------------|----------------------|----------------|---------------------|--------------------|-------------|----------|--------------|
| 1 | 2390.0000 | 33.36 | -6.60 | 39.96 | 74.00 | -34.04 | Peak | Horizontal |
| 2 | 2390.0000 | 21.39 | -6.60 | 27.99 | 54.00 | -26.01 | Average | Horizontal |



Band Edges (CH-High)

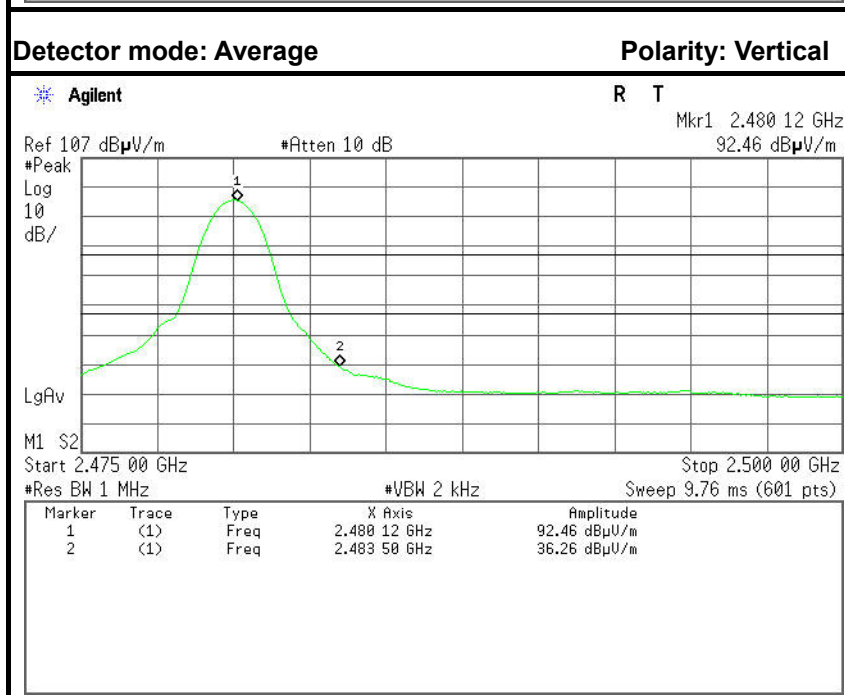
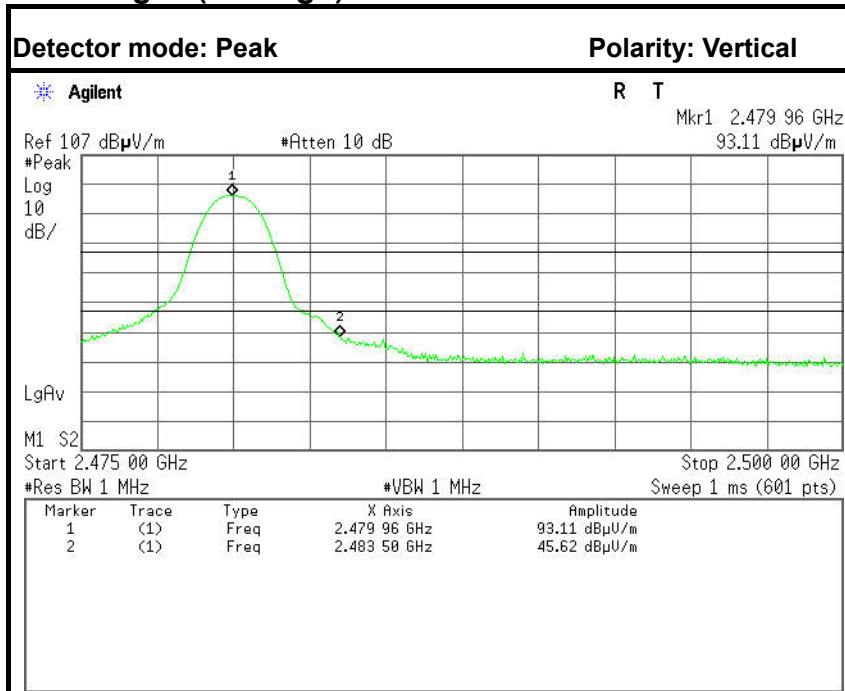

| No. | Frequency (MHz) | Reading (dBuV) | Corrected (dB) | Result (dBuV) | Limit (dBuV) | Margin (dB) | Detector | Antenna Pole |
|-----|-----------------|----------------|----------------|---------------|--------------|-------------|----------|--------------|
| 1 | 2483.5000 | 39.38 | -6.24 | 45.62 | 74.00 | -28.38 | Peak | Vertical |
| 2 | 2483.5000 | 30.02 | -6.24 | 36.26 | 54.00 | -17.74 | Average | Vertical |

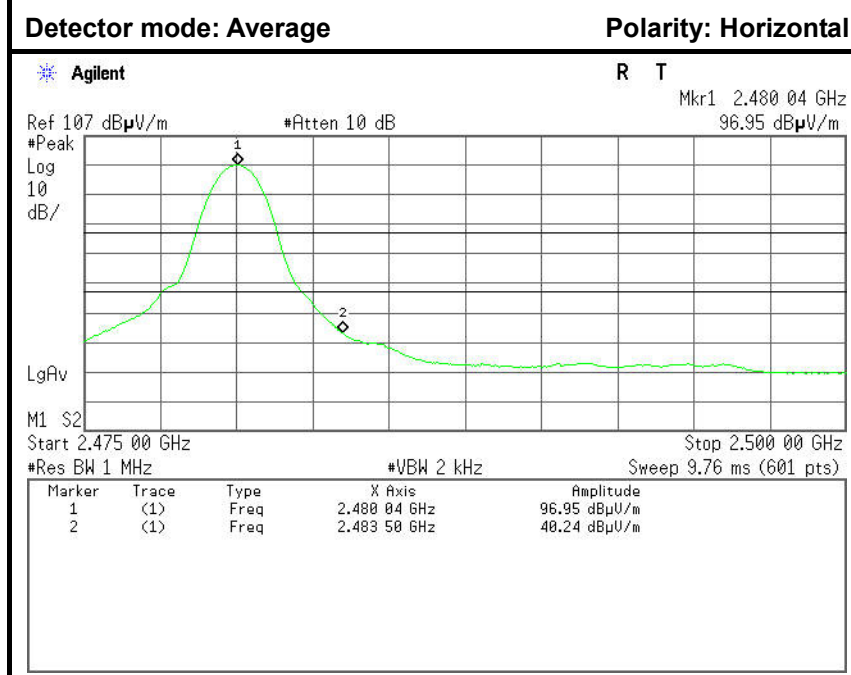
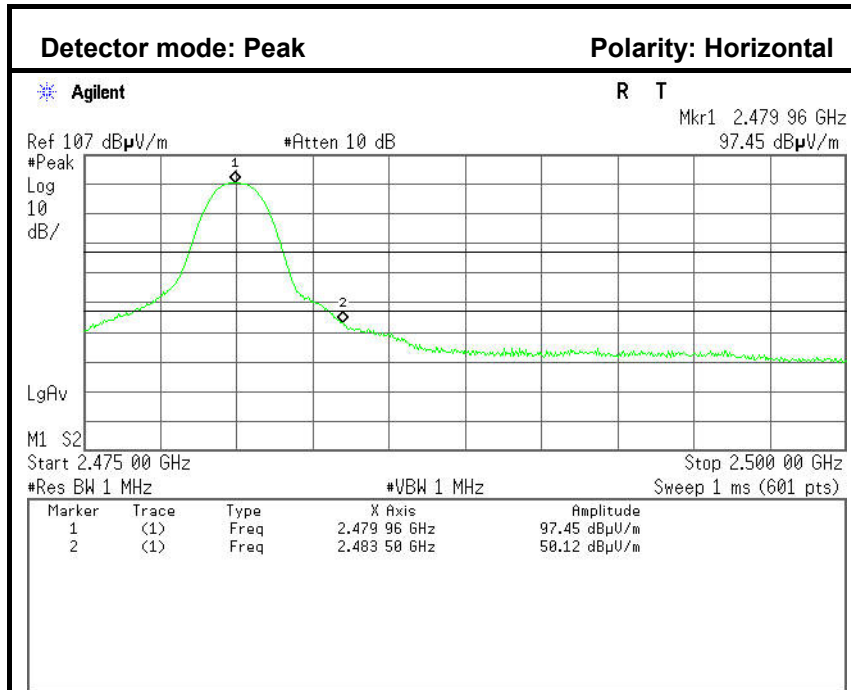

| No. | Frequency (MHz) | Reading (dBuV) | Corrected (dB) | Result (dBuV) | Limit (dBuV) | Margin (dB) | Detector | Antenna Pole |
|-----|-----------------|----------------|----------------|---------------|--------------|-------------|----------|--------------|
| 1 | 2483.5000 | 43.88 | -6.24 | 50.12 | 74.00 | -23.88 | Peak | Horizontal |
| 2 | 2483.5000 | 34.00 | -6.24 | 40.24 | 54.00 | -13.76 | Average | Horizontal |



8DPSK

Band Edges (CH-Low)

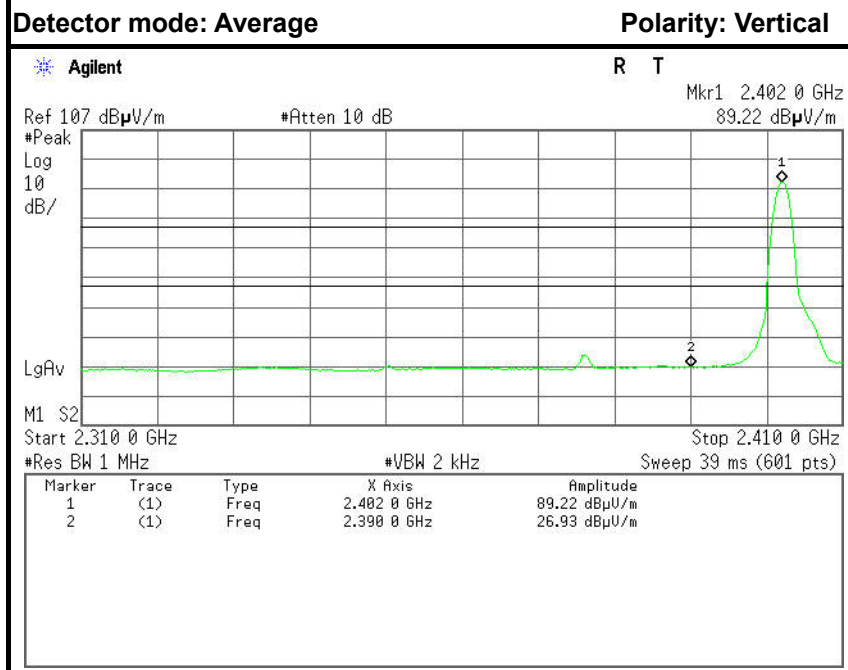
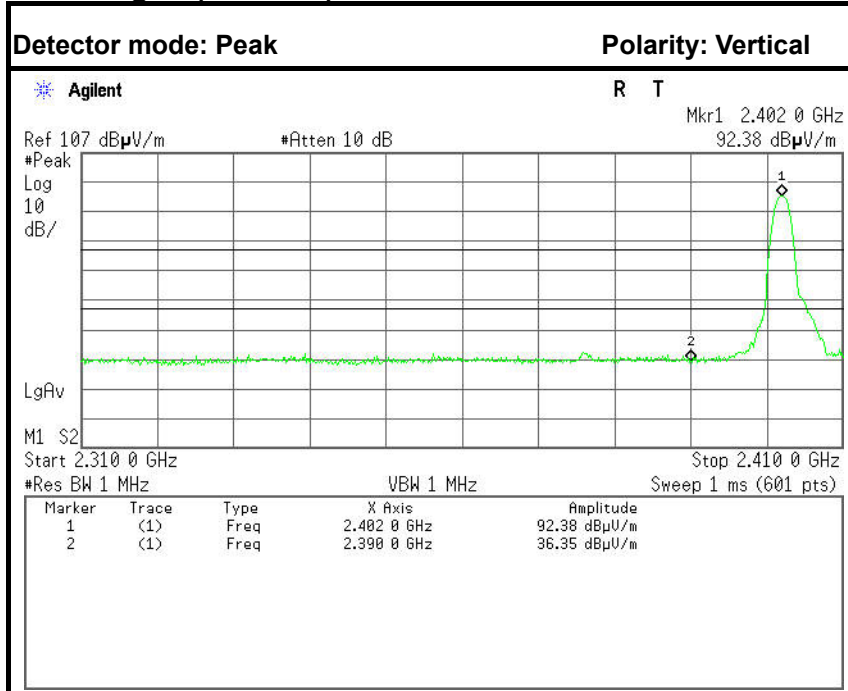

| No. | Frequency (MHz) | Reading (dBuV) | Corrected (dB) | Result (dBuV) | Limit (dBuV) | Margin (dB) | Detector | Antenna Pole |
|-----|-----------------|----------------|----------------|---------------|--------------|-------------|----------|--------------|
| 1 | 2390.0000 | 29.75 | -6.60 | 36.35 | 74.00 | -37.65 | Peak | Vertical |
| 2 | 2390.0000 | 20.33 | -6.60 | 26.93 | 54.00 | -27.07 | Average | Vertical |

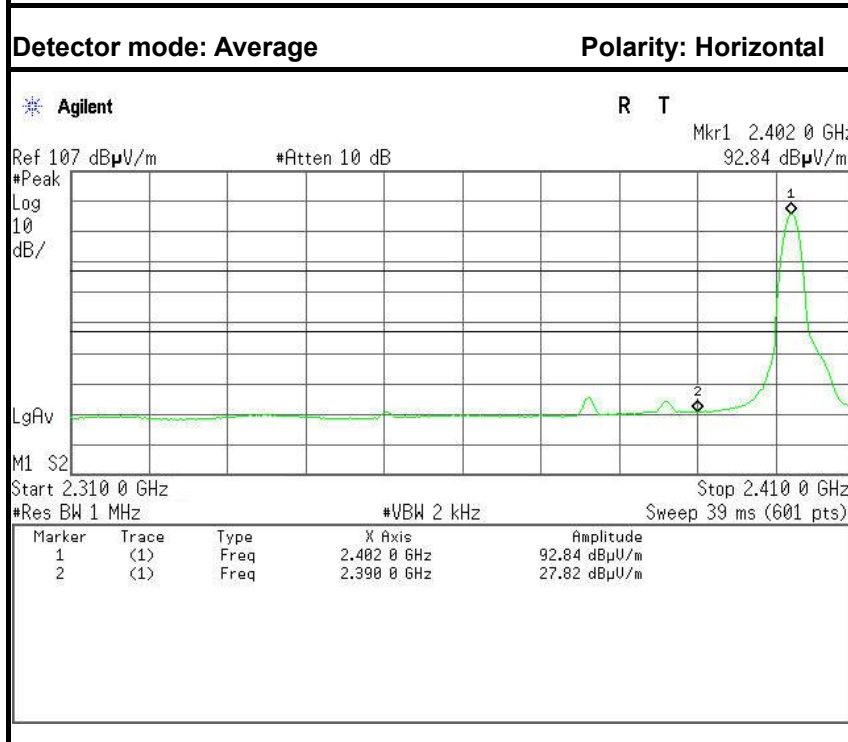
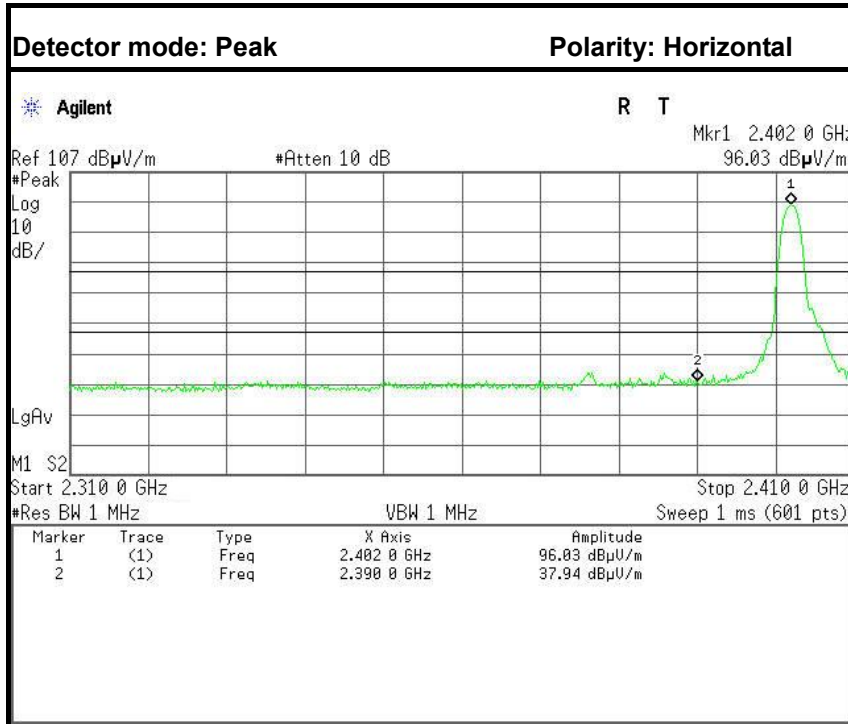

| No. | Frequency (MHz) | Reading (dB μ V) | Corrected (dB) | Result (dB μ V) | Limit (dB μ V) | Margin (dB) | Detector | Antenna Pole |
|-----|-----------------|----------------------|----------------|---------------------|--------------------|-------------|----------|--------------|
| 1 | 2390.0000 | 31.34 | -6.60 | 37.94 | 74.00 | -36.06 | Peak | Horizontal |
| 2 | 2390.0000 | 21.22 | -6.60 | 27.82 | 54.00 | -26.18 | Average | Horizontal |



Band Edges (CH-High)

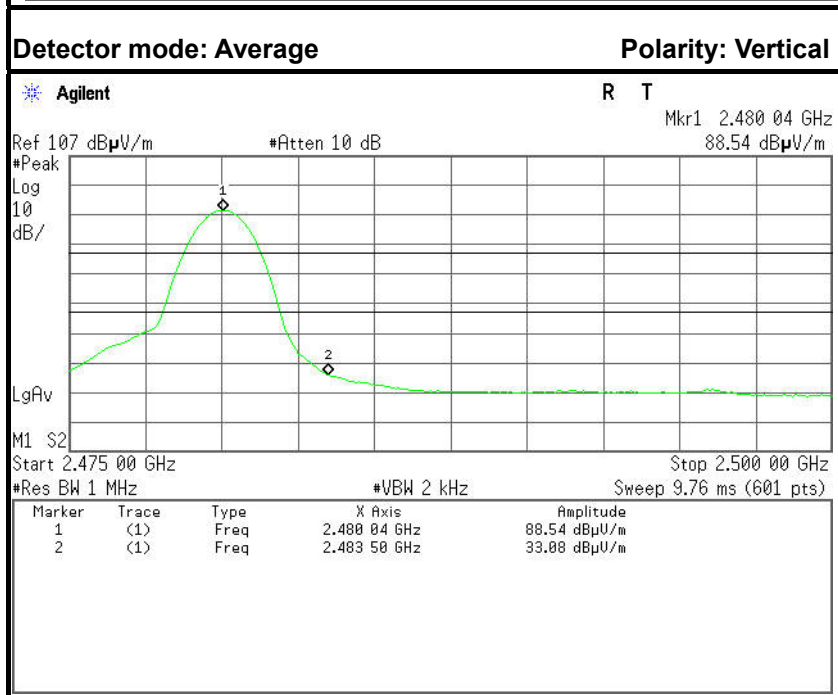
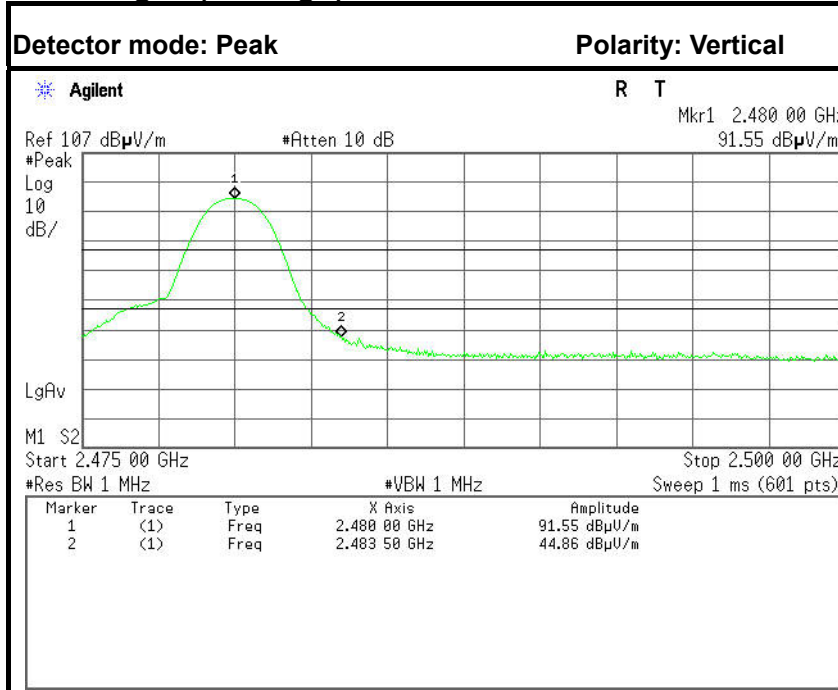

| No. | Frequency (MHz) | Reading (dBuV) | Corrected (dB) | Result (dBuV) | Limit (dBuV) | Margin (dB) | Detector | Antenna Pole |
|-----|-----------------|----------------|----------------|---------------|--------------|-------------|----------|--------------|
| 1 | 2483.5000 | 38.62 | -6.24 | 44.86 | 74.00 | -29.14 | Peak | Vertical |
| 2 | 2483.5000 | 26.84 | -6.24 | 33.08 | 54.00 | -20.92 | Average | Vertical |

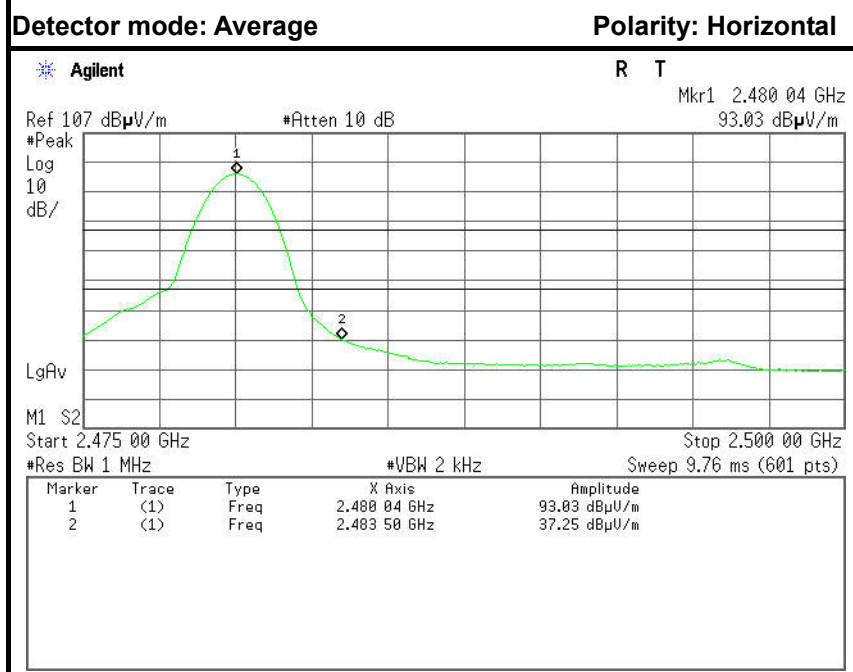
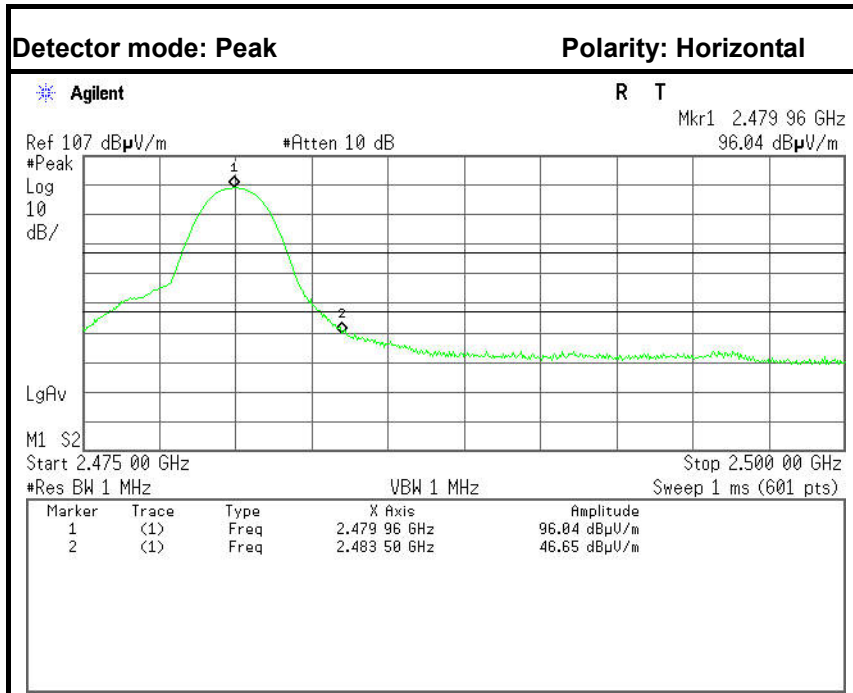

| No. | Frequency (MHz) | Reading (dBuV) | Corrected (dB) | Result (dBuV) | Limit (dBuV) | Margin (dB) | Detector | Antenna Pole |
|-----|-----------------|----------------|----------------|---------------|--------------|-------------|----------|--------------|
| 1 | 2483.5000 | 40.41 | -6.24 | 46.65 | 74.00 | -27.35 | Peak | Horizontal |
| 2 | 2483.5000 | 31.01 | -6.24 | 37.25 | 54.00 | -16.75 | Average | Horizontal |



6.5 FREQUENCY SEPARATION

LIMIT

According to §15.247(a)(1), Frequency hopping systems shall have hopping channel carrier frequencies separated by a minimum of 25 kHz or the 20 dB bandwidth of the hopping channel, whichever is greater. Alternatively, frequency hopping systems operating in the 2400-2483.5 MHz band may have hopping channel carrier frequencies that are separated by 25 kHz or two-thirds of the 20 dB bandwidth of the hopping channel, whichever is greater, provided the systems operate with an output power no greater than 125 mW.

MEASUREMENT EQUIPMENT USED

| Name of Equipment | Manufacturer | Model | Serial Number | Last Calibration | Due Calibration |
|-------------------|--------------|--------|---------------|------------------|-----------------|
| Spectrum Analyzer | Agilent | E4446A | US44300399 | 03/01/2014 | 03/01/2015 |

Remark: Each piece of equipment is scheduled for calibration once a year.

Test Configuration

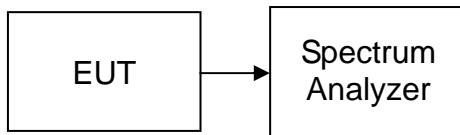

TEST PROCEDURE

1. Place the EUT on the table and set it in transmitting mode.
2. Remove the antenna from the EUT and then connect a low loss RF cable from the antenna port to the spectrum analyzer.
3. Set center frequency of spectrum analyzer = middle of hopping channel.
4. Set the spectrum analyzer as RBW=30kHz, VBW=30kHz, Adjust Span to 4 MHz, Sweep = auto.
5. Max hold. Mark 3 Peaks of hopping channel and record the 3 peaks frequency.

TEST RESULTS

No non-compliance noted

Test Data

GFSK

| Channel Separation (MHz) | Two-thirds of the 20 dB Bandwidth (kHz) | Channel Separation Limit | Result |
|--------------------------|---|-------------------------------------|--------|
| 1.000 | 563.207 | > Two-thirds of the 20 dB Bandwidth | Pass |

8DPSK

| Channel Separation (MHz) | Two-thirds of the 20 dB Bandwidth (kHz) | Channel Separation Limit | Result |
|--------------------------|---|-------------------------------------|--------|
| 1.000 | 806.667 | > Two-thirds of the 20 dB Bandwidth | Pass |



GFSK

Test Plot

Measurement of Channel Separation

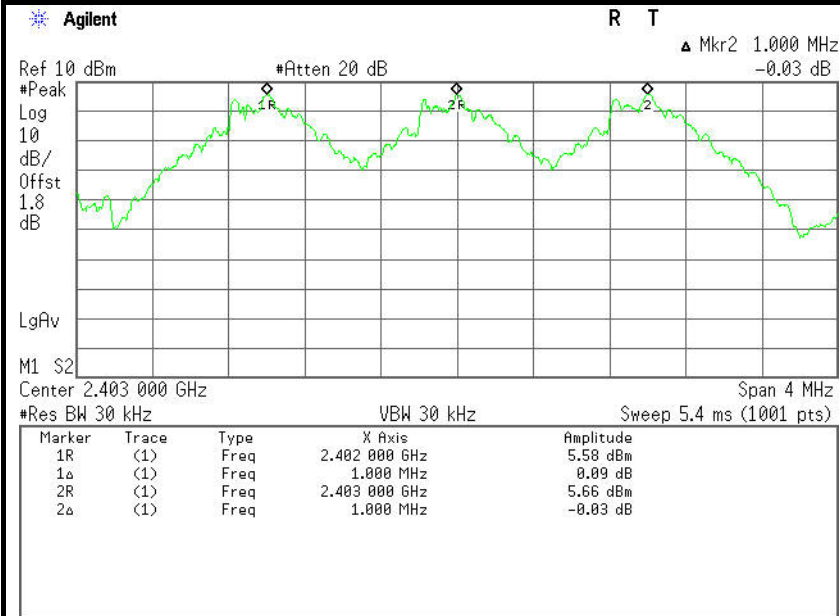

20 dB bandwidth(CH Low)

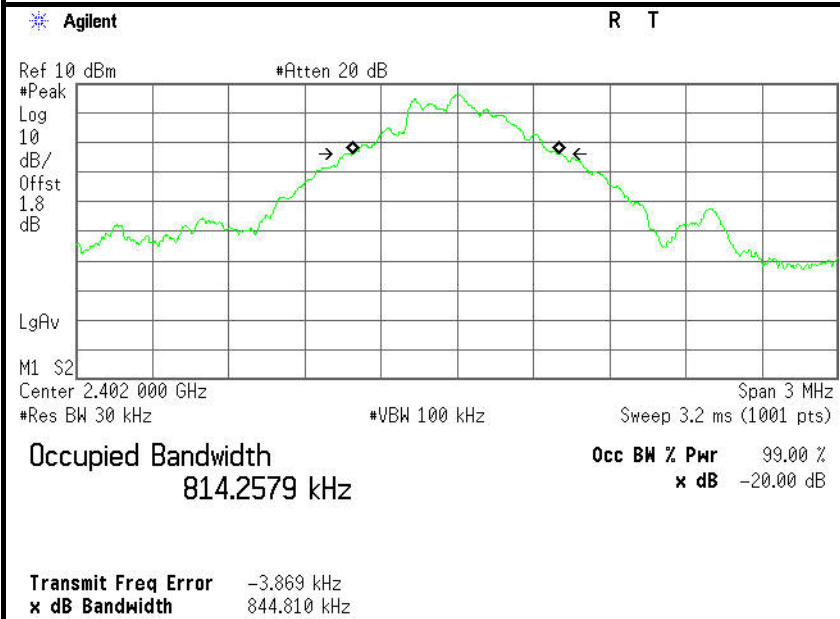



8DPSK

Test Plot

Measurement of Channel Separation

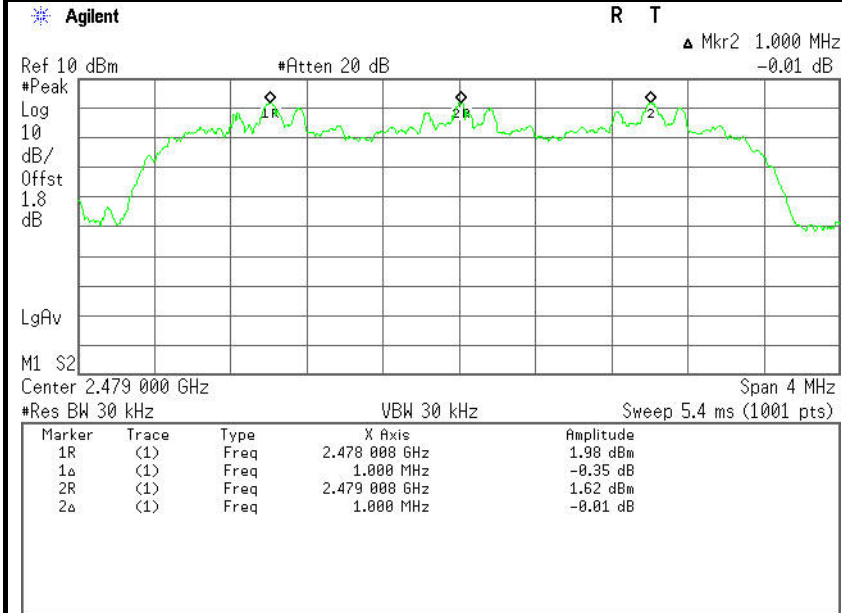

20 dB bandwidth(CH High)

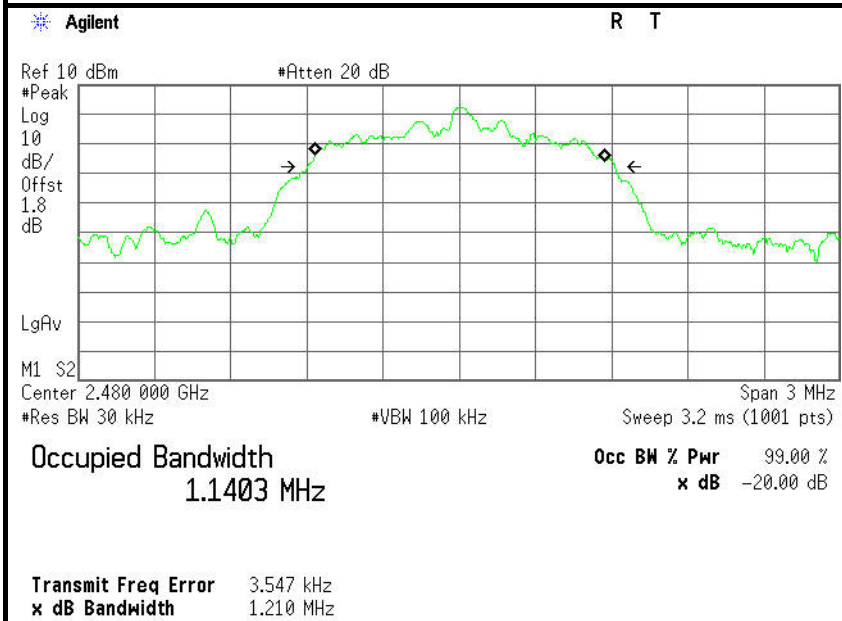



6.6 NUMBER OF HOPPING FREQUENCY

LIMIT

According to §15.247(a)(1)(ii), Frequency hopping systems operating in the 2400MHz-2483.5 MHz bands shall use at least 15 hopping frequencies.

MEASUREMENT EQUIPMENT USED

| Name of Equipment | Manufacturer | Model | Serial Number | Last Calibration | Due Calibration |
|-------------------|--------------|--------|---------------|------------------|-----------------|
| Spectrum Analyzer | Agilent | E4446A | US44300399 | 03/01/2014 | 03/01/2015 |

Remark: Each piece of equipment is scheduled for calibration once a year.

Test Configuration

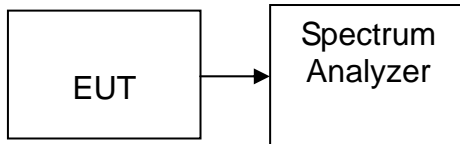

TEST PROCEDURE

1. Place the EUT on the table and set it in transmitting mode.
2. Remove the antenna from the EUT and then connect a low loss RF cable from the antenna port to the spectrum analyzer.
3. Set spectrum analyzer Start=2400MHz, Stop = 2441.5MHz, Sweep = 1ms and Start=2441.5MHz, Stop = 2483.5MHz, Sweep = 1ms.
4. Set the spectrum analyzer as RBW, VBW=300kHz,
5. Max hold, view and count how many channel in the band.

TEST RESULTS

No non-compliance noted

Test Data

| Result (No. of CH) | Limit (No. of CH) | Result |
|--------------------|-------------------|--------|
| 79 | >15 | PASS |



Test Plot

Channel Number

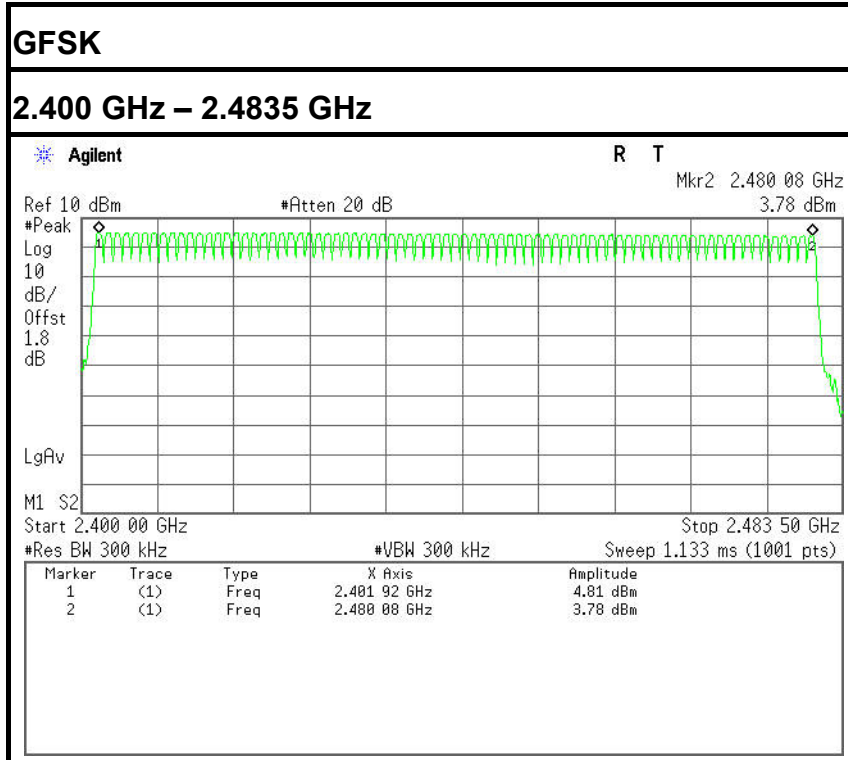

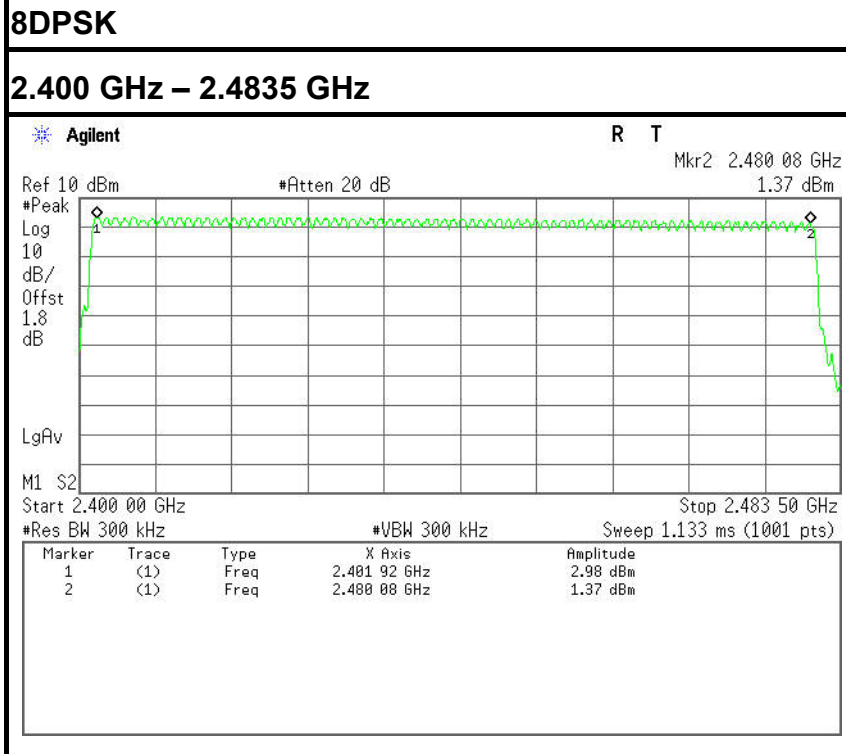



6.7 TIME OF OCCUPANCY (DWELL TIME)

LIMIT

According to §15.247(a)(1)(iii), Frequency hopping systems operating in the 2400MHz-2483.5 MHz bands. The average time of occupancy on any channels shall not greater than 0.4 s within a period 0.4 s multiplied by the number of hopping channels employed.

MEASUREMENT EQUIPMENT USED

| Name of Equipment | Manufacturer | Model | Serial Number | Last Calibration | Due Calibration |
|-------------------|--------------|--------|---------------|------------------|-----------------|
| Spectrum Analyzer | Agilent | E4446A | US44300399 | 03/01/2014 | 03/01/2015 |

Remark: Each piece of equipment is scheduled for calibration once a year.

Test Configuration

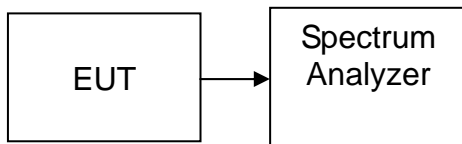

TEST PROCEDURE

1. Place the EUT on the table and set it in transmitting mode.
2. Remove the antenna from the EUT and then connect a low loss RF cable from the antenna port to the spectrum analyzer.
3. Set center frequency of spectrum analyzer = operating frequency.
4. Set the spectrum analyzer as RBW, VBW=1MHz, Span = 0Hz, Sweep = auto.
5. Repeat above procedures until all frequency measured were complete.



TEST RESULTS

No non-compliance noted

Test Data

GFSK

DH 1

CH Mid: $0.524 * (1600/2)/79 * 31.6 = 167.680(\text{ms})$

| CH | Pulse Time (ms) | Total of Dwell (ms) | Period Time (s) | Limit (ms) | Result |
|-----|-----------------|---------------------|-----------------|------------|--------|
| Mid | 0.524 | 167.680 | 31.60 | 400.00 | PASS |

DH 3

CH Mid: $1.779 * (1600/4)/79 * 31.6 = 284.640 (\text{ms})$

| CH | Pulse Time (ms) | Total of Dwell (ms) | Period Time (s) | Limit (ms) | Result |
|-----|-----------------|---------------------|-----------------|------------|--------|
| Mid | 1.779 | 284.640 | 31.60 | 400.00 | PASS |

DH 5

CH Mid: $3.035 * (1600/6)/79 * 31.6 = 323.733(\text{ms})$

| CH | Pulse Time (ms) | Total of Dwell (ms) | Period Time (s) | Limit (ms) | Result |
|-----|-----------------|---------------------|-----------------|------------|--------|
| Mid | 3.035 | 323.733 | 31.60 | 400.00 | PASS |



Test Data

8DPSK

DH 1

CH Mid: $0.535 * (1600/2)/79 * 31.6 = 171.200$ (ms)

| CH | Pulse Time (ms) | Total of Dwell (ms) | Period Time (s) | Limit (ms) | Result |
|-----|-----------------|---------------------|-----------------|------------|--------|
| Mid | 0.535 | 171.200 | 31.60 | 400.00 | PASS |

DH 3

CH Mid: $1.788 * (1600/4)/79 * 31.6 = 286.080$ (ms)

| CH | Pulse Time (ms) | Total of Dwell (ms) | Period Time (s) | Limit (ms) | Result |
|-----|-----------------|---------------------|-----------------|------------|--------|
| Mid | 1.788 | 286.080 | 31.60 | 400.00 | PASS |

DH 5

CH Mid: $3.040 * (1600/6)/79 * 31.6 = 324.267$ (ms)

| CH | Pulse Time (ms) | Total of Dwell (ms) | Period Time (s) | Limit (ms) | Result |
|-----|-----------------|---------------------|-----------------|------------|--------|
| Mid | 3.040 | 324.267 | 31.60 | 400.00 | PASS |



Test Plot

GFSK

DH 1

CH Mid

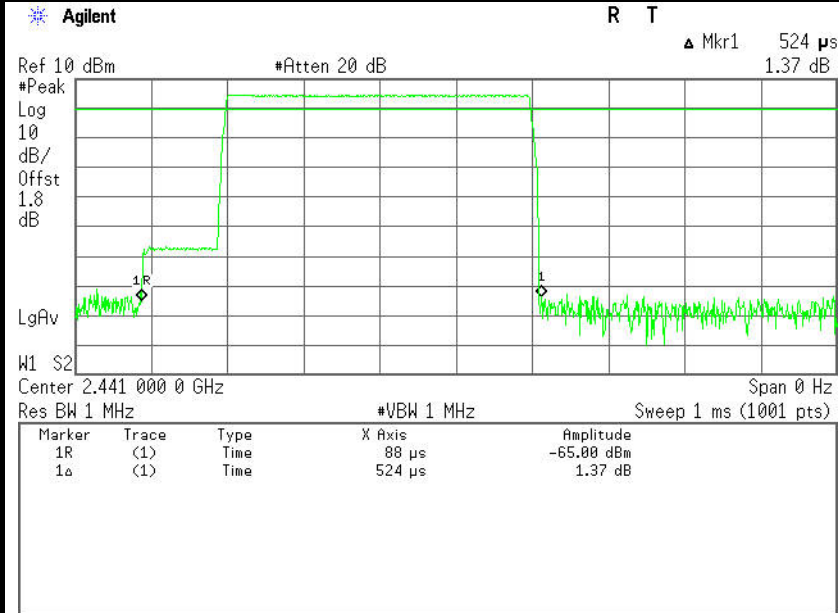

DH 3

CH Mid

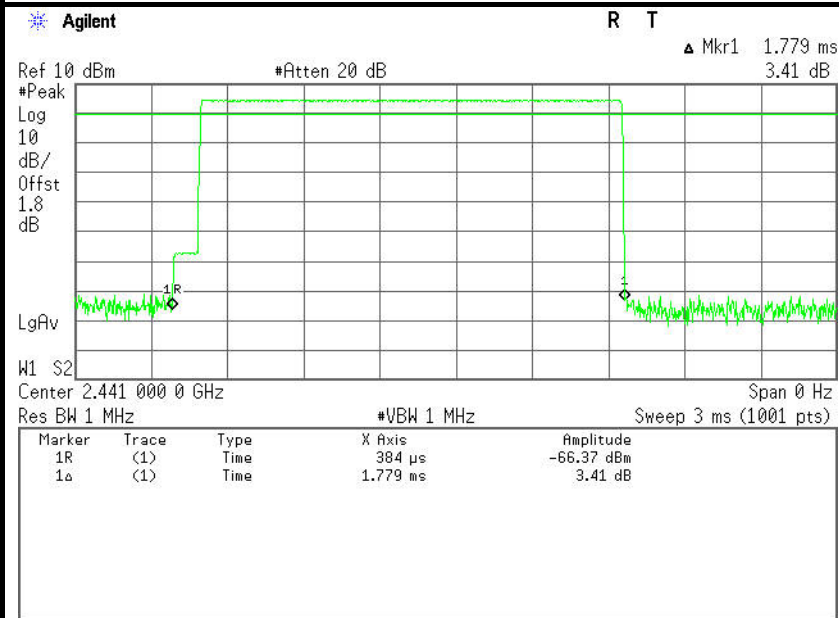



DH 5

CH Mid

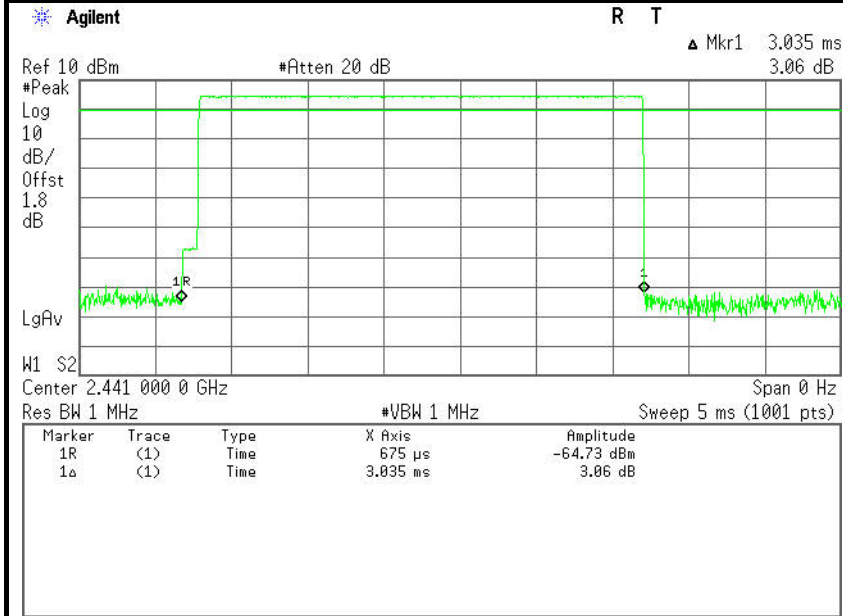



Test Plot
8DPSK

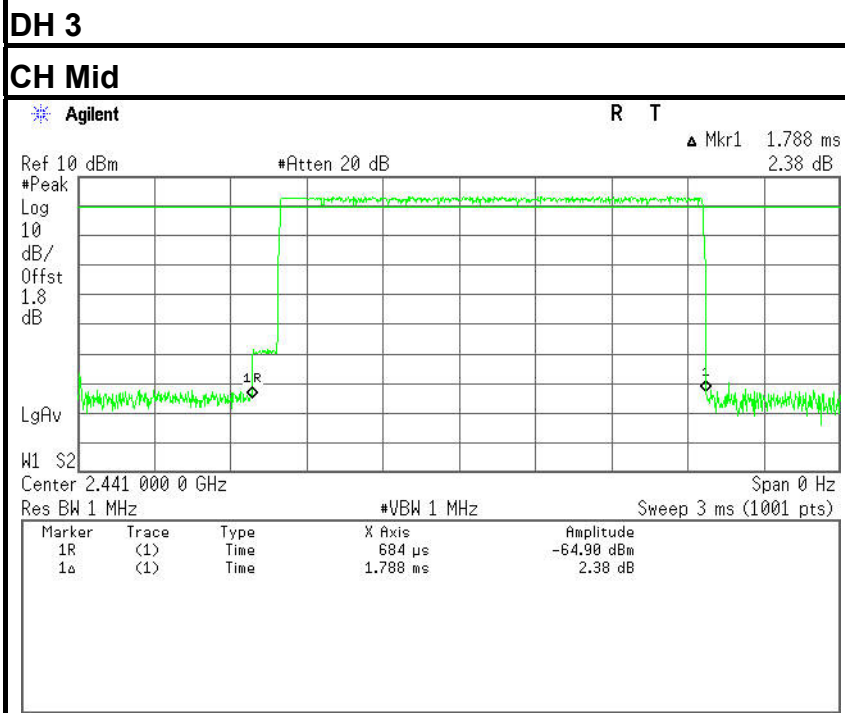
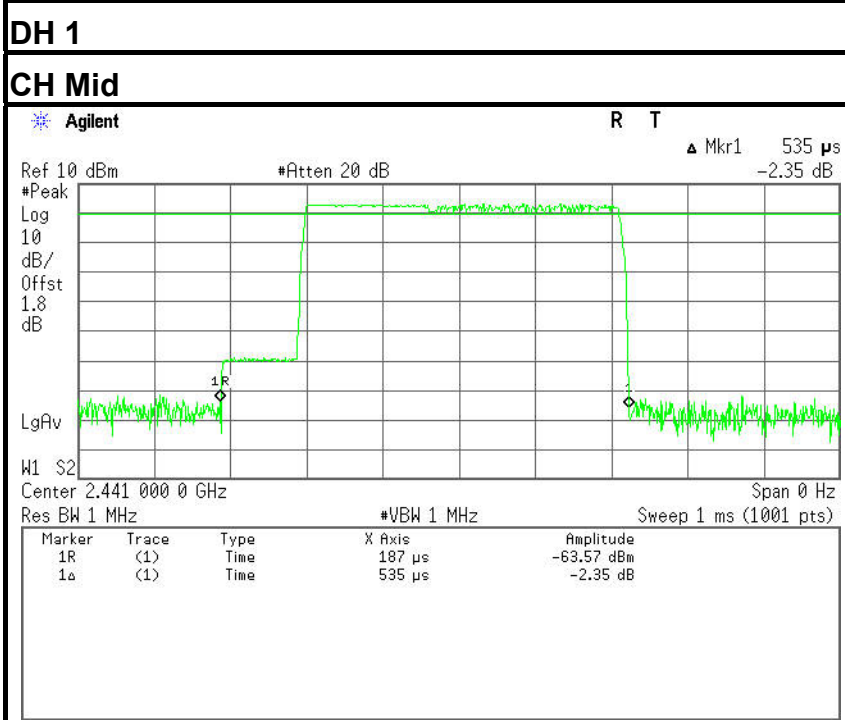

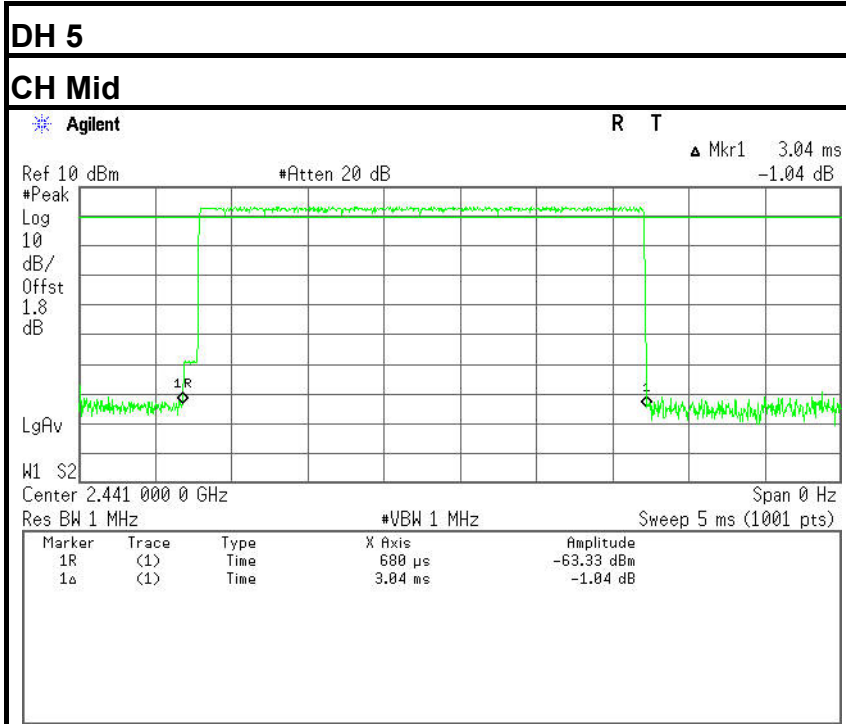



6.8 SPURIOUS EMISSIONS

6.8.1. Conducted Measurement

LIMIT

In any 100 kHz bandwidth outside the frequency band in which the spread spectrum or digitally modulated intentional radiator is operating, the radio frequency power that is produced by the intentional radiator shall be at least 20 dB below that in the 100 kHz bandwidth within the band that contains the highest level of the desired power, based on either an RF conducted or a radiated measurement. Attenuation below the general limits specified in Section 15.209(a) is not required. In addition, radiated emissions which fall in the restricted bands, as defined in Section 15.205(a), must also comply with the radiated emission limits specified in Section 15.209(a) (see Section 15.205(c)).

MEASUREMENT EQUIPMENT USED

| Name of Equipment | Manufacturer | Model | Serial Number | Last Calibration | Due Calibration |
|-------------------|--------------|--------|---------------|------------------|-----------------|
| Spectrum Analyzer | Agilent | E4446A | US44300399 | 03/01/2014 | 03/01/2015 |

Remark: Each piece of equipment is scheduled for calibration once a year.

Test Configuration

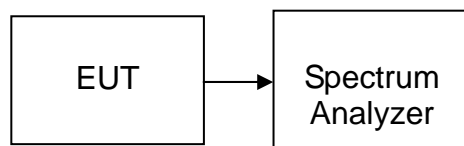

TEST PROCEDURE

Conducted RF measurements of the transmitter output were made to confirm that the EUT antenna port conducted emissions meet the specified limit and to identify any spurious signals that require further investigation or measurements on the radiated emissions site.

The transmitter output is connected to the spectrum analyzer. The resolution bandwidth is set to 100 kHz. The video bandwidth is set to 100 kHz.

Measurements are made over the 30MHz to 26GHz range with the transmitter set to the lowest, middle, and highest channels.

TEST RESULTS

No non-compliance noted



Test Plot (GFSK)

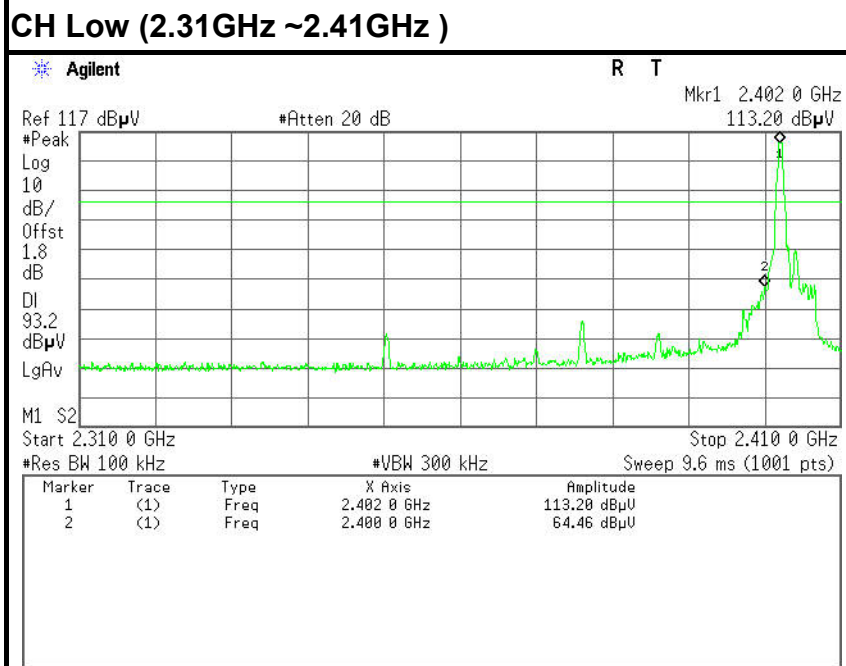
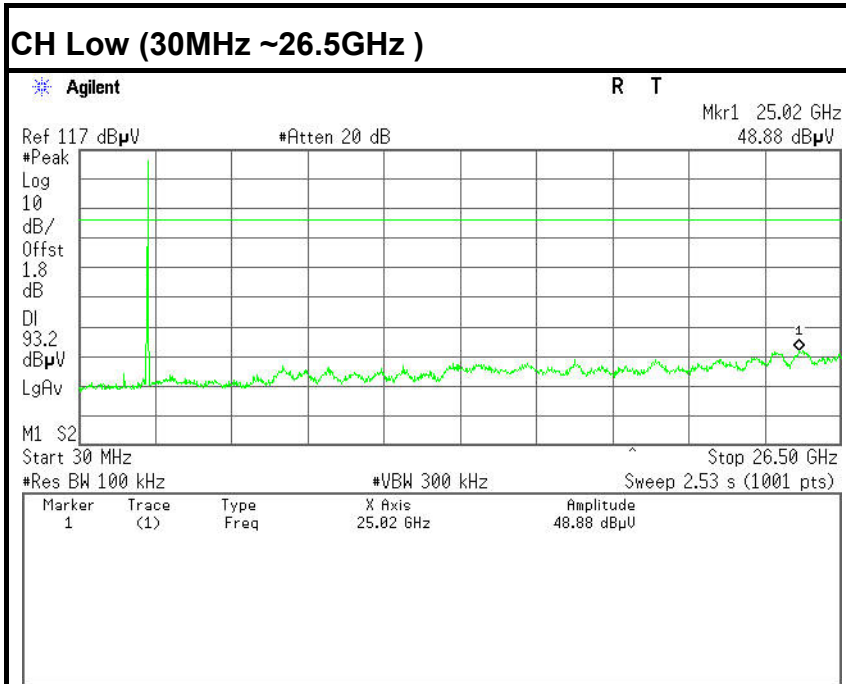

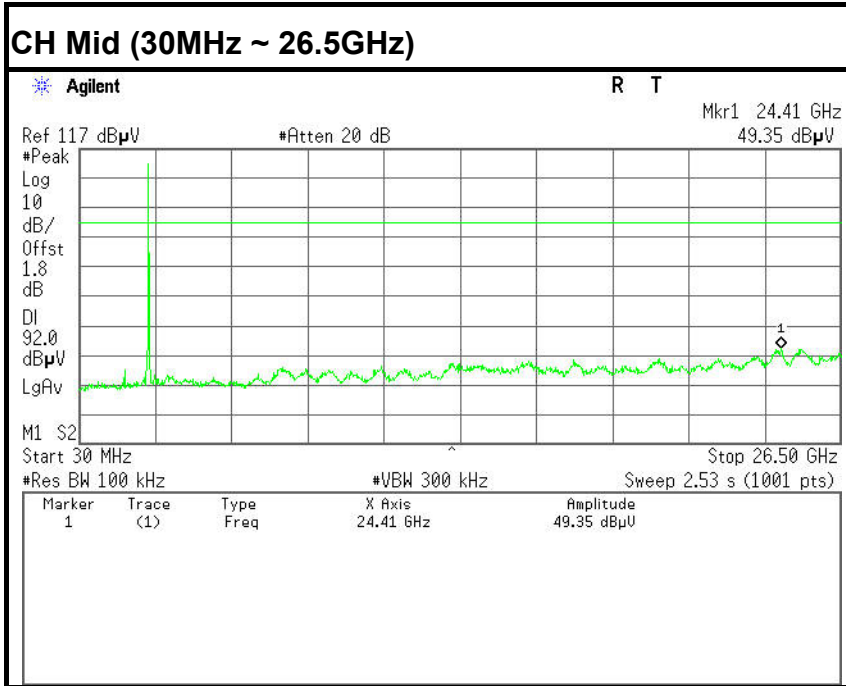



CH High (30MHz ~ 26.5GHz)

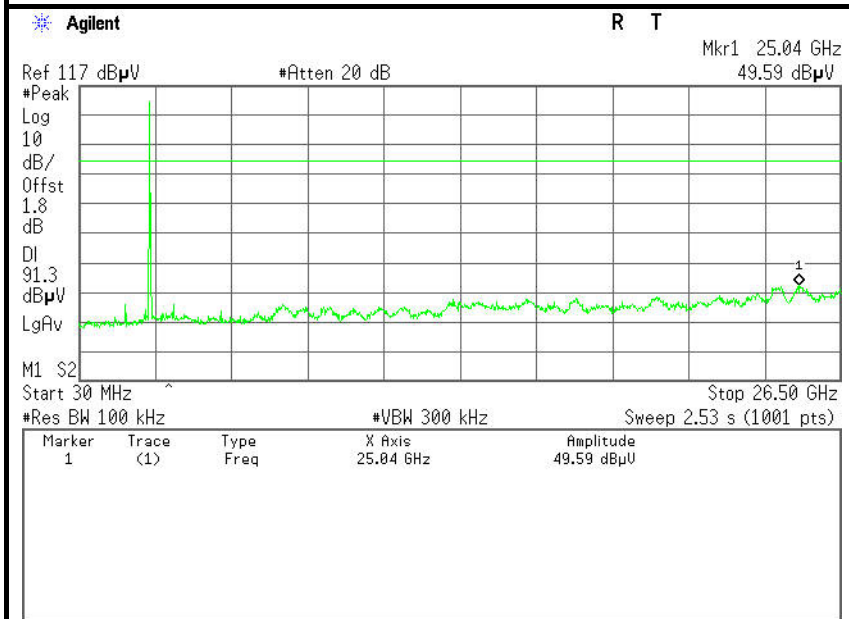

CH High (2.475GHz ~ 2.5GHz)

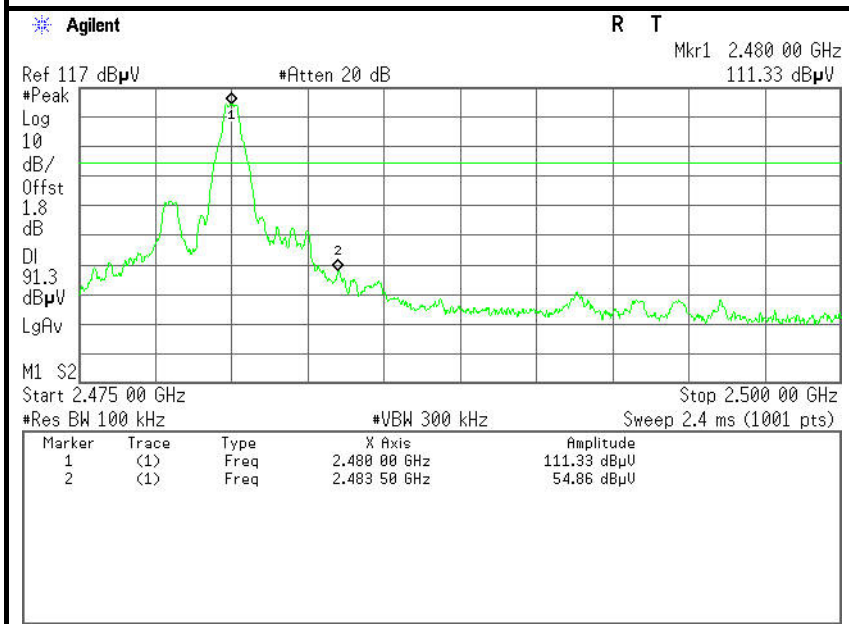



Test Plot (8DPSK)

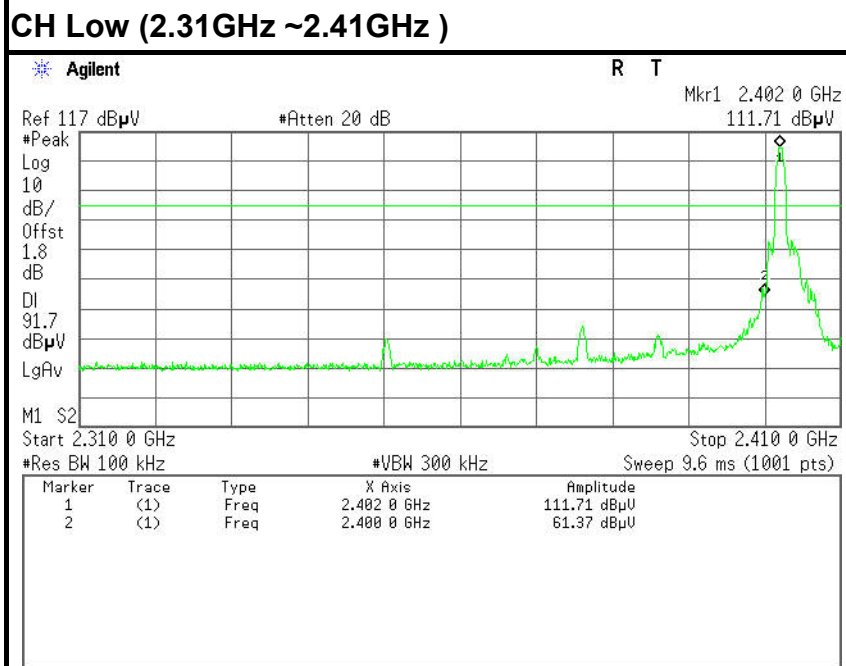
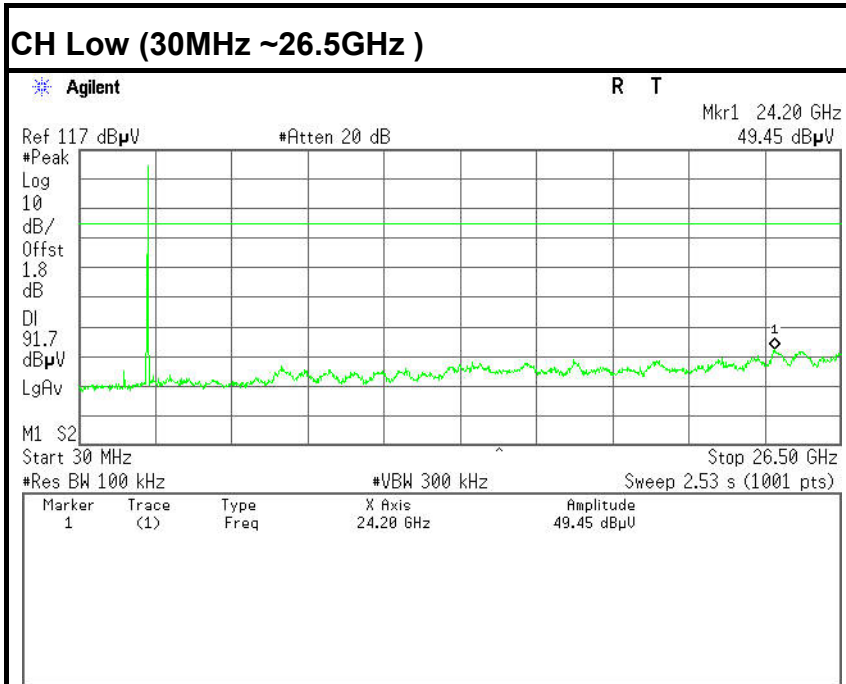

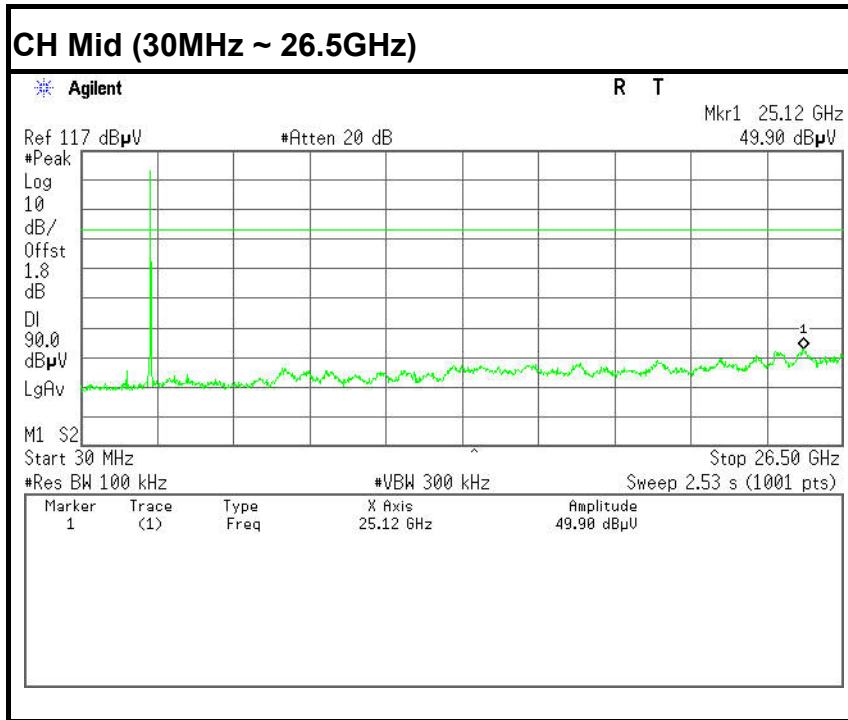



CH High (30MHz ~ 26.5GHz)

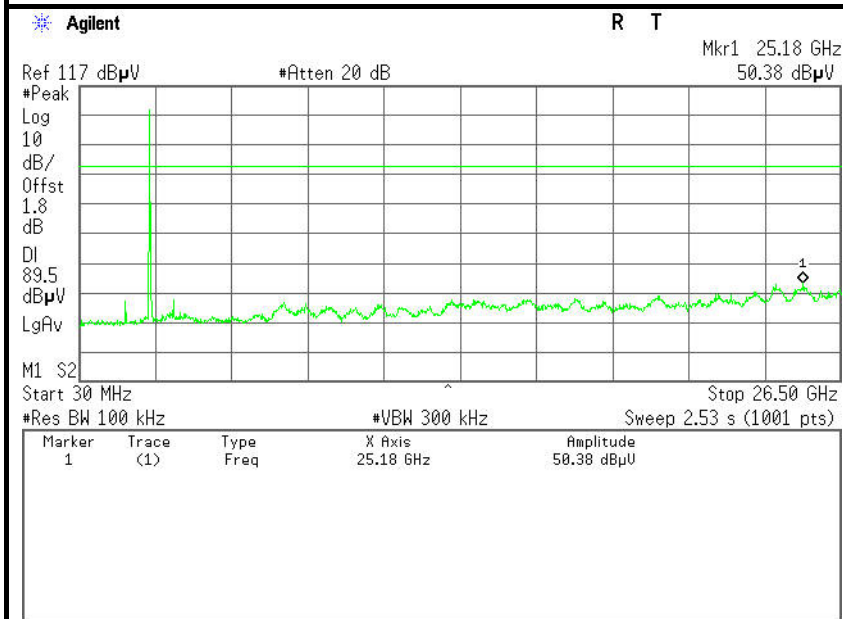

CH High (2.475GHz ~ 2.5GHz)

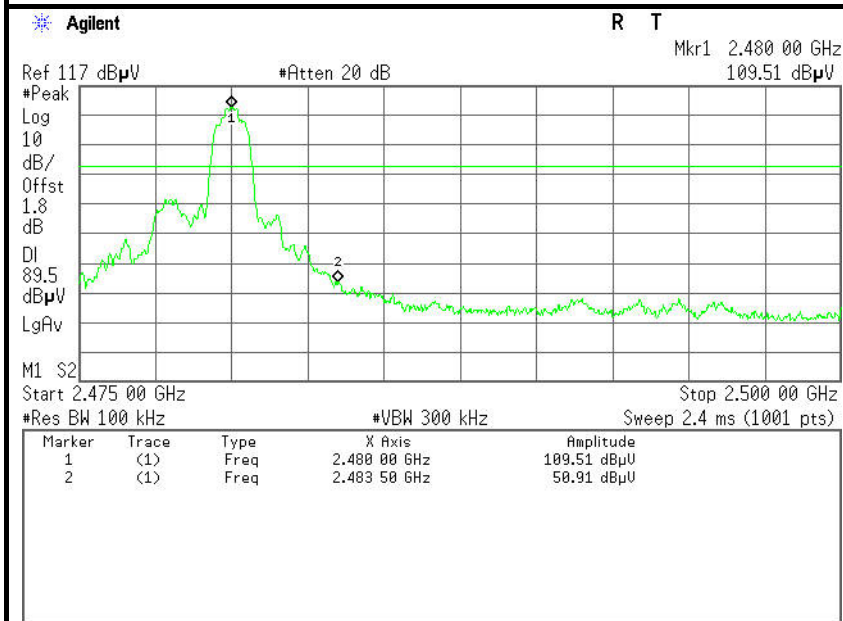



6.8.2. Radiated Emissions

LIMIT

1. Except as provided elsewhere in this Subpart, the emissions from an intentional radiator shall not exceed the field strength levels specified in the following table:

| Frequency (MHz) | Field Strength (mV/m) | Measurement Distance (m) |
|-----------------|-----------------------|--------------------------|
| 0.009-0.490 | 2400/F(kHz) | 300 |
| 0.490-1.705 | 24000/F(kHz) | 30 |
| 1.705-30.0 | 30 | 30 |
| 30-88 | 100* | 3 |
| 88-216 | 150* | 3 |
| 216-960 | 200* | 3 |
| Above 960 | 500 | 3 |

Note: Except as provided in paragraph (g), fundamental emissions from intentional radiators operating under this Section shall not be located in the frequency bands 54-72 MHz, 76-88 MHz, 174-216 MHz or 470-806 MHz. However, operation within these frequency bands is permitted under other sections of this Part, e.g., Sections 15.231 and 15.241.

2. In the above emission table, the tighter limit applies at the band edges.

| Frequency (Hz) | Field Strength (μ V/m at 3-meter) | Field Strength (dB μ V/m at 3-meter) |
|----------------|--|--|
| 30-88 | 100 | 40 |
| 88-216 | 150 | 43.5 |
| 216-960 | 200 | 46 |
| Above 960 | 500 | 54 |



MEASUREMENT EQUIPMENT USED

| Radiated Emission Test Site 966 (2) | | | | | |
|--|---------------------|---------------------|----------------------|-------------------------|------------------------|
| Name of Equipment | Manufacturer | Model Number | Serial Number | Last Calibration | Due Calibration |
| PSA Series Spectrum Analyzer | Agilent | E4446A | US44300399 | 03/01/2014 | 03/01/2015 |
| EMI TEST RECEIVER | ROHDE&SCHWARZ | ESCI | 100783 | 03/09/2014 | 03/08/2015 |
| Amplifier | MITEQ | AM-1604-3000 | 1123808 | 03/18/2015 | 03/18/2015 |
| High Noise Amplifier | Agilent | 8449B | 3008A01838 | 03/18/2015 | 03/18/2015 |
| Board-Band Horn Antenna | Schwarzbeck | BBHA 9170 | 9170-497 | 07/10/2013 | 07/09/2014 |
| Bilog Antenna | SCHAFFNER | CBL6143 | 5082 | 03/01/2014 | 03/01/2015 |
| Horn Antenna | SCHWARZBECK | BBHA9120 | D286 | 03/01/2014 | 03/01/2015 |
| Loop Antenna | A, R, A | PLA-1030/B | 1029 | 09/27/2013 | 09/26/2014 |
| Turn Table | N/A | N/A | N/A | N.C.R | N.C.R |
| Controller | Sunol Sciences | SC104V | 022310-1 | N.C.R | N.C.R |
| Controller | CT | N/A | N/A | N.C.R | N.C.R |
| Temp. / Humidity Meter | Anymetre | JR913 | N/A | 02/28/2014 | 02/28/2015 |
| Antenna Tower | SUNOL | TLT2 | N/A | N.C.R | N.C.R |
| Test S/W | FARAD | LZ-RF / CCS-SZ-3A2 | | | |

Remark: Each piece of equipment is scheduled for calibration once a year.



Test Configuration

Below 30MHz

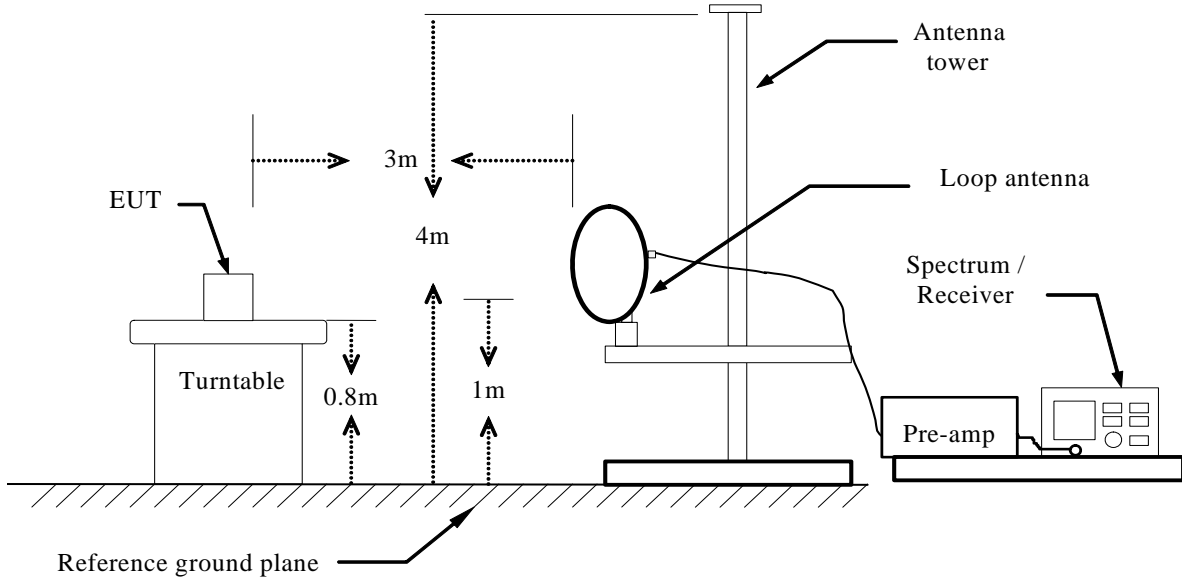

Below 1 GHz

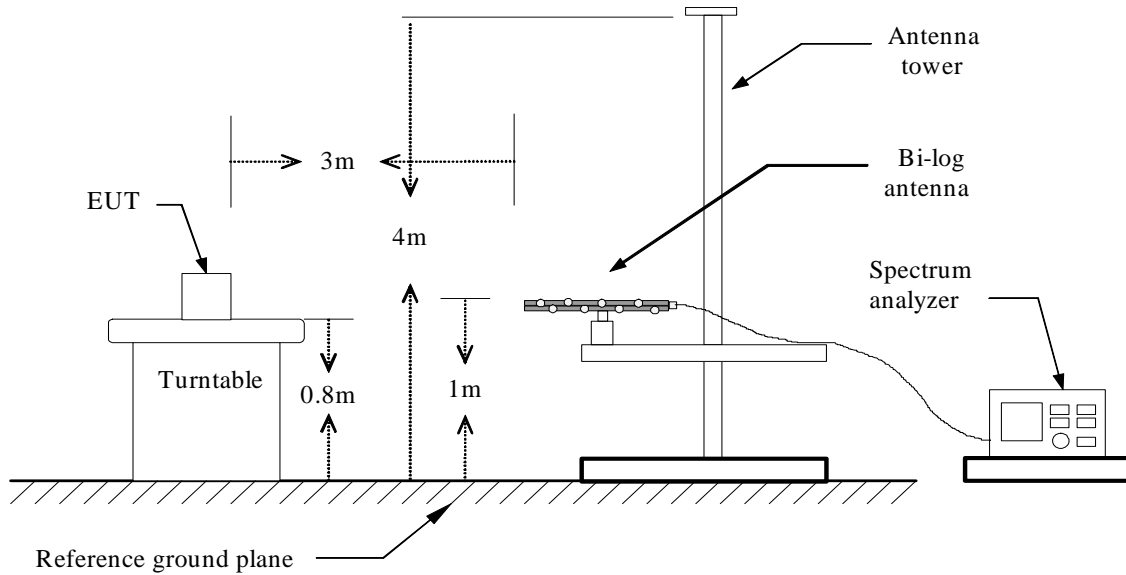



Above 1 GHz

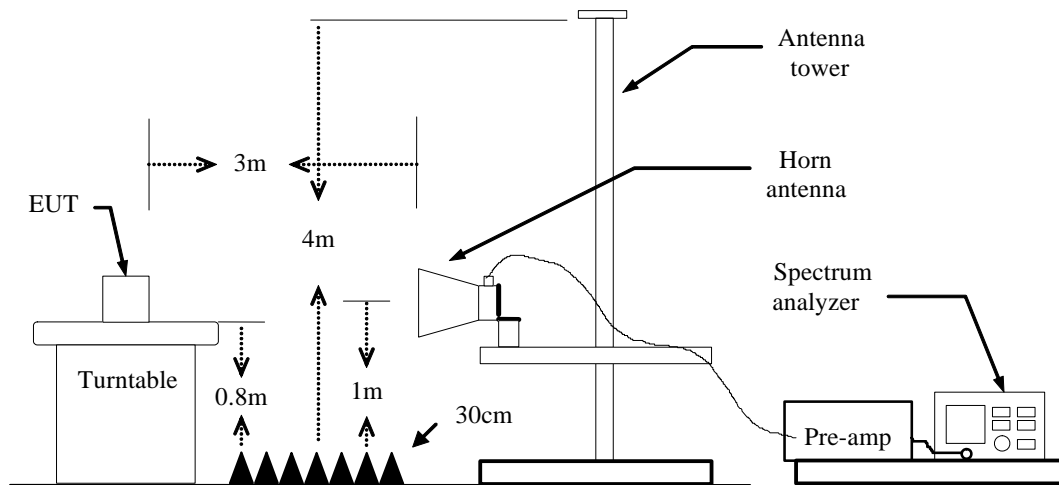

TEST PROCEDURE

1. The EUT is placed on a turntable, which is 0.8m above ground plane.
2. The turntable shall be rotated for 360 degrees to determine the position of maximum emission level.
3. EUT is set 3m away from the receiving antenna, which is varied from 1m to 4m to find out the highest emissions.
4. Maximum procedure was performed on the six highest emissions to ensure EUT compliance.
5. And also, each emission was to be maximized by changing the polarization of receiving antenna both horizontal and vertical.
6. Repeat above procedures until the measurements for all frequencies are complete.



TEST RESULTS

Below 1 GHz

Test Mode: TX

Tested by: Mack Li

Ambient temperature: 24°C Relative humidity: 52% RH

Date: May 5, 2014

| Frequency (MHz) | Reading (dBuV) | Correction Factor (dB/m) | Result (dBuV/m) | Limit (dBuV/m) | Margin (dB) | Antenna Pole (V/H) | Remark |
|-----------------|----------------|--------------------------|-----------------|----------------|-------------|--------------------|--------|
| 30.9700 | 45.91 | -12.22 | 33.69 | 40.00 | -6.31 | V | QP |
| 53.2800 | 55.42 | -22.18 | 33.24 | 40.00 | -6.76 | V | QP |
| 192.9600 | 45.63 | -22.82 | 22.81 | 43.50 | -20.69 | V | QP |
| 278.3200 | 41.46 | -20.41 | 21.05 | 46.00 | -24.95 | V | QP |
| 487.8400 | 37.57 | -14.36 | 23.21 | 46.00 | -22.79 | V | QP |
| 687.6600 | 34.10 | -12.25 | 21.85 | 46.00 | -24.15 | V | QP |
| 36.7900 | 45.12 | -15.21 | 29.91 | 40.00 | -10.09 | H | QP |
| 256.0100 | 47.82 | -20.38 | 27.44 | 46.00 | -18.56 | H | QP |
| 319.0600 | 45.20 | -18.95 | 26.25 | 46.00 | -19.75 | H | QP |
| 384.0500 | 44.10 | -16.45 | 27.65 | 46.00 | -18.35 | H | QP |
| 423.8200 | 48.75 | -15.48 | 33.27 | 46.00 | -12.73 | H | QP |
| 487.8400 | 44.38 | -14.36 | 30.02 | 46.00 | -15.98 | H | QP |

****Remark:** No emission found between lowest internal used/generated frequency to 30MHz.

Notes:

1. Measuring frequencies from 9kHz to the 1GHz.
2. Radiated emissions measured in frequency range from 30MHz to 1GHz were made with an instrument using Peak/Quasi-peak detector mode.
3. Data of measurement within this frequency range shown " --- " in the table above means the reading of emissions are attenuated more than 20dB below the permissible limits or the field strength is too small to be measured.
4. The IF bandwidth of SPA between 30MHz to 1GHz was 120kHz.
5. Frequency (MHz). = Emission frequency in MHz
Reading (dBuV) = Receiver reading
Correction Factor(dB/m) = Antenna factor + Cable loss – Amplifier gain
Actual FS (dBuV/m) = Reading (dBuV) + Corr. Factor (dB/m)
Limit (dBuV/m) = Limit stated in standard
Margin(dB) = Measured (dBuV/m) – Limits (dBuV/m)
Antenna Pole(V/H) = Current carrying line of reading



Above 1 GHz
GFSK

Test Mode: TX(CH Low)

Tested by: Mack Li

Ambient temperature: 24°C Relative humidity: 52% RH

Date: May 5, 2014

| Frequency (MHz) | Reading (dBuV) | Correction Factor (dB/m) | Result (dBuV/m) | Limit (dBuV/m) | Margin (dB) | Antenna Pole (V/H) | Remark |
|-----------------|----------------|--------------------------|-----------------|----------------|-------------|--------------------|--------|
| 1600.0000 | 57.35 | -8.38 | 48.97 | 74.00 | -25.03 | V | peak |
| 3850.0000 | 42.95 | -0.68 | 42.27 | 74.00 | -31.73 | V | peak |
| 5365.0000 | 40.58 | 4.25 | 44.83 | 74.00 | -29.17 | V | peak |
| 6010.0000 | 40.76 | 7.59 | 48.35 | 74.00 | -25.65 | V | peak |
| 6955.0000 | 41.34 | 7.15 | 48.49 | 74.00 | -25.51 | V | peak |
| 8485.0000 | 40.86 | 8.16 | 49.02 | 74.00 | -24.98 | V | peak |
| 1600.0000 | 56.22 | -8.38 | 47.84 | 74.00 | -26.16 | H | Peak |
| 3550.0000 | 44.01 | -0.98 | 43.03 | 74.00 | -30.97 | H | Peak |
| 5530.0000 | 40.80 | 4.56 | 45.36 | 74.00 | -28.64 | H | Peak |
| 6460.0000 | 40.79 | 7.38 | 48.17 | 74.00 | -25.83 | H | peak |
| 7720.0000 | 40.96 | 7.59 | 48.55 | 74.00 | -25.45 | H | peak |
| 8905.0000 | 41.46 | 8.50 | 49.96 | 74.00 | -24.04 | H | peak |

Notes:

1. Measuring frequencies from 1 GHz to the 10th harmonic of highest fundamental frequency.
2. Measurements above show only up to 6 maximum emissions noted, or would be lesser if no specific emissions from the EUT are recorded (ie: margin>20dB from the applicable limit) and considered that's already beyond the background noise floor.
3. Radiated emissions measured in frequency above 1000MHz were made with an instrument using Peak detector mode and average detector mode of the emission shown in Actual FS column.
4. Spectrum setting:
 - a. Peak Setting 1GHz - 26GHz, RBW = 1MHz, VBW = 1MHz, Sweep time = 200 ms.
 - b. AV Setting 1GH z- 26GHz, RBW = 1MHz, VBW = 10Hz, Sweep time = 200 ms.
5. Frequency (MHz) = Emission frequency in MHz
 Reading (dBuV/m) =Uncorrected Analyzer / Receiver Reading
 Correction Factor (dB) = Antenna factor + Cable loss – Amplifier gain
 Limit (dBuV/m) = Limit stated in standard
 Margin (dB) = Result (dBuV/m)- Limit (dBuV/m)
 Pk = Peak Reading
 AV. = Average Reading
 Remark = Mark Peak Reading or Average Reading



Test Mode: TX(CH Mid)

Tested by: Mack Li

Ambient temperature: 24°C Relative humidity: 52% RH

Date: May 5, 2014

| Frequency (MHz) | Reading (dBuV) | Correction Factor (dB/m) | Result (dBuV/m) | Limit (dBuV/m) | Margin (dB) | Antenna Pole (V/H) | Remark |
|-----------------|----------------|--------------------------|-----------------|----------------|-------------|--------------------|--------|
| 1630.0000 | 56.33 | -8.37 | 47.96 | 74.00 | -26.04 | V | peak |
| 3550.0000 | 42.71 | -0.98 | 41.73 | 74.00 | -32.27 | V | peak |
| 5260.0000 | 40.88 | 4.15 | 45.03 | 74.00 | -28.97 | V | peak |
| 6085.0000 | 41.35 | 7.55 | 48.90 | 74.00 | -25.10 | V | peak |
| 6940.0000 | 40.21 | 7.16 | 47.37 | 74.00 | -26.63 | V | peak |
| 8410.0000 | 39.81 | 8.10 | 47.91 | 74.00 | -26.09 | V | peak |
| 1630.0000 | 56.48 | -8.37 | 48.11 | 74.00 | -25.89 | H | Peak |
| 3550.0000 | 43.32 | -0.98 | 42.34 | 74.00 | -31.66 | H | Peak |
| 4855.0000 | 42.06 | 3.04 | 45.10 | 74.00 | -28.90 | H | Peak |
| 6160.0000 | 40.29 | 7.52 | 47.81 | 74.00 | -26.19 | H | peak |
| 6985.0000 | 40.72 | 7.14 | 47.86 | 74.00 | -26.14 | H | peak |
| 8380.0000 | 40.55 | 8.08 | 48.63 | 74.00 | -25.37 | H | peak |

Notes:

1. Measuring frequencies from 1 GHz to the 10th harmonic of highest fundamental frequency.
2. Measurements above show only up to 6 maximum emissions noted, or would be lesser if no specific emissions from the EUT are recorded (ie: margin>20dB from the applicable limit) and considered that's already beyond the background noise floor.
3. Radiated emissions measured in frequency above 1000MHz were made with an instrument using Peak detector mode and average detector mode of the emission shown in Actual FS column.
4. Spectrum setting:
 - a. Peak Setting 1GHz - 26GHz, RBW = 1MHz, VBW = 1MHz, Sweep time = 200 ms.
 - b. AV Setting 1GH z- 26GHz, RBW = 1MHz, VBW = 10Hz, Sweep time = 200 ms.
5. Frequency (MHz) = Emission frequency in MHz
 Reading (dBuV/m) =Uncorrected Analyzer / Receiver Reading
 Correction Factor (dB) = Antenna factor + Cable loss – Amplifier gain
 Limit (dBuV/m) = Limit stated in standard
 Margin (dB) = Result (dBuV/m)- Limit (dBuV/m)
 Pk = Peak Reading
 AV. = Average Reading
 Remark = Mark Peak Reading or Average Reading



Test Mode: TX(CH High)

Tested by: Mack Li

Ambient temperature: 24°C Relative humidity: 52% RH

Date: May 5, 2014

| Frequency (MHz) | Reading (dBuV) | Correction Factor (dB/m) | Result (dBuV/m) | Limit (dBuV/m) | Margin (dB) | Antenna Pole (V/H) | Remark |
|-----------------|----------------|--------------------------|-----------------|----------------|-------------|--------------------|--------|
| 1660.0000 | 54.92 | -8.37 | 46.55 | 74.00 | -27.45 | V | peak |
| 3550.0000 | 44.23 | -0.98 | 43.25 | 74.00 | -30.75 | V | peak |
| 4555.0000 | 41.88 | 1.21 | 43.09 | 74.00 | -30.91 | V | peak |
| 6145.0000 | 40.59 | 7.52 | 48.11 | 74.00 | -25.89 | V | peak |
| 7735.0000 | 41.24 | 7.60 | 48.84 | 74.00 | -25.16 | V | peak |
| 8995.0000 | 39.88 | 8.58 | 48.46 | 74.00 | -25.54 | V | peak |
| 1660.0000 | 54.47 | -8.37 | 46.10 | 74.00 | -27.90 | H | Peak |
| 3550.0000 | 43.64 | -0.98 | 42.66 | 74.00 | -31.34 | H | Peak |
| 4960.0000 | 41.45 | 3.68 | 45.13 | 74.00 | -28.87 | H | Peak |
| 6280.0000 | 40.62 | 7.46 | 48.08 | 74.00 | -25.92 | H | peak |
| 6955.0000 | 40.81 | 7.15 | 47.96 | 74.00 | -26.04 | H | peak |
| 8380.0000 | 40.57 | 8.08 | 48.65 | 74.00 | -25.35 | H | peak |

Notes:

1. Measuring frequencies from 1 GHz to the 10th harmonic of highest fundamental frequency.
2. Measurements above show only up to 6 maximum emissions noted, or would be lesser if no specific emissions from the EUT are recorded (ie: margin>20dB from the applicable limit) and considered that's already beyond the background noise floor.
3. Radiated emissions measured in frequency above 1000MHz were made with an instrument using Peak detector mode and average detector mode of the emission shown in Actual FS column.
4. Spectrum setting:
 - a. Peak Setting 1GHz - 26GHz, RBW = 1MHz, VBW = 1MHz, Sweep time = 200 ms.
 - b. AV Setting 1GH z- 26GHz, RBW = 1MHz, VBW = 10Hz, Sweep time = 200 ms.
5. Frequency (MHz) = Emission frequency in MHz
 Reading (dBuV/m) =Uncorrected Analyzer / Receiver Reading
 Correction Factor (dB) = Antenna factor + Cable loss – Amplifier gain
 Limit (dBuV/m) = Limit stated in standard
 Margin (dB) = Result (dBuV/m)- Limit (dBuV/m)
 Pk = Peak Reading
 AV. = Average Reading
 Remark = Mark Peak Reading or Average Reading



8DPSK

Test Mode: TX(CH Low)

Tested by: Mack Li

Ambient temperature: 24°C Relative humidity: 52% RH

Date: May 5, 2014

Table with 8 columns: Frequency (MHz), Reading (dBuV), Correction Factor (dB/m), Result (dBuV/m), Limit (dBuV/m), Margin (dB), Antenna Pole (V/H), Remark. It contains two sets of data rows for various frequencies.

Notes:

- 1. Measuring frequencies from 1 GHz to the 10th harmonic of highest fundamental frequency.
2. Measurements above show only up to 6 maximum emissions noted, or would be lesser if no specific emissions from the EUT are recorded...
3. Radiated emissions measured in frequency above 1000MHz were made with an instrument using Peak detector mode...
4. Spectrum setting:
a. Peak Setting 1GHz - 26GHz, RBW = 1MHz, VBW = 1MHz, Sweep time = 200 ms.
b. AV Setting 1GHz - 26GHz, RBW = 1MHz, VBW = 10Hz, Sweep time = 200 ms.
5. Frequency (MHz) = Emission frequency in MHz
Reading (dBuV/m) = Uncorrected Analyzer / Receiver Reading
Correction Factor (dB) = Antenna factor + Cable loss - Amplifier gain
Limit (dBuV/m) = Limit stated in standard
Margin (dB) = Result (dBuV/m) - Limit (dBuV/m)
Pk = Peak Reading
AV = Average Reading
Remark = Mark Peak Reading or Average Reading



Test Mode: TX(CH Mid)

Tested by: Mack Li

Ambient temperature: 24°C Relative humidity: 52% RH

Date: May 5, 2014

| Frequency (MHz) | Reading (dBuV) | Correction Factor (dB/m) | Result (dBuV/m) | Limit (dBuV/m) | Margin (dB) | Antenna Pole (V/H) | Remark |
|-----------------|----------------|--------------------------|-----------------|----------------|-------------|--------------------|--------|
| 1630.0000 | 56.73 | -8.37 | 48.36 | 74.00 | -25.64 | V | peak |
| 5095.0000 | 40.98 | 4.01 | 44.99 | 74.00 | -29.01 | V | peak |
| 5995.0000 | 41.84 | 7.56 | 49.40 | 74.00 | -24.60 | V | peak |
| 7045.0000 | 40.44 | 7.16 | 47.60 | 74.00 | -26.40 | V | peak |
| 7780.0000 | 40.32 | 7.63 | 47.95 | 74.00 | -26.05 | V | peak |
| 8725.0000 | 40.00 | 8.36 | 48.36 | 74.00 | -25.64 | V | peak |
| 1630.0000 | 56.28 | -8.37 | 47.91 | 74.00 | -26.09 | H | Peak |
| 3550.0000 | 43.49 | -0.98 | 42.51 | 74.00 | -31.49 | H | Peak |
| 5230.0000 | 40.99 | 4.13 | 45.12 | 74.00 | -28.88 | H | Peak |
| 6115.0000 | 40.58 | 7.54 | 48.12 | 74.00 | -25.88 | H | peak |
| 7645.0000 | 40.98 | 7.54 | 48.52 | 74.00 | -25.48 | H | peak |
| 8500.0000 | 40.74 | 8.18 | 48.92 | 74.00 | -25.08 | H | peak |

Notes:

1. Measuring frequencies from 1 GHz to the 10th harmonic of highest fundamental frequency.
2. Measurements above show only up to 6 maximum emissions noted, or would be lesser if no specific emissions from the EUT are recorded (ie: margin>20dB from the applicable limit) and considered that's already beyond the background noise floor.
3. Radiated emissions measured in frequency above 1000MHz were made with an instrument using Peak detector mode and average detector mode of the emission shown in Actual FS column.
4. Spectrum setting:
 - a. Peak Setting 1GHz - 26GHz, RBW = 1MHz, VBW = 1MHz, Sweep time = 200 ms.
 - b. AV Setting 1GH z- 26GHz, RBW = 1MHz, VBW = 10Hz, Sweep time = 200 ms.
5. Frequency (MHz) = Emission frequency in MHz
 Reading (dBuV/m) =Uncorrected Analyzer / Receiver Reading
 Correction Factor (dB) = Antenna factor + Cable loss – Amplifier gain
 Limit (dBuV/m) = Limit stated in standard
 Margin (dB) = Result (dBuV/m)- Limit (dBuV/m)
 Pk = Peak Reading
 AV. = Average Reading
 Remark = Mark Peak Reading or Average Reading



Test Mode: TX(CH High)

Tested by: Mack Li

Ambient temperature: 24°C Relative humidity: 52% RH

Date: May 5, 2014

| Frequency (MHz) | Reading (dBuV) | Correction Factor (dB/m) | Result (dBuV/m) | Limit (dBuV/m) | Margin (dB) | Antenna Pole (V/H) | Remark |
|-----------------|----------------|--------------------------|-----------------|----------------|-------------|--------------------|--------|
| 1660.0000 | 54.86 | -8.37 | 46.49 | 74.00 | -27.51 | V | peak |
| 3550.0000 | 43.76 | -0.98 | 42.78 | 74.00 | -31.22 | V | peak |
| 4945.0000 | 41.03 | 3.59 | 44.62 | 74.00 | -29.38 | V | peak |
| 6145.0000 | 40.30 | 7.52 | 47.82 | 74.00 | -26.18 | V | peak |
| 6745.0000 | 41.53 | 7.25 | 48.78 | 74.00 | -25.22 | V | peak |
| 7780.0000 | 40.31 | 7.63 | 47.94 | 74.00 | -26.06 | V | peak |
| | | | | | | | |
| 1660.0000 | 54.80 | -8.37 | 46.43 | 74.00 | -27.57 | H | Peak |
| 3550.0000 | 44.06 | -0.98 | 43.08 | 74.00 | -30.92 | H | Peak |
| 5185.0000 | 40.90 | 4.09 | 44.99 | 74.00 | -29.01 | H | Peak |
| 6070.0000 | 41.16 | 7.56 | 48.72 | 74.00 | -25.28 | H | peak |
| 7765.0000 | 40.53 | 7.62 | 48.15 | 74.00 | -25.85 | H | peak |
| 8785.0000 | 40.02 | 8.41 | 48.43 | 74.00 | -25.57 | H | peak |

Notes:

1. Measuring frequencies from 1 GHz to the 10th harmonic of highest fundamental frequency.
2. Measurements above show only up to 6 maximum emissions noted, or would be lesser if no specific emissions from the EUT are recorded (ie: margin>20dB from the applicable limit) and considered that's already beyond the background noise floor.
3. Radiated emissions measured in frequency above 1000MHz were made with an instrument using Peak detector mode and average detector mode of the emission shown in Actual FS column.
4. Spectrum setting:
 - a. Peak Setting 1GHz - 26GHz, RBW = 1MHz, VBW = 1MHz, Sweep time = 200 ms.
 - b. AV Setting 1GH z- 26GHz, RBW = 1MHz, VBW = 10Hz, Sweep time = 200 ms.
5. Frequency (MHz) = Emission frequency in MHz
 Reading (dBuV/m) =Uncorrected Analyzer / Receiver Reading
 Correction Factor (dB) = Antenna factor + Cable loss – Amplifier gain
 Limit (dBuV/m) = Limit stated in standard
 Margin (dB) = Result (dBuV/m)- Limit (dBuV/m)
 Pk = Peak Reading
 AV. = Average Reading
 Remark = Mark Peak Reading or Average Reading



6.9 POWERLINE CONDUCTED EMISSIONS

LIMIT

For an intentional radiator which is designed to be connected to the public utility (AC) power line, the radio frequency voltage that is conducted back onto the AC power line on any frequency or frequencies within the band 150 kHz to 30 MHz shall not exceed 250 microvolts (The limit decreases linearly with the logarithm of the frequency in the range 0.15 MHz to 0.50 MHz). The limits at specific frequency range is listed as follows:

| Frequency Range (MHz) | Limits (dBµV) | |
|-----------------------|---------------|----------|
| | Quasi-peak | Average |
| 0.15 to 0.50 | 66 to 56 | 56 to 46 |
| 0.50 to 5 | 56 | 46 |
| 5 to 30 | 60 | 50 |

Compliance with this provision shall be based on the measurement of the radio frequency voltage between each power line (LINE and NEUTRAL) and ground at the power terminals.

MEASUREMENT EQUIPMENT USED

| Conducted Emission Test Site | | | | | |
|------------------------------|---------------|--------------------|---------------|------------------|-----------------|
| Name of Equipment | Manufacturer | Model Number | Serial Number | Last Calibration | Due Calibration |
| EMI TEST RECEIVER | ROHDE&SCHWARZ | ESCI | 100783 | 03/09/2014 | 03/08/2015 |
| LISN(EUT) | ROHDE&SCHWARZ | ENV216 | 101543-WX | 04/20/2014 | 04/19/2015 |
| LISN | EMCO | 3825/2 | 8901-1459 | 03/09/2014 | 03/08/2015 |
| Temp. / Humidity Meter | VICTOR | HTC-1 | N/A | 03/17/2014 | 03/17/2015 |
| Test S/W | FARAD | EZ-EMC/ CCS-3A1-CE | | | |

Remark: Each piece of equipment is scheduled for calibration once a year.



Test Configuration

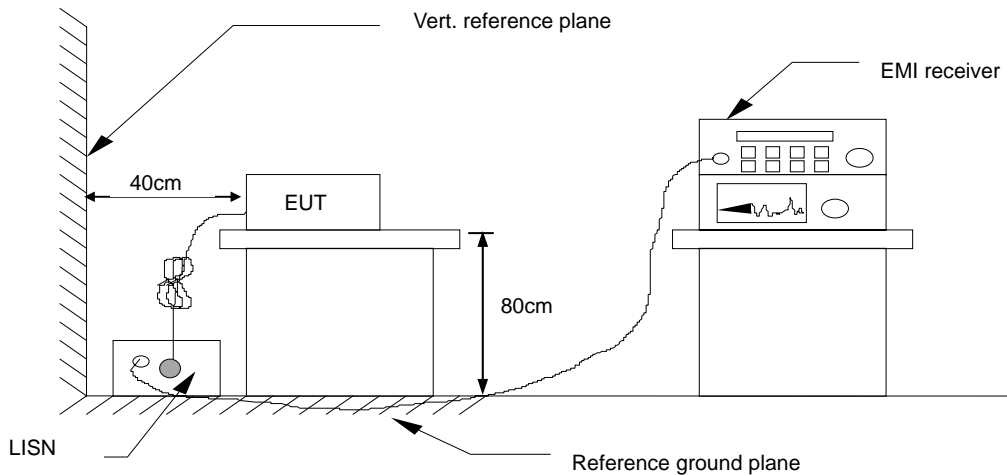

See test photographs attached in Appendix 1 for the actual connections between EUT and support equipment.

TEST PROCEDURE

1. The EUT was placed on a table, which is 0.8m above ground plane.
2. Maximum procedure was performed on the six highest emissions to ensure EUT compliance.
3. Repeat above procedures until all frequency measured were complete.

TEST RESULTS

The initial step in collecting conducted data is a spectrum analyzer peak scan of the measurement range. Significant peaks are then marked as shown on the following data page, and these signals are then quasi-peaked.



Test Data

Operation Mode: Aux Play

Test Date: April 25, 2014

Temperature: 22°C

Humidity: 45% RH

Tested by: Mack Li

| Frequency (MHz) | QuasiPeak Reading (dBuV) | Average Reading (dBuV) | Correction Factor (dB) | QuasiPeak Result (dBuV) | Average Result (dBuV) | QuasiPeak Limit (dBuV) | Average Limit (dBuV) | QuasiPeak Margin (dB) | Average Margin (dB) | Line (L1/L2) |
|-----------------|--------------------------|------------------------|------------------------|-------------------------|-----------------------|------------------------|----------------------|-----------------------|---------------------|--------------|
| 0.6260 | 39.65 | 33.95 | 9.75 | 49.40 | 43.70 | 56.00 | 46.00 | -6.60 | -2.30 | L1 |
| 0.8380 | 40.31 | 29.04 | 9.75 | 50.06 | 38.79 | 56.00 | 46.00 | -5.94 | -7.21 | L1 |
| 1.2900 | 40.50 | 27.62 | 9.72 | 50.22 | 37.34 | 56.00 | 46.00 | -5.78 | -8.66 | L1 |
| 1.7420 | 38.40 | 26.91 | 9.72 | 48.12 | 36.63 | 56.00 | 46.00 | -7.88 | -9.37 | L1 |
| 2.2500 | 38.25 | 26.64 | 9.72 | 47.97 | 36.36 | 56.00 | 46.00 | -8.03 | -9.64 | L1 |
| 3.8340 | 38.52 | 24.45 | 9.70 | 48.22 | 34.15 | 56.00 | 46.00 | -7.78 | -11.85 | L1 |
| 0.6260 | 39.41 | 32.91 | 9.69 | 49.10 | 42.60 | 56.00 | 46.00 | -6.90 | -3.40 | L2 |
| 0.8340 | 39.80 | 29.03 | 9.74 | 49.54 | 38.77 | 56.00 | 46.00 | -6.46 | -7.23 | L2 |
| 1.2220 | 40.04 | 27.13 | 9.79 | 49.83 | 36.92 | 56.00 | 46.00 | -6.17 | -9.08 | L2 |
| 1.7580 | 38.53 | 26.14 | 9.75 | 48.28 | 35.89 | 56.00 | 46.00 | -7.72 | -10.11 | L2 |
| 3.2780 | 38.30 | 24.91 | 9.75 | 48.05 | 34.66 | 56.00 | 46.00 | -7.95 | -11.34 | L2 |
| 3.8260 | 38.35 | 24.56 | 9.76 | 48.11 | 34.32 | 56.00 | 46.00 | -7.89 | -11.68 | L2 |

Note:

1. Measuring frequencies from 0.15 MHz to 30MHz.
2. The emissions measured in frequency range from 0.15 MHz to 30MHz were made with an instrument using Peak detector, Quasi-peak detector and average detector.
3. “---” denotes the emission level was or more than 2dB below the Average limit.
4. The IF bandwidth of SPA between 0.15MHz to 30MHz was 10kHz; the IF bandwidth of Test Receiver between 0.15MHz to 30MHz was 9kHz;
5. L1= Line One (Live Line)/ L2= Line Two (Neutral Line)