

FCC AND IC CERTIFICATION TEST REPORT

FOR

Applicant	:	Harman International Industries, Incorporated
Address	:	8500 Balboa Boulevard, Northridge, CA 91329, UNITED STATES
Equipment under Test	:	Bluetooth headset
Model No.	:	Everest 710GA
Trade Mark	:	JBL
FCC ID	:	APIJBLV710GA
IC	:	6132A-JBLV710GA
Manufacturer	:	Harman International Industries, Incorporated
Address	:	8500 Balboa Boulevard, Northridge, CA 91329, UNITED STATES

Issued By: Dongguan Dongdian Testing Service Co., Ltd.

Add: No. 17, Zongbu Road 2, Songshan Lake Sci&Tech, Industry Park, Dongguan
City, Guangdong Province, China, 523808

Tel: +86-0769-89201699, **E-mail:** ddt@dgddt.com, <http://www.dgddt.com>

REPORT

TABLE OF CONTENTS

	Test report declares.....	4
1.	Summary of test results	6
2.	General test information	7
2.1.	Description of EUT.....	7
2.2.	Accessories of EUT	7
2.3.	Assistant equipment used for test.....	7
2.4.	Block diagram of EUT configuration for test	7
2.5.	Test environment conditions	8
2.6.	Deviations of test standard	8
2.7.	Test laboratory.....	8
2.8.	Measurement uncertainty	9
3.	Equipment used during test	10
4.	6dB Bandwidth and 99% Bandwidth.....	11
4.1.	Block diagram of test setup	11
4.2.	Limits	11
4.3.	Test Procedure	11
4.4.	Test Result	11
4.5.	Original test data.....	11
5.	Maximum Peak Output Power	13
5.1.	Block diagram of test setup	13
5.2.	Limits	13
5.3.	Test Procedure	13
5.4.	Test Result	13
5.5.	Original test data.....	14
6.	Power Spectral Density	15
6.1.	Block diagram of test setup	15
6.2.	Limits	15
6.3.	Test Procedure	15
6.4.	Test Result	15
6.5.	Original test data.....	16
7.	Band Edge Compliance (conducted method)	17
7.1.	Block diagram of test setup	17
7.2.	Limits	17
7.3.	Test Procedure	17
7.4.	Test Result	17
7.5.	Original test data.....	18

8.	Radiated emission	18
8.1.	Block diagram of test setup	18
8.2.	Limit	20
8.3.	Test Procedure	21
8.4.	Test result.....	23
9.	RF Conducted Spurious Emissions	26
9.1.	Block diagram of test setup	26
9.2.	Limits	27
9.3.	Test Procedure	27
9.4.	Test Result	27
9.5.	Original test data.....	27
10.	Emissions in restricted frequency bands	31
10.1.	Block diagram of test setup	31
10.2.	Limit	31
10.3.	Test Procedure	31
10.4.	Test result.....	31
11.	Power Line Conducted Emission	36
11.1.	Block diagram of test setup	36
11.2.	Power Line Conducted Emission Limits.....	36
11.3.	Test Procedure	36
11.4.	Test Result	37
12.	Antenna Requirements	40
12.1.	Limit	40
12.2.	Result	40

TEST REPORT DECLARE

Applicant	:	Harman International Industries, Incorporated
Address	:	8500 Balboa Boulevard, Northridge, CA 91329, UNITED STATES
Equipment under Test	:	Bluetooth headset
Model No.	:	Everest 710GA
Trade mark	:	JBL
Manufacturer	:	Harman International Industries, Incorporated
Address	:	8500 Balboa Boulevard, Northridge, CA 91329, UNITED STATES

Test Standard Used:

FCC Rules and Regulations Part 15 Subpart C, RSS-247 Issue 2 February 2017.

Test procedure used:

ANSI C63.10:2013, RSS-Gen Issue 4, Nov. 2014

We Declare:

The equipment described above is tested by Dongguan Dongdian Testing Service Co., Ltd. and in the configuration tested the equipment complied with the standards specified above. The test results are contained in this test report and Dongguan Dongdian Testing Service Co., Ltd. is assumed of full responsibility for the accuracy and completeness of these tests.

After test and evaluation, our opinion is that the equipment provided for test compliance with the requirement of the above FCC&IC standards.

Report No:	DDT-R18012408-1E5		
Date of Receipt:	Feb. 11, 2018	Date of Test:	Feb. 11, 2018 ~Mar.15, 2018

Prepared By:

Ella Gong

Ella Gong/Engineer



Kevin Feng/EMC Manager

Note: This report applies to above tested sample only. This report shall not be reproduced in parts without written approval of Dongguan Dongdian Testing Service Co., Ltd.

Revision history

Rev.	Revisions	Issue Date	Revised By
---	Initial issue	Mar.15, 2018	

1. Summary of test results

The EUT have been tested according to the applicable standards as referenced below.		
Description of Test Item	Standard	Results
6dB Bandwidth and 99% Bandwidth	FCC Part 15: 15.247 ANSI C63.10:2013 RSS-247 Issue 2	PASS
Peak Output Power	FCC Part 15: 15.247 ANSI C63.10:2013 RSS-247 Issue 2	PASS
Power Spectral Density	FCC Part 15:15.247 ANSI C63.10:2013 RSS-247 Issue 2	PASS
Band Edge Compliance (conducted method)	FCC Part 15: 15.209 FCC Part 15: 15.247 ANSI C63.10: 2013 RSS-247 Issue 2 RSS-Gen Issue 4	PASS
Radiation Emission	FCC Part 15: 15.247 ANSI C63.10:2013 RSS-247 Issue 2 RSS-Gen Issue 4	PASS
RF Conducted Spurious Emissions	FCC Part 15: 15.209 FCC Part 15: 15.247 ANSI C63.10: 2013 RSS-247 Issue 2 RSS-Gen Issue 4	PASS
Emission in restricted frequency bands	FCC Part 15: 15.209 FCC Part 15: 15.247 ANSI C63.10: 2013 RSS-247 Issue 2 RSS-Gen Issue 4	PASS
Power Line Conducted Emission	FCC Part 15: 15.207 ANSI C63.10: 2013 RSS-Gen Issue 4	PASS
Antenna requirement	FCC Part 15: 15.203 RSS-Gen Issue 4	PASS

2. General test information

2.1. Description of EUT

EUT* Name	: Bluetooth headset
Model Number	: Everest 710GA
EUT function description	: Please reference user manual of this device
Power supply	: DC 5V from external AC Adapter : DC 3.7V 610mAh Polymer Li-ion Battery
Radio Specification	: Bluetooth V4.2
Operation frequency	: 2402MHz -2480MHz
Modulation	: GFSK,
Data rate	: 1Mbps
Antenna Type	: Integrated antenna, maximum PK gain: 2.0dBi
Sample Type	: Series production

Note: EUT is the ab. of equipment under test.

2.2. Accessories of EUT

Description of Accessories	Manufacturer	Model number	Serial No.	Other
N/A	N/A	N/A	N/A	N/A

2.3. Assistant equipment used for test

Assistant equipment	Manufacturer	Model number	EMC Compliance	SN
Notebook	DELL	Latitude D610	FCC DOC	00045-534-136-300
AC Adapter	Group Intellect Power Technology Limited	F5V-2.3C-1U	/	Input: AC 100-240V -50/60Hz, 0.5A; Output: DC 5V, 2.3A

2.4. Block diagram of EUT configuration for test

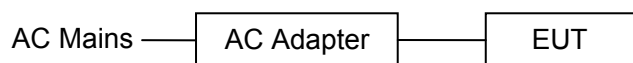

Test software: BlueSuite 2.6.4.EXE

The test software was used to control EUT work in Continuous Tx mode, and select test channel, wireless mode as blow table:

Tested mode, channel, information		
Mode	Channel	Frequency (MHz)
GFSK	CH0	2402
	CH19	2440
	CH39	2480
Note: According exploratory test, EUT will have maximum output power in those data rate, so those data rate were used for all test.		

2.5. Test environment conditions

During the measurement the environmental conditions were within the listed ranges:

Temperature range:	21-25°C
Humidity range:	40-75%
Pressure range:	86-106kPa

2.6. Deviations of test standard

No Deviation.

2.7. Test laboratory

Dongguan Dongdian Testing Service Co., Ltd

Add: No. 17, Zongbu Road 2, Songshan Lake Sci&Tech, Industry Park, Dongguan City, Guangdong Province, China, 523808

Tel: +86-0769-89201699, <http://www.dgddt.com>, Email: ddt@dgddt.com

CNAS Accreditation No. L6451; A2LA Accreditation No. 3870.01

Designation Number: CN1182; Test Firm Registration Number: 540522

Industry Canada site registration number: 10288A-1

2.8. Measurement uncertainty

Test Item	Uncertainty
Bandwidth	1.1%
Peak Output Power(Conducted)(Spectrum analyzer)	0.86dB (10 MHz ≤ f < 3.6GHz);
	1.38dB (3.6GHz ≤ f < 8GHz)
Peak Output Power(Conducted)(Power Sensor)	0.74dB
Power Spectral Density	0.74dB (10 MHz ≤ f < 3.6GHz);
	1.38dB (3.6GHz ≤ f < 8GHz)
Frequencies Stability	6.7 x 10 ⁻⁸ (Antenna couple method)
	5.5 x 10 ⁻⁸ (Conducted method)
Conducted spurious emissions	0.86dB (10 MHz ≤ f < 3.6GHz);
	1.40dB (3.6GHz ≤ f < 8GHz)
	1.66dB (8GHz ≤ f < 22GHz)
Uncertainty for radio frequency (RBW<20kHz)	3×10 ⁻⁸
Temperature	0.4℃
Humidity	2%
Uncertainty for Radiation Emission test (30MHz-1GHz)	4.70 dB (Antenna Polarize: V)
	4.84 dB (Antenna Polarize: H)
Uncertainty for Radiation Emission test (1GHz-40GHz)	4.10dB (1-6GHz)
	4.40dB (6GHz-18GHz)
	3.54dB (18GHz-26GHz)
	4.30dB (26GHz-40GHz)
Uncertainty for Power line conduction emission test	3.32dB (150kHz-30MHz)
Note: This uncertainty represents an expanded uncertainty expressed at approximately the 95% confidence level using a coverage factor of k=2.	

3. Equipment used during test

Equipment	Manufacturer	Model No.	Serial No.	Last Cal.	Cal. Interval
RF Connected Test (Tonscend RF Measurement System)					
Spectrum analyzer	R&S	FSU26	200071	Oct. 23, 2017	1Year
Spectrum analyzer	R&S	FSU26	201124	Dec. 11, 2017	1Year
Wideband Radio Communication tester	R&S	CMW500	117491	Jun. 16, 2017	1 Year
Vector Signal Generator	Agilent	E8267D	US49060192	Oct. 23, 2017	1Year
Vector Signal Generator	Agilent	N5182A	MY48180737	Jun.16, 2017	1Year
Power Sensor	Agilent	U2021XA	MY55150010	Oct. 21, 2017	1Year
Power Sensor	Agilent	U2021XA	MY55150011	Oct. 23, 2017	1Year
DC Power Source	MATRIS	MPS-3005L-3	D813058W	Aug. 18, 2017	1Year
Attenuator	Mini-Circuits	BW-S10W2	101109	Aug. 18, 2017	1Year
RF Cable	Micable	C10-01-01-1	100309	Oct. 21, 2017	1Year
Temp&Humi Programmable	ZHIXIANG	ZXGDJS-150L	ZX170110-A	Oct. 21, 2017	1Year
Test Software	JS Tonscend	JS1120-3	Ver.2.7	N/A	N/A
Radiated Emission Test Chamber 1#					
EMI Test Receiver	R&S	ESU8	100316	Oct. 21, 2017	1 Year
Spectrum analyzer	Agilent	E4447A	MY50180031	Jun. 16, 2017	1 Year
Trilog Broadband Antenna	Schwarzbeck	VULB9163	9163-462	Nov. 09, 2017	1 Year
Active Loop antenna	Schwarzbeck	FMZB-1519	1519-038	Oct. 17, 2017	1 Year
Double Ridged Horn Antenna	R&S	HF907	100276	Oct. 17, 2017	1 Year
Broad Band Horn Antenna	Schwarzbeck	BBHA 9170	790	Nov. 09,2017	1 Year
Pre-amplifier	A.H.	PAM-0118	360	Oct. 21, 2017	1 Year
Pre-amplifier	TERA-MW	TRLA-0040 G35	101303	Oct. 21, 2017	1 Year
RF Cable	HUBSER	CP-X2+ CP-X1	W11.03+ W12.02	Oct. 21, 2017	1Year
RF Cable	N/A	SMAJ-SMA J-1M+ 11M	17070133+17070131	Nov. 08, 2017	1 Year
MI Cable	HUBSER	C10-01-01-1 M	1091629	Oct. 21, 2017	1 Year
Test software	Audix	E3	V 6.11111b	N/A	N/A
Power Line Conducted Emissions Test					
Test Receiver	R&S	ESU8	100316	Oct. 21, 2017	1 Year
LISN 1	R&S	ENV216	101109	Oct. 21 2017	1 Year
LISN 2	R&S	ESH2-Z5	100309	Oct. 21 2017	1 Year
Pulse Limiter	R&S	ESH3-Z2	101242	Oct. 21 2017	1 Year
CE Cable 1	HUBSER	N/A	W10.01	Oct. 21 2017	1 Year
Test software	Audix	E3	V 6.11111b	N/A	N/A

4. 6dB Bandwidth and 99% Bandwidth

4.1. Block diagram of test setup

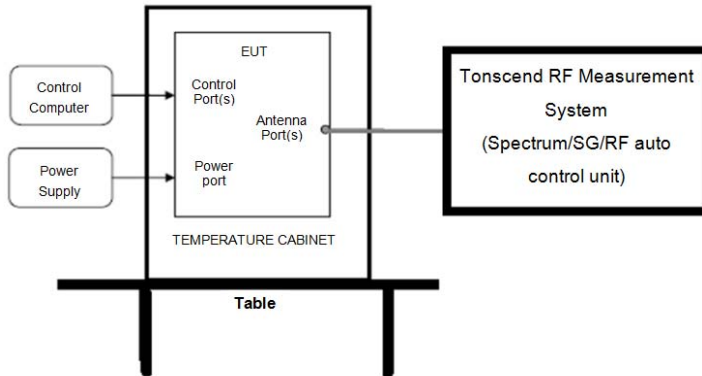

4.2. Limits

For direct sequence systems, the minimum 6dB bandwidth shall be at least 500 kHz

4.3. Test Procedure

(1) Connect EUT's antenna output to spectrum analyzer by RF cable.

(2) Set the spectrum analyzer as follows:

RBW: 100kHz
 VBW: 300kHz
 Detector Mode: Peak
 Sweep time: auto
 Trace mode Max hold

(3) Allow the trace to stabilize, measure the 6dB and 99% bandwidth of signal.

4.4. Test Result

Mode	Channel	6dB bandwidth Result (MHz)	99% bandwidth Result (MHz)	6 dB width Limit (MHz)	Conclusion
GFSK	CH0	0.700	1.044	>0.5	PASS
	CH19	0.692	1.044	>0.5	PASS
	CH39	0.692	1.040	>0.5	PASS

4.5. Original test data

BLE_ANT1_2402

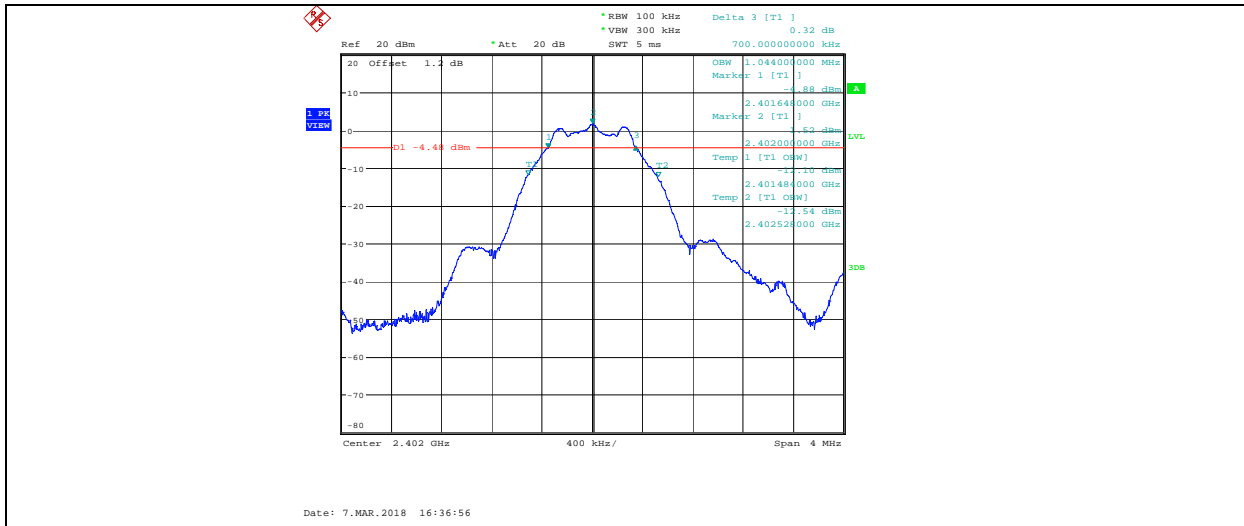

BLE ANT1 2440

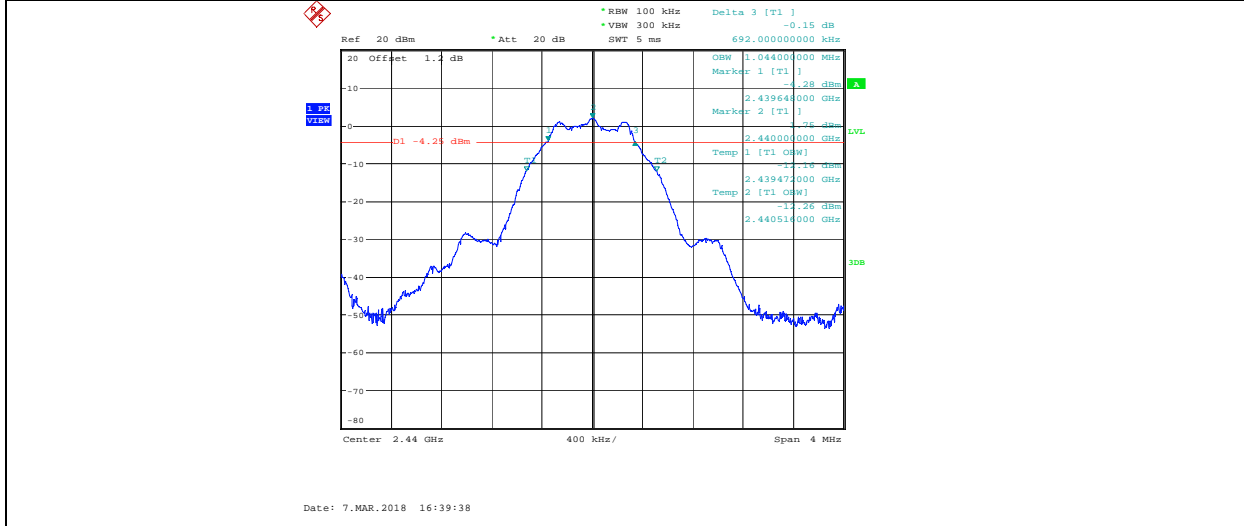

BLE ANT1 2480

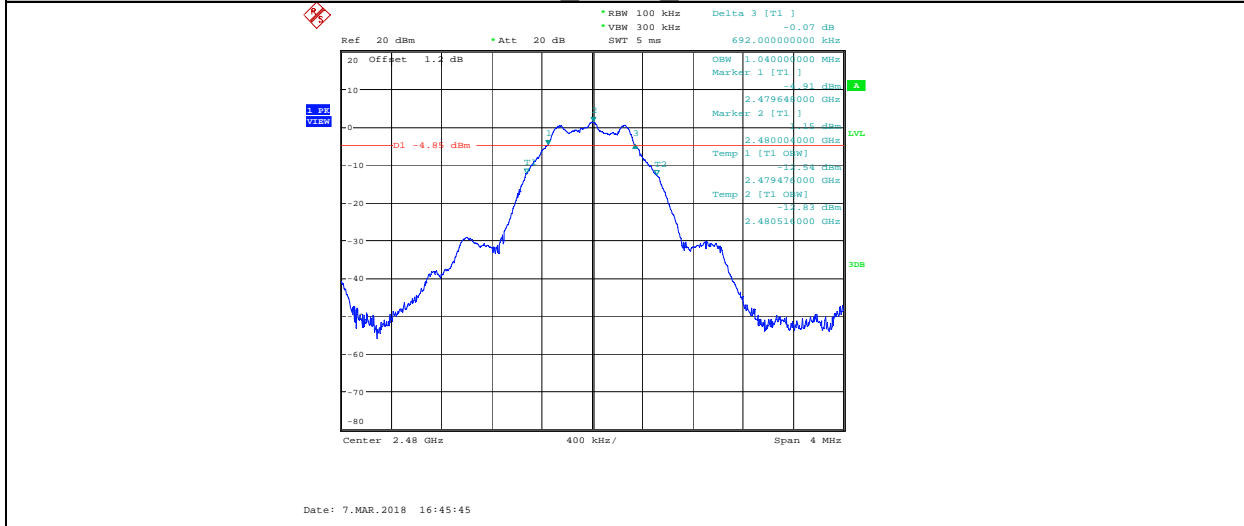

5. Maximum Peak Output Power

5.1. Block diagram of test setup

Same with 4.1

5.2. Limits

For systems using digital modulation in the 902-928 MHz, 2400-2483.5 MHz, and 5725-5850 MHz bands: 1 Watt. If transmitting antennas of directional gain greater than 6 dBi are used, the conducted output power from the intentional radiator shall be reduced below the stated values as appropriate, by the amount in dB that the directional gain of the antenna exceeds 6 dBi.

5.3. Test Procedure

(1) Connect EUT's antenna output to spectrum analyzer by RF cable.

(2) Set the spectrum analyzer as follows:

RBW:	3MHz
VBW:	10MHz
Span	>1.5x 6dB bandwidth
Detector Mode:	Peak
Sweep time:	auto
Trace mode	Max hold

(3) Allow the trace to stabilize, Use the instrument's band/channel power measurement function with the band limits set equal to the DTS bandwidth edges measure out the PK output power.

5.4. Test Result

Mode	Freq (MHz)	Peak Output Power (dBm)	Limit (dBm)	Conclusion
GFSK	2402	1.92	30	PASS
	2440	1.89	30	PASS
	2480	1.49	30	PASS

5.5. Original test data

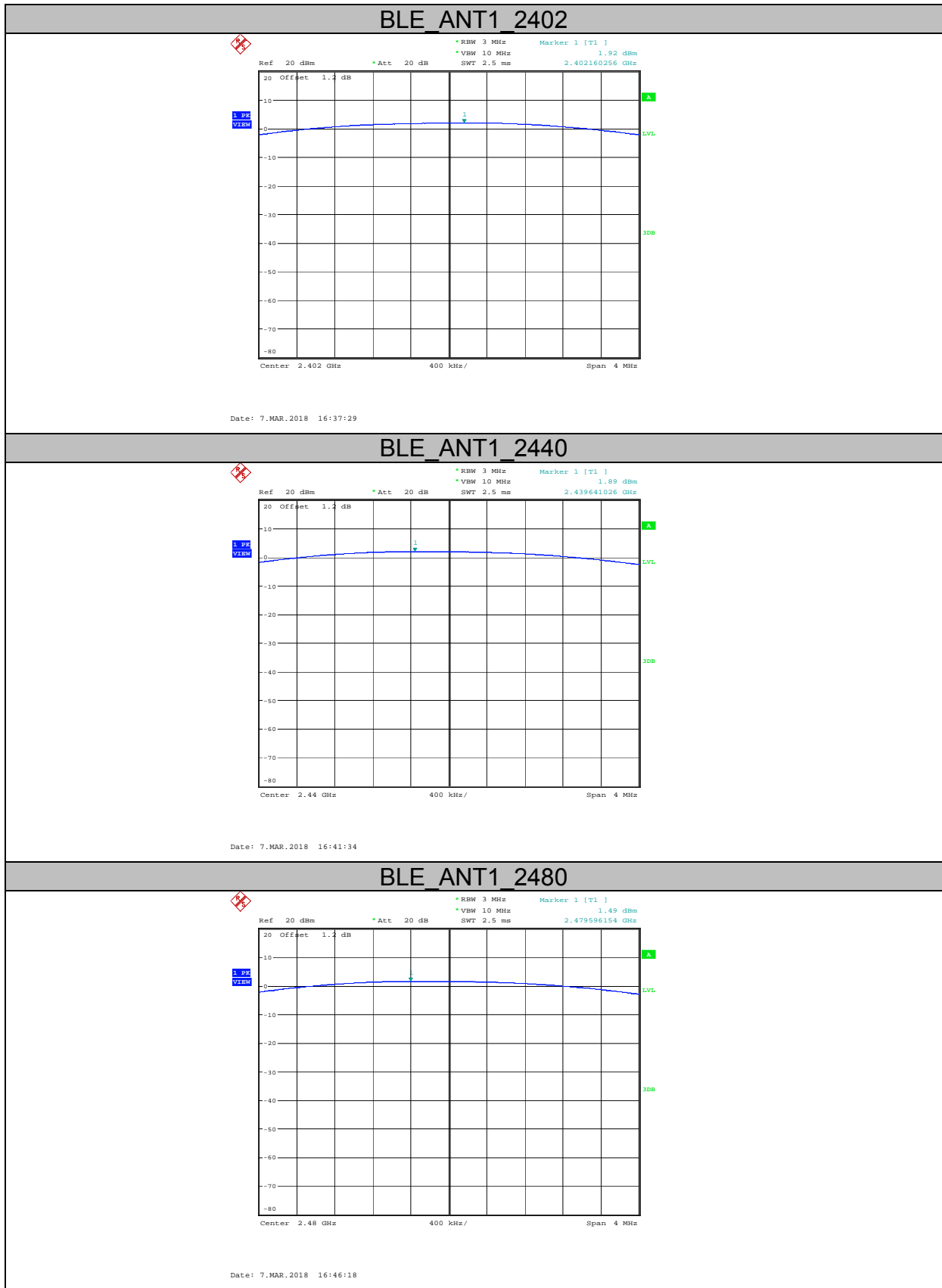

6. Power Spectral Density

6.1. Block diagram of test setup

Same with 4.1

6.2. Limits

For digitally modulated systems, the power spectral density conducted from the intentional radiator to the antenna shall not be greater than 8dBm in any 3 kHz band during any time interval of continuous transmission.

6.3. Test Procedure

(1) Connect EUT's antenna output to spectrum analyzer by RF cable.

(2) Set the spectrum analyzer as follows:

Center frequency	DTS Channel center frequency
RBW:	$3 \text{ kHz} \leq \text{RBW} \leq 100 \text{ kHz}$
VBW:	$\geq 3\text{RBW}$
Span	1.5times the DTS bandwidth
Detector Mode:	Peak
Sweep time:	auto
Trace mode	Max hold

(3) Allow the trace to stabilize, use the peak marker function to determine the maximum amplitude level within the RBW.

(4) If measured value exceeds limit, reduce RBW (no less than 3 kHz) and repeat.

6.4. Test Result

EUT Set Mode	Channel	Result (dBm/100kHz)	Result (dBm/3kHz)
GFSK	CH0	1.54	-13.69
	CH19	1.59	-13.64
	CH39	1.18	-14.05
Limit: <8dBm/3kHz		Conclusion: PASS	

6.5. Original test data

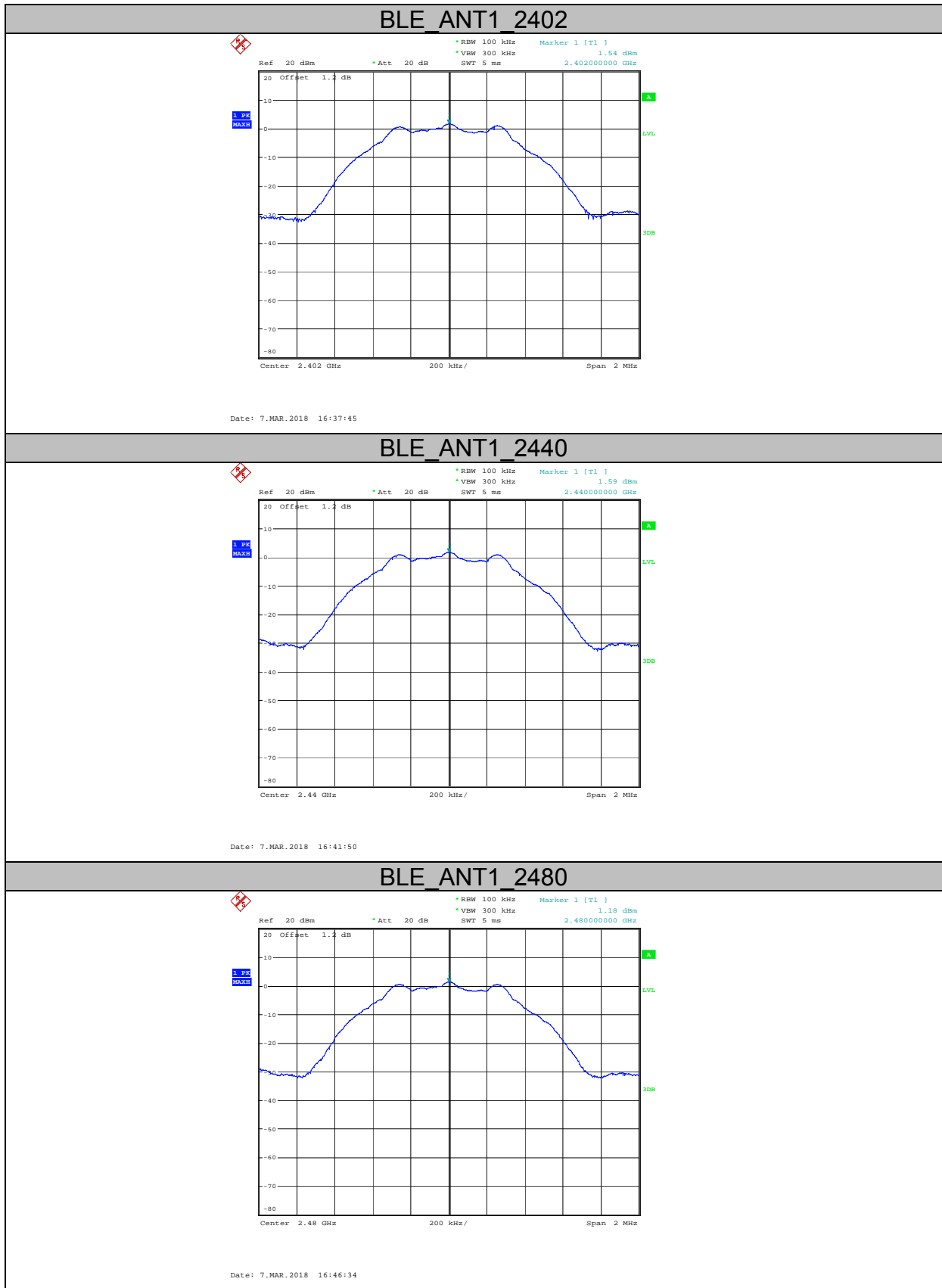

7. Band Edge Compliance (conducted method)

7.1. Block diagram of test setup

Same with 4.1

7.2. Limits

In any 100kHz bandwidth outside the frequency bands in which the spread spectrum intentional radiator is operating, the radio frequency power that is produced by the intentional radiator shall be at least 20dB below that in the 100kHz bandwidth within the band that contains the highest level of the desired power.

7.3. Test Procedure

(1) Connect EUT's antenna output to spectrum analyzer by RF cable.

(2) Establish a reference level by using the following procedure:

Center frequency	DTS Channel center frequency
RBW:	100kHz
VBW:	300kHz
Span	1.5times the DTS bandwidth
Detector Mode:	Peak
Sweep time:	auto
Trace mode	Max hold

(3) Allow the trace to stabilize, use the peak marker function to determine the maximum peak power level to establish the reference level.

(4) Set the spectrum analyzer as follows:

RBW:	100kHz
VBW:	300kHz
Span	Encompass frequency range to be measured
Number of measurement points	$\geq \text{span}/\text{RBW}$
Detector Mode:	Peak
Sweep time:	auto
Trace mode	Max hold

(5) Allow the trace to stabilize, use the peak marker function to determine the maximum amplitude of all unwanted emissions outside of the authorized frequency band

7.4. Test Result

EUT Set Mode	CH or Frequency	Measured Range	Result (dBm)
GFSK	CH0	2.375GHz-2.405GHz	PASS
	CH39	2.476GHz-2.506GHz	PASS

7.5. Original test data

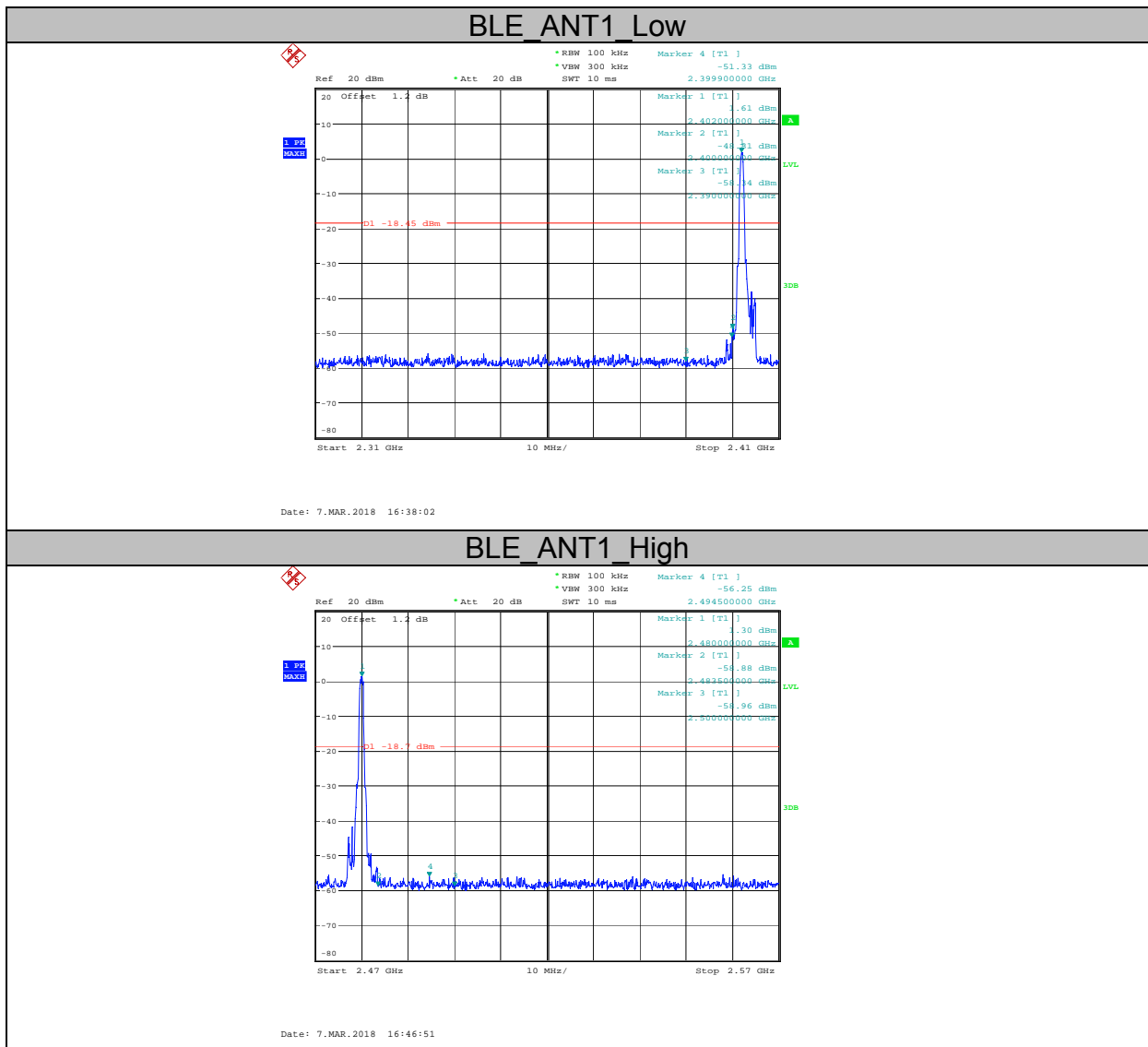

8. Radiated emission

8.1. Block diagram of test setup

In 3m Anechoic Chamber Test Setup Diagram for 9kHz-30MHz

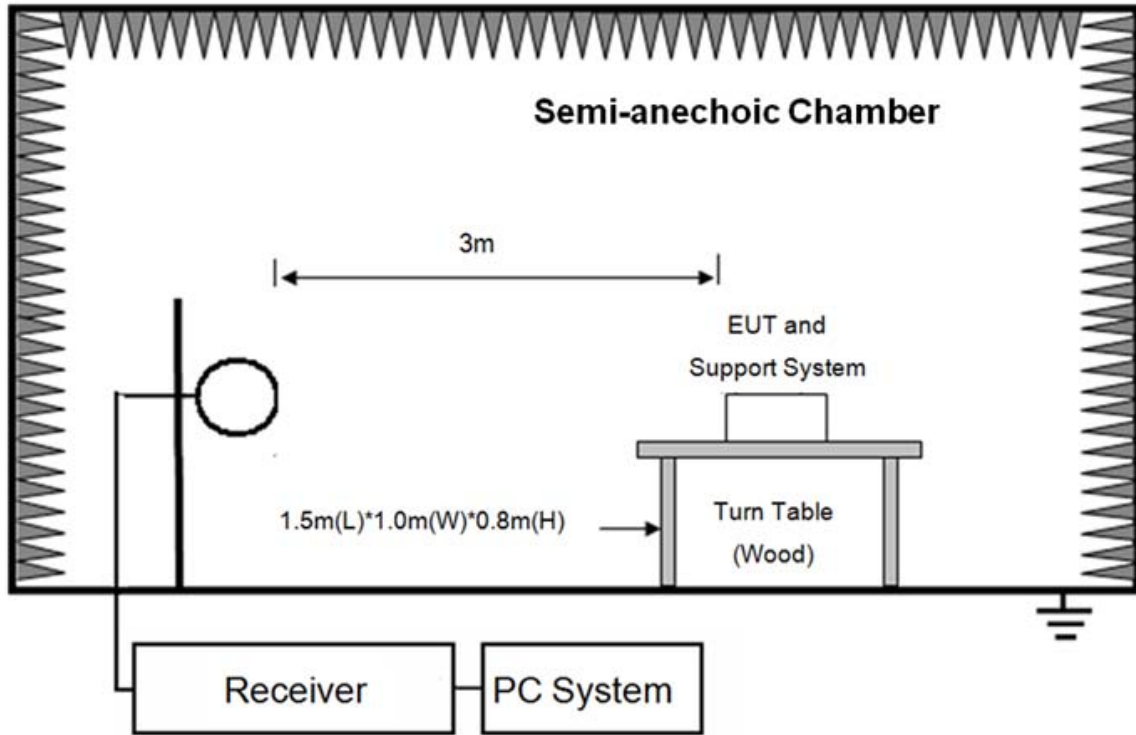

In 3m Anechoic Chamber Test Setup Diagram for 30MHz-1GHz

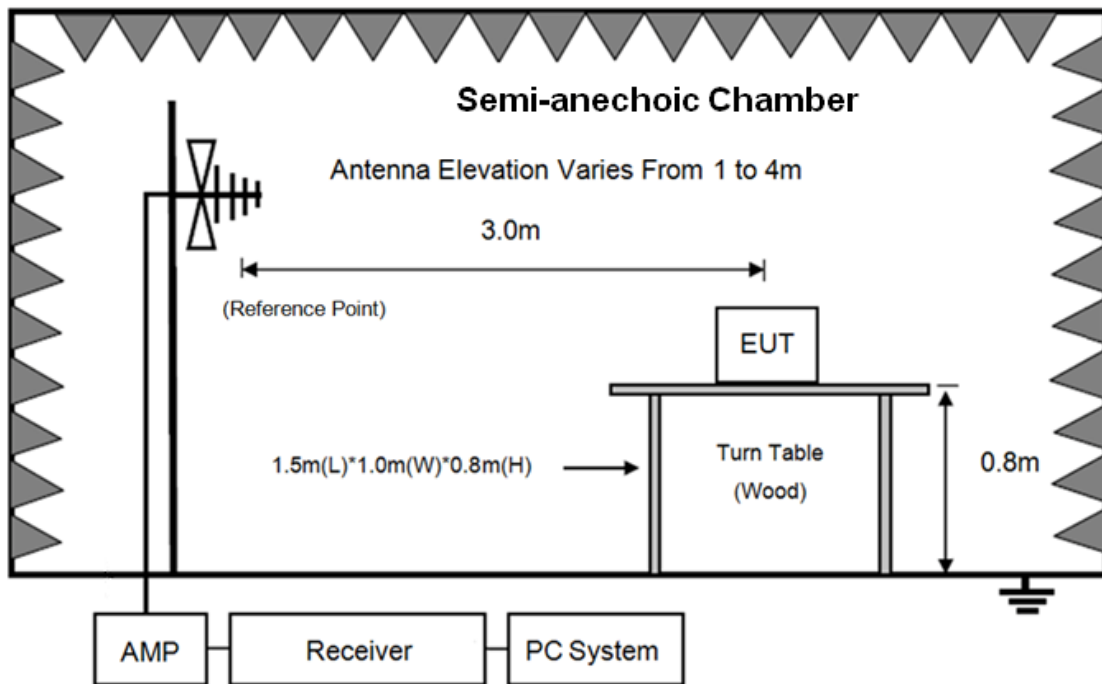

In 3m Anechoic Chamber Test Setup Diagram for frequency above 1GHz

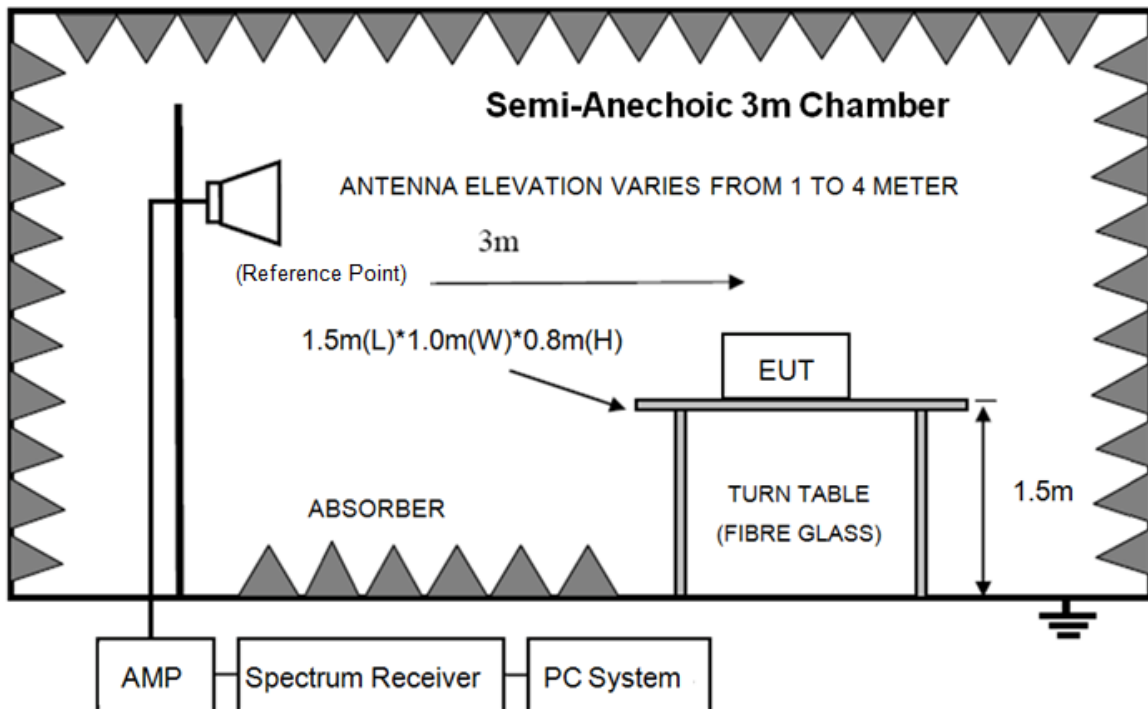

Note: For harmonic emissions test a appropriate high pass filter was inserted in the input port of AMP.

8.2. Limit

8.2.1 FCC 15.205 Restricted frequency band

MHz	MHz	MHz	GHz
0.090-0.110	16.42-16.423	399.9-410	4.5-5.15
10.495-0.505	16.69475-16.69525	608-614	5.35-5.46
2.1735-2.1905	16.80425-16.80475	960-1240	7.25-7.75
4.125-4.128	25.5-25.67	1300-1427	8.025-8.5
4.1772&4.17775	37.5-38.25	1435-1626.5	9.0-9.2
4.2072&4.20775	73-74.6	1645.5-1646.5	9.3-9.5
6.215-6.218	74.8-75.2	1660-1710	10.6-12.7
6.26775-6.26825	108-121.94	1718.8-1722.2	13.25-13.4
6.31175-6.31225	123-138	2200-2300	14.47-14.5
8.291-8.294	149.9-150.05	2310-2390	15.35-16.2
8.362-8.366	156.52475-156.52525	2483.5-2500	17.7-21.4
8.37625-8.38675	156.7-156.9	2690-2900	22.01-23.12
8.41425-8.41475	162.0125-167.17	3260-3267	23.6-24.G
12.29-12.293	167.72-173.2	3332-3339	31.2-31.8
12.51975-12.52025	240-285	3345.8-3358	36.43-36.5
12.57675-12.57725	322-335.4	3600-4400	(²)
13.36-13.41			

8.2.2 FCC 15.209 Limit.

FREQUENCY MHz	DISTANCE Meters	FIELD STRENGTHS LIMIT	
		$\mu\text{V}/\text{m}$	$\text{dB}(\mu\text{V})/\text{m}$
0.009 ~ 0.490	300	2400/F(kHz)	67.6-20log(F)
0.490 ~ 1.705	30	24000/F(kHz)	87.6-20log(F)
1.705 ~ 30.0	30	30	29.54
30 ~ 88	3	100	40.0
88 ~ 216	3	150	43.5
216 ~ 960	3	200	46.0
960 ~ 1000	3	500	54.0
Above 1000	3	74.0 dB(μV)/m (Peak) 54.0 dB(μV)/m (Average)	

Note: (1)The emission limits shown in the above table are based on measurements employing a CISPR QP detector except for the frequency bands 9-90kHz, 110-490kHz and above 1000MHz. Radiated emissions limits in these three bands are based on measurements employing an average detector.

(2) At frequencies below 30MHz, measurement may be performed at a distance closer than that specified, and the limit at closer measurement distance can be extrapolated by below formula:

$$\text{Limit}_{3\text{m}}(\text{dB}\mu\text{V}/\text{m}) = \text{Limit}_{30\text{m}}(\text{dB}\mu\text{V}/\text{m}) + 40\text{Log}(30\text{m}/3\text{m})$$

8.2.3 Limit for this EUT

All the emissions appearing within 15.205 restricted frequency bands shall not exceed the limits shown in 15.209, all the other emissions shall be at least 20dB below the fundamental emissions, or comply with 15.209 limits.

8.3. Test Procedure

- (1) EUT was placed on a non-metallic table, 80 cm above the ground plane inside a semi-anechoic chamber for below 1G and 150 cm above the ground plane inside a semi-anechoic chamber for above 1G.
- (2) Test antenna was located 3m from the EUT on an adjustable mast, and the antenna used as below table.

Test frequency range	Test antenna used	Test antenna distance
9kHz-30MHz	Active Loop antenna	3m
30MHz-1GHz	Trilog Broadband Antenna	3m
1GHz-18GHz	Double Ridged Horn Antenna(1GHz-18GHz)	3m
18GHz-40GHz	Horn Antenna(18GHz-40GHz)	1m

According ANSI C63.10:2013 clause 6.4.4.2 and 6.5.3, for measurements below 30 MHz, the loop antenna was positioned with its plane vertical from the EUT and rotated about its vertical axis for maximum response at each azimuth position around the EUT. And the loop antenna also

be positioned with its plane horizontal at the specified distance from the EUT. The center of the loop is 1 m above the ground. for measurement above 30MHz, the Trilog Broadband Antenna or Horn Antenna was located 3m from EUT, Measurements were made with the antenna positioned in both the horizontal and vertical planes of

Polarization, and the measurement antenna was varied from 1 m to 4 m. in height above the reference ground plane to obtain the maximum signal strength.

(3) Below pre-scan procedure was first performed in order to find prominent frequency spectrum radiated emissions from 9kHz to 25GHz:

(a) Scanning the peak frequency spectrum with the antenna specified in step (3), and the EUT was rotated 360 degree, the antenna height was varied from 1m to 4m(Except loop antenna, it's fixed 1m above ground.)

(b) Change work frequency or channel of device if practicable.

(c) Change modulation type of device if practicable.

(d) Change power supply range from 85% to 115% of the rated supply voltage

(e) Rotated EUT though three orthogonal axes to determine the attitude of EUT arrangement produces highest emissions.

Spectrum frequency from 9kHz to 25GHz (tenth harmonic of fundamental frequency) was investigated, and no any obvious emission were detected from 9kHz to 30MHz and 18GHz to 25GHzso below final test was performed with frequency range from 30MHz to 18GHz.

(4) For final emissions measurements at each frequency of interest, the EUT was rotated and the antenna height was varied between 1m and 4m in order to maximize the emission. Measurements in both horizontal and vertical polarities were made and the data was recorded. In order to find the maximum emission, the relative positions of equipments and all of the interface cables were changed according to ANSI C63.10 2013 on Radiated Emission test.

(5) The emissions from 9kHz to 1GHz were measured based on CISPR QP detector except for the frequency bands 9-90kHz, 110-490kHz, for emissions from 9kHz-90kHz,110kHz-490kHz and above 1GHz were measured based on average detector, for emissions above 1GHz, peak emissions also be measured and need comply with Peak limit.

(6)The emissions from 9kHz to 1GHz, QP or average values were measured with EMI receiver with below RBW

Frequency band	RBW
9kHz-150kHz	200Hz
150kHz-30MHz	9kHz
30MHz-1GHz	120kHz

(7)For emissions above 1GHz, both Peak and Average level were measured with Spectrum Analyzer, and the RBW is set at 1MHz, VBW is set at 3MHz for Peak measure; RBW is set at 1MHz, VBW is set at 3MHz for Average measure(according ANSI C63.10:2013 clause 4.1.4.2.2 procedure for average measure).

(8) X axis, Y axis, Z axis are tested, and worse setup X axis is reported.

8.4. Test result

PASS. (See below detailed test result)

All the emissions except fundamental emission from 9kHz to 25GHz were comply with 15.209 limit.

Note1: According exploratory test no any obvious emission were detected from 9kHz to 30MHz and 18GHz to 25GHz, so the final test was performed with frequency range from 30MHz to 18GHz and recorded in below.

Note2: For emissions below 1GHz, according exploratory explorer test, when change Tx mode and channel, have no distinct influence on emissions level, so for emissions below 1GHz, the final test was only performed with EUT working in GFSK, Tx 2440MHz mode.

Note3: For emissions above 1GHz. If peak results comply with AV limit, AV Result is deemed to comply with AV limit.

Radiated Emission test (below 1GHz) TR-4-E-009 Radiated Emission Test Result

Test Site	: DDT 3m Chamber 1#	D:\2018 RE1# Report Data\Q18012408-1E V710GA\FCC	BELOW1G.EM6
Test Date	: 2018-03-04	Tested By	: TALENT
EUT	: Bluetooth headset	Model Number	: Everest 710GA
Power Supply	: Battery	Test Mode	: Tx mode
Condition	: Temp:24.5°C,Humi:55%, Press:100.1kPa	Antenna/Distance	: 2017 VULB 9163 1#/3m/VERTICAL
Memo	:		

Data: 1

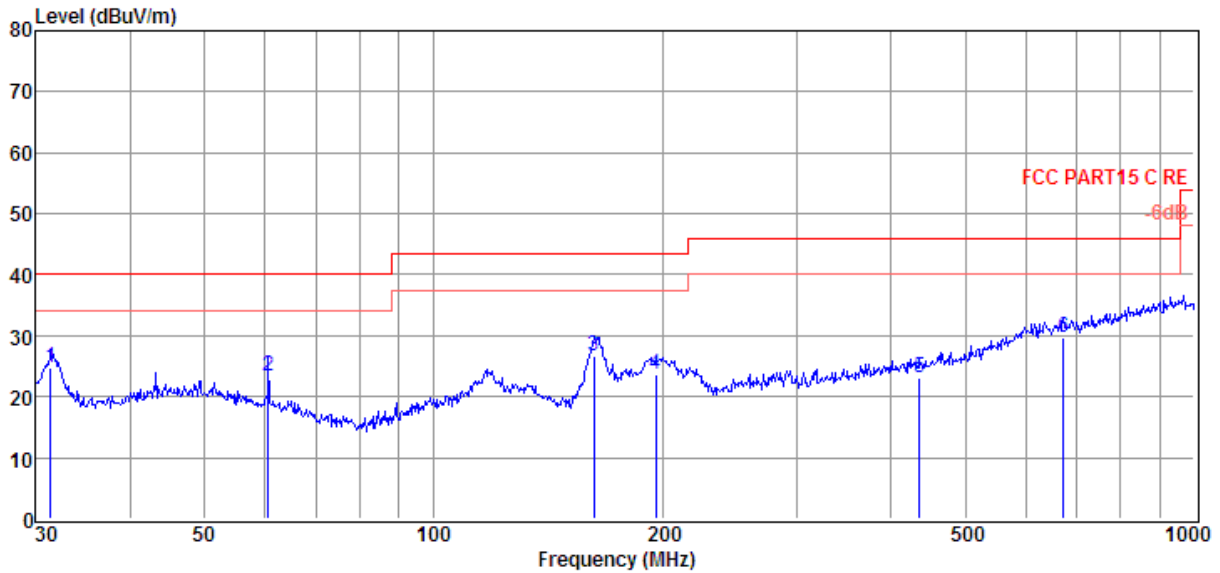

Item (Mark)	Freq. (MHz)	Read Level (dBμV)	Antenna Factor (dB/m)	Cable Loss dB	Result Level (dBμV/m)	Limit Line (dBμV/m)	Over Limit (dB)	Detector	Polarization
1	31.40	10.08	10.75	3.79	24.62	40.00	-15.38	QP	VERTICAL
2	60.70	7.94	11.23	4.10	23.27	40.00	-16.73	QP	VERTICAL
3	162.61	13.16	8.75	4.84	26.75	43.50	-16.75	QP	VERTICAL
4	195.82	7.39	11.14	5.00	23.53	43.50	-19.97	QP	VERTICAL
5	435.59	1.28	16.08	5.71	23.07	46.00	-22.93	QP	VERTICAL
6	672.84	3.20	19.62	6.92	29.74	46.00	-16.26	QP	VERTICAL

- Note: 1. Result Level = Read Level + Antenna Factor + Cable loss.
 2. If Peak Result complies with QP limit, QP Result is deemed to comply with QP limit.
 3. Test setup: RBW: 120 kHz, VBW: 300 kHz, Sweep time: auto.

TR-4-E-009 Radiated Emission Test Result

Test Site : DDT 3m Chamber 1#
Test Date : 2018-03-04
EUT : Bluetooth headset
Power Supply : Battery
Condition : Temp:24.5'C,Humi:55%, Press:100.1kPa
Memo : BLE

D:\2018 RE1# Report Data\Q18012408-1E V710GA\FCC BELOW1G.EM6
Tested By : TALENT
Model Number : Everest 710GA
Test Mode : Tx mode
Antenna/Distance : 2017 VULB 9163 1#/3m/HORIZONTAL

Data: 2

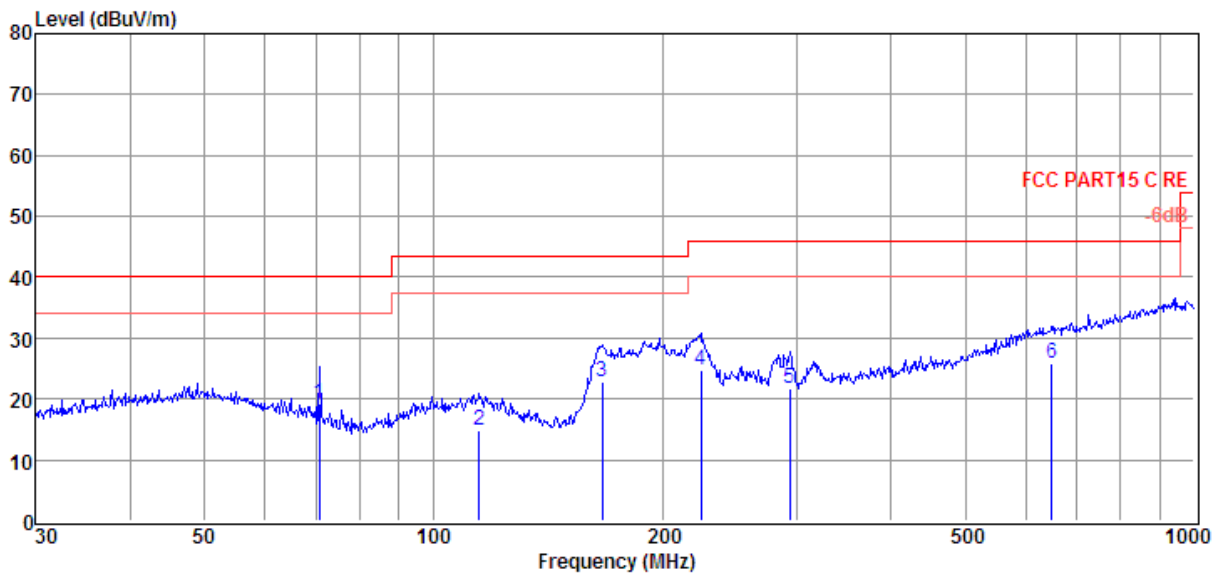

Item (Mark)	Freq. (MHz)	Read Level (dBuV)	Antenna Factor (dB/m)	Cable Loss (dB)	Result Level (dBuV/m)	Limit Line (dBuV/m)	Over Limit (dB)	Detector	Polarization
1	70.83	5.95	9.06	4.18	19.19	40.00	-20.81	QP	HORIZONTAL
2	114.92	0.50	9.75	4.53	14.78	43.50	-28.72	QP	HORIZONTAL
3	166.65	9.06	8.98	4.86	22.90	43.50	-20.60	QP	HORIZONTAL
4	224.52	7.57	12.01	5.16	24.74	46.00	-21.26	QP	HORIZONTAL
5	294.11	3.03	13.21	5.50	21.74	46.00	-24.26	QP	HORIZONTAL
6	649.66	-0.42	19.55	6.85	25.98	46.00	-20.02	QP	HORIZONTAL

- Note: 1. Result Level = Read Level + Antenna Factor + Cable loss.
 2. If Peak Result complies with QP limit, QP Result is deemed to comply with QP limit.
 3. Test setup: RBW: 120 kHz, VBW: 300 kHz, Sweep time: auto.

Radiated Emission test (above 1GHz)

Freq. (MHz)	Read level (dB μ V)	Antenna Factor (dB/m)	PRM Factor (dB)	Cable Loss (dB)	Result Level (dB μ V/m)	Limit (dB μ V/ m)	Margin (dB)	Detector type	Polarization
GFSK Tx mode 2402MHz									
4655.00	34.29	34.45	29.28	7.23	46.69	74.00	-27.31	Peak	HORIZONTAL
6899.00	33.44	36.58	30.31	8.32	48.03	74.00	-25.97	Peak	HORIZONTAL
8225.00	34.07	37.24	31.33	9.49	49.47	74.00	-24.53	Peak	HORIZONTAL
9041.00	34.00	37.52	32.34	10.39	49.57	74.00	-24.43	Peak	HORIZONTAL
10571.00	33.52	38.54	33.33	10.99	49.72	74.00	-24.28	Peak	HORIZONTAL
12186.00	33.59	38.86	34.92	11.04	48.57	74.00	-25.43	Peak	HORIZONTAL
4791.00	37.39	34.67	29.31	7.37	50.12	74.00	-23.88	Peak	VERTICAL
6576.00	34.37	35.87	29.97	8.28	48.55	74.00	-25.45	Peak	VERTICAL
7970.00	34.61	37.19	31.12	9.20	49.88	74.00	-24.12	Peak	VERTICAL
9381.00	34.55	37.65	32.52	10.57	50.25	74.00	-23.75	Peak	VERTICAL
10894.00	33.13	38.74	33.74	11.04	49.17	74.00	-24.83	Peak	VERTICAL
12084.00	33.68	38.88	34.85	11.00	48.71	74.00	-25.29	Peak	VERTICAL
GFSK Tx mode 2441MHz									
5080.00	35.61	35.08	29.34	7.63	48.98	74.00	-25.02	Peak	HORIZONTAL
6661.00	34.79	36.05	30.10	8.29	49.03	74.00	-24.97	Peak	HORIZONTAL
7936.00	34.46	37.17	31.11	9.17	49.69	74.00	-24.31	Peak	HORIZONTAL
9500.00	33.98	37.70	32.62	10.63	49.69	74.00	-24.31	Peak	HORIZONTAL
10945.00	33.68	38.77	33.80	11.05	49.70	74.00	-24.30	Peak	HORIZONTAL
13274.00	33.99	39.57	35.50	11.63	49.69	74.00	-24.31	Peak	HORIZONTAL
4791.00	34.33	34.67	29.31	7.37	47.06	74.00	-26.94	Peak	VERTICAL
6576.00	35.55	35.87	29.97	8.28	49.73	74.00	-24.27	Peak	VERTICAL
8225.00	34.77	37.24	31.33	9.49	50.17	74.00	-23.83	Peak	VERTICAL
10010.00	34.73	38.21	32.92	10.89	50.91	74.00	-23.09	Peak	VERTICAL
10911.00	33.58	38.75	33.74	11.04	49.63	74.00	-24.37	Peak	VERTICAL
12084.00	34.34	38.88	34.85	11.00	49.37	74.00	-24.63	Peak	VERTICAL
GFSK Tx mode 2480MHz									
4961.00	37.13	34.94	29.35	7.54	50.26	74.00	-23.74	Peak	HORIZONTAL
6780.00	34.87	36.32	30.24	8.30	49.25	74.00	-24.75	Peak	HORIZONTAL
8021.00	34.78	37.20	31.17	9.25	50.06	74.00	-23.94	Peak	HORIZONTAL
9211.00	33.90	37.58	32.42	10.48	49.54	74.00	-24.46	Peak	HORIZONTAL
10469.00	33.68	38.48	33.25	10.97	49.88	74.00	-24.12	Peak	HORIZONTAL
11251.00	33.60	38.70	34.28	11.04	49.06	74.00	-24.94	Peak	HORIZONTAL

Note:1. Result Level = Read Level + Antenna Factor + Cable loss - PRM Factor.

2. For emissions above 1GHz. If peak results comply with AV limit, AV Result is deemed to comply with AV limit.

9. RF Conducted Spurious Emissions**9.1. Block diagram of test setup**

Same as section 4.1

9.2. Limits

In any 100kHz bandwidth outside the frequency bands in which the spread spectrum intentional radiator is operating, the radio frequency power that is produced by the intentional radiator shall be at least 20dB below that in the 100kHz bandwidth within the band that contains the highest level of the desired power.

9.3. Test Procedure

(1) Connect EUT's antenna output to spectrum analyzer by RF cable.

(2) Establish a reference level by using the following procedure:

Center frequency	DTS Channel center frequency
RBW:	100kHz
VBW:	300kHz
Span	1.5times the DTS bandwidth
Detector Mode:	Peak
Sweep time:	auto
Trace mode	Max hold

(3) Allow the trace to stabilize, use the peak marker function to determine the maximum peak power level to establish the reference level.

(4) Set the spectrum analyzer as follows:

RBW:	100kHz
VBW:	300kHz
Span	Encompass frequency range to be measured
Number of measurement points	$\geq \text{span}/\text{RBW}$
Detector Mode:	Peak
Sweep time:	auto
Trace mode	Max hold

(5) Allow the trace to stabilize, use the peak marker function to determine the maximum amplitude of all unwanted emissions outside of the authorized frequency band

9.4. Test Result

Mode	Freq. (MHz)	Conclusion
GFSK	Hopping off 2402	PASS
	Hopping off 2441	PASS
	Hopping off 2480	PASS

9.5. Original test data

BLE_ANT1_2402_Ref

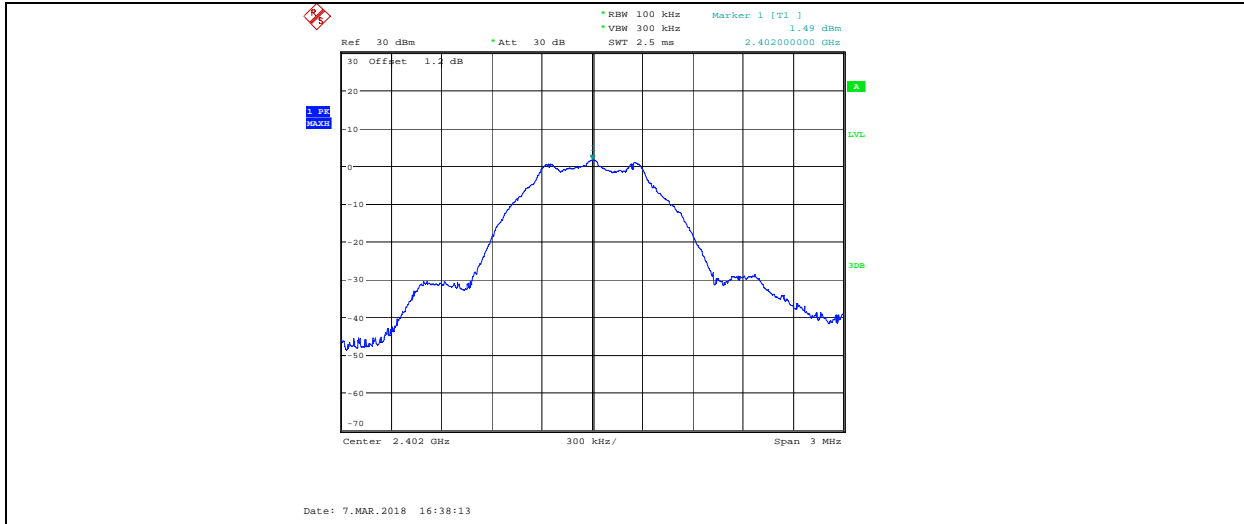

BLE ANT1 2402 30~1000

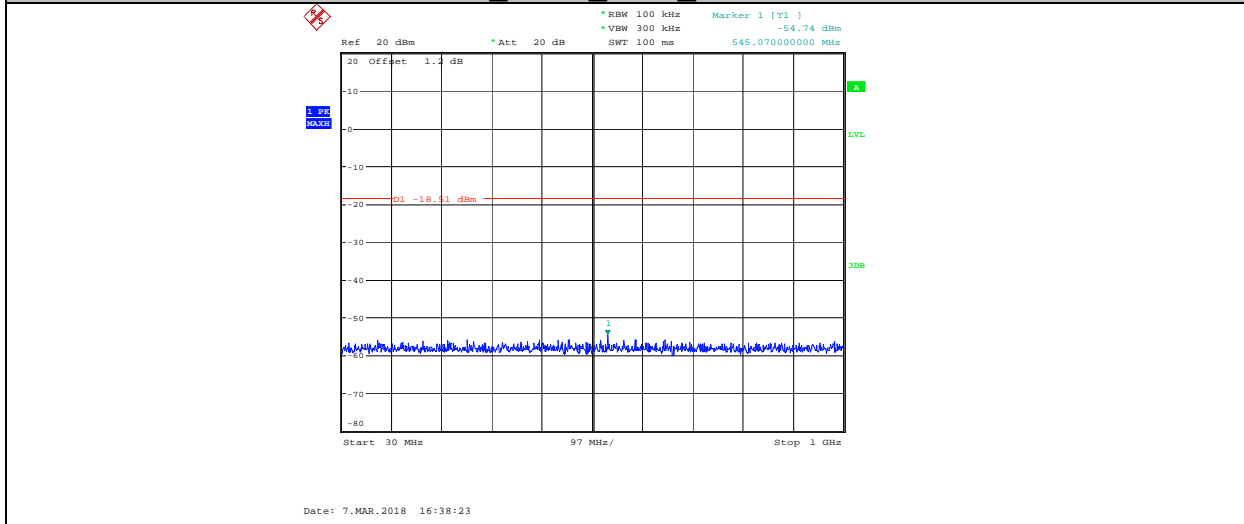

BLE ANT1 2402 1000~26500

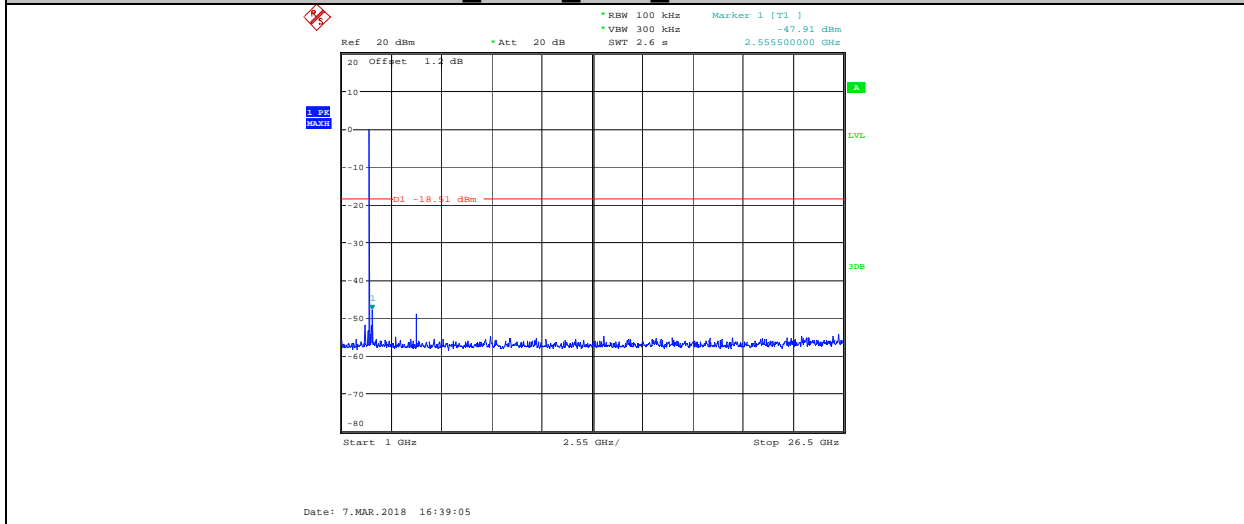

BLE ANT1 2440 Ref

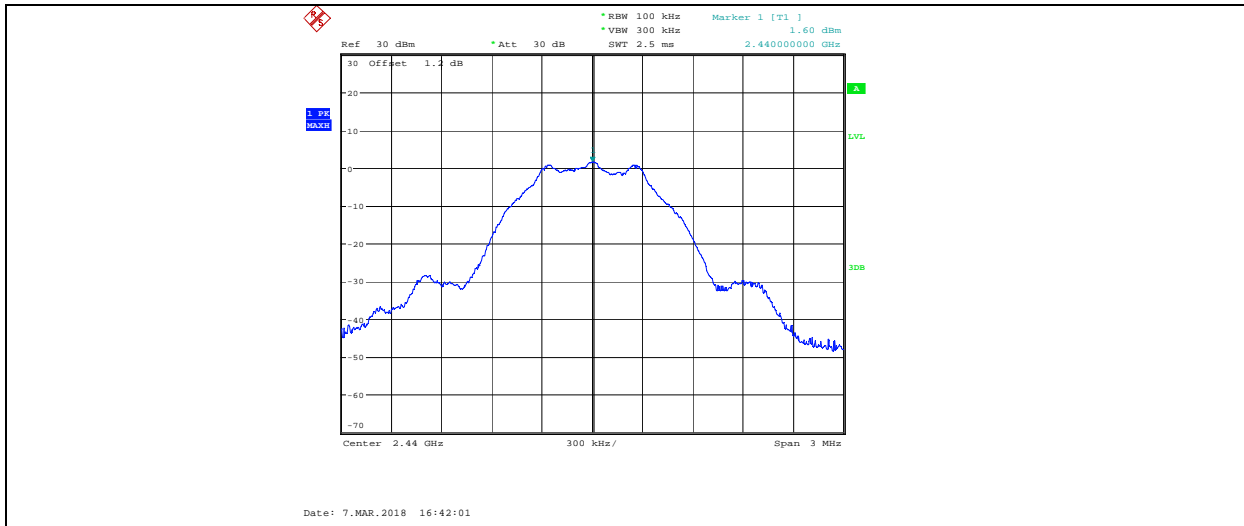

BLE_ANT1_2440_30~1000

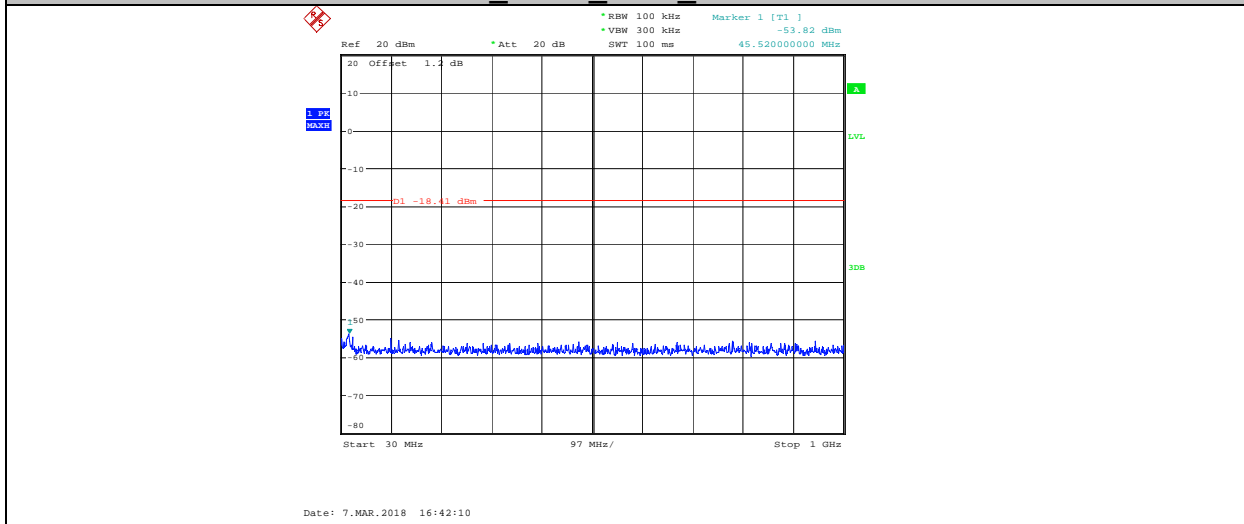

BLE_ANT1_2440_1000~26500

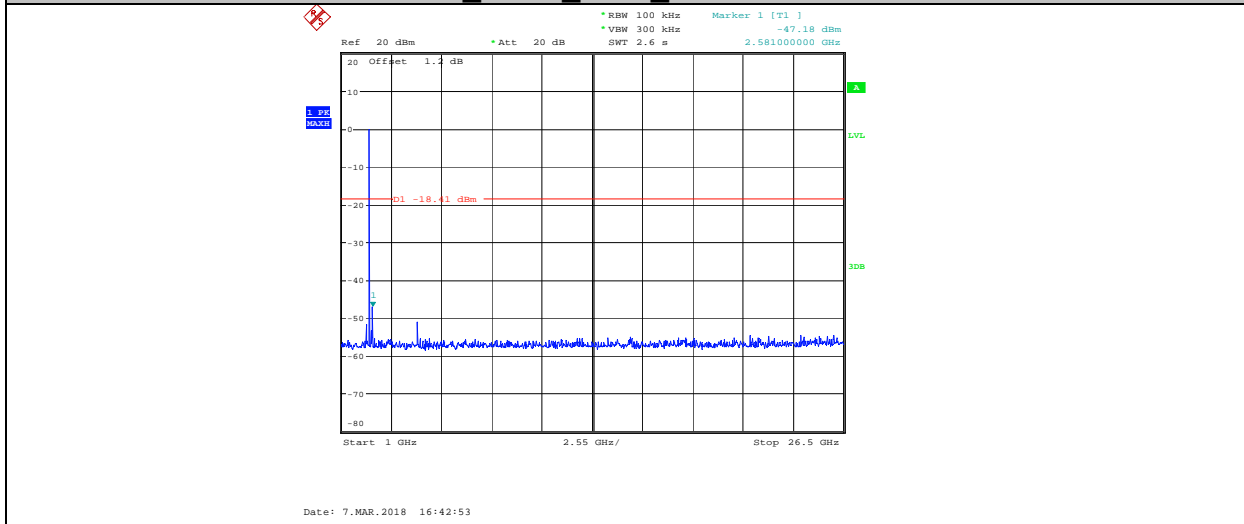

BLE_ANT1_2480_Ref

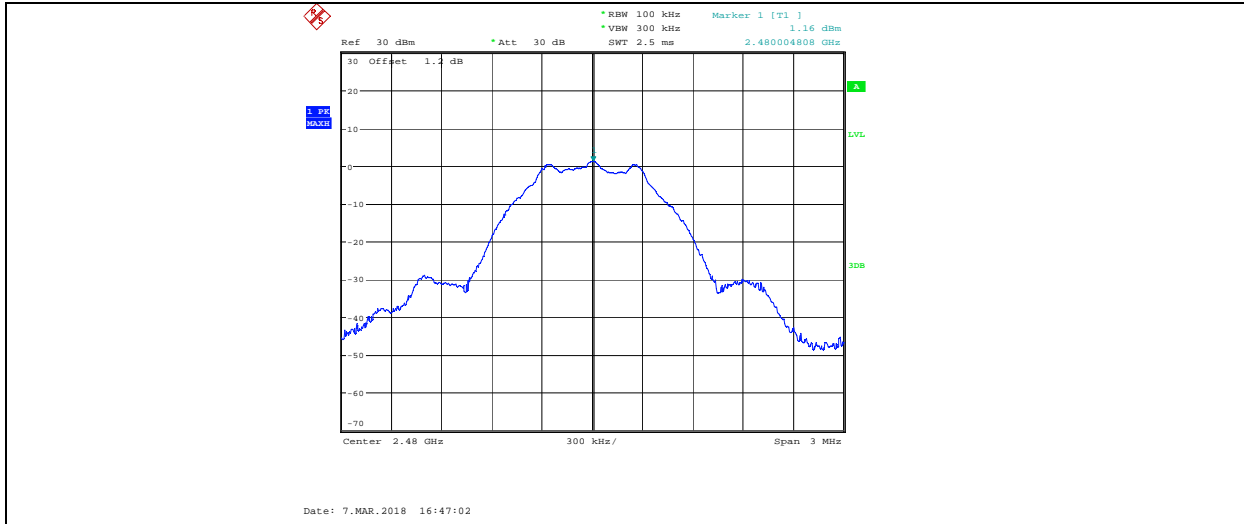

BLE ANT1 2480 30~1000

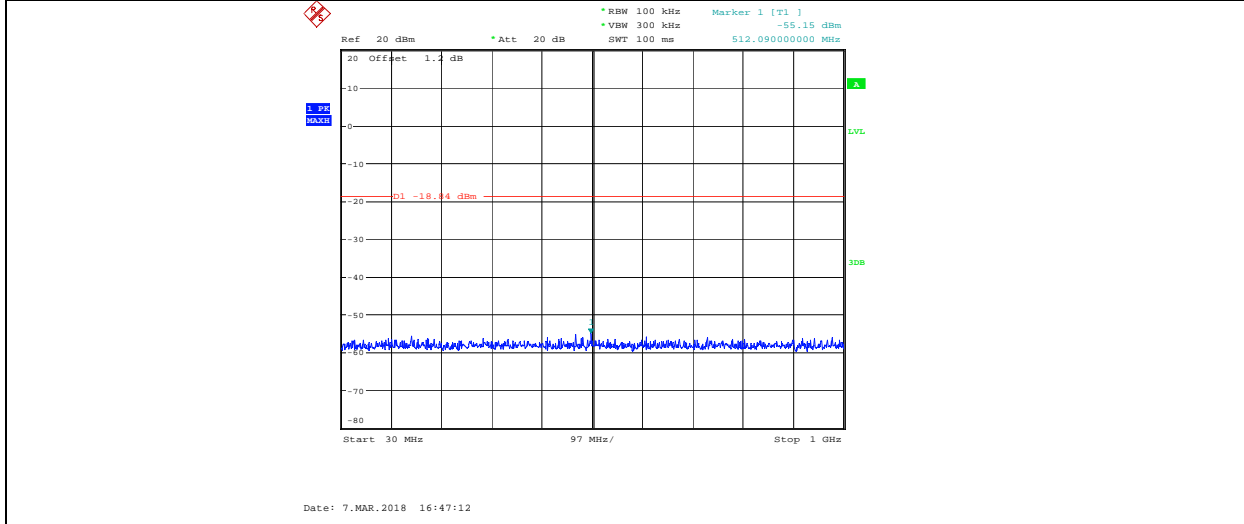

BLE ANT1 2480 1000~26500

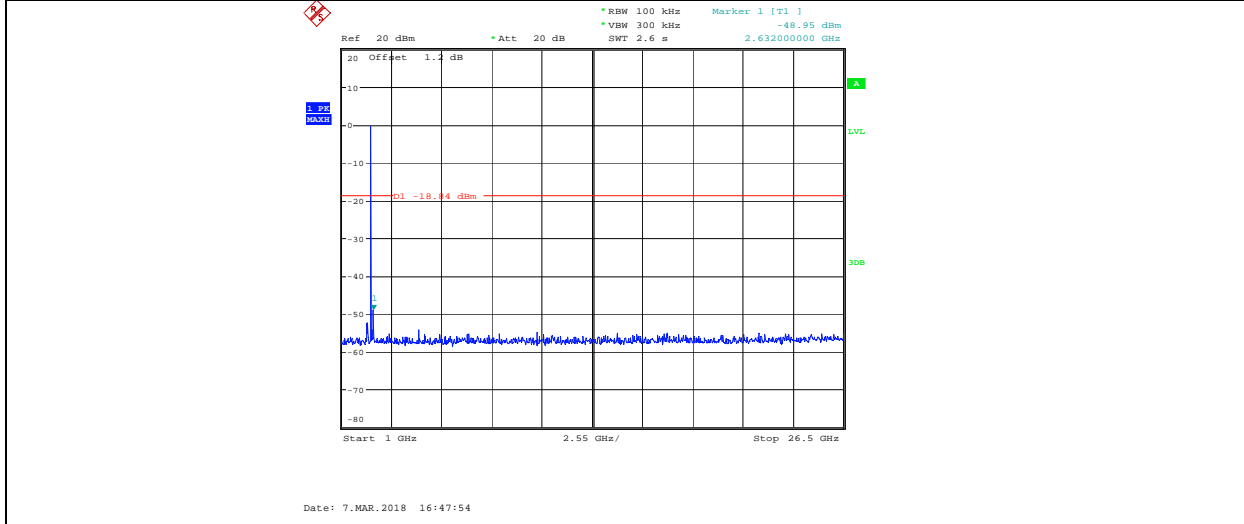

10. Emissions in restricted frequency bands

10.1. Block diagram of test setup

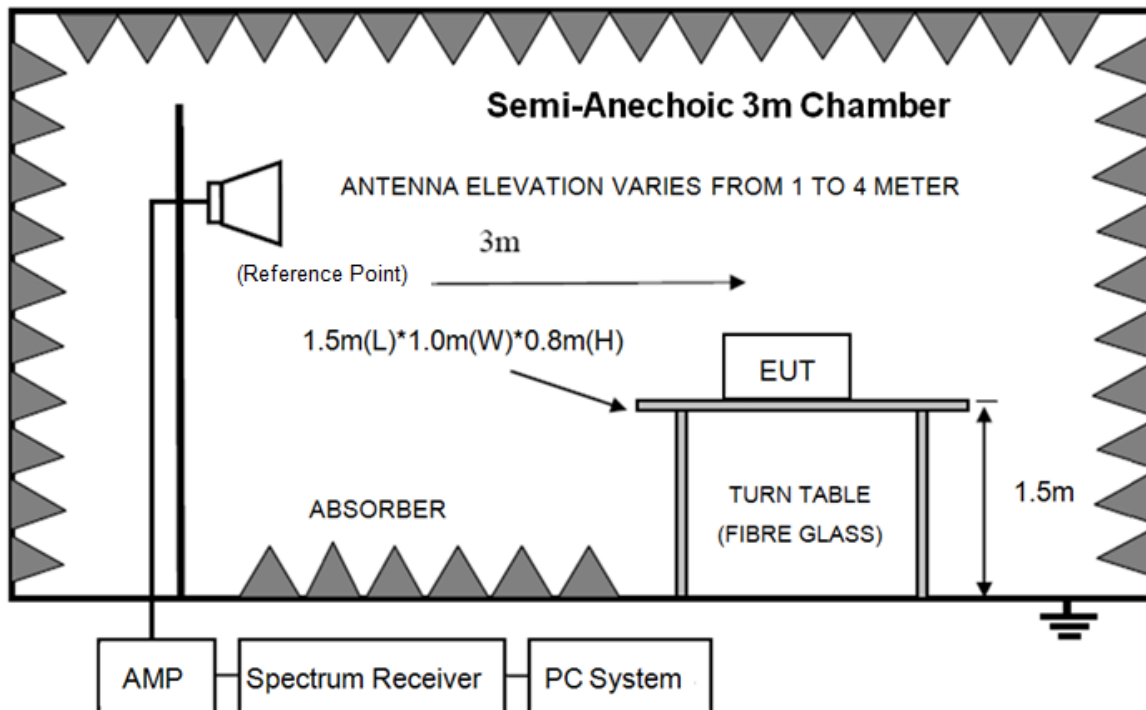

10.2. Limit

All the lower and upper band-edges emissions appearing within 2310MHz to 2390MHz and 2483.5MHz to 2500MHz restricted frequency bands shall not exceed the limits shown in 15.209, all the other emissions outside operation frequency band 2400MHz to 2483.5MHz and 5725MHz to 5850MHz shall be at least 20dB below the fundamental emissions, or comply with 15.209 limits.

10.3. Test Procedure

Same with clause 8.3 except change investigated frequency range from 2310MHz to 2415MHz and 2475MHz to 2500MHz.

Remark: All restriction band have been tested, and only the worse case is shown in report.

10.4. Test result

PASS. (See below detailed test result)

TR-4-E-009 Radiated Emission Test Result

Test Site : DDT 3m Chamber 1# D:\2018 RE1# Report Data\Q18012408-1E V710GA\FCC ABOVE1G.EM6
Test Date : 2018-03-05 **Tested By** : Talent
EUT : Bluetooth headset **Model Number** : Everest 710GA
Power Supply : Battery **Test Mode** : Tx mode
Condition : Temp:24.5°C,Humi:55%,
 Press:100.1kPa **Antenna/Distance** : 2017 HF907/3m/VERTICAL
Memo : BLE 2402

Data: 17

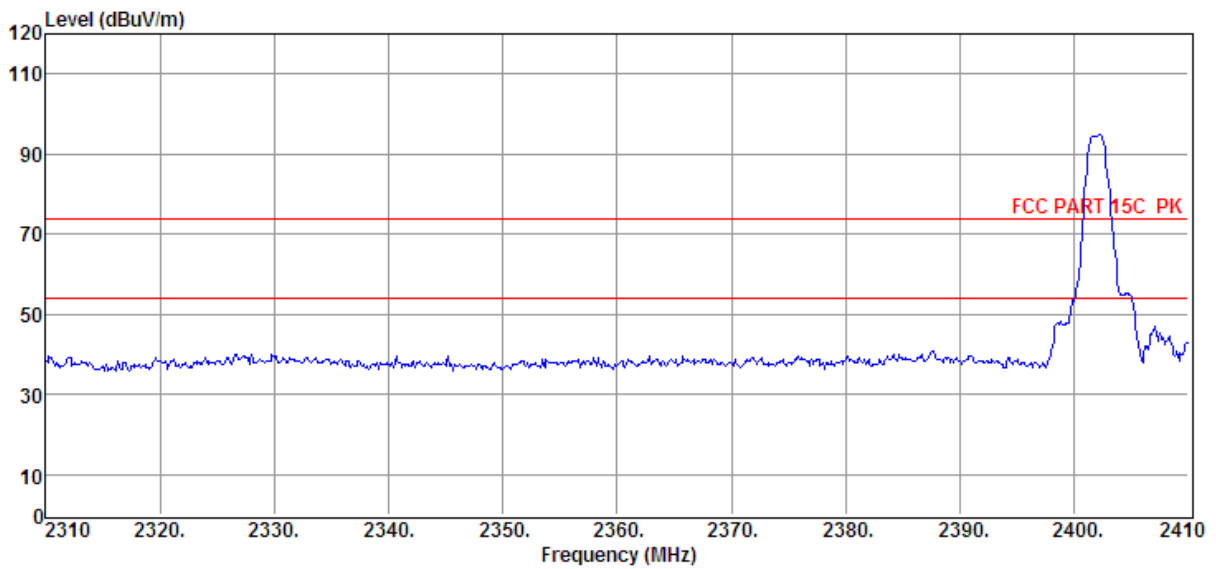

Item	Freq.	Read Level	Antenna Factor	PRM Factor	Cable Loss	Result Level	Limit Line	Over Limit	Detector	Polarization
(Mark)	(MHz)	(dBμV)	(dB/m)	dB	dB	(dBμV/m)	(dBμV/m)	(dB)		

- Note: 1. Result Level = Read Level + Antenna Factor + Cable loss - PRM Factor.
 2. If Peak Result complies with AV limit, AV Result is deemed to comply with AV limit.
 3. Test setup: RBW: 1 MHz, VBW: 3 MHz, Sweep time: auto.

TR-4-E-009 Radiated Emission Test Result

Test Site : DDT 3m Chamber 1#
Test Date : 2018-03-05
EUT : Bluetooth headset
Power Supply : Battery
Condition : Temp:24.5°C,Humi:55%,
 Press:100.1kPa
Memo : BLE 2402

D:\2018 RE1# Report Data\Q18012408-1E V710GA\FCC ABOVE1G.EM6
Tested By : Talent
Model Number : Everest 710GA
Test Mode : Tx mode
Antenna/Distance : 2017 HF907/3m/HORIZONTAL

Data: 18

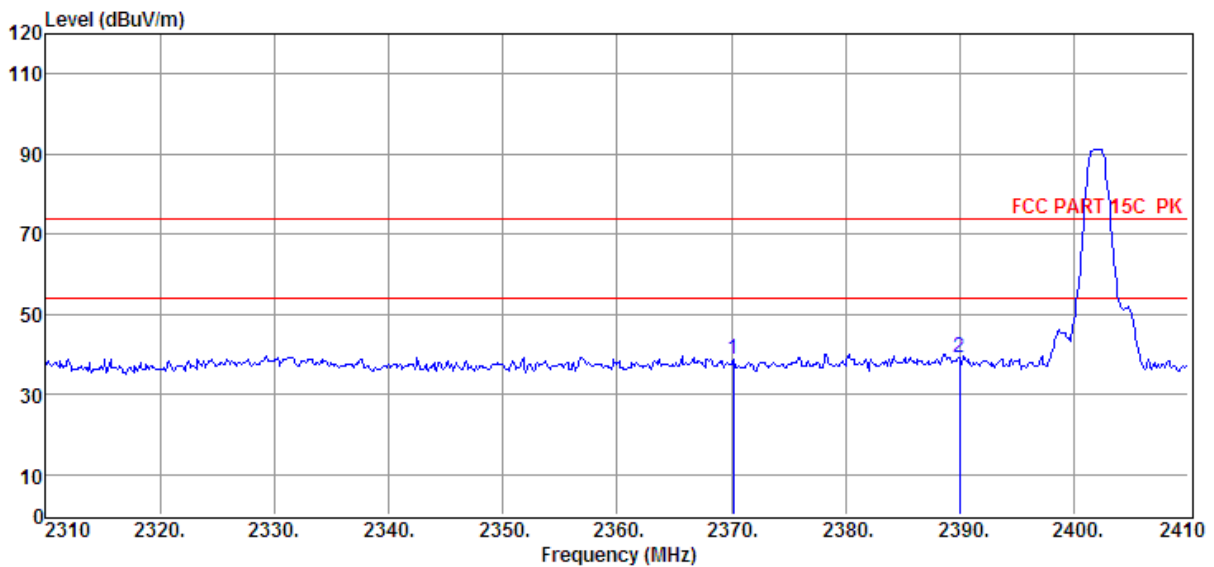

Item (Mark)	Freq. (MHz)	Read Level (dBμV)	Antenna Factor (dB/m)	PRM Factor dB	Cable Loss dB	Result Level (dBμV/m)	Limit Line (dBμV/ m)	Over Limit (dB)	Detector	Polarization
1	2370.20	36.11	26.93	29.37	5.09	38.76	74.00	-35.24	Peak	HORIZONTAL
2	2390.00	36.59	27.00	29.42	5.11	39.28	74.00	-34.72	Peak	HORIZONTAL

- Note: 1. Result Level = Read Level + Antenna Factor + Cable loss - PRM Factor.
 2. If Peak Result complies with AV limit, AV Result is deemed to comply with AV limit.
 3. Test setup: RBW: 1 MHz, VBW: 3 MHz, Sweep time: auto.

TR-4-E-009 Radiated Emission Test Result

Test Site : DDT 3m Chamber 1# D:\2018 RE1# Report Data\Q18012408-1E V710GA\FCC ABOVE1G.EM6
Test Date : 2018-03-05 **Tested By** : Talent
EUT : Bluetooth headset **Model Number** : Everest 710GA
Power Supply : Battery **Test Mode** : Tx mode
Condition : Temp:24.5°C,Humi:55%,
 Press:100.1kPa **Antenna/Distance** : 2017 HF907/3m/HORIZONTAL
Memo : BLE 2480

Data: 23

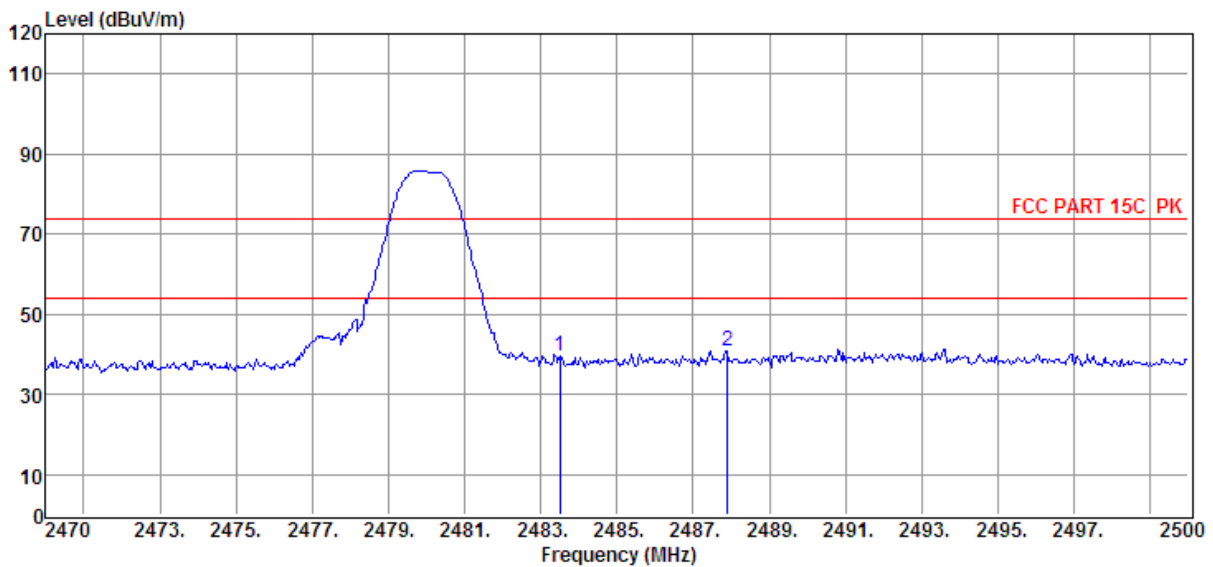

Item (Mark)	Freq. (MHz)	Read Level (dBμV)	Antenna Factor (dB/m)	PRM Factor dB	Cable Loss dB	Result Level (dBμV/m)	Limit Line (dBμV/ m)	Over Limit (dB)	Detector	Polarization
1	2483.50	36.69	27.34	29.71	5.21	39.53	74.00	-34.47	Peak	HORIZONTAL
2	2487.91	38.00	27.36	29.71	5.22	40.87	74.00	-33.13	Peak	HORIZONTAL

- Note: 1. Result Level = Read Level + Antenna Factor + Cable loss - PRM Factor.
 2. If Peak Result complies with AV limit, AV Result is deemed to comply with AV limit.
 3. Test setup: RBW: 1 MHz, VBW: 3 MHz, Sweep time: auto.

TR-4-E-009 Radiated Emission Test Result

Test Site : DDT 3m Chamber 1# D:\2018 RE1# Report Data\Q18012408-1E V710GA\FCC ABOVE1G.EM6
Test Date : 2018-03-05 **Tested By** : Talent
EUT : Bluetooth headset **Model Number** : Everest 710GA
Power Supply : Battery **Test Mode** : Tx mode
Condition : Temp:24.5°C,Humi:55%,
 Press:100.1kPa **Antenna/Distance** : 2017 HF907/3m/VERTICAL
Memo : BLE 2480

Data: 24

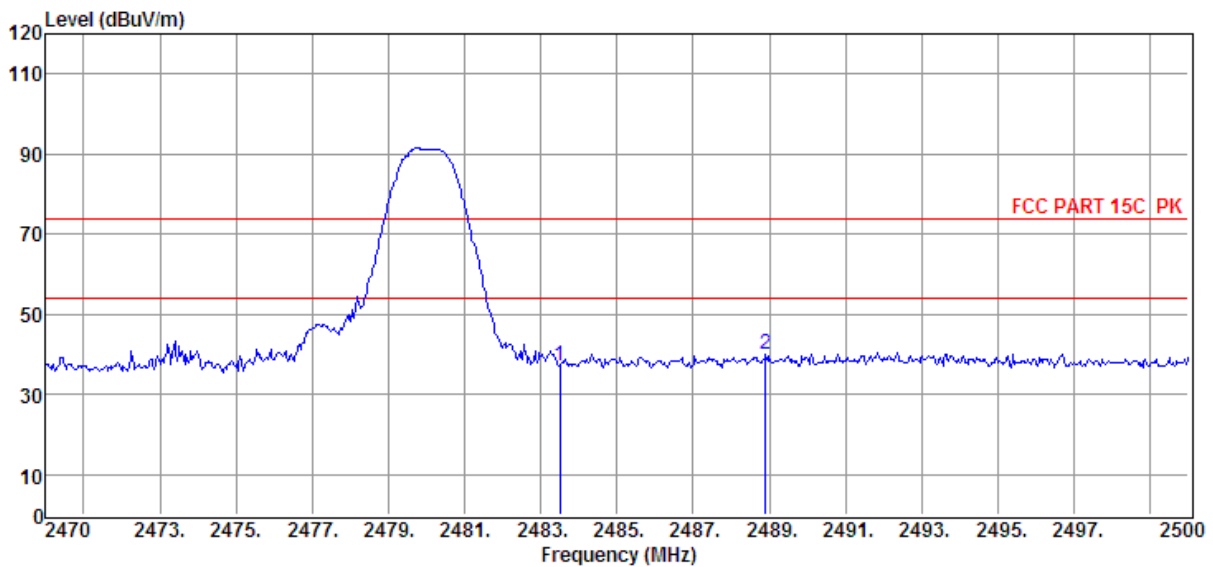

Item (Mark)	Freq. (MHz)	Read Level (dBμV)	Antenna Factor (dB/m)	PRM Factor dB	Cable Loss dB	Result Level (dBμV/m)	Limit Line (dBμV/ m)	Over Limit (dB)	Detector	Polarization
1	2483.50	34.10	27.34	29.71	5.21	36.94	74.00	-37.06	Peak	VERTICAL
2	2488.90	37.16	27.36	29.71	5.22	40.03	74.00	-33.97	Peak	VERTICAL

- Note: 1. Result Level = Read Level + Antenna Factor + Cable loss - PRM Factor.
 2. If Peak Result complies with AV limit, AV Result is deemed to comply with AV limit.
 3. Test setup: RBW: 1 MHz, VBW: 3 MHz, Sweep time: auto.

11. Power Line Conducted Emission

11.1. Block diagram of test setup

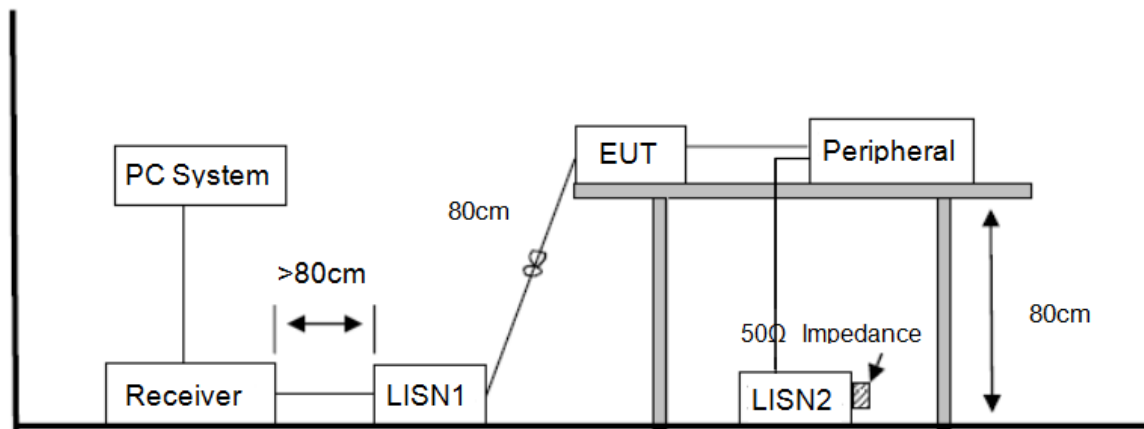

11.2. Power Line Conducted Emission Limits

Frequency	Quasi-Peak Level dB(μ V)	Average Level dB(μ V)
150kHz ~ 500kHz	66 ~ 56*	56 ~ 46*
500kHz ~ 5MHz	56	46
5MHz ~ 30MHz	60	50

Note 1: * Decreasing linearly with logarithm of frequency.

Note 2: The lower limit shall apply at the transition frequencies.

11.3. Test Procedure

The EUT and Support equipment, if needed, were put placed on a non-metallic table, 80cm above the ground plane.

Configuration EUT to simulate typical usage as described in clause 2.4 and test equipment as described in clause 10.2 of this report.

All I/O cables were positioned to simulate typical actual usage as per ANSI C63.10.

All support equipment power received from a second LISN.

Emissions were measured on each current carrying line of the EUT using an EMI Test Receiver connected to the LISN powering the EUT.

The Receiver scanned from 150 kHz to 30MHz for emissions in each of the test modes.

During the above scans, the emissions were maximized by cable manipulation.

The test mode(s) described in clause 2.4 were scanned during the preliminary test.

After the preliminary scan, we found the test mode producing the highest emission level.

The EUT configuration and worse cable configuration of the above highest emission levels were recorded for reference of the final test.

EUT and support equipment were set up on the test bench as per the configuration with highest emission level in the preliminary test.

A scan was taken on both power lines, Neutral and Line, recording at least the six highest emissions.

Emission frequency and amplitude were recorded into a computer in which correction factors were used to calculate the emission level and compare reading to the applicable limit.

The test data of the worst-case condition(s) was recorded.

The bandwidth of test receiver is set at 9 kHz.

11.4. Test Result

PASS. (See below detailed test result)

Note1: All emissions not reported below are too low against the prescribed limits.

Note2: "----" means Peak detection; "----" means Average detection

Note3:Pre-test AC conducted emission at both voltage AC 120V/60Hz and AC 230V/50Hz, recorded worst case.

TR-4-E-010 Conducted Emission Test Result

Test Site : DDT 1# Shield Room E:\2018 CE report data\Q18012408-1E\CE.EM6
Test Date : 2018-02-28 **Tested By** : Xuemin
EUT : Bluetooth headset **Model Number** : Everest 710GA
Power Supply : AC 120V/60Hz **Test Mode** : Tx mode
Condition : Temp:24.5°C,Humi:55%,
LISN : 2016 ENV216/LINE
Press:100.1kPa
Memo :

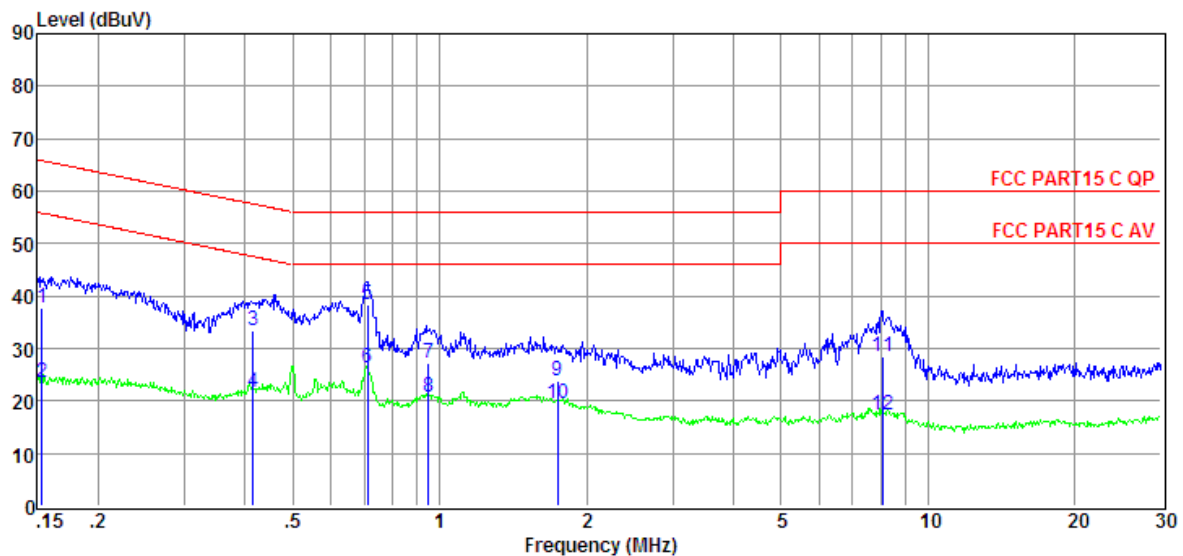

Item (Mark)	Freq. (MHz)	Read Level (dBμV)	LISN Factor (dB)	Cable Loss (dB)	Pulse Limiter Factor (dB)	Result Level (dBμV)	Limit Line (dBμV)	Over Limit (dB)	Detector	Phase
1	0.15	18.22	9.62	0.02	9.86	37.72	65.82	-28.10	QP	LINE
2	0.15	3.97	9.62	0.02	9.86	23.47	55.82	-32.35	Average	LINE
3	0.41	13.77	9.62	0.02	9.86	33.27	57.55	-24.28	QP	LINE
4	0.41	2.26	9.62	0.02	9.86	21.76	47.55	-25.79	Average	LINE
5	0.71	18.75	9.62	0.03	9.86	38.26	56.00	-17.74	QP	LINE
6	0.71	6.64	9.62	0.03	9.86	26.15	46.00	-19.85	Average	LINE
7	0.95	7.67	9.62	0.03	9.86	27.18	56.00	-28.82	QP	LINE
8	0.95	1.26	9.62	0.03	9.86	20.77	46.00	-25.23	Average	LINE
9	1.74	4.19	9.63	0.04	9.87	23.73	56.00	-32.27	QP	LINE
10	1.74	-0.10	9.63	0.04	9.87	19.44	46.00	-26.56	Average	LINE
11	8.06	8.75	9.71	0.09	9.89	28.44	60.00	-31.56	QP	LINE
12	8.06	-2.33	9.71	0.09	9.89	17.36	50.00	-32.64	Average	LINE

Note: 1. Result Level = Read Level + LISN Factor + Pulse Limiter Factor + Cable loss.

2. If QP Result complies with AV limit, AV Result is deemed to comply with AV limit.

3. Test setup: RBW: 200 Hz (9 kHz—150 kHz), 9 kHz (150 kHz—30 MHz).

4. Step size: 80Hz (0.009MHz-0.15MHz), 4 kHz (0.15MHz-30MHz), Scan time: auto.

TR-4-E-010 Conducted Emission Test Result

Test Site : DDT 1# Shield Room E:\2018 CE report data\Q18012408-1E\CE.EM6
Test Date : 2018-02-28 **Tested By** : Xuemin
EUT : Bluetooth headset **Model Number** : Everest 710GA
Power Supply : AC 120V/60Hz **Test Mode** : Tx mode
Condition : Temp:24.5°C,Humi:55%,
LISN : 2016 ENV216/NEUTRAL
 Press:100.1kPa
Memo :

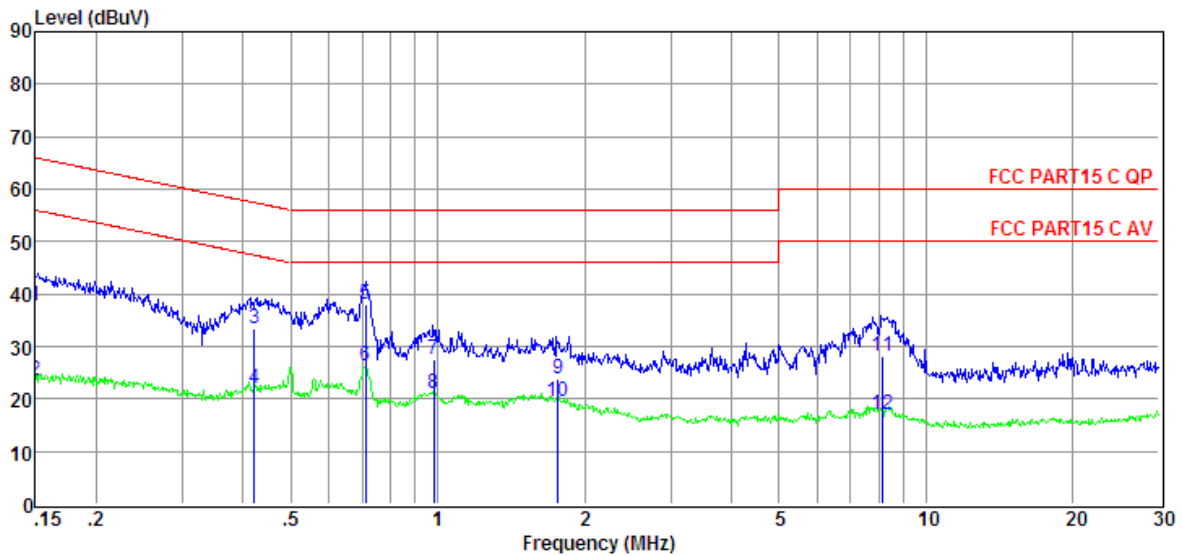

Item (Mark)	Freq. (MHz)	Read Level (dBμV)	LISN Factor (dB)	Cable Loss (dB)	Pulse Limiter Factor (dB)	Result Level (dBμV)	Limit Line (dBμV)	Over Limit (dB)	Detector	Phase
1	0.15	18.22	9.60	0.02	9.86	37.70	66.00	-28.30	QP	NEUTRAL
2	0.15	4.11	9.60	0.02	9.86	23.59	56.00	-32.41	Average	NEUTRAL
3	0.42	13.83	9.60	0.02	9.86	33.31	57.42	-24.11	QP	NEUTRAL
4	0.42	2.38	9.60	0.02	9.86	21.86	47.42	-25.56	Average	NEUTRAL
5	0.71	18.64	9.60	0.03	9.86	38.13	56.00	-17.87	QP	NEUTRAL
6	0.71	6.73	9.60	0.03	9.86	26.22	46.00	-19.78	Average	NEUTRAL
7	0.98	7.97	9.61	0.03	9.86	27.47	56.00	-28.53	QP	NEUTRAL
8	0.98	1.60	9.61	0.03	9.86	21.10	46.00	-24.90	Average	NEUTRAL
9	1.76	4.19	9.62	0.04	9.87	23.72	56.00	-32.28	QP	NEUTRAL
10	1.76	-0.17	9.62	0.04	9.87	19.36	46.00	-26.64	Average	NEUTRAL
11	8.15	8.48	9.71	0.09	9.89	28.17	60.00	-31.83	QP	NEUTRAL
12	8.15	-2.55	9.71	0.09	9.89	17.14	50.00	-32.86	Average	NEUTRAL

- Note: 1. Result Level = Read Level + LISN Factor + Pulse Limiter Factor + Cable loss.
 2. If QP Result complies with AV limit, AV Result is deemed to comply with AV limit.
 3. Test setup: RBW: 200 Hz (9 kHz—150 kHz), 9 kHz (150 kHz—30 MHz).
 4. Step size: 80Hz (0.009MHz-0.15MHz), 4 kHz (0.15MHz-30MHz), Scan time: auto.

12. Antenna Requirements

12.1. Limit

For intentional device, according to FCC 47 CFR Section 15.203, an intentional radiator shall be designed to ensure that no antenna other than that furnished by the responsible party shall be used with the device. And according to FCC 47 CFR Section 15.247 (b), if transmitting antennas of directional gain greater than 6dBi are used, the power shall be reduced by the amount in dB that the directional gain of the antenna exceeds 6dBi.

12.2. Result

The antennas used for this product is integrated antenna and that no antenna other than that furnished by the responsible party shall be used with the device, the maximum peak gain of the transmit antenna is only 2.0dBi.

END OF REPORT