

Test Mode: 06; Polarity: Horizontal; Modulation:802.11ac; Bandwidth:20MHz; Channel:High

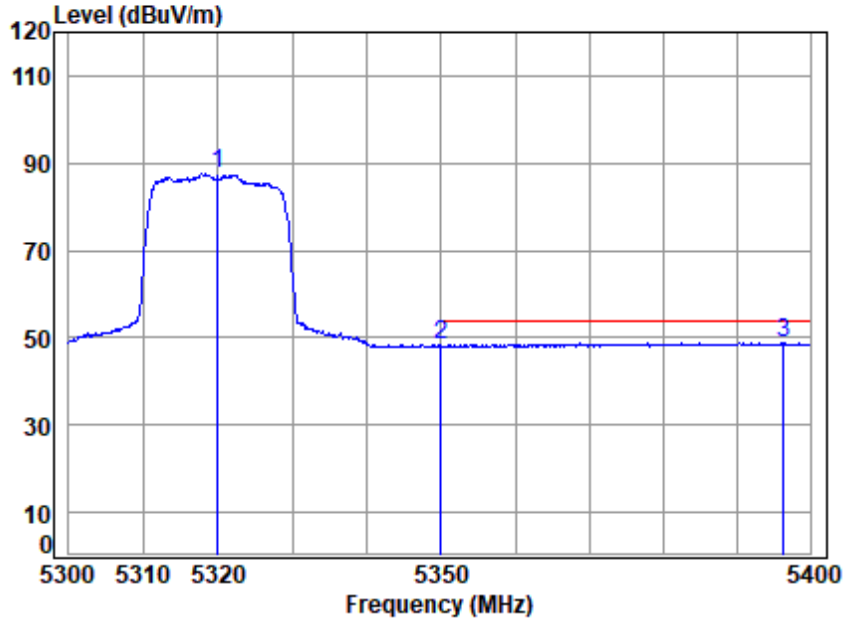

Site : chamber
 Condition: 3m HORIZONTAL
 Job No : 00750AT\00751AT
 Mode : 5320 Band edge
 : 5G WIFI 11AC20

	Freq	Cable Loss	Ant Factor	Preamp Factor	Read Level	Level	Limit	Over	Remark
	MHz	dB	dB/m	dB	dBuV	dBuV/m	dBuV/m	dB	
1	5320.000	7.53	34.24	35.00	80.82	87.59	-----	-----	Average
2	5350.020	7.56	34.30	35.00	41.29	48.15	54.00	-5.85	Average
3 q	5396.368	7.61	34.49	35.01	41.89	48.98	54.00	-5.02	Average



Unless otherwise agreed in writing, this document is issued by the Company subject to its General Conditions of Service printed overleaf, available on request or accessible at <http://www.sgs.com/en/Terms-and-Conditions.aspx> and, for electronic format documents, subject to Terms and Conditions for Electronic Documents at <http://www.sgs.com/en/Terms-and-Conditions/Terms-e-Documents.aspx>. Attention is drawn to the limitation of liability, indemnification and jurisdiction issues defined therein. Any holder of this document is advised that information contained hereon reflects the Company's findings at the time of its intervention only and within the limits of Client's instructions, if any. The Company's sole responsibility is to its Client and this document does not exonerate parties to a transaction from exercising all their rights and obligations under the transaction documents. This document cannot be reproduced except in full, without prior written approval of the Company. Any unauthorized alteration, forgery or falsification of the content or appearance of this document is unlawful and offenders may be prosecuted to the fullest extent of the law. Unless otherwise stated the results shown in this test report refer only to the sample(s) tested and such sample(s) are retained for 30 days only.

Test Mode: 06; Polarity: Vertical; Modulation:802.11ac; Bandwidth:20MHz; Channel:High

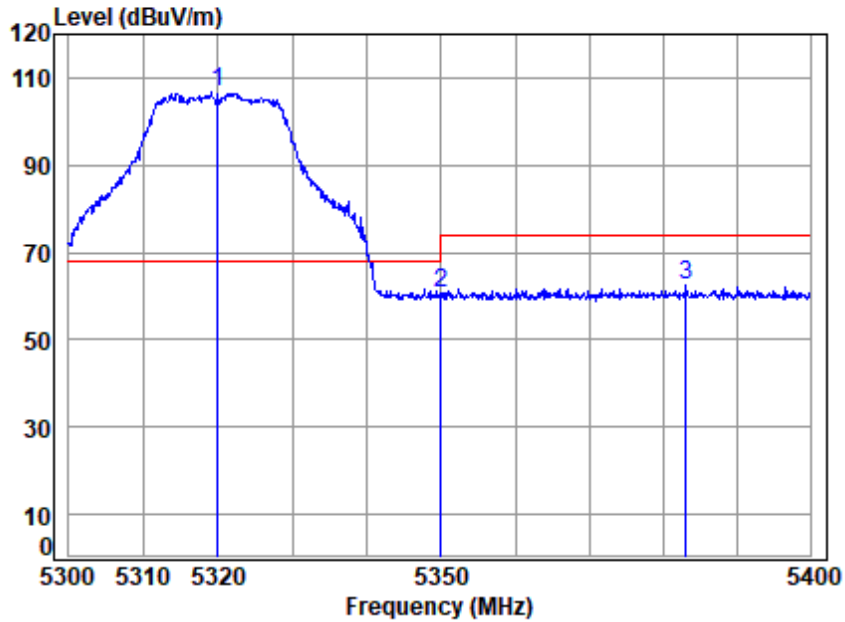

Site : chamber
 Condition: 3m VERTICAL
 Job No : 00750AT\00751AT
 Mode : 5320 Band edge
 : 5G WIFI 11AC20

		Cable	Ant	Preamp	Read	Limit	Over	
Freq		Loss	Factor	Factor	Level	Level	Line	Limit
	MHz	dB	dB/m	dB	dBuV	dBuV/m	dBuV/m	dB
1 q	5320.000	7.53	34.24	35.00	99.78	106.55	68.20	38.35 Peak
2	5350.020	7.56	34.30	35.00	53.84	60.70	74.00	-13.30 Peak
3	5383.170	7.59	34.43	35.00	55.34	62.36	74.00	-11.64 Peak



Unless otherwise agreed in writing, this document is issued by the Company subject to its General Conditions of Service printed overleaf, available on request or accessible at <http://www.sgs.com/en/Terms-and-Conditions.aspx> and, for electronic format documents, subject to Terms and Conditions for Electronic Documents at <http://www.sgs.com/en/Terms-and-Conditions/Terms-e-Documents.aspx>. Attention is drawn to the limitation of liability, indemnification and jurisdiction issues defined therein. Any holder of this document is advised that information contained hereon reflects the Company's findings at the time of its intervention only and within the limits of Client's instructions, if any. The Company's sole responsibility is to its Client and this document does not exonerate parties to a transaction from exercising all their rights and obligations under the transaction documents. This document cannot be reproduced except in full, without prior written approval of the Company. Any unauthorized alteration, forgery or falsification of the content or appearance of this document is unlawful and offenders may be prosecuted to the fullest extent of the law. Unless otherwise stated the results shown in this test report refer only to the sample(s) tested and such sample(s) are retained for 30 days only.

Test Mode: 06; Polarity: Vertical; Modulation:802.11ac; Bandwidth:20MHz; Channel:High

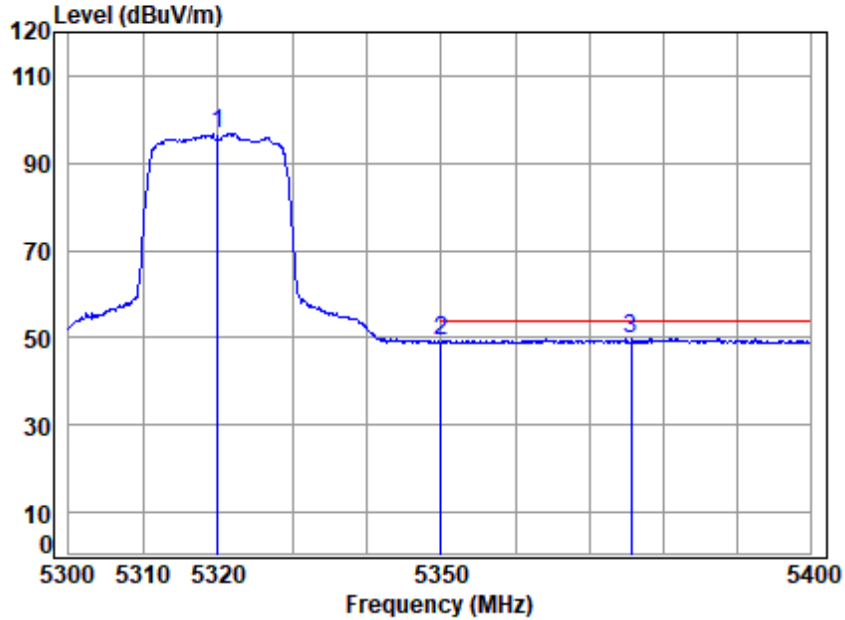

Site : chamber
 Condition: 3m VERTICAL
 Job No : 00750AT\00751AT
 Mode : 5320 Band edge
 : 5G WIFI 11AC20

	Freq	Cable Loss	Ant Factor	Preamp Factor	Read Level	Level	Limit	Over	Remark
	MHz	dB	dB/m	dB	dBuV	dBuV/m	dBuV/m	dB	
1	5320.000	7.53	34.24	35.00	89.92	96.69	-----	-----	Average
2	5350.020	7.56	34.30	35.00	42.31	49.17	54.00	-4.83	Average
3 q	5375.729	7.59	34.40	35.00	42.81	49.80	54.00	-4.20	Average



Unless otherwise agreed in writing, this document is issued by the Company subject to its General Conditions of Service printed overleaf, available on request or accessible at <http://www.sgs.com/en/Terms-and-Conditions.aspx> and, for electronic format documents, subject to Terms and Conditions for Electronic Documents at <http://www.sgs.com/en/Terms-and-Conditions/Terms-e-Documents.aspx>. Attention is drawn to the limitation of liability, indemnification and jurisdiction issues defined therein. Any holder of this document is advised that information contained hereon reflects the Company's findings at the time of its intervention only and within the limits of Client's instructions, if any. The Company's sole responsibility is to its Client and this document does not exonerate parties to a transaction from exercising all their rights and obligations under the transaction documents. This document cannot be reproduced except in full, without prior written approval of the Company. Any unauthorized alteration, forgery or falsification of the content or appearance of this document is unlawful and offenders may be prosecuted to the fullest extent of the law. Unless otherwise stated the results shown in this test report refer only to the sample(s) tested and such sample(s) are retained for 30 days only.

Test Mode: 06; Polarity: Horizontal; Modulation:802.11ac; Bandwidth:40MHz; Channel:Low

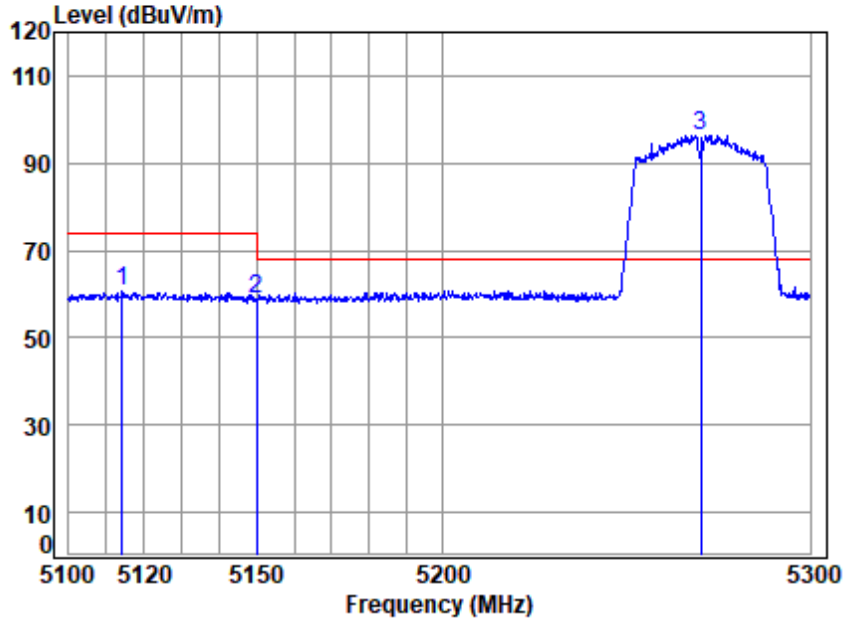

Site : chamber
 Condition: 3m HORIZONTAL
 Job No : 00750AT\00751AT
 Mode : 5270 Band edge
 : 5G WIFI 11AC40

		Cable	Ant	Preamp	Read	Limit	Over	
	Freq	Loss	Factor	Factor	Level	Line	Limit	Remark
	MHz	dB	dB/m	dB	dBuV	dBuV/m	dBuV/m	dB
1	5114.145	7.33	34.07	34.99	54.08	60.49	74.00	-13.51 peak
2	5149.980	7.36	34.00	34.99	52.57	58.94	74.00	-15.06 peak
3 q	5270.000	7.48	34.08	35.00	89.93	96.49	68.20	28.29 peak



Unless otherwise agreed in writing, this document is issued by the Company subject to its General Conditions of Service printed overleaf, available on request or accessible at <http://www.sgs.com/en/Terms-and-Conditions.aspx> and, for electronic format documents, subject to Terms and Conditions for Electronic Documents at <http://www.sgs.com/en/Terms-and-Conditions/Terms-e-Documents.aspx>. Attention is drawn to the limitation of liability, indemnification and jurisdiction issues defined therein. Any holder of this document is advised that information contained hereon reflects the Company's findings at the time of its intervention only and within the limits of Client's instructions, if any. The Company's sole responsibility is to its Client and this document does not exonerate parties to a transaction from exercising all their rights and obligations under the transaction documents. This document cannot be reproduced except in full, without prior written approval of the Company. Any unauthorized alteration, forgery or falsification of the content or appearance of this document is unlawful and offenders may be prosecuted to the fullest extent of the law. Unless otherwise stated the results shown in this test report refer only to the sample(s) tested and such sample(s) are retained for 30 days only.
 Attention: To check the authenticity of testing /inspection report & certificate, please contact us at telephone: (86-755) 8307 1443, or email: CN.Doccheck@sgs.com

Test Mode: 06; Polarity: Horizontal; Modulation:802.11ac; Bandwidth:40MHz; Channel:Low

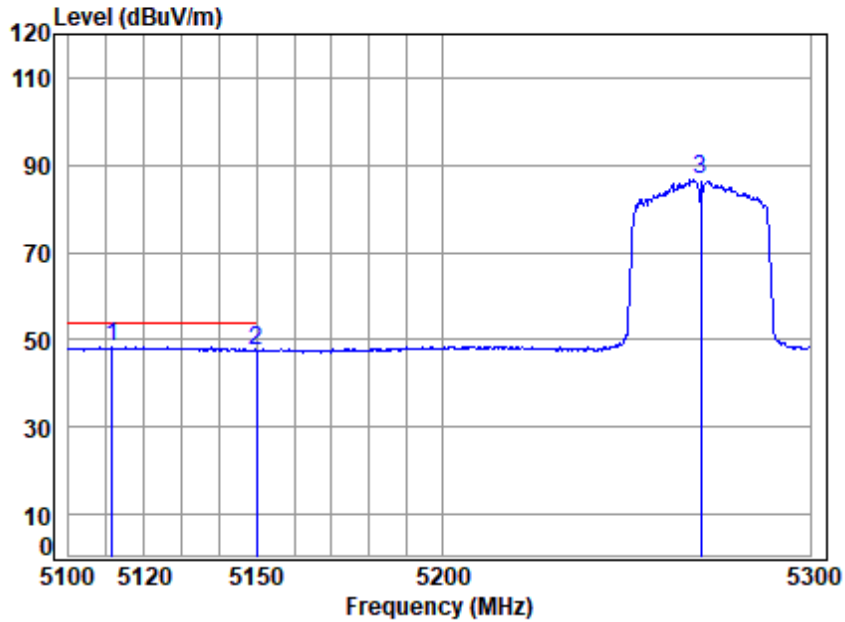

Site : chamber
 Condition: 3m HORIZONTAL
 Job No : 00750AT\00751AT
 Mode : 5270 Band edge
 : 5G WIFI 11AC40

		Cable	Ant	Preamp	Read	Limit	Over	
Freq		Loss	Factor	Factor	Level	Line	Limit	Remark
	MHz	dB	dB/m	dB	dBuV	dBuV/m	dBuV/m	dB
1 q	5111.391	7.32	34.08	34.99	42.05	48.46	54.00	-5.54 Average
2	5149.980	7.36	34.00	34.99	41.30	47.67	54.00	-6.33 Average
3	5270.000	7.48	34.08	35.00	80.05	86.61	-----	----- Average



Unless otherwise agreed in writing, this document is issued by the Company subject to its General Conditions of Service printed overleaf, available on request or accessible at <http://www.sgs.com/en/Terms-and-Conditions.aspx> and, for electronic format documents, subject to Terms and Conditions for Electronic Documents at <http://www.sgs.com/en/Terms-and-Conditions/Terms-e-Documents.aspx>. Attention is drawn to the limitation of liability, indemnification and jurisdiction issues defined therein. Any holder of this document is advised that information contained hereon reflects the Company's findings at the time of its intervention only and within the limits of Client's instructions, if any. The Company's sole responsibility is to its Client and this document does not exonerate parties to a transaction from exercising all their rights and obligations under the transaction documents. This document cannot be reproduced except in full, without prior written approval of the Company. Any unauthorized alteration, forgery or falsification of the content or appearance of this document is unlawful and offenders may be prosecuted to the fullest extent of the law. Unless otherwise stated the results shown in this test report refer only to the sample(s) tested and such sample(s) are retained for 30 days only.
 Attention: To check the authenticity of testing /inspection report & certificate, please contact us at telephone: (86-755) 8307 1443, or email: CN_Doccheck@sgs.com

Test Mode: 06; Polarity: Vertical; Modulation:802.11ac; Bandwidth:40MHz; Channel:Low

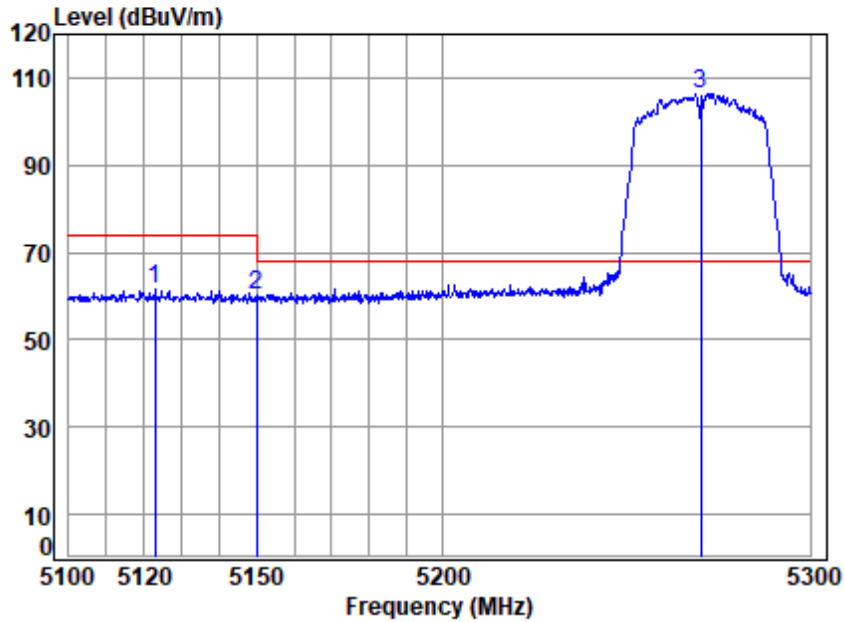

Site : chamber
 Condition: 3m VERTICAL
 Job No : 00750AT\00751AT
 Mode : 5270 Band edge
 : 5G WIFI 11AC40

		Cable	Ant	Preamp	Read	Limit	Over	
	Freq	Loss	Factor	Factor	Level	Line	Limit	Remark
	MHz	dB	dB/m	dB	dBuV	dBuV/m	dBuV/m	dB
1	5122.808	7.34	34.05	34.99	55.41	61.81	74.00	-12.19 Peak
2	5149.980	7.36	34.00	34.99	53.87	60.24	74.00	-13.76 Peak
3 q	5270.000	7.48	34.08	35.00	99.69	106.25	68.20	38.05 Peak



Unless otherwise agreed in writing, this document is issued by the Company subject to its General Conditions of Service printed overleaf, available on request or accessible at <http://www.sgs.com/en/Terms-and-Conditions.aspx> and, for electronic format documents, subject to Terms and Conditions for Electronic Documents at <http://www.sgs.com/en/Terms-and-Conditions/Terms-e-Documents.aspx>. Attention is drawn to the limitation of liability, indemnification and jurisdiction issues defined therein. Any holder of this document is advised that information contained hereon reflects the Company's findings at the time of its intervention only and within the limits of Client's instructions, if any. The Company's sole responsibility is to its Client and this document does not exonerate parties to a transaction from exercising all their rights and obligations under the transaction documents. This document cannot be reproduced except in full, without prior written approval of the Company. Any unauthorized alteration, forgery or falsification of the content or appearance of this document is unlawful and offenders may be prosecuted to the fullest extent of the law. Unless otherwise stated the results shown in this test report refer only to the sample(s) tested and such sample(s) are retained for 30 days only.

Test Mode: 06; Polarity: Vertical; Modulation:802.11ac; Bandwidth:40MHz; Channel:Low

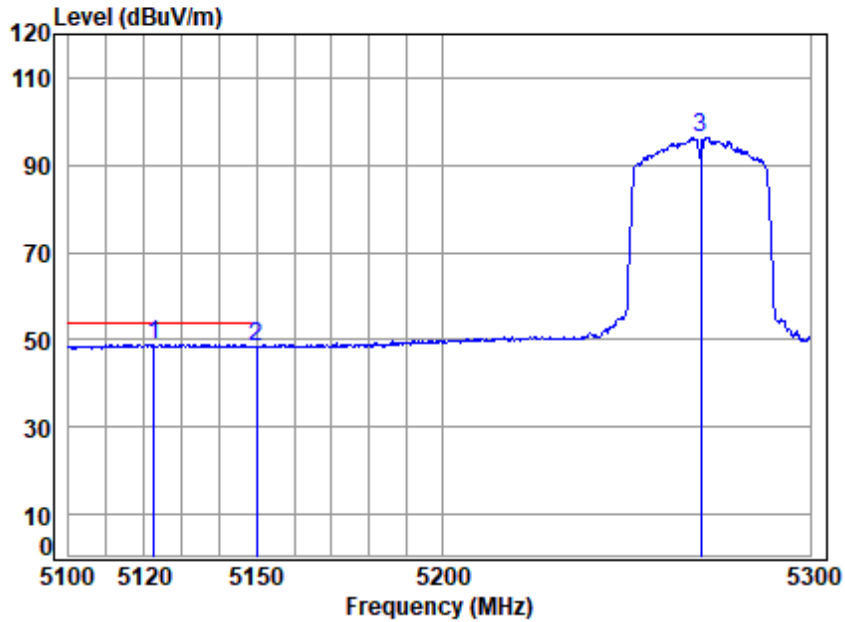

Site : chamber
 Condition: 3m VERTICAL
 Job No : 00750AT\00751AT
 Mode : 5270 Band edge
 : 5G WIFI 11AC40

		Cable	Ant	Preamp	Read	Limit	Over	
1	2	Loss	Factor	Factor	Level	Line	Limit	Remark
Freq		dB	dB/m	dB	dBuV	dBuV/m	dB	
	MHz				dBuV	dBuV/m		
1	5122.610	7.34	34.05	34.99	42.63	49.03	54.00	-4.97 Average
2	5149.980	7.36	34.00	34.99	42.22	48.59	54.00	-5.41 Average
3	5270.000	7.48	34.08	35.00	89.79	96.35	-----	----- Average



Unless otherwise agreed in writing, this document is issued by the Company subject to its General Conditions of Service printed overleaf, available on request or accessible at <http://www.sgs.com/en/Terms-and-Conditions.aspx> and, for electronic format documents, subject to Terms and Conditions for Electronic Documents at <http://www.sgs.com/en/Terms-and-Conditions/Terms-e-Documents.aspx>. Attention is drawn to the limitation of liability, indemnification and jurisdiction issues defined therein. Any holder of this document is advised that information contained hereon reflects the Company's findings at the time of its intervention only and within the limits of Client's instructions, if any. The Company's sole responsibility is to its Client and this document does not exonerate parties to a transaction from exercising all their rights and obligations under the transaction documents. This document cannot be reproduced except in full, without prior written approval of the Company. Any unauthorized alteration, forgery or falsification of the content or appearance of this document is unlawful and offenders may be prosecuted to the fullest extent of the law. Unless otherwise stated the results shown in this test report refer only to the sample(s) tested and such sample(s) are retained for 30 days only.

Test Mode: 06; Polarity: Horizontal; Modulation:802.11ac; Bandwidth:40MHz; Channel:High

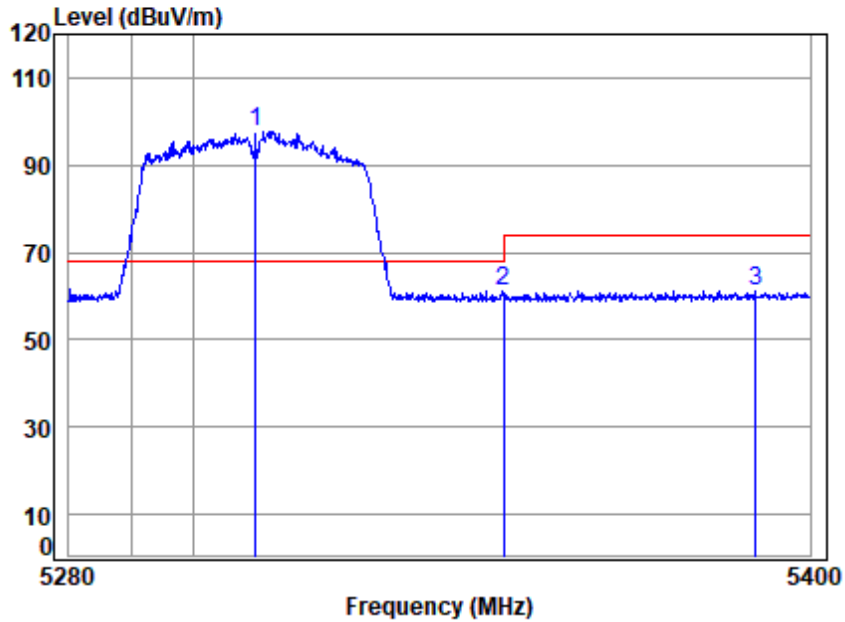

Site : chamber
 Condition: 3m HORIZONTAL
 Job No : 00750AT\00751AT
 Mode : 5310 Band edge
 : 5G WIFI 11AC40

		Cable	Ant	Preamp	Read	Limit	Over	
Freq		Loss	Factor	Factor	Level	Level	Line	Limit
	MHz	dB	dB/m	dB	dBuV	dBuV/m	dBuV/m	dB
1	q 5310.000	7.52	34.22	35.00	91.01	97.75	68.20	29.55 peak
2	5350.020	7.56	34.30	35.00	54.11	60.97	74.00	-13.03 peak
3	5391.027	7.60	34.46	35.00	54.16	61.22	74.00	-12.78 peak



Unless otherwise agreed in writing, this document is issued by the Company subject to its General Conditions of Service printed overleaf, available on request or accessible at <http://www.sgs.com/en/Terms-and-Conditions.aspx> and, for electronic format documents, subject to Terms and Conditions for Electronic Documents at <http://www.sgs.com/en/Terms-and-Conditions/Terms-e-Documents.aspx>. Attention is drawn to the limitation of liability, indemnification and jurisdiction issues defined therein. Any holder of this document is advised that information contained hereon reflects the Company's findings at the time of its intervention only and within the limits of Client's instructions, if any. The Company's sole responsibility is to its Client and this document does not exonerate parties to a transaction from exercising all their rights and obligations under the transaction documents. This document cannot be reproduced except in full, without prior written approval of the Company. Any unauthorized alteration, forgery or falsification of the content or appearance of this document is unlawful and offenders may be prosecuted to the fullest extent of the law. Unless otherwise stated the results shown in this test report refer only to the sample(s) tested and such sample(s) are retained for 30 days only.

Test Mode: 06; Polarity: Horizontal; Modulation:802.11ac; Bandwidth:40MHz; Channel:High

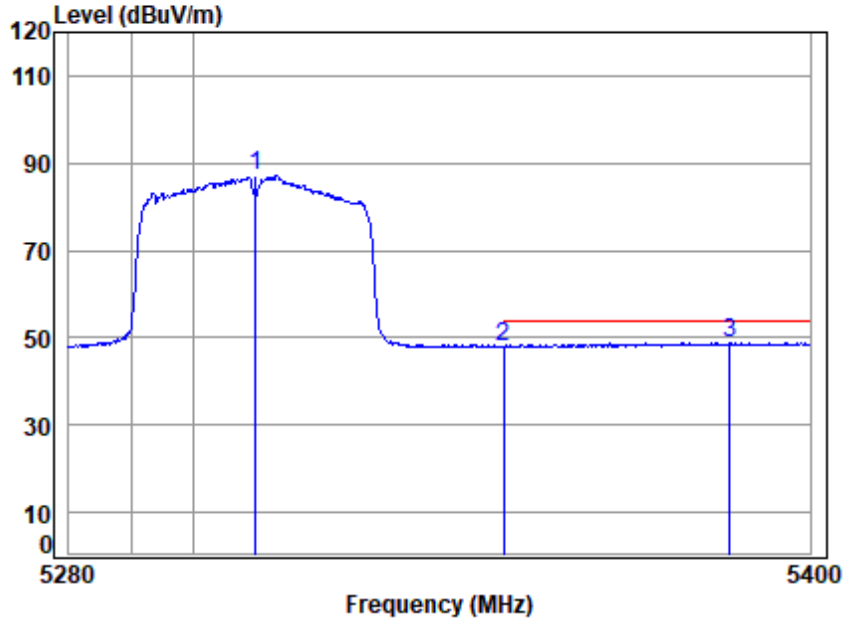

Site : chamber
 Condition: 3m HORIZONTAL
 Job No : 00750AT\00751AT
 Mode : 5310 Band edge
 : 5G WIFI 11AC40

		Cable	Ant	Preamp	Read	Limit	Over		
Freq		Loss	Factor	Factor	Level	Level	Line	Limit	Remark
	MHz	dB	dB/m	dB	dBuV	dBuV/m	dBuV/m	dB	
1	5310.000	7.52	34.22	35.00	80.60	87.34	-----	-----	Average
2	5350.020	7.56	34.30	35.00	41.27	48.13	54.00	-5.87	Average
3 q	5386.910	7.60	34.45	35.00	41.72	48.77	54.00	-5.23	Average



Unless otherwise agreed in writing, this document is issued by the Company subject to its General Conditions of Service printed overleaf, available on request or accessible at <http://www.sgs.com/en/Terms-and-Conditions.aspx> and, for electronic format documents, subject to Terms and Conditions for Electronic Documents at <http://www.sgs.com/en/Terms-and-Conditions/Terms-e-Documents.aspx>. Attention is drawn to the limitation of liability, indemnification and jurisdiction issues defined therein. Any holder of this document is advised that information contained hereon reflects the Company's findings at the time of its intervention only and within the limits of Client's instructions, if any. The Company's sole responsibility is to its Client and this document does not exonerate parties to a transaction from exercising all their rights and obligations under the transaction documents. This document cannot be reproduced except in full, without prior written approval of the Company. Any unauthorized alteration, forgery or falsification of the content or appearance of this document is unlawful and offenders may be prosecuted to the fullest extent of the law. Unless otherwise stated the results shown in this test report refer only to the sample(s) tested and such sample(s) are retained for 30 days only.
 Attention: To check the authenticity of testing /inspection report & certificate, please contact us at telephone: (86-755) 8307 1443, or email: CN.Doccheck@sgs.com

Test Mode: 06; Polarity: Vertical; Modulation:802.11ac; Bandwidth:40MHz; Channel:High

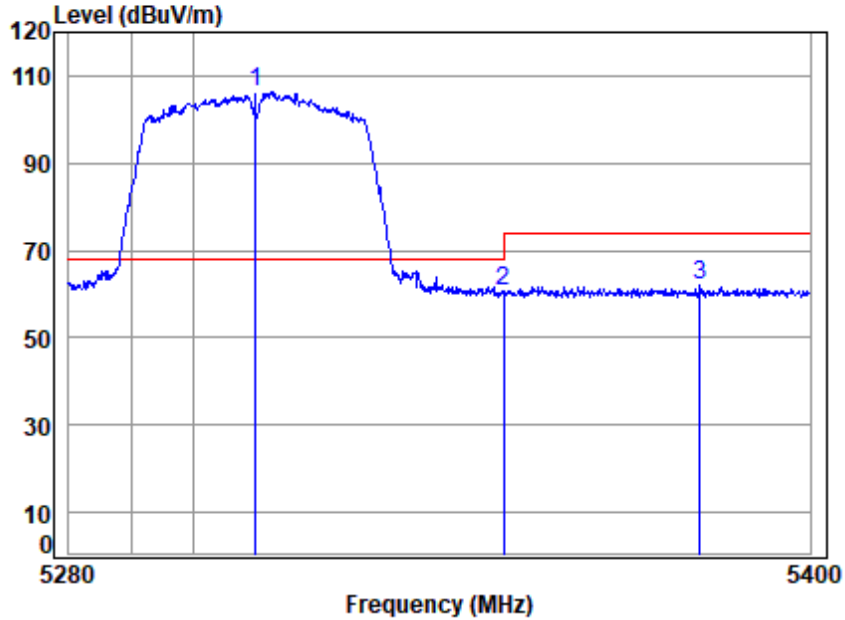

Site : chamber
 Condition: 3m VERTICAL
 Job No : 00750AT\00751AT
 Mode : 5310 Band edge
 : 5G WIFI 11AC40

		Cable	Ant	Preamp	Read	Limit	Over	
	Freq	Loss	Factor	Factor	Level	Line	Limit	Remark
	MHz	dB	dB/m	dB	dBuV	dBuV/m	dBuV/m	dB
1	q 5310.000	7.52	34.22	35.00	99.45	106.19	68.20	37.99 Peak
2	5350.020	7.56	34.30	35.00	53.84	60.70	74.00	-13.30 Peak
3	5382.069	7.59	34.43	35.00	55.20	62.22	74.00	-11.78 Peak



Unless otherwise agreed in writing, this document is issued by the Company subject to its General Conditions of Service printed overleaf, available on request or accessible at <http://www.sgs.com/en/Terms-and-Conditions.aspx> and, for electronic format documents, subject to Terms and Conditions for Electronic Documents at <http://www.sgs.com/en/Terms-and-Conditions/Terms-e-Documents.aspx>. Attention is drawn to the limitation of liability, indemnification and jurisdiction issues defined therein. Any holder of this document is advised that information contained hereon reflects the Company's findings at the time of its intervention only and within the limits of Client's instructions, if any. The Company's sole responsibility is to its Client and this document does not exonerate parties to a transaction from exercising all their rights and obligations under the transaction documents. This document cannot be reproduced except in full, without prior written approval of the Company. Any unauthorized alteration, forgery or falsification of the content or appearance of this document is unlawful and offenders may be prosecuted to the fullest extent of the law. Unless otherwise stated the results shown in this test report refer only to the sample(s) tested and such sample(s) are retained for 30 days only.

Test Mode: 06; Polarity: Vertical; Modulation:802.11ac; Bandwidth:40MHz; Channel:High

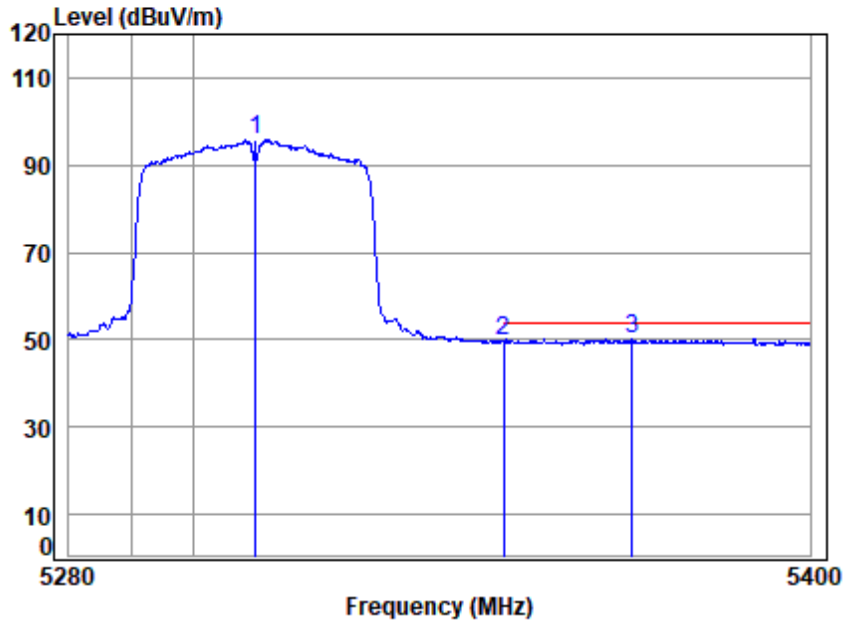

Site : chamber
 Condition: 3m VERTICAL
 Job No : 00750AT\00751AT
 Mode : 5310 Band edge
 : 5G WIFI 11AC40

	Freq	Cable Loss	Ant Factor	Preamp Factor	Read Level	Level	Limit	Over	Remark
	MHz	dB	dB/m	dB	dBuV	dBuV/m	dBuV/m	dB	
1	5310.000	7.52	34.22	35.00	89.28	96.02	-----	-----	Average
2	5350.020	7.56	34.30	35.00	43.03	49.89	54.00	-4.11	Average
3 q	5370.954	7.58	34.38	35.00	43.13	50.09	54.00	-3.91	Average



Unless otherwise agreed in writing, this document is issued by the Company subject to its General Conditions of Service printed overleaf, available on request or accessible at <http://www.sgs.com/en/Terms-and-Conditions.aspx> and, for electronic format documents, subject to Terms and Conditions for Electronic Documents at <http://www.sgs.com/en/Terms-and-Conditions/Terms-e-Documents.aspx>. Attention is drawn to the limitation of liability, indemnification and jurisdiction issues defined therein. Any holder of this document is advised that information contained hereon reflects the Company's findings at the time of its intervention only and within the limits of Client's instructions, if any. The Company's sole responsibility is to its Client and this document does not exonerate parties to a transaction from exercising all their rights and obligations under the transaction documents. This document cannot be reproduced except in full, without prior written approval of the Company. Any unauthorized alteration, forgery or falsification of the content or appearance of this document is unlawful and offenders may be prosecuted to the fullest extent of the law. Unless otherwise stated the results shown in this test report refer only to the sample(s) tested and such sample(s) are retained for 30 days only.

Test Mode: 06; Polarity: Horizontal; Modulation:802.11ac; Bandwidth:80MHz; Channel:middle

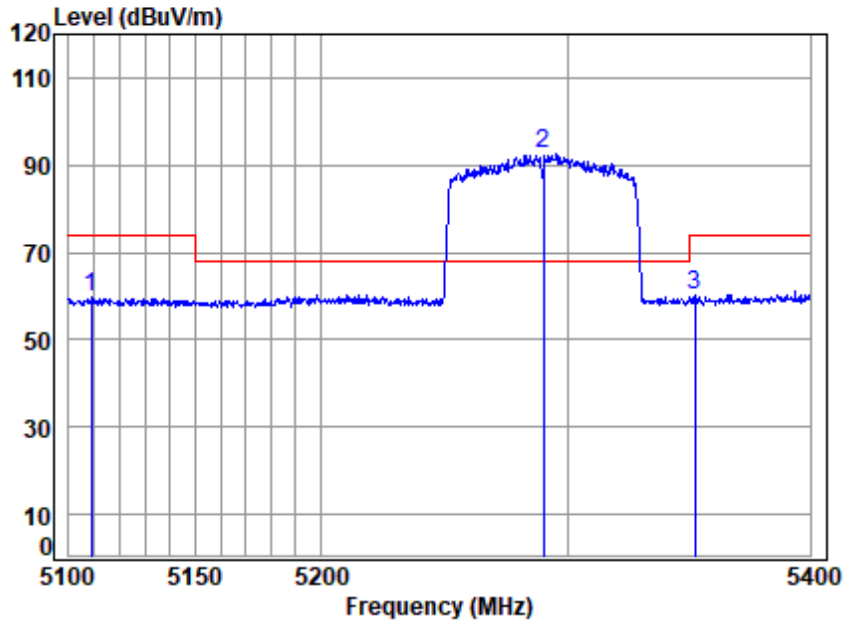

Site : chamber
 Condition: 3m HORIZONTAL
 Job No : 00750AT\00751AT
 Mode : 5290 Band edge
 : 5G WIFI 11AC80

	Freq	Cable Loss	Ant Factor	Preamp Factor	Read Level	Level	Limit	Over	Remark
	MHz	dB	dB/m	dB	dBuV	dBuV/m	dBuV/m	dB	
1	5109.045	7.32	34.08	34.99	53.52	59.93	74.00	-14.07	peak
2 q	5290.000	7.50	34.16	35.00	86.12	92.78	68.20	24.58	peak
3	5352.064	7.56	34.31	35.00	53.28	60.15	74.00	-13.85	peak



Unless otherwise agreed in writing, this document is issued by the Company subject to its General Conditions of Service printed overleaf, available on request or accessible at <http://www.sgs.com/en/Terms-and-Conditions.aspx> and, for electronic format documents, subject to Terms and Conditions for Electronic Documents at <http://www.sgs.com/en/Terms-and-Conditions/Terms-e-Documents.aspx>. Attention is drawn to the limitation of liability, indemnification and jurisdiction issues defined therein. Any holder of this document is advised that information contained hereon reflects the Company's findings at the time of its intervention only and within the limits of Client's instructions, if any. The Company's sole responsibility is to its Client and this document does not exonerate parties to a transaction from exercising all their rights and obligations under the transaction documents. This document cannot be reproduced except in full, without prior written approval of the Company. Any unauthorized alteration, forgery or falsification of the content or appearance of this document is unlawful and offenders may be prosecuted to the fullest extent of the law. Unless otherwise stated the results shown in this test report refer only to the sample(s) tested and such sample(s) are retained for 30 days only.

Test Mode: 06; Polarity: Horizontal; Modulation:802.11ac; Bandwidth:80MHz; Channel:middle

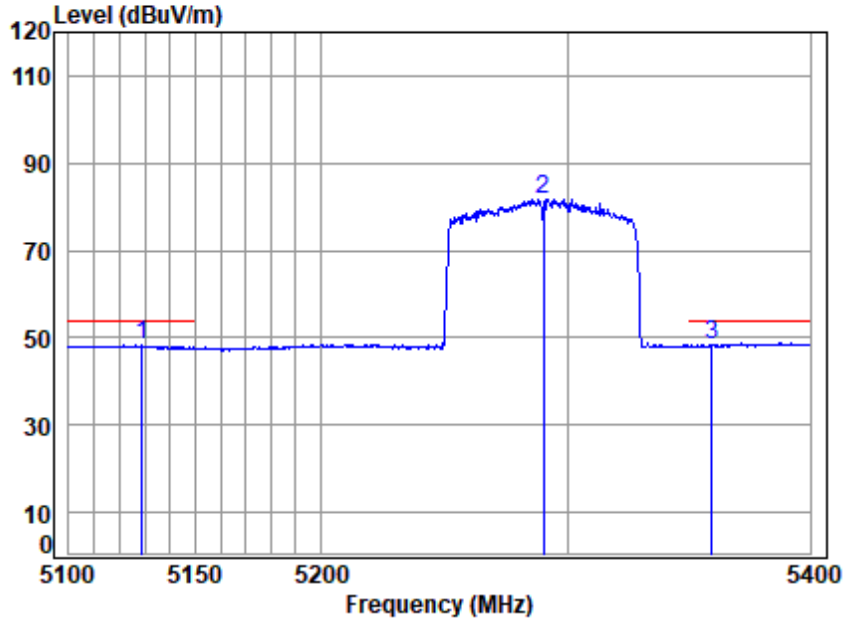

Site : chamber
 Condition: 3m HORIZONTAL
 Job No : 00750AT\00751AT
 Mode : 5290 Band edge
 : 5G WIFI 11AC80

		Cable	Ant	Preamp	Read	Limit	Over		
1	2	Loss	Factor	Factor	Level	Line	Limit	Remark	
MHz	dB	dB/m	dB	dBuV	dBuV/m	dBuV/m	dB		
1 q 5128.941	7.34	34.04	34.99	41.97	48.36	54.00	-5.64	Average	
2 5290.000	7.50	34.16	35.00	75.12	81.78	-----	-----	Average	
3 5359.104	7.57	34.34	35.00	41.42	48.33	54.00	-5.67	Average	



Unless otherwise agreed in writing, this document is issued by the Company subject to its General Conditions of Service printed overleaf, available on request or accessible at <http://www.sgs.com/en/Terms-and-Conditions.aspx> and, for electronic format documents, subject to Terms and Conditions for Electronic Documents at <http://www.sgs.com/en/Terms-and-Conditions/Terms-e-Documents.aspx>. Attention is drawn to the limitation of liability, indemnification and jurisdiction issues defined therein. Any holder of this document is advised that information contained hereon reflects the Company's findings at the time of its intervention only and within the limits of Client's instructions, if any. The Company's sole responsibility is to its Client and this document does not exonerate parties to a transaction from exercising all their rights and obligations under the transaction documents. This document cannot be reproduced except in full, without prior written approval of the Company. Any unauthorized alteration, forgery or falsification of the content or appearance of this document is unlawful and offenders may be prosecuted to the fullest extent of the law. Unless otherwise stated the results shown in this test report refer only to the sample(s) tested and such sample(s) are retained for 30 days only.

Test Mode: 06; Polarity: Vertical; Modulation:802.11ac; Bandwidth:80MHz; Channel:middle

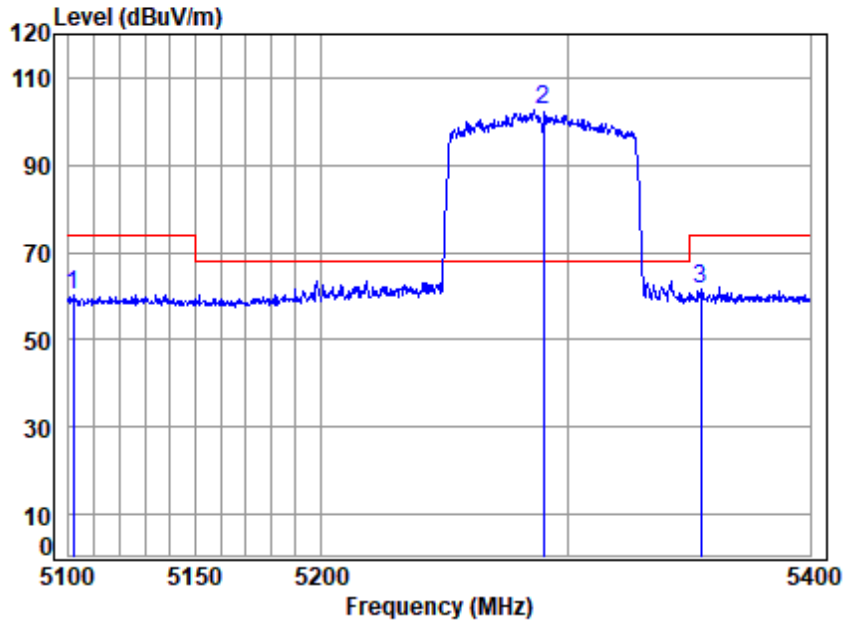

Site : chamber
 Condition: 3m VERTICAL
 Job No : 00750AT\00751AT
 Mode : 5290 Band edge
 : 5G WIFI 11AC80

		Cable	Ant	Preamp	Read	Limit	Over	
	Freq	Loss	Factor	Factor	Level	Line	Limit	Remark
	MHz	dB	dB/m	dB	dBuV	dBuV/m	dBuV/m	dB
1	5101.750	7.31	34.10	34.99	53.93	60.35	74.00	-13.65 Peak
2 q	5290.000	7.50	34.16	35.00	96.02	102.68	68.20	34.48 Peak
3	5354.818	7.57	34.32	35.00	54.92	61.81	74.00	-12.19 Peak



Unless otherwise agreed in writing, this document is issued by the Company subject to its General Conditions of Service printed overleaf, available on request or accessible at <http://www.sgs.com/en/Terms-and-Conditions.aspx> and, for electronic format documents, subject to Terms and Conditions for Electronic Documents at <http://www.sgs.com/en/Terms-and-Conditions/Terms-e-Documents.aspx>. Attention is drawn to the limitation of liability, indemnification and jurisdiction issues defined therein. Any holder of this document is advised that information contained hereon reflects the Company's findings at the time of its intervention only and within the limits of Client's instructions, if any. The Company's sole responsibility is to its Client and this document does not exonerate parties to a transaction from exercising all their rights and obligations under the transaction documents. This document cannot be reproduced except in full, without prior written approval of the Company. Any unauthorized alteration, forgery or falsification of the content or appearance of this document is unlawful and offenders may be prosecuted to the fullest extent of the law. Unless otherwise stated the results shown in this test report refer only to the sample(s) tested and such sample(s) are retained for 30 days only.
 Attention: To check the authenticity of testing /inspection report & certificate, please contact us at telephone: (86-755) 8307 1443, or email: CN.Doccheck@sgs.com

Test Mode: 06; Polarity: Vertical; Modulation:802.11ac; Bandwidth:80MHz; Channel:middle

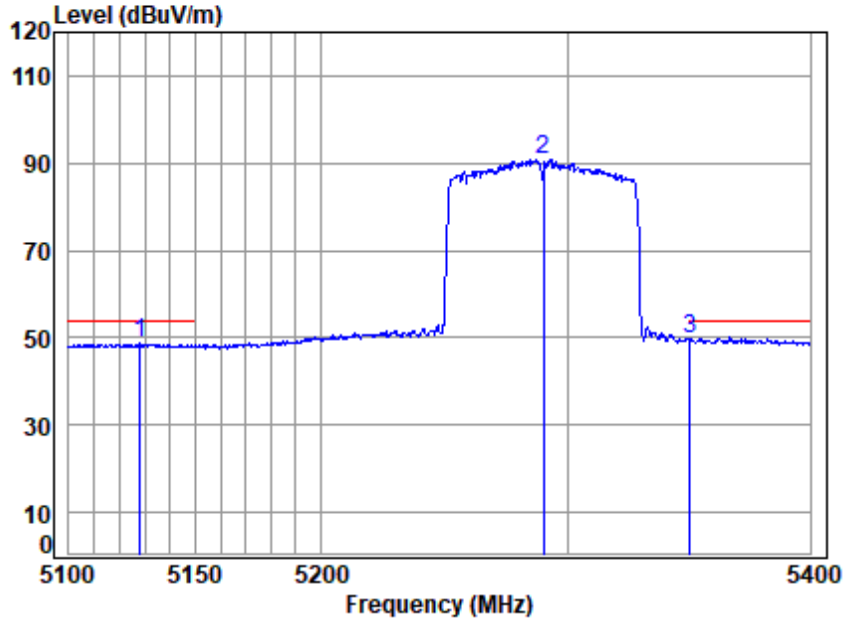

Site : chamber
 Condition: 3m VERTICAL
 Job No : 00750AT\00751AT
 Mode : 5290 Band edge
 : 5G WIFI 11AC80

		Cable	Ant	Preamp	Read	Limit	Over		
	Freq	Loss	Factor	Factor	Level	Line	Limit	Remark	
	MHz	dB	dB/m	dB	dBuV	dBuV/m	dBuV/m	dB	
1	5128.062	7.34	34.04	34.99	42.22	48.61	54.00	-5.39	Average
2	5290.000	7.50	34.16	35.00	84.08	90.74	-----	-----	Average
3 q	5350.229	7.56	34.30	35.00	42.93	49.79	54.00	-4.21	Average



Unless otherwise agreed in writing, this document is issued by the Company subject to its General Conditions of Service printed overleaf, available on request or accessible at <http://www.sgs.com/en/Terms-and-Conditions.aspx> and, for electronic format documents, subject to Terms and Conditions for Electronic Documents at <http://www.sgs.com/en/Terms-and-Conditions/Terms-e-Documents.aspx>. Attention is drawn to the limitation of liability, indemnification and jurisdiction issues defined therein. Any holder of this document is advised that information contained hereon reflects the Company's findings at the time of its intervention only and within the limits of Client's instructions, if any. The Company's sole responsibility is to its Client and this document does not exonerate parties to a transaction from exercising all their rights and obligations under the transaction documents. This document cannot be reproduced except in full, without prior written approval of the Company. Any unauthorized alteration, forgery or falsification of the content or appearance of this document is unlawful and offenders may be prosecuted to the fullest extent of the law. Unless otherwise stated the results shown in this test report refer only to the sample(s) tested and such sample(s) are retained for 30 days only.

Test Mode: 06; Polarity: Horizontal; Modulation:802.11ax; Bandwidth:20MHz; Channel:Low

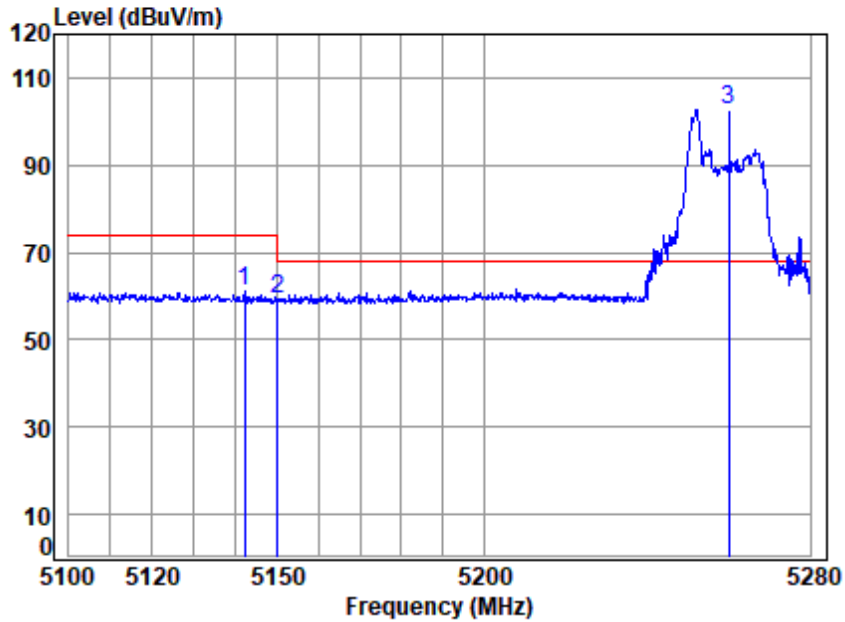

Site : chamber
 Condition: 3m HORIZONTAL
 Job No : 00750AT\00751AT
 Mode : 5260 Band edge
 : 5G WIFI 11AX20 26 RU

	Cable	Ant	Preamp	Read	Limit	Over		
Freq	Loss	Factor	Factor	Level	Level	Line	Limit	Remark
MHz	dB	dB/m	dB	dBuV	dBuV/m	dBuV/m	dB	
1	5142.097	7.36	34.02	34.99	54.58	60.97	74.00	-13.03 peak
2	5149.980	7.36	34.00	34.99	53.09	59.46	74.00	-14.54 peak
3 q	5260.000	7.47	34.04	35.00	96.20	102.71	68.20	34.51 peak



Unless otherwise agreed in writing, this document is issued by the Company subject to its General Conditions of Service printed overleaf, available on request or accessible at <http://www.sgs.com/en/Terms-and-Conditions.aspx> and, for electronic format documents, subject to Terms and Conditions for Electronic Documents at <http://www.sgs.com/en/Terms-and-Conditions/Terms-e-Documents.aspx>. Attention is drawn to the limitation of liability, indemnification and jurisdiction issues defined therein. Any holder of this document is advised that information contained hereon reflects the Company's findings at the time of its intervention only and within the limits of Client's instructions, if any. The Company's sole responsibility is to its Client and this document does not exonerate parties to a transaction from exercising all their rights and obligations under the transaction documents. This document cannot be reproduced except in full, without prior written approval of the Company. Any unauthorized alteration, forgery or falsification of the content or appearance of this document is unlawful and offenders may be prosecuted to the fullest extent of the law. Unless otherwise stated the results shown in this test report refer only to the sample(s) tested and such sample(s) are retained for 30 days only.

Test Mode: 06; Polarity: Horizontal; Modulation:802.11ax; Bandwidth:20MHz; Channel:Low

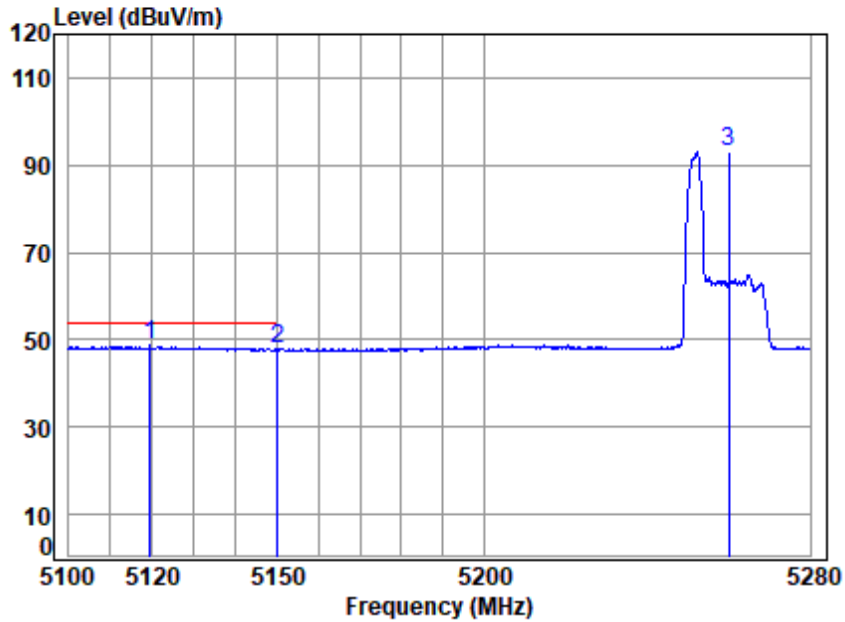

Site : chamber
 Condition: 3m HORIZONTAL
 Job No : 00750AT\00751AT
 Mode : 5260 Band edge
 : 5G WIFI 11AX20 26 RU

	Cable	Ant	Preamp	Read	Limit	Over		
Freq	Loss	Factor	Factor	Level	Level	Line	Limit	Remark
MHz	dB	dB/m	dB	dBuV	dBuV/m	dBuV/m	dB	
1 q 5119.318	7.33	34.06	34.99	42.20	48.60	54.00	-5.40	Average
2 5149.980	7.36	34.00	34.99	41.68	48.05	54.00	-5.95	Average
3 5260.000	7.47	34.04	35.00	86.57	93.08	-----	-----	Average



Unless otherwise agreed in writing, this document is issued by the Company subject to its General Conditions of Service printed overleaf, available on request or accessible at <http://www.sgs.com/en/Terms-and-Conditions.aspx> and, for electronic format documents, subject to Terms and Conditions for Electronic Documents at <http://www.sgs.com/en/Terms-and-Conditions/Terms-e-Documents.aspx>. Attention is drawn to the limitation of liability, indemnification and jurisdiction issues defined therein. Any holder of this document is advised that information contained hereon reflects the Company's findings at the time of its intervention only and within the limits of Client's instructions, if any. The Company's sole responsibility is to its Client and this document does not exonerate parties to a transaction from exercising all their rights and obligations under the transaction documents. This document cannot be reproduced except in full, without prior written approval of the Company. Any unauthorized alteration, forgery or falsification of the content or appearance of this document is unlawful and offenders may be prosecuted to the fullest extent of the law. Unless otherwise stated the results shown in this test report refer only to the sample(s) tested and such sample(s) are retained for 30 days only.

Test Mode: 06; Polarity: Vertical; Modulation:802.11ax; Bandwidth:20MHz; Channel:Low

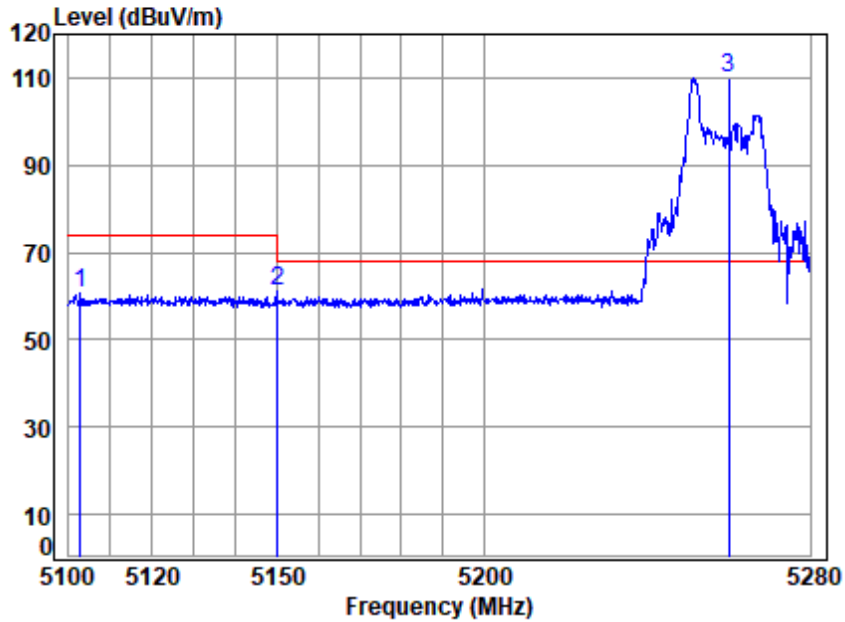

Site : chamber
 Condition: 3m VERTICAL
 Job No : 00750AT\00751AT
 Mode : 5260 Band edge
 : 5G WIFI 11AX20 26 RU

	Cable	Ant	Preamp	Read	Limit	Over	
Freq	Loss	Factor	Factor	Level	Level	Line	Limit
MHz	dB	dB/m	dB	dBuV	dBuV/m	dBuV/m	dB
1	7.32	34.09	34.99	54.37	60.79	74.00	-13.21 Peak
2	7.36	34.00	34.99	54.59	60.96	74.00	-13.04 Peak
3 q	7.47	34.04	35.00	103.39	109.90	68.20	41.70 Peak



Unless otherwise agreed in writing, this document is issued by the Company subject to its General Conditions of Service printed overleaf, available on request or accessible at <http://www.sgs.com/en/Terms-and-Conditions.aspx> and, for electronic format documents, subject to Terms and Conditions for Electronic Documents at <http://www.sgs.com/en/Terms-and-Conditions/Terms-e-Documents.aspx>. Attention is drawn to the limitation of liability, indemnification and jurisdiction issues defined therein. Any holder of this document is advised that information contained hereon reflects the Company's findings at the time of its intervention only and within the limits of Client's instructions, if any. The Company's sole responsibility is to its Client and this document does not exonerate parties to a transaction from exercising all their rights and obligations under the transaction documents. This document cannot be reproduced except in full, without prior written approval of the Company. Any unauthorized alteration, forgery or falsification of the content or appearance of this document is unlawful and offenders may be prosecuted to the fullest extent of the law. Unless otherwise stated the results shown in this test report refer only to the sample(s) tested and such sample(s) are retained for 30 days only.
 Attention: To check the authenticity of testing /inspection report & certificate, please contact us at telephone: (86-755) 8307 1443, or email: CN.Doccheck@sgs.com

Test Mode: 06; Polarity: Vertical; Modulation:802.11ax; Bandwidth:20MHz; Channel:Low

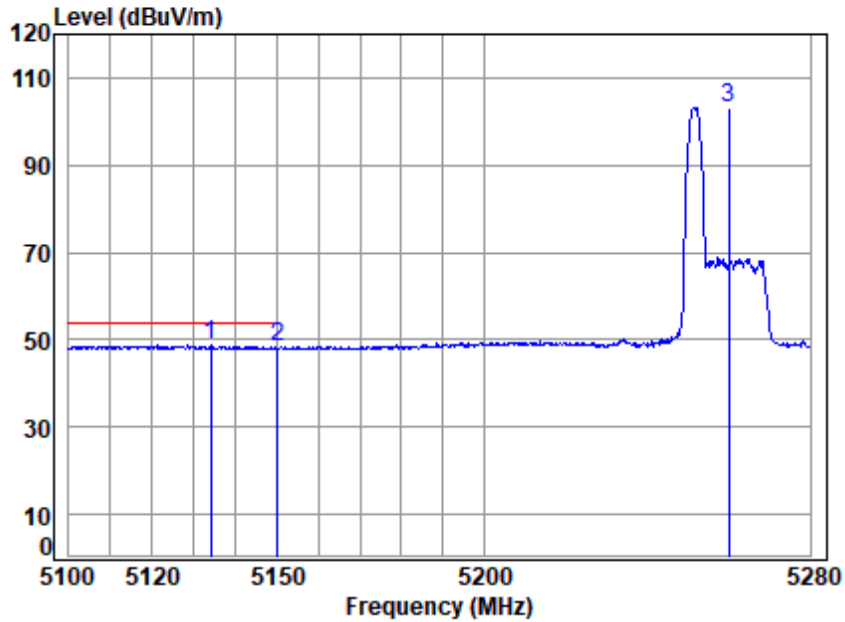

Site : chamber
 Condition: 3m VERTICAL
 Job No : 00750AT\00751AT
 Mode : 5260 Band edge
 : 5G WIFI 11AX20 26 RU

	Cable	Ant	Preamp	Read	Limit	Over		
Freq	Loss	Factor	Factor	Level	Level	Line	Limit	Remark
MHz	dB	dB/m	dB	dBuV	dBuV/m	dBuV/m	dB	
1 q 5133.899	7.35	34.03	34.99	42.32	48.71	54.00	-5.29	Average
2 5149.980	7.36	34.00	34.99	41.89	48.26	54.00	-5.74	Average
3 5260.000	7.47	34.04	35.00	96.80	103.31	-----	-----	Average



Unless otherwise agreed in writing, this document is issued by the Company subject to its General Conditions of Service printed overleaf, available on request or accessible at <http://www.sgs.com/en/Terms-and-Conditions.aspx> and, for electronic format documents, subject to Terms and Conditions for Electronic Documents at <http://www.sgs.com/en/Terms-and-Conditions/Terms-e-Documents.aspx>. Attention is drawn to the limitation of liability, indemnification and jurisdiction issues defined therein. Any holder of this document is advised that information contained hereon reflects the Company's findings at the time of its intervention only and within the limits of Client's instructions, if any. The Company's sole responsibility is to its Client and this document does not exonerate parties to a transaction from exercising all their rights and obligations under the transaction documents. This document cannot be reproduced except in full, without prior written approval of the Company. Any unauthorized alteration, forgery or falsification of the content or appearance of this document is unlawful and offenders may be prosecuted to the fullest extent of the law. Unless otherwise stated the results shown in this test report refer only to the sample(s) tested and such sample(s) are retained for 30 days only.

Test Mode: 06; Polarity: Horizontal; Modulation:802.11ax; Bandwidth:20MHz; Channel:Low

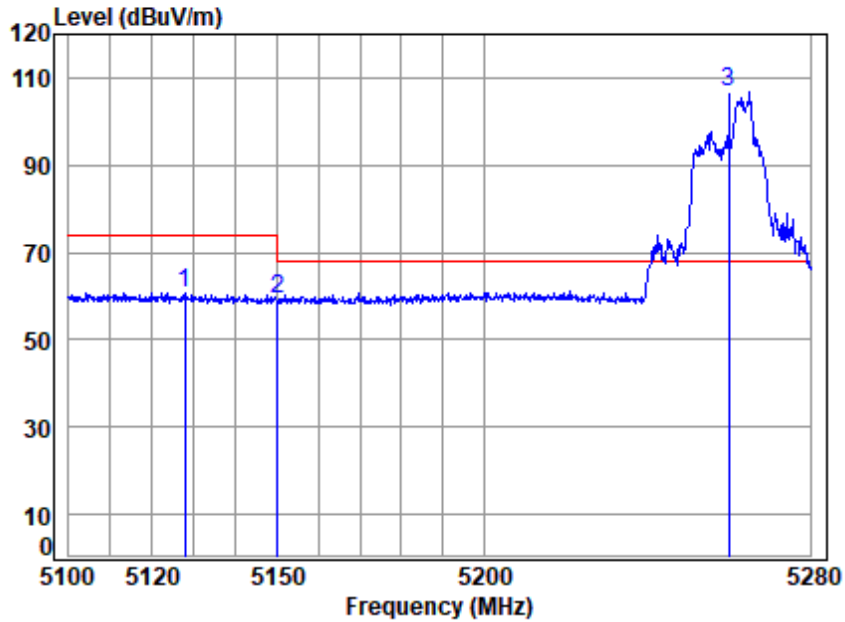

Site : chamber
 Condition: 3m HORIZONTAL
 Job No : 00750AT\00751AT
 Mode : 5260 Band edge
 : 5G WIFI 11AX20 52 RU

	Cable	Ant	Preamp	Read	Limit	Over		
Freq	Loss	Factor	Factor	Level	Level	Line	Limit	Remark
MHz	dB	dB/m	dB	dBuV	dBuV/m	dBuV/m	dB	
1	7.34	34.04	34.99	54.23	60.62	74.00	-13.38	peak
2	7.36	34.00	34.99	53.14	59.51	74.00	-14.49	peak
3 q	7.47	34.04	35.00	100.45	106.96	68.20	38.76	peak



Unless otherwise agreed in writing, this document is issued by the Company subject to its General Conditions of Service printed overleaf, available on request or accessible at <http://www.sgs.com/en/Terms-and-Conditions.aspx> and, for electronic format documents, subject to Terms and Conditions for Electronic Documents at <http://www.sgs.com/en/Terms-and-Conditions/Terms-e-Documents.aspx>. Attention is drawn to the limitation of liability, indemnification and jurisdiction issues defined therein. Any holder of this document is advised that information contained hereon reflects the Company's findings at the time of its intervention only and within the limits of Client's instructions, if any. The Company's sole responsibility is to its Client and this document does not exonerate parties to a transaction from exercising all their rights and obligations under the transaction documents. This document cannot be reproduced except in full, without prior written approval of the Company. Any unauthorized alteration, forgery or falsification of the content or appearance of this document is unlawful and offenders may be prosecuted to the fullest extent of the law. Unless otherwise stated the results shown in this test report refer only to the sample(s) tested and such sample(s) are retained for 30 days only.

Test Mode: 06; Polarity: Horizontal; Modulation:802.11ax; Bandwidth:20MHz; Channel:Low

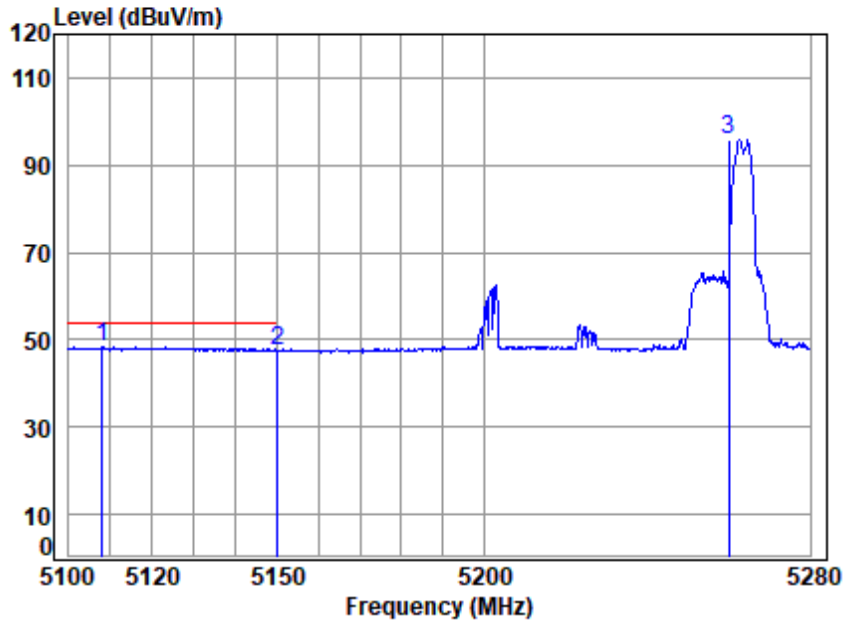

Site : chamber
 Condition: 3m HORIZONTAL
 Job No : 00750AT\00751AT
 Mode : 5260 Band edge
 : 5G WIFI 11AX20 52 RU

	Cable	Ant	Preamp	Read	Limit	Over		
Freq	Loss	Factor	Factor	Level	Level	Line	Limit	Remark
MHz	dB	dB/m	dB	dBuV	dBuV/m	dBuV/m	dB	
1 q 5107.966	7.32	34.08	34.99	42.01	48.42	54.00	-5.58	Average
2 5149.980	7.36	34.00	34.99	41.28	47.65	54.00	-6.35	Average
3 5260.000	7.47	34.04	35.00	89.30	95.81	-----	-----	Average



Unless otherwise agreed in writing, this document is issued by the Company subject to its General Conditions of Service printed overleaf, available on request or accessible at <http://www.sgs.com/en/Terms-and-Conditions.aspx> and, for electronic format documents, subject to Terms and Conditions for Electronic Documents at <http://www.sgs.com/en/Terms-and-Conditions/Terms-e-Documents.aspx>. Attention is drawn to the limitation of liability, indemnification and jurisdiction issues defined therein. Any holder of this document is advised that information contained hereon reflects the Company's findings at the time of its intervention only and within the limits of Client's instructions, if any. The Company's sole responsibility is to its Client and this document does not exonerate parties to a transaction from exercising all their rights and obligations under the transaction documents. This document cannot be reproduced except in full, without prior written approval of the Company. Any unauthorized alteration, forgery or falsification of the content or appearance of this document is unlawful and offenders may be prosecuted to the fullest extent of the law. Unless otherwise stated the results shown in this test report refer only to the sample(s) tested and such sample(s) are retained for 30 days only.
 Attention: To check the authenticity of testing /inspection report & certificate, please contact us at telephone: (86-755) 8307 1443, or email: CN.Doccheck@sgs.com

Test Mode: 06; Polarity: Vertical; Modulation:802.11ax; Bandwidth:20MHz; Channel:Low

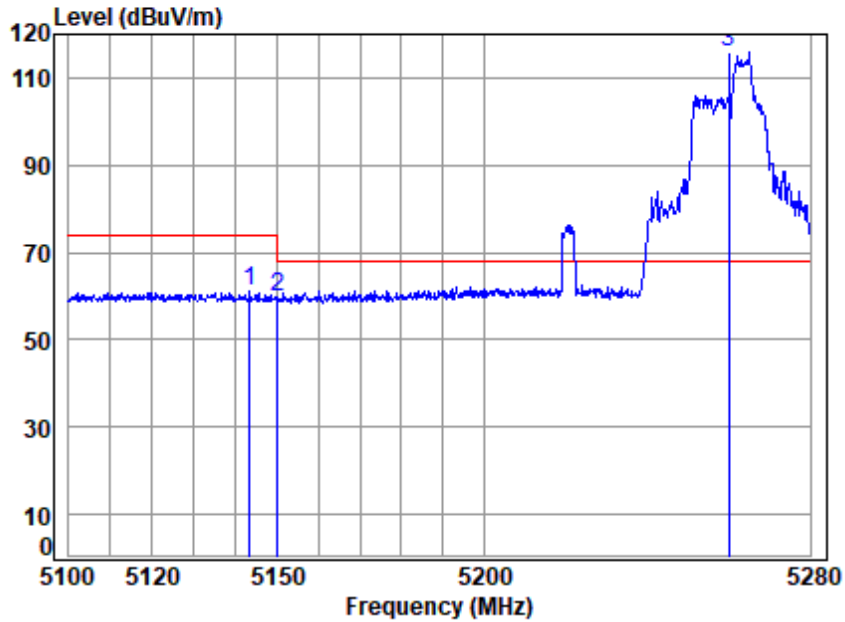

Site : chamber
 Condition: 3m VERTICAL
 Job No : 00750AT\00751AT
 Mode : 5260 Band edge
 : 5G WIFI 11AX20 52 RU

	Cable	Ant	Preamp	Read	Limit	Over		
Freq	Loss	Factor	Factor	Level	Level	Line	Limit	Remark
MHz	dB	dB/m	dB	dBuV	dBuV/m	dBuV/m	dB	
1	5143.346	7.36	34.01	34.99	54.86	61.24	74.00	-12.76 Peak
2	5149.980	7.36	34.00	34.99	53.36	59.73	74.00	-14.27 Peak
3 q	5260.000	7.47	34.04	35.00	109.28	115.79	68.20	47.59 Peak



Unless otherwise agreed in writing, this document is issued by the Company subject to its General Conditions of Service printed overleaf, available on request or accessible at <http://www.sgs.com/en/Terms-and-Conditions.aspx> and, for electronic format documents, subject to Terms and Conditions for Electronic Documents at <http://www.sgs.com/en/Terms-and-Conditions/Terms-e-Documents.aspx>. Attention is drawn to the limitation of liability, indemnification and jurisdiction issues defined therein. Any holder of this document is advised that information contained hereon reflects the Company's findings at the time of its intervention only and within the limits of Client's instructions, if any. The Company's sole responsibility is to its Client and this document does not exonerate parties to a transaction from exercising all their rights and obligations under the transaction documents. This document cannot be reproduced except in full, without prior written approval of the Company. Any unauthorized alteration, forgery or falsification of the content or appearance of this document is unlawful and offenders may be prosecuted to the fullest extent of the law. Unless otherwise stated the results shown in this test report refer only to the sample(s) tested and such sample(s) are retained for 30 days only.

Test Mode: 06; Polarity: Vertical; Modulation:802.11ax; Bandwidth:20MHz; Channel:Low

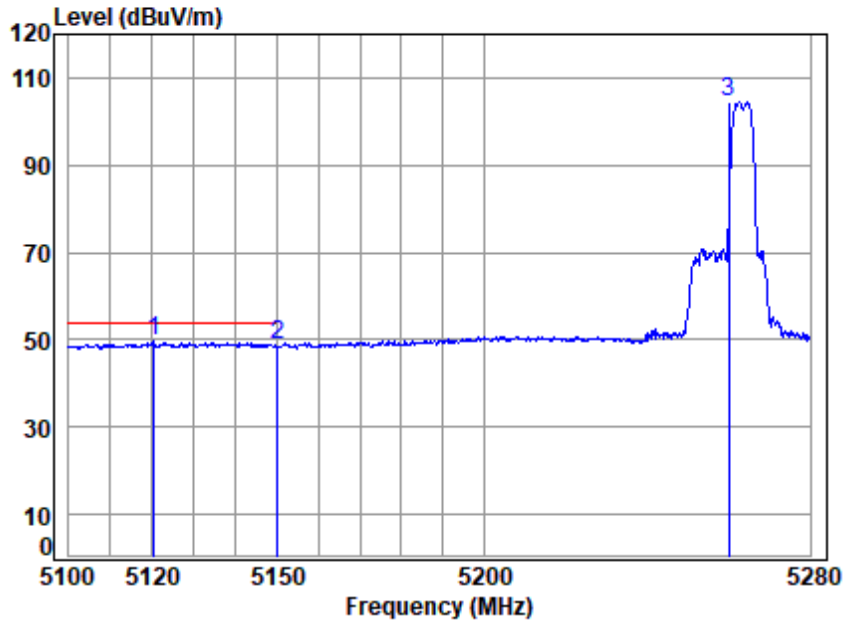

Site : chamber
 Condition: 3m VERTICAL
 Job No : 00750AT\00751AT
 Mode : 5260 Band edge
 : 5G WIFI 11AX20 52 RU

	Cable	Ant	Preamp	Read	Limit	Over		
Freq	Loss	Factor	Factor	Level	Level	Line	Limit	Remark
MHz	dB	dB/m	dB	dBuV	dBuV/m	dBuV/m	dB	
1 q 5120.384	7.33	34.06	34.99	43.15	49.55	54.00	-4.45	Average
2 5149.980	7.36	34.00	34.99	42.55	48.92	54.00	-5.08	Average
3 5260.000	7.47	34.04	35.00	97.89	104.40	-----	-----	Average



Unless otherwise agreed in writing, this document is issued by the Company subject to its General Conditions of Service printed overleaf, available on request or accessible at <http://www.sgs.com/en/Terms-and-Conditions.aspx> and, for electronic format documents, subject to Terms and Conditions for Electronic Documents at <http://www.sgs.com/en/Terms-and-Conditions/Terms-e-Documents.aspx>. Attention is drawn to the limitation of liability, indemnification and jurisdiction issues defined therein. Any holder of this document is advised that information contained hereon reflects the Company's findings at the time of its intervention only and within the limits of Client's instructions, if any. The Company's sole responsibility is to its Client and this document does not exonerate parties to a transaction from exercising all their rights and obligations under the transaction documents. This document cannot be reproduced except in full, without prior written approval of the Company. Any unauthorized alteration, forgery or falsification of the content or appearance of this document is unlawful and offenders may be prosecuted to the fullest extent of the law. Unless otherwise stated the results shown in this test report refer only to the sample(s) tested and such sample(s) are retained for 30 days only.

Test Mode: 06; Polarity: Horizontal; Modulation:802.11ax; Bandwidth:20MHz; Channel:Low

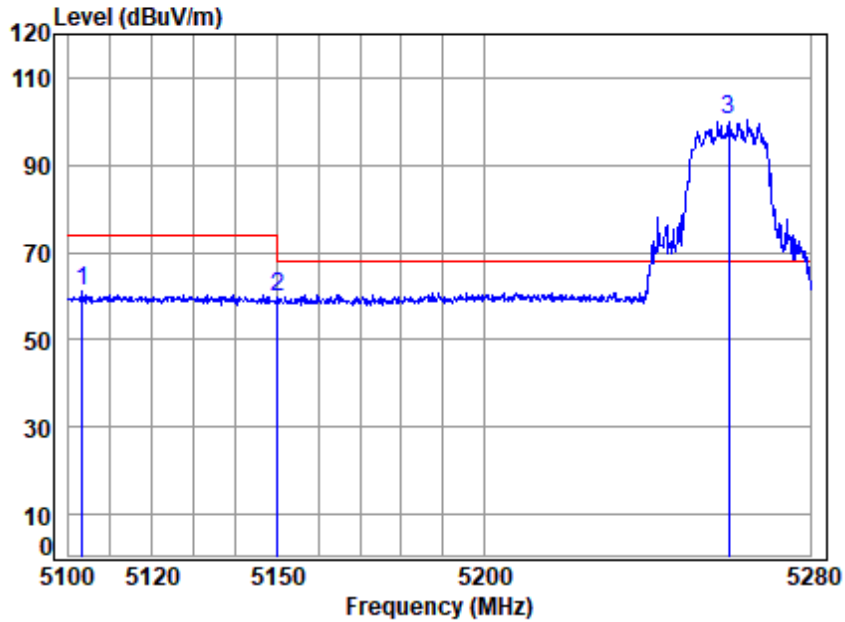

Site : chamber
 Condition: 3m HORIZONTAL
 Job No : 00750AT\00751AT
 Mode : 5260 Band edge
 : 5G WIFI 11AX20 242 RU

		Cable	Ant	Preamp	Read	Limit	Over	
	Freq	Loss	Factor	Factor	Level	Level	Line	Limit
	MHz	dB	dB/m	dB	dBuV	dBuV/m	dBuV/m	dB
1	5103.185	7.32	34.09	34.99	54.81	61.23	74.00	-12.77 peak
2	5149.980	7.36	34.00	34.99	53.36	59.73	74.00	-14.27 peak
3 q	5260.000	7.47	34.04	35.00	93.92	100.43	68.20	32.23 peak



Unless otherwise agreed in writing, this document is issued by the Company subject to its General Conditions of Service printed overleaf, available on request or accessible at <http://www.sgs.com/en/Terms-and-Conditions.aspx> and, for electronic format documents, subject to Terms and Conditions for Electronic Documents at <http://www.sgs.com/en/Terms-and-Conditions/Terms-e-Documents.aspx>. Attention is drawn to the limitation of liability, indemnification and jurisdiction issues defined therein. Any holder of this document is advised that information contained hereon reflects the Company's findings at the time of its intervention only and within the limits of Client's instructions, if any. The Company's sole responsibility is to its Client and this document does not exonerate parties to a transaction from exercising all their rights and obligations under the transaction documents. This document cannot be reproduced except in full, without prior written approval of the Company. Any unauthorized alteration, forgery or falsification of the content or appearance of this document is unlawful and offenders may be prosecuted to the fullest extent of the law. Unless otherwise stated the results shown in this test report refer only to the sample(s) tested and such sample(s) are retained for 30 days only.

Test Mode: 06; Polarity: Horizontal; Modulation:802.11ax; Bandwidth:20MHz; Channel:Low

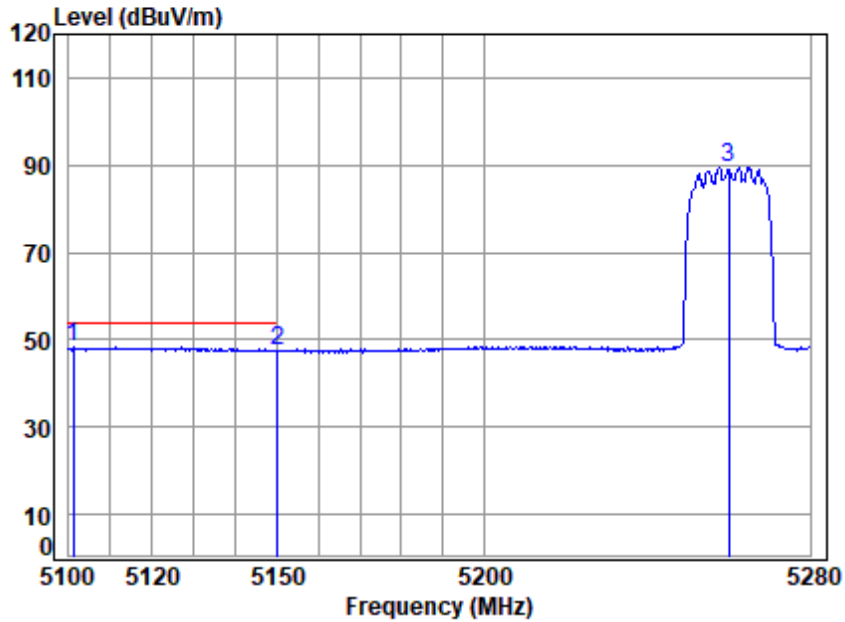

Site : chamber
 Condition: 3m HORIZONTAL
 Job No : 00750AT\00751AT
 Mode : 5260 Band edge
 : 5G WIFI 11AX20 242 RU

	Cable	Ant	Preamp	Read	Limit	Over		
Freq	Loss	Factor	Factor	Level	Level	Line	Limit	Remark
MHz	dB	dB/m	dB	dBuV	dBuV/m	dBuV/m	dB	
1 q 5101.062	7.31	34.10	34.99	41.86	48.28	54.00	-5.72	Average
2 5149.980	7.36	34.00	34.99	41.26	47.63	54.00	-6.37	Average
3 5260.000	7.47	34.04	35.00	83.03	89.54	-----	-----	Average



Unless otherwise agreed in writing, this document is issued by the Company subject to its General Conditions of Service printed overleaf, available on request or accessible at <http://www.sgs.com/en/Terms-and-Conditions.aspx> and, for electronic format documents, subject to Terms and Conditions for Electronic Documents at <http://www.sgs.com/en/Terms-and-Conditions/Terms-e-Documents.aspx>. Attention is drawn to the limitation of liability, indemnification and jurisdiction issues defined therein. Any holder of this document is advised that information contained hereon reflects the Company's findings at the time of its intervention only and within the limits of Client's instructions, if any. The Company's sole responsibility is to its Client and this document does not exonerate parties to a transaction from exercising all their rights and obligations under the transaction documents. This document cannot be reproduced except in full, without prior written approval of the Company. Any unauthorized alteration, forgery or falsification of the content or appearance of this document is unlawful and offenders may be prosecuted to the fullest extent of the law. Unless otherwise stated the results shown in this test report refer only to the sample(s) tested and such sample(s) are retained for 30 days only.

Test Mode: 06; Polarity: Vertical; Modulation:802.11ax; Bandwidth:20MHz; Channel:Low

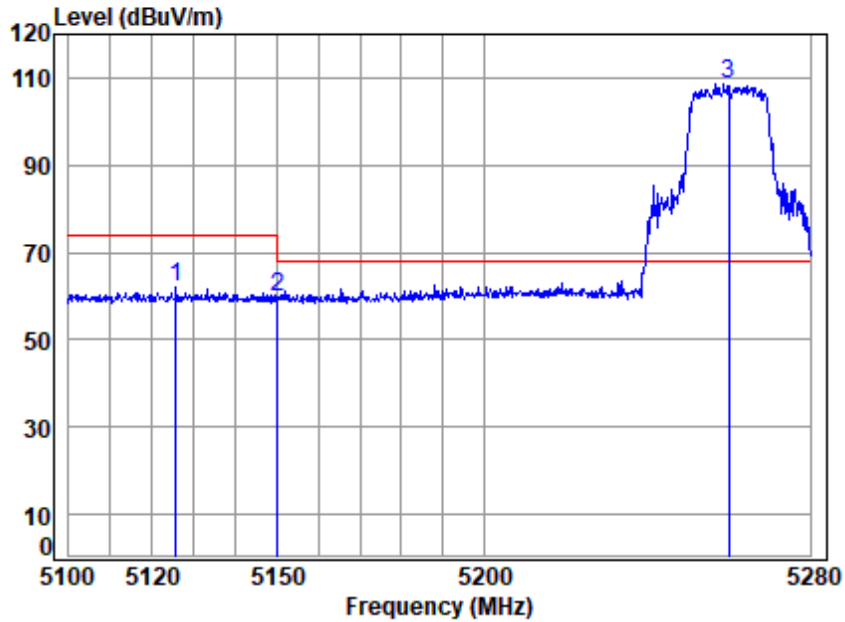

Site : chamber
 Condition: 3m VERTICAL
 Job No : 00750AT\00751AT
 Mode : 5260 Band edge
 : 5G WIFI 11AX20 242 RU

		Cable	Ant	Preamp	Read	Limit	Over	
Freq	Loss	Factor	Factor	Factor	Level	Level	Line	Limit
	dB	dB/m	dB	dB	dBuV	dBuV/m	dBuV/m	dB
	MHz	dB	dB/m	dB	dBuV	dBuV/m	dBuV/m	dB
1	5125.714	7.34	34.05	34.99	55.46	61.86	74.00	-12.14 Peak
2	5149.980	7.36	34.00	34.99	53.45	59.82	74.00	-14.18 Peak
3 q	5260.000	7.47	34.04	35.00	102.04	108.55	68.20	40.35 Peak



Unless otherwise agreed in writing, this document is issued by the Company subject to its General Conditions of Service printed overleaf, available on request or accessible at <http://www.sgs.com/en/Terms-and-Conditions.aspx> and, for electronic format documents, subject to Terms and Conditions for Electronic Documents at <http://www.sgs.com/en/Terms-and-Conditions/Terms-e-Documents.aspx>. Attention is drawn to the limitation of liability, indemnification and jurisdiction issues defined therein. Any holder of this document is advised that information contained hereon reflects the Company's findings at the time of its intervention only and within the limits of Client's instructions, if any. The Company's sole responsibility is to its Client and this document does not exonerate parties to a transaction from exercising all their rights and obligations under the transaction documents. This document cannot be reproduced except in full, without prior written approval of the Company. Any unauthorized alteration, forgery or falsification of the content or appearance of this document is unlawful and offenders may be prosecuted to the fullest extent of the law. Unless otherwise stated the results shown in this test report refer only to the sample(s) tested and such sample(s) are retained for 30 days only.

Test Mode: 06; Polarity: Vertical; Modulation:802.11ax; Bandwidth:20MHz; Channel:Low

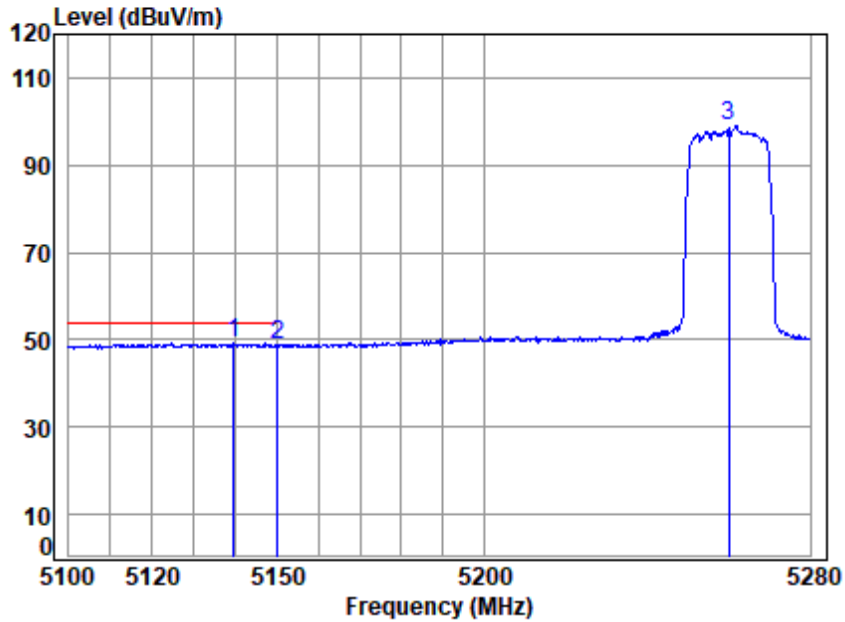

Site : chamber
 Condition: 3m VERTICAL
 Job No : 00750AT\00751AT
 Mode : 5260 Band edge
 : 5G WIFI 11AX20 242 RU

		Cable	Ant	Preamp	Read	Limit	Over		
Freq	Loss	Factor	Factor	Factor	Level	Level	Line	Limit	Remark
MHz	dB	dB/m	dB/m	dB	dBuV	dBuV/m	dBuV/m	dB	
1 q 5139.601	7.35	34.02	34.99	42.79	49.17	54.00	-4.83	Average	
2 5149.980	7.36	34.00	34.99	42.50	48.87	54.00	-5.13	Average	
3 5260.000	7.47	34.04	35.00	92.48	98.99	-----	-----	Average	



Unless otherwise agreed in writing, this document is issued by the Company subject to its General Conditions of Service printed overleaf, available on request or accessible at <http://www.sgs.com/en/Terms-and-Conditions.aspx> and, for electronic format documents, subject to Terms and Conditions for Electronic Documents at <http://www.sgs.com/en/Terms-and-Conditions/Terms-e-Documents.aspx>. Attention is drawn to the limitation of liability, indemnification and jurisdiction issues defined therein. Any holder of this document is advised that information contained hereon reflects the Company's findings at the time of its intervention only and within the limits of Client's instructions, if any. The Company's sole responsibility is to its Client and this document does not exonerate parties to a transaction from exercising all their rights and obligations under the transaction documents. This document cannot be reproduced except in full, without prior written approval of the Company. Any unauthorized alteration, forgery or falsification of the content or appearance of this document is unlawful and offenders may be prosecuted to the fullest extent of the law. Unless otherwise stated the results shown in this test report refer only to the sample(s) tested and such sample(s) are retained for 30 days only.

Test Mode: 06; Polarity: Horizontal; Modulation:802.11ax; Bandwidth:20MHz; Channel:High

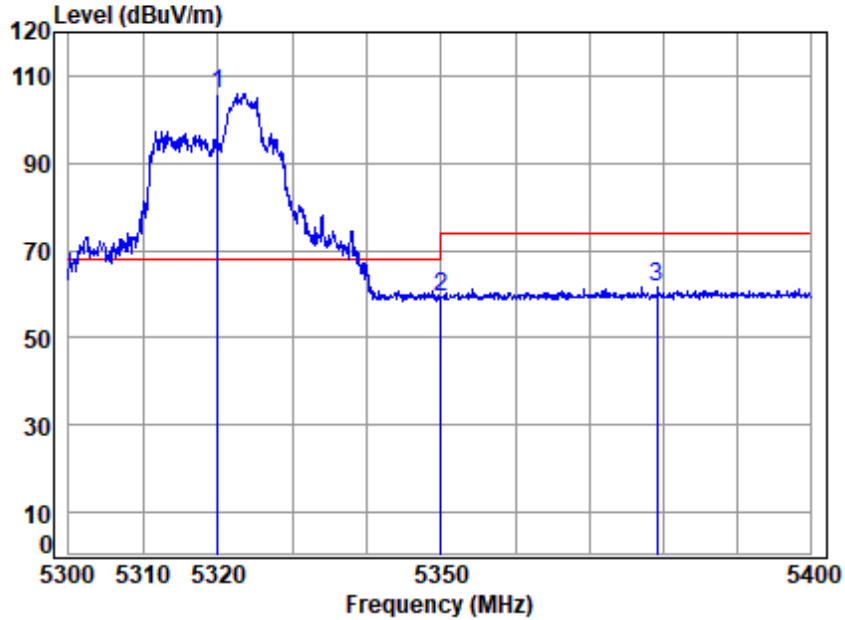

Site : chamber
 Condition: 3m HORIZONTAL
 Job No : 00750AT\00751AT
 Mode : 5320 Band edge
 : 5G WIFI 11AX20 52 RU

	Cable	Ant	Preamp	Read	Limit	Over		
Freq	Loss	Factor	Factor	Level	Level	Line	Limit	Remark
MHz	dB	dB/m	dB	dBuV	dBuV/m	dBuV/m	dB	
1 q 5320.000	7.53	34.24	35.00	99.23	106.00	68.20	37.80	peak
2 5350.020	7.56	34.30	35.00	52.68	59.54	74.00	-14.46	peak
3 5379.247	7.59	34.42	35.00	54.60	61.61	74.00	-12.39	peak



Unless otherwise agreed in writing, this document is issued by the Company subject to its General Conditions of Service printed overleaf, available on request or accessible at <http://www.sgs.com/en/Terms-and-Conditions.aspx> and, for electronic format documents, subject to Terms and Conditions for Electronic Documents at <http://www.sgs.com/en/Terms-and-Conditions/Terms-e-Documents.aspx>. Attention is drawn to the limitation of liability, indemnification and jurisdiction issues defined therein. Any holder of this document is advised that information contained hereon reflects the Company's findings at the time of its intervention only and within the limits of Client's instructions, if any. The Company's sole responsibility is to its Client and this document does not exonerate parties to a transaction from exercising all their rights and obligations under the transaction documents. This document cannot be reproduced except in full, without prior written approval of the Company. Any unauthorized alteration, forgery or falsification of the content or appearance of this document is unlawful and offenders may be prosecuted to the fullest extent of the law. Unless otherwise stated the results shown in this test report refer only to the sample(s) tested and such sample(s) are retained for 30 days only.

Test Mode: 06; Polarity: Horizontal; Modulation:802.11ax; Bandwidth:20MHz; Channel:High

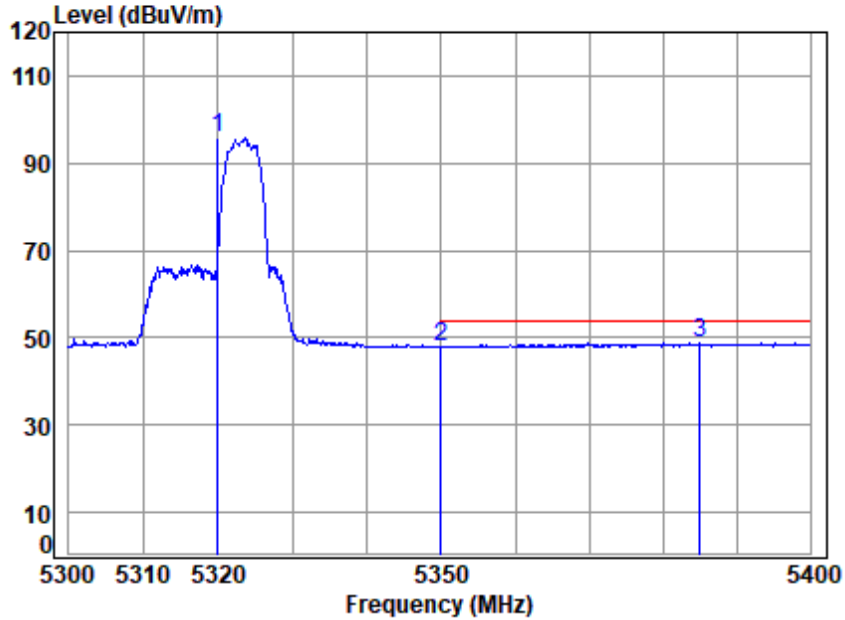

Site : chamber
 Condition: 3m HORIZONTAL
 Job No : 00750AT\00751AT
 Mode : 5320 Band edge
 : 5G WIFI 11AX20 52 RU

	Cable	Ant	Preamp	Read	Limit	Over		
Freq	Loss	Factor	Factor	Level	Level	Line	Limit	Remark
MHz	dB	dB/m	dB	dBuV	dBuV/m	dBuV/m	dB	
1	5320.000	7.53	34.24	35.00	88.93	95.70	-----	----- Average
2	5350.020	7.56	34.30	35.00	41.12	47.98	54.00	-6.02 Average
3 q	5385.082	7.60	34.44	35.00	41.73	48.77	54.00	-5.23 Average



Unless otherwise agreed in writing, this document is issued by the Company subject to its General Conditions of Service printed overleaf, available on request or accessible at <http://www.sgs.com/en/Terms-and-Conditions.aspx> and, for electronic format documents, subject to Terms and Conditions for Electronic Documents at <http://www.sgs.com/en/Terms-and-Conditions/Terms-e-Documents.aspx>. Attention is drawn to the limitation of liability, indemnification and jurisdiction issues defined therein. Any holder of this document is advised that information contained hereon reflects the Company's findings at the time of its intervention only and within the limits of Client's instructions, if any. The Company's sole responsibility is to its Client and this document does not exonerate parties to a transaction from exercising all their rights and obligations under the transaction documents. This document cannot be reproduced except in full, without prior written approval of the Company. Any unauthorized alteration, forgery or falsification of the content or appearance of this document is unlawful and offenders may be prosecuted to the fullest extent of the law. Unless otherwise stated the results shown in this test report refer only to the sample(s) tested and such sample(s) are retained for 30 days only.

Test Mode: 06; Polarity: Vertical; Modulation:802.11ax; Bandwidth:20MHz; Channel:High

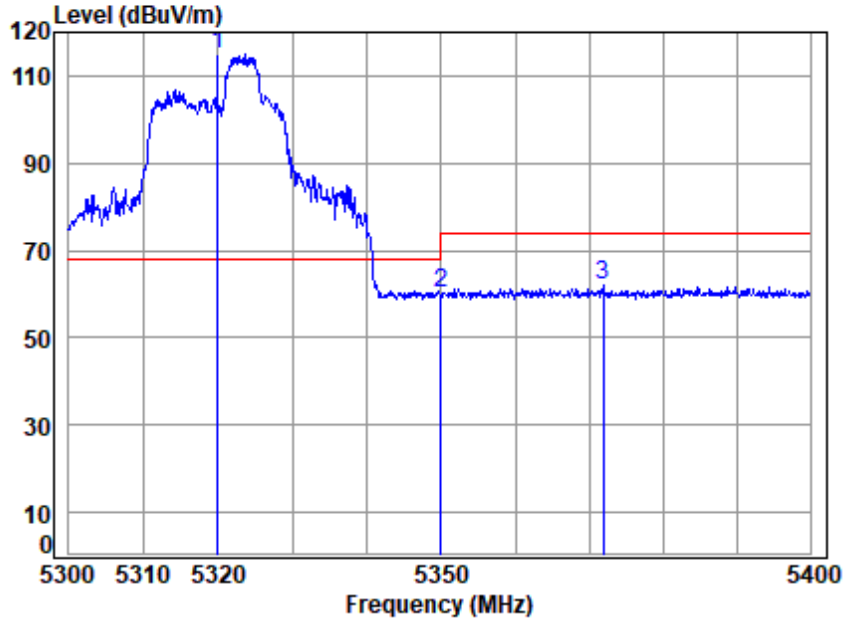

Site : chamber
 Condition: 3m VERTICAL
 Job No : 00750AT\00751AT
 Mode : 5320 Band edge
 : 5G WIFI 11AX20 52 RU

	Cable	Ant	Preamp	Read	Limit	Over		
Freq	Loss	Factor	Factor	Level	Level	Line	Limit	Remark
MHz	dB	dB/m	dB	dBuV	dBuV/m	dBuV/m	dB	
1 q 5320.000	7.53	34.24	35.00	108.16	114.93	68.20	46.73	Peak
2 5350.020	7.56	34.30	35.00	53.50	60.36	74.00	-13.64	Peak
3 5371.912	7.58	34.39	35.00	55.07	62.04	74.00	-11.96	Peak



Unless otherwise agreed in writing, this document is issued by the Company subject to its General Conditions of Service printed overleaf, available on request or accessible at <http://www.sgs.com/en/Terms-and-Conditions.aspx> and, for electronic format documents, subject to Terms and Conditions for Electronic Documents at <http://www.sgs.com/en/Terms-and-Conditions/Terms-e-Documents.aspx>. Attention is drawn to the limitation of liability, indemnification and jurisdiction issues defined therein. Any holder of this document is advised that information contained hereon reflects the Company's findings at the time of its intervention only and within the limits of Client's instructions, if any. The Company's sole responsibility is to its Client and this document does not exonerate parties to a transaction from exercising all their rights and obligations under the transaction documents. This document cannot be reproduced except in full, without prior written approval of the Company. Any unauthorized alteration, forgery or falsification of the content or appearance of this document is unlawful and offenders may be prosecuted to the fullest extent of the law. Unless otherwise stated the results shown in this test report refer only to the sample(s) tested and such sample(s) are retained for 30 days only.

Test Mode: 06; Polarity: Vertical; Modulation:802.11ax; Bandwidth:20MHz; Channel:High

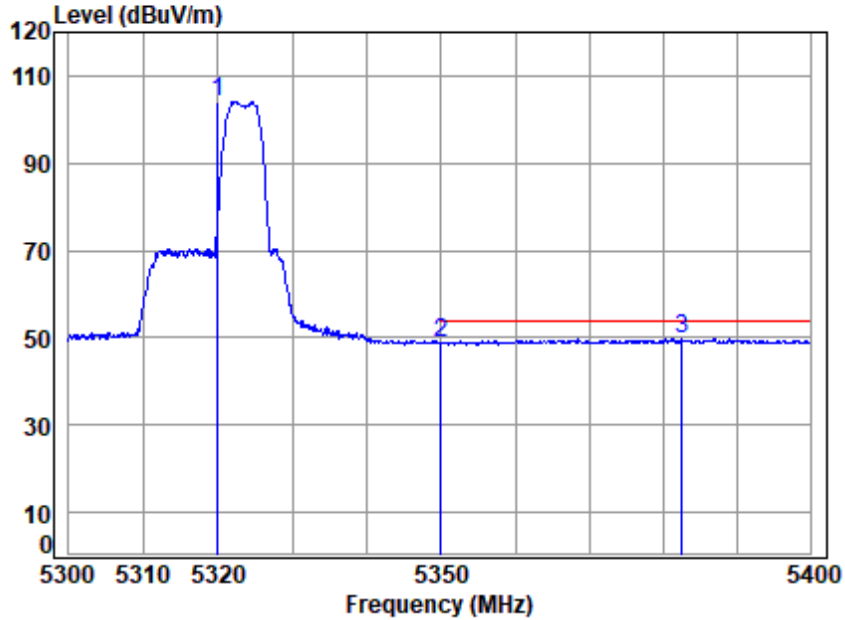

Site : chamber
 Condition: 3m VERTICAL
 Job No : 00750AT\00751AT
 Mode : 5320 Band edge
 : 5G WIFI 11AX20 52 RU

	Cable	Ant	Preamp	Read	Limit	Over			
Freq	Loss	Factor	Factor	Level	Level	Line	Limit	Remark	
MHz	dB	dB/m	dB	dBuV	dBuV/m	dBuV/m	dB		
1	5320.000	7.53	34.24	35.00	97.34	104.11	-----	-----	Average
2	5350.020	7.56	34.30	35.00	41.93	48.79	54.00	-5.21	Average
3 q	5382.566	7.59	34.43	35.00	42.67	49.69	54.00	-4.31	Average



Unless otherwise agreed in writing, this document is issued by the Company subject to its General Conditions of Service printed overleaf, available on request or accessible at <http://www.sgs.com/en/Terms-and-Conditions.aspx> and, for electronic format documents, subject to Terms and Conditions for Electronic Documents at <http://www.sgs.com/en/Terms-and-Conditions/Terms-e-Documents.aspx>. Attention is drawn to the limitation of liability, indemnification and jurisdiction issues defined therein. Any holder of this document is advised that information contained hereon reflects the Company's findings at the time of its intervention only and within the limits of Client's instructions, if any. The Company's sole responsibility is to its Client and this document does not exonerate parties to a transaction from exercising all their rights and obligations under the transaction documents. This document cannot be reproduced except in full, without prior written approval of the Company. Any unauthorized alteration, forgery or falsification of the content or appearance of this document is unlawful and offenders may be prosecuted to the fullest extent of the law. Unless otherwise stated the results shown in this test report refer only to the sample(s) tested and such sample(s) are retained for 30 days only.

Test Mode: 06; Polarity: Horizontal; Modulation:802.11ax; Bandwidth:20MHz; Channel:Low

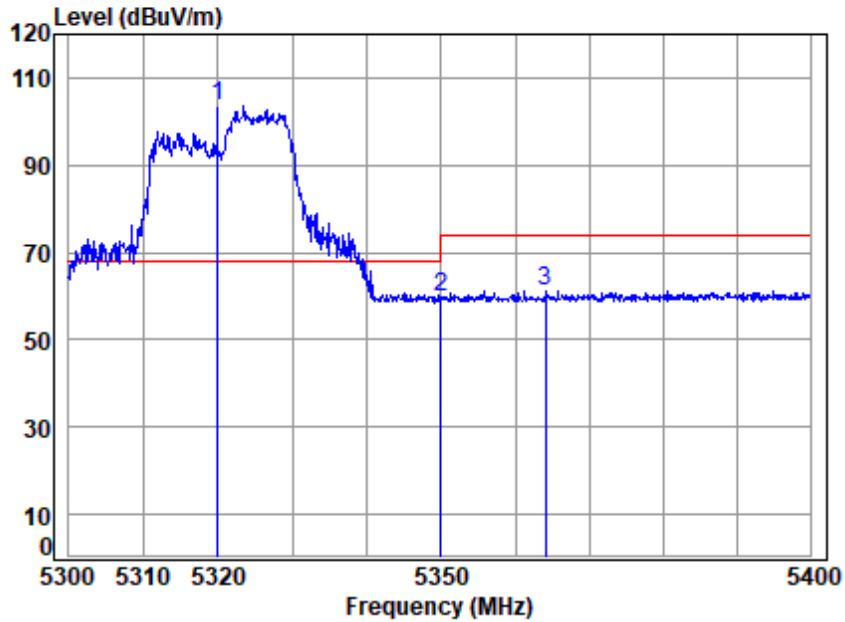

Site : chamber
 Condition: 3m HORIZONTAL
 Job No : 00750AT\00751AT
 Mode : 5320 Band edge
 : 5G WIFI 11AX20 106 RU

		Cable	Ant	Preamp	Read	Limit	Over	
Freq	Loss	Factor	Factor	Factor	Level	Level	Line	Limit
MHz	dB	dB/m	dB	dB	dBuV	dBuV/m	dBuV/m	dB
1 q 5320.000	7.53	34.24	35.00	96.83	103.60	68.20	35.40	peak
2 5350.020	7.56	34.30	35.00	52.85	59.71	74.00	-14.29	peak
3 5364.085	7.58	34.36	35.00	54.16	61.10	74.00	-12.90	peak



Unless otherwise agreed in writing, this document is issued by the Company subject to its General Conditions of Service printed overleaf, available on request or accessible at <http://www.sgs.com/en/Terms-and-Conditions.aspx> and, for electronic format documents, subject to Terms and Conditions for Electronic Documents at <http://www.sgs.com/en/Terms-and-Conditions/Terms-e-Documents.aspx>. Attention is drawn to the limitation of liability, indemnification and jurisdiction issues defined therein. Any holder of this document is advised that information contained hereon reflects the Company's findings at the time of its intervention only and within the limits of Client's instructions, if any. The Company's sole responsibility is to its Client and this document does not exonerate parties to a transaction from exercising all their rights and obligations under the transaction documents. This document cannot be reproduced except in full, without prior written approval of the Company. Any unauthorized alteration, forgery or falsification of the content or appearance of this document is unlawful and offenders may be prosecuted to the fullest extent of the law. Unless otherwise stated the results shown in this test report refer only to the sample(s) tested and such sample(s) are retained for 30 days only.

Test Mode: 06; Polarity: Horizontal; Modulation:802.11ax; Bandwidth:20MHz; Channel:Low

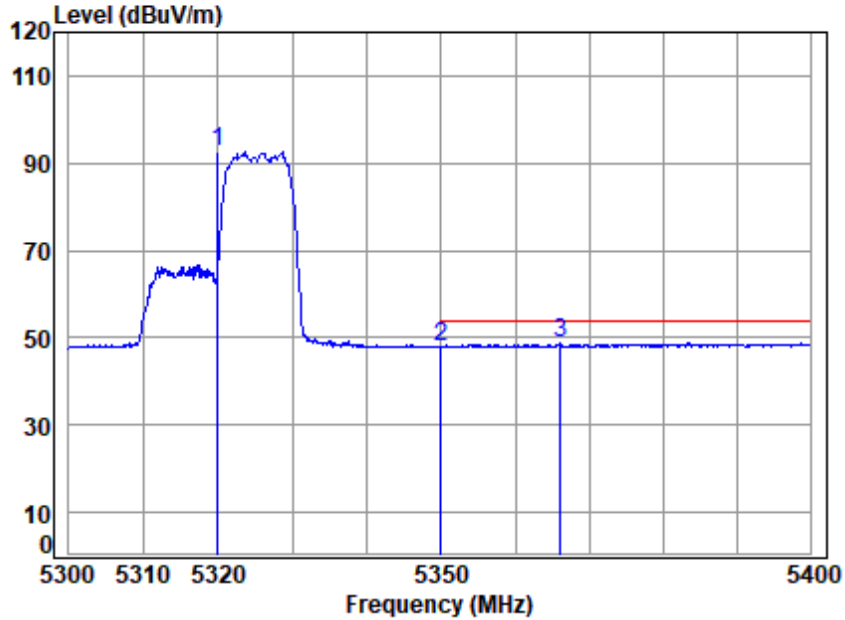

Site : chamber
 Condition: 3m HORIZONTAL
 Job No : 00750AT\00751AT
 Mode : 5320 Band edge
 : 5G WIFI 11AX20 106 RU

		Cable	Ant	Preamp	Read	Limit	Over	
	Freq	Loss	Factor	Factor	Level	Line	Limit	Remark
	MHz	dB	dB/m	dB	dBuV	dBuV/m	dBuV/m	dB
1	5320.000	7.53	34.24	35.00	85.77	92.54	-----	----- Average
2	5350.020	7.56	34.30	35.00	41.25	48.11	54.00	-5.89 Average
3 q	5366.091	7.58	34.36	35.00	41.78	48.72	54.00	-5.28 Average



Unless otherwise agreed in writing, this document is issued by the Company subject to its General Conditions of Service printed overleaf, available on request or accessible at <http://www.sgs.com/en/Terms-and-Conditions.aspx> and, for electronic format documents, subject to Terms and Conditions for Electronic Documents at <http://www.sgs.com/en/Terms-and-Conditions/Terms-e-Documents.aspx>. Attention is drawn to the limitation of liability, indemnification and jurisdiction issues defined therein. Any holder of this document is advised that information contained hereon reflects the Company's findings at the time of its intervention only and within the limits of Client's instructions, if any. The Company's sole responsibility is to its Client and this document does not exonerate parties to a transaction from exercising all their rights and obligations under the transaction documents. This document cannot be reproduced except in full, without prior written approval of the Company. Any unauthorized alteration, forgery or falsification of the content or appearance of this document is unlawful and offenders may be prosecuted to the fullest extent of the law. Unless otherwise stated the results shown in this test report refer only to the sample(s) tested and such sample(s) are retained for 30 days only.

Test Mode: 06; Polarity: Vertical; Modulation:802.11ax; Bandwidth:20MHz; Channel:Low

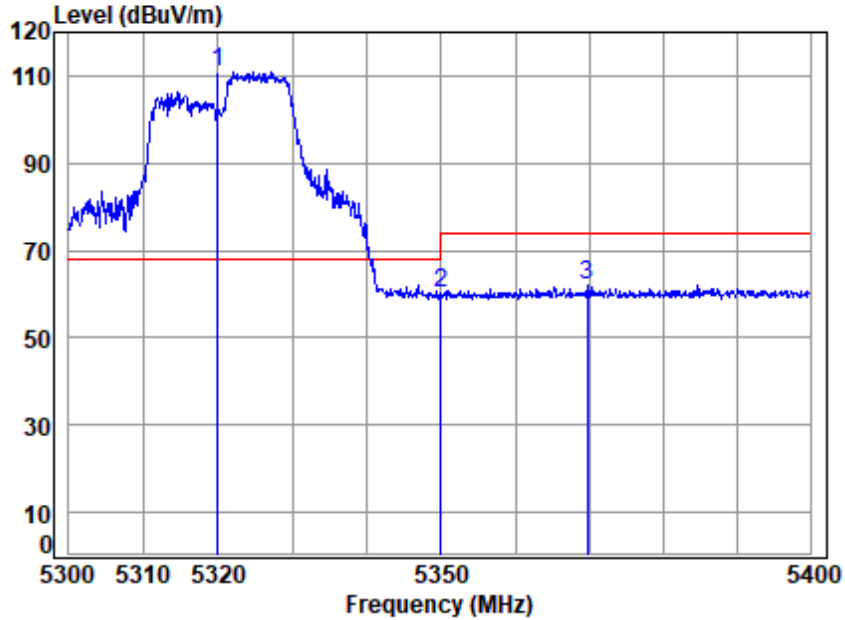

Site : chamber
 Condition: 3m VERTICAL
 Job No : 00750AT\00751AT
 Mode : 5320 Band edge
 : 5G WIFI 11AX20 106 RU

		Cable	Ant	Preamp	Read	Limit	Over	
Freq	Loss	Factor	Factor	Factor	Level	Line	Limit	Remark
MHz	dB	dB/m	dB	dB	dBuV	dBuV/m	dB	
1 q 5320.000	7.53	34.24	35.00	104.09	110.86	68.20	42.66	Peak
2 5350.020	7.56	34.30	35.00	53.21	60.07	74.00	-13.93	Peak
3 5369.703	7.58	34.38	35.00	55.25	62.21	74.00	-11.79	Peak



Unless otherwise agreed in writing, this document is issued by the Company subject to its General Conditions of Service printed overleaf, available on request or accessible at <http://www.sgs.com/en/Terms-and-Conditions.aspx> and, for electronic format documents, subject to Terms and Conditions for Electronic Documents at <http://www.sgs.com/en/Terms-and-Conditions/Terms-e-Documents.aspx>. Attention is drawn to the limitation of liability, indemnification and jurisdiction issues defined therein. Any holder of this document is advised that information contained hereon reflects the Company's findings at the time of its intervention only and within the limits of Client's instructions, if any. The Company's sole responsibility is to its Client and this document does not exonerate parties to a transaction from exercising all their rights and obligations under the transaction documents. This document cannot be reproduced except in full, without prior written approval of the Company. Any unauthorized alteration, forgery or falsification of the content or appearance of this document is unlawful and offenders may be prosecuted to the fullest extent of the law. Unless otherwise stated the results shown in this test report refer only to the sample(s) tested and such sample(s) are retained for 30 days only.

Test Mode: 06; Polarity: Vertical; Modulation:802.11ax; Bandwidth:20MHz; Channel:Low

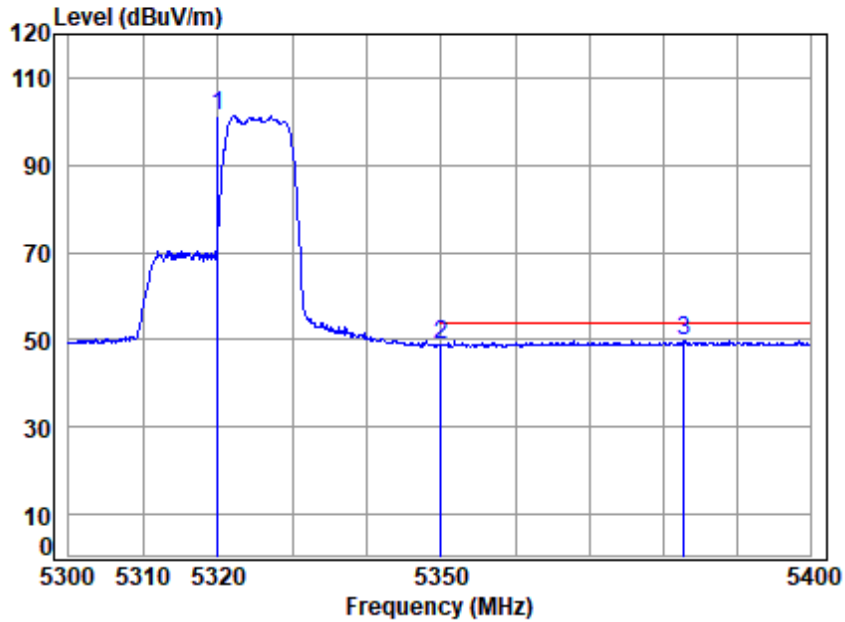

Site : chamber
 Condition: 3m VERTICAL
 Job No : 00750AT\00751AT
 Mode : 5320 Band edge
 : 5G WIFI 11AX20 106 RU

		Cable	Ant	Preamp	Read	Limit	Over	
	Freq	Loss	Factor	Factor	Level	Level	Line	Limit
	MHz	dB	dB/m	dB	dBuV	dBuV/m	dBuV/m	dB
1	5320.000	7.53	34.24	35.00	94.65	101.42	-----	-----
2	5350.020	7.56	34.30	35.00	41.93	48.79	54.00	-5.21
3 q	5382.868	7.59	34.43	35.00	42.65	49.67	54.00	-4.33



Unless otherwise agreed in writing, this document is issued by the Company subject to its General Conditions of Service printed overleaf, available on request or accessible at <http://www.sgs.com/en/Terms-and-Conditions.aspx> and, for electronic format documents, subject to Terms and Conditions for Electronic Documents at <http://www.sgs.com/en/Terms-and-Conditions/Terms-e-Documents.aspx>. Attention is drawn to the limitation of liability, indemnification and jurisdiction issues defined therein. Any holder of this document is advised that information contained hereon reflects the Company's findings at the time of its intervention only and within the limits of Client's instructions, if any. The Company's sole responsibility is to its Client and this document does not exonerate parties to a transaction from exercising all their rights and obligations under the transaction documents. This document cannot be reproduced except in full, without prior written approval of the Company. Any unauthorized alteration, forgery or falsification of the content or appearance of this document is unlawful and offenders may be prosecuted to the fullest extent of the law. Unless otherwise stated the results shown in this test report refer only to the sample(s) tested and such sample(s) are retained for 30 days only.

Test Mode: 06; Polarity: Horizontal; Modulation:802.11ax; Bandwidth:20MHz; Channel:Low

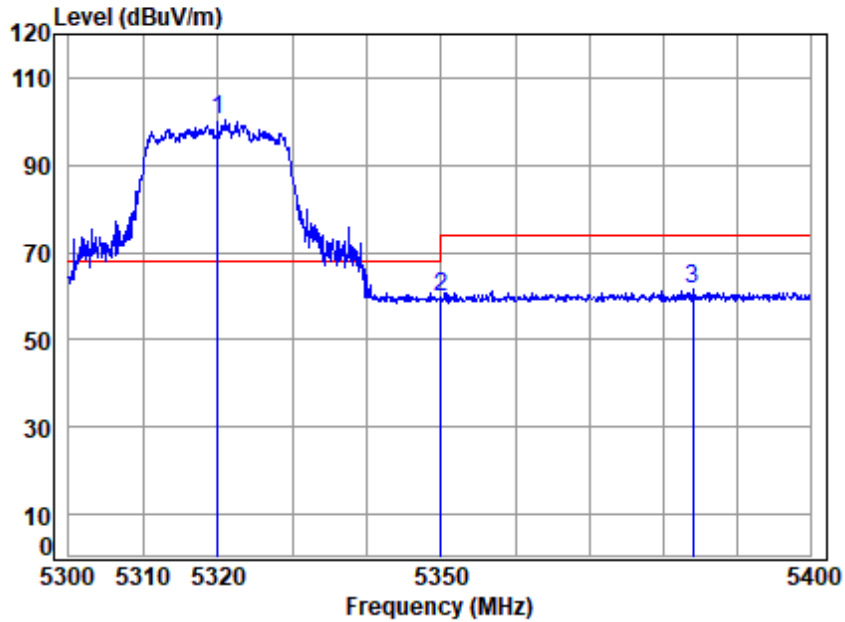

Site : chamber
 Condition: 3m HORIZONTAL
 Job No : 00750AT\00751AT
 Mode : 5320 Band edge
 : 5G WIFI 11AX20 242 RU

		Cable	Ant	Preamp	Read	Limit	Over	
Freq	Loss	Factor	Factor	Factor	Level	Level	Line	Limit
MHz	dB	dB/m	dB	dB	dBuV	dBuV/m	dBuV/m	dB
1 q 5320.000	7.53	34.24	35.00	93.70	100.47	68.20	32.27	peak
2 5350.020	7.56	34.30	35.00	52.89	59.75	74.00	-14.25	peak
3 5384.075	7.60	34.44	35.00	54.36	61.40	74.00	-12.60	peak



Unless otherwise agreed in writing, this document is issued by the Company subject to its General Conditions of Service printed overleaf, available on request or accessible at <http://www.sgs.com/en/Terms-and-Conditions.aspx> and, for electronic format documents, subject to Terms and Conditions for Electronic Documents at <http://www.sgs.com/en/Terms-and-Conditions/Terms-e-Documents.aspx>. Attention is drawn to the limitation of liability, indemnification and jurisdiction issues defined therein. Any holder of this document is advised that information contained hereon reflects the Company's findings at the time of its intervention only and within the limits of Client's instructions, if any. The Company's sole responsibility is to its Client and this document does not exonerate parties to a transaction from exercising all their rights and obligations under the transaction documents. This document cannot be reproduced except in full, without prior written approval of the Company. Any unauthorized alteration, forgery or falsification of the content or appearance of this document is unlawful and offenders may be prosecuted to the fullest extent of the law. Unless otherwise stated the results shown in this test report refer only to the sample(s) tested and such sample(s) are retained for 30 days only.

Test Mode: 06; Polarity: Horizontal; Modulation:802.11ax; Bandwidth:20MHz; Channel:Low

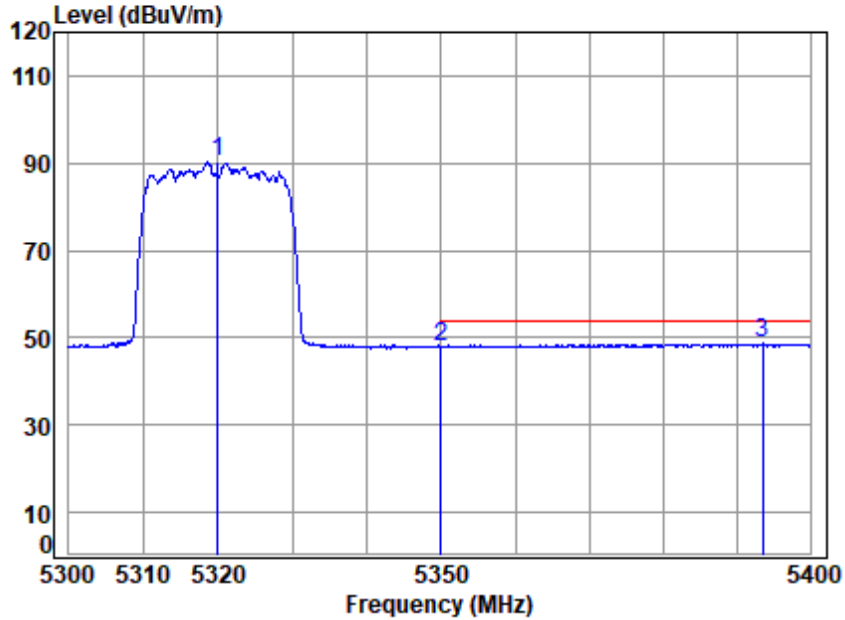

Site : chamber
 Condition: 3m HORIZONTAL
 Job No : 00750AT\00751AT
 Mode : 5320 Band edge
 : 5G WIFI 11AX20 242 RU

		Cable	Ant	Preamp	Read	Limit	Over		
	Freq	Loss	Factor	Factor	Level	Level	Line	Limit	
	MHz	dB	dB/m	dB	dBuV	dBuV/m	dBuV/m	dB	
1	5320.000	7.53	34.24	35.00	83.62	90.39	-----	-----	Average
2	5350.020	7.56	34.30	35.00	41.19	48.05	54.00	-5.95	Average
3 q	5393.544	7.60	34.47	35.00	41.65	48.72	54.00	-5.28	Average



Unless otherwise agreed in writing, this document is issued by the Company subject to its General Conditions of Service printed overleaf, available on request or accessible at <http://www.sgs.com/en/Terms-and-Conditions.aspx> and, for electronic format documents, subject to Terms and Conditions for Electronic Documents at <http://www.sgs.com/en/Terms-and-Conditions/Terms-e-Documents.aspx>. Attention is drawn to the limitation of liability, indemnification and jurisdiction issues defined therein. Any holder of this document is advised that information contained hereon reflects the Company's findings at the time of its intervention only and within the limits of Client's instructions, if any. The Company's sole responsibility is to its Client and this document does not exonerate parties to a transaction from exercising all their rights and obligations under the transaction documents. This document cannot be reproduced except in full, without prior written approval of the Company. Any unauthorized alteration, forgery or falsification of the content or appearance of this document is unlawful and offenders may be prosecuted to the fullest extent of the law. Unless otherwise stated the results shown in this test report refer only to the sample(s) tested and such sample(s) are retained for 30 days only.

Test Mode: 06; Polarity: Vertical; Modulation:802.11ax; Bandwidth:20MHz; Channel:Low

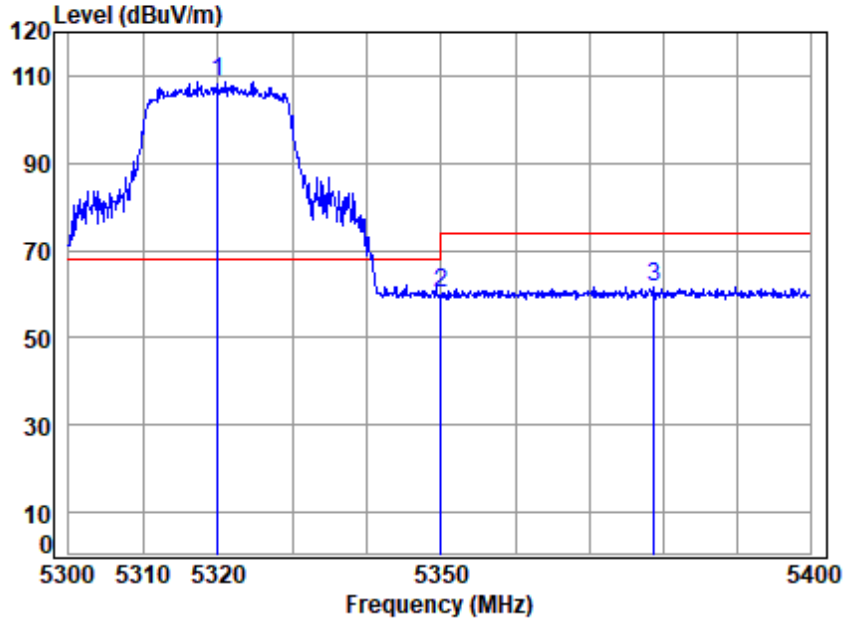

Site : chamber
 Condition: 3m VERTICAL
 Job No : 00750AT\00751AT
 Mode : 5320 Band edge
 : 5G WIFI 11AX20 242 RU

		Cable	Ant	Preamp	Read	Limit	Over		
Freq	Loss	Factor	Factor	Factor	Level	Level	Line	Limit	Remark
MHz	dB	dB/m	dB/m	dB	dBuV	dBuV/m	dBuV/m	dB	
1 q 5320.000	7.53	34.24	35.00	101.90	108.67	68.20	40.47	Peak	
2 5350.020	7.56	34.30	35.00	53.58	60.44	74.00	-13.56	Peak	
3 5378.744	7.59	34.42	35.00	54.67	61.68	74.00	-12.32	Peak	



Unless otherwise agreed in writing, this document is issued by the Company subject to its General Conditions of Service printed overleaf, available on request or accessible at <http://www.sgs.com/en/Terms-and-Conditions.aspx> and, for electronic format documents, subject to Terms and Conditions for Electronic Documents at <http://www.sgs.com/en/Terms-and-Conditions/Terms-e-Documents.aspx>. Attention is drawn to the limitation of liability, indemnification and jurisdiction issues defined therein. Any holder of this document is advised that information contained hereon reflects the Company's findings at the time of its intervention only and within the limits of Client's instructions, if any. The Company's sole responsibility is to its Client and this document does not exonerate parties to a transaction from exercising all their rights and obligations under the transaction documents. This document cannot be reproduced except in full, without prior written approval of the Company. Any unauthorized alteration, forgery or falsification of the content or appearance of this document is unlawful and offenders may be prosecuted to the fullest extent of the law. Unless otherwise stated the results shown in this test report refer only to the sample(s) tested and such sample(s) are retained for 30 days only.

Test Mode: 06; Polarity: Vertical; Modulation:802.11ax; Bandwidth:20MHz; Channel:Low

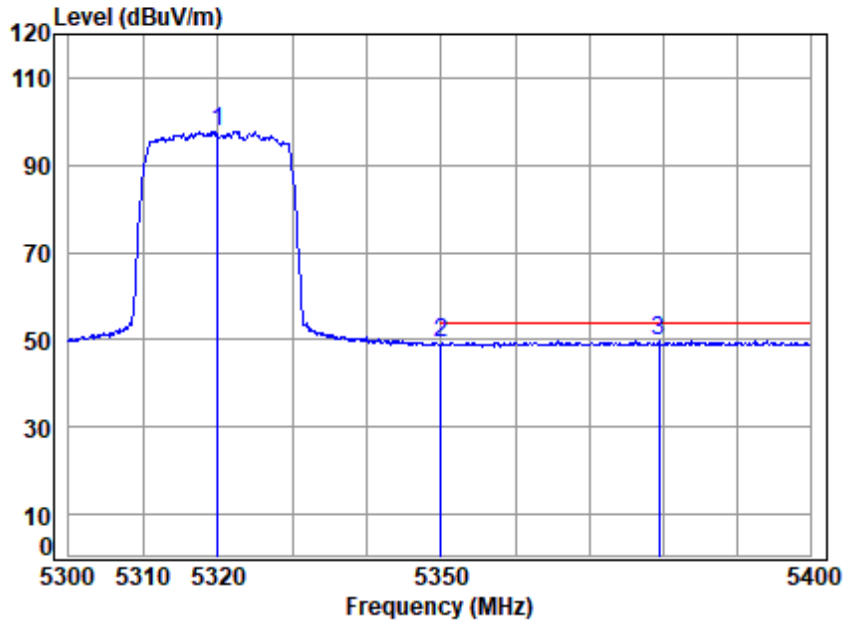

Site : chamber
 Condition: 3m VERTICAL
 Job No : 00750AT\00751AT
 Mode : 5320 Band edge
 : 5G WIFI 11AX20 242 RU

		Cable	Ant	Preamp	Read	Limit	Over	
	Freq	Loss	Factor	Factor	Level	Level	Line	Limit
	MHz	dB	dB/m	dB	dBuV	dBuV/m	dBuV/m	dB
1	5320.000	7.53	34.24	35.00	91.04	97.81	-----	-----
2	5350.020	7.56	34.30	35.00	42.22	49.08	54.00	-4.92
3 q	5379.448	7.59	34.42	35.00	42.61	49.62	54.00	-4.38



Unless otherwise agreed in writing, this document is issued by the Company subject to its General Conditions of Service printed overleaf, available on request or accessible at <http://www.sgs.com/en/Terms-and-Conditions.aspx> and, for electronic format documents, subject to Terms and Conditions for Electronic Documents at <http://www.sgs.com/en/Terms-and-Conditions/Terms-e-Documents.aspx>. Attention is drawn to the limitation of liability, indemnification and jurisdiction issues defined therein. Any holder of this document is advised that information contained hereon reflects the Company's findings at the time of its intervention only and within the limits of Client's instructions, if any. The Company's sole responsibility is to its Client and this document does not exonerate parties to a transaction from exercising all their rights and obligations under the transaction documents. This document cannot be reproduced except in full, without prior written approval of the Company. Any unauthorized alteration, forgery or falsification of the content or appearance of this document is unlawful and offenders may be prosecuted to the fullest extent of the law. Unless otherwise stated the results shown in this test report refer only to the sample(s) tested and such sample(s) are retained for 30 days only.

Test Mode: 06; Polarity: Horizontal; Modulation:802.11ax; Bandwidth:40MHz; Channel:Low

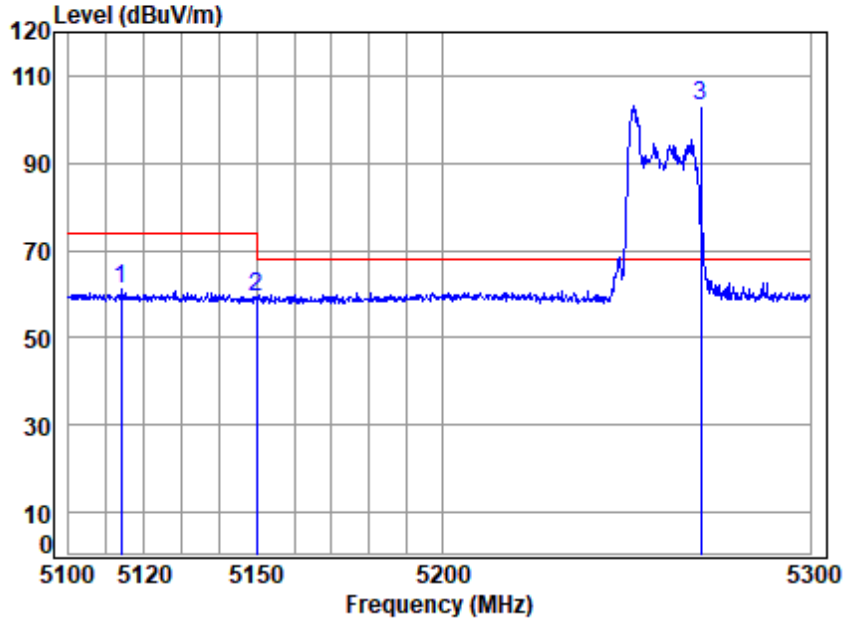

Site : chamber
 Condition: 3m HORIZONTAL
 Job No : 00750AT\00751AT
 Mode : 5270 Band edge
 : 5G WIFI 11AX40 26 RU

	Cable	Ant	Preamp	Read	Limit	Over		
Freq	Loss	Factor	Factor	Level	Level	Line	Limit	Remark
MHz	dB	dB/m	dB	dBuV	dBuV/m	dBuV/m	dB	
1	7.33	34.07	34.99	54.50	60.91	74.00	-13.09	peak
2	7.36	34.00	34.99	52.80	59.17	74.00	-14.83	peak
3 q	7.48	34.08	35.00	96.60	103.16	68.20	34.96	peak



Unless otherwise agreed in writing, this document is issued by the Company subject to its General Conditions of Service printed overleaf, available on request or accessible at <http://www.sgs.com/en/Terms-and-Conditions.aspx> and, for electronic format documents, subject to Terms and Conditions for Electronic Documents at <http://www.sgs.com/en/Terms-and-Conditions/Terms-e-Documents.aspx>. Attention is drawn to the limitation of liability, indemnification and jurisdiction issues defined therein. Any holder of this document is advised that information contained hereon reflects the Company's findings at the time of its intervention only and within the limits of Client's instructions, if any. The Company's sole responsibility is to its Client and this document does not exonerate parties to a transaction from exercising all their rights and obligations under the transaction documents. This document cannot be reproduced except in full, without prior written approval of the Company. Any unauthorized alteration, forgery or falsification of the content or appearance of this document is unlawful and offenders may be prosecuted to the fullest extent of the law. Unless otherwise stated the results shown in this test report refer only to the sample(s) tested and such sample(s) are retained for 30 days only.

Test Mode: 06; Polarity: Horizontal; Modulation:802.11ax; Bandwidth:40MHz; Channel:Low

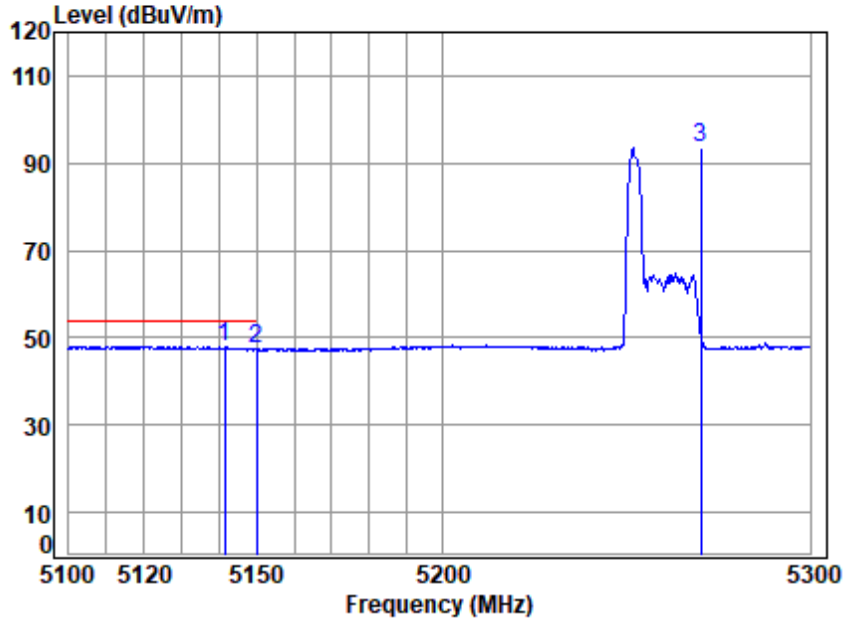

Site : chamber
 Condition: 3m HORIZONTAL
 Job No : 00750AT\00751AT
 Mode : 5270 Band edge
 : 5G WIFI 11AX40 26 RU

	Cable	Ant	Preamp	Read	Limit	Over		
Freq	Loss	Factor	Factor	Level	Level	Line	Limit	Remark
MHz	dB	dB/m	dB	dBuV	dBuV/m	dBuV/m	dB	
1 q 5141.562	7.36	34.02	34.99	41.74	48.13	54.00	-5.87	Average
2 5149.980	7.36	34.00	34.99	41.13	47.50	54.00	-6.50	Average
3 5270.000	7.48	34.08	35.00	86.79	93.35	-----	-----	Average



Unless otherwise agreed in writing, this document is issued by the Company subject to its General Conditions of Service printed overleaf, available on request or accessible at <http://www.sgs.com/en/Terms-and-Conditions.aspx> and, for electronic format documents, subject to Terms and Conditions for Electronic Documents at <http://www.sgs.com/en/Terms-and-Conditions/Terms-e-Documents.aspx>. Attention is drawn to the limitation of liability, indemnification and jurisdiction issues defined therein. Any holder of this document is advised that information contained hereon reflects the Company's findings at the time of its intervention only and within the limits of Client's instructions, if any. The Company's sole responsibility is to its Client and this document does not exonerate parties to a transaction from exercising all their rights and obligations under the transaction documents. This document cannot be reproduced except in full, without prior written approval of the Company. Any unauthorized alteration, forgery or falsification of the content or appearance of this document is unlawful and offenders may be prosecuted to the fullest extent of the law. Unless otherwise stated the results shown in this test report refer only to the sample(s) tested and such sample(s) are retained for 30 days only.

Test Mode: 06; Polarity: Vertical; Modulation:802.11ax; Bandwidth:40MHz; Channel:Low

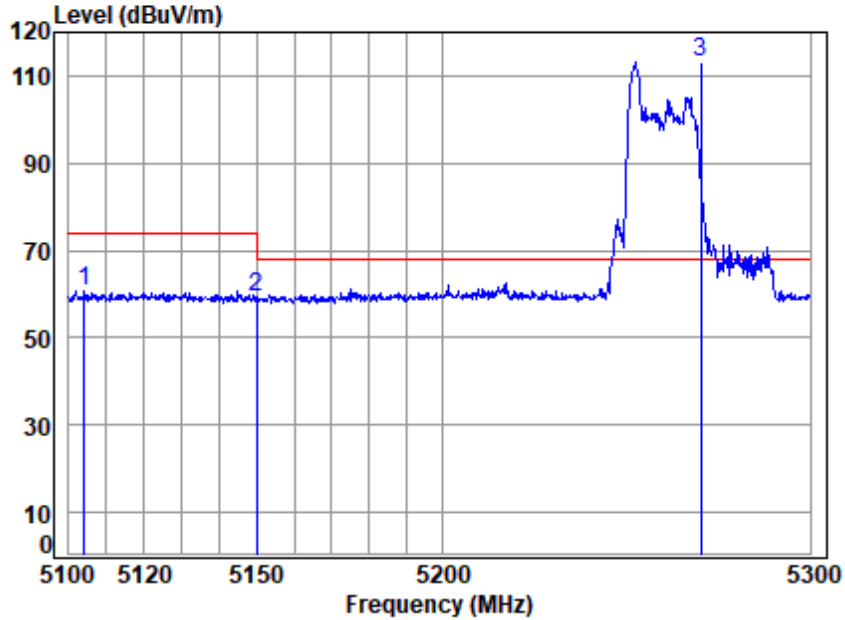

Site : chamber
 Condition: 3m VERTICAL
 Job No : 00750AT\00751AT
 Mode : 5270 Band edge
 : 5G WIFI 11AX40 26 RU

	Cable	Ant	Preamp	Read	Limit	Over		
Freq	Loss	Factor	Factor	Level	Level	Line	Limit	Remark
MHz	dB	dB/m	dB	dBuV	dBuV/m	dBuV/m	dB	
1	5104.122	7.32	34.09	34.99	54.37	60.79	74.00	-13.21 Peak
2	5149.980	7.36	34.00	34.99	52.86	59.23	74.00	-14.77 Peak
3 q	5270.000	7.48	34.08	35.00	106.75	113.31	68.20	45.11 Peak



Unless otherwise agreed in writing, this document is issued by the Company subject to its General Conditions of Service printed overleaf, available on request or accessible at <http://www.sgs.com/en/Terms-and-Conditions.aspx> and, for electronic format documents, subject to Terms and Conditions for Electronic Documents at <http://www.sgs.com/en/Terms-and-Conditions/Terms-e-Documents.aspx>. Attention is drawn to the limitation of liability, indemnification and jurisdiction issues defined therein. Any holder of this document is advised that information contained hereon reflects the Company's findings at the time of its intervention only and within the limits of Client's instructions, if any. The Company's sole responsibility is to its Client and this document does not exonerate parties to a transaction from exercising all their rights and obligations under the transaction documents. This document cannot be reproduced except in full, without prior written approval of the Company. Any unauthorized alteration, forgery or falsification of the content or appearance of this document is unlawful and offenders may be prosecuted to the fullest extent of the law. Unless otherwise stated the results shown in this test report refer only to the sample(s) tested and such sample(s) are retained for 30 days only.
 Attention: To check the authenticity of testing /inspection report & certificate, please contact us at telephone: (86-755) 8307 1443, or email: CN.Doccheck@sgs.com

Test Mode: 06; Polarity: Vertical; Modulation:802.11ax; Bandwidth:40MHz; Channel:Low

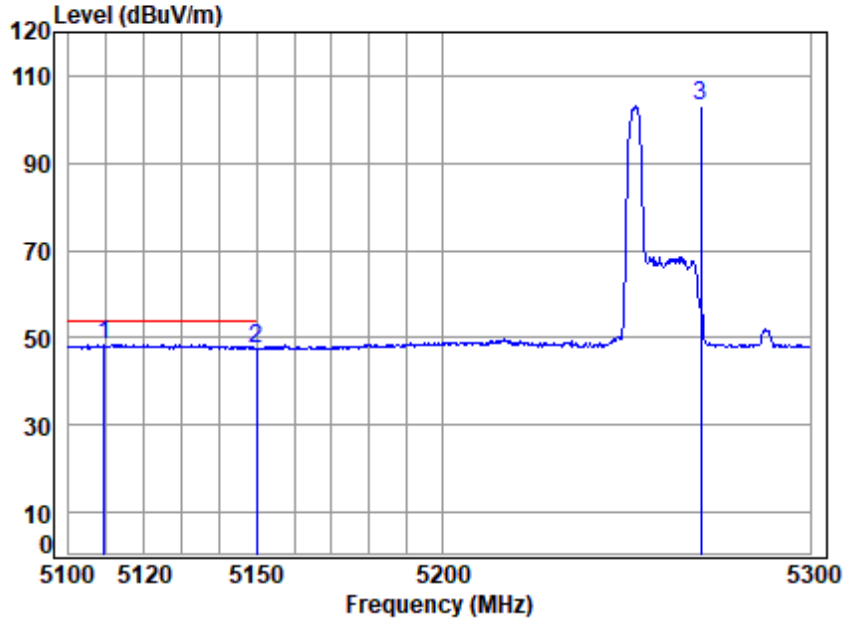

Site : chamber
 Condition: 3m VERTICAL
 Job No : 00750AT\00751AT
 Mode : 5270 Band edge
 : 5G WIFI 11AX40 26 RU

	Cable	Ant	Preamp	Read	Limit	Over		
Freq	Loss	Factor	Factor	Level	Level	Line	Limit	Remark
MHz	dB	dB/m	dB	dBuV	dBuV/m	dBuV/m	dB	
1 q 5109.425	7.32	34.08	34.99	42.04	48.45	54.00	-5.55	Average
2 5149.980	7.36	34.00	34.99	41.14	47.51	54.00	-6.49	Average
3 5270.000	7.48	34.08	35.00	96.62	103.18	-----	-----	Average



Unless otherwise agreed in writing, this document is issued by the Company subject to its General Conditions of Service printed overleaf, available on request or accessible at <http://www.sgs.com/en/Terms-and-Conditions.aspx> and, for electronic format documents, subject to Terms and Conditions for Electronic Documents at <http://www.sgs.com/en/Terms-and-Conditions/Terms-e-Documents.aspx>. Attention is drawn to the limitation of liability, indemnification and jurisdiction issues defined therein. Any holder of this document is advised that information contained hereon reflects the Company's findings at the time of its intervention only and within the limits of Client's instructions, if any. The Company's sole responsibility is to its Client and this document does not exonerate parties to a transaction from exercising all their rights and obligations under the transaction documents. This document cannot be reproduced except in full, without prior written approval of the Company. Any unauthorized alteration, forgery or falsification of the content or appearance of this document is unlawful and offenders may be prosecuted to the fullest extent of the law. Unless otherwise stated the results shown in this test report refer only to the sample(s) tested and such sample(s) are retained for 30 days only.

Test Mode: 06; Polarity: Horizontal; Modulation:802.11ax; Bandwidth:40MHz; Channel:Low

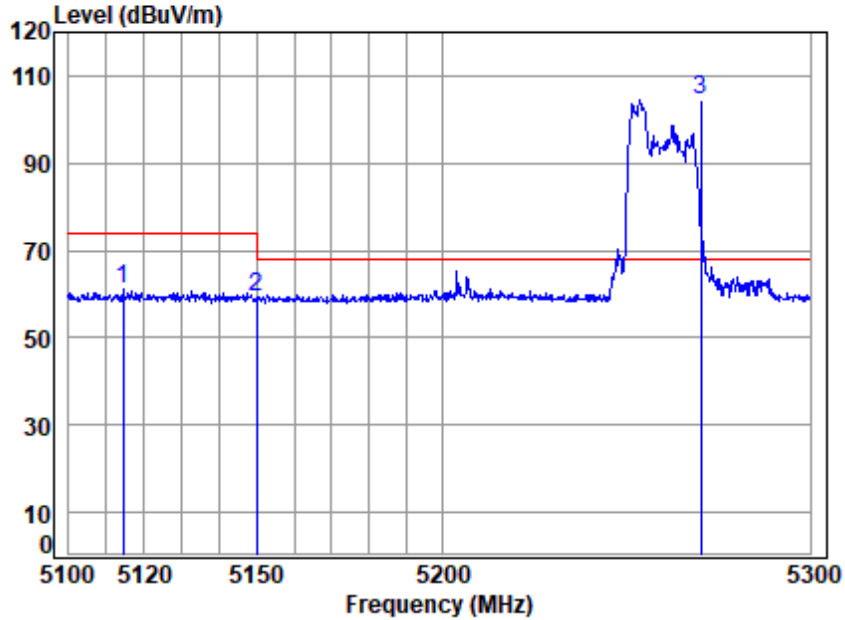

Site : chamber
 Condition: 3m HORIZONTAL
 Job No : 00750AT\00751AT
 Mode : 5270 Band edge
 : 5G WIFI 11AX40 52 RU

	Cable	Ant	Preamp	Read	Limit	Over		
Freq	Loss	Factor	Factor	Level	Level	Line	Limit	Remark
MHz	dB	dB/m	dB	dBuV	dBuV/m	dBuV/m	dB	
1	7.33	34.07	34.99	54.53	60.94	74.00	-13.06	peak
2	7.36	34.00	34.99	52.73	59.10	74.00	-14.90	peak
3 q	7.48	34.08	35.00	98.02	104.58	68.20	36.38	peak



Unless otherwise agreed in writing, this document is issued by the Company subject to its General Conditions of Service printed overleaf, available on request or accessible at <http://www.sgs.com/en/Terms-and-Conditions.aspx> and, for electronic format documents, subject to Terms and Conditions for Electronic Documents at <http://www.sgs.com/en/Terms-and-Conditions/Terms-e-Documents.aspx>. Attention is drawn to the limitation of liability, indemnification and jurisdiction issues defined therein. Any holder of this document is advised that information contained hereon reflects the Company's findings at the time of its intervention only and within the limits of Client's instructions, if any. The Company's sole responsibility is to its Client and this document does not exonerate parties to a transaction from exercising all their rights and obligations under the transaction documents. This document cannot be reproduced except in full, without prior written approval of the Company. Any unauthorized alteration, forgery or falsification of the content or appearance of this document is unlawful and offenders may be prosecuted to the fullest extent of the law. Unless otherwise stated the results shown in this test report refer only to the sample(s) tested and such sample(s) are retained for 30 days only.

Test Mode: 06; Polarity: Horizontal; Modulation:802.11ax; Bandwidth:40MHz; Channel:Low

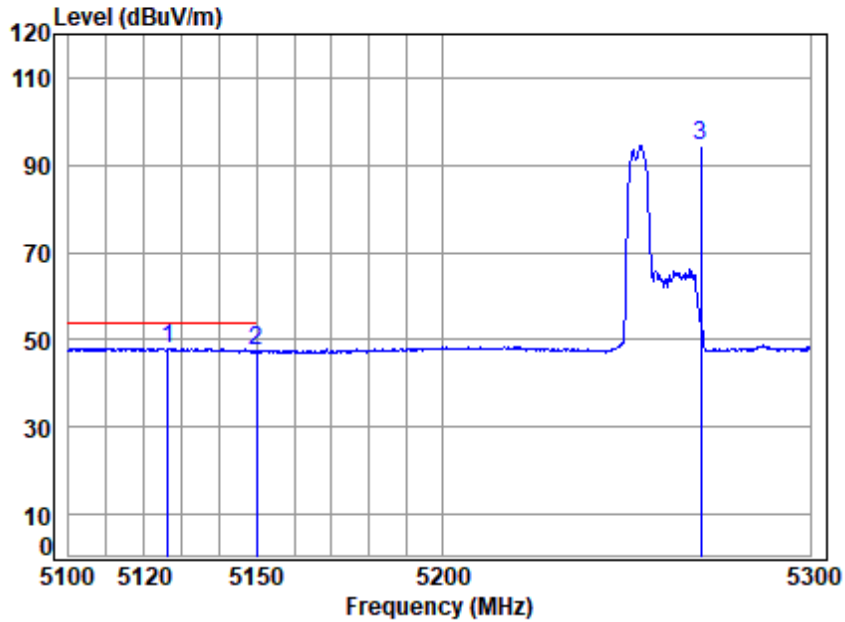

Site : chamber
 Condition: 3m HORIZONTAL
 Job No : 00750AT\00751AT
 Mode : 5270 Band edge
 : 5G WIFI 11AX40 52 RU

	Cable	Ant	Preamp	Read	Limit	Over		
Freq	Loss	Factor	Factor	Level	Level	Line	Limit	Remark
MHz	dB	dB/m	dB	dBuV	dBuV/m	dBuV/m	dB	
1 q 5126.356	7.34	34.05	34.99	41.60	48.00	54.00	-6.00	Average
2 5149.980	7.36	34.00	34.99	41.05	47.42	54.00	-6.58	Average
3 5270.000	7.48	34.08	35.00	88.02	94.58	-----	-----	Average



Unless otherwise agreed in writing, this document is issued by the Company subject to its General Conditions of Service printed overleaf, available on request or accessible at <http://www.sgs.com/en/Terms-and-Conditions.aspx> and, for electronic format documents, subject to Terms and Conditions for Electronic Documents at <http://www.sgs.com/en/Terms-and-Conditions/Terms-e-Documents.aspx>. Attention is drawn to the limitation of liability, indemnification and jurisdiction issues defined therein. Any holder of this document is advised that information contained hereon reflects the Company's findings at the time of its intervention only and within the limits of Client's instructions, if any. The Company's sole responsibility is to its Client and this document does not exonerate parties to a transaction from exercising all their rights and obligations under the transaction documents. This document cannot be reproduced except in full, without prior written approval of the Company. Any unauthorized alteration, forgery or falsification of the content or appearance of this document is unlawful and offenders may be prosecuted to the fullest extent of the law. Unless otherwise stated the results shown in this test report refer only to the sample(s) tested and such sample(s) are retained for 30 days only.

Test Mode: 06; Polarity: Vertical; Modulation:802.11ax; Bandwidth:40MHz; Channel:Low

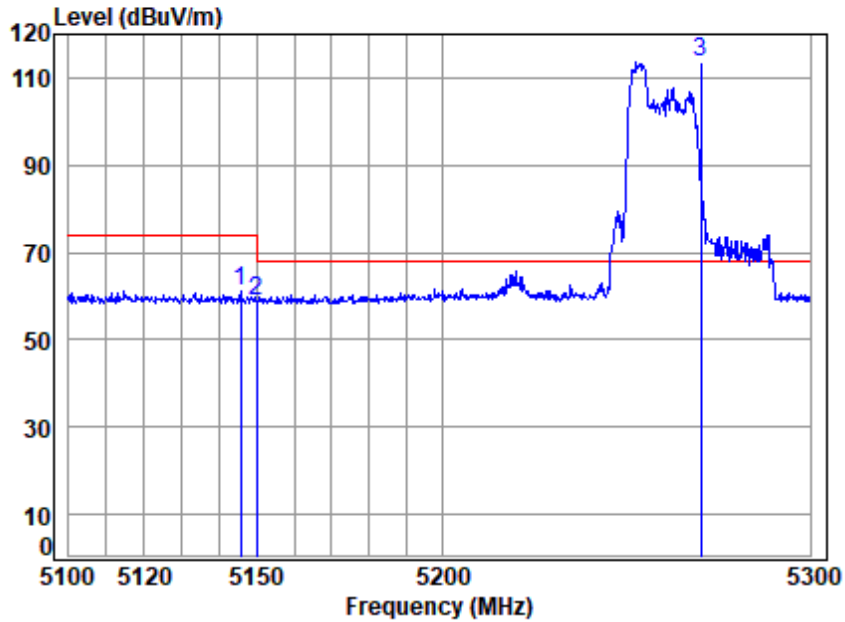

Site : chamber
 Condition: 3m VERTICAL
 Job No : 00750AT\00751AT
 Mode : 5270 Band edge
 : 5G WIFI 11AX40 52 RU

	Cable	Ant	Preamp	Read	Limit	Over		
Freq	Loss	Factor	Factor	Level	Level	Line	Limit	Remark
MHz	dB	dB/m	dB	dBuV	dBuV/m	dBuV/m	dB	
1	5145.717	7.36	34.01	34.99	54.67	61.05	74.00	-12.95 Peak
2	5149.980	7.36	34.00	34.99	52.61	58.98	74.00	-15.02 Peak
3 q	5270.000	7.48	34.08	35.00	107.06	113.62	68.20	45.42 Peak



Unless otherwise agreed in writing, this document is issued by the Company subject to its General Conditions of Service printed overleaf, available on request or accessible at <http://www.sgs.com/en/Terms-and-Conditions.aspx> and, for electronic format documents, subject to Terms and Conditions for Electronic Documents at <http://www.sgs.com/en/Terms-and-Conditions/Terms-e-Documents.aspx>. Attention is drawn to the limitation of liability, indemnification and jurisdiction issues defined therein. Any holder of this document is advised that information contained hereon reflects the Company's findings at the time of its intervention only and within the limits of Client's instructions, if any. The Company's sole responsibility is to its Client and this document does not exonerate parties to a transaction from exercising all their rights and obligations under the transaction documents. This document cannot be reproduced except in full, without prior written approval of the Company. Any unauthorized alteration, forgery or falsification of the content or appearance of this document is unlawful and offenders may be prosecuted to the fullest extent of the law. Unless otherwise stated the results shown in this test report refer only to the sample(s) tested and such sample(s) are retained for 30 days only.

Test Mode: 06; Polarity: Vertical; Modulation:802.11ax; Bandwidth:40MHz; Channel:Low

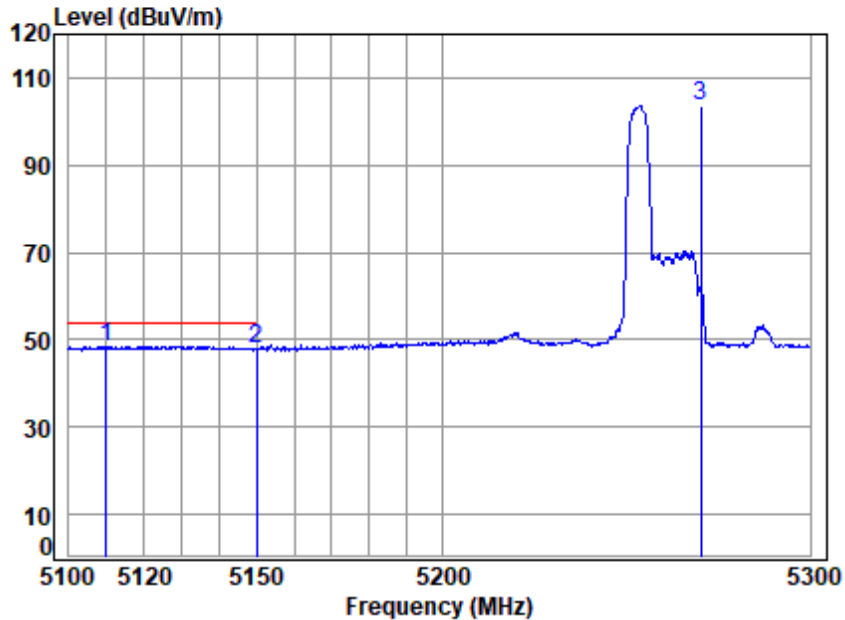

Site : chamber
 Condition: 3m VERTICAL
 Job No : 00750AT\00751AT
 Mode : 5270 Band edge
 : 5G WIFI 11AX40 52 RU

	Cable	Ant	Preamp	Read	Limit	Over		
Freq	Loss	Factor	Factor	Level	Level	Line	Limit	Remark
MHz	dB	dB/m	dB	dBuV	dBuV/m	dBuV/m	dB	
1 q 5110.015	7.32	34.08	34.99	42.01	48.42	54.00	-5.58	Average
2 5149.980	7.36	34.00	34.99	41.55	47.92	54.00	-6.08	Average
3 5270.000	7.48	34.08	35.00	97.06	103.62	-----	-----	Average



Unless otherwise agreed in writing, this document is issued by the Company subject to its General Conditions of Service printed overleaf, available on request or accessible at <http://www.sgs.com/en/Terms-and-Conditions.aspx> and, for electronic format documents, subject to Terms and Conditions for Electronic Documents at <http://www.sgs.com/en/Terms-and-Conditions/Terms-e-Documents.aspx>. Attention is drawn to the limitation of liability, indemnification and jurisdiction issues defined therein. Any holder of this document is advised that information contained hereon reflects the Company's findings at the time of its intervention only and within the limits of Client's instructions, if any. The Company's sole responsibility is to its Client and this document does not exonerate parties to a transaction from exercising all their rights and obligations under the transaction documents. This document cannot be reproduced except in full, without prior written approval of the Company. Any unauthorized alteration, forgery or falsification of the content or appearance of this document is unlawful and offenders may be prosecuted to the fullest extent of the law. Unless otherwise stated the results shown in this test report refer only to the sample(s) tested and such sample(s) are retained for 30 days only.

Test Mode: 06; Polarity: Horizontal; Modulation:802.11ax; Bandwidth:40MHz; Channel:Low

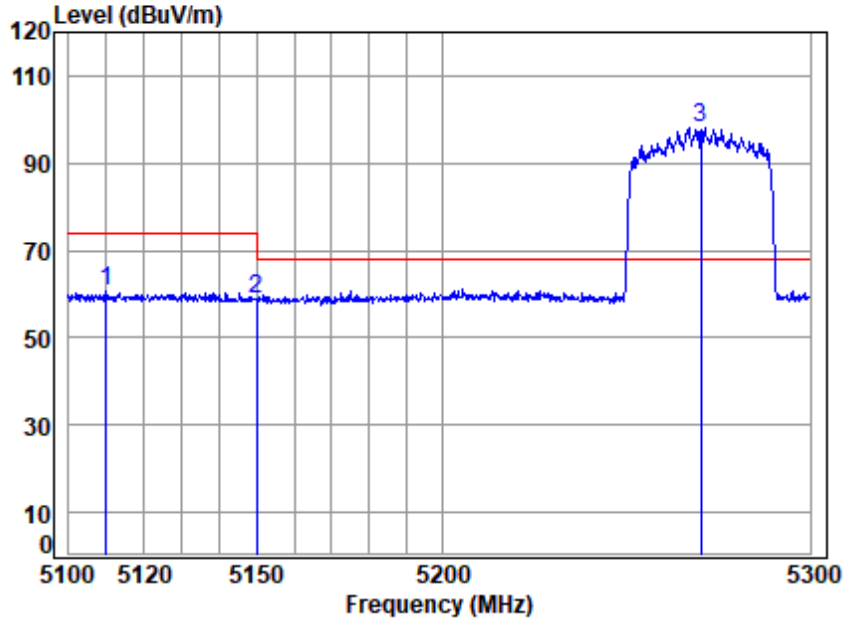

Site : chamber
 Condition: 3m HORIZONTAL
 Job No : 00750AT\00751AT
 Mode : 5270 Band edge
 : 5G WIFI 11AX40 484 RU

		Cable	Ant	Preamp	Read	Limit	Over	
	Freq	Loss	Factor	Factor	Level	Level	Line	Limit
	MHz	dB	dB/m	dB	dBuV	dBuV/m	dBuV/m	dB
1	5110.015	7.32	34.08	34.99	54.12	60.53	74.00	-13.47 peak
2	5149.980	7.36	34.00	34.99	52.49	58.86	74.00	-15.14 peak
3 q	5270.000	7.48	34.08	35.00	91.73	98.29	68.20	30.09 peak



Unless otherwise agreed in writing, this document is issued by the Company subject to its General Conditions of Service printed overleaf, available on request or accessible at <http://www.sgs.com/en/Terms-and-Conditions.aspx> and, for electronic format documents, subject to Terms and Conditions for Electronic Documents at <http://www.sgs.com/en/Terms-and-Conditions/Terms-e-Documents.aspx>. Attention is drawn to the limitation of liability, indemnification and jurisdiction issues defined therein. Any holder of this document is advised that information contained hereon reflects the Company's findings at the time of its intervention only and within the limits of Client's instructions, if any. The Company's sole responsibility is to its Client and this document does not exonerate parties to a transaction from exercising all their rights and obligations under the transaction documents. This document cannot be reproduced except in full, without prior written approval of the Company. Any unauthorized alteration, forgery or falsification of the content or appearance of this document is unlawful and offenders may be prosecuted to the fullest extent of the law. Unless otherwise stated the results shown in this test report refer only to the sample(s) tested and such sample(s) are retained for 30 days only.
 Attention: To check the authenticity of testing /inspection report & certificate, please contact us at telephone: (86-755) 8307 1443, or email: CN.Doccheck@sgs.com

Test Mode: 06; Polarity: Horizontal; Modulation:802.11ax; Bandwidth:40MHz; Channel:Low

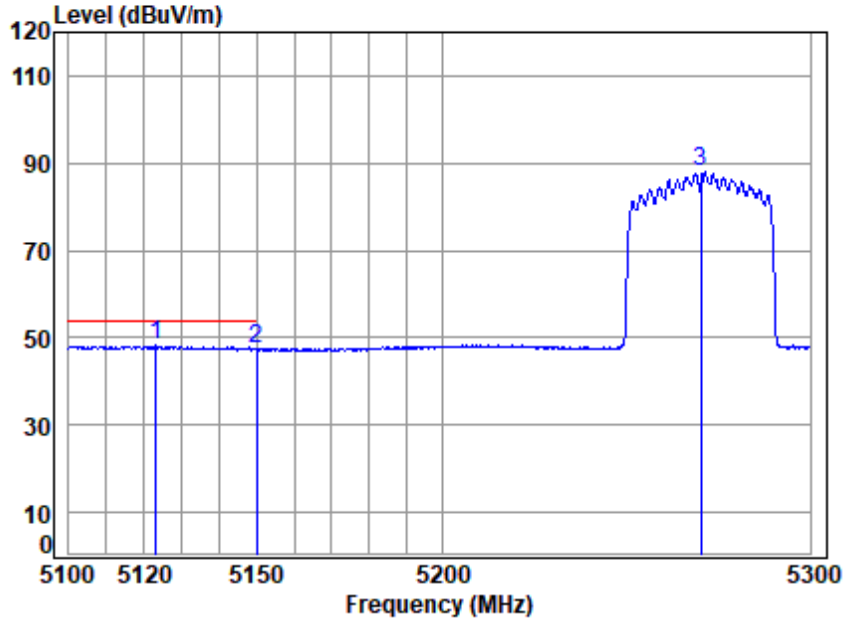

Site : chamber
 Condition: 3m HORIZONTAL
 Job No : 00750AT\00751AT
 Mode : 5270 Band edge
 : 5G WIFI 11AX40 484 RU

		Cable	Ant	Preamp	Read	Limit	Over		
Freq	Loss	Factor	Factor	Factor	Level	Level	Line	Limit	Remark
MHz	dB	dB/m	dB/m	dB	dBuV	dBuV/m	dBuV/m	dB	
1 q 5123.202	7.34	34.05	34.99	42.03	48.43	54.00	-5.57	Average	
2 5149.980	7.36	34.00	34.99	41.12	47.49	54.00	-6.51	Average	
3 5270.000	7.48	34.08	35.00	81.51	88.07	-----	-----	Average	



Unless otherwise agreed in writing, this document is issued by the Company subject to its General Conditions of Service printed overleaf, available on request or accessible at <http://www.sgs.com/en/Terms-and-Conditions.aspx> and, for electronic format documents, subject to Terms and Conditions for Electronic Documents at <http://www.sgs.com/en/Terms-and-Conditions/Terms-e-Documents.aspx>. Attention is drawn to the limitation of liability, indemnification and jurisdiction issues defined therein. Any holder of this document is advised that information contained hereon reflects the Company's findings at the time of its intervention only and within the limits of Client's instructions, if any. The Company's sole responsibility is to its Client and this document does not exonerate parties to a transaction from exercising all their rights and obligations under the transaction documents. This document cannot be reproduced except in full, without prior written approval of the Company. Any unauthorized alteration, forgery or falsification of the content or appearance of this document is unlawful and offenders may be prosecuted to the fullest extent of the law. Unless otherwise stated the results shown in this test report refer only to the sample(s) tested and such sample(s) are retained for 30 days only.

Test Mode: 06; Polarity: Vertical; Modulation:802.11ax; Bandwidth:40MHz; Channel:Low

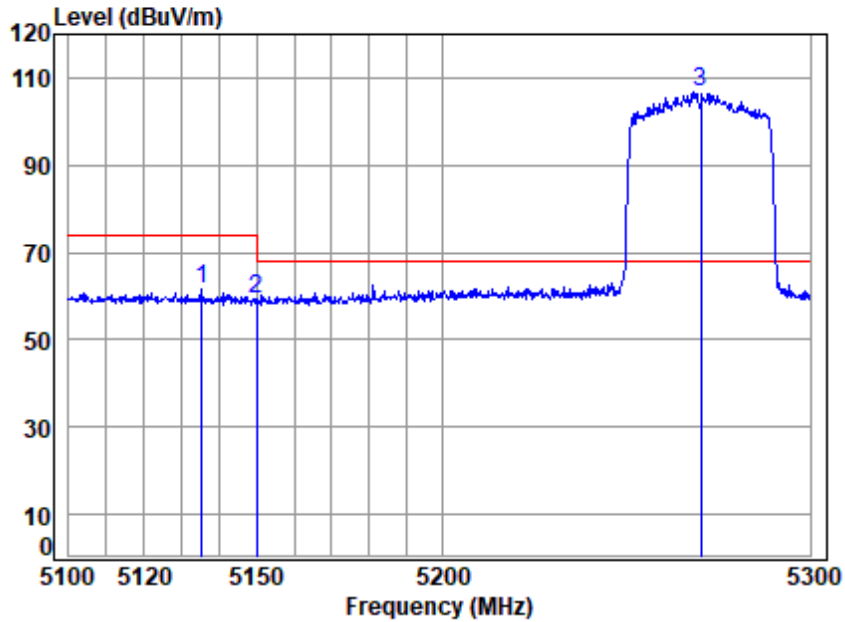

Site : chamber
 Condition: 3m VERTICAL
 Job No : 00750AT\00751AT
 Mode : 5270 Band edge
 : 5G WIFI 11AX40 484 RU

		Cable	Ant	Preamp	Read	Limit	Over	
	Freq	Loss	Factor	Factor	Level	Level	Line	Limit
	MHz	dB	dB/m	dB	dBuV	dBuV/m	dBuV/m	dB
1	5135.435	7.35	34.03	34.99	55.00	61.39	74.00	-12.61 Peak
2	5149.980	7.36	34.00	34.99	52.97	59.34	74.00	-14.66 Peak
3 q	5270.000	7.48	34.08	35.00	100.28	106.84	68.20	38.64 Peak



Unless otherwise agreed in writing, this document is issued by the Company subject to its General Conditions of Service printed overleaf, available on request or accessible at <http://www.sgs.com/en/Terms-and-Conditions.aspx> and, for electronic format documents, subject to Terms and Conditions for Electronic Documents at <http://www.sgs.com/en/Terms-and-Conditions/Terms-e-Documents.aspx>. Attention is drawn to the limitation of liability, indemnification and jurisdiction issues defined therein. Any holder of this document is advised that information contained hereon reflects the Company's findings at the time of its intervention only and within the limits of Client's instructions, if any. The Company's sole responsibility is to its Client and this document does not exonerate parties to a transaction from exercising all their rights and obligations under the transaction documents. This document cannot be reproduced except in full, without prior written approval of the Company. Any unauthorized alteration, forgery or falsification of the content or appearance of this document is unlawful and offenders may be prosecuted to the fullest extent of the law. Unless otherwise stated the results shown in this test report refer only to the sample(s) tested and such sample(s) are retained for 30 days only.

Test Mode: 06; Polarity: Vertical; Modulation:802.11ax; Bandwidth:40MHz; Channel:Low

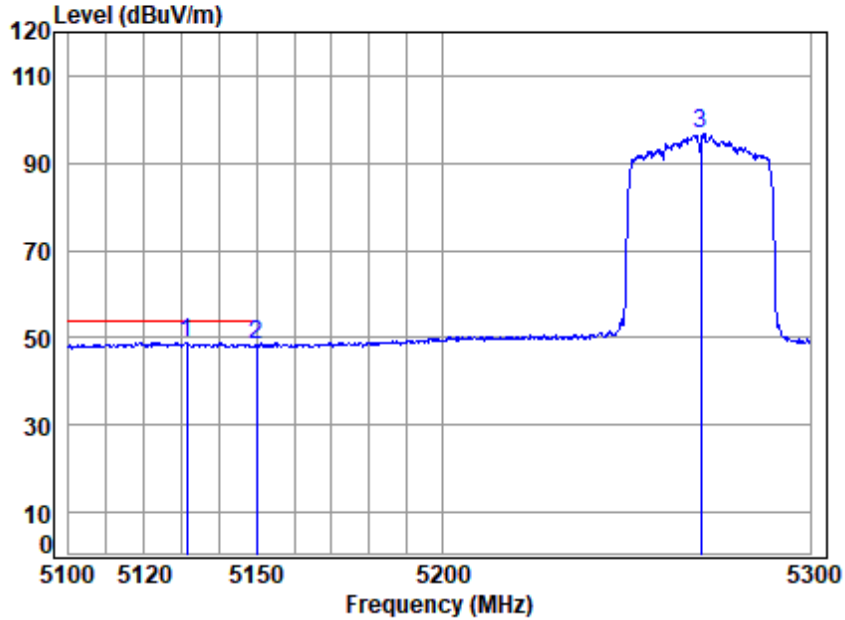

Site : chamber
 Condition: 3m VERTICAL
 Job No : 00750AT\00751AT
 Mode : 5270 Band edge
 : 5G WIFI 11AX40 484 RU

	Cable	Ant	Preamp	Read	Limit	Over		
Freq	Loss	Factor	Factor	Level	Level	Line	Limit	Remark
MHz	dB	dB/m	dB	dBuV	dBuV/m	dBuV/m	dB	
1 q 5131.288	7.35	34.04	34.99	42.36	48.76	54.00	-5.24	Average
2 5149.980	7.36	34.00	34.99	42.10	48.47	54.00	-5.53	Average
3 5270.000	7.48	34.08	35.00	90.17	96.73	-----	-----	Average



Unless otherwise agreed in writing, this document is issued by the Company subject to its General Conditions of Service printed overleaf, available on request or accessible at <http://www.sgs.com/en/Terms-and-Conditions.aspx> and, for electronic format documents, subject to Terms and Conditions for Electronic Documents at <http://www.sgs.com/en/Terms-and-Conditions/Terms-e-Documents.aspx>. Attention is drawn to the limitation of liability, indemnification and jurisdiction issues defined therein. Any holder of this document is advised that information contained hereon reflects the Company's findings at the time of its intervention only and within the limits of Client's instructions, if any. The Company's sole responsibility is to its Client and this document does not exonerate parties to a transaction from exercising all their rights and obligations under the transaction documents. This document cannot be reproduced except in full, without prior written approval of the Company. Any unauthorized alteration, forgery or falsification of the content or appearance of this document is unlawful and offenders may be prosecuted to the fullest extent of the law. Unless otherwise stated the results shown in this test report refer only to the sample(s) tested and such sample(s) are retained for 30 days only.

Test Mode: 06; Polarity: Horizontal; Modulation:802.11ax; Bandwidth:40MHz; Channel:High

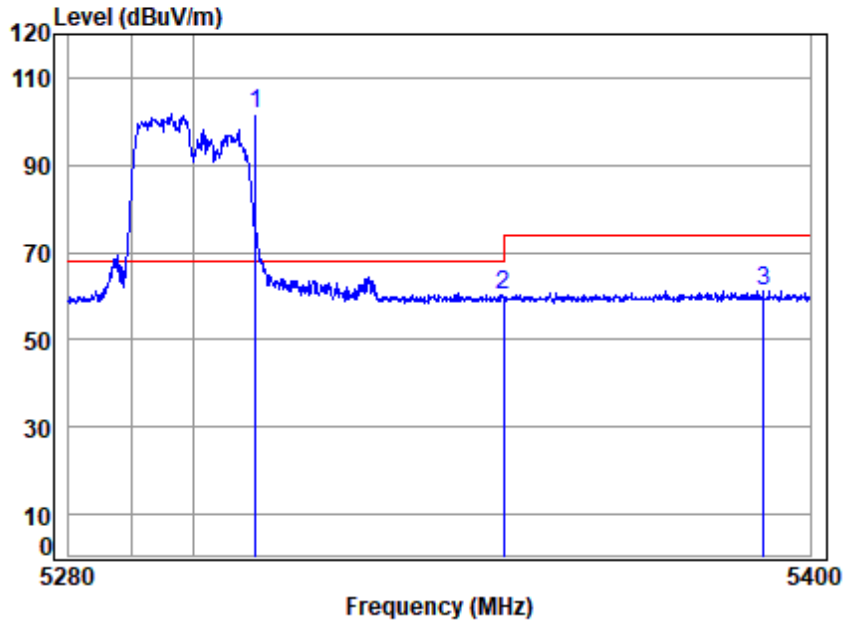

Site : chamber
 Condition: 3m HORIZONTAL
 Job No : 00750AT\00751AT
 Mode : 5310 Band edge
 : 5G WIFI 11AX40 106 RU

		Cable	Ant	Preamp	Read	Limit	Over	
Freq	Loss	Factor	Factor	Factor	Level	Level	Line	Limit
MHz	dB	dB/m	dB/m	dB	dBuV	dBuV/m	dBuV/m	dB
1 q 5310.000	7.52	34.22	35.00	94.99	101.73	68.20	33.53	peak
2 5350.020	7.56	34.30	35.00	53.44	60.30	74.00	-13.70	peak
3 5392.360	7.60	34.47	35.00	54.07	61.14	74.00	-12.86	peak



Unless otherwise agreed in writing, this document is issued by the Company subject to its General Conditions of Service printed overleaf, available on request or accessible at <http://www.sgs.com/en/Terms-and-Conditions.aspx> and, for electronic format documents, subject to Terms and Conditions for Electronic Documents at <http://www.sgs.com/en/Terms-and-Conditions/Terms-e-Documents.aspx>. Attention is drawn to the limitation of liability, indemnification and jurisdiction issues defined therein. Any holder of this document is advised that information contained hereon reflects the Company's findings at the time of its intervention only and within the limits of Client's instructions, if any. The Company's sole responsibility is to its Client and this document does not exonerate parties to a transaction from exercising all their rights and obligations under the transaction documents. This document cannot be reproduced except in full, without prior written approval of the Company. Any unauthorized alteration, forgery or falsification of the content or appearance of this document is unlawful and offenders may be prosecuted to the fullest extent of the law. Unless otherwise stated the results shown in this test report refer only to the sample(s) tested and such sample(s) are retained for 30 days only.

Test Mode: 06; Polarity: Horizontal; Modulation:802.11ax; Bandwidth:40MHz; Channel:High

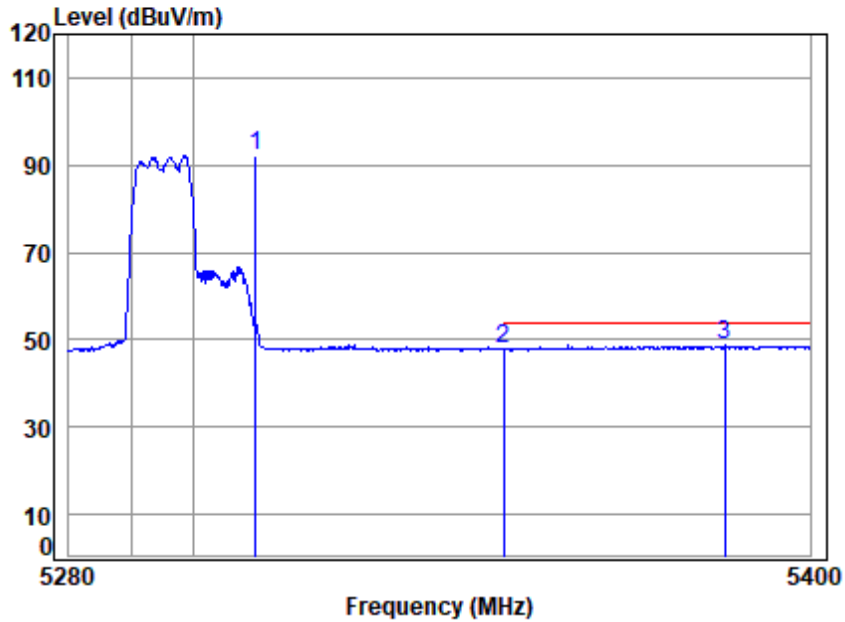

Site : chamber
 Condition: 3m HORIZONTAL
 Job No : 00750AT\00751AT
 Mode : 5310 Band edge
 : 5G WIFI 11AX40 106 RU

		Cable	Ant	Preamp	Read	Limit	Over		
Freq	Loss	Factor	Factor	Factor	Level	Level	Line	Limit	Remark
MHz	dB	dB/m	dB	dB	dBuV	dBuV/m	dBuV/m	dB	
1	5310.000	7.52	34.22	35.00	85.64	92.38	-----	-----	Average
2	5350.020	7.56	34.30	35.00	40.95	47.81	54.00	-6.19	Average
3 q	5386.063	7.60	34.44	35.00	41.64	48.68	54.00	-5.32	Average



Unless otherwise agreed in writing, this document is issued by the Company subject to its General Conditions of Service printed overleaf, available on request or accessible at <http://www.sgs.com/en/Terms-and-Conditions.aspx> and, for electronic format documents, subject to Terms and Conditions for Electronic Documents at <http://www.sgs.com/en/Terms-and-Conditions/Terms-e-Documents.aspx>. Attention is drawn to the limitation of liability, indemnification and jurisdiction issues defined therein. Any holder of this document is advised that information contained hereon reflects the Company's findings at the time of its intervention only and within the limits of Client's instructions, if any. The Company's sole responsibility is to its Client and this document does not exonerate parties to a transaction from exercising all their rights and obligations under the transaction documents. This document cannot be reproduced except in full, without prior written approval of the Company. Any unauthorized alteration, forgery or falsification of the content or appearance of this document is unlawful and offenders may be prosecuted to the fullest extent of the law. Unless otherwise stated the results shown in this test report refer only to the sample(s) tested and such sample(s) are retained for 30 days only.

Test Mode: 06; Polarity: Vertical; Modulation:802.11ax; Bandwidth:40MHz; Channel:High

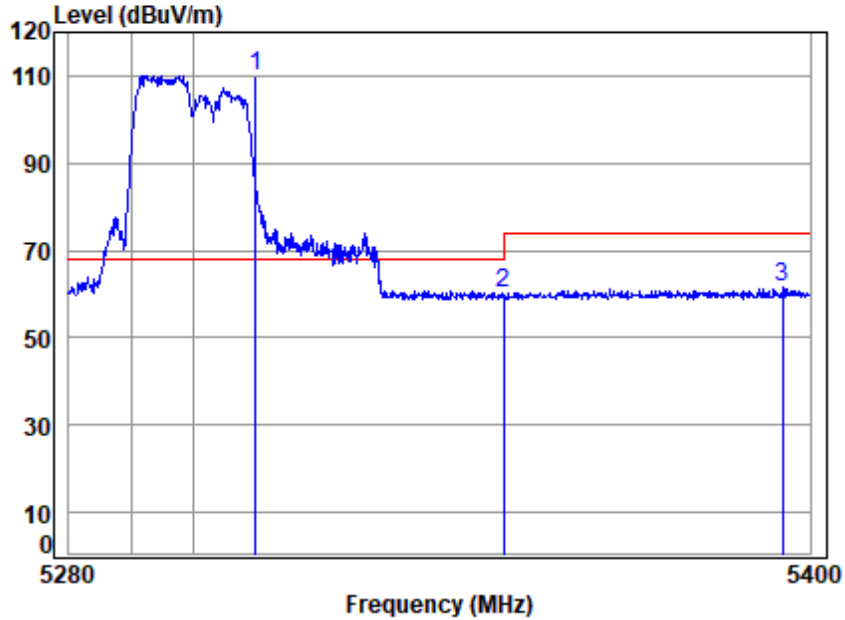

Site : chamber
 Condition: 3m VERTICAL
 Job No : 00750AT\00751AT
 Mode : 5310 Band edge
 : 5G WIFI 11AX40 106 RU

		Cable	Ant	Preamp	Read	Limit	Over	
Freq	Loss	Factor	Factor	Factor	Level	Level	Line	Limit
MHz	dB	dB/m	dB/m	dB	dBuV	dBuV/m	dBuV/m	dB
1 q 5310.000	7.52	34.22	35.00	103.45	110.19	68.20	41.99	Peak
2 5350.020	7.56	34.30	35.00	53.56	60.42	74.00	-13.58	Peak
3 5395.512	7.61	34.48	35.01	54.33	61.41	74.00	-12.59	Peak



Unless otherwise agreed in writing, this document is issued by the Company subject to its General Conditions of Service printed overleaf, available on request or accessible at <http://www.sgs.com/en/Terms-and-Conditions.aspx> and, for electronic format documents, subject to Terms and Conditions for Electronic Documents at <http://www.sgs.com/en/Terms-and-Conditions/Terms-e-Documents.aspx>. Attention is drawn to the limitation of liability, indemnification and jurisdiction issues defined therein. Any holder of this document is advised that information contained hereon reflects the Company's findings at the time of its intervention only and within the limits of Client's instructions, if any. The Company's sole responsibility is to its Client and this document does not exonerate parties to a transaction from exercising all their rights and obligations under the transaction documents. This document cannot be reproduced except in full, without prior written approval of the Company. Any unauthorized alteration, forgery or falsification of the content or appearance of this document is unlawful and offenders may be prosecuted to the fullest extent of the law. Unless otherwise stated the results shown in this test report refer only to the sample(s) tested and such sample(s) are retained for 30 days only.

Test Mode: 06; Polarity: Vertical; Modulation:802.11ax; Bandwidth:40MHz; Channel:High

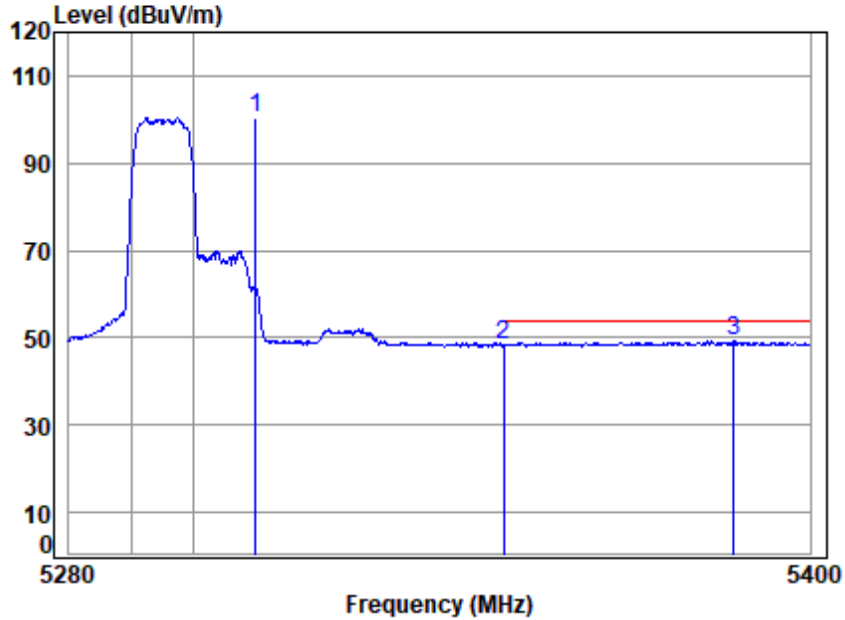

Site : chamber
 Condition: 3m VERTICAL
 Job No : 00750AT\00751AT
 Mode : 5310 Band edge
 : 5G WIFI 11AX40 106 RU

	Cable	Ant	Preamp	Read	Limit	Over		
Freq	Loss	Factor	Factor	Level	Level	Line	Limit	Remark
MHz	dB	dB/m	dB	dBuV	dBuV/m	dBuV/m	dB	
1	5310.000	7.52	34.22	35.00	93.74	100.48	-----	----- Average
2	5350.020	7.56	34.30	35.00	41.67	48.53	54.00	-5.47 Average
3 q	5387.515	7.60	34.45	35.00	42.33	49.38	54.00	-4.62 Average



Unless otherwise agreed in writing, this document is issued by the Company subject to its General Conditions of Service printed overleaf, available on request or accessible at <http://www.sgs.com/en/Terms-and-Conditions.aspx> and, for electronic format documents, subject to Terms and Conditions for Electronic Documents at <http://www.sgs.com/en/Terms-and-Conditions/Terms-e-Documents.aspx>. Attention is drawn to the limitation of liability, indemnification and jurisdiction issues defined therein. Any holder of this document is advised that information contained hereon reflects the Company's findings at the time of its intervention only and within the limits of Client's instructions, if any. The Company's sole responsibility is to its Client and this document does not exonerate parties to a transaction from exercising all their rights and obligations under the transaction documents. This document cannot be reproduced except in full, without prior written approval of the Company. Any unauthorized alteration, forgery or falsification of the content or appearance of this document is unlawful and offenders may be prosecuted to the fullest extent of the law. Unless otherwise stated the results shown in this test report refer only to the sample(s) tested and such sample(s) are retained for 30 days only.

Test Mode: 06; Polarity: Horizontal; Modulation:802.11ax; Bandwidth:40MHz; Channel:High

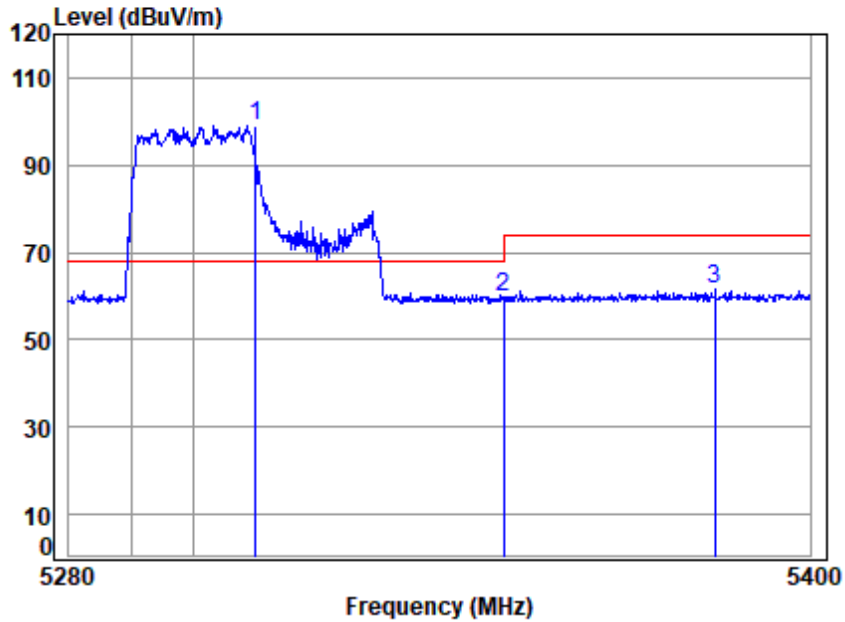

Site : chamber
 Condition: 3m HORIZONTAL
 Job No : 00750AT\00751AT
 Mode : 5310 Band edge
 : 5G WIFI 11AX40 242 RU

		Cable	Ant	Preamp	Read	Limit	Over		
Freq	Loss	Factor	Factor	Factor	Level	Level	Line	Limit	Remark
MHz	dB	dB/m	dB/m	dB	dBuV	dBuV/m	dBuV/m	dB	
1 q 5310.000	7.52	34.22	35.00	92.25	98.99	68.20	30.79	peak	
2 5350.020	7.56	34.30	35.00	53.08	59.94	74.00	-14.06	peak	
3 5384.489	7.60	34.44	35.00	54.40	61.44	74.00	-12.56	peak	



Unless otherwise agreed in writing, this document is issued by the Company subject to its General Conditions of Service printed overleaf, available on request or accessible at <http://www.sgs.com/en/Terms-and-Conditions.aspx> and, for electronic format documents, subject to Terms and Conditions for Electronic Documents at <http://www.sgs.com/en/Terms-and-Conditions/Terms-e-Documents.aspx>. Attention is drawn to the limitation of liability, indemnification and jurisdiction issues defined therein. Any holder of this document is advised that information contained hereon reflects the Company's findings at the time of its intervention only and within the limits of Client's instructions, if any. The Company's sole responsibility is to its Client and this document does not exonerate parties to a transaction from exercising all their rights and obligations under the transaction documents. This document cannot be reproduced except in full, without prior written approval of the Company. Any unauthorized alteration, forgery or falsification of the content or appearance of this document is unlawful and offenders may be prosecuted to the fullest extent of the law. Unless otherwise stated the results shown in this test report refer only to the sample(s) tested and such sample(s) are retained for 30 days only.

Test Mode: 06; Polarity: Horizontal; Modulation:802.11ax; Bandwidth:40MHz; Channel:High

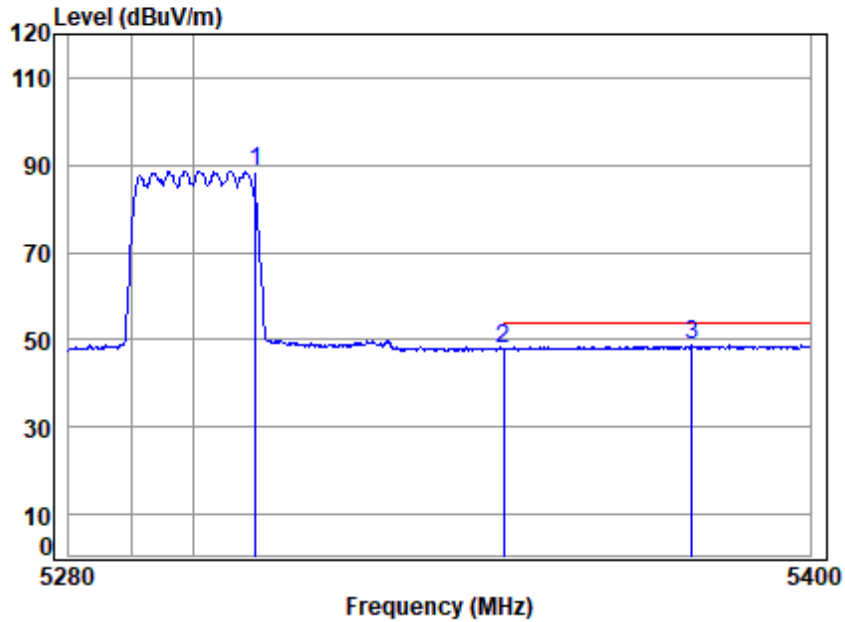

Site : chamber
 Condition: 3m HORIZONTAL
 Job No : 00750AT\00751AT
 Mode : 5310 Band edge
 : 5G WIFI 11AX40 242 RU

		Cable	Ant	Preamp	Read	Limit	Over		
	Freq	Loss	Factor	Factor	Level	Level	Line	Limit	
	MHz	dB	dB/m	dB	dBuV	dBuV/m	dBuV/m	dB	
1	5310.000	7.52	34.22	35.00	82.00	88.74	-----	-----	Average
2	5350.020	7.56	34.30	35.00	41.27	48.13	54.00	-5.87	Average
3 q	5380.739	7.59	34.42	35.00	41.77	48.78	54.00	-5.22	Average



Unless otherwise agreed in writing, this document is issued by the Company subject to its General Conditions of Service printed overleaf, available on request or accessible at <http://www.sgs.com/en/Terms-and-Conditions.aspx> and, for electronic format documents, subject to Terms and Conditions for Electronic Documents at <http://www.sgs.com/en/Terms-and-Conditions/Terms-e-Documents.aspx>. Attention is drawn to the limitation of liability, indemnification and jurisdiction issues defined therein. Any holder of this document is advised that information contained hereon reflects the Company's findings at the time of its intervention only and within the limits of Client's instructions, if any. The Company's sole responsibility is to its Client and this document does not exonerate parties to a transaction from exercising all their rights and obligations under the transaction documents. This document cannot be reproduced except in full, without prior written approval of the Company. Any unauthorized alteration, forgery or falsification of the content or appearance of this document is unlawful and offenders may be prosecuted to the fullest extent of the law. Unless otherwise stated the results shown in this test report refer only to the sample(s) tested and such sample(s) are retained for 30 days only.

Test Mode: 06; Polarity: Vertical; Modulation:802.11ax; Bandwidth:40MHz; Channel:High

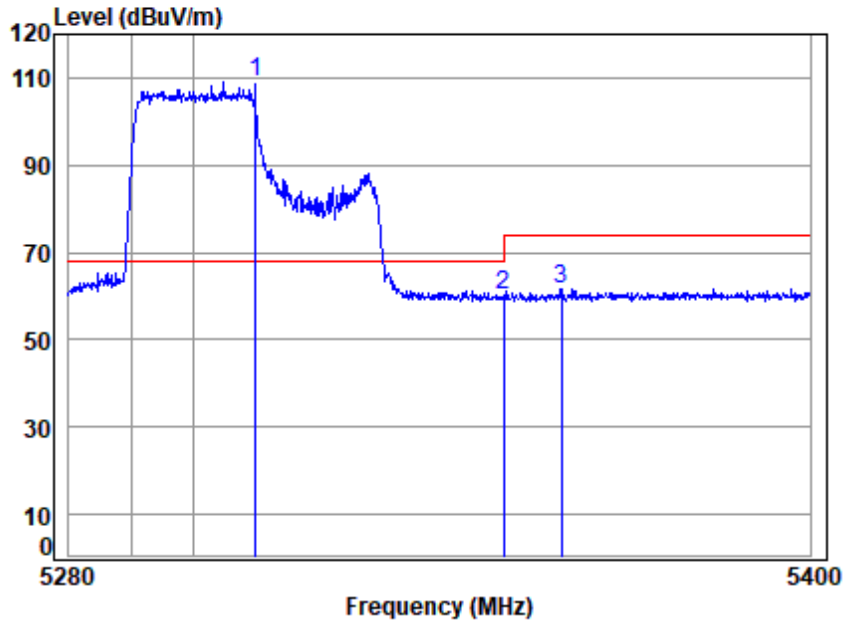

Site : chamber
 Condition: 3m VERTICAL
 Job No : 00750AT\00751AT
 Mode : 5310 Band edge
 : 5G WIFI 11AX40 242 RU

		Cable	Ant	Preamp	Read	Limit	Over	
Freq	Loss	Factor	Factor	Factor	Level	Line	Limit	Remark
MHz	dB	dB/m	dB/m	dB	dBuV	dBuV/m	dBuV/m	dB
1 q 5310.000	7.52	34.22	35.00	102.10	108.84	68.20	40.64	Peak
2 5350.020	7.56	34.30	35.00	53.15	60.01	74.00	-13.99	Peak
3 5359.379	7.57	34.34	35.00	54.81	61.72	74.00	-12.28	Peak



Unless otherwise agreed in writing, this document is issued by the Company subject to its General Conditions of Service printed overleaf, available on request or accessible at <http://www.sgs.com/en/Terms-and-Conditions.aspx> and, for electronic format documents, subject to Terms and Conditions for Electronic Documents at <http://www.sgs.com/en/Terms-and-Conditions/Terms-e-Documents.aspx>. Attention is drawn to the limitation of liability, indemnification and jurisdiction issues defined therein. Any holder of this document is advised that information contained hereon reflects the Company's findings at the time of its intervention only and within the limits of Client's instructions, if any. The Company's sole responsibility is to its Client and this document does not exonerate parties to a transaction from exercising all their rights and obligations under the transaction documents. This document cannot be reproduced except in full, without prior written approval of the Company. Any unauthorized alteration, forgery or falsification of the content or appearance of this document is unlawful and offenders may be prosecuted to the fullest extent of the law. Unless otherwise stated the results shown in this test report refer only to the sample(s) tested and such sample(s) are retained for 30 days only.

Test Mode: 06; Polarity: Vertical; Modulation:802.11ax; Bandwidth:40MHz; Channel:High

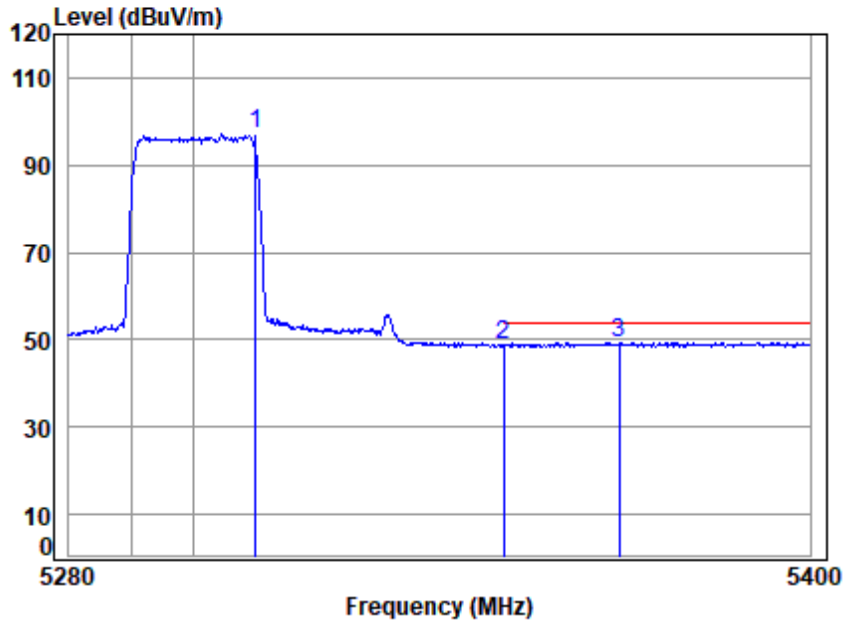

Site : chamber
 Condition: 3m VERTICAL
 Job No : 00750AT\00751AT
 Mode : 5310 Band edge
 : 5G WIFI 11AX40 242 RU

		Cable	Ant	Preamp	Read	Limit	Over		
	Freq	Loss	Factor	Factor	Level	Level	Line	Limit	
	MHz	dB	dB/m	dB	dBuV	dBuV/m	dBuV/m	dB	
1	5310.000	7.52	34.22	35.00	90.31	97.05	-----	-----	Average
2	5350.020	7.56	34.30	35.00	42.01	48.87	54.00	-5.13	Average
3 q	5368.902	7.58	34.38	35.00	42.48	49.44	54.00	-4.56	Average



Unless otherwise agreed in writing, this document is issued by the Company subject to its General Conditions of Service printed overleaf, available on request or accessible at <http://www.sgs.com/en/Terms-and-Conditions.aspx> and, for electronic format documents, subject to Terms and Conditions for Electronic Documents at <http://www.sgs.com/en/Terms-and-Conditions/Terms-e-Documents.aspx>. Attention is drawn to the limitation of liability, indemnification and jurisdiction issues defined therein. Any holder of this document is advised that information contained hereon reflects the Company's findings at the time of its intervention only and within the limits of Client's instructions, if any. The Company's sole responsibility is to its Client and this document does not exonerate parties to a transaction from exercising all their rights and obligations under the transaction documents. This document cannot be reproduced except in full, without prior written approval of the Company. Any unauthorized alteration, forgery or falsification of the content or appearance of this document is unlawful and offenders may be prosecuted to the fullest extent of the law. Unless otherwise stated the results shown in this test report refer only to the sample(s) tested and such sample(s) are retained for 30 days only.

Test Mode: 06; Polarity: Horizontal; Modulation:802.11ax; Bandwidth:40MHz; Channel:High

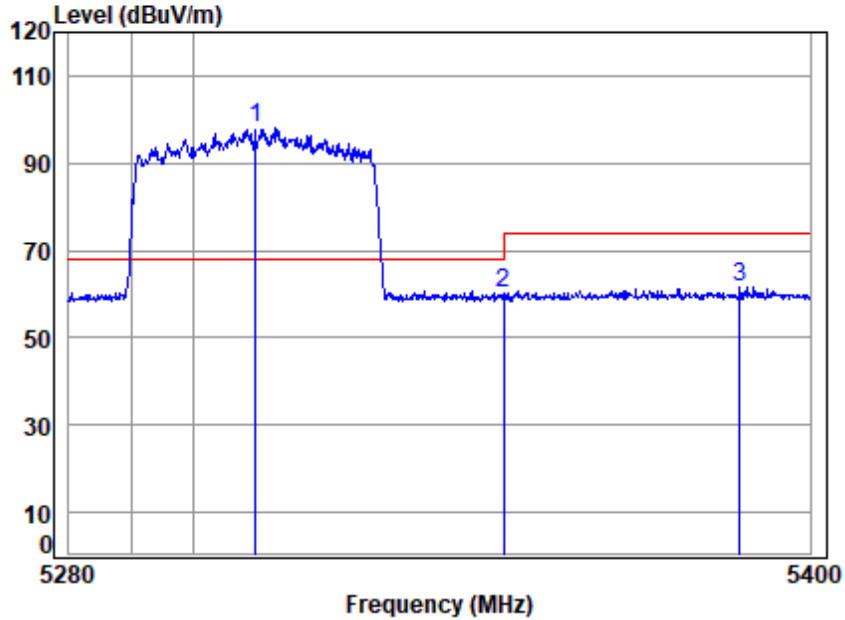

Site : chamber
 Condition: 3m HORIZONTAL
 Job No : 00750AT\00751AT
 Mode : 5310 Band edge
 : 5G WIFI 11AX40 484 RU

		Cable	Ant	Preamp	Read	Limit	Over		
Freq	Loss	Factor	Factor	Factor	Level	Level	Line	Limit	Remark
MHz	dB	dB/m	dB/m	dB	dBuV	dBuV/m	dBuV/m	dB	
1 q 5310.000	7.52	34.22	35.00	91.34	98.08	68.20	29.88	peak	
2 5350.020	7.56	34.30	35.00	53.37	60.23	74.00	-13.77	peak	
3 5388.484	7.60	34.45	35.00	54.54	61.59	74.00	-12.41	peak	



Unless otherwise agreed in writing, this document is issued by the Company subject to its General Conditions of Service printed overleaf, available on request or accessible at <http://www.sgs.com/en/Terms-and-Conditions.aspx> and, for electronic format documents, subject to Terms and Conditions for Electronic Documents at <http://www.sgs.com/en/Terms-and-Conditions/Terms-e-Documents.aspx>. Attention is drawn to the limitation of liability, indemnification and jurisdiction issues defined therein. Any holder of this document is advised that information contained hereon reflects the Company's findings at the time of its intervention only and within the limits of Client's instructions, if any. The Company's sole responsibility is to its Client and this document does not exonerate parties to a transaction from exercising all their rights and obligations under the transaction documents. This document cannot be reproduced except in full, without prior written approval of the Company. Any unauthorized alteration, forgery or falsification of the content or appearance of this document is unlawful and offenders may be prosecuted to the fullest extent of the law. Unless otherwise stated the results shown in this test report refer only to the sample(s) tested and such sample(s) are retained for 30 days only.

Test Mode: 06; Polarity: Horizontal; Modulation:802.11ax; Bandwidth:40MHz; Channel:High

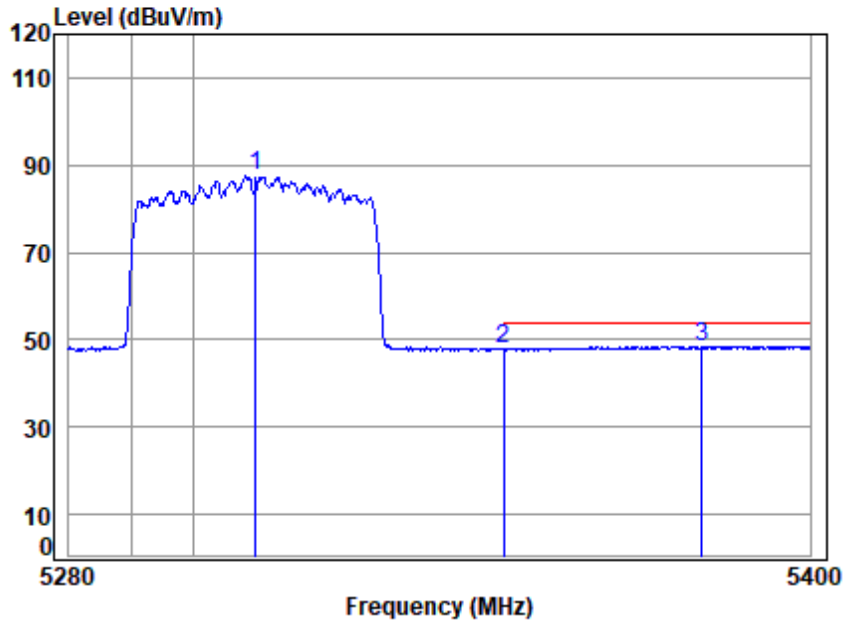

Site : chamber
 Condition: 3m HORIZONTAL
 Job No : 00750AT\00751AT
 Mode : 5310 Band edge
 : 5G WIFI 11AX40 484 RU

		Cable	Ant	Preamp	Read	Limit	Over		
	Freq	Loss	Factor	Factor	Level	Level	Line	Limit	
	MHz	dB	dB/m	dB	dBuV	dBuV/m	dBuV/m	dB	
1	5310.000	7.52	34.22	35.00	81.06	87.80	-----	-----	Average
2	5350.020	7.56	34.30	35.00	40.98	47.84	54.00	-6.16	Average
3 q	5382.312	7.59	34.43	35.00	41.54	48.56	54.00	-5.44	Average



Unless otherwise agreed in writing, this document is issued by the Company subject to its General Conditions of Service printed overleaf, available on request or accessible at <http://www.sgs.com/en/Terms-and-Conditions.aspx> and, for electronic format documents, subject to Terms and Conditions for Electronic Documents at <http://www.sgs.com/en/Terms-and-Conditions/Terms-e-Documents.aspx>. Attention is drawn to the limitation of liability, indemnification and jurisdiction issues defined therein. Any holder of this document is advised that information contained hereon reflects the Company's findings at the time of its intervention only and within the limits of Client's instructions, if any. The Company's sole responsibility is to its Client and this document does not exonerate parties to a transaction from exercising all their rights and obligations under the transaction documents. This document cannot be reproduced except in full, without prior written approval of the Company. Any unauthorized alteration, forgery or falsification of the content or appearance of this document is unlawful and offenders may be prosecuted to the fullest extent of the law. Unless otherwise stated the results shown in this test report refer only to the sample(s) tested and such sample(s) are retained for 30 days only.

Test Mode: 06; Polarity: Vertical; Modulation:802.11ax; Bandwidth:40MHz; Channel:High

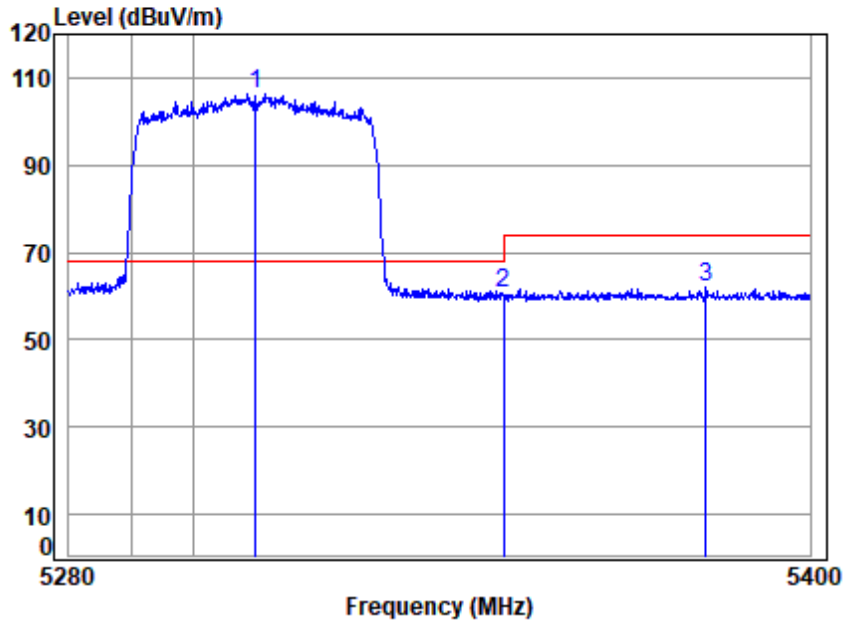

Site : chamber
 Condition: 3m VERTICAL
 Job No : 00750AT\00751AT
 Mode : 5310 Band edge
 : 5G WIFI 11AX40 484 RU

		Cable	Ant	Preamp	Read	Limit	Over	
Freq	Loss	Factor	Factor	Factor	Level	Level	Line	Limit
MHz	dB	dB/m	dB/m	dB	dBuV	dBuV/m	dBuV/m	dB
1 q 5310.000	7.52	34.22	35.00	99.68	106.42	68.20	38.22	Peak
2 5350.020	7.56	34.30	35.00	53.61	60.47	74.00	-13.53	Peak
3 5383.037	7.59	34.43	35.00	55.17	62.19	74.00	-11.81	Peak



Unless otherwise agreed in writing, this document is issued by the Company subject to its General Conditions of Service printed overleaf, available on request or accessible at <http://www.sgs.com/en/Terms-and-Conditions.aspx> and, for electronic format documents, subject to Terms and Conditions for Electronic Documents at <http://www.sgs.com/en/Terms-and-Conditions/Terms-e-Documents.aspx>. Attention is drawn to the limitation of liability, indemnification and jurisdiction issues defined therein. Any holder of this document is advised that information contained hereon reflects the Company's findings at the time of its intervention only and within the limits of Client's instructions, if any. The Company's sole responsibility is to its Client and this document does not exonerate parties to a transaction from exercising all their rights and obligations under the transaction documents. This document cannot be reproduced except in full, without prior written approval of the Company. Any unauthorized alteration, forgery or falsification of the content or appearance of this document is unlawful and offenders may be prosecuted to the fullest extent of the law. Unless otherwise stated the results shown in this test report refer only to the sample(s) tested and such sample(s) are retained for 30 days only.

Test Mode: 06; Polarity: Vertical; Modulation:802.11ax; Bandwidth:40MHz; Channel:High

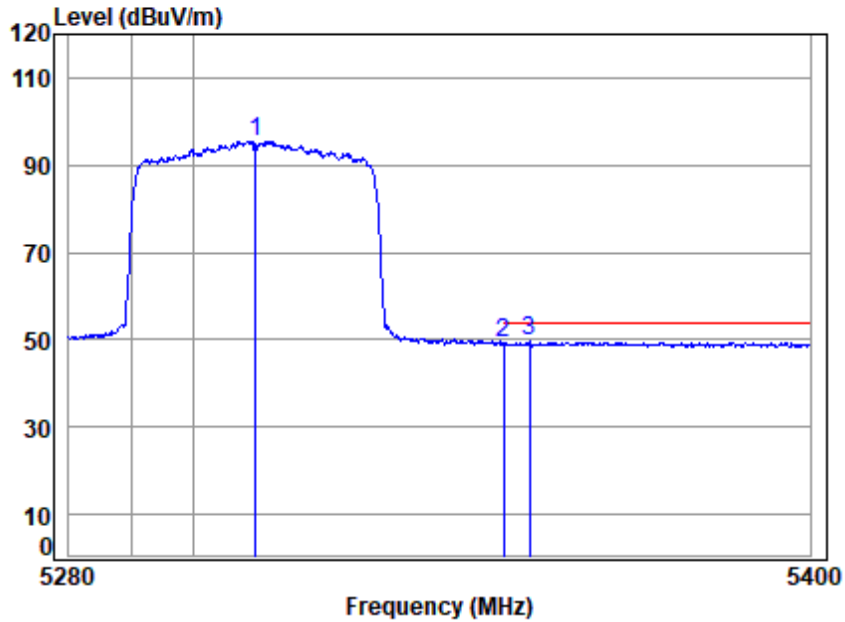

Site : chamber
 Condition: 3m VERTICAL
 Job No : 00750AT\00751AT
 Mode : 5310 Band edge
 : 5G WIFI 11AX40 484 RU

		Cable	Ant	Preamp	Read	Limit	Over		
Freq	Loss	Factor	Factor	Factor	Level	Level	Line	Limit	Remark
MHz	dB	dB/m	dB	dB	dBuV	dBuV/m	dBuV/m	dB	
1	5310.000	7.52	34.22	35.00	88.66	95.40	-----	-----	Average
2	5350.020	7.56	34.30	35.00	42.58	49.44	54.00	-4.56	Average
3 q	5354.202	7.57	34.32	35.00	42.73	49.62	54.00	-4.38	Average



Unless otherwise agreed in writing, this document is issued by the Company subject to its General Conditions of Service printed overleaf, available on request or accessible at <http://www.sgs.com/en/Terms-and-Conditions.aspx> and, for electronic format documents, subject to Terms and Conditions for Electronic Documents at <http://www.sgs.com/en/Terms-and-Conditions/Terms-e-Documents.aspx>. Attention is drawn to the limitation of liability, indemnification and jurisdiction issues defined therein. Any holder of this document is advised that information contained hereon reflects the Company's findings at the time of its intervention only and within the limits of Client's instructions, if any. The Company's sole responsibility is to its Client and this document does not exonerate parties to a transaction from exercising all their rights and obligations under the transaction documents. This document cannot be reproduced except in full, without prior written approval of the Company. Any unauthorized alteration, forgery or falsification of the content or appearance of this document is unlawful and offenders may be prosecuted to the fullest extent of the law. Unless otherwise stated the results shown in this test report refer only to the sample(s) tested and such sample(s) are retained for 30 days only.

Test Mode: 06; Polarity: Horizontal; Modulation:802.11ax; Bandwidth:80MHz; Channel:middle

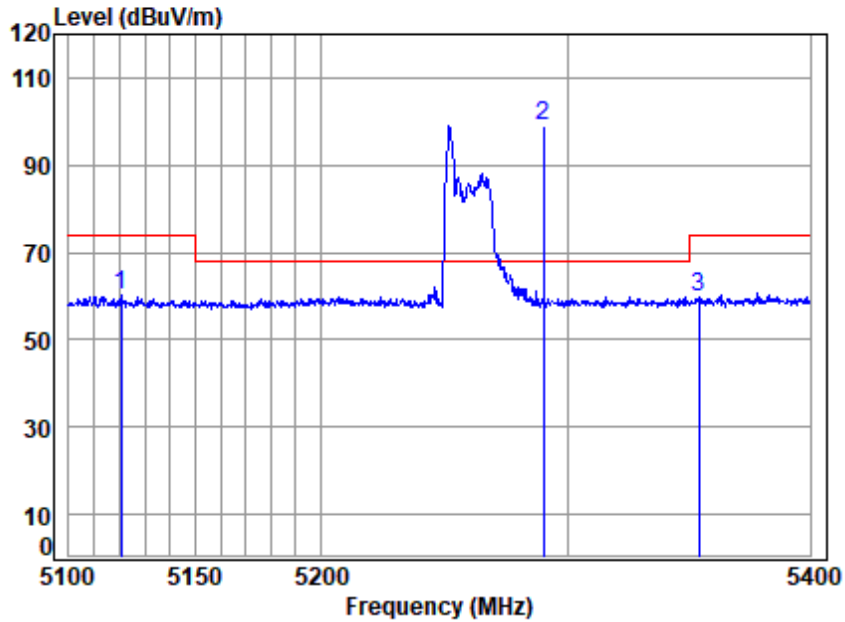

Site : chamber
 Condition: 3m HORIZONTAL
 Job No : 00750AT\00751AT
 Mode : 5290 Band edge
 : 5G WIFI 11AX80 26 RU

	Cable	Ant	Preamp	Read	Limit	Over		
Freq	Loss	Factor	Factor	Level	Level	Line	Limit	Remark
MHz	dB	dB/m	dB	dBuV	dBuV/m	dBuV/m	dB	
1	5120.739	7.33	34.06	34.99	53.98	60.38	74.00	-13.62 peak
2	5290.000	7.50	34.16	35.00	92.57	99.23	68.20	31.03 peak
3	5353.899	7.57	34.32	35.00	52.95	59.84	74.00	-14.16 peak



Unless otherwise agreed in writing, this document is issued by the Company subject to its General Conditions of Service printed overleaf, available on request or accessible at <http://www.sgs.com/en/Terms-and-Conditions.aspx> and, for electronic format documents, subject to Terms and Conditions for Electronic Documents at <http://www.sgs.com/en/Terms-and-Conditions/Terms-e-Documents.aspx>. Attention is drawn to the limitation of liability, indemnification and jurisdiction issues defined therein. Any holder of this document is advised that information contained hereon reflects the Company's findings at the time of its intervention only and within the limits of Client's instructions, if any. The Company's sole responsibility is to its Client and this document does not exonerate parties to a transaction from exercising all their rights and obligations under the transaction documents. This document cannot be reproduced except in full, without prior written approval of the Company. Any unauthorized alteration, forgery or falsification of the content or appearance of this document is unlawful and offenders may be prosecuted to the fullest extent of the law. Unless otherwise stated the results shown in this test report refer only to the sample(s) tested and such sample(s) are retained for 30 days only.

Test Mode: 06; Polarity: Horizontal; Modulation:802.11ax; Bandwidth:80MHz; Channel:middle

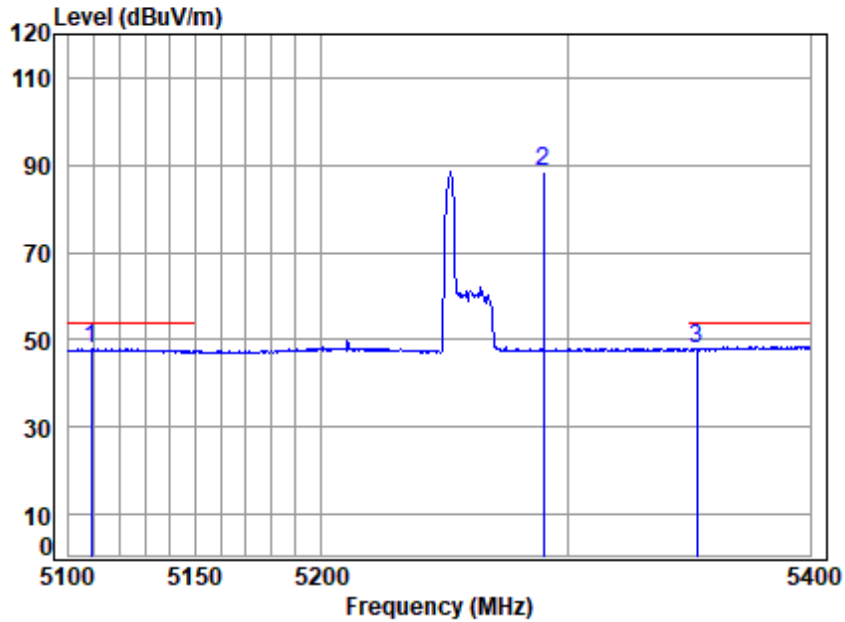

Site : chamber
 Condition: 3m HORIZONTAL
 Job No : 00750AT\00751AT
 Mode : 5290 Band edge
 : 5G WIFI 11AX80 26 RU

	Cable	Ant	Preamp	Read	Limit	Over		
Freq	Loss	Factor	Factor	Level	Level	Line	Limit	Remark
MHz	dB	dB/m	dB	dBuV	dBuV/m	dBuV/m	dB	
1 q 5108.753	7.32	34.08	34.99	41.71	48.12	54.00	-5.88	Average
2 5290.000	7.50	34.16	35.00	81.80	88.46	-----	-----	Average
3 5353.288	7.57	34.31	35.00	41.05	47.93	54.00	-6.07	Average



Unless otherwise agreed in writing, this document is issued by the Company subject to its General Conditions of Service printed overleaf, available on request or accessible at <http://www.sgs.com/en/Terms-and-Conditions.aspx> and, for electronic format documents, subject to Terms and Conditions for Electronic Documents at <http://www.sgs.com/en/Terms-and-Conditions/Terms-e-Documents.aspx>. Attention is drawn to the limitation of liability, indemnification and jurisdiction issues defined therein. Any holder of this document is advised that information contained hereon reflects the Company's findings at the time of its intervention only and within the limits of Client's instructions, if any. The Company's sole responsibility is to its Client and this document does not exonerate parties to a transaction from exercising all their rights and obligations under the transaction documents. This document cannot be reproduced except in full, without prior written approval of the Company. Any unauthorized alteration, forgery or falsification of the content or appearance of this document is unlawful and offenders may be prosecuted to the fullest extent of the law. Unless otherwise stated the results shown in this test report refer only to the sample(s) tested and such sample(s) are retained for 30 days only.
 Attention: To check the authenticity of testing /inspection report & certificate, please contact us at telephone: (86-755) 8307 1443, or email: CN.Doccheck@sgs.com

Test Mode: 06; Polarity: Vertical; Modulation:802.11ax; Bandwidth:80MHz; Channel:middle

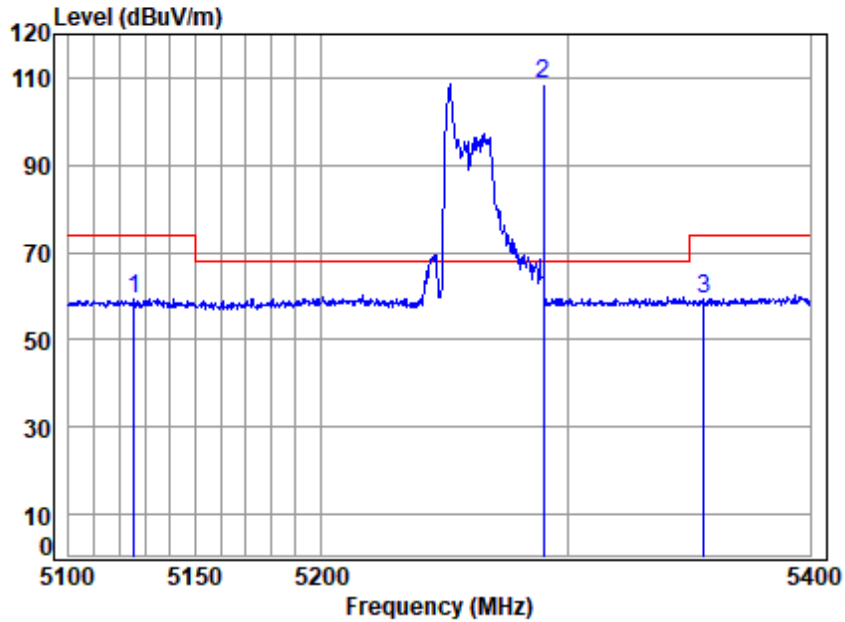

Site : chamber
 Condition: 3m VERTICAL
 Job No : 00750AT\00751AT
 Mode : 5290 Band edge
 : 5G WIFI 11AX80 26 RU

		Cable	Ant	Preamp	Read	Limit	Over	
Freq	Loss	Factor	Factor	Factor	Level	Line	Limit	Remark
MHz	dB	dB/m	dB	dB	dBuV	dBuV/m	dBuV/m	dB
1	5125.717	7.34	34.05	34.99	52.90	59.30	74.00	-14.70 Peak
2	5290.000	7.50	34.16	35.00	102.01	108.67	68.20	40.47 Peak
3	5356.042	7.57	34.32	35.00	52.49	59.38	74.00	-14.62 Peak



Unless otherwise agreed in writing, this document is issued by the Company subject to its General Conditions of Service printed overleaf, available on request or accessible at <http://www.sgs.com/en/Terms-and-Conditions.aspx> and, for electronic format documents, subject to Terms and Conditions for Electronic Documents at <http://www.sgs.com/en/Terms-and-Conditions/Terms-e-Documents.aspx>. Attention is drawn to the limitation of liability, indemnification and jurisdiction issues defined therein. Any holder of this document is advised that information contained hereon reflects the Company's findings at the time of its intervention only and within the limits of Client's instructions, if any. The Company's sole responsibility is to its Client and this document does not exonerate parties to a transaction from exercising all their rights and obligations under the transaction documents. This document cannot be reproduced except in full, without prior written approval of the Company. Any unauthorized alteration, forgery or falsification of the content or appearance of this document is unlawful and offenders may be prosecuted to the fullest extent of the law. Unless otherwise stated the results shown in this test report refer only to the sample(s) tested and such sample(s) are retained for 30 days only.

Test Mode: 06; Polarity: Vertical; Modulation:802.11ax; Bandwidth:80MHz; Channel:middle

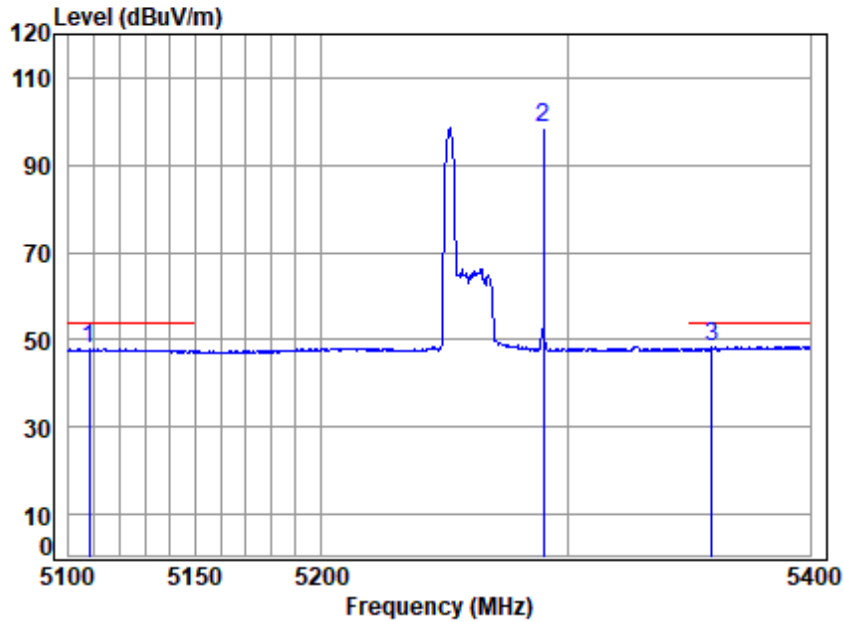

Site : chamber
 Condition: 3m VERTICAL
 Job No : 00750AT\00751AT
 Mode : 5290 Band edge
 : 5G WIFI 11AX80 26 RU

	Cable	Ant	Preamp	Read	Limit	Over		
Freq	Loss	Factor	Factor	Level	Level	Line	Limit	Remark
MHz	dB	dB/m	dB	dBuV	dBuV/m	dBuV/m	dB	
1	5108.169	7.32	34.08	34.99	41.56	47.97	54.00	-6.03 Average
2	5290.000	7.50	34.16	35.00	91.68	98.34	-----	----- Average
3 q	5359.411	7.57	34.34	35.00	41.49	48.40	54.00	-5.60 Average



Unless otherwise agreed in writing, this document is issued by the Company subject to its General Conditions of Service printed overleaf, available on request or accessible at <http://www.sgs.com/en/Terms-and-Conditions.aspx> and, for electronic format documents, subject to Terms and Conditions for Electronic Documents at <http://www.sgs.com/en/Terms-and-Conditions/Terms-e-Documents.aspx>. Attention is drawn to the limitation of liability, indemnification and jurisdiction issues defined therein. Any holder of this document is advised that information contained hereon reflects the Company's findings at the time of its intervention only and within the limits of Client's instructions, if any. The Company's sole responsibility is to its Client and this document does not exonerate parties to a transaction from exercising all their rights and obligations under the transaction documents. This document cannot be reproduced except in full, without prior written approval of the Company. Any unauthorized alteration, forgery or falsification of the content or appearance of this document is unlawful and offenders may be prosecuted to the fullest extent of the law. Unless otherwise stated the results shown in this test report refer only to the sample(s) tested and such sample(s) are retained for 30 days only.

Test Mode: 06; Polarity: Horizontal; Modulation:802.11ax; Bandwidth:80MHz; Channel:middle

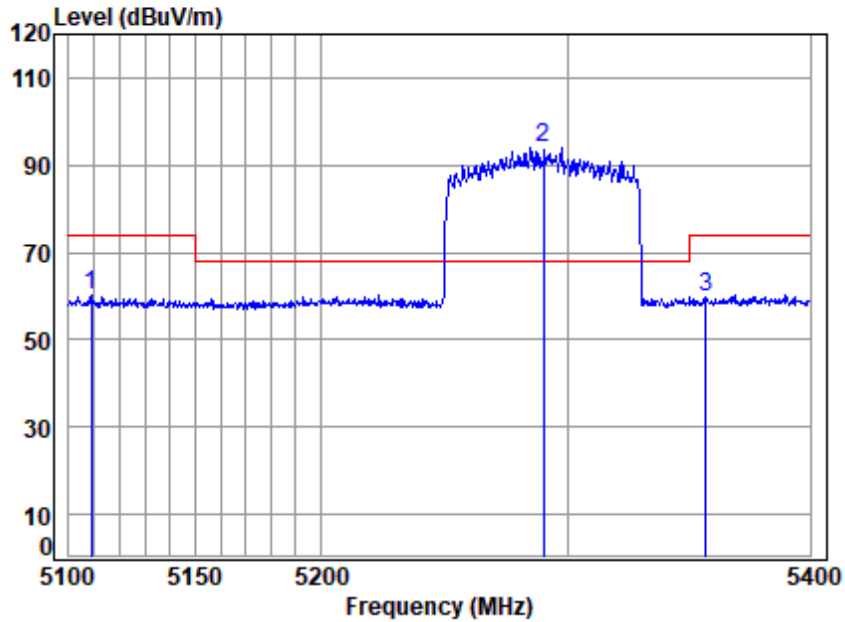

Site : chamber
 Condition: 3m HORIZONTAL
 Job No : 00750AT\00751AT
 Mode : 5290 Band edge
 : 5G WIFI 11AX80 996 RU

		Cable	Ant	Preamp	Read	Limit	Over	
	Freq	Loss	Factor	Factor	Level	Level	Line	Limit
	MHz	dB	dB/m	dB	dBuV	dBuV/m	dBuV/m	dB
1	5108.753	7.32	34.08	34.99	53.92	60.33	74.00	-13.67 peak
2 q	5290.000	7.50	34.16	35.00	87.35	94.01	68.20	25.81 peak
3	5356.654	7.57	34.33	35.00	52.77	59.67	74.00	-14.33 peak



Unless otherwise agreed in writing, this document is issued by the Company subject to its General Conditions of Service printed overleaf, available on request or accessible at <http://www.sgs.com/en/Terms-and-Conditions.aspx> and, for electronic format documents, subject to Terms and Conditions for Electronic Documents at <http://www.sgs.com/en/Terms-and-Conditions/Terms-e-Documents.aspx>. Attention is drawn to the limitation of liability, indemnification and jurisdiction issues defined therein. Any holder of this document is advised that information contained hereon reflects the Company's findings at the time of its intervention only and within the limits of Client's instructions, if any. The Company's sole responsibility is to its Client and this document does not exonerate parties to a transaction from exercising all their rights and obligations under the transaction documents. This document cannot be reproduced except in full, without prior written approval of the Company. Any unauthorized alteration, forgery or falsification of the content or appearance of this document is unlawful and offenders may be prosecuted to the fullest extent of the law. Unless otherwise stated the results shown in this test report refer only to the sample(s) tested and such sample(s) are retained for 30 days only.

Test Mode: 06; Polarity: Horizontal; Modulation:802.11ax; Bandwidth:80MHz; Channel:middle

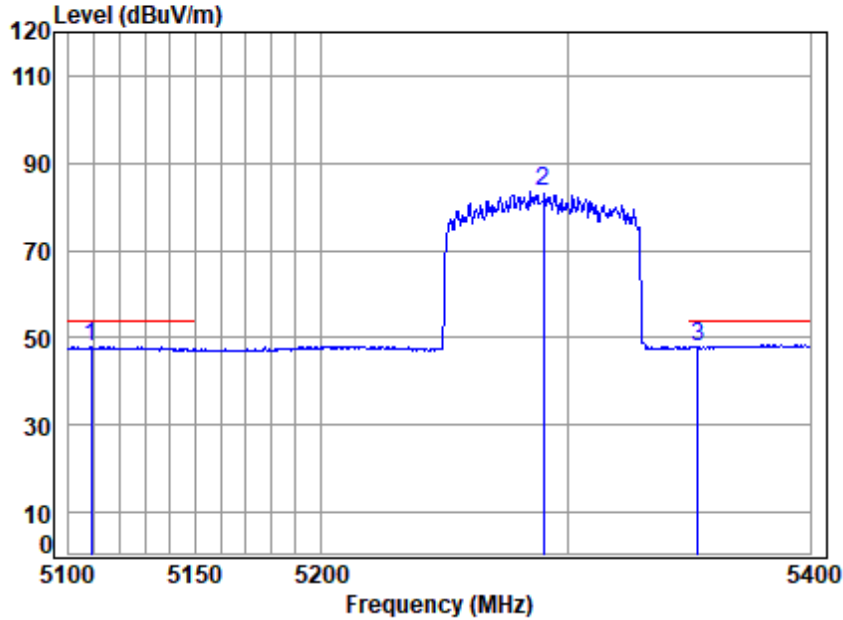

Site : chamber
 Condition: 3m HORIZONTAL
 Job No : 00750AT\00751AT
 Mode : 5290 Band edge
 : 5G WIFI 11AX80 996 RU

		Cable	Ant	Preamp	Read	Limit	Over		
Freq		Loss	Factor	Factor	Level	Line	Limit	Remark	
	MHz	dB	dB/m	dB	dBuV	dBuV/m	dBuV/m	dB	
1	5108.753	7.32	34.08	34.99	41.42	47.83	54.00	-6.17 Average	
2	5290.000	7.50	34.16	35.00	76.98	83.64	-----	----- Average	
3 q	5353.594	7.57	34.31	35.00	41.20	48.08	54.00	-5.92 Average	



Unless otherwise agreed in writing, this document is issued by the Company subject to its General Conditions of Service printed overleaf, available on request or accessible at <http://www.sgs.com/en/Terms-and-Conditions.aspx> and, for electronic format documents, subject to Terms and Conditions for Electronic Documents at <http://www.sgs.com/en/Terms-and-Conditions/Terms-e-Documents.aspx>. Attention is drawn to the limitation of liability, indemnification and jurisdiction issues defined therein. Any holder of this document is advised that information contained hereon reflects the Company's findings at the time of its intervention only and within the limits of Client's instructions, if any. The Company's sole responsibility is to its Client and this document does not exonerate parties to a transaction from exercising all their rights and obligations under the transaction documents. This document cannot be reproduced except in full, without prior written approval of the Company. Any unauthorized alteration, forgery or falsification of the content or appearance of this document is unlawful and offenders may be prosecuted to the fullest extent of the law. Unless otherwise stated the results shown in this test report refer only to the sample(s) tested and such sample(s) are retained for 30 days only.

Test Mode: 06; Polarity: Vertical; Modulation:802.11ax; Bandwidth:80MHz; Channel:middle

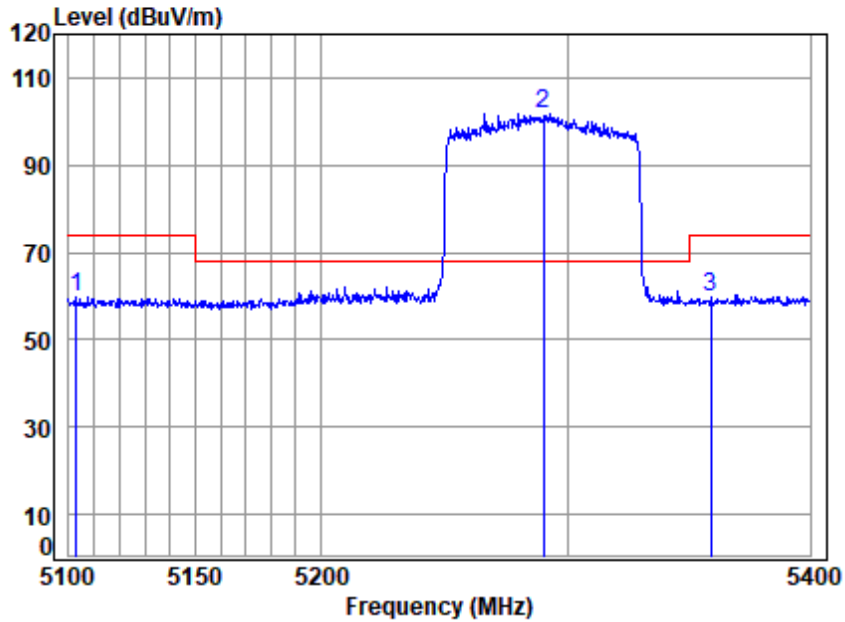

Site : chamber
 Condition: 3m VERTICAL
 Job No : 00750AT\00751AT
 Mode : 5290 Band edge
 : 5G WIFI 11AX80 996 RU

		Cable	Ant	Preamp	Read	Limit	Over	
	Freq	Loss	Factor	Factor	Level	Level	Line	Limit
	MHz	dB	dB/m	dB	dBuV	dBuV/m	dBuV/m	dB
1	5102.916	7.32	34.09	34.99	53.23	59.65	74.00	-14.35 Peak
2 q	5290.000	7.50	34.16	35.00	95.29	101.95	68.20	33.75 Peak
3	5358.798	7.57	34.34	35.00	52.79	59.70	74.00	-14.30 Peak



Unless otherwise agreed in writing, this document is issued by the Company subject to its General Conditions of Service printed overleaf, available on request or accessible at <http://www.sgs.com/en/Terms-and-Conditions.aspx> and, for electronic format documents, subject to Terms and Conditions for Electronic Documents at <http://www.sgs.com/en/Terms-and-Conditions/Terms-e-Documents.aspx>. Attention is drawn to the limitation of liability, indemnification and jurisdiction issues defined therein. Any holder of this document is advised that information contained hereon reflects the Company's findings at the time of its intervention only and within the limits of Client's instructions, if any. The Company's sole responsibility is to its Client and this document does not exonerate parties to a transaction from exercising all their rights and obligations under the transaction documents. This document cannot be reproduced except in full, without prior written approval of the Company. Any unauthorized alteration, forgery or falsification of the content or appearance of this document is unlawful and offenders may be prosecuted to the fullest extent of the law. Unless otherwise stated the results shown in this test report refer only to the sample(s) tested and such sample(s) are retained for 30 days only.

Test Mode: 06; Polarity: Vertical; Modulation:802.11ax; Bandwidth:80MHz; Channel:middle

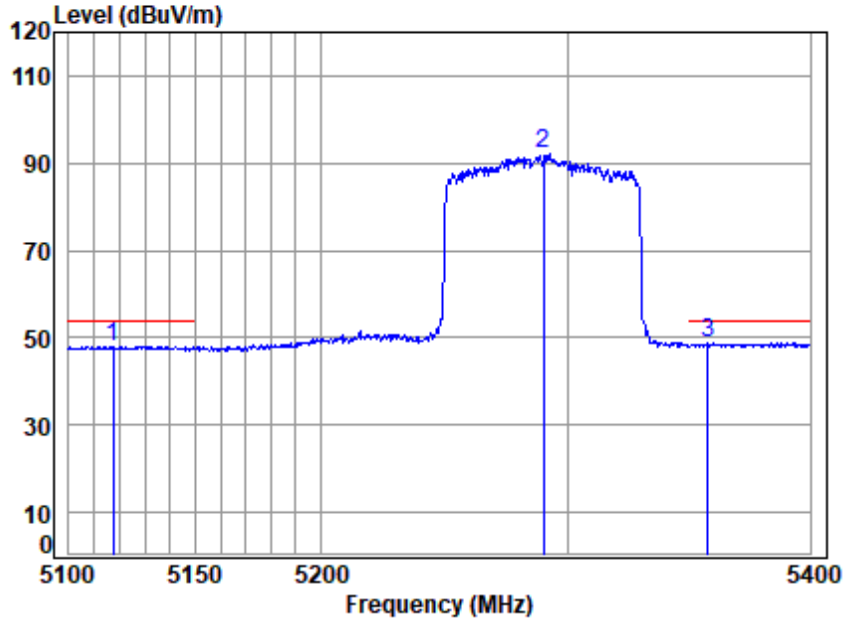

Site : chamber
 Condition: 3m VERTICAL
 Job No : 00750AT\00751AT
 Mode : 5290 Band edge
 : 5G WIFI 11AX80 996 RU

		Cable	Ant	Preamp	Read	Limit	Over	
Freq		Loss	Factor	Factor	Level	Line	Limit	Remark
	MHz	dB	dB/m	dB	dBuV	dBuV/m	dBuV/m	dB
1	5117.521	7.33	34.06	34.99	41.71	48.11	54.00	-5.89 Average
2	5290.000	7.50	34.16	35.00	85.63	92.29	-----	----- Average
3 q	5357.573	7.57	34.33	35.00	41.82	48.72	54.00	-5.28 Average



Unless otherwise agreed in writing, this document is issued by the Company subject to its General Conditions of Service printed overleaf, available on request or accessible at <http://www.sgs.com/en/Terms-and-Conditions.aspx> and, for electronic format documents, subject to Terms and Conditions for Electronic Documents at <http://www.sgs.com/en/Terms-and-Conditions/Terms-e-Documents.aspx>. Attention is drawn to the limitation of liability, indemnification and jurisdiction issues defined therein. Any holder of this document is advised that information contained hereon reflects the Company's findings at the time of its intervention only and within the limits of Client's instructions, if any. The Company's sole responsibility is to its Client and this document does not exonerate parties to a transaction from exercising all their rights and obligations under the transaction documents. This document cannot be reproduced except in full, without prior written approval of the Company. Any unauthorized alteration, forgery or falsification of the content or appearance of this document is unlawful and offenders may be prosecuted to the fullest extent of the law. Unless otherwise stated the results shown in this test report refer only to the sample(s) tested and such sample(s) are retained for 30 days only.

Test Mode: 07; Polarity: Horizontal; Modulation:802.11a; Bandwidth:20MHz; Channel:Low

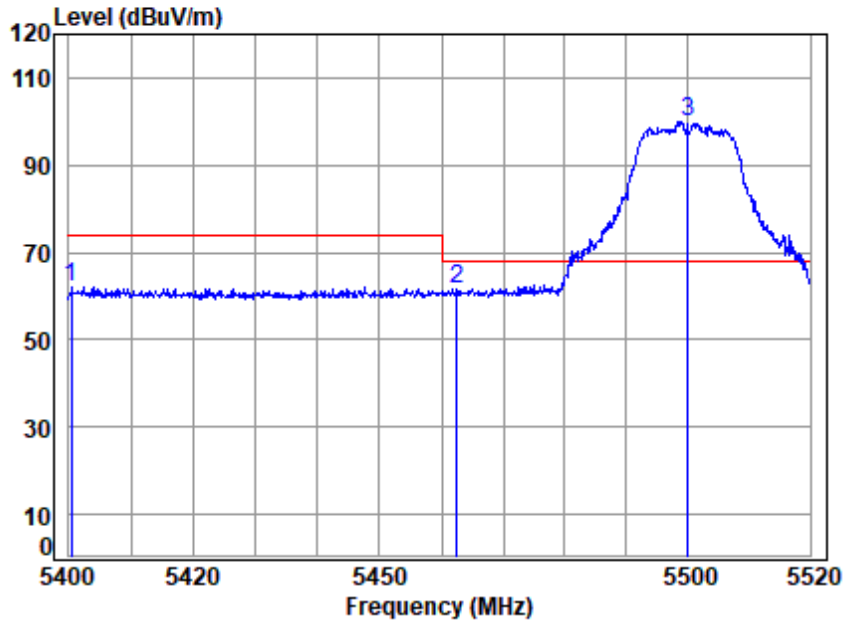

Site : chamber
 Condition: 3m HORIZONTAL
 Job No : 00750AT\00751AT
 Mode : 5500 Band edge
 : 5G WIFI 11A

		Cable	Ant	Preamp	Read	Limit	Over	
	Freq	Loss	Factor	Factor	Level	Level	Line	Limit
	MHz	dB	dB/m	dB	dBuV	dBuV/m	dBuV/m	dB
1	5400.475	7.61	34.50	35.01	54.90	62.00	74.00	-12.00 peak
2	5462.431	7.67	34.60	35.01	54.39	61.65	68.20	-6.55 peak
3 q	5500.000	7.71	34.60	35.01	92.61	99.91	68.20	31.71 peak



Unless otherwise agreed in writing, this document is issued by the Company subject to its General Conditions of Service printed overleaf, available on request or accessible at <http://www.sgs.com/en/Terms-and-Conditions.aspx> and, for electronic format documents, subject to Terms and Conditions for Electronic Documents at <http://www.sgs.com/en/Terms-and-Conditions/Terms-e-Documents.aspx>. Attention is drawn to the limitation of liability, indemnification and jurisdiction issues defined therein. Any holder of this document is advised that information contained hereon reflects the Company's findings at the time of its intervention only and within the limits of Client's instructions, if any. The Company's sole responsibility is to its Client and this document does not exonerate parties to a transaction from exercising all their rights and obligations under the transaction documents. This document cannot be reproduced except in full, without prior written approval of the Company. Any unauthorized alteration, forgery or falsification of the content or appearance of this document is unlawful and offenders may be prosecuted to the fullest extent of the law. Unless otherwise stated the results shown in this test report refer only to the sample(s) tested and such sample(s) are retained for 30 days only.

Test Mode: 07; Polarity: Horizontal; Modulation:802.11a; Bandwidth:20MHz; Channel:Low

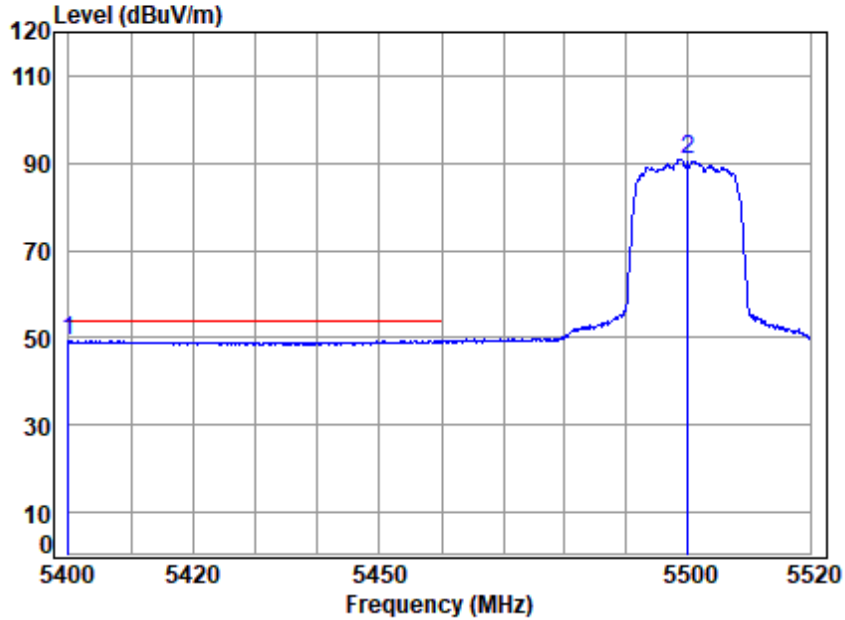

Site : chamber
 Condition: 3m HORIZONTAL
 Job No : 00750AT\00751AT
 Mode : 5500 Band edge
 : 5G WIFI 11A

	Freq	Cable Loss	Ant Factor	Preamp Factor	Read Level	Limit	Over	Remark
	MHz	dB	dB/m	dB	dBuV	dBuV/m	dB	
1 q	5400.000	7.61	34.50	35.01	42.26	54.00	-4.64	Average
2	5500.000	7.71	34.60	35.01	83.68	-----	-----	Average



Unless otherwise agreed in writing, this document is issued by the Company subject to its General Conditions of Service printed overleaf, available on request or accessible at <http://www.sgs.com/en/Terms-and-Conditions.aspx> and, for electronic format documents, subject to Terms and Conditions for Electronic Documents at <http://www.sgs.com/en/Terms-and-Conditions/Terms-e-Documents.aspx>. Attention is drawn to the limitation of liability, indemnification and jurisdiction issues defined therein. Any holder of this document is advised that information contained hereon reflects the Company's findings at the time of its intervention only and within the limits of Client's instructions, if any. The Company's sole responsibility is to its Client and this document does not exonerate parties to a transaction from exercising all their rights and obligations under the transaction documents. This document cannot be reproduced except in full, without prior written approval of the Company. Any unauthorized alteration, forgery or falsification of the content or appearance of this document is unlawful and offenders may be prosecuted to the fullest extent of the law. Unless otherwise stated the results shown in this test report refer only to the sample(s) tested and such sample(s) are retained for 30 days only.
 Attention: To check the authenticity of testing /inspection report & certificate, please contact us at telephone: (86-755) 8307 1443, or email: CN.Doccheck@sgs.com

Test Mode: 07; Polarity: Vertical; Modulation:802.11a; Bandwidth:20MHz; Channel:Low

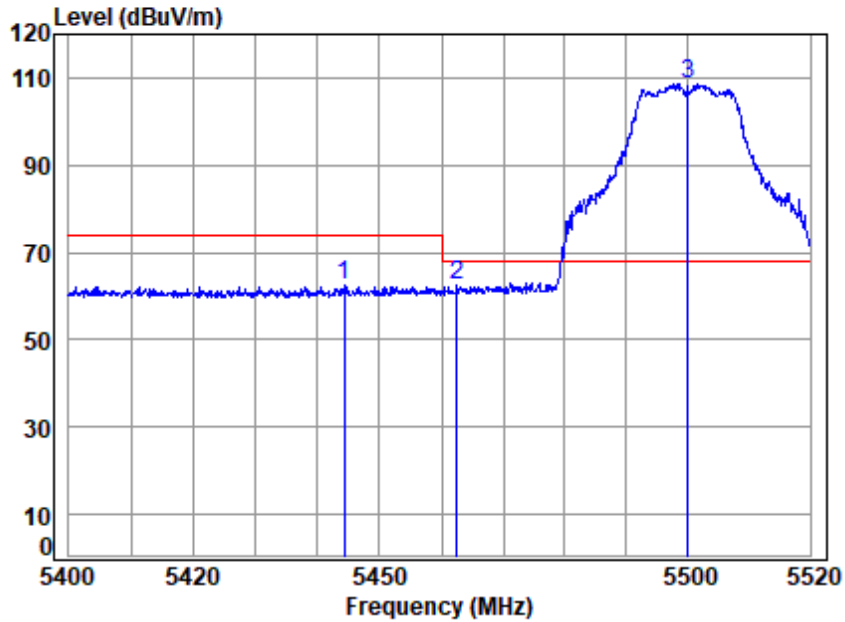

Site : chamber
 Condition: 3m VERTICAL
 Job No : 00750AT\00751AT
 Mode : 5500 Band edge
 : 5G WIFI 11A

		Cable	Ant	Preamp	Read	Limit	Over	
	Freq	Loss	Factor	Factor	Level	Level	Line	Limit Remark
	MHz	dB	dB/m	dB	dBuV	dBuV/m	dBuV/m	dB
1	5444.332	7.65	34.59	35.01	55.24	62.47	74.00	-11.53 Peak
2	5462.551	7.67	34.60	35.01	55.32	62.58	68.20	-5.62 peak
3 q	5500.000	7.71	34.60	35.01	101.41	108.71	68.20	40.51 Peak



Unless otherwise agreed in writing, this document is issued by the Company subject to its General Conditions of Service printed overleaf, available on request or accessible at <http://www.sgs.com/en/Terms-and-Conditions.aspx> and, for electronic format documents, subject to Terms and Conditions for Electronic Documents at <http://www.sgs.com/en/Terms-and-Conditions/Terms-e-Documents.aspx>. Attention is drawn to the limitation of liability, indemnification and jurisdiction issues defined therein. Any holder of this document is advised that information contained hereon reflects the Company's findings at the time of its intervention only and within the limits of Client's instructions, if any. The Company's sole responsibility is to its Client and this document does not exonerate parties to a transaction from exercising all their rights and obligations under the transaction documents. This document cannot be reproduced except in full, without prior written approval of the Company. Any unauthorized alteration, forgery or falsification of the content or appearance of this document is unlawful and offenders may be prosecuted to the fullest extent of the law. Unless otherwise stated the results shown in this test report refer only to the sample(s) tested and such sample(s) are retained for 30 days only.

Test Mode: 07; Polarity: Vertical; Modulation:802.11a; Bandwidth:20MHz; Channel:Low

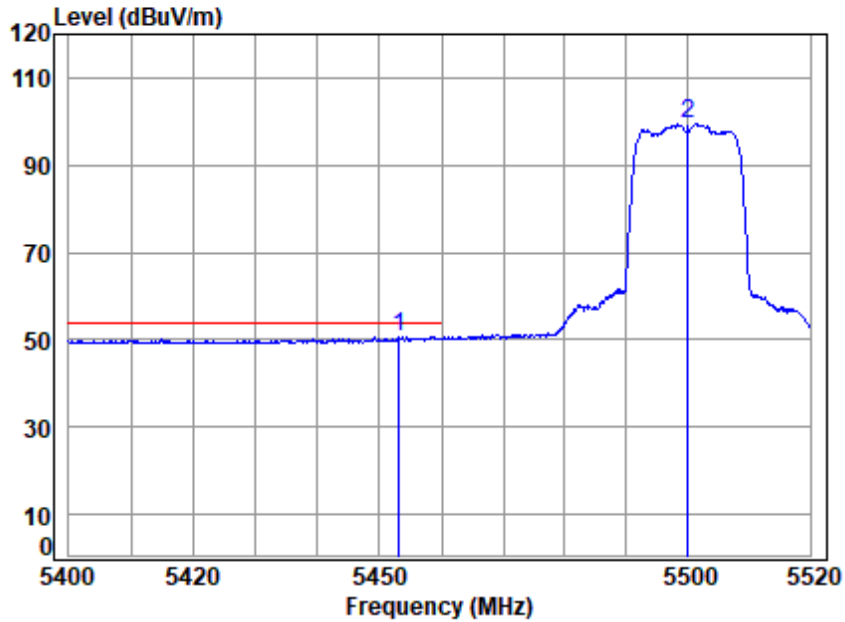

Site : chamber
 Condition: 3m VERTICAL
 Job No : 00750AT\00751AT
 Mode : 5500 Band edge
 : 5G WIFI 11A

		Cable	Ant	Preamp	Read	Limit	Over		
1	2	Loss	Factor	Factor	Level	Level	Line	Limit	Remark
MHz	dB	dB/m	dB	dBuV	dBuV/m	dBuV/m	dB		
1 q 5453.194	7.66	34.60	35.01	43.53	50.78	54.00	-3.22	Average	
2 5500.000	7.71	34.60	35.01	92.21	99.51	-----	-----	Average	



Unless otherwise agreed in writing, this document is issued by the Company subject to its General Conditions of Service printed overleaf, available on request or accessible at <http://www.sgs.com/en/Terms-and-Conditions.aspx> and, for electronic format documents, subject to Terms and Conditions for Electronic Documents at <http://www.sgs.com/en/Terms-and-Conditions/Terms-e-Documents.aspx>. Attention is drawn to the limitation of liability, indemnification and jurisdiction issues defined therein. Any holder of this document is advised that information contained hereon reflects the Company's findings at the time of its intervention only and within the limits of Client's instructions, if any. The Company's sole responsibility is to its Client and this document does not exonerate parties to a transaction from exercising all their rights and obligations under the transaction documents. This document cannot be reproduced except in full, without prior written approval of the Company. Any unauthorized alteration, forgery or falsification of the content or appearance of this document is unlawful and offenders may be prosecuted to the fullest extent of the law. Unless otherwise stated the results shown in this test report refer only to the sample(s) tested and such sample(s) are retained for 30 days only.
 Attention: To check the authenticity of testing /inspection report & certificate, please contact us at telephone: (86-755) 8307 1443, or email: CN.Doccheck@sgs.com

Test Mode: 07; Polarity: Horizontal; Modulation:802.11a; Bandwidth:20MHz; Channel:High

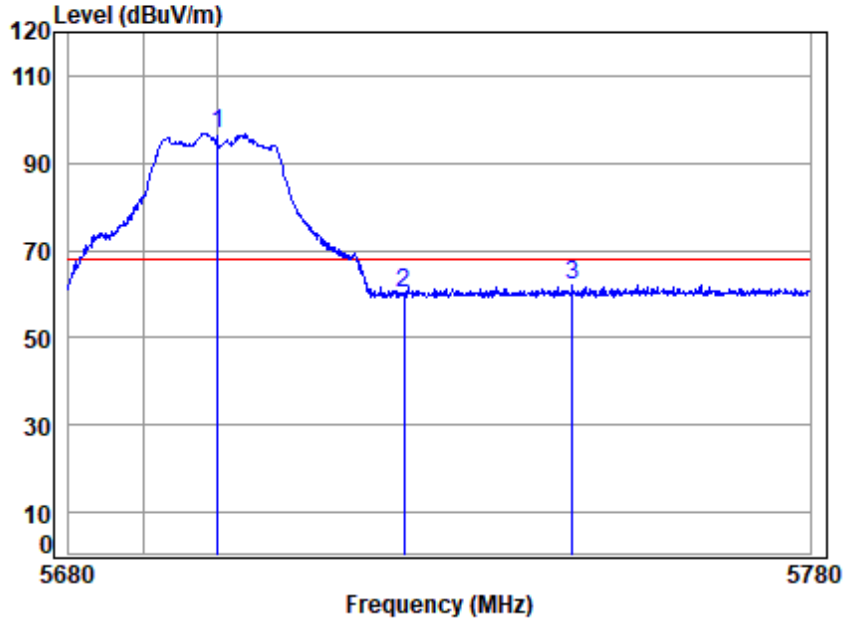

Site : chamber
 Condition: 3m HORIZONTAL
 Job No : 00750AT\00751AT
 Mode : 5700 Band edge
 : 5G WIFI 11A

	Freq	Cable Loss	Ant Factor	Preamp Factor	Read Level	Level	Limit	Over	Remark
	MHz	dB	dB/m	dB	dBuV	dBuV/m	dBuV/m	dB	
1	q 5700.000	7.89	34.50	35.02	89.51	96.88	68.20	28.68	peak
2	5725.000	7.92	34.50	35.02	52.99	60.39	68.20	-7.81	peak
3	5747.810	7.94	34.50	35.03	54.57	61.98	68.20	-6.22	peak



Unless otherwise agreed in writing, this document is issued by the Company subject to its General Conditions of Service printed overleaf, available on request or accessible at <http://www.sgs.com/en/Terms-and-Conditions.aspx> and, for electronic format documents, subject to Terms and Conditions for Electronic Documents at <http://www.sgs.com/en/Terms-and-Conditions/Terms-e-Documents.aspx>. Attention is drawn to the limitation of liability, indemnification and jurisdiction issues defined therein. Any holder of this document is advised that information contained hereon reflects the Company's findings at the time of its intervention only and within the limits of Client's instructions, if any. The Company's sole responsibility is to its Client and this document does not exonerate parties to a transaction from exercising all their rights and obligations under the transaction documents. This document cannot be reproduced except in full, without prior written approval of the Company. Any unauthorized alteration, forgery or falsification of the content or appearance of this document is unlawful and offenders may be prosecuted to the fullest extent of the law. Unless otherwise stated the results shown in this test report refer only to the sample(s) tested and such sample(s) are retained for 30 days only.

Test Mode: 07; Polarity: Vertical; Modulation:802.11a; Bandwidth:20MHz; Channel:High

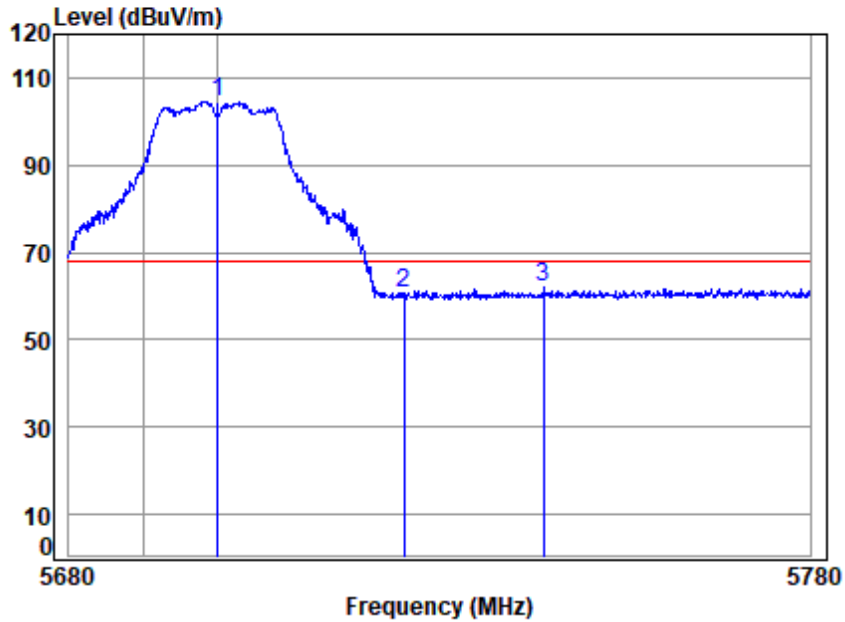

Site : chamber
 Condition: 3m VERTICAL
 Job No : 00750AT\00751AT
 Mode : 5700 Band edge
 : 5G WIFI 11A

		Cable	Ant	Preamp	Read	Limit	Over	
Freq		Loss	Factor	Factor	Level	Line	Limit	Remark
	MHz	dB	dB/m	dB	dBuV	dBuV/m	dBuV/m	dB
1	q 5700.000	7.89	34.50	35.02	97.28	104.65	68.20	36.45 Peak
2	5725.000	7.92	34.50	35.02	53.43	60.83	68.20	-7.37 Peak
3	5743.799	7.93	34.50	35.03	54.75	62.15	68.20	-6.05 Peak



Unless otherwise agreed in writing, this document is issued by the Company subject to its General Conditions of Service printed overleaf, available on request or accessible at <http://www.sgs.com/en/Terms-and-Conditions.aspx> and, for electronic format documents, subject to Terms and Conditions for Electronic Documents at <http://www.sgs.com/en/Terms-and-Conditions/Terms-e-Documents.aspx>. Attention is drawn to the limitation of liability, indemnification and jurisdiction issues defined therein. Any holder of this document is advised that information contained hereon reflects the Company's findings at the time of its intervention only and within the limits of Client's instructions, if any. The Company's sole responsibility is to its Client and this document does not exonerate parties to a transaction from exercising all their rights and obligations under the transaction documents. This document cannot be reproduced except in full, without prior written approval of the Company. Any unauthorized alteration, forgery or falsification of the content or appearance of this document is unlawful and offenders may be prosecuted to the fullest extent of the law. Unless otherwise stated the results shown in this test report refer only to the sample(s) tested and such sample(s) are retained for 30 days only.

Test Mode: 07; Polarity: Horizontal; Modulation:802.11n; Bandwidth:20MHz; Channel:Low

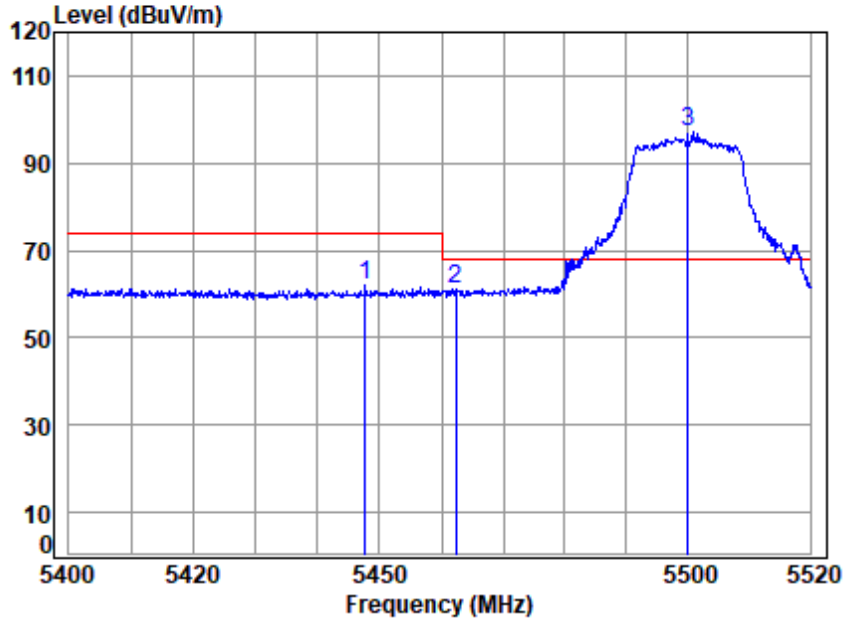

Site : chamber
 Condition: 3m HORIZONTAL
 Job No : 00750AT\00751AT
 Mode : 5500 Band edge
 : 5G WIFI 11N20

		Cable	Ant	Preamp	Read	Limit	Over	
	Freq	Loss	Factor	Factor	Level	Level	Line	Limit
	MHz	dB	dB/m	dB	dBuV	dBuV/m	dBuV/m	dB
1	5447.684	7.66	34.60	35.01	54.64	61.89	74.00	-12.11 peak
2	5462.311	7.67	34.60	35.01	54.09	61.35	68.20	-6.85 peak
3 q	5500.000	7.71	34.60	35.01	89.72	97.02	68.20	28.82 peak



Unless otherwise agreed in writing, this document is issued by the Company subject to its General Conditions of Service printed overleaf, available on request or accessible at <http://www.sgs.com/en/Terms-and-Conditions.aspx> and, for electronic format documents, subject to Terms and Conditions for Electronic Documents at <http://www.sgs.com/en/Terms-and-Conditions/Terms-e-Documents.aspx>. Attention is drawn to the limitation of liability, indemnification and jurisdiction issues defined therein. Any holder of this document is advised that information contained hereon reflects the Company's findings at the time of its intervention only and within the limits of Client's instructions, if any. The Company's sole responsibility is to its Client and this document does not exonerate parties to a transaction from exercising all their rights and obligations under the transaction documents. This document cannot be reproduced except in full, without prior written approval of the Company. Any unauthorized alteration, forgery or falsification of the content or appearance of this document is unlawful and offenders may be prosecuted to the fullest extent of the law. Unless otherwise stated the results shown in this test report refer only to the sample(s) tested and such sample(s) are retained for 30 days only.

Test Mode: 07; Polarity: Horizontal; Modulation:802.11n; Bandwidth:20MHz; Channel:Low

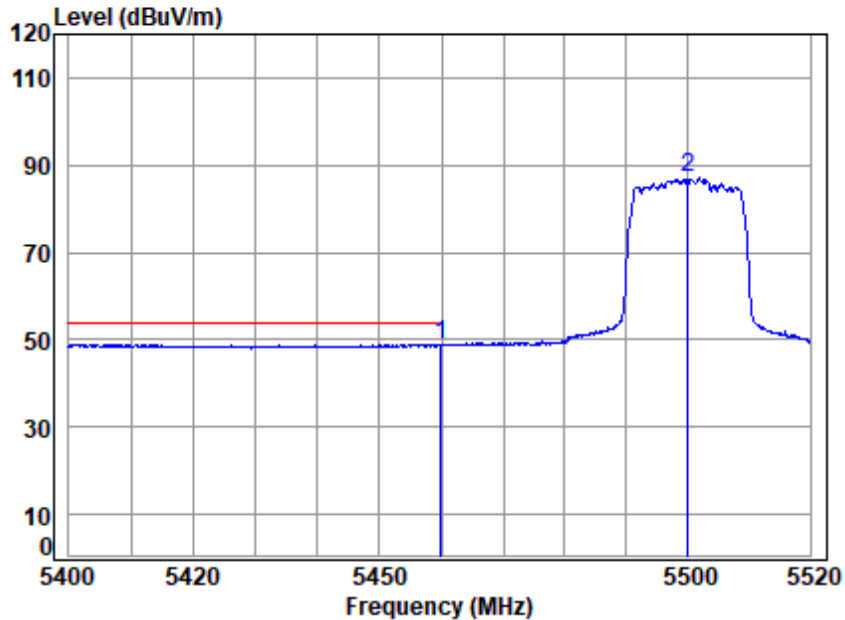

Site : chamber
 Condition: 3m HORIZONTAL
 Job No : 00750AT\00751AT
 Mode : 5500 Band edge
 : 5G WIFI 11N20

		Cable	Ant	Preamp	Read	Limit	Over		
Freq		Loss	Factor	Factor	Level	Level	Line	Limit	Remark
	MHz	dB	dB/m	dB	dBuV	dBuV/m	dBuV/m	dB	
1 q	5459.910	7.67	34.60	35.01	41.77	49.03	54.00	-4.97	Average
2	5500.000	7.71	34.60	35.01	79.64	86.94	-----	-----	Average



Unless otherwise agreed in writing, this document is issued by the Company subject to its General Conditions of Service printed overleaf, available on request or accessible at <http://www.sgs.com/en/Terms-and-Conditions.aspx> and, for electronic format documents, subject to Terms and Conditions for Electronic Documents at <http://www.sgs.com/en/Terms-and-Conditions/Terms-e-Documents.aspx>. Attention is drawn to the limitation of liability, indemnification and jurisdiction issues defined therein. Any holder of this document is advised that information contained hereon reflects the Company's findings at the time of its intervention only and within the limits of Client's instructions, if any. The Company's sole responsibility is to its Client and this document does not exonerate parties to a transaction from exercising all their rights and obligations under the transaction documents. This document cannot be reproduced except in full, without prior written approval of the Company. Any unauthorized alteration, forgery or falsification of the content or appearance of this document is unlawful and offenders may be prosecuted to the fullest extent of the law. Unless otherwise stated the results shown in this test report refer only to the sample(s) tested and such sample(s) are retained for 30 days only.

Test Mode: 07; Polarity: Vertical; Modulation:802.11n; Bandwidth:20MHz; Channel:Low

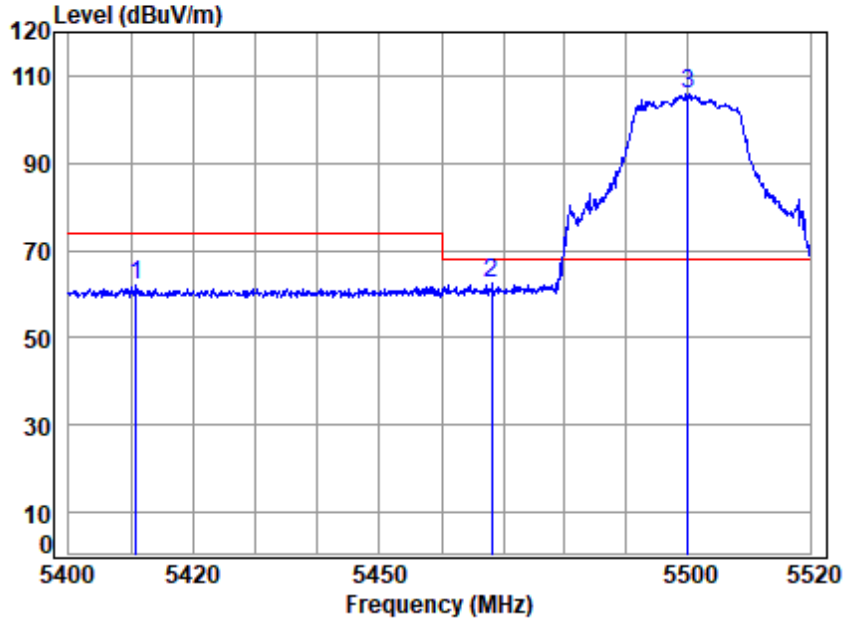

Site : chamber
 Condition: 3m VERTICAL
 Job No : 00750AT\00751AT
 Mode : 5500 Band edge
 : 5G WIFI 11N20

		Cable	Ant	Preamp	Read	Limit	Over	
	Freq	Loss	Factor	Factor	Level	Level	Line	Limit
	MHz	dB	dB/m	dB	dBuV	dBuV/m	dBuV/m	dB
1	5410.811	7.62	34.52	35.01	54.96	62.09	74.00	-11.91 Peak
2	5468.197	7.68	34.60	35.01	55.01	62.28	68.20	-5.92 peak
3 q	5500.000	7.71	34.60	35.01	98.45	105.75	68.20	37.55 Peak



Unless otherwise agreed in writing, this document is issued by the Company subject to its General Conditions of Service printed overleaf, available on request or accessible at <http://www.sgs.com/en/Terms-and-Conditions.aspx> and, for electronic format documents, subject to Terms and Conditions for Electronic Documents at <http://www.sgs.com/en/Terms-and-Conditions/Terms-e-Documents.aspx>. Attention is drawn to the limitation of liability, indemnification and jurisdiction issues defined therein. Any holder of this document is advised that information contained hereon reflects the Company's findings at the time of its intervention only and within the limits of Client's instructions, if any. The Company's sole responsibility is to its Client and this document does not exonerate parties to a transaction from exercising all their rights and obligations under the transaction documents. This document cannot be reproduced except in full, without prior written approval of the Company. Any unauthorized alteration, forgery or falsification of the content or appearance of this document is unlawful and offenders may be prosecuted to the fullest extent of the law. Unless otherwise stated the results shown in this test report refer only to the sample(s) tested and such sample(s) are retained for 30 days only.

Test Mode: 07; Polarity: Vertical; Modulation:802.11n; Bandwidth:20MHz; Channel:Low

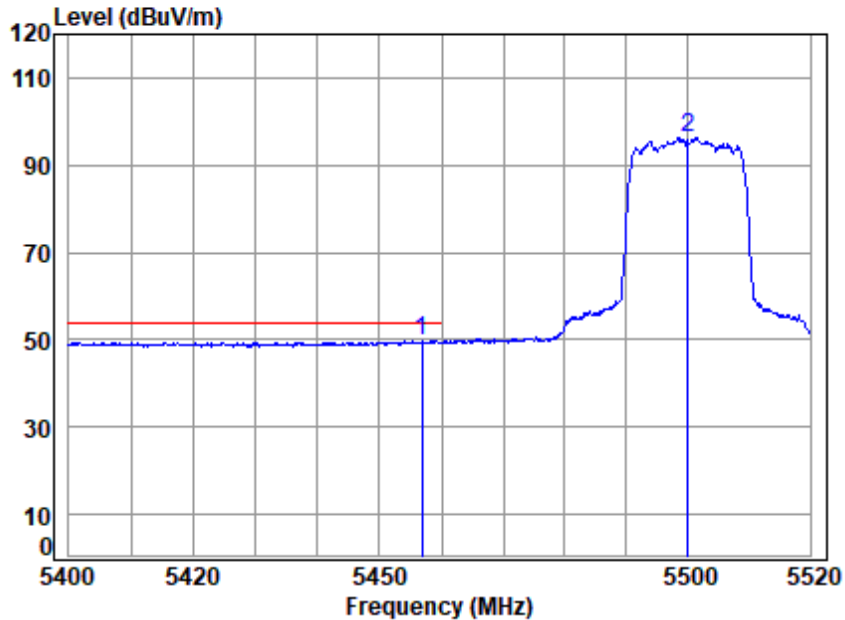

Site : chamber
 Condition: 3m VERTICAL
 Job No : 00750AT\00751AT
 Mode : 5500 Band edge
 : 5G WIFI 11N20

	Cable	Ant	Preamp	Read	Limit	Over		
Freq	Loss	Factor	Factor	Level	Level	Line	Limit	Remark
MHz	dB	dB/m	dB	dBuV	dBuV/m	dBuV/m	dB	
1 q 5456.791	7.67	34.60	35.01	42.45	49.71	54.00	-4.29	Average
2 5500.000	7.71	34.60	35.01	89.11	96.41	-----	-----	Average



Unless otherwise agreed in writing, this document is issued by the Company subject to its General Conditions of Service printed overleaf, available on request or accessible at <http://www.sgs.com/en/Terms-and-Conditions.aspx> and, for electronic format documents, subject to Terms and Conditions for Electronic Documents at <http://www.sgs.com/en/Terms-and-Conditions/Terms-e-Documents.aspx>. Attention is drawn to the limitation of liability, indemnification and jurisdiction issues defined therein. Any holder of this document is advised that information contained hereon reflects the Company's findings at the time of its intervention only and within the limits of Client's instructions, if any. The Company's sole responsibility is to its Client and this document does not exonerate parties to a transaction from exercising all their rights and obligations under the transaction documents. This document cannot be reproduced except in full, without prior written approval of the Company. Any unauthorized alteration, forgery or falsification of the content or appearance of this document is unlawful and offenders may be prosecuted to the fullest extent of the law. Unless otherwise stated the results shown in this test report refer only to the sample(s) tested and such sample(s) are retained for 30 days only.
 Attention: To check the authenticity of testing /inspection report & certificate, please contact us at telephone: (86-755) 8307 1443, or email: CN.Doccheck@sgs.com

Test Mode: 07; Polarity: Horizontal; Modulation:802.11n; Bandwidth:20MHz; Channel:High

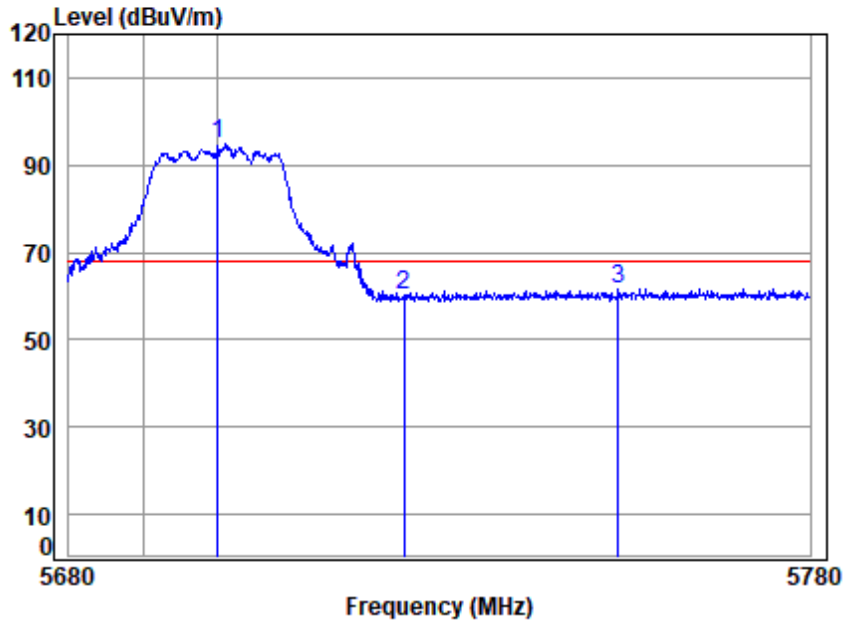

Site : chamber
 Condition: 3m HORIZONTAL
 Job No : 00750AT\00751AT
 Mode : 5700 Band edge
 : 5G WIFI 11N20

		Cable	Ant	Preamp	Read	Limit	Over	
Freq		Loss	Factor	Factor	Level	Line	Limit	Remark
	MHz	dB	dB/m	dB	dBuV	dBuV/m	dBuV/m	dB
1 q	5700.000	7.89	34.50	35.02	87.47	94.84	68.20	26.64 peak
2	5725.000	7.92	34.50	35.02	53.05	60.45	68.20	-7.75 peak
3	5753.932	7.94	34.51	35.03	54.12	61.54	68.20	-6.66 peak



Unless otherwise agreed in writing, this document is issued by the Company subject to its General Conditions of Service printed overleaf, available on request or accessible at <http://www.sgs.com/en/Terms-and-Conditions.aspx> and, for electronic format documents, subject to Terms and Conditions for Electronic Documents at <http://www.sgs.com/en/Terms-and-Conditions/Terms-e-Documents.aspx>. Attention is drawn to the limitation of liability, indemnification and jurisdiction issues defined therein. Any holder of this document is advised that information contained hereon reflects the Company's findings at the time of its intervention only and within the limits of Client's instructions, if any. The Company's sole responsibility is to its Client and this document does not exonerate parties to a transaction from exercising all their rights and obligations under the transaction documents. This document cannot be reproduced except in full, without prior written approval of the Company. Any unauthorized alteration, forgery or falsification of the content or appearance of this document is unlawful and offenders may be prosecuted to the fullest extent of the law. Unless otherwise stated the results shown in this test report refer only to the sample(s) tested and such sample(s) are retained for 30 days only.

Test Mode: 07; Polarity: Vertical; Modulation:802.11n; Bandwidth:20MHz; Channel:High

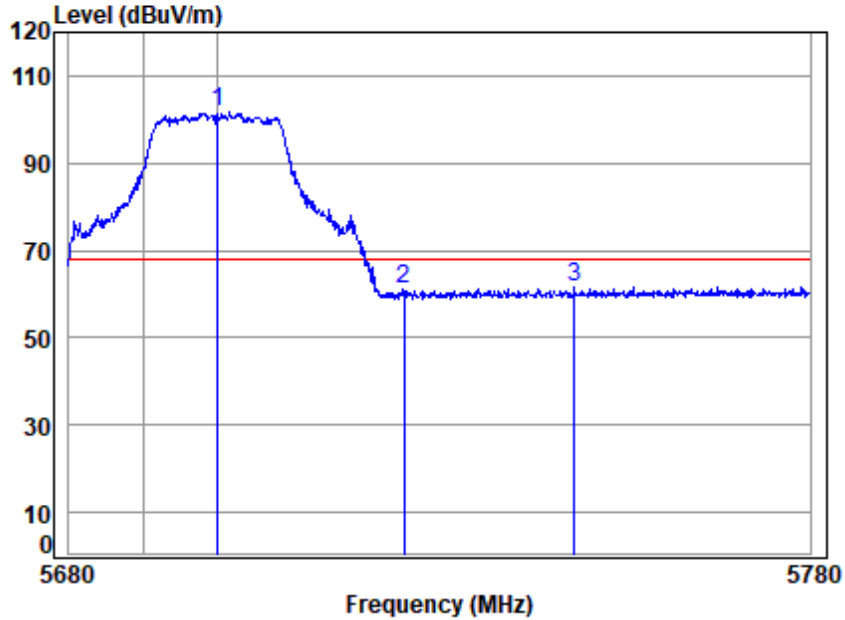

Site : chamber
 Condition: 3m VERTICAL
 Job No : 00750AT\00751AT
 Mode : 5700 Band edge
 : 5G WIFI 11N20

		Cable	Ant	Preamp	Read	Limit	Over	
Freq		Loss	Factor	Factor	Level	Line	Limit	Remark
	MHz	dB	dB/m	dB	dBuV	dBuV/m	dBuV/m	dB
1 q	5700.000	7.89	34.50	35.02	94.42	101.79	68.20	33.59 Peak
2	5725.000	7.92	34.50	35.02	53.75	61.15	68.20	-7.05 Peak
3	5748.011	7.94	34.50	35.03	54.40	61.81	68.20	-6.39 Peak



Unless otherwise agreed in writing, this document is issued by the Company subject to its General Conditions of Service printed overleaf, available on request or accessible at <http://www.sgs.com/en/Terms-and-Conditions.aspx> and, for electronic format documents, subject to Terms and Conditions for Electronic Documents at <http://www.sgs.com/en/Terms-and-Conditions/Terms-e-Documents.aspx>. Attention is drawn to the limitation of liability, indemnification and jurisdiction issues defined therein. Any holder of this document is advised that information contained hereon reflects the Company's findings at the time of its intervention only and within the limits of Client's instructions, if any. The Company's sole responsibility is to its Client and this document does not exonerate parties to a transaction from exercising all their rights and obligations under the transaction documents. This document cannot be reproduced except in full, without prior written approval of the Company. Any unauthorized alteration, forgery or falsification of the content or appearance of this document is unlawful and offenders may be prosecuted to the fullest extent of the law. Unless otherwise stated the results shown in this test report refer only to the sample(s) tested and such sample(s) are retained for 30 days only.

Test Mode: 07; Polarity: Horizontal; Modulation:802.11n; Bandwidth:40MHz; Channel:Low

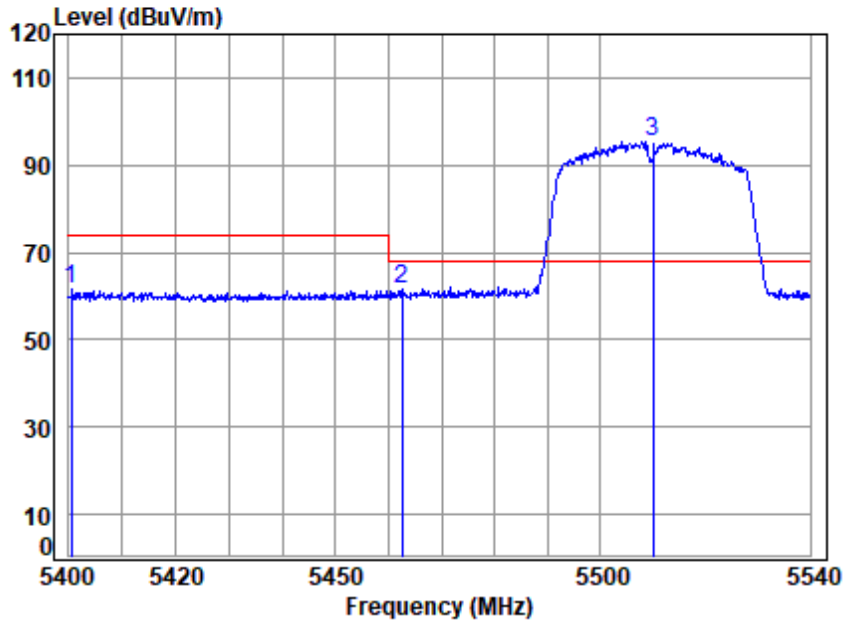

Site : chamber
 Condition: 3m HORIZONTAL
 Job No : 00750AT\00751AT
 Mode : 5510 Band edge
 : 5G WIFI 11N40

		Cable	Ant	Preamp	Read	Limit	Over	
	Freq	Loss	Factor	Factor	Level	Level	Line	Limit
	MHz	dB	dB/m	dB	dBuV	dBuV/m	dBuV/m	dB
1	5400.553	7.61	34.50	35.01	54.52	61.62	74.00	-12.38 peak
2	5462.557	7.67	34.60	35.01	54.45	61.71	68.20	-6.49 peak
3 q	5510.000	7.72	34.60	35.01	88.22	95.53	68.20	27.33 peak



Unless otherwise agreed in writing, this document is issued by the Company subject to its General Conditions of Service printed overleaf, available on request or accessible at <http://www.sgs.com/en/Terms-and-Conditions.aspx> and, for electronic format documents, subject to Terms and Conditions for Electronic Documents at <http://www.sgs.com/en/Terms-and-Conditions/Terms-e-Documents.aspx>. Attention is drawn to the limitation of liability, indemnification and jurisdiction issues defined therein. Any holder of this document is advised that information contained hereon reflects the Company's findings at the time of its intervention only and within the limits of Client's instructions, if any. The Company's sole responsibility is to its Client and this document does not exonerate parties to a transaction from exercising all their rights and obligations under the transaction documents. This document cannot be reproduced except in full, without prior written approval of the Company. Any unauthorized alteration, forgery or falsification of the content or appearance of this document is unlawful and offenders may be prosecuted to the fullest extent of the law. Unless otherwise stated the results shown in this test report refer only to the sample(s) tested and such sample(s) are retained for 30 days only.

Test Mode: 07; Polarity: Horizontal; Modulation:802.11n; Bandwidth:40MHz; Channel:Low

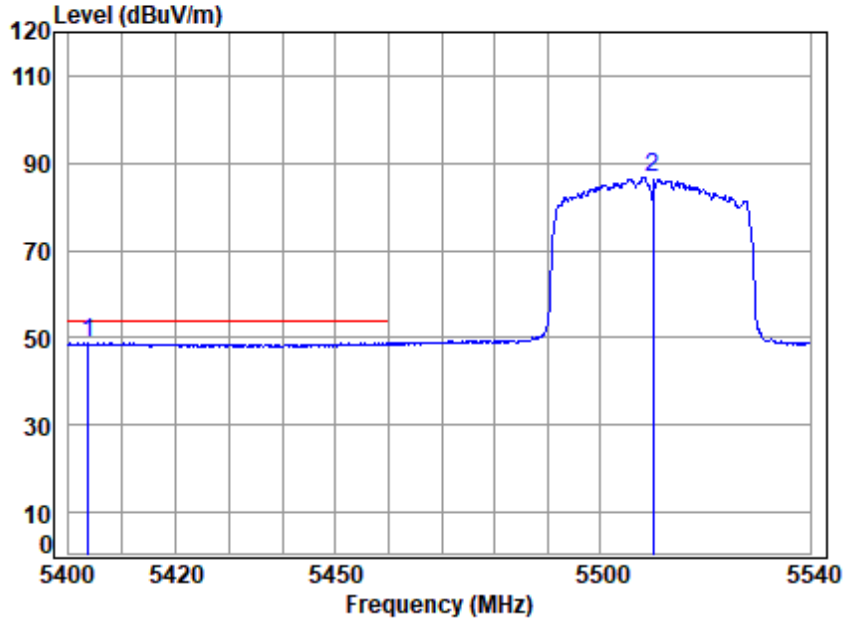

Site : chamber
 Condition: 3m HORIZONTAL
 Job No : 00750AT\00751AT
 Mode : 5510 Band edge
 : 5G WIFI 11N40

	Freq	Cable Loss	Ant Factor	Preamp Factor	Read Level	Limit Level	Over Limit	Remark
	MHz	dB	dB/m	dB	dBuV	dBuV/m	dBuV/m	dB
1 q	5403.595	7.61	34.51	35.01	41.90	49.01	54.00	-4.99 Average
2	5510.000	7.72	34.60	35.01	79.49	86.80	-----	----- Average



Unless otherwise agreed in writing, this document is issued by the Company subject to its General Conditions of Service printed overleaf, available on request or accessible at <http://www.sgs.com/en/Terms-and-Conditions.aspx> and, for electronic format documents, subject to Terms and Conditions for Electronic Documents at <http://www.sgs.com/en/Terms-and-Conditions/Terms-e-Documents.aspx>. Attention is drawn to the limitation of liability, indemnification and jurisdiction issues defined therein. Any holder of this document is advised that information contained hereon reflects the Company's findings at the time of its intervention only and within the limits of Client's instructions, if any. The Company's sole responsibility is to its Client and this document does not exonerate parties to a transaction from exercising all their rights and obligations under the transaction documents. This document cannot be reproduced except in full, without prior written approval of the Company. Any unauthorized alteration, forgery or falsification of the content or appearance of this document is unlawful and offenders may be prosecuted to the fullest extent of the law. Unless otherwise stated the results shown in this test report refer only to the sample(s) tested and such sample(s) are retained for 30 days only.
 Attention: To check the authenticity of testing /inspection report & certificate, please contact us at telephone: (86-755) 8307 1443, or email: CN.Doccheck@sgs.com

Test Mode: 07; Polarity: Vertical; Modulation:802.11n; Bandwidth:40MHz; Channel:Low

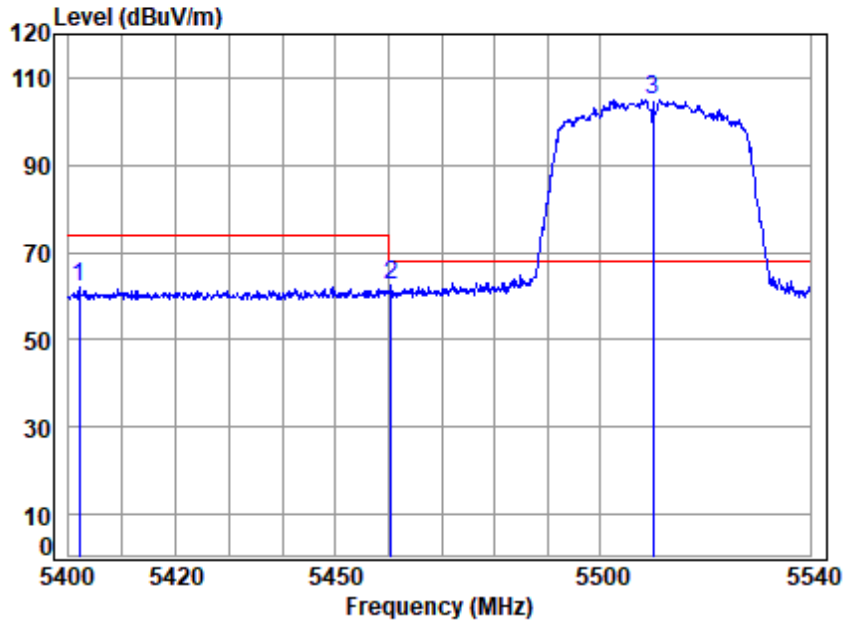

Site : chamber
 Condition: 3m VERTICAL
 Job No : 00750AT\00751AT
 Mode : 5510 Band edge
 : 5G WIFI 11N40

		Cable	Ant	Preamp	Read	Limit	Over	
	Freq	Loss	Factor	Factor	Level	Level	Line	Limit
	MHz	dB	dB/m	dB	dBuV	dBuV/m	dBuV/m	dB
1	5401.936	7.61	34.50	35.01	54.99	62.09	74.00	-11.91 Peak
2	5460.460	7.67	34.60	35.01	55.12	62.38	68.20	-5.82 peak
3 q	5510.000	7.72	34.60	35.01	97.61	104.92	68.20	36.72 Peak



Unless otherwise agreed in writing, this document is issued by the Company subject to its General Conditions of Service printed overleaf, available on request or accessible at <http://www.sgs.com/en/Terms-and-Conditions.aspx> and, for electronic format documents, subject to Terms and Conditions for Electronic Documents at <http://www.sgs.com/en/Terms-and-Conditions/Terms-e-Documents.aspx>. Attention is drawn to the limitation of liability, indemnification and jurisdiction issues defined therein. Any holder of this document is advised that information contained hereon reflects the Company's findings at the time of its intervention only and within the limits of Client's instructions, if any. The Company's sole responsibility is to its Client and this document does not exonerate parties to a transaction from exercising all their rights and obligations under the transaction documents. This document cannot be reproduced except in full, without prior written approval of the Company. Any unauthorized alteration, forgery or falsification of the content or appearance of this document is unlawful and offenders may be prosecuted to the fullest extent of the law. Unless otherwise stated the results shown in this test report refer only to the sample(s) tested and such sample(s) are retained for 30 days only.

Test Mode: 07; Polarity: Vertical; Modulation:802.11n; Bandwidth:40MHz; Channel:Low

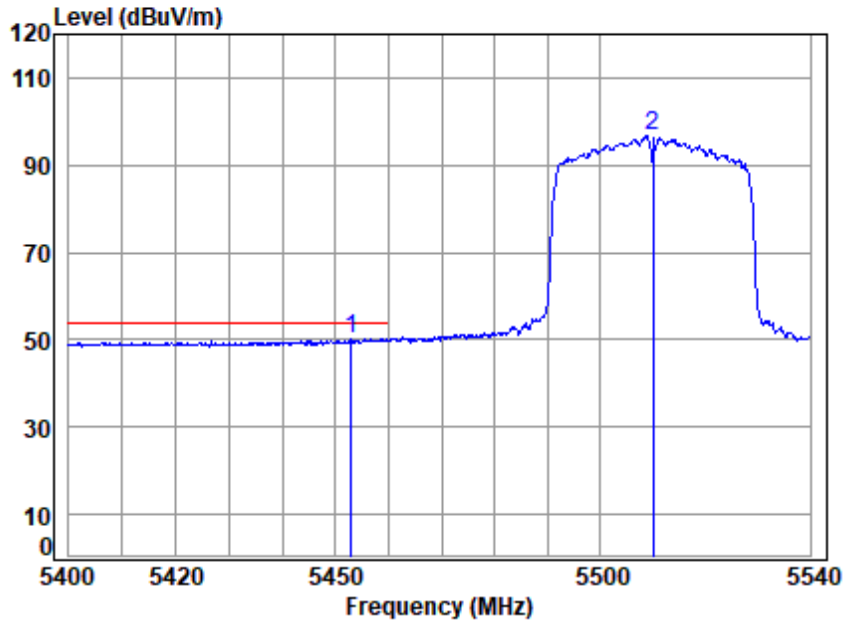

Site : chamber
 Condition: 3m VERTICAL
 Job No : 00750AT\00751AT
 Mode : 5510 Band edge
 : 5G WIFI 11N40

		Cable	Ant	Preamp	Read	Limit	Over		
1	2	Loss	Factor	Factor	Level	Level	Line	Limit	Remark
MHz	dB	dB/m	dB	dBuV	dBuV/m	dBuV/m	dB		
1 q 5452.918	7.66	34.60	35.01	42.94	50.19	54.00	-3.81	Average	
2 5510.000	7.72	34.60	35.01	89.30	96.61	-----	-----	Average	



Unless otherwise agreed in writing, this document is issued by the Company subject to its General Conditions of Service printed overleaf, available on request or accessible at <http://www.sgs.com/en/Terms-and-Conditions.aspx> and, for electronic format documents, subject to Terms and Conditions for Electronic Documents at <http://www.sgs.com/en/Terms-and-Conditions/Terms-e-Documents.aspx>. Attention is drawn to the limitation of liability, indemnification and jurisdiction issues defined therein. Any holder of this document is advised that information contained hereon reflects the Company's findings at the time of its intervention only and within the limits of Client's instructions, if any. The Company's sole responsibility is to its Client and this document does not exonerate parties to a transaction from exercising all their rights and obligations under the transaction documents. This document cannot be reproduced except in full, without prior written approval of the Company. Any unauthorized alteration, forgery or falsification of the content or appearance of this document is unlawful and offenders may be prosecuted to the fullest extent of the law. Unless otherwise stated the results shown in this test report refer only to the sample(s) tested and such sample(s) are retained for 30 days only.

Test Mode: 07; Polarity: Horizontal; Modulation:802.11n; Bandwidth:40MHz; Channel:High

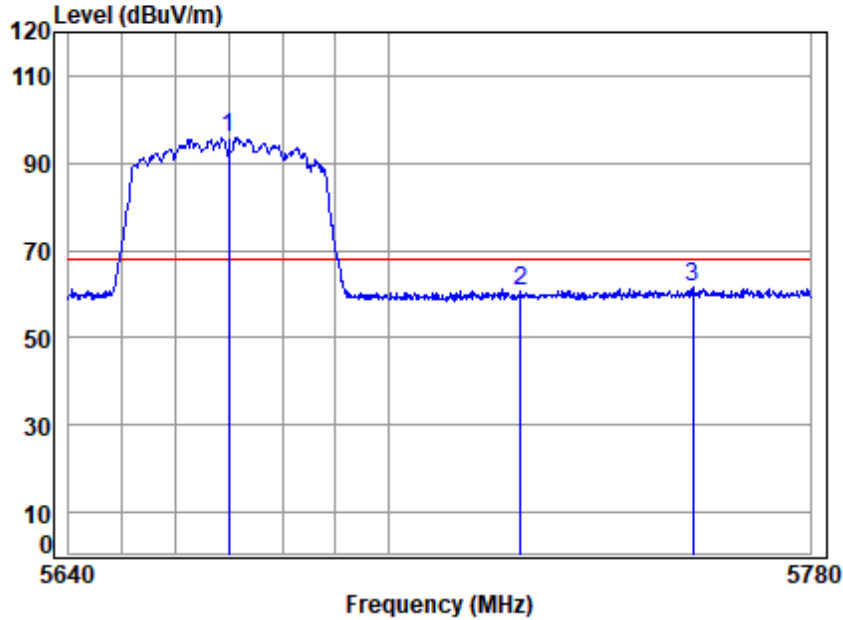

Site : chamber
 Condition: 3m HORIZONTAL
 Job No : 00750AT\00751AT
 Mode : 5670 Band edge
 : 5G WIFI 11N40

		Cable	Ant	Preamp	Read	Limit	Over	
Freq		Loss	Factor	Factor	Level	Line	Limit	Remark
	MHz	dB	dB/m	dB	dBuV	dBuV/m	dBuV/m	dB
1 q	5670.000	7.87	34.50	35.02	88.69	96.04	68.20	27.84 peak
2	5725.000	7.92	34.50	35.02	53.16	60.56	68.20	-7.64 peak
3	5757.651	7.95	34.52	35.03	53.98	61.42	68.20	-6.78 peak



Unless otherwise agreed in writing, this document is issued by the Company subject to its General Conditions of Service printed overleaf, available on request or accessible at <http://www.sgs.com/en/Terms-and-Conditions.aspx> and, for electronic format documents, subject to Terms and Conditions for Electronic Documents at <http://www.sgs.com/en/Terms-and-Conditions/Terms-e-Documents.aspx>. Attention is drawn to the limitation of liability, indemnification and jurisdiction issues defined therein. Any holder of this document is advised that information contained hereon reflects the Company's findings at the time of its intervention only and within the limits of Client's instructions, if any. The Company's sole responsibility is to its Client and this document does not exonerate parties to a transaction from exercising all their rights and obligations under the transaction documents. This document cannot be reproduced except in full, without prior written approval of the Company. Any unauthorized alteration, forgery or falsification of the content or appearance of this document is unlawful and offenders may be prosecuted to the fullest extent of the law. Unless otherwise stated the results shown in this test report refer only to the sample(s) tested and such sample(s) are retained for 30 days only.

Test Mode: 07; Polarity: Vertical; Modulation:802.11n; Bandwidth:40MHz; Channel:High

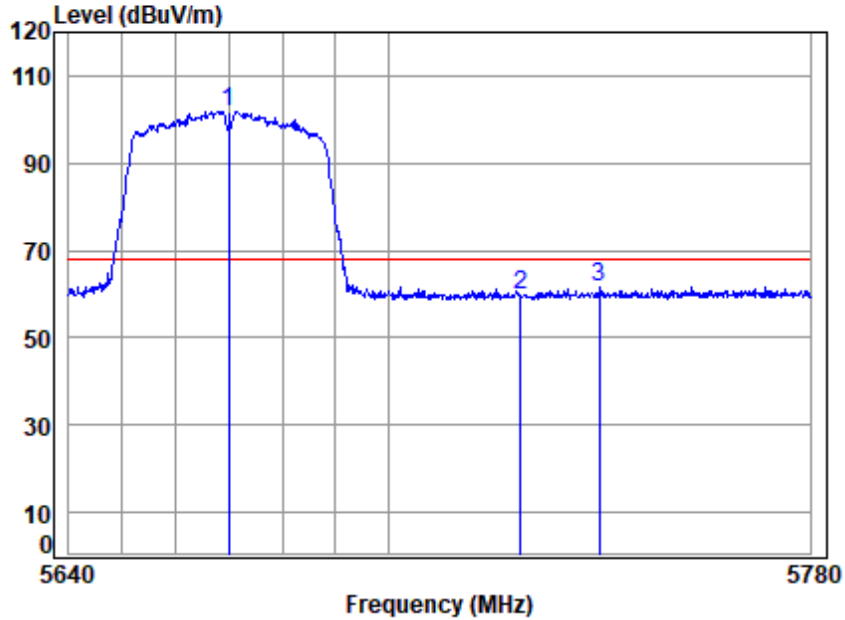

Site : chamber
 Condition: 3m VERTICAL
 Job No : 00750AT\00751AT
 Mode : 5670 Band edge
 : 5G WIFI 11N40

		Cable	Ant	Preamp	Read	Limit	Over	
	Freq	Loss	Factor	Factor	Level	Line	Limit	Remark
	MHz	dB	dB/m	dB	dBuV	dBuV/m	dBuV/m	dB
1	q 5670.000	7.87	34.50	35.02	94.45	101.80	68.20	33.60 Peak
2	5725.000	7.92	34.50	35.02	52.40	59.80	68.20	-8.40 Peak
3	5739.750	7.93	34.50	35.03	54.28	61.68	68.20	-6.52 Peak



Unless otherwise agreed in writing, this document is issued by the Company subject to its General Conditions of Service printed overleaf, available on request or accessible at <http://www.sgs.com/en/Terms-and-Conditions.aspx> and, for electronic format documents, subject to Terms and Conditions for Electronic Documents at <http://www.sgs.com/en/Terms-and-Conditions/Terms-e-Documents.aspx>. Attention is drawn to the limitation of liability, indemnification and jurisdiction issues defined therein. Any holder of this document is advised that information contained hereon reflects the Company's findings at the time of its intervention only and within the limits of Client's instructions, if any. The Company's sole responsibility is to its Client and this document does not exonerate parties to a transaction from exercising all their rights and obligations under the transaction documents. This document cannot be reproduced except in full, without prior written approval of the Company. Any unauthorized alteration, forgery or falsification of the content or appearance of this document is unlawful and offenders may be prosecuted to the fullest extent of the law. Unless otherwise stated the results shown in this test report refer only to the sample(s) tested and such sample(s) are retained for 30 days only.

Test Mode: 07; Polarity: Horizontal; Modulation:802.11ac; Bandwidth:20MHz; Channel:Low

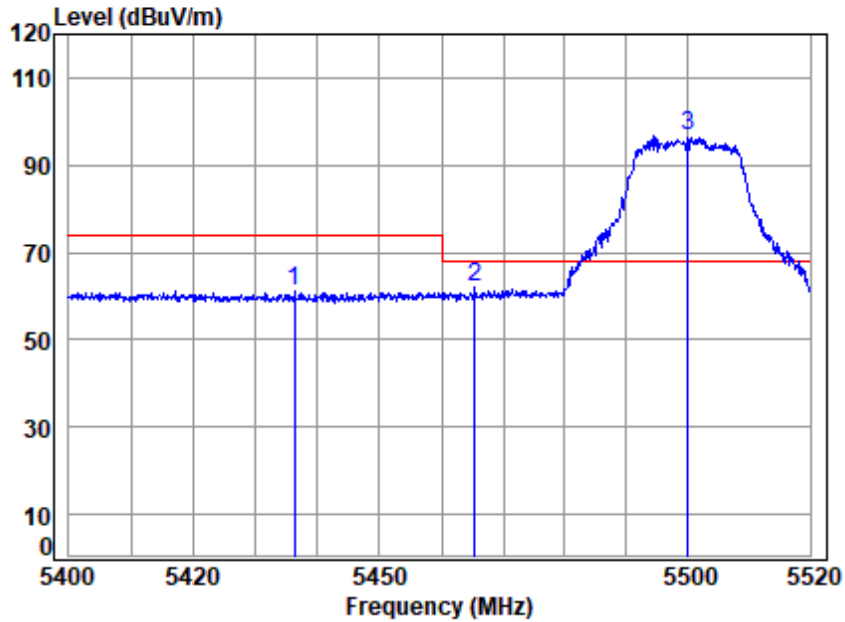

Site : chamber
 Condition: 3m HORIZONTAL
 Job No : 00750AT\00751AT
 Mode : 5500 Band edge
 : 5G WIFI 11AC20

		Cable	Ant	Preamp	Read	Limit	Over	
	Freq	Loss	Factor	Factor	Level	Level	Line	Limit
	MHz	dB	dB/m	dB	dBuV	dBuV/m	dBuV/m	dB
1	5436.321	7.65	34.57	35.01	53.98	61.19	74.00	-12.81 peak
2	5465.433	7.67	34.60	35.01	54.70	61.96	68.20	-6.24 peak
3 q	5500.000	7.71	34.60	35.01	89.34	96.64	68.20	28.44 peak



Unless otherwise agreed in writing, this document is issued by the Company subject to its General Conditions of Service printed overleaf, available on request or accessible at <http://www.sgs.com/en/Terms-and-Conditions.aspx> and, for electronic format documents, subject to Terms and Conditions for Electronic Documents at <http://www.sgs.com/en/Terms-and-Conditions/Terms-e-Documents.aspx>. Attention is drawn to the limitation of liability, indemnification and jurisdiction issues defined therein. Any holder of this document is advised that information contained hereon reflects the Company's findings at the time of its intervention only and within the limits of Client's instructions, if any. The Company's sole responsibility is to its Client and this document does not exonerate parties to a transaction from exercising all their rights and obligations under the transaction documents. This document cannot be reproduced except in full, without prior written approval of the Company. Any unauthorized alteration, forgery or falsification of the content or appearance of this document is unlawful and offenders may be prosecuted to the fullest extent of the law. Unless otherwise stated the results shown in this test report refer only to the sample(s) tested and such sample(s) are retained for 30 days only.

Test Mode: 07; Polarity: Horizontal; Modulation:802.11ac; Bandwidth:20MHz; Channel:Low

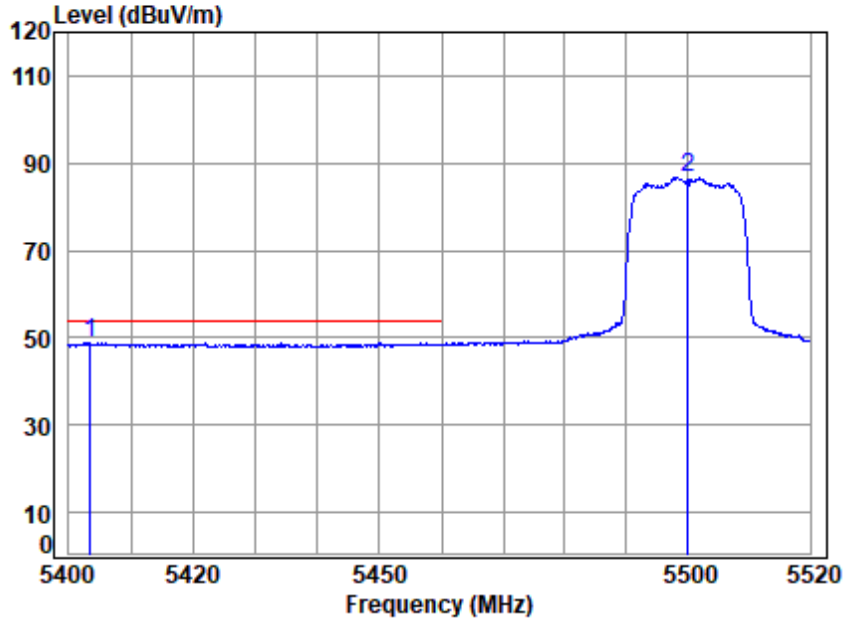

Site : chamber
 Condition: 3m HORIZONTAL
 Job No : 00750AT\00751AT
 Mode : 5500 Band edge
 : 5G WIFI 11AC20

	Freq	Cable Loss	Ant Factor	Preamp Factor	Read Level	Limit	Over	Remark
	MHz	dB	dB/m	dB	dBuV	dBuV/m	dB	
1 q	5403.443	7.61	34.51	35.01	41.69	48.80	54.00	-5.20 Average
2	5500.000	7.71	34.60	35.01	79.59	86.89	-----	----- Average



Unless otherwise agreed in writing, this document is issued by the Company subject to its General Conditions of Service printed overleaf, available on request or accessible at <http://www.sgs.com/en/Terms-and-Conditions.aspx> and, for electronic format documents, subject to Terms and Conditions for Electronic Documents at <http://www.sgs.com/en/Terms-and-Conditions/Terms-e-Documents.aspx>. Attention is drawn to the limitation of liability, indemnification and jurisdiction issues defined therein. Any holder of this document is advised that information contained hereon reflects the Company's findings at the time of its intervention only and within the limits of Client's instructions, if any. The Company's sole responsibility is to its Client and this document does not exonerate parties to a transaction from exercising all their rights and obligations under the transaction documents. This document cannot be reproduced except in full, without prior written approval of the Company. Any unauthorized alteration, forgery or falsification of the content or appearance of this document is unlawful and offenders may be prosecuted to the fullest extent of the law. Unless otherwise stated the results shown in this test report refer only to the sample(s) tested and such sample(s) are retained for 30 days only.

Test Mode: 07; Polarity: Vertical; Modulation:802.11ac; Bandwidth:20MHz; Channel:Low

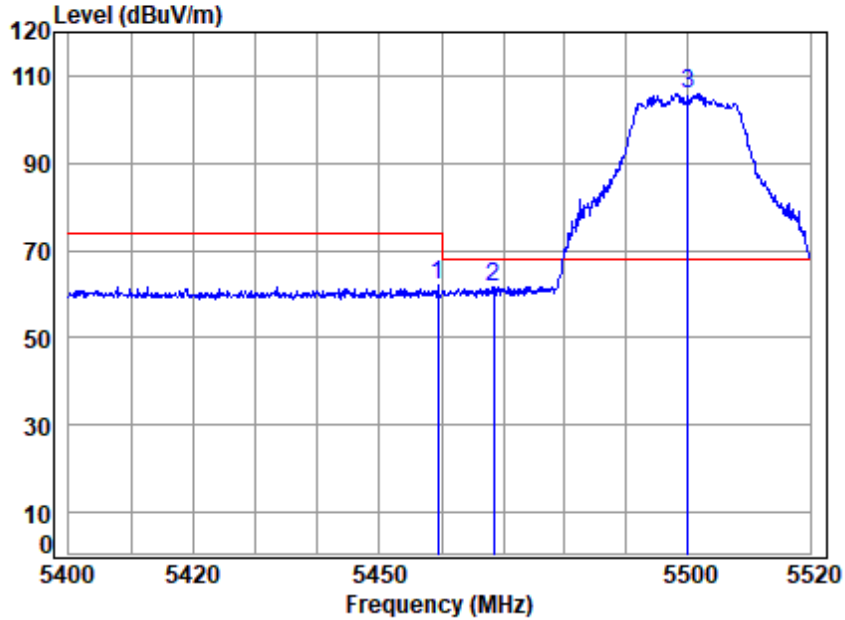

Site : chamber
 Condition: 3m VERTICAL
 Job No : 00750AT\00751AT
 Mode : 5500 Band edge
 : 5G WIFI 11AC20

		Cable	Ant	Preamp	Read	Limit	Over	
	Freq	Loss	Factor	Factor	Level	Level	Line	Limit
	MHz	dB	dB/m	dB	dBuV	dBuV/m	dBuV/m	dB
1	5459.430	7.67	34.60	35.01	54.98	62.24	74.00	-11.76 Peak
2	5468.437	7.68	34.60	35.01	54.23	61.50	68.20	-6.70 peak
3 q	5500.000	7.71	34.60	35.01	98.63	105.93	68.20	37.73 Peak



Unless otherwise agreed in writing, this document is issued by the Company subject to its General Conditions of Service printed overleaf, available on request or accessible at <http://www.sgs.com/en/Terms-and-Conditions.aspx> and, for electronic format documents, subject to Terms and Conditions for Electronic Documents at <http://www.sgs.com/en/Terms-and-Conditions/Terms-e-Documents.aspx>. Attention is drawn to the limitation of liability, indemnification and jurisdiction issues defined therein. Any holder of this document is advised that information contained hereon reflects the Company's findings at the time of its intervention only and within the limits of Client's instructions, if any. The Company's sole responsibility is to its Client and this document does not exonerate parties to a transaction from exercising all their rights and obligations under the transaction documents. This document cannot be reproduced except in full, without prior written approval of the Company. Any unauthorized alteration, forgery or falsification of the content or appearance of this document is unlawful and offenders may be prosecuted to the fullest extent of the law. Unless otherwise stated the results shown in this test report refer only to the sample(s) tested and such sample(s) are retained for 30 days only.

Test Mode: 07; Polarity: Vertical; Modulation:802.11ac; Bandwidth:20MHz; Channel:Low

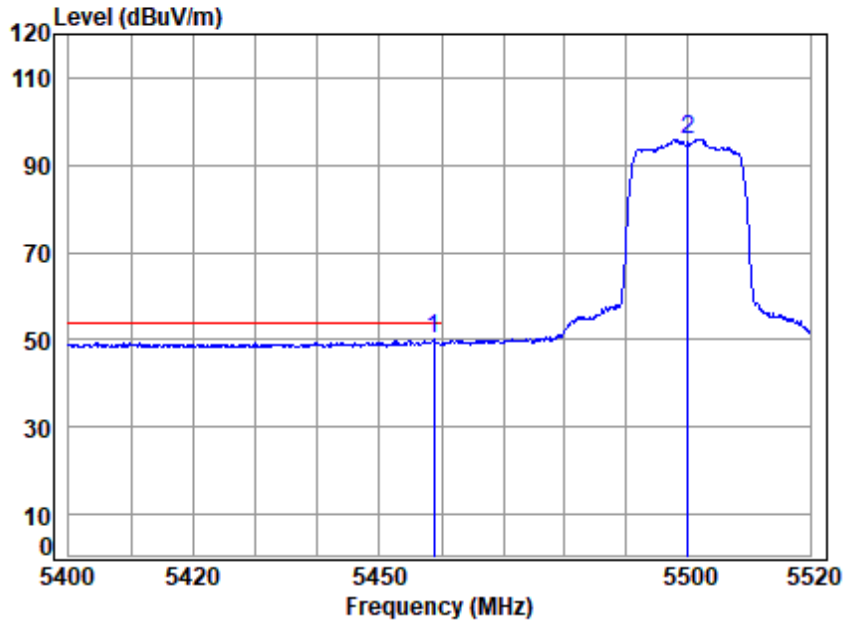

Site : chamber
 Condition: 3m VERTICAL
 Job No : 00750AT\00751AT
 Mode : 5500 Band edge
 : 5G WIFI 11AC20

		Cable	Ant	Preamp	Read	Limit	Over		
Freq		Loss	Factor	Factor	Level	Level	Line	Limit	Remark
	MHz	dB	dB/m	dB	dBuV	dBuV/m	dBuV/m	dB	
1 q	5458.831	7.67	34.60	35.01	42.82	50.08	54.00	-3.92	Average
2	5500.000	7.71	34.60	35.01	88.71	96.01	-----	-----	Average



Unless otherwise agreed in writing, this document is issued by the Company subject to its General Conditions of Service printed overleaf, available on request or accessible at <http://www.sgs.com/en/Terms-and-Conditions.aspx> and, for electronic format documents, subject to Terms and Conditions for Electronic Documents at <http://www.sgs.com/en/Terms-and-Conditions/Terms-e-Documents.aspx>. Attention is drawn to the limitation of liability, indemnification and jurisdiction issues defined therein. Any holder of this document is advised that information contained hereon reflects the Company's findings at the time of its intervention only and within the limits of Client's instructions, if any. The Company's sole responsibility is to its Client and this document does not exonerate parties to a transaction from exercising all their rights and obligations under the transaction documents. This document cannot be reproduced except in full, without prior written approval of the Company. Any unauthorized alteration, forgery or falsification of the content or appearance of this document is unlawful and offenders may be prosecuted to the fullest extent of the law. Unless otherwise stated the results shown in this test report refer only to the sample(s) tested and such sample(s) are retained for 30 days only.

Test Mode: 07; Polarity: Horizontal; Modulation:802.11ac; Bandwidth:20MHz; Channel:High

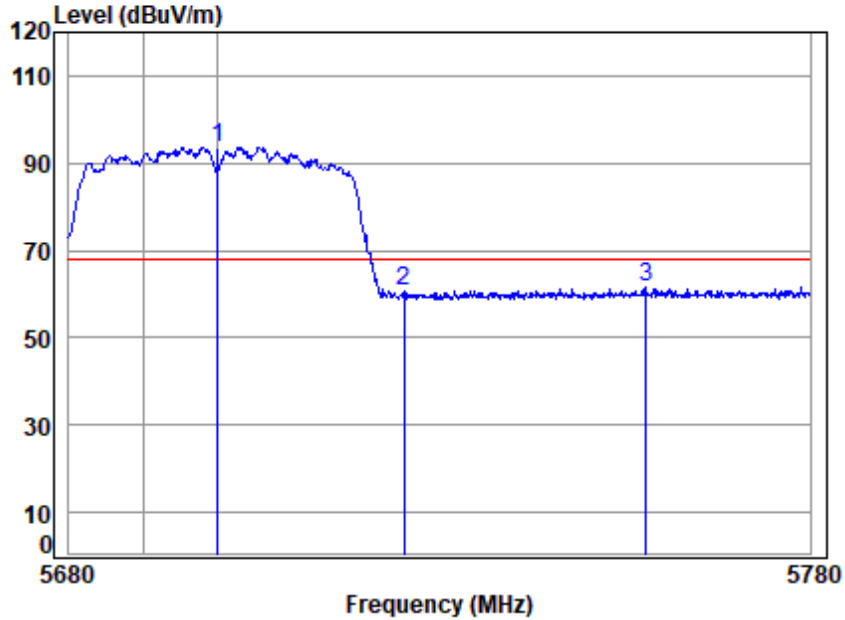

Site : chamber
 Condition: 3m HORIZONTAL
 Job No : 00750AT\00751AT
 Mode : 5700 Band edge
 : 5G WIFI 11AC20

	Cable	Ant	Preamp	Read	Limit	Over		
Freq	Loss	Factor	Factor	Level	Level	Line	Limit	Remark
MHz	dB	dB/m	dB	dBuV	dBuV/m	dBuV/m	dB	
1 q 5700.000	7.89	34.50	35.02	86.27	93.64	68.20	25.44	peak
2 5725.000	7.92	34.50	35.02	53.32	60.72	68.20	-7.48	peak
3 5757.750	7.95	34.52	35.03	54.11	61.55	68.20	-6.65	peak



Unless otherwise agreed in writing, this document is issued by the Company subject to its General Conditions of Service printed overleaf, available on request or accessible at <http://www.sgs.com/en/Terms-and-Conditions.aspx> and, for electronic format documents, subject to Terms and Conditions for Electronic Documents at <http://www.sgs.com/en/Terms-and-Conditions/Terms-e-Documents.aspx>. Attention is drawn to the limitation of liability, indemnification and jurisdiction issues defined therein. Any holder of this document is advised that information contained hereon reflects the Company's findings at the time of its intervention only and within the limits of Client's instructions, if any. The Company's sole responsibility is to its Client and this document does not exonerate parties to a transaction from exercising all their rights and obligations under the transaction documents. This document cannot be reproduced except in full, without prior written approval of the Company. Any unauthorized alteration, forgery or falsification of the content or appearance of this document is unlawful and offenders may be prosecuted to the fullest extent of the law. Unless otherwise stated the results shown in this test report refer only to the sample(s) tested and such sample(s) are retained for 30 days only.

Test Mode: 07; Polarity: Vertical; Modulation:802.11ac; Bandwidth:20MHz; Channel:High

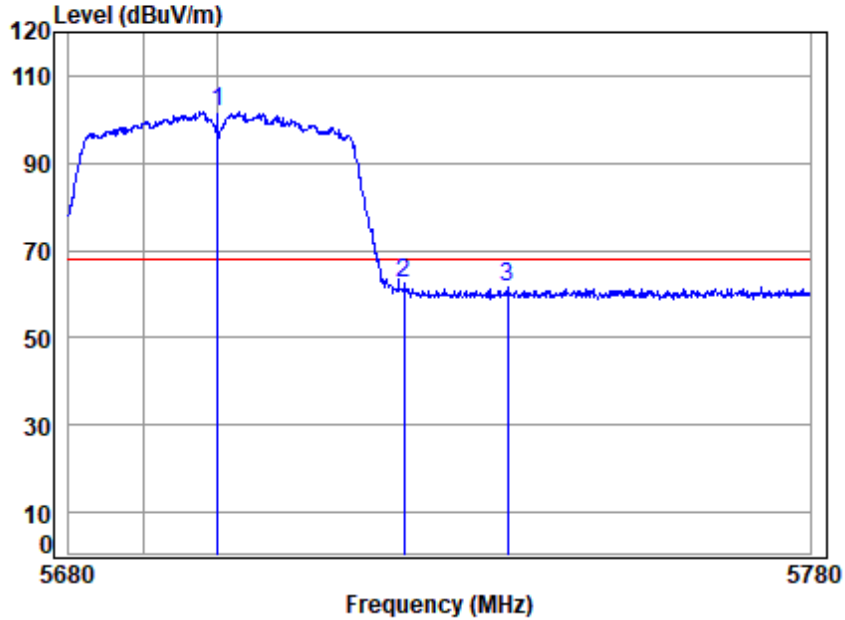

Site : chamber
 Condition: 3m VERTICAL
 Job No : 00750AT\00751AT
 Mode : 5700 Band edge
 : 5G WIFI 11AC20

		Cable	Ant	Preamp	Read	Limit	Over	
	Freq	Loss	Factor	Factor	Level	Level	Line	Limit
	MHz	dB	dB/m	dB	dBuV	dBuV/m	dBuV/m	dB
1	q 5700.000	7.89	34.50	35.02	94.22	101.59	68.20	33.39 Peak
2	5725.000	7.92	34.50	35.02	54.99	62.39	68.20	-5.81 Peak
3	5738.989	7.93	34.50	35.03	54.08	61.48	68.20	-6.72 Peak



Unless otherwise agreed in writing, this document is issued by the Company subject to its General Conditions of Service printed overleaf, available on request or accessible at <http://www.sgs.com/en/Terms-and-Conditions.aspx> and, for electronic format documents, subject to Terms and Conditions for Electronic Documents at <http://www.sgs.com/en/Terms-and-Conditions/Terms-e-Documents.aspx>. Attention is drawn to the limitation of liability, indemnification and jurisdiction issues defined therein. Any holder of this document is advised that information contained hereon reflects the Company's findings at the time of its intervention only and within the limits of Client's instructions, if any. The Company's sole responsibility is to its Client and this document does not exonerate parties to a transaction from exercising all their rights and obligations under the transaction documents. This document cannot be reproduced except in full, without prior written approval of the Company. Any unauthorized alteration, forgery or falsification of the content or appearance of this document is unlawful and offenders may be prosecuted to the fullest extent of the law. Unless otherwise stated the results shown in this test report refer only to the sample(s) tested and such sample(s) are retained for 30 days only.

Test Mode: 07; Polarity: Horizontal; Modulation:802.11ac; Bandwidth:40MHz; Channel:Low

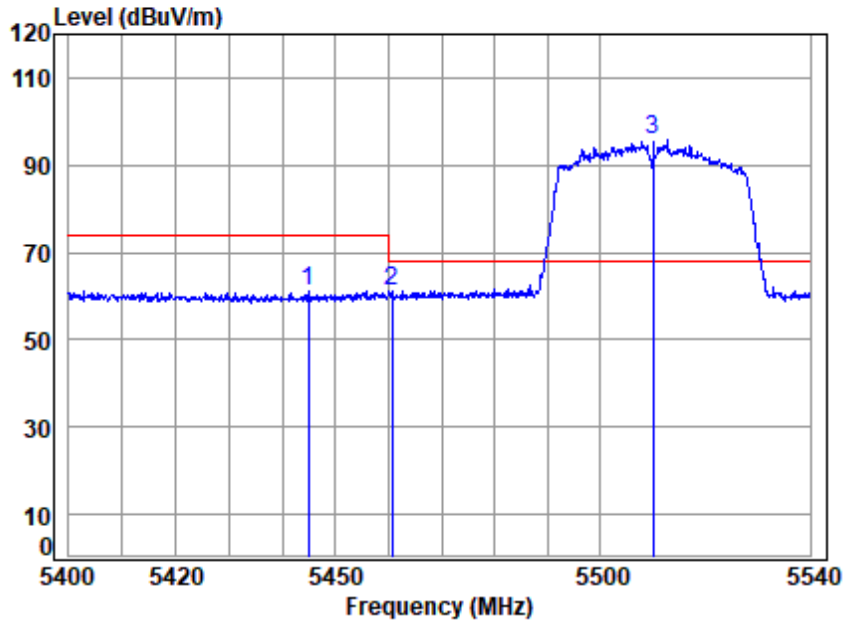

Site : chamber
 Condition: 3m HORIZONTAL
 Job No : 00750AT\00751AT
 Mode : 5510 Band edge
 : 5G WIFI 11AC40

		Cable	Ant	Preamp	Read	Limit	Over	
	Freq	Loss	Factor	Factor	Level	Level	Line	Limit
	MHz	dB	dB/m	dB	dBuV	dBuV/m	dBuV/m	dB
1	5444.829	7.65	34.59	35.01	54.00	61.23	74.00	-12.77 peak
2	5460.600	7.67	34.60	35.01	53.81	61.07	68.20	-7.13 peak
3 q	5510.000	7.72	34.60	35.01	88.33	95.64	68.20	27.44 peak



Unless otherwise agreed in writing, this document is issued by the Company subject to its General Conditions of Service printed overleaf, available on request or accessible at <http://www.sgs.com/en/Terms-and-Conditions.aspx> and, for electronic format documents, subject to Terms and Conditions for Electronic Documents at <http://www.sgs.com/en/Terms-and-Conditions/Terms-e-Documents.aspx>. Attention is drawn to the limitation of liability, indemnification and jurisdiction issues defined therein. Any holder of this document is advised that information contained hereon reflects the Company's findings at the time of its intervention only and within the limits of Client's instructions, if any. The Company's sole responsibility is to its Client and this document does not exonerate parties to a transaction from exercising all their rights and obligations under the transaction documents. This document cannot be reproduced except in full, without prior written approval of the Company. Any unauthorized alteration, forgery or falsification of the content or appearance of this document is unlawful and offenders may be prosecuted to the fullest extent of the law. Unless otherwise stated the results shown in this test report refer only to the sample(s) tested and such sample(s) are retained for 30 days only.

Test Mode: 07; Polarity: Horizontal; Modulation:802.11ac; Bandwidth:40MHz; Channel:Low

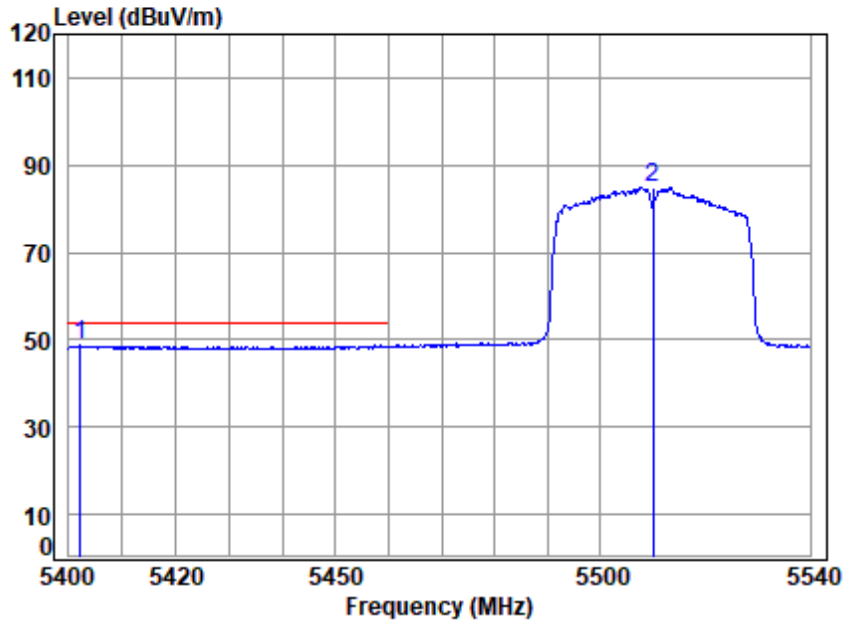

Site : chamber
 Condition: 3m HORIZONTAL
 Job No : 00750AT\00751AT
 Mode : 5510 Band edge
 : 5G WIFI 11AC40

	Freq	Cable Loss	Ant Factor	Preamp Factor	Read Level	Limit Level	Over Limit	Remark
	MHz	dB	dB/m	dB	dBuV	dBuV/m	dBuV/m	dB
1 q	5402.212	7.61	34.50	35.01	41.59	48.69	54.00	-5.31 Average
2	5510.000	7.72	34.60	35.01	77.60	84.91	-----	----- Average



Unless otherwise agreed in writing, this document is issued by the Company subject to its General Conditions of Service printed overleaf, available on request or accessible at <http://www.sgs.com/en/Terms-and-Conditions.aspx> and, for electronic format documents, subject to Terms and Conditions for Electronic Documents at <http://www.sgs.com/en/Terms-and-Conditions/Terms-e-Documents.aspx>. Attention is drawn to the limitation of liability, indemnification and jurisdiction issues defined therein. Any holder of this document is advised that information contained hereon reflects the Company's findings at the time of its intervention only and within the limits of Client's instructions, if any. The Company's sole responsibility is to its Client and this document does not exonerate parties to a transaction from exercising all their rights and obligations under the transaction documents. This document cannot be reproduced except in full, without prior written approval of the Company. Any unauthorized alteration, forgery or falsification of the content or appearance of this document is unlawful and offenders may be prosecuted to the fullest extent of the law. Unless otherwise stated the results shown in this test report refer only to the sample(s) tested and such sample(s) are retained for 30 days only.
 Attention: To check the authenticity of testing /inspection report & certificate, please contact us at telephone: (86-755) 8307 1443, or email: CN.Doccheck@sgs.com

Test Mode: 07; Polarity: Vertical; Modulation:802.11ac; Bandwidth:40MHz; Channel:Low

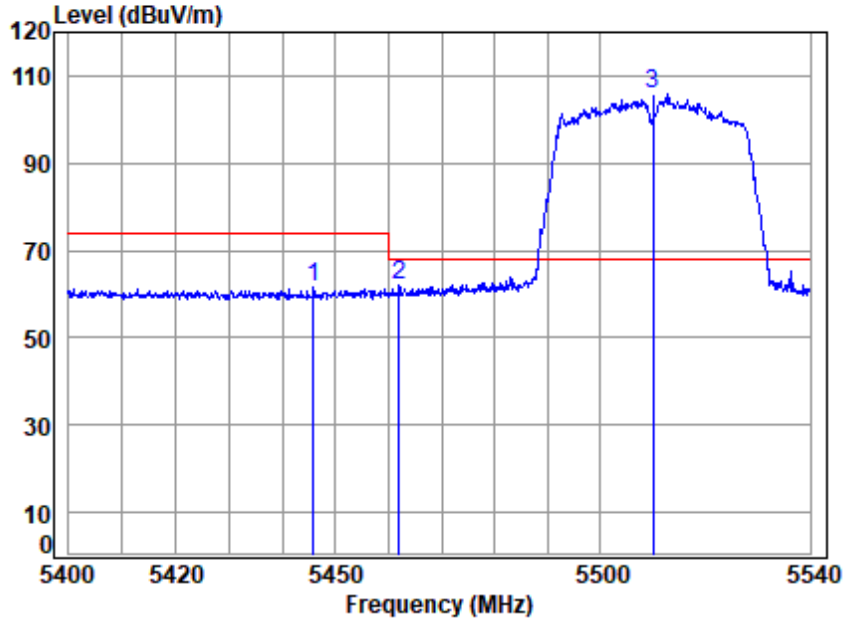

Site : chamber
 Condition: 3m VERTICAL
 Job No : 00750AT\00751AT
 Mode : 5510 Band edge
 : 5G WIFI 11AC40

		Cable	Ant	Preamp	Read	Limit	Over	
	Freq	Loss	Factor	Factor	Level	Level	Line	Limit
	MHz	dB	dB/m	dB	dBuV	dBuV/m	dBuV/m	dB
1	5445.804	7.66	34.59	35.01	54.29	61.53	74.00	-12.47 Peak
2	5461.998	7.67	34.60	35.01	54.72	61.98	68.20	-6.22 peak
3 q	5510.000	7.72	34.60	35.01	98.39	105.70	68.20	37.50 Peak



Unless otherwise agreed in writing, this document is issued by the Company subject to its General Conditions of Service printed overleaf, available on request or accessible at <http://www.sgs.com/en/Terms-and-Conditions.aspx> and, for electronic format documents, subject to Terms and Conditions for Electronic Documents at <http://www.sgs.com/en/Terms-and-Conditions/Terms-e-Documents.aspx>. Attention is drawn to the limitation of liability, indemnification and jurisdiction issues defined therein. Any holder of this document is advised that information contained hereon reflects the Company's findings at the time of its intervention only and within the limits of Client's instructions, if any. The Company's sole responsibility is to its Client and this document does not exonerate parties to a transaction from exercising all their rights and obligations under the transaction documents. This document cannot be reproduced except in full, without prior written approval of the Company. Any unauthorized alteration, forgery or falsification of the content or appearance of this document is unlawful and offenders may be prosecuted to the fullest extent of the law. Unless otherwise stated the results shown in this test report refer only to the sample(s) tested and such sample(s) are retained for 30 days only.

Test Mode: 07; Polarity: Vertical; Modulation:802.11ac; Bandwidth:40MHz; Channel:Low

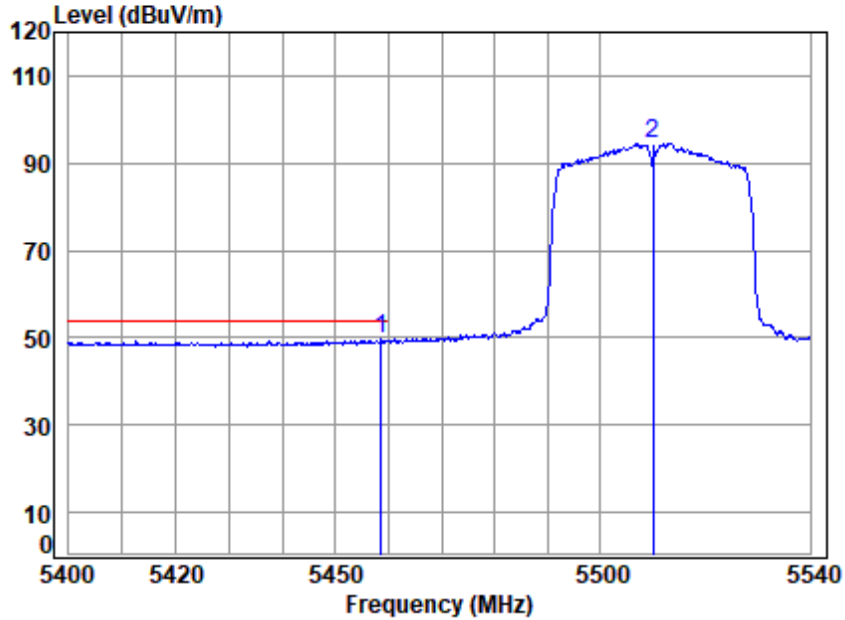

Site : chamber
 Condition: 3m VERTICAL
 Job No : 00750AT\00751AT
 Mode : 5510 Band edge
 : 5G WIFI 11AC40

	Freq	Cable Loss	Ant Factor	Preamp Factor	Read Level	Limit Level	Over Limit	Remark
	MHz	dB	dB/m	dB	dBuV	dBuV/m	dB	
1	q 5458.643	7.67	34.60	35.01	42.34	54.00	-4.40	Average
2	5510.000	7.72	34.60	35.01	87.21	-----	-----	Average



Unless otherwise agreed in writing, this document is issued by the Company subject to its General Conditions of Service printed overleaf, available on request or accessible at <http://www.sgs.com/en/Terms-and-Conditions.aspx> and, for electronic format documents, subject to Terms and Conditions for Electronic Documents at <http://www.sgs.com/en/Terms-and-Conditions/Terms-e-Documents.aspx>. Attention is drawn to the limitation of liability, indemnification and jurisdiction issues defined therein. Any holder of this document is advised that information contained hereon reflects the Company's findings at the time of its intervention only and within the limits of Client's instructions, if any. The Company's sole responsibility is to its Client and this document does not exonerate parties to a transaction from exercising all their rights and obligations under the transaction documents. This document cannot be reproduced except in full, without prior written approval of the Company. Any unauthorized alteration, forgery or falsification of the content or appearance of this document is unlawful and offenders may be prosecuted to the fullest extent of the law. Unless otherwise stated the results shown in this test report refer only to the sample(s) tested and such sample(s) are retained for 30 days only.

Test Mode: 07; Polarity: Horizontal; Modulation:802.11ac; Bandwidth:40MHz; Channel:High

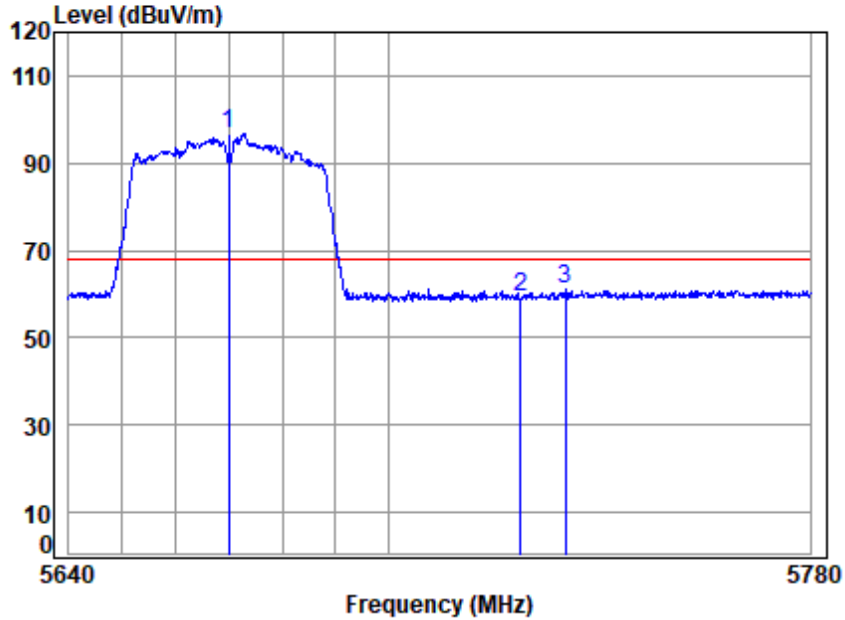

Site : chamber
 Condition: 3m HORIZONTAL
 Job No : 00750AT\00751AT
 Mode : 5670 Band edge
 : 5G WIFI 11AC40

		Cable	Ant	Preamp	Read	Limit	Over	
Freq		Loss	Factor	Factor	Level	Line	Limit	Remark
	MHz	dB	dB/m	dB	dBuV	dBuV/m	dBuV/m	dB
1 q	5670.000	7.87	34.50	35.02	89.35	96.70	68.20	28.50 peak
2	5725.000	7.92	34.50	35.02	51.87	59.27	68.20	-8.93 peak
3	5733.420	7.92	34.50	35.03	53.53	60.92	68.20	-7.28 peak



Unless otherwise agreed in writing, this document is issued by the Company subject to its General Conditions of Service printed overleaf, available on request or accessible at <http://www.sgs.com/en/Terms-and-Conditions.aspx> and, for electronic format documents, subject to Terms and Conditions for Electronic Documents at <http://www.sgs.com/en/Terms-and-Conditions/Terms-e-Documents.aspx>. Attention is drawn to the limitation of liability, indemnification and jurisdiction issues defined therein. Any holder of this document is advised that information contained hereon reflects the Company's findings at the time of its intervention only and within the limits of Client's instructions, if any. The Company's sole responsibility is to its Client and this document does not exonerate parties to a transaction from exercising all their rights and obligations under the transaction documents. This document cannot be reproduced except in full, without prior written approval of the Company. Any unauthorized alteration, forgery or falsification of the content or appearance of this document is unlawful and offenders may be prosecuted to the fullest extent of the law. Unless otherwise stated the results shown in this test report refer only to the sample(s) tested and such sample(s) are retained for 30 days only.

Test Mode: 07; Polarity: Vertical; Modulation:802.11ac; Bandwidth:40MHz; Channel:High

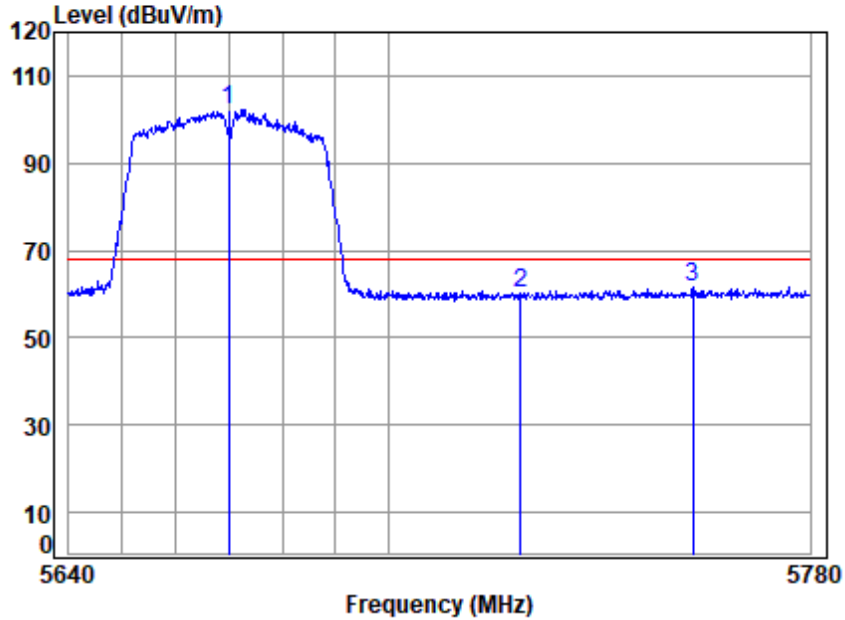

Site : chamber
 Condition: 3m VERTICAL
 Job No : 00750AT\00751AT
 Mode : 5670 Band edge
 : 5G WIFI 11AC40

	Cable	Ant	Preamp	Read	Limit	Over		
Freq	Loss	Factor	Factor	Level	Level	Line	Limit	Remark
MHz	dB	dB/m	dB	dBuV	dBuV/m	dBuV/m	dB	
1 q 5670.000	7.87	34.50	35.02	94.86	102.21	68.20	34.01	Peak
2 5725.000	7.92	34.50	35.02	52.81	60.21	68.20	-7.99	Peak
3 5757.651	7.95	34.52	35.03	53.93	61.37	68.20	-6.83	Peak



Unless otherwise agreed in writing, this document is issued by the Company subject to its General Conditions of Service printed overleaf, available on request or accessible at <http://www.sgs.com/en/Terms-and-Conditions.aspx> and, for electronic format documents, subject to Terms and Conditions for Electronic Documents at <http://www.sgs.com/en/Terms-and-Conditions/Terms-e-Documents.aspx>. Attention is drawn to the limitation of liability, indemnification and jurisdiction issues defined therein. Any holder of this document is advised that information contained hereon reflects the Company's findings at the time of its intervention only and within the limits of Client's instructions, if any. The Company's sole responsibility is to its Client and this document does not exonerate parties to a transaction from exercising all their rights and obligations under the transaction documents. This document cannot be reproduced except in full, without prior written approval of the Company. Any unauthorized alteration, forgery or falsification of the content or appearance of this document is unlawful and offenders may be prosecuted to the fullest extent of the law. Unless otherwise stated the results shown in this test report refer only to the sample(s) tested and such sample(s) are retained for 30 days only.

Test Mode: 07; Polarity: Horizontal; Modulation:802.11ac; Bandwidth:80MHz; Channel:Low

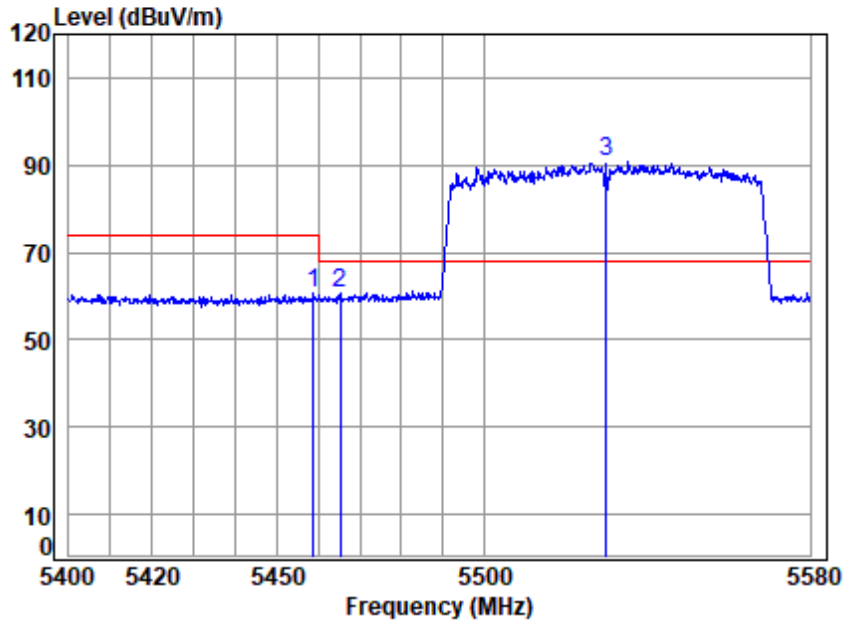

Site : chamber
 Condition: 3m HORIZONTAL
 Job No : 00750AT\00751AT
 Mode : 5530 Band edge
 : 5G WIFI 11AC80

		Cable	Ant	Preamp	Read	Limit	Over	
	Freq	Loss	Factor	Factor	Level	Level	Line	Limit
	MHz	dB	dB/m	dB	dBuV	dBuV/m	dBuV/m	dB
1	5458.749	7.67	34.60	35.01	53.36	60.62	74.00	-13.38 peak
2	5465.196	7.67	34.60	35.01	53.25	60.51	68.20	-7.69 peak
3 q	5530.000	7.73	34.60	35.01	83.55	90.87	68.20	22.67 peak



Unless otherwise agreed in writing, this document is issued by the Company subject to its General Conditions of Service printed overleaf, available on request or accessible at <http://www.sgs.com/en/Terms-and-Conditions.aspx> and, for electronic format documents, subject to Terms and Conditions for Electronic Documents at <http://www.sgs.com/en/Terms-and-Conditions/Terms-e-Documents.aspx>. Attention is drawn to the limitation of liability, indemnification and jurisdiction issues defined therein. Any holder of this document is advised that information contained hereon reflects the Company's findings at the time of its intervention only and within the limits of Client's instructions, if any. The Company's sole responsibility is to its Client and this document does not exonerate parties to a transaction from exercising all their rights and obligations under the transaction documents. This document cannot be reproduced except in full, without prior written approval of the Company. Any unauthorized alteration, forgery or falsification of the content or appearance of this document is unlawful and offenders may be prosecuted to the fullest extent of the law. Unless otherwise stated the results shown in this test report refer only to the sample(s) tested and such sample(s) are retained for 30 days only.

Test Mode: 07; Polarity: Horizontal; Modulation:802.11ac; Bandwidth:80MHz; Channel:Low

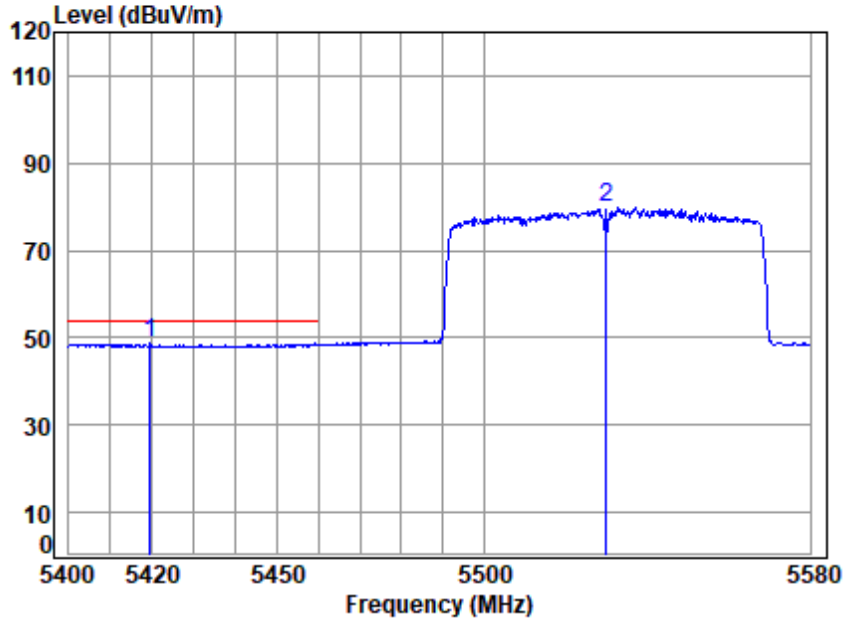

Site : chamber
 Condition: 3m HORIZONTAL
 Job No : 00750AT\00751AT
 Mode : 5530 Band edge
 : 5G WIFI 11AC80

	Freq	Cable Loss	Ant Factor	Preamp Factor	Read Level	Limit Level	Over Limit	Remark
	MHz	dB	dB/m	dB	dBuV	dBuV/m	dBuV/m	dB
1 q	5419.512	7.63	34.54	35.01	41.61	48.77	54.00	-5.23 Average
2	5530.000	7.73	34.60	35.01	72.51	79.83	-----	----- Average



Unless otherwise agreed in writing, this document is issued by the Company subject to its General Conditions of Service printed overleaf, available on request or accessible at <http://www.sgs.com/en/Terms-and-Conditions.aspx> and, for electronic format documents, subject to Terms and Conditions for Electronic Documents at <http://www.sgs.com/en/Terms-and-Conditions/Terms-e-Documents.aspx>. Attention is drawn to the limitation of liability, indemnification and jurisdiction issues defined therein. Any holder of this document is advised that information contained hereon reflects the Company's findings at the time of its intervention only and within the limits of Client's instructions, if any. The Company's sole responsibility is to its Client and this document does not exonerate parties to a transaction from exercising all their rights and obligations under the transaction documents. This document cannot be reproduced except in full, without prior written approval of the Company. Any unauthorized alteration, forgery or falsification of the content or appearance of this document is unlawful and offenders may be prosecuted to the fullest extent of the law. Unless otherwise stated the results shown in this test report refer only to the sample(s) tested and such sample(s) are retained for 30 days only.

Test Mode: 07; Polarity: Vertical; Modulation:802.11ac; Bandwidth:80MHz; Channel:Low

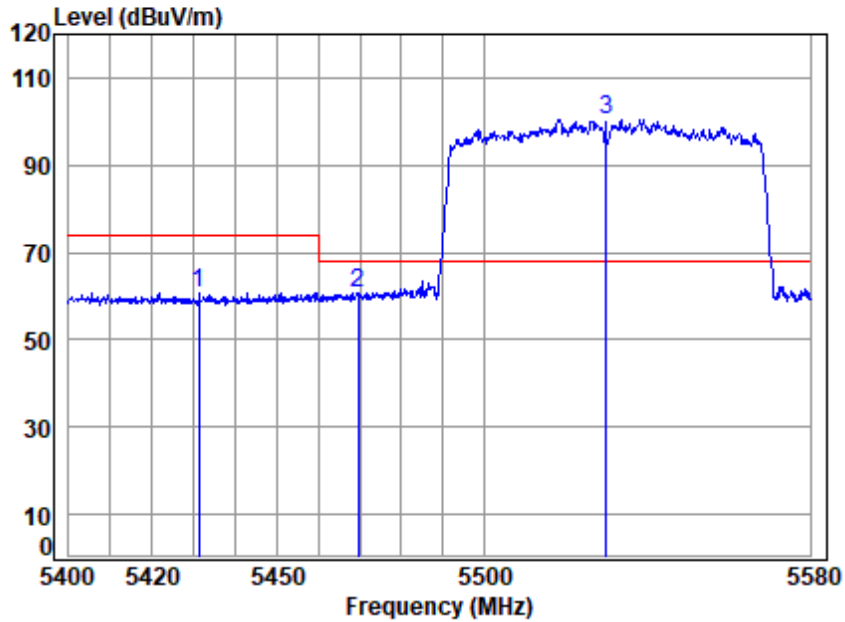

Site : chamber
 Condition: 3m VERTICAL
 Job No : 00750AT\00751AT
 Mode : 5530 Band edge
 : 5G WIFI 11AC80

		Cable	Ant	Preamp	Read	Limit	Over	
	Freq	Loss	Factor	Factor	Level	Level	Line	Limit
	MHz	dB	dB/m	dB	dBuV	dBuV/m	dBuV/m	dB
1	5431.253	7.64	34.56	35.01	53.51	60.70	74.00	-13.30 Peak
2	5469.678	7.68	34.60	35.01	53.29	60.56	68.20	-7.64 peak
3 q	5530.000	7.73	34.60	35.01	93.28	100.60	68.20	32.40 Peak



Unless otherwise agreed in writing, this document is issued by the Company subject to its General Conditions of Service printed overleaf, available on request or accessible at <http://www.sgs.com/en/Terms-and-Conditions.aspx> and, for electronic format documents, subject to Terms and Conditions for Electronic Documents at <http://www.sgs.com/en/Terms-and-Conditions/Terms-e-Documents.aspx>. Attention is drawn to the limitation of liability, indemnification and jurisdiction issues defined therein. Any holder of this document is advised that information contained hereon reflects the Company's findings at the time of its intervention only and within the limits of Client's instructions, if any. The Company's sole responsibility is to its Client and this document does not exonerate parties to a transaction from exercising all their rights and obligations under the transaction documents. This document cannot be reproduced except in full, without prior written approval of the Company. Any unauthorized alteration, forgery or falsification of the content or appearance of this document is unlawful and offenders may be prosecuted to the fullest extent of the law. Unless otherwise stated the results shown in this test report refer only to the sample(s) tested and such sample(s) are retained for 30 days only.

Test Mode: 07; Polarity: Vertical; Modulation:802.11ac; Bandwidth:80MHz; Channel:Low

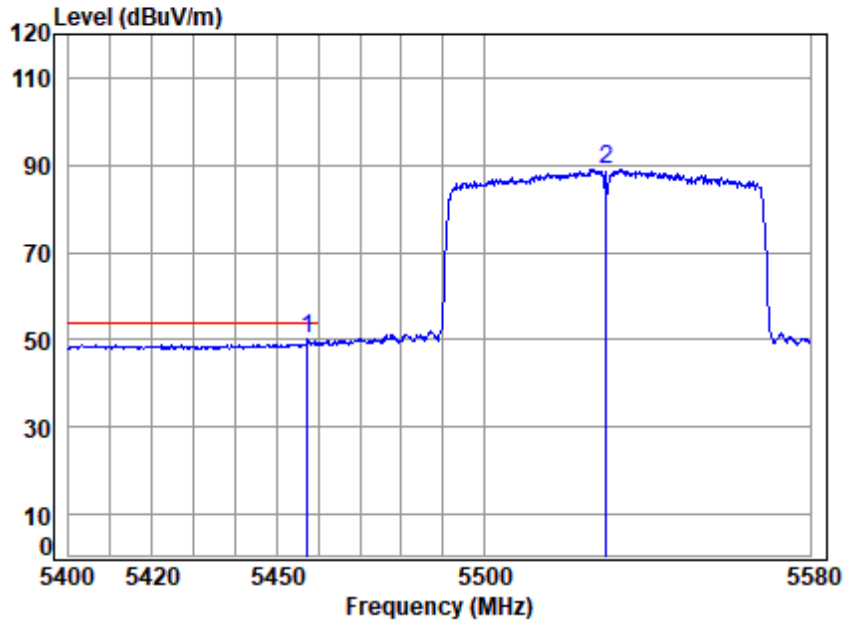

Site : chamber
 Condition: 3m VERTICAL
 Job No : 00750AT\00751AT
 Mode : 5530 Band edge
 : 5G WIFI 11AC80

		Cable	Ant	Preamp	Read	Limit	Over	
Freq	Loss	Factor	Factor	Factor	Level	Line	Limit	Remark
MHz	dB	dB/m	dB/m	dB	dBuV	dBuV/m	dBuV/m	dB
1 q 5457.317	7.67	34.60	35.01	42.76	50.02	54.00	-3.98	Average
2 5530.000	7.73	34.60	35.01	81.75	89.07	-----	-----	Average



Unless otherwise agreed in writing, this document is issued by the Company subject to its General Conditions of Service printed overleaf, available on request or accessible at <http://www.sgs.com/en/Terms-and-Conditions.aspx> and, for electronic format documents, subject to Terms and Conditions for Electronic Documents at <http://www.sgs.com/en/Terms-and-Conditions/Terms-e-Documents.aspx>. Attention is drawn to the limitation of liability, indemnification and jurisdiction issues defined therein. Any holder of this document is advised that information contained hereon reflects the Company's findings at the time of its intervention only and within the limits of Client's instructions, if any. The Company's sole responsibility is to its Client and this document does not exonerate parties to a transaction from exercising all their rights and obligations under the transaction documents. This document cannot be reproduced except in full, without prior written approval of the Company. Any unauthorized alteration, forgery or falsification of the content or appearance of this document is unlawful and offenders may be prosecuted to the fullest extent of the law. Unless otherwise stated the results shown in this test report refer only to the sample(s) tested and such sample(s) are retained for 30 days only.

Test Mode: 07; Polarity: Horizontal; Modulation:802.11ac; Bandwidth:80MHz; Channel:High

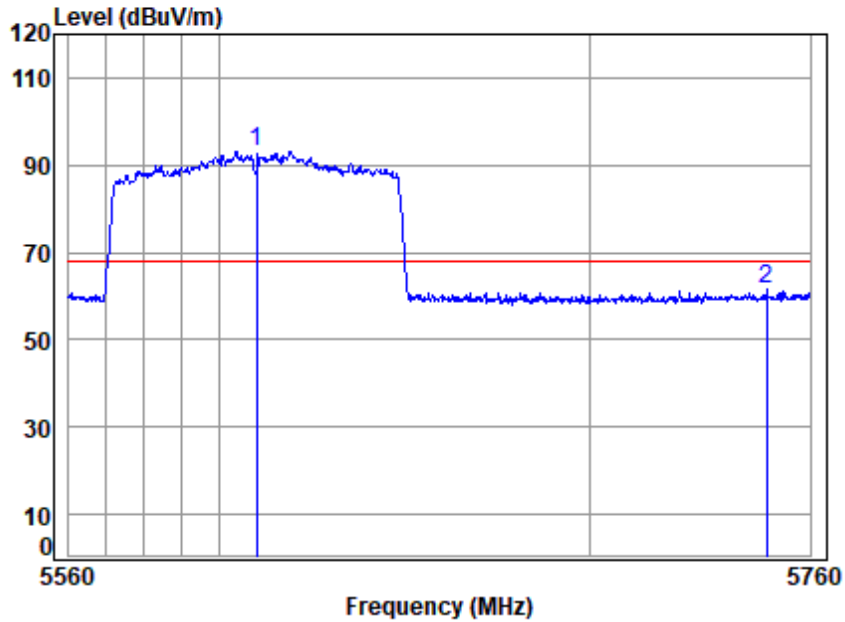

Site : chamber
 Condition: 3m HORIZONTAL
 Job No : 00750AT\00751AT
 Mode : 5610 Band edge
 : 5G WIFI 11AC80

	Cable	Ant	Preamp	Read	Limit	Over	
Freq	Loss	Factor	Factor	Level	Level	Line	Limit
MHz	dB	dB/m	dB	dBuV	dBuV/m	dBuV/m	dB
1 q 5610.000	7.81	34.50	35.02	85.83	93.12	68.20	24.92 peak
2 5748.206	7.94	34.50	35.03	54.23	61.64	68.20	-6.56 peak



Unless otherwise agreed in writing, this document is issued by the Company subject to its General Conditions of Service printed overleaf, available on request or accessible at <http://www.sgs.com/en/Terms-and-Conditions.aspx> and, for electronic format documents, subject to Terms and Conditions for Electronic Documents at <http://www.sgs.com/en/Terms-and-Conditions/Terms-e-Documents.aspx>. Attention is drawn to the limitation of liability, indemnification and jurisdiction issues defined therein. Any holder of this document is advised that information contained hereon reflects the Company's findings at the time of its intervention only and within the limits of Client's instructions, if any. The Company's sole responsibility is to its Client and this document does not exonerate parties to a transaction from exercising all their rights and obligations under the transaction documents. This document cannot be reproduced except in full, without prior written approval of the Company. Any unauthorized alteration, forgery or falsification of the content or appearance of this document is unlawful and offenders may be prosecuted to the fullest extent of the law. Unless otherwise stated the results shown in this test report refer only to the sample(s) tested and such sample(s) are retained for 30 days only.

Test Mode: 07; Polarity: Vertical; Modulation:802.11ac; Bandwidth:80MHz; Channel:High

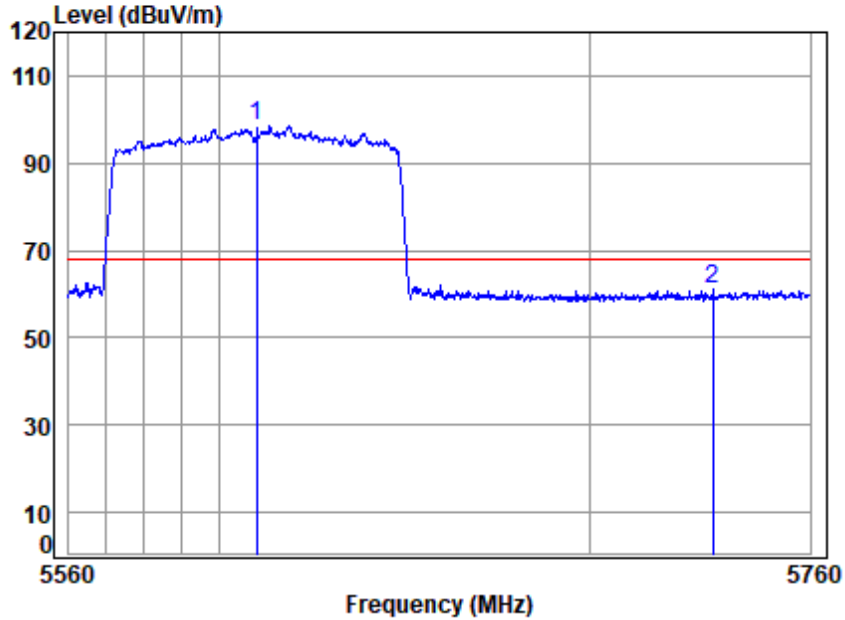

Site : chamber
 Condition: 3m VERTICAL
 Job No : 00750AT\00751AT
 Mode : 5610 Band edge
 : 5G WIFI 11AC80

	Cable	Ant	Preamp	Read	Limit	Over		
Freq	Loss	Factor	Factor	Level	Level	Line	Limit	Remark
MHz	dB	dB/m	dB	dBuV	dBuV/m	dBuV/m	dB	
1 q 5610.000	7.81	34.50	35.02	91.26	98.55	68.20	30.35	Peak
2 5733.396	7.92	34.50	35.03	53.62	61.01	68.20	-7.19	Peak



Unless otherwise agreed in writing, this document is issued by the Company subject to its General Conditions of Service printed overleaf, available on request or accessible at <http://www.sgs.com/en/Terms-and-Conditions.aspx> and, for electronic format documents, subject to Terms and Conditions for Electronic Documents at <http://www.sgs.com/en/Terms-and-Conditions/Terms-e-Documents.aspx>. Attention is drawn to the limitation of liability, indemnification and jurisdiction issues defined therein. Any holder of this document is advised that information contained hereon reflects the Company's findings at the time of its intervention only and within the limits of Client's instructions, if any. The Company's sole responsibility is to its Client and this document does not exonerate parties to a transaction from exercising all their rights and obligations under the transaction documents. This document cannot be reproduced except in full, without prior written approval of the Company. Any unauthorized alteration, forgery or falsification of the content or appearance of this document is unlawful and offenders may be prosecuted to the fullest extent of the law. Unless otherwise stated the results shown in this test report refer only to the sample(s) tested and such sample(s) are retained for 30 days only.

Test Mode: 07; Polarity: Horizontal; Modulation:802.11ax; Bandwidth:20MHz; Channel:Low

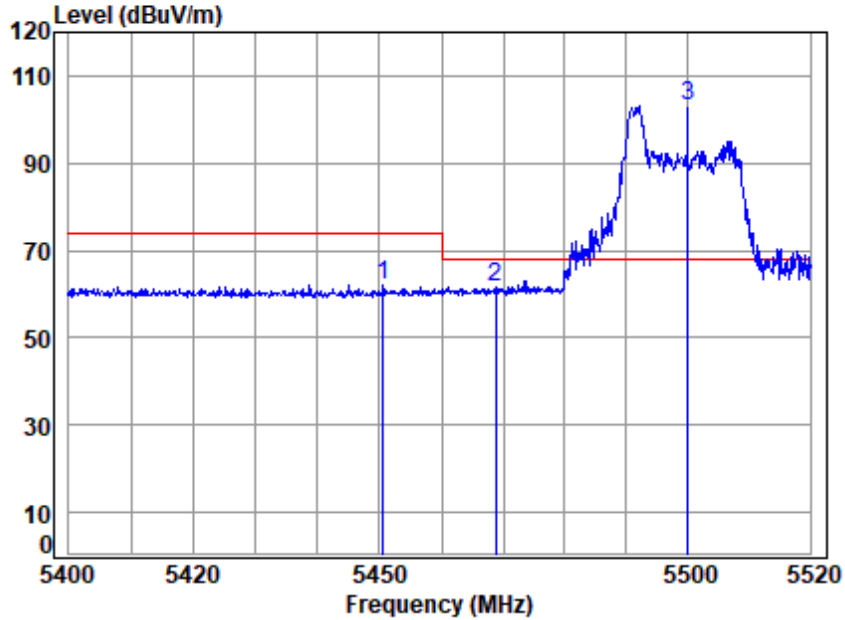

Site : chamber
 Condition: 3m HORIZONTAL
 Job No : 00750AT\00751AT
 Mode : 5500 Band edge
 : 5G WIFI 11AX20 26 RU

	Cable	Ant	Preamp	Read	Limit	Over		
Freq	Loss	Factor	Factor	Level	Level	Line	Limit	Remark
MHz	dB	dB/m	dB	dBuV	dBuV/m	dBuV/m	dB	
1	7.66	34.60	35.01	54.64	61.89	74.00	-12.11	peak
2	7.68	34.60	35.01	54.54	61.81	68.20	-6.39	peak
3 q	7.71	34.60	35.01	95.67	102.97	68.20	34.77	peak



Unless otherwise agreed in writing, this document is issued by the Company subject to its General Conditions of Service printed overleaf, available on request or accessible at <http://www.sgs.com/en/Terms-and-Conditions.aspx> and, for electronic format documents, subject to Terms and Conditions for Electronic Documents at <http://www.sgs.com/en/Terms-and-Conditions/Terms-e-Documents.aspx>. Attention is drawn to the limitation of liability, indemnification and jurisdiction issues defined therein. Any holder of this document is advised that information contained hereon reflects the Company's findings at the time of its intervention only and within the limits of Client's instructions, if any. The Company's sole responsibility is to its Client and this document does not exonerate parties to a transaction from exercising all their rights and obligations under the transaction documents. This document cannot be reproduced except in full, without prior written approval of the Company. Any unauthorized alteration, forgery or falsification of the content or appearance of this document is unlawful and offenders may be prosecuted to the fullest extent of the law. Unless otherwise stated the results shown in this test report refer only to the sample(s) tested and such sample(s) are retained for 30 days only.
 Attention: To check the authenticity of testing /inspection report & certificate, please contact us at telephone: (86-755) 8307 1443, or email: CN_Doccheck@sgs.com

Test Mode: 07; Polarity: Horizontal; Modulation:802.11ax; Bandwidth:20MHz; Channel:Low

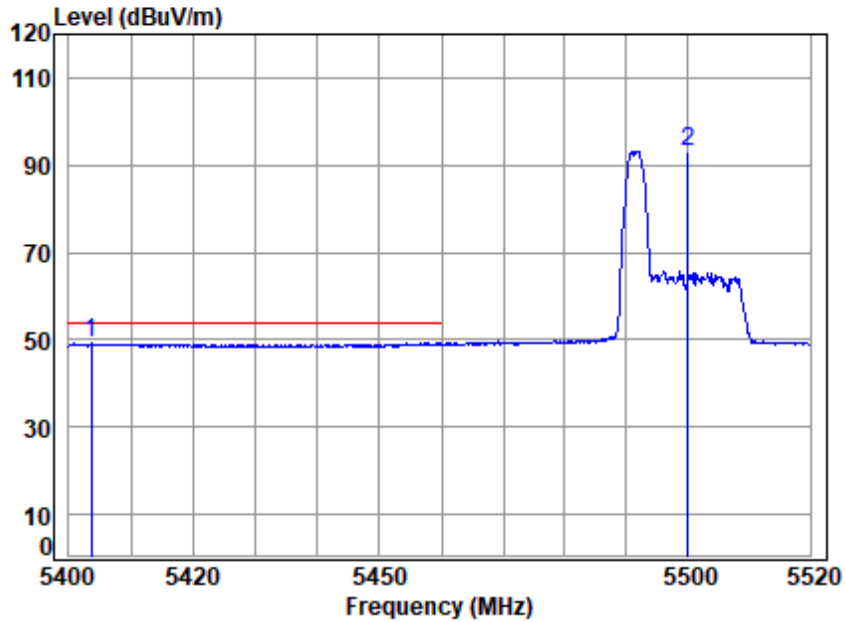

Site : chamber
 Condition: 3m HORIZONTAL
 Job No : 00750AT\00751AT
 Mode : 5500 Band edge
 : 5G WIFI 11AX20 26 RU

	Cable	Ant	Preamp	Read	Limit	Over		
Freq	Loss	Factor	Factor	Level	Level	Line	Limit	Remark
MHz	dB	dB/m	dB	dBuV	dBuV/m	dBuV/m	dB	
1 q 5403.562	7.61	34.51	35.01	42.14	49.25	54.00	-4.75	Average
2 5500.000	7.71	34.60	35.01	85.88	93.18	-----	-----	Average



Unless otherwise agreed in writing, this document is issued by the Company subject to its General Conditions of Service printed overleaf, available on request or accessible at <http://www.sgs.com/en/Terms-and-Conditions.aspx> and, for electronic format documents, subject to Terms and Conditions for Electronic Documents at <http://www.sgs.com/en/Terms-and-Conditions/Terms-e-Documents.aspx>. Attention is drawn to the limitation of liability, indemnification and jurisdiction issues defined therein. Any holder of this document is advised that information contained hereon reflects the Company's findings at the time of its intervention only and within the limits of Client's instructions, if any. The Company's sole responsibility is to its Client and this document does not exonerate parties to a transaction from exercising all their rights and obligations under the transaction documents. This document cannot be reproduced except in full, without prior written approval of the Company. Any unauthorized alteration, forgery or falsification of the content or appearance of this document is unlawful and offenders may be prosecuted to the fullest extent of the law. Unless otherwise stated the results shown in this test report refer only to the sample(s) tested and such sample(s) are retained for 30 days only.
 Attention: To check the authenticity of testing /inspection report & certificate, please contact us at telephone: (86-755) 8307 1443, or email: CN.Doccheck@sgs.com

Test Mode: 07; Polarity: Vertical; Modulation:802.11ax; Bandwidth:20MHz; Channel:Low

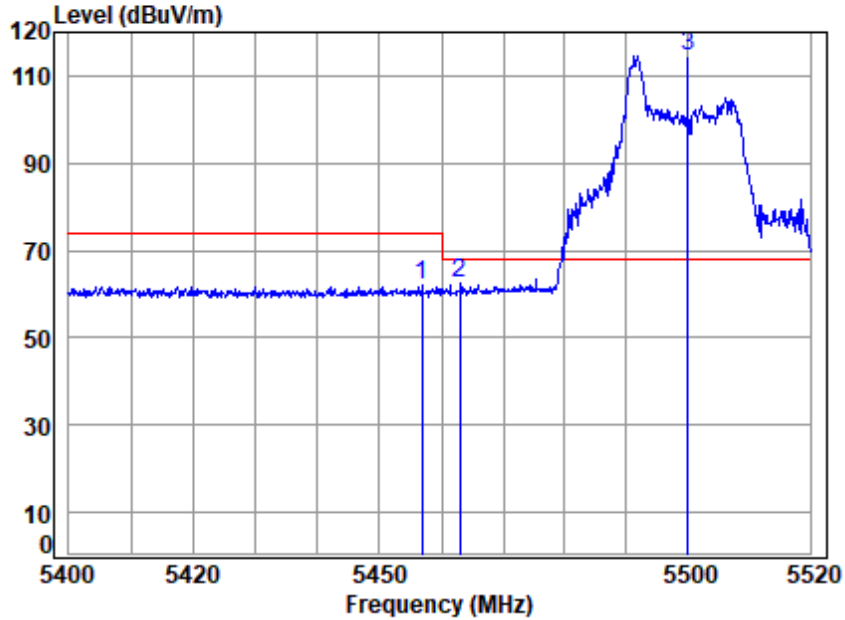

Site : chamber
 Condition: 3m VERTICAL
 Job No : 00750AT\00751AT
 Mode : 5500 Band edge
 : 5G WIFI 11AX20 26 RU

	Cable	Ant	Preamp	Read	Limit	Over		
Freq	Loss	Factor	Factor	Level	Level	Line	Limit	Remark
MHz	dB	dB/m	dB	dBuV	dBuV/m	dBuV/m	dB	
1	7.67	34.60	35.01	54.66	61.92	74.00	-12.08	Peak
2	7.67	34.60	35.01	55.25	62.51	68.20	-5.69	peak
3 q	7.71	34.60	35.01	107.31	114.61	68.20	46.41	Peak



Unless otherwise agreed in writing, this document is issued by the Company subject to its General Conditions of Service printed overleaf, available on request or accessible at <http://www.sgs.com/en/Terms-and-Conditions.aspx> and, for electronic format documents, subject to Terms and Conditions for Electronic Documents at <http://www.sgs.com/en/Terms-and-Conditions/Terms-e-Documents.aspx>. Attention is drawn to the limitation of liability, indemnification and jurisdiction issues defined therein. Any holder of this document is advised that information contained hereon reflects the Company's findings at the time of its intervention only and within the limits of Client's instructions, if any. The Company's sole responsibility is to its Client and this document does not exonerate parties to a transaction from exercising all their rights and obligations under the transaction documents. This document cannot be reproduced except in full, without prior written approval of the Company. Any unauthorized alteration, forgery or falsification of the content or appearance of this document is unlawful and offenders may be prosecuted to the fullest extent of the law. Unless otherwise stated the results shown in this test report refer only to the sample(s) tested and such sample(s) are retained for 30 days only.

Test Mode: 07; Polarity: Vertical; Modulation:802.11ax; Bandwidth:20MHz; Channel:Low

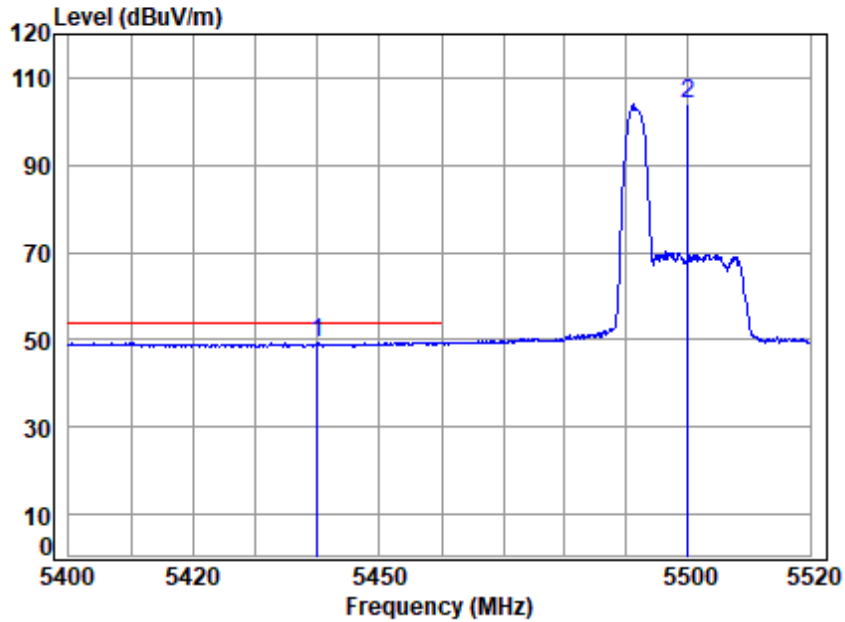

Site : chamber
 Condition: 3m VERTICAL
 Job No : 00750AT\00751AT
 Mode : 5500 Band edge
 : 5G WIFI 11AX20 26 RU

	Cable	Ant	Preamp	Read	Limit	Over		
Freq	Loss	Factor	Factor	Level	Level	Line	Limit	Remark
MHz	dB	dB/m	dB	dBuV	dBuV/m	dBuV/m	dB	
1 q 5440.026	7.65	34.58	35.01	42.17	49.39	54.00	-4.61	Average
2 5500.000	7.71	34.60	35.01	96.63	103.93	-----	-----	Average



Unless otherwise agreed in writing, this document is issued by the Company subject to its General Conditions of Service printed overleaf, available on request or accessible at <http://www.sgs.com/en/Terms-and-Conditions.aspx> and, for electronic format documents, subject to Terms and Conditions for Electronic Documents at <http://www.sgs.com/en/Terms-and-Conditions/Terms-e-Documents.aspx>. Attention is drawn to the limitation of liability, indemnification and jurisdiction issues defined therein. Any holder of this document is advised that information contained hereon reflects the Company's findings at the time of its intervention only and within the limits of Client's instructions, if any. The Company's sole responsibility is to its Client and this document does not exonerate parties to a transaction from exercising all their rights and obligations under the transaction documents. This document cannot be reproduced except in full, without prior written approval of the Company. Any unauthorized alteration, forgery or falsification of the content or appearance of this document is unlawful and offenders may be prosecuted to the fullest extent of the law. Unless otherwise stated the results shown in this test report refer only to the sample(s) tested and such sample(s) are retained for 30 days only.

Test Mode: 07; Polarity: Horizontal; Modulation:802.11ax; Bandwidth:20MHz; Channel:Low

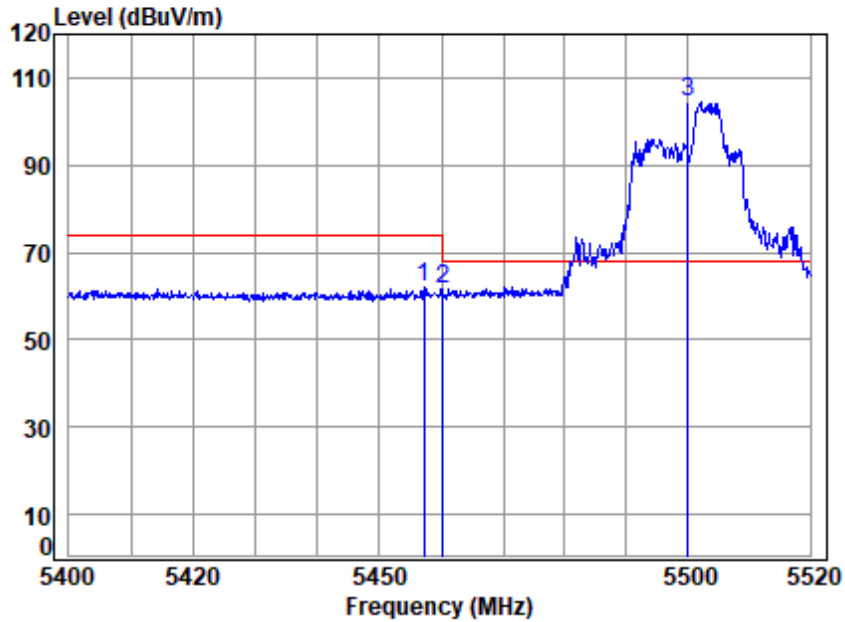

Site : chamber
 Condition: 3m HORIZONTAL
 Job No : 00750AT\00751AT
 Mode : 5500 Band edge
 : 5G WIFI 11AX20 52 RU

	Cable	Ant	Preamp	Read	Limit	Over		
Freq	Loss	Factor	Factor	Level	Level	Line	Limit	Remark
MHz	dB	dB/m	dB	dBuV	dBuV/m	dBuV/m	dB	
1	7.67	34.60	35.01	54.57	61.83	74.00	-12.17	peak
2	7.67	34.60	35.01	54.52	61.78	68.20	-6.42	peak
3 q	7.71	34.60	35.01	97.00	104.30	68.20	36.10	peak



Unless otherwise agreed in writing, this document is issued by the Company subject to its General Conditions of Service printed overleaf, available on request or accessible at <http://www.sgs.com/en/Terms-and-Conditions.aspx> and, for electronic format documents, subject to Terms and Conditions for Electronic Documents at <http://www.sgs.com/en/Terms-and-Conditions/Terms-e-Documents.aspx>. Attention is drawn to the limitation of liability, indemnification and jurisdiction issues defined therein. Any holder of this document is advised that information contained hereon reflects the Company's findings at the time of its intervention only and within the limits of Client's instructions, if any. The Company's sole responsibility is to its Client and this document does not exonerate parties to a transaction from exercising all their rights and obligations under the transaction documents. This document cannot be reproduced except in full, without prior written approval of the Company. Any unauthorized alteration, forgery or falsification of the content or appearance of this document is unlawful and offenders may be prosecuted to the fullest extent of the law. Unless otherwise stated the results shown in this test report refer only to the sample(s) tested and such sample(s) are retained for 30 days only.

Test Mode: 07; Polarity: Horizontal; Modulation:802.11ax; Bandwidth:20MHz; Channel:Low

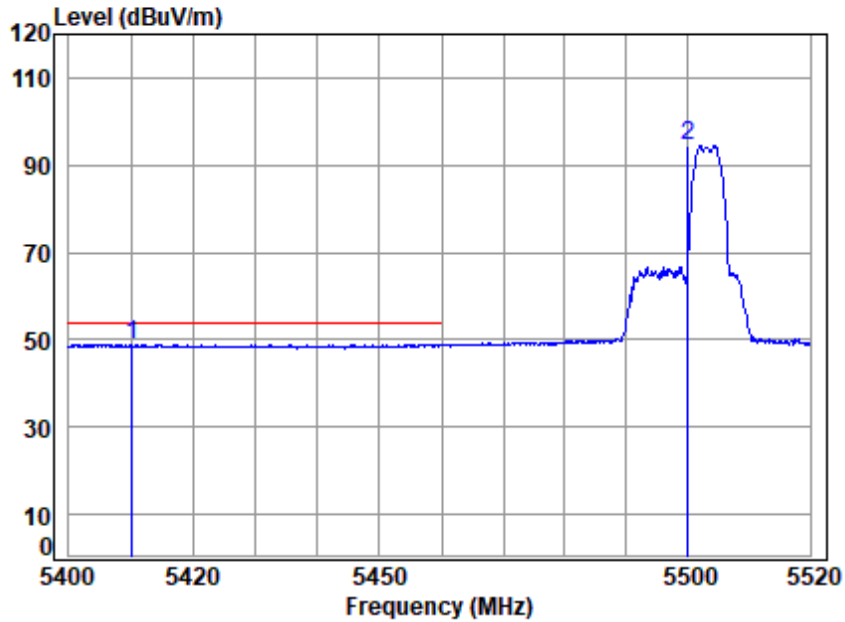

Site : chamber
 Condition: 3m HORIZONTAL
 Job No : 00750AT\00751AT
 Mode : 5500 Band edge
 : 5G WIFI 11AX20 52 RU

	Cable	Ant	Preamp	Read	Limit	Over		
Freq	Loss	Factor	Factor	Level	Level	Line	Limit	Remark
MHz	dB	dB/m	dB	dBuV	dBuV/m	dBuV/m	dB	
1 q 5410.098	7.62	34.52	35.01	41.90	49.03	54.00	-4.97	Average
2 5500.000	7.71	34.60	35.01	87.29	94.59	-----	-----	Average



Unless otherwise agreed in writing, this document is issued by the Company subject to its General Conditions of Service printed overleaf, available on request or accessible at <http://www.sgs.com/en/Terms-and-Conditions.aspx> and, for electronic format documents, subject to Terms and Conditions for Electronic Documents at <http://www.sgs.com/en/Terms-and-Conditions/Terms-e-Documents.aspx>. Attention is drawn to the limitation of liability, indemnification and jurisdiction issues defined therein. Any holder of this document is advised that information contained hereon reflects the Company's findings at the time of its intervention only and within the limits of Client's instructions, if any. The Company's sole responsibility is to its Client and this document does not exonerate parties to a transaction from exercising all their rights and obligations under the transaction documents. This document cannot be reproduced except in full, without prior written approval of the Company. Any unauthorized alteration, forgery or falsification of the content or appearance of this document is unlawful and offenders may be prosecuted to the fullest extent of the law. Unless otherwise stated the results shown in this test report refer only to the sample(s) tested and such sample(s) are retained for 30 days only.

Test Mode: 07; Polarity: Vertical; Modulation:802.11ax; Bandwidth:20MHz; Channel:Low

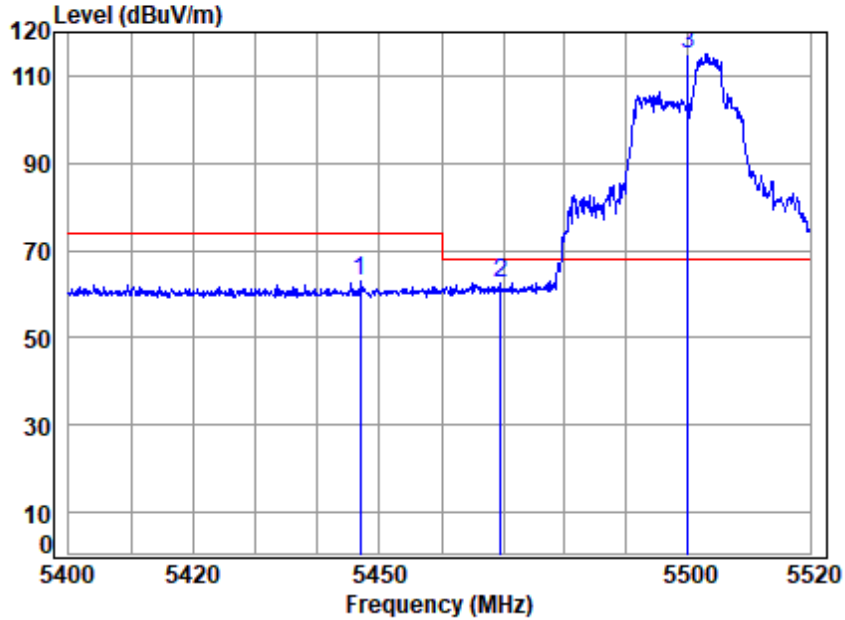

Site : chamber
 Condition: 3m VERTICAL
 Job No : 00750AT\00751AT
 Mode : 5500 Band edge
 : 5G WIFI 11AX20 52 RU

	Cable	Ant	Preamp	Read	Limit	Over		
Freq	Loss	Factor	Factor	Level	Level	Line	Limit	Remark
MHz	dB	dB/m	dB	dBuV	dBuV/m	dBuV/m	dB	
1	7.66	34.59	35.01	55.71	62.95	74.00	-11.05	Peak
2	7.68	34.60	35.01	55.19	62.46	68.20	-5.74	peak
3 q	7.71	34.60	35.01	107.64	114.94	68.20	46.74	Peak



Unless otherwise agreed in writing, this document is issued by the Company subject to its General Conditions of Service printed overleaf, available on request or accessible at <http://www.sgs.com/en/Terms-and-Conditions.aspx> and, for electronic format documents, subject to Terms and Conditions for Electronic Documents at <http://www.sgs.com/en/Terms-and-Conditions/Terms-e-Documents.aspx>. Attention is drawn to the limitation of liability, indemnification and jurisdiction issues defined therein. Any holder of this document is advised that information contained hereon reflects the Company's findings at the time of its intervention only and within the limits of Client's instructions, if any. The Company's sole responsibility is to its Client and this document does not exonerate parties to a transaction from exercising all their rights and obligations under the transaction documents. This document cannot be reproduced except in full, without prior written approval of the Company. Any unauthorized alteration, forgery or falsification of the content or appearance of this document is unlawful and offenders may be prosecuted to the fullest extent of the law. Unless otherwise stated the results shown in this test report refer only to the sample(s) tested and such sample(s) are retained for 30 days only.

Test Mode: 07; Polarity: Vertical; Modulation:802.11ax; Bandwidth:20MHz; Channel:Low

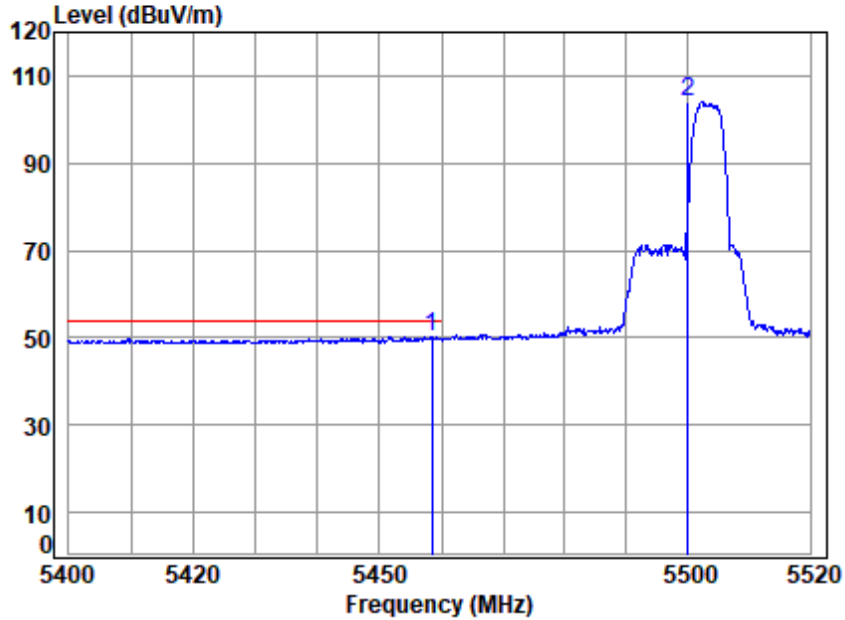

Site : chamber
 Condition: 3m VERTICAL
 Job No : 00750AT\00751AT
 Mode : 5500 Band edge
 : 5G WIFI 11AX20 52 RU

	Cable	Ant	Preamp	Read	Limit	Over		
Freq	Loss	Factor	Factor	Level	Level	Line	Limit	Remark
MHz	dB	dB/m	dB	dBuV	dBuV/m	dBuV/m	dB	
1 q 5458.471	7.67	34.60	35.01	43.01	50.27	54.00	-3.73	Average
2 5500.000	7.71	34.60	35.01	96.65	103.95	-----	-----	Average



Unless otherwise agreed in writing, this document is issued by the Company subject to its General Conditions of Service printed overleaf, available on request or accessible at <http://www.sgs.com/en/Terms-and-Conditions.aspx> and, for electronic format documents, subject to Terms and Conditions for Electronic Documents at <http://www.sgs.com/en/Terms-and-Conditions/Terms-e-Documents.aspx>. Attention is drawn to the limitation of liability, indemnification and jurisdiction issues defined therein. Any holder of this document is advised that information contained hereon reflects the Company's findings at the time of its intervention only and within the limits of Client's instructions, if any. The Company's sole responsibility is to its Client and this document does not exonerate parties to a transaction from exercising all their rights and obligations under the transaction documents. This document cannot be reproduced except in full, without prior written approval of the Company. Any unauthorized alteration, forgery or falsification of the content or appearance of this document is unlawful and offenders may be prosecuted to the fullest extent of the law. Unless otherwise stated the results shown in this test report refer only to the sample(s) tested and such sample(s) are retained for 30 days only.

Test Mode: 07; Polarity: Horizontal; Modulation:802.11ax; Bandwidth:20MHz; Channel:Low

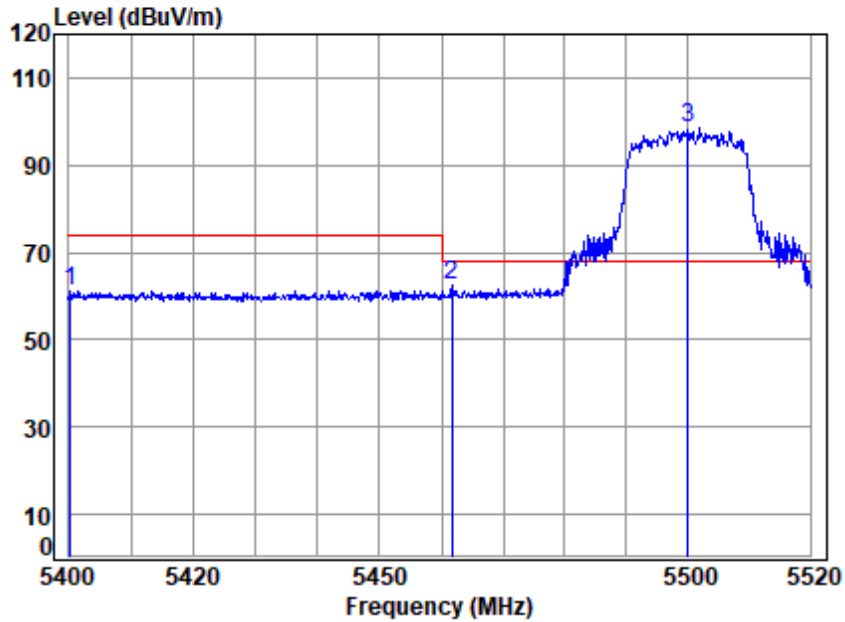

Site : chamber
 Condition: 3m HORIZONTAL
 Job No : 00750AT\00751AT
 Mode : 5500 Band edge
 : 5G WIFI 11AX20 242 RU

		Cable	Ant	Preamp	Read	Limit	Over	
	Freq	Loss	Factor	Factor	Level	Level	Line	Limit
	MHz	dB	dB/m	dB	dBuV	dBuV/m	dBuV/m	dB
1	5400.237	7.61	34.50	35.01	54.13	61.23	74.00	-12.77 peak
2	5461.710	7.67	34.60	35.01	55.08	62.34	68.20	-5.86 peak
3 q	5500.000	7.71	34.60	35.01	91.04	98.34	68.20	30.14 peak



Unless otherwise agreed in writing, this document is issued by the Company subject to its General Conditions of Service printed overleaf, available on request or accessible at <http://www.sgs.com/en/Terms-and-Conditions.aspx> and, for electronic format documents, subject to Terms and Conditions for Electronic Documents at <http://www.sgs.com/en/Terms-and-Conditions/Terms-e-Documents.aspx>. Attention is drawn to the limitation of liability, indemnification and jurisdiction issues defined therein. Any holder of this document is advised that information contained hereon reflects the Company's findings at the time of its intervention only and within the limits of Client's instructions, if any. The Company's sole responsibility is to its Client and this document does not exonerate parties to a transaction from exercising all their rights and obligations under the transaction documents. This document cannot be reproduced except in full, without prior written approval of the Company. Any unauthorized alteration, forgery or falsification of the content or appearance of this document is unlawful and offenders may be prosecuted to the fullest extent of the law. Unless otherwise stated the results shown in this test report refer only to the sample(s) tested and such sample(s) are retained for 30 days only.

Test Mode: 07; Polarity: Horizontal; Modulation:802.11ax; Bandwidth:20MHz; Channel:Low

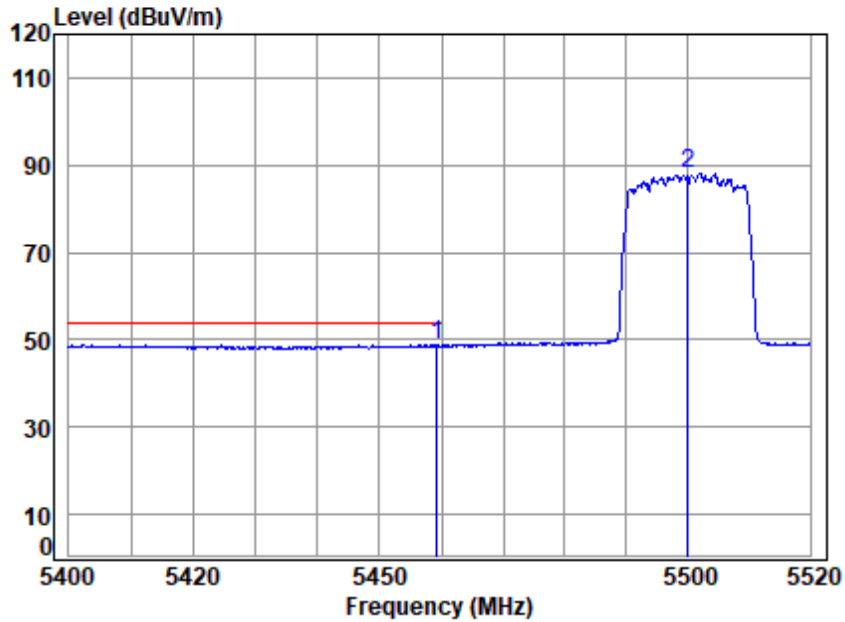

Site : chamber
 Condition: 3m HORIZONTAL
 Job No : 00750AT\00751AT
 Mode : 5500 Band edge
 : 5G WIFI 11AX20 242 RU

	Cable	Ant	Preamp	Read	Limit	Over		
Freq	Loss	Factor	Factor	Level	Level	Line	Limit	Remark
MHz	dB	dB/m	dB	dBuV	dBuV/m	dBuV/m	dB	
1 q 5459.190	7.67	34.60	35.01	41.69	48.95	54.00	-5.05	Average
2 5500.000	7.71	34.60	35.01	80.70	88.00	-----	-----	Average



Unless otherwise agreed in writing, this document is issued by the Company subject to its General Conditions of Service printed overleaf, available on request or accessible at <http://www.sgs.com/en/Terms-and-Conditions.aspx> and, for electronic format documents, subject to Terms and Conditions for Electronic Documents at <http://www.sgs.com/en/Terms-and-Conditions/Terms-e-Documents.aspx>. Attention is drawn to the limitation of liability, indemnification and jurisdiction issues defined therein. Any holder of this document is advised that information contained hereon reflects the Company's findings at the time of its intervention only and within the limits of Client's instructions, if any. The Company's sole responsibility is to its Client and this document does not exonerate parties to a transaction from exercising all their rights and obligations under the transaction documents. This document cannot be reproduced except in full, without prior written approval of the Company. Any unauthorized alteration, forgery or falsification of the content or appearance of this document is unlawful and offenders may be prosecuted to the fullest extent of the law. Unless otherwise stated the results shown in this test report refer only to the sample(s) tested and such sample(s) are retained for 30 days only.

Test Mode: 07; Polarity: Vertical; Modulation:802.11ax; Bandwidth:20MHz; Channel:Low

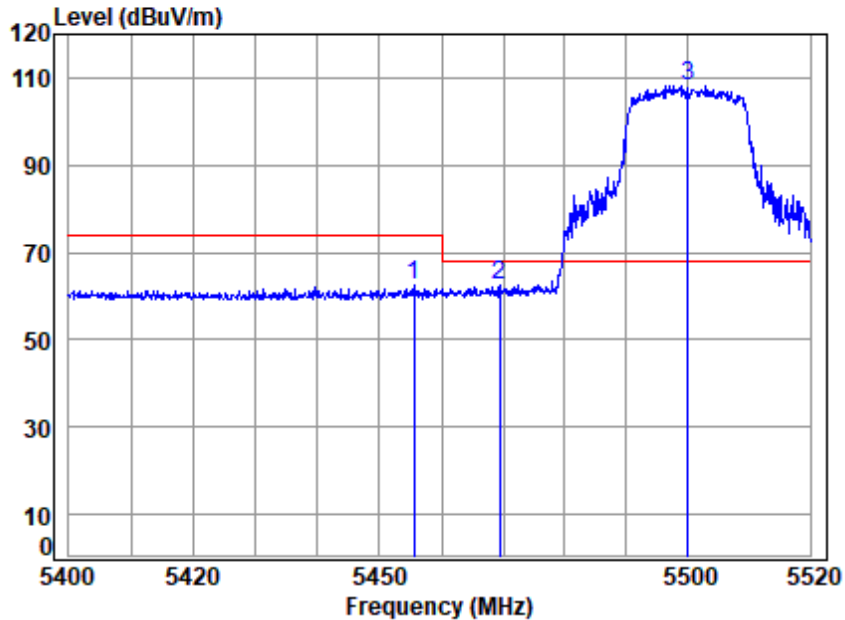

Site : chamber
 Condition: 3m VERTICAL
 Job No : 00750AT\00751AT
 Mode : 5500 Band edge
 : 5G WIFI 11AX20 242 RU

		Cable	Ant	Preamp	Read	Limit	Over	
	Freq	Loss	Factor	Factor	Level	Level	Line	Limit
	MHz	dB	dB/m	dB	dBuV	dBuV/m	dBuV/m	dB
1	5455.592	7.66	34.60	35.01	55.39	62.64	74.00	-11.36 Peak
2	5469.399	7.68	34.60	35.01	55.11	62.38	68.20	-5.82 peak
3 q	5500.000	7.71	34.60	35.01	100.91	108.21	68.20	40.01 Peak



Unless otherwise agreed in writing, this document is issued by the Company subject to its General Conditions of Service printed overleaf, available on request or accessible at <http://www.sgs.com/en/Terms-and-Conditions.aspx> and, for electronic format documents, subject to Terms and Conditions for Electronic Documents at <http://www.sgs.com/en/Terms-and-Conditions/Terms-e-Documents.aspx>. Attention is drawn to the limitation of liability, indemnification and jurisdiction issues defined therein. Any holder of this document is advised that information contained hereon reflects the Company's findings at the time of its intervention only and within the limits of Client's instructions, if any. The Company's sole responsibility is to its Client and this document does not exonerate parties to a transaction from exercising all their rights and obligations under the transaction documents. This document cannot be reproduced except in full, without prior written approval of the Company. Any unauthorized alteration, forgery or falsification of the content or appearance of this document is unlawful and offenders may be prosecuted to the fullest extent of the law. Unless otherwise stated the results shown in this test report refer only to the sample(s) tested and such sample(s) are retained for 30 days only.

Test Mode: 07; Polarity: Vertical; Modulation:802.11ax; Bandwidth:20MHz; Channel:Low

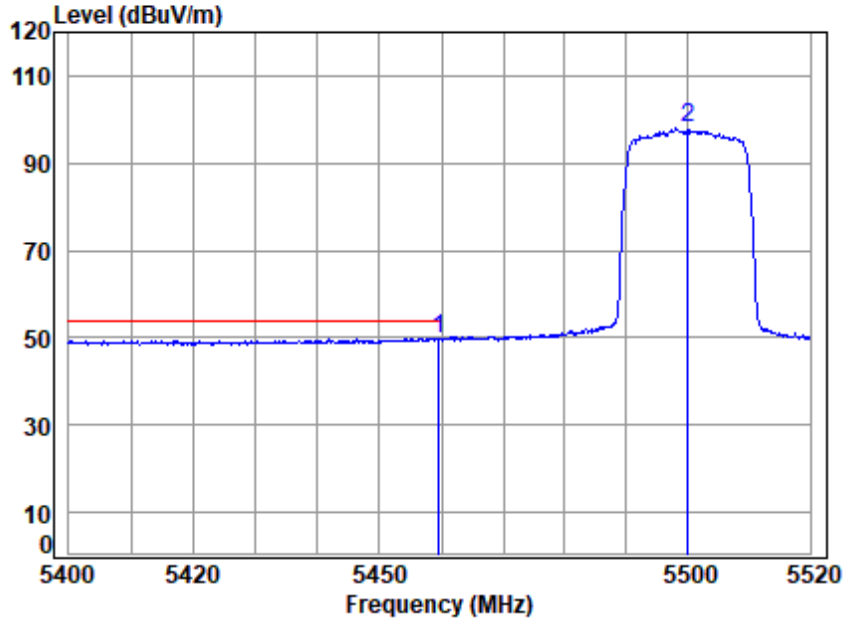

Site : chamber
 Condition: 3m VERTICAL
 Job No : 00750AT\00751AT
 Mode : 5500 Band edge
 : 5G WIFI 11AX20 242 RU

	Cable	Ant	Preamp	Read	Limit	Over		
Freq	Loss	Factor	Factor	Level	Level	Line	Limit	Remark
MHz	dB	dB/m	dB	dBuV	dBuV/m	dBuV/m	dB	
1 q 5459.670	7.67	34.60	35.01	42.62	49.88	54.00	-4.12	Average
2 5500.000	7.71	34.60	35.01	90.76	98.06	-----	-----	Average



Unless otherwise agreed in writing, this document is issued by the Company subject to its General Conditions of Service printed overleaf, available on request or accessible at <http://www.sgs.com/en/Terms-and-Conditions.aspx> and, for electronic format documents, subject to Terms and Conditions for Electronic Documents at <http://www.sgs.com/en/Terms-and-Conditions/Terms-e-Documents.aspx>. Attention is drawn to the limitation of liability, indemnification and jurisdiction issues defined therein. Any holder of this document is advised that information contained hereon reflects the Company's findings at the time of its intervention only and within the limits of Client's instructions, if any. The Company's sole responsibility is to its Client and this document does not exonerate parties to a transaction from exercising all their rights and obligations under the transaction documents. This document cannot be reproduced except in full, without prior written approval of the Company. Any unauthorized alteration, forgery or falsification of the content or appearance of this document is unlawful and offenders may be prosecuted to the fullest extent of the law. Unless otherwise stated the results shown in this test report refer only to the sample(s) tested and such sample(s) are retained for 30 days only.

Test Mode: 07; Polarity: Horizontal; Modulation:802.11ax; Bandwidth:20MHz; Channel:High

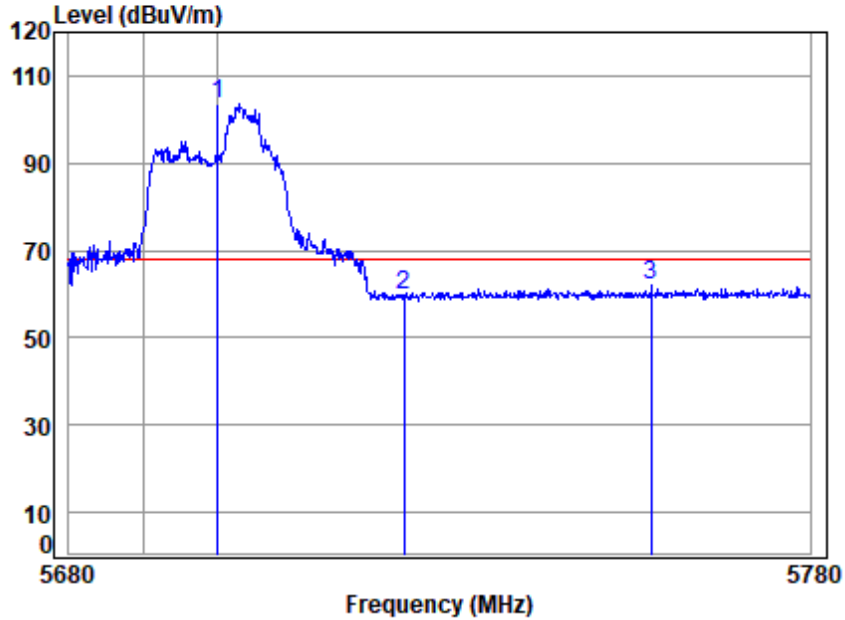

Site : chamber
 Condition: 3m HORIZONTAL
 Job No : 00750AT\00751AT
 Mode : 5700 Band edge
 : 5G WIFI 11AX20 52 RU

	Cable	Ant	Preamp	Read	Limit	Over		
Freq	Loss	Factor	Factor	Level	Level	Line	Limit	Remark
MHz	dB	dB/m	dB	dBuV	dBuV/m	dBuV/m	dB	
1 q 5700.000	7.89	34.50	35.02	96.02	103.39	68.20	35.19	peak
2 5725.000	7.92	34.50	35.02	52.54	59.94	68.20	-8.26	peak
3 5758.453	7.95	34.52	35.03	54.50	61.94	68.20	-6.26	peak



Unless otherwise agreed in writing, this document is issued by the Company subject to its General Conditions of Service printed overleaf, available on request or accessible at <http://www.sgs.com/en/Terms-and-Conditions.aspx> and, for electronic format documents, subject to Terms and Conditions for Electronic Documents at <http://www.sgs.com/en/Terms-and-Conditions/Terms-e-Documents.aspx>. Attention is drawn to the limitation of liability, indemnification and jurisdiction issues defined therein. Any holder of this document is advised that information contained hereon reflects the Company's findings at the time of its intervention only and within the limits of Client's instructions, if any. The Company's sole responsibility is to its Client and this document does not exonerate parties to a transaction from exercising all their rights and obligations under the transaction documents. This document cannot be reproduced except in full, without prior written approval of the Company. Any unauthorized alteration, forgery or falsification of the content or appearance of this document is unlawful and offenders may be prosecuted to the fullest extent of the law. Unless otherwise stated the results shown in this test report refer only to the sample(s) tested and such sample(s) are retained for 30 days only.

Test Mode: 07; Polarity: Vertical; Modulation:802.11ax; Bandwidth:20MHz; Channel:High

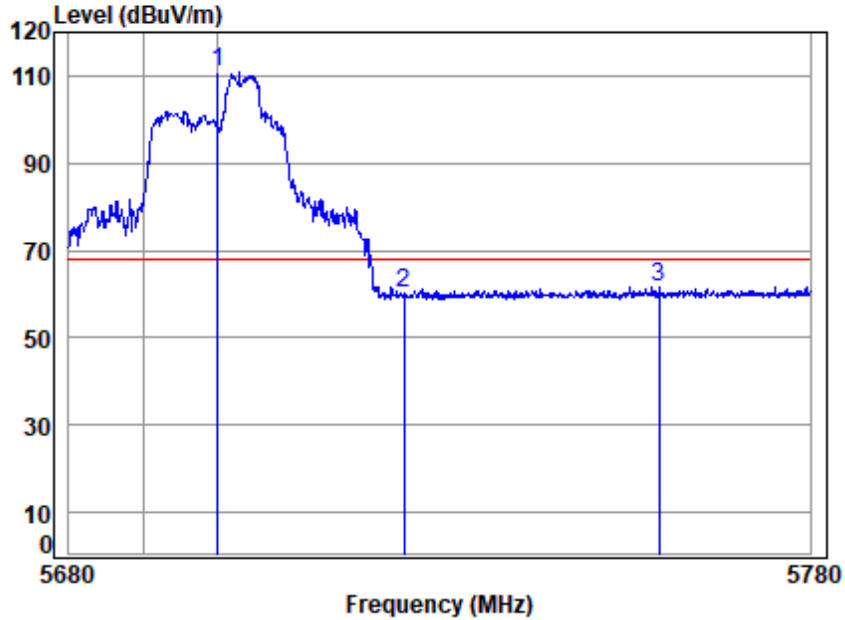

Site : chamber
 Condition: 3m VERTICAL
 Job No : 00750AT\00751AT
 Mode : 5700 Band edge
 : 5G WIFI 11AX20 52 RU

	Cable	Ant	Preamp	Read	Limit	Over		
Freq	Loss	Factor	Factor	Level	Level	Line	Limit	Remark
MHz	dB	dB/m	dB	dBuV	dBuV/m	dBuV/m	dB	
1 q 5700.000	7.89	34.50	35.02	103.37	110.74	68.20	42.54	Peak
2 5725.000	7.92	34.50	35.02	52.76	60.16	68.20	-8.04	Peak
3 5759.458	7.95	34.52	35.03	54.14	61.58	68.20	-6.62	Peak



Unless otherwise agreed in writing, this document is issued by the Company subject to its General Conditions of Service printed overleaf, available on request or accessible at <http://www.sgs.com/en/Terms-and-Conditions.aspx> and, for electronic format documents, subject to Terms and Conditions for Electronic Documents at <http://www.sgs.com/en/Terms-and-Conditions/Terms-e-Documents.aspx>. Attention is drawn to the limitation of liability, indemnification and jurisdiction issues defined therein. Any holder of this document is advised that information contained hereon reflects the Company's findings at the time of its intervention only and within the limits of Client's instructions, if any. The Company's sole responsibility is to its Client and this document does not exonerate parties to a transaction from exercising all their rights and obligations under the transaction documents. This document cannot be reproduced except in full, without prior written approval of the Company. Any unauthorized alteration, forgery or falsification of the content or appearance of this document is unlawful and offenders may be prosecuted to the fullest extent of the law. Unless otherwise stated the results shown in this test report refer only to the sample(s) tested and such sample(s) are retained for 30 days only.

Test Mode: 07; Polarity: Horizontal; Modulation:802.11ax; Bandwidth:20MHz; Channel:High

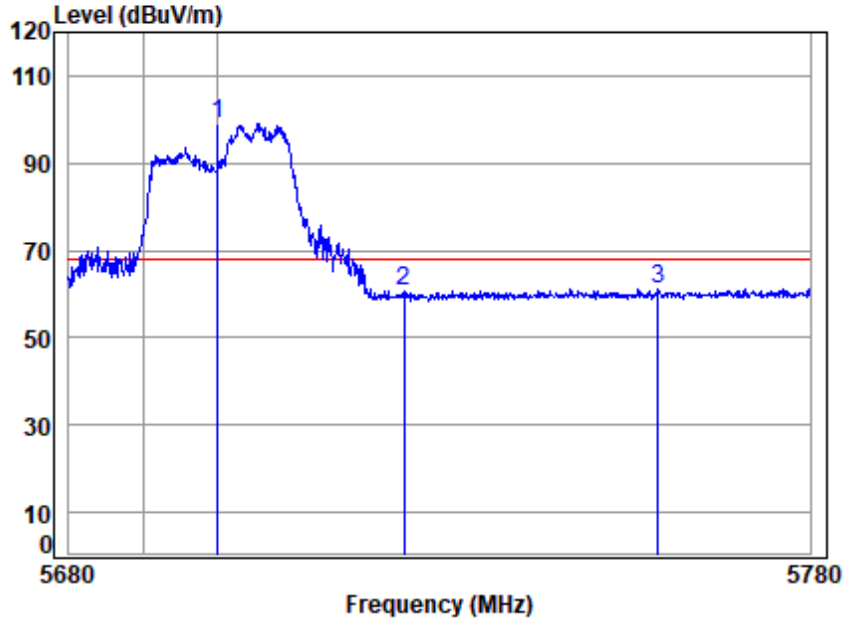

Site : chamber
 Condition: 3m HORIZONTAL
 Job No : 00750AT\00751AT
 Mode : 5700 Band edge
 : 5G WIFI 11AX20 106 RU

		Cable	Ant	Preamp	Read	Limit	Over	
Freq	Loss	Factor	Factor	Factor	Level	Level	Line	Limit
MHz	dB		dB/m	dB	dBuV	dBuV/m	dBuV/m	dB
1 q 5700.000	7.89		34.50	35.02	91.49	98.86	68.20	30.66 peak
2 5725.000	7.92		34.50	35.02	53.14	60.54	68.20	-7.66 peak
3 5759.357	7.95		34.52	35.03	53.71	61.15	68.20	-7.05 peak



Unless otherwise agreed in writing, this document is issued by the Company subject to its General Conditions of Service printed overleaf, available on request or accessible at <http://www.sgs.com/en/Terms-and-Conditions.aspx> and, for electronic format documents, subject to Terms and Conditions for Electronic Documents at <http://www.sgs.com/en/Terms-and-Conditions/Terms-e-Documents.aspx>. Attention is drawn to the limitation of liability, indemnification and jurisdiction issues defined therein. Any holder of this document is advised that information contained hereon reflects the Company's findings at the time of its intervention only and within the limits of Client's instructions, if any. The Company's sole responsibility is to its Client and this document does not exonerate parties to a transaction from exercising all their rights and obligations under the transaction documents. This document cannot be reproduced except in full, without prior written approval of the Company. Any unauthorized alteration, forgery or falsification of the content or appearance of this document is unlawful and offenders may be prosecuted to the fullest extent of the law. Unless otherwise stated the results shown in this test report refer only to the sample(s) tested and such sample(s) are retained for 30 days only.

Test Mode: 07; Polarity: Vertical; Modulation:802.11ax; Bandwidth:20MHz; Channel:High

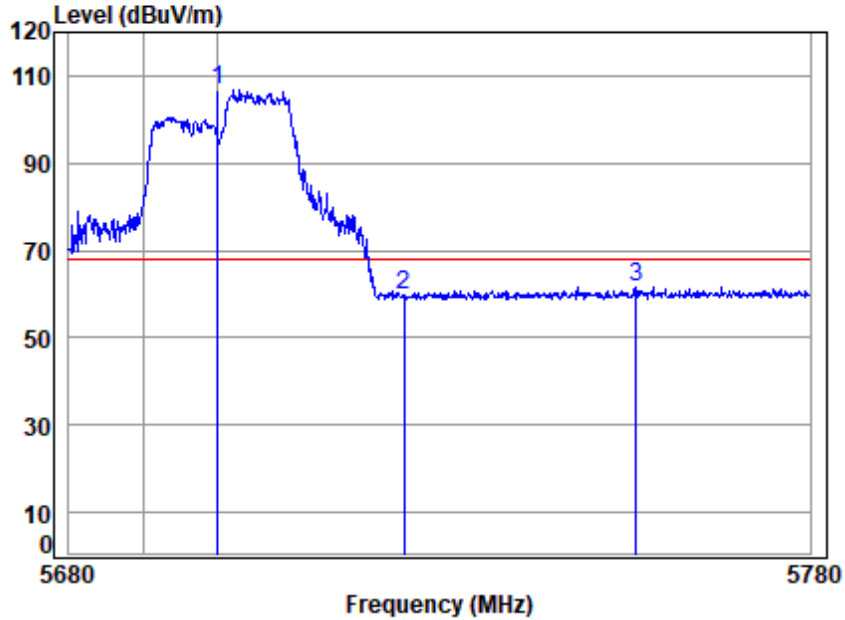

Site : chamber
 Condition: 3m VERTICAL
 Job No : 00750AT\00751AT
 Mode : 5700 Band edge
 : 5G WIFI 11AX20 106 RU

		Cable	Ant	Preamp	Read	Limit	Over	
Freq	Loss	Factor	Factor	Factor	Level	Line	Limit	Remark
MHz	dB	dB/m	dB/m	dB	dBuV	dBuV/m	dBuV/m	dB
1 q 5700.000	7.89	34.50	35.02	99.54	106.91	68.20	38.71	Peak
2 5725.000	7.92	34.50	35.02	52.52	59.92	68.20	-8.28	Peak
3 5756.443	7.94	34.51	35.03	54.26	61.68	68.20	-6.52	Peak



Unless otherwise agreed in writing, this document is issued by the Company subject to its General Conditions of Service printed overleaf, available on request or accessible at <http://www.sgs.com/en/Terms-and-Conditions.aspx> and, for electronic format documents, subject to Terms and Conditions for Electronic Documents at <http://www.sgs.com/en/Terms-and-Conditions/Terms-e-Documents.aspx>. Attention is drawn to the limitation of liability, indemnification and jurisdiction issues defined therein. Any holder of this document is advised that information contained hereon reflects the Company's findings at the time of its intervention only and within the limits of Client's instructions, if any. The Company's sole responsibility is to its Client and this document does not exonerate parties to a transaction from exercising all their rights and obligations under the transaction documents. This document cannot be reproduced except in full, without prior written approval of the Company. Any unauthorized alteration, forgery or falsification of the content or appearance of this document is unlawful and offenders may be prosecuted to the fullest extent of the law. Unless otherwise stated the results shown in this test report refer only to the sample(s) tested and such sample(s) are retained for 30 days only.

Test Mode: 07; Polarity: Horizontal; Modulation:802.11ax; Bandwidth:20MHz; Channel:High

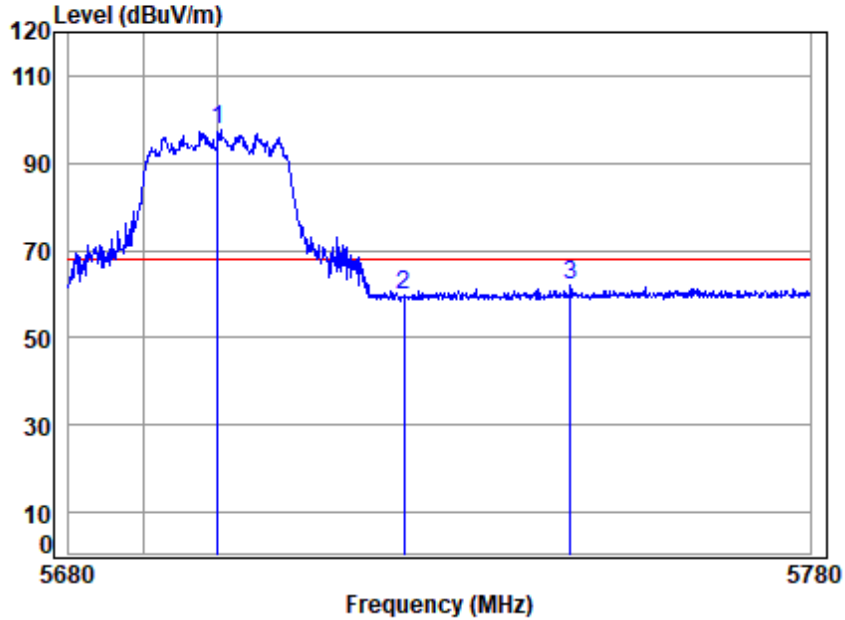

Site : chamber
 Condition: 3m HORIZONTAL
 Job No : 00750AT\00751AT
 Mode : 5700 Band edge
 : 5G WIFI 11AX20 242 RU

	Cable	Ant	Preamp	Read	Limit	Over		
Freq	Loss	Factor	Factor	Level	Level	Line	Limit	Remark
MHz	dB	dB/m	dB	dBuV	dBuV/m	dBuV/m	dB	
1 q 5700.000	7.89	34.50	35.02	90.14	97.51	68.20	29.31	peak
2 5725.000	7.92	34.50	35.02	52.20	59.60	68.20	-8.60	peak
3 5747.509	7.94	34.50	35.03	54.59	62.00	68.20	-6.20	peak



Unless otherwise agreed in writing, this document is issued by the Company subject to its General Conditions of Service printed overleaf, available on request or accessible at <http://www.sgs.com/en/Terms-and-Conditions.aspx> and, for electronic format documents, subject to Terms and Conditions for Electronic Documents at <http://www.sgs.com/en/Terms-and-Conditions/Terms-e-Documents.aspx>. Attention is drawn to the limitation of liability, indemnification and jurisdiction issues defined therein. Any holder of this document is advised that information contained hereon reflects the Company's findings at the time of its intervention only and within the limits of Client's instructions, if any. The Company's sole responsibility is to its Client and this document does not exonerate parties to a transaction from exercising all their rights and obligations under the transaction documents. This document cannot be reproduced except in full, without prior written approval of the Company. Any unauthorized alteration, forgery or falsification of the content or appearance of this document is unlawful and offenders may be prosecuted to the fullest extent of the law. Unless otherwise stated the results shown in this test report refer only to the sample(s) tested and such sample(s) are retained for 30 days only.

Test Mode: 07; Polarity: Vertical; Modulation:802.11ax; Bandwidth:20MHz; Channel:High

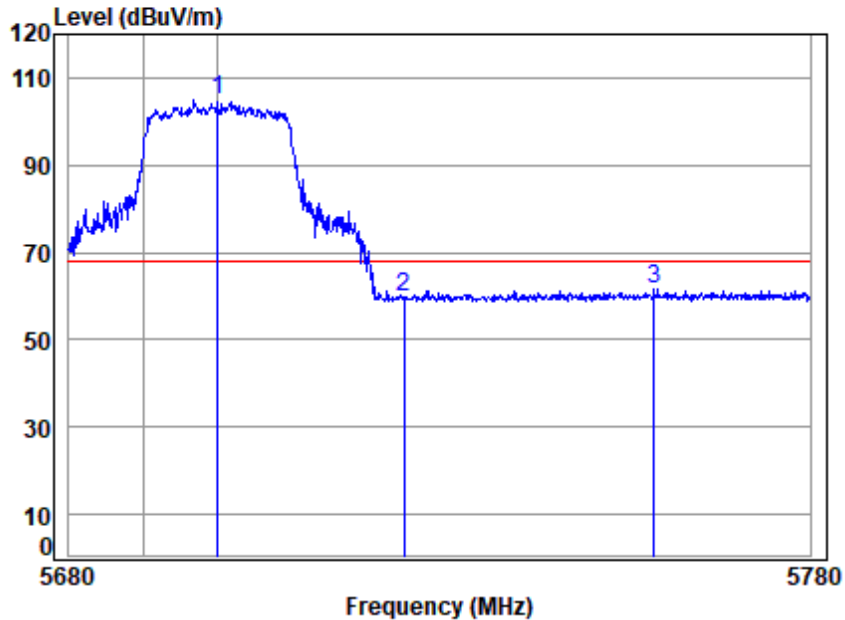

Site : chamber
 Condition: 3m VERTICAL
 Job No : 00750AT\00751AT
 Mode : 5700 Band edge
 : 5G WIFI 11AX20 242 RU

	Cable	Ant	Preamp	Read	Limit	Over		
Freq	Loss	Factor	Factor	Level	Level	Line	Limit	Remark
MHz	dB	dB/m	dB	dBuV	dBuV/m	dBuV/m	dB	
1 q 5700.000	7.89	34.50	35.02	97.52	104.89	68.20	36.69	Peak
2 5725.000	7.92	34.50	35.02	52.46	59.86	68.20	-8.34	Peak
3 5758.855	7.95	34.52	35.03	54.11	61.55	68.20	-6.65	Peak



Unless otherwise agreed in writing, this document is issued by the Company subject to its General Conditions of Service printed overleaf, available on request or accessible at <http://www.sgs.com/en/Terms-and-Conditions.aspx> and, for electronic format documents, subject to Terms and Conditions for Electronic Documents at <http://www.sgs.com/en/Terms-and-Conditions/Terms-e-Documents.aspx>. Attention is drawn to the limitation of liability, indemnification and jurisdiction issues defined therein. Any holder of this document is advised that information contained hereon reflects the Company's findings at the time of its intervention only and within the limits of Client's instructions, if any. The Company's sole responsibility is to its Client and this document does not exonerate parties to a transaction from exercising all their rights and obligations under the transaction documents. This document cannot be reproduced except in full, without prior written approval of the Company. Any unauthorized alteration, forgery or falsification of the content or appearance of this document is unlawful and offenders may be prosecuted to the fullest extent of the law. Unless otherwise stated the results shown in this test report refer only to the sample(s) tested and such sample(s) are retained for 30 days only.

Test Mode: 07; Polarity: Horizontal; Modulation:802.11ax; Bandwidth:40MHz; Channel:Low

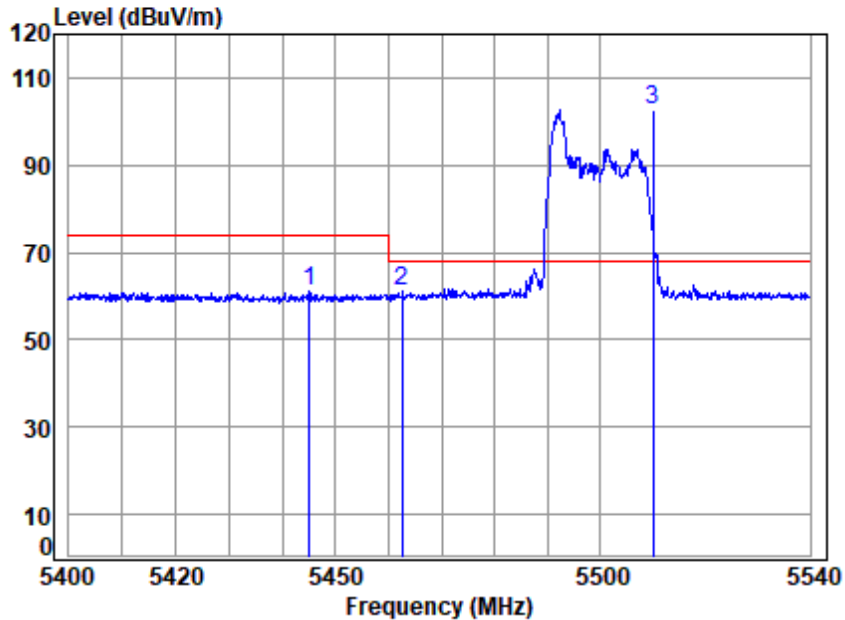

Site : chamber
 Condition: 3m HORIZONTAL
 Job No : 00750AT\00751AT
 Mode : 5510 Band edge
 : 5G WIFI 11AX40 26 RU

	Cable	Ant	Preamp	Read	Limit	Over		
Freq	Loss	Factor	Factor	Level	Level	Line	Limit	Remark
MHz	dB	dB/m	dB	dBuV	dBuV/m	dBuV/m	dB	
1	5445.107	7.65	34.59	35.01	53.95	61.18	74.00	-12.82 peak
2	5462.557	7.67	34.60	35.01	53.85	61.11	68.20	-7.09 peak
3 q	5510.000	7.72	34.60	35.01	95.40	102.71	68.20	34.51 peak



Unless otherwise agreed in writing, this document is issued by the Company subject to its General Conditions of Service printed overleaf, available on request or accessible at <http://www.sgs.com/en/Terms-and-Conditions.aspx> and, for electronic format documents, subject to Terms and Conditions for Electronic Documents at <http://www.sgs.com/en/Terms-and-Conditions/Terms-e-Documents.aspx>. Attention is drawn to the limitation of liability, indemnification and jurisdiction issues defined therein. Any holder of this document is advised that information contained hereon reflects the Company's findings at the time of its intervention only and within the limits of Client's instructions, if any. The Company's sole responsibility is to its Client and this document does not exonerate parties to a transaction from exercising all their rights and obligations under the transaction documents. This document cannot be reproduced except in full, without prior written approval of the Company. Any unauthorized alteration, forgery or falsification of the content or appearance of this document is unlawful and offenders may be prosecuted to the fullest extent of the law. Unless otherwise stated the results shown in this test report refer only to the sample(s) tested and such sample(s) are retained for 30 days only.

Test Mode: 07; Polarity: Horizontal; Modulation:802.11ax; Bandwidth:40MHz; Channel:Low

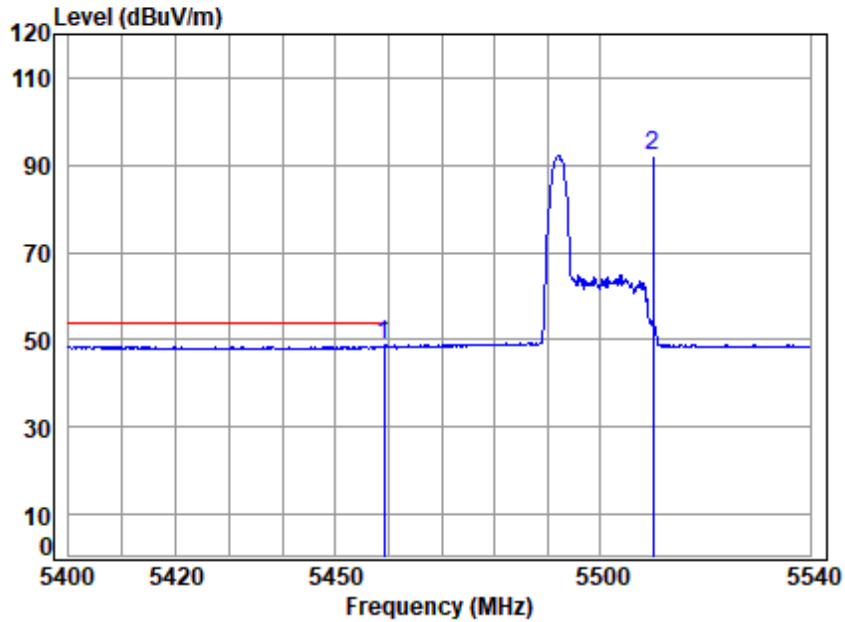

Site : chamber
 Condition: 3m HORIZONTAL
 Job No : 00750AT\00751AT
 Mode : 5510 Band edge
 : 5G WIFI 11AX40 26 RU

	Cable	Ant	Preamp	Read	Limit	Over		
Freq	Loss	Factor	Factor	Level	Level	Line	Limit	Remark
MHz	dB	dB/m	dB	dBuV	dBuV/m	dBuV/m	dB	
1 q 5459.063	7.67	34.60	35.01	41.39	48.65	54.00	-5.35	Average
2 5510.000	7.72	34.60	35.01	85.03	92.34	-----	-----	Average



Unless otherwise agreed in writing, this document is issued by the Company subject to its General Conditions of Service printed overleaf, available on request or accessible at <http://www.sgs.com/en/Terms-and-Conditions.aspx> and, for electronic format documents, subject to Terms and Conditions for Electronic Documents at <http://www.sgs.com/en/Terms-and-Conditions/Terms-e-Documents.aspx>. Attention is drawn to the limitation of liability, indemnification and jurisdiction issues defined therein. Any holder of this document is advised that information contained hereon reflects the Company's findings at the time of its intervention only and within the limits of Client's instructions, if any. The Company's sole responsibility is to its Client and this document does not exonerate parties to a transaction from exercising all their rights and obligations under the transaction documents. This document cannot be reproduced except in full, without prior written approval of the Company. Any unauthorized alteration, forgery or falsification of the content or appearance of this document is unlawful and offenders may be prosecuted to the fullest extent of the law. Unless otherwise stated the results shown in this test report refer only to the sample(s) tested and such sample(s) are retained for 30 days only.

Test Mode: 07; Polarity: Vertical; Modulation:802.11ax; Bandwidth:40MHz; Channel:Low

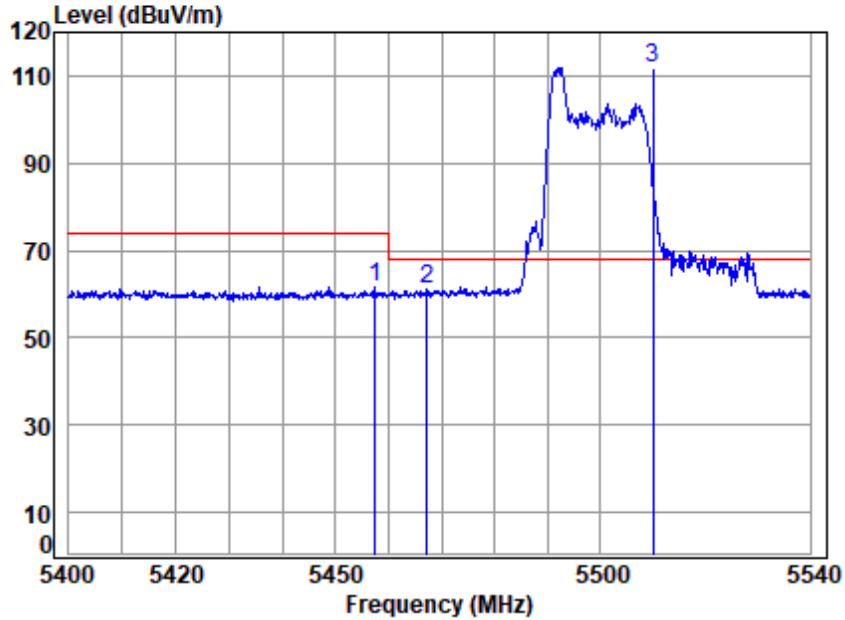

Site : chamber
 Condition: 3m VERTICAL
 Job No : 00750AT\00751AT
 Mode : 5510 Band edge
 : 5G WIFI 11AX40 26 RU

	Cable	Ant	Preamp	Read	Limit	Over		
Freq	Loss	Factor	Factor	Level	Level	Line	Limit	Remark
MHz	dB	dB/m	dB	dBuV	dBuV/m	dBuV/m	dB	
1	5457.526	7.67	34.60	35.01	54.30	61.56	74.00	-12.44 Peak
2	5467.173	7.68	34.60	35.01	54.03	61.30	68.20	-6.90 peak
3 q	5510.000	7.72	34.60	35.01	104.57	111.88	68.20	43.68 Peak



Unless otherwise agreed in writing, this document is issued by the Company subject to its General Conditions of Service printed overleaf, available on request or accessible at <http://www.sgs.com/en/Terms-and-Conditions.aspx> and, for electronic format documents, subject to Terms and Conditions for Electronic Documents at <http://www.sgs.com/en/Terms-and-Conditions/Terms-e-Documents.aspx>. Attention is drawn to the limitation of liability, indemnification and jurisdiction issues defined therein. Any holder of this document is advised that information contained hereon reflects the Company's findings at the time of its intervention only and within the limits of Client's instructions, if any. The Company's sole responsibility is to its Client and this document does not exonerate parties to a transaction from exercising all their rights and obligations under the transaction documents. This document cannot be reproduced except in full, without prior written approval of the Company. Any unauthorized alteration, forgery or falsification of the content or appearance of this document is unlawful and offenders may be prosecuted to the fullest extent of the law. Unless otherwise stated the results shown in this test report refer only to the sample(s) tested and such sample(s) are retained for 30 days only.

Test Mode: 07; Polarity: Vertical; Modulation:802.11ax; Bandwidth:40MHz; Channel:Low

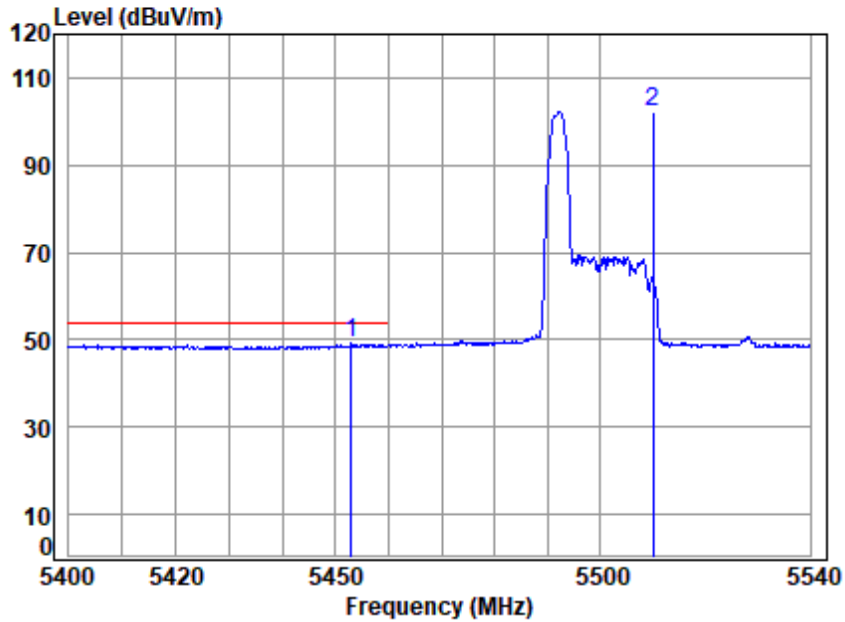

Site : chamber
 Condition: 3m VERTICAL
 Job No : 00750AT\00751AT
 Mode : 5510 Band edge
 : 5G WIFI 11AX40 26 RU

	Cable	Ant	Preamp	Read	Limit	Over		
Freq	Loss	Factor	Factor	Level	Level	Line	Limit	Remark
MHz	dB	dB/m	dB	dBuV	dBuV/m	dBuV/m	dB	
1 q 5452.918	7.66	34.60	35.01	41.84	49.09	54.00	-4.91	Average
2 5510.000	7.72	34.60	35.01	94.89	102.20	-----	-----	Average



Unless otherwise agreed in writing, this document is issued by the Company subject to its General Conditions of Service printed overleaf, available on request or accessible at <http://www.sgs.com/en/Terms-and-Conditions.aspx> and, for electronic format documents, subject to Terms and Conditions for Electronic Documents at <http://www.sgs.com/en/Terms-and-Conditions/Terms-e-Documents.aspx>. Attention is drawn to the limitation of liability, indemnification and jurisdiction issues defined therein. Any holder of this document is advised that information contained hereon reflects the Company's findings at the time of its intervention only and within the limits of Client's instructions, if any. The Company's sole responsibility is to its Client and this document does not exonerate parties to a transaction from exercising all their rights and obligations under the transaction documents. This document cannot be reproduced except in full, without prior written approval of the Company. Any unauthorized alteration, forgery or falsification of the content or appearance of this document is unlawful and offenders may be prosecuted to the fullest extent of the law. Unless otherwise stated the results shown in this test report refer only to the sample(s) tested and such sample(s) are retained for 30 days only.

Test Mode: 07; Polarity: Horizontal; Modulation:802.11ax; Bandwidth:40MHz; Channel:Low

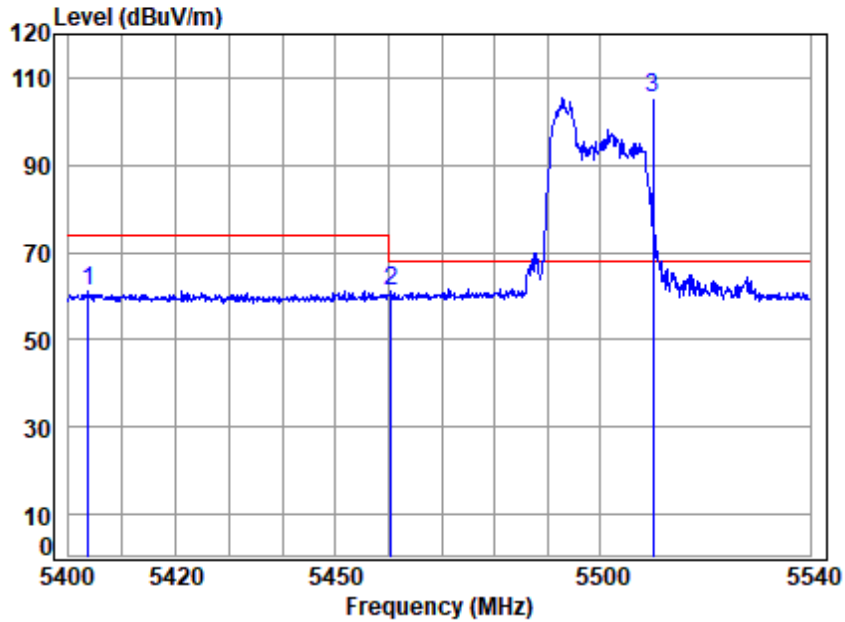

Site : chamber
 Condition: 3m HORIZONTAL
 Job No : 00750AT\00751AT
 Mode : 5510 Band edge
 : 5G WIFI 11AX40 52 RU

	Cable	Ant	Preamp	Read	Limit	Over	
Freq	Loss	Factor	Factor	Level	Level	Line	Limit
MHz	dB	dB/m	dB	dBuV	dBuV/m	dBuV/m	dB
1	7.61	34.51	35.01	53.99	61.10	74.00	-12.90 peak
2	7.67	34.60	35.01	54.06	61.32	68.20	-6.88 peak
3 q	7.72	34.60	35.01	98.08	105.39	68.20	37.19 peak



Unless otherwise agreed in writing, this document is issued by the Company subject to its General Conditions of Service printed overleaf, available on request or accessible at <http://www.sgs.com/en/Terms-and-Conditions.aspx> and, for electronic format documents, subject to Terms and Conditions for Electronic Documents at <http://www.sgs.com/en/Terms-and-Conditions/Terms-e-Documents.aspx>. Attention is drawn to the limitation of liability, indemnification and jurisdiction issues defined therein. Any holder of this document is advised that information contained hereon reflects the Company's findings at the time of its intervention only and within the limits of Client's instructions, if any. The Company's sole responsibility is to its Client and this document does not exonerate parties to a transaction from exercising all their rights and obligations under the transaction documents. This document cannot be reproduced except in full, without prior written approval of the Company. Any unauthorized alteration, forgery or falsification of the content or appearance of this document is unlawful and offenders may be prosecuted to the fullest extent of the law. Unless otherwise stated the results shown in this test report refer only to the sample(s) tested and such sample(s) are retained for 30 days only.

Test Mode: 07; Polarity: Horizontal; Modulation:802.11ax; Bandwidth:40MHz; Channel:Low

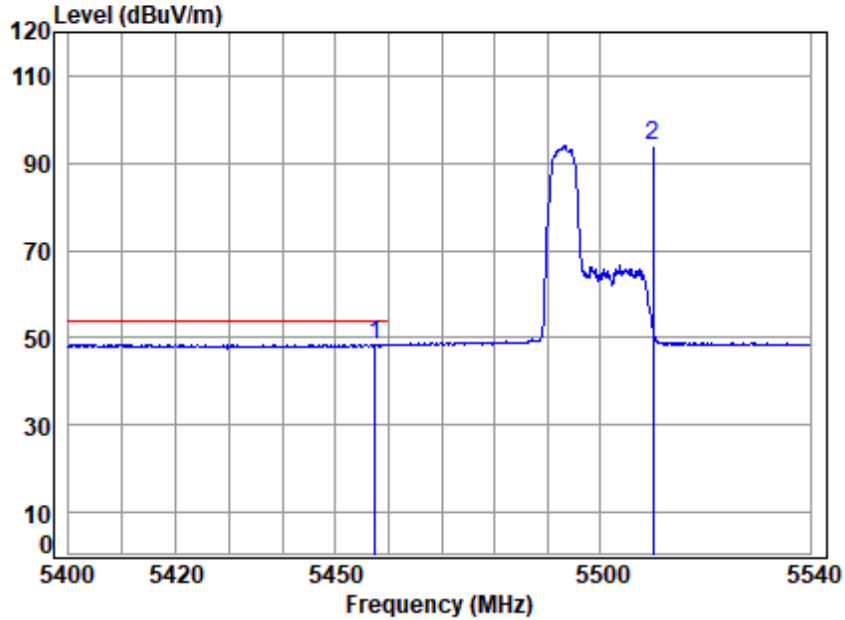

Site : chamber
 Condition: 3m HORIZONTAL
 Job No : 00750AT\00751AT
 Mode : 5510 Band edge
 : 5G WIFI 11AX40 52 RU

	Cable	Ant	Preamp	Read	Limit	Over		
Freq	Loss	Factor	Factor	Level	Level	Line	Limit	Remark
MHz	dB	dB/m	dB	dBuV	dBuV/m	dBuV/m	dB	
1 q 5457.526	7.67	34.60	35.01	41.27	48.53	54.00	-5.47	Average
2 5510.000	7.72	34.60	35.01	86.57	93.88	-----	-----	Average



Unless otherwise agreed in writing, this document is issued by the Company subject to its General Conditions of Service printed overleaf, available on request or accessible at <http://www.sgs.com/en/Terms-and-Conditions.aspx> and, for electronic format documents, subject to Terms and Conditions for Electronic Documents at <http://www.sgs.com/en/Terms-and-Conditions/Terms-e-Documents.aspx>. Attention is drawn to the limitation of liability, indemnification and jurisdiction issues defined therein. Any holder of this document is advised that information contained hereon reflects the Company's findings at the time of its intervention only and within the limits of Client's instructions, if any. The Company's sole responsibility is to its Client and this document does not exonerate parties to a transaction from exercising all their rights and obligations under the transaction documents. This document cannot be reproduced except in full, without prior written approval of the Company. Any unauthorized alteration, forgery or falsification of the content or appearance of this document is unlawful and offenders may be prosecuted to the fullest extent of the law. Unless otherwise stated the results shown in this test report refer only to the sample(s) tested and such sample(s) are retained for 30 days only.

Test Mode: 07; Polarity: Vertical; Modulation:802.11ax; Bandwidth:40MHz; Channel:Low

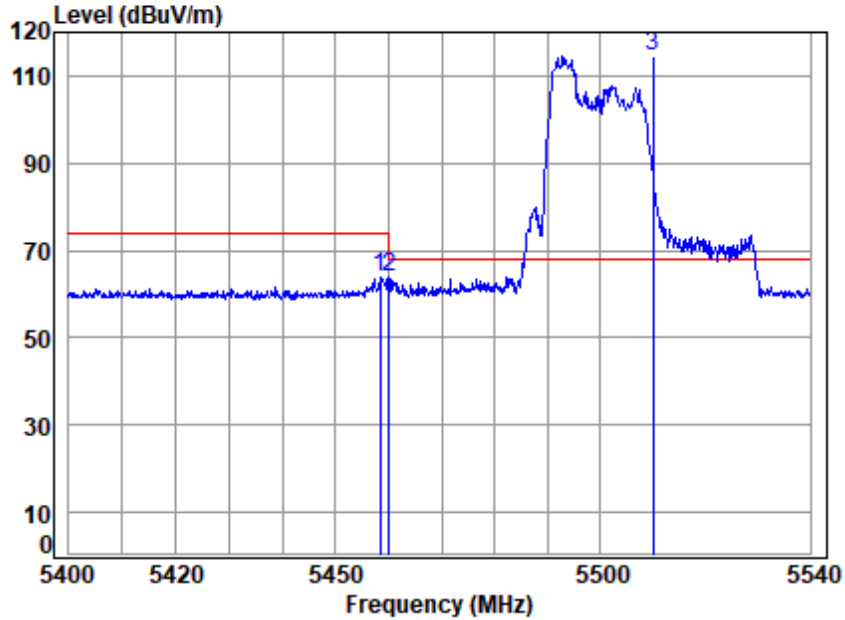

Site : chamber
 Condition: 3m VERTICAL
 Job No : 00750AT\00751AT
 Mode : 5510 Band edge
 : 5G WIFI 11AX40 52 RU

	Cable	Ant	Preamp	Read	Limit	Over		
Freq	Loss	Factor	Factor	Level	Level	Line	Limit	Remark
MHz	dB	dB/m	dB	dBuV	dBuV/m	dBuV/m	dB	
1	7.67	34.60	35.01	56.79	64.05	74.00	-9.95	Peak
2	7.67	34.60	35.01	56.83	64.09	68.20	-4.11	peak
3 q	7.72	34.60	35.01	107.43	114.74	68.20	46.54	Peak



Unless otherwise agreed in writing, this document is issued by the Company subject to its General Conditions of Service printed overleaf, available on request or accessible at <http://www.sgs.com/en/Terms-and-Conditions.aspx> and, for electronic format documents, subject to Terms and Conditions for Electronic Documents at <http://www.sgs.com/en/Terms-and-Conditions/Terms-e-Documents.aspx>. Attention is drawn to the limitation of liability, indemnification and jurisdiction issues defined therein. Any holder of this document is advised that information contained hereon reflects the Company's findings at the time of its intervention only and within the limits of Client's instructions, if any. The Company's sole responsibility is to its Client and this document does not exonerate parties to a transaction from exercising all their rights and obligations under the transaction documents. This document cannot be reproduced except in full, without prior written approval of the Company. Any unauthorized alteration, forgery or falsification of the content or appearance of this document is unlawful and offenders may be prosecuted to the fullest extent of the law. Unless otherwise stated the results shown in this test report refer only to the sample(s) tested and such sample(s) are retained for 30 days only.

Test Mode: 07; Polarity: Vertical; Modulation:802.11ax; Bandwidth:40MHz; Channel:Low

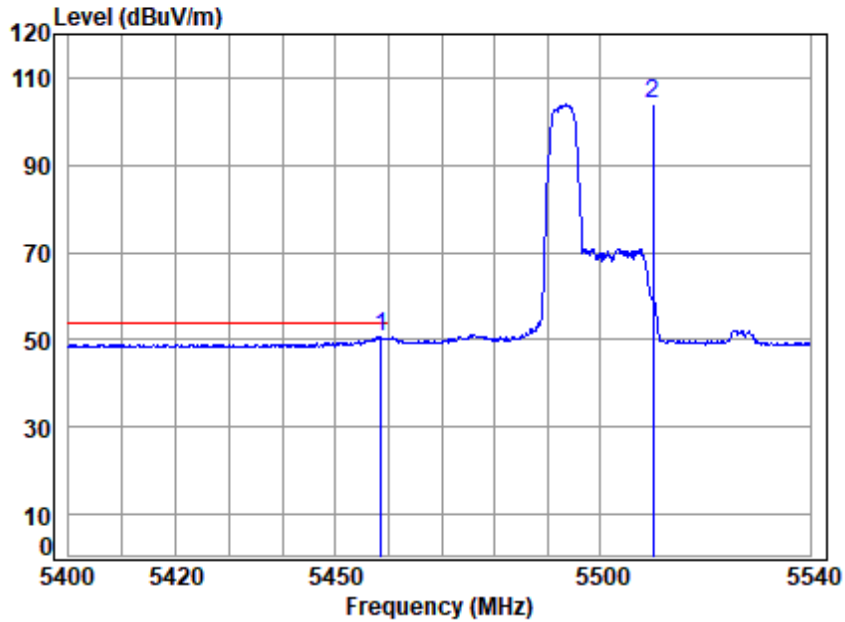

Site : chamber
 Condition: 3m VERTICAL
 Job No : 00750AT\00751AT
 Mode : 5510 Band edge
 : 5G WIFI 11AX40 52 RU

	Cable	Ant	Preamp	Read	Limit	Over		
Freq	Loss	Factor	Factor	Level	Level	Line	Limit	Remark
MHz	dB	dB/m	dB	dBuV	dBuV/m	dBuV/m	dB	
1 q 5458.643	7.67	34.60	35.01	43.37	50.63	54.00	-3.37	Average
2 5510.000	7.72	34.60	35.01	96.55	103.86	-----	-----	Average



Unless otherwise agreed in writing, this document is issued by the Company subject to its General Conditions of Service printed overleaf, available on request or accessible at <http://www.sgs.com/en/Terms-and-Conditions.aspx> and, for electronic format documents, subject to Terms and Conditions for Electronic Documents at <http://www.sgs.com/en/Terms-and-Conditions/Terms-e-Documents.aspx>. Attention is drawn to the limitation of liability, indemnification and jurisdiction issues defined therein. Any holder of this document is advised that information contained hereon reflects the Company's findings at the time of its intervention only and within the limits of Client's instructions, if any. The Company's sole responsibility is to its Client and this document does not exonerate parties to a transaction from exercising all their rights and obligations under the transaction documents. This document cannot be reproduced except in full, without prior written approval of the Company. Any unauthorized alteration, forgery or falsification of the content or appearance of this document is unlawful and offenders may be prosecuted to the fullest extent of the law. Unless otherwise stated the results shown in this test report refer only to the sample(s) tested and such sample(s) are retained for 30 days only.

Test Mode: 07; Polarity: Horizontal; Modulation:802.11ax; Bandwidth:40MHz; Channel:Low

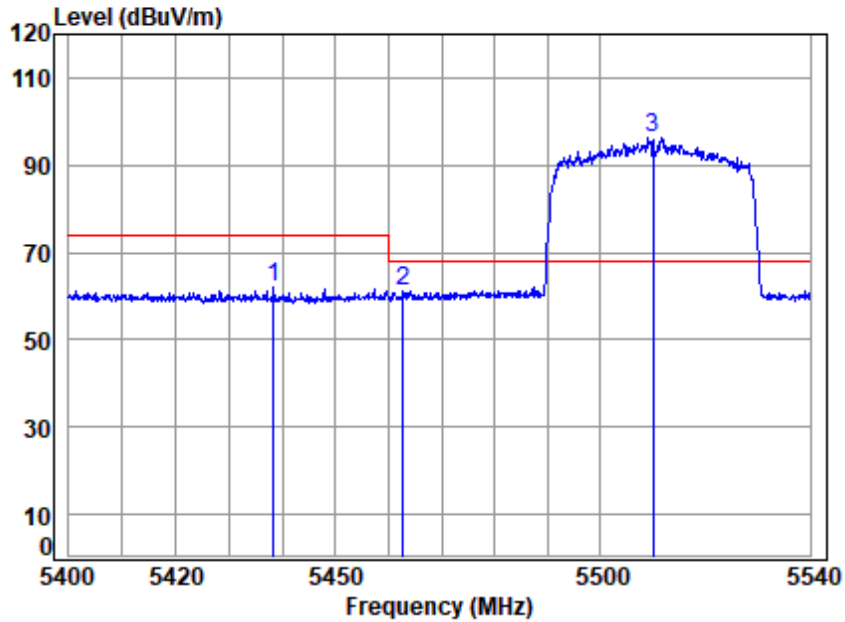

Site : chamber
 Condition: 3m HORIZONTAL
 Job No : 00750AT\00751AT
 Mode : 5510 Band edge
 : 5G WIFI 11AX40 484 RU

		Cable	Ant	Preamp	Read	Limit	Over	
	Freq	Loss	Factor	Factor	Level	Level	Line	Limit
	MHz	dB	dB/m	dB	dBuV	dBuV/m	dBuV/m	dB
1	5438.283	7.65	34.58	35.01	54.73	61.95	74.00	-12.05 peak
2	5462.697	7.67	34.60	35.01	53.94	61.20	68.20	-7.00 peak
3 q	5510.000	7.72	34.60	35.01	89.14	96.45	68.20	28.25 peak



Unless otherwise agreed in writing, this document is issued by the Company subject to its General Conditions of Service printed overleaf, available on request or accessible at <http://www.sgs.com/en/Terms-and-Conditions.aspx> and, for electronic format documents, subject to Terms and Conditions for Electronic Documents at <http://www.sgs.com/en/Terms-and-Conditions/Terms-e-Documents.aspx>. Attention is drawn to the limitation of liability, indemnification and jurisdiction issues defined therein. Any holder of this document is advised that information contained hereon reflects the Company's findings at the time of its intervention only and within the limits of Client's instructions, if any. The Company's sole responsibility is to its Client and this document does not exonerate parties to a transaction from exercising all their rights and obligations under the transaction documents. This document cannot be reproduced except in full, without prior written approval of the Company. Any unauthorized alteration, forgery or falsification of the content or appearance of this document is unlawful and offenders may be prosecuted to the fullest extent of the law. Unless otherwise stated the results shown in this test report refer only to the sample(s) tested and such sample(s) are retained for 30 days only.

Test Mode: 07; Polarity: Horizontal; Modulation:802.11ax; Bandwidth:40MHz; Channel:Low

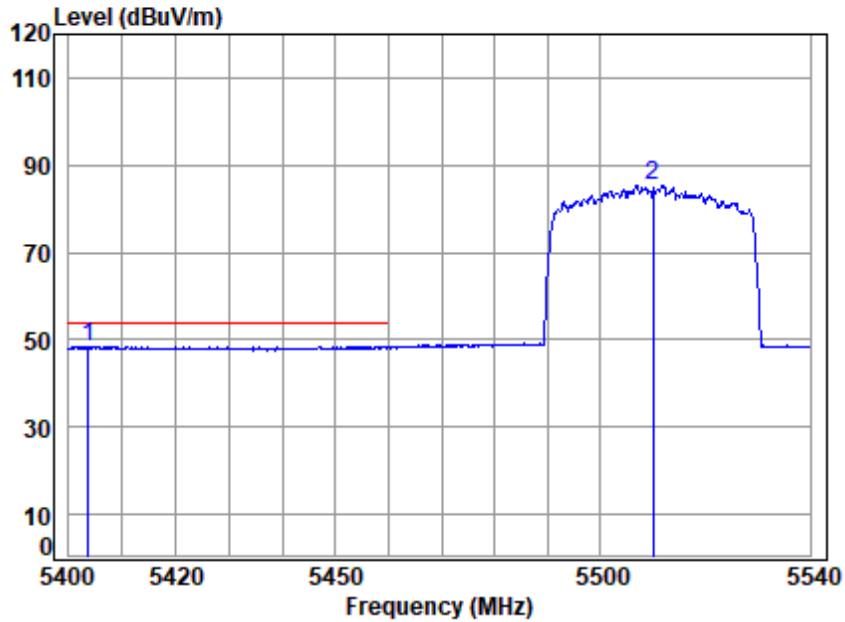

Site : chamber
 Condition: 3m HORIZONTAL
 Job No : 00750AT\00751AT
 Mode : 5510 Band edge
 : 5G WIFI 11AX40 484 RU

	Cable	Ant	Preamp	Read	Limit	Over		
Freq	Loss	Factor	Factor	Level	Level	Line	Limit	Remark
MHz	dB	dB/m	dB	dBuV	dBuV/m	dBuV/m	dB	
1 q 5403.595	7.61	34.51	35.01	41.48	48.59	54.00	-5.41	Average
2 5510.000	7.72	34.60	35.01	77.93	85.24	-----	-----	Average



Unless otherwise agreed in writing, this document is issued by the Company subject to its General Conditions of Service printed overleaf, available on request or accessible at <http://www.sgs.com/en/Terms-and-Conditions.aspx> and, for electronic format documents, subject to Terms and Conditions for Electronic Documents at <http://www.sgs.com/en/Terms-and-Conditions/Terms-e-Documents.aspx>. Attention is drawn to the limitation of liability, indemnification and jurisdiction issues defined therein. Any holder of this document is advised that information contained hereon reflects the Company's findings at the time of its intervention only and within the limits of Client's instructions, if any. The Company's sole responsibility is to its Client and this document does not exonerate parties to a transaction from exercising all their rights and obligations under the transaction documents. This document cannot be reproduced except in full, without prior written approval of the Company. Any unauthorized alteration, forgery or falsification of the content or appearance of this document is unlawful and offenders may be prosecuted to the fullest extent of the law. Unless otherwise stated the results shown in this test report refer only to the sample(s) tested and such sample(s) are retained for 30 days only.
 Attention: To check the authenticity of testing /inspection report & certificate, please contact us at telephone: (86-755) 8307 1443, or email: CN.Doccheck@sgs.com

Test Mode: 07; Polarity: Vertical; Modulation:802.11ax; Bandwidth:40MHz; Channel:Low

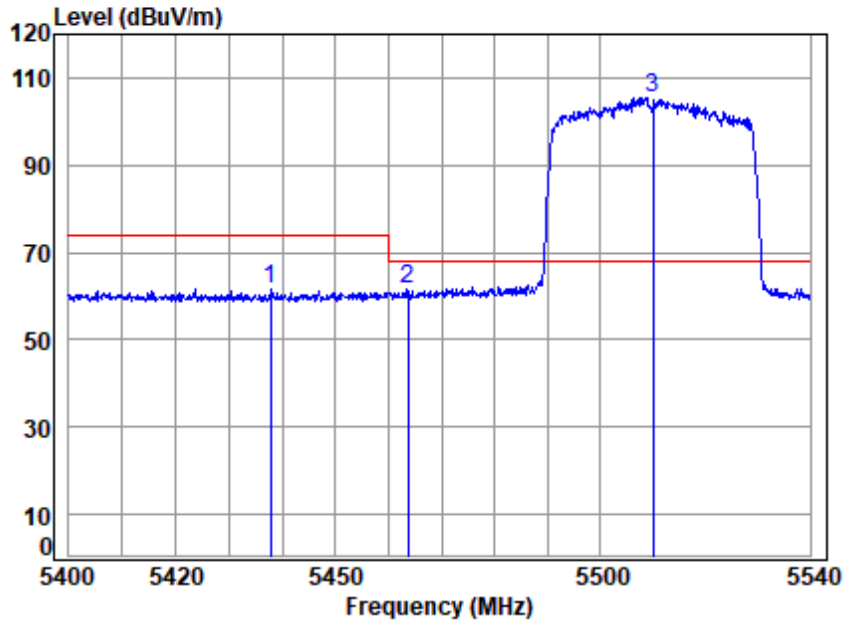

Site : chamber
 Condition: 3m VERTICAL
 Job No : 00750AT\00751AT
 Mode : 5510 Band edge
 : 5G WIFI 11AX40 484 RU

	Cable	Ant	Preamp	Read	Limit	Over		
Freq	Loss	Factor	Factor	Level	Level	Line	Limit	Remark
MHz	dB	dB/m	dB	dBuV	dBuV/m	dBuV/m	dB	
1	5437.726	7.65	34.58	35.01	54.36	61.58	74.00	-12.42 Peak
2	5463.536	7.67	34.60	35.01	54.14	61.40	68.20	-6.80 peak
3 q	5510.000	7.72	34.60	35.01	98.25	105.56	68.20	37.36 Peak



Unless otherwise agreed in writing, this document is issued by the Company subject to its General Conditions of Service printed overleaf, available on request or accessible at <http://www.sgs.com/en/Terms-and-Conditions.aspx> and, for electronic format documents, subject to Terms and Conditions for Electronic Documents at <http://www.sgs.com/en/Terms-and-Conditions/Terms-e-Documents.aspx>. Attention is drawn to the limitation of liability, indemnification and jurisdiction issues defined therein. Any holder of this document is advised that information contained hereon reflects the Company's findings at the time of its intervention only and within the limits of Client's instructions, if any. The Company's sole responsibility is to its Client and this document does not exonerate parties to a transaction from exercising all their rights and obligations under the transaction documents. This document cannot be reproduced except in full, without prior written approval of the Company. Any unauthorized alteration, forgery or falsification of the content or appearance of this document is unlawful and offenders may be prosecuted to the fullest extent of the law. Unless otherwise stated the results shown in this test report refer only to the sample(s) tested and such sample(s) are retained for 30 days only.

Test Mode: 07; Polarity: Vertical; Modulation:802.11ax; Bandwidth:40MHz; Channel:Low

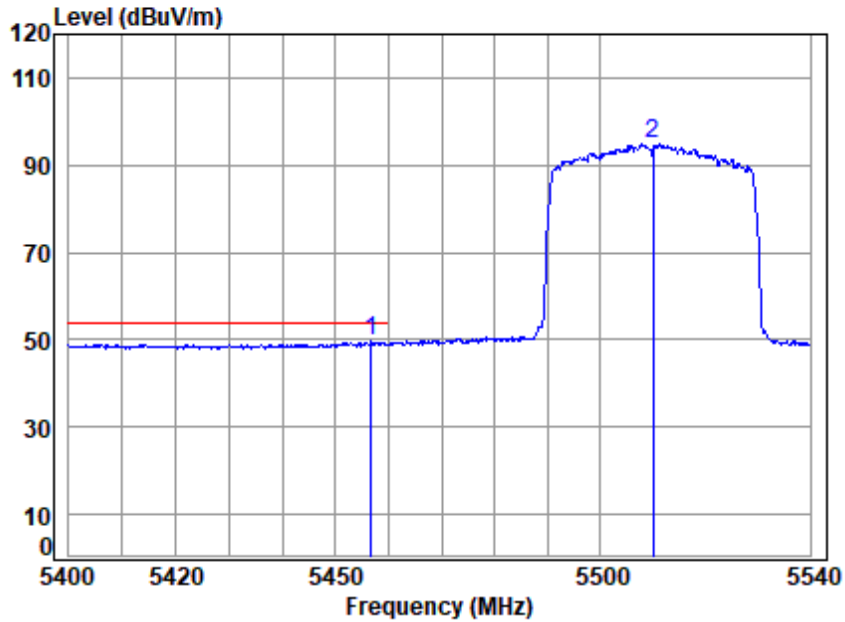

Site : chamber
 Condition: 3m VERTICAL
 Job No : 00750AT\00751AT
 Mode : 5510 Band edge
 : 5G WIFI 11AX40 484 RU

	Cable	Ant	Preamp	Read	Limit	Over		
Freq	Loss	Factor	Factor	Level	Level	Line	Limit	Remark
MHz	dB	dB/m	dB	dBuV	dBuV/m	dBuV/m	dB	
1 q 5456.688	7.67	34.60	35.01	42.30	49.56	54.00	-4.44	Average
2 5510.000	7.72	34.60	35.01	87.59	94.90	-----	-----	Average



Unless otherwise agreed in writing, this document is issued by the Company subject to its General Conditions of Service printed overleaf, available on request or accessible at <http://www.sgs.com/en/Terms-and-Conditions.aspx> and, for electronic format documents, subject to Terms and Conditions for Electronic Documents at <http://www.sgs.com/en/Terms-and-Conditions/Terms-e-Documents.aspx>. Attention is drawn to the limitation of liability, indemnification and jurisdiction issues defined therein. Any holder of this document is advised that information contained hereon reflects the Company's findings at the time of its intervention only and within the limits of Client's instructions, if any. The Company's sole responsibility is to its Client and this document does not exonerate parties to a transaction from exercising all their rights and obligations under the transaction documents. This document cannot be reproduced except in full, without prior written approval of the Company. Any unauthorized alteration, forgery or falsification of the content or appearance of this document is unlawful and offenders may be prosecuted to the fullest extent of the law. Unless otherwise stated the results shown in this test report refer only to the sample(s) tested and such sample(s) are retained for 30 days only.
 Attention: To check the authenticity of testing /inspection report & certificate, please contact us at telephone: (86-755) 8307 1443, or email: CN.Doccheck@sgs.com

Test Mode: 07; Polarity: Horizontal; Modulation:802.11ax; Bandwidth:40MHz; Channel:High

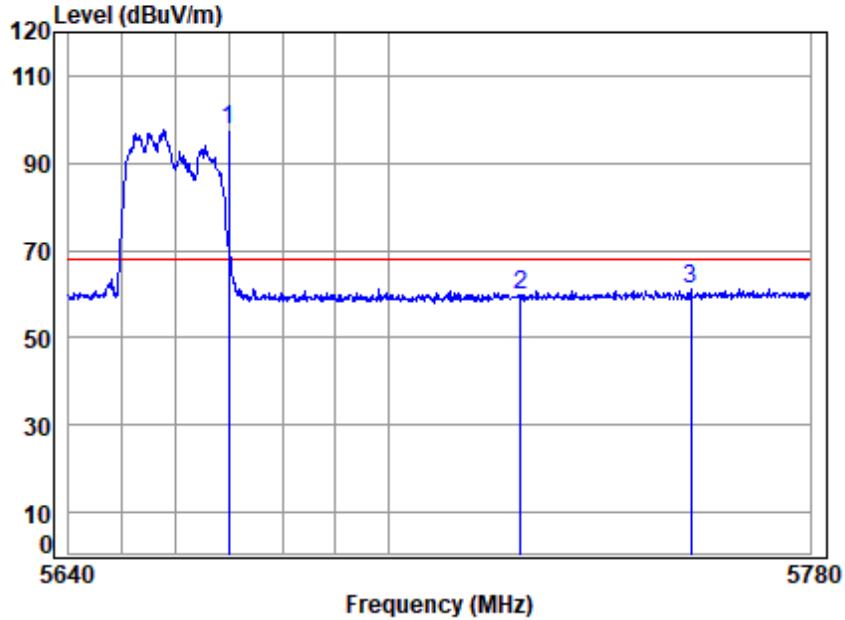

Site : chamber
 Condition: 3m HORIZONTAL
 Job No : 00750AT\00751AT
 Mode : 5670 Band edge
 : 5G WIFI 11AX40 106 RU

	Cable	Ant	Preamp	Read	Limit	Over		
Freq	Loss	Factor	Factor	Level	Level	Line	Limit	Remark
MHz	dB	dB/m	dB	dBuV	dBuV/m	dBuV/m	dB	
1 q 5670.000	7.87	34.50	35.02	90.08	97.43	68.20	29.23	peak
2 5725.000	7.92	34.50	35.02	52.42	59.82	68.20	-8.38	peak
3 5757.228	7.94	34.51	35.03	53.52	60.94	68.20	-7.26	peak



Unless otherwise agreed in writing, this document is issued by the Company subject to its General Conditions of Service printed overleaf, available on request or accessible at <http://www.sgs.com/en/Terms-and-Conditions.aspx> and, for electronic format documents, subject to Terms and Conditions for Electronic Documents at <http://www.sgs.com/en/Terms-and-Conditions/Terms-e-Documents.aspx>. Attention is drawn to the limitation of liability, indemnification and jurisdiction issues defined therein. Any holder of this document is advised that information contained hereon reflects the Company's findings at the time of its intervention only and within the limits of Client's instructions, if any. The Company's sole responsibility is to its Client and this document does not exonerate parties to a transaction from exercising all their rights and obligations under the transaction documents. This document cannot be reproduced except in full, without prior written approval of the Company. Any unauthorized alteration, forgery or falsification of the content or appearance of this document is unlawful and offenders may be prosecuted to the fullest extent of the law. Unless otherwise stated the results shown in this test report refer only to the sample(s) tested and such sample(s) are retained for 30 days only.

Test Mode: 07; Polarity: Vertical; Modulation:802.11ax; Bandwidth:40MHz; Channel:High

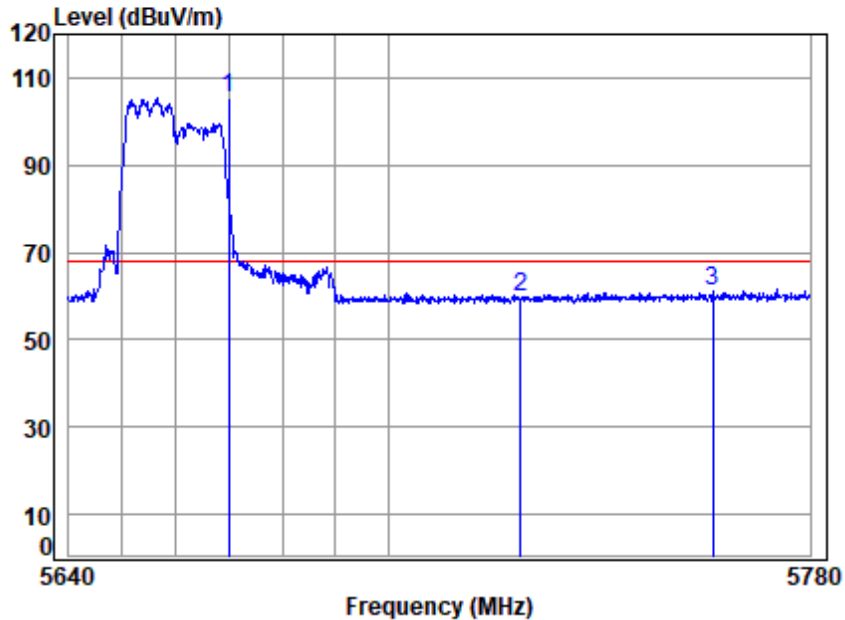

Site : chamber
 Condition: 3m VERTICAL
 Job No : 00750AT\00751AT
 Mode : 5670 Band edge
 : 5G WIFI 11AX40 106 RU

	Cable	Ant	Preamp	Read	Limit	Over		
Freq	Loss	Factor	Factor	Level	Level	Line	Limit	Remark
MHz	dB	dB/m	dB	dBuV	dBuV/m	dBuV/m	dB	
1 q 5670.000	7.87	34.50	35.02	98.00	105.35	68.20	37.15	Peak
2 5725.000	7.92	34.50	35.02	52.16	59.56	68.20	-8.64	Peak
3 5761.464	7.95	34.52	35.03	53.75	61.19	68.20	-7.01	Peak



Unless otherwise agreed in writing, this document is issued by the Company subject to its General Conditions of Service printed overleaf, available on request or accessible at <http://www.sgs.com/en/Terms-and-Conditions.aspx> and, for electronic format documents, subject to Terms and Conditions for Electronic Documents at <http://www.sgs.com/en/Terms-and-Conditions/Terms-e-Documents.aspx>. Attention is drawn to the limitation of liability, indemnification and jurisdiction issues defined therein. Any holder of this document is advised that information contained hereon reflects the Company's findings at the time of its intervention only and within the limits of Client's instructions, if any. The Company's sole responsibility is to its Client and this document does not exonerate parties to a transaction from exercising all their rights and obligations under the transaction documents. This document cannot be reproduced except in full, without prior written approval of the Company. Any unauthorized alteration, forgery or falsification of the content or appearance of this document is unlawful and offenders may be prosecuted to the fullest extent of the law. Unless otherwise stated the results shown in this test report refer only to the sample(s) tested and such sample(s) are retained for 30 days only.

Test Mode: 07; Polarity: Horizontal; Modulation:802.11ax; Bandwidth:40MHz; Channel:High

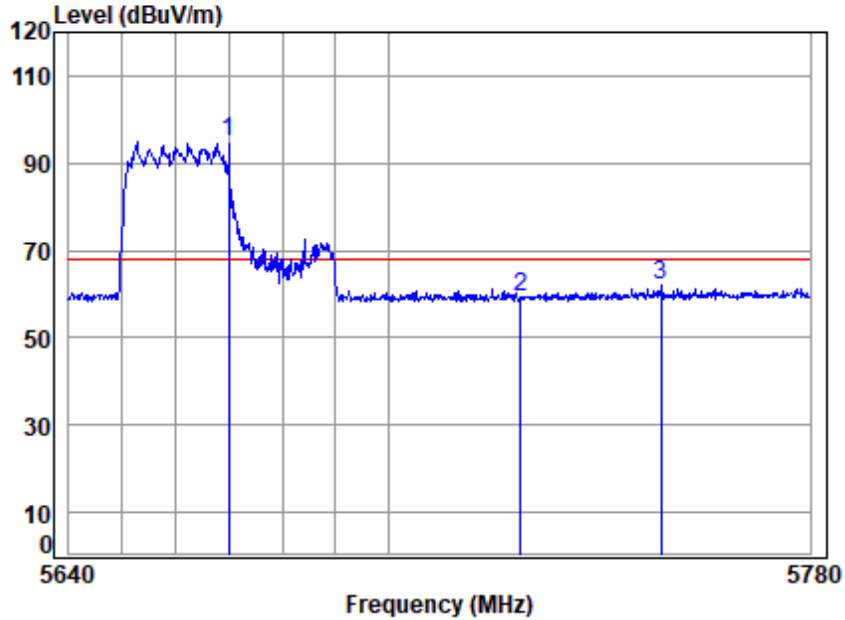

Site : chamber
 Condition: 3m HORIZONTAL
 Job No : 00750AT\00751AT
 Mode : 5670 Band edge
 : 5G WIFI 11AX40 242 RU

	Cable	Ant	Preamp	Read	Limit	Over		
Freq	Loss	Factor	Factor	Level	Level	Line	Limit	Remark
MHz	dB	dB/m	dB	dBuV	dBuV/m	dBuV/m	dB	
1 q 5670.000	7.87	34.50	35.02	87.75	95.10	68.20	26.90	peak
2 5725.000	7.92	34.50	35.02	51.84	59.24	68.20	-8.96	peak
3 5751.583	7.94	34.50	35.03	54.45	61.86	68.20	-6.34	peak



Unless otherwise agreed in writing, this document is issued by the Company subject to its General Conditions of Service printed overleaf, available on request or accessible at <http://www.sgs.com/en/Terms-and-Conditions.aspx> and, for electronic format documents, subject to Terms and Conditions for Electronic Documents at <http://www.sgs.com/en/Terms-and-Conditions/Terms-e-Documents.aspx>. Attention is drawn to the limitation of liability, indemnification and jurisdiction issues defined therein. Any holder of this document is advised that information contained hereon reflects the Company's findings at the time of its intervention only and within the limits of Client's instructions, if any. The Company's sole responsibility is to its Client and this document does not exonerate parties to a transaction from exercising all their rights and obligations under the transaction documents. This document cannot be reproduced except in full, without prior written approval of the Company. Any unauthorized alteration, forgery or falsification of the content or appearance of this document is unlawful and offenders may be prosecuted to the fullest extent of the law. Unless otherwise stated the results shown in this test report refer only to the sample(s) tested and such sample(s) are retained for 30 days only.

Test Mode: 07; Polarity: Vertical; Modulation:802.11ax; Bandwidth:40MHz; Channel:High

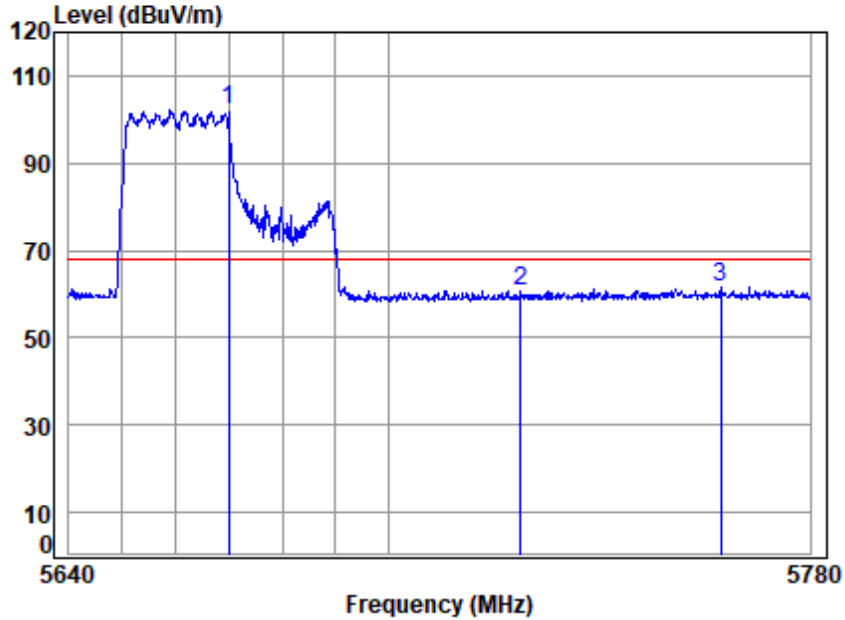

Site : chamber
 Condition: 3m VERTICAL
 Job No : 00750AT\00751AT
 Mode : 5670 Band edge
 : 5G WIFI 11AX40 242 RU

	Cable	Ant	Preamp	Read	Limit	Over		
Freq	Loss	Factor	Factor	Level	Level	Line	Limit	Remark
MHz	dB	dB/m	dB	dBuV	dBuV/m	dBuV/m	dB	
1 q 5670.000	7.87	34.50	35.02	94.64	101.99	68.20	33.79	Peak
2 5725.000	7.92	34.50	35.02	53.36	60.76	68.20	-7.44	Peak
3 5762.877	7.95	34.53	35.03	53.94	61.39	68.20	-6.81	Peak



Unless otherwise agreed in writing, this document is issued by the Company subject to its General Conditions of Service printed overleaf, available on request or accessible at <http://www.sgs.com/en/Terms-and-Conditions.aspx> and, for electronic format documents, subject to Terms and Conditions for Electronic Documents at <http://www.sgs.com/en/Terms-and-Conditions/Terms-e-Documents.aspx>. Attention is drawn to the limitation of liability, indemnification and jurisdiction issues defined therein. Any holder of this document is advised that information contained hereon reflects the Company's findings at the time of its intervention only and within the limits of Client's instructions, if any. The Company's sole responsibility is to its Client and this document does not exonerate parties to a transaction from exercising all their rights and obligations under the transaction documents. This document cannot be reproduced except in full, without prior written approval of the Company. Any unauthorized alteration, forgery or falsification of the content or appearance of this document is unlawful and offenders may be prosecuted to the fullest extent of the law. Unless otherwise stated the results shown in this test report refer only to the sample(s) tested and such sample(s) are retained for 30 days only.

Test Mode: 07; Polarity: Horizontal; Modulation:802.11ax; Bandwidth:40MHz; Channel:High

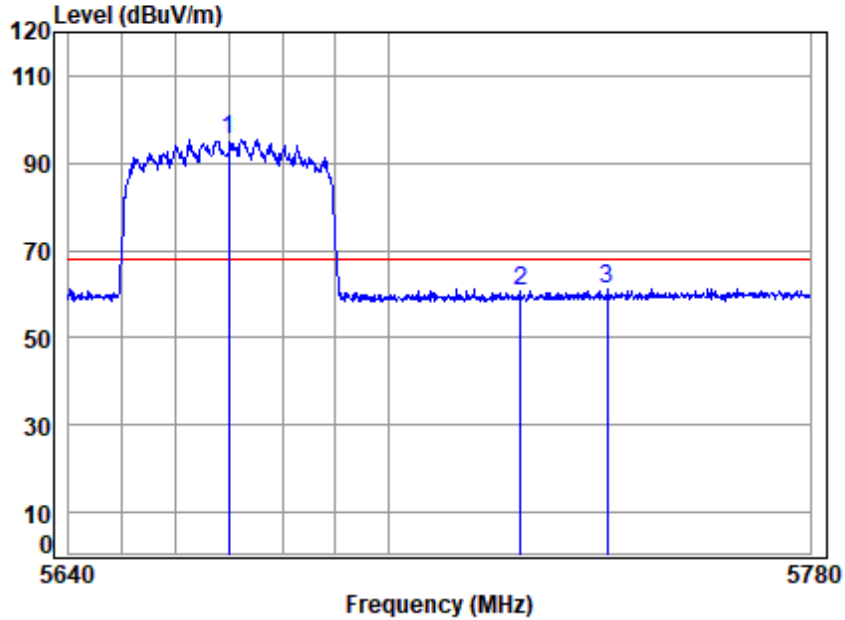

Site : chamber
 Condition: 3m HORIZONTAL
 Job No : 00750AT\00751AT
 Mode : 5670 Band edge
 : 5G WIFI 11AX40 484 RU

	Cable	Ant	Preamp	Read	Limit	Over		
Freq	Loss	Factor	Factor	Level	Level	Line	Limit	Remark
MHz	dB	dB/m	dB	dBuV	dBuV/m	dBuV/m	dB	
1 q 5670.000	7.87	34.50	35.02	88.07	95.42	68.20	27.22	peak
2 5725.000	7.92	34.50	35.02	53.27	60.67	68.20	-7.53	peak
3 5741.439	7.93	34.50	35.03	53.80	61.20	68.20	-7.00	peak



Unless otherwise agreed in writing, this document is issued by the Company subject to its General Conditions of Service printed overleaf, available on request or accessible at <http://www.sgs.com/en/Terms-and-Conditions.aspx> and, for electronic format documents, subject to Terms and Conditions for Electronic Documents at <http://www.sgs.com/en/Terms-and-Conditions/Terms-e-Documents.aspx>. Attention is drawn to the limitation of liability, indemnification and jurisdiction issues defined therein. Any holder of this document is advised that information contained hereon reflects the Company's findings at the time of its intervention only and within the limits of Client's instructions, if any. The Company's sole responsibility is to its Client and this document does not exonerate parties to a transaction from exercising all their rights and obligations under the transaction documents. This document cannot be reproduced except in full, without prior written approval of the Company. Any unauthorized alteration, forgery or falsification of the content or appearance of this document is unlawful and offenders may be prosecuted to the fullest extent of the law. Unless otherwise stated the results shown in this test report refer only to the sample(s) tested and such sample(s) are retained for 30 days only.

Test Mode: 07; Polarity: Vertical; Modulation:802.11ax; Bandwidth:40MHz; Channel:High

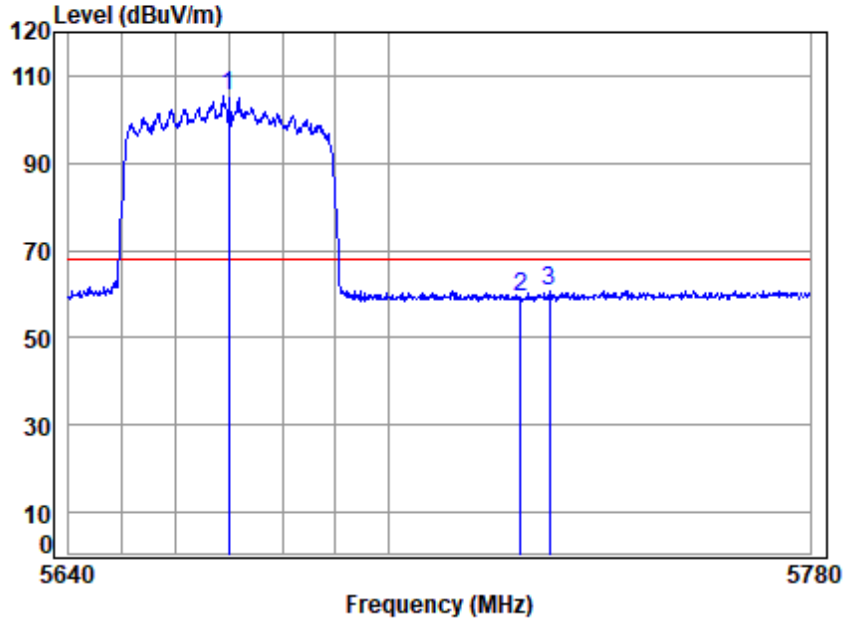

Site : chamber
 Condition: 3m VERTICAL
 Job No : 00750AT\00751AT
 Mode : 5670 Band edge
 : 5G WIFI 11AX40 484 RU

	Cable	Ant	Preamp	Read	Limit	Over		
Freq	Loss	Factor	Factor	Level	Level	Line	Limit	Remark
MHz	dB	dB/m	dB	dBuV	dBuV/m	dBuV/m	dB	
1 q 5670.000	7.87	34.50	35.02	97.88	105.23	68.20	37.03	Peak
2 5725.000	7.92	34.50	35.02	51.80	59.20	68.20	-9.00	Peak
3 5730.328	7.92	34.50	35.02	53.41	60.81	68.20	-7.39	Peak



Unless otherwise agreed in writing, this document is issued by the Company subject to its General Conditions of Service printed overleaf, available on request or accessible at <http://www.sgs.com/en/Terms-and-Conditions.aspx> and, for electronic format documents, subject to Terms and Conditions for Electronic Documents at <http://www.sgs.com/en/Terms-and-Conditions/Terms-e-Documents.aspx>. Attention is drawn to the limitation of liability, indemnification and jurisdiction issues defined therein. Any holder of this document is advised that information contained hereon reflects the Company's findings at the time of its intervention only and within the limits of Client's instructions, if any. The Company's sole responsibility is to its Client and this document does not exonerate parties to a transaction from exercising all their rights and obligations under the transaction documents. This document cannot be reproduced except in full, without prior written approval of the Company. Any unauthorized alteration, forgery or falsification of the content or appearance of this document is unlawful and offenders may be prosecuted to the fullest extent of the law. Unless otherwise stated the results shown in this test report refer only to the sample(s) tested and such sample(s) are retained for 30 days only.

Test Mode: 07; Polarity: Horizontal; Modulation:802.11ax; Bandwidth:80MHz; Channel:Low

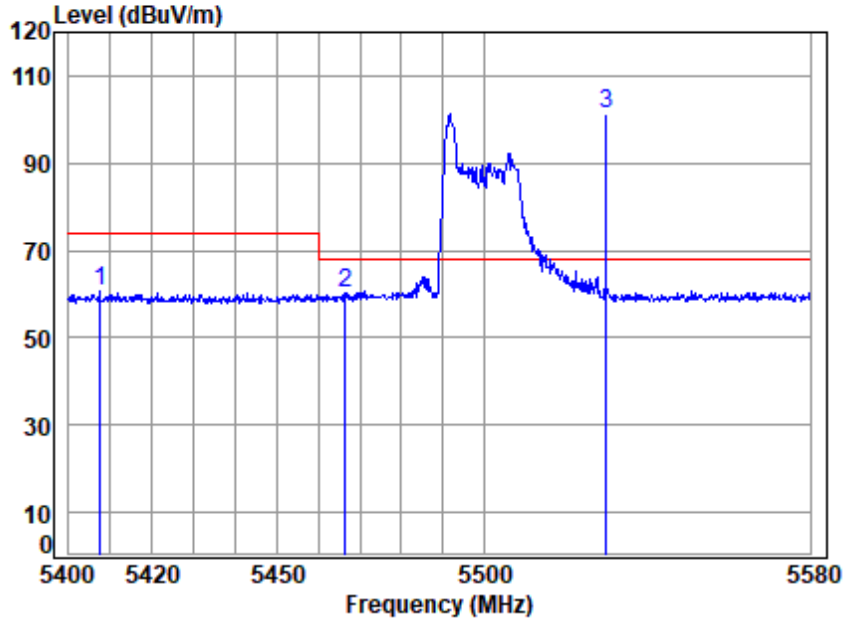

Site : chamber
 Condition: 3m HORIZONTAL
 Job No : 00750AT\00751AT
 Mode : 5530 Band edge
 : 5G WIFI 11AX80 26 RU

	Cable	Ant	Preamp	Read	Limit	Over		
Freq	Loss	Factor	Factor	Level	Level	Line	Limit	Remark
MHz	dB	dB/m	dB	dBuV	dBuV/m	dBuV/m	dB	
1	5407.442	7.62	34.51	35.01	53.38	60.50	74.00	-13.50 peak
2	5466.451	7.67	34.60	35.01	53.11	60.37	68.20	-7.83 peak
3 q	5530.000	7.73	34.60	35.01	93.75	101.07	68.20	32.87 peak



Unless otherwise agreed in writing, this document is issued by the Company subject to its General Conditions of Service printed overleaf, available on request or accessible at <http://www.sgs.com/en/Terms-and-Conditions.aspx> and, for electronic format documents, subject to Terms and Conditions for Electronic Documents at <http://www.sgs.com/en/Terms-and-Conditions/Terms-e-Documents.aspx>. Attention is drawn to the limitation of liability, indemnification and jurisdiction issues defined therein. Any holder of this document is advised that information contained hereon reflects the Company's findings at the time of its intervention only and within the limits of Client's instructions, if any. The Company's sole responsibility is to its Client and this document does not exonerate parties to a transaction from exercising all their rights and obligations under the transaction documents. This document cannot be reproduced except in full, without prior written approval of the Company. Any unauthorized alteration, forgery or falsification of the content or appearance of this document is unlawful and offenders may be prosecuted to the fullest extent of the law. Unless otherwise stated the results shown in this test report refer only to the sample(s) tested and such sample(s) are retained for 30 days only.

Test Mode: 07; Polarity: Horizontal; Modulation:802.11ax; Bandwidth:80MHz; Channel:Low

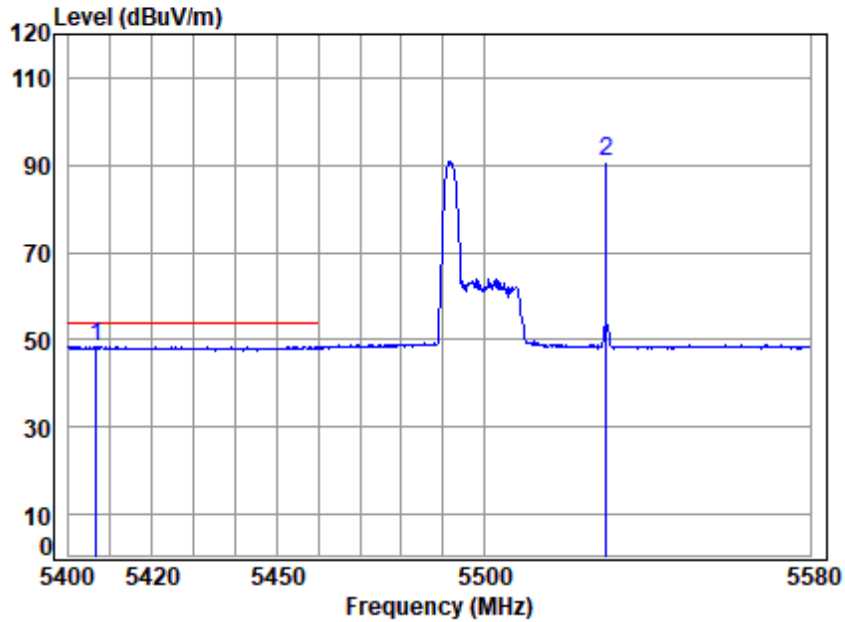

Site : chamber
 Condition: 3m HORIZONTAL
 Job No : 00750AT\00751AT
 Mode : 5530 Band edge
 : 5G WIFI 11AX80 26 RU

	Cable	Ant	Preamp	Read	Limit	Over		
Freq	Loss	Factor	Factor	Level	Level	Line	Limit	Remark
MHz	dB	dB/m	dB	dBuV	dBuV/m	dBuV/m	dB	
1 q 5406.555	7.62	34.51	35.01	41.44	48.56	54.00	-5.44	Average
2 5530.000	7.73	34.60	35.01	83.53	90.85	-----	-----	Average



Unless otherwise agreed in writing, this document is issued by the Company subject to its General Conditions of Service printed overleaf, available on request or accessible at <http://www.sgs.com/en/Terms-and-Conditions.aspx> and, for electronic format documents, subject to Terms and Conditions for Electronic Documents at <http://www.sgs.com/en/Terms-and-Conditions/Terms-e-Documents.aspx>. Attention is drawn to the limitation of liability, indemnification and jurisdiction issues defined therein. Any holder of this document is advised that information contained hereon reflects the Company's findings at the time of its intervention only and within the limits of Client's instructions, if any. The Company's sole responsibility is to its Client and this document does not exonerate parties to a transaction from exercising all their rights and obligations under the transaction documents. This document cannot be reproduced except in full, without prior written approval of the Company. Any unauthorized alteration, forgery or falsification of the content or appearance of this document is unlawful and offenders may be prosecuted to the fullest extent of the law. Unless otherwise stated the results shown in this test report refer only to the sample(s) tested and such sample(s) are retained for 30 days only.

Test Mode: 07; Polarity: Vertical; Modulation:802.11ax; Bandwidth:80MHz; Channel:Low

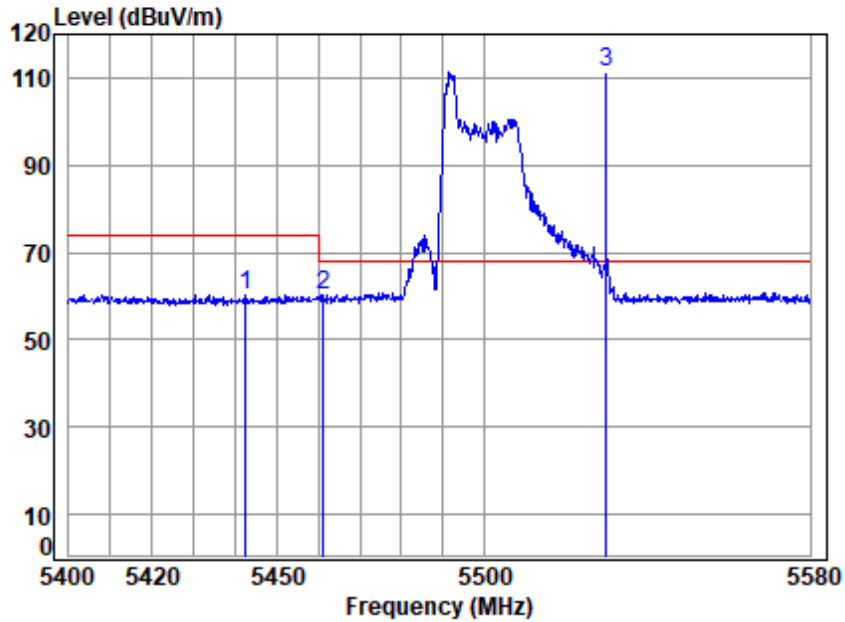

Site : chamber
 Condition: 3m VERTICAL
 Job No : 00750AT\00751AT
 Mode : 5530 Band edge
 : 5G WIFI 11AX80 26 RU

	Cable	Ant	Preamp	Read	Limit	Over		
Freq	Loss	Factor	Factor	Level	Level	Line	Limit	Remark
MHz	dB	dB/m	dB	dBuV	dBuV/m	dBuV/m	dB	
1	5442.306	7.65	34.58	35.01	53.17	60.39	74.00	-13.61 Peak
2	5461.076	7.67	34.60	35.01	53.10	60.36	68.20	-7.84 peak
3 q	5530.000	7.73	34.60	35.01	103.90	111.22	68.20	43.02 Peak



Unless otherwise agreed in writing, this document is issued by the Company subject to its General Conditions of Service printed overleaf, available on request or accessible at <http://www.sgs.com/en/Terms-and-Conditions.aspx> and, for electronic format documents, subject to Terms and Conditions for Electronic Documents at <http://www.sgs.com/en/Terms-and-Conditions/Terms-e-Documents.aspx>. Attention is drawn to the limitation of liability, indemnification and jurisdiction issues defined therein. Any holder of this document is advised that information contained hereon reflects the Company's findings at the time of its intervention only and within the limits of Client's instructions, if any. The Company's sole responsibility is to its Client and this document does not exonerate parties to a transaction from exercising all their rights and obligations under the transaction documents. This document cannot be reproduced except in full, without prior written approval of the Company. Any unauthorized alteration, forgery or falsification of the content or appearance of this document is unlawful and offenders may be prosecuted to the fullest extent of the law. Unless otherwise stated the results shown in this test report refer only to the sample(s) tested and such sample(s) are retained for 30 days only.

Test Mode: 07; Polarity: Vertical; Modulation:802.11ax; Bandwidth:80MHz; Channel:Low

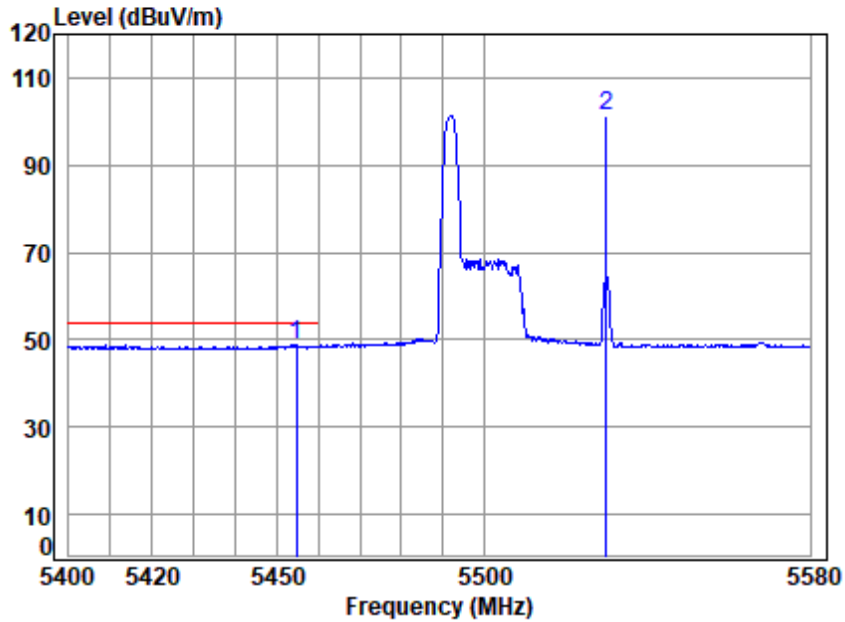

Site : chamber
 Condition: 3m VERTICAL
 Job No : 00750AT\00751AT
 Mode : 5530 Band edge
 : 5G WIFI 11AX80 26 RU

	Cable	Ant	Preamp	Read	Limit	Over		
Freq	Loss	Factor	Factor	Level	Level	Line	Limit	Remark
MHz	dB	dB/m	dB	dBuV	dBuV/m	dBuV/m	dB	
1 q 5454.633	7.66	34.60	35.01	41.53	48.78	54.00	-5.22	Average
2 5530.000	7.73	34.60	35.01	94.00	101.32	-----	-----	Average



Unless otherwise agreed in writing, this document is issued by the Company subject to its General Conditions of Service printed overleaf, available on request or accessible at <http://www.sgs.com/en/Terms-and-Conditions.aspx> and, for electronic format documents, subject to Terms and Conditions for Electronic Documents at <http://www.sgs.com/en/Terms-and-Conditions/Terms-e-Documents.aspx>. Attention is drawn to the limitation of liability, indemnification and jurisdiction issues defined therein. Any holder of this document is advised that information contained hereon reflects the Company's findings at the time of its intervention only and within the limits of Client's instructions, if any. The Company's sole responsibility is to its Client and this document does not exonerate parties to a transaction from exercising all their rights and obligations under the transaction documents. This document cannot be reproduced except in full, without prior written approval of the Company. Any unauthorized alteration, forgery or falsification of the content or appearance of this document is unlawful and offenders may be prosecuted to the fullest extent of the law. Unless otherwise stated the results shown in this test report refer only to the sample(s) tested and such sample(s) are retained for 30 days only.
 Attention: To check the authenticity of testing / inspection report & certificate, please contact us at telephone: (86-755) 8307 1443, or email: CN.Doccheck@sgs.com

Test Mode: 07; Polarity: Horizontal; Modulation:802.11ax; Bandwidth:80MHz; Channel:Low

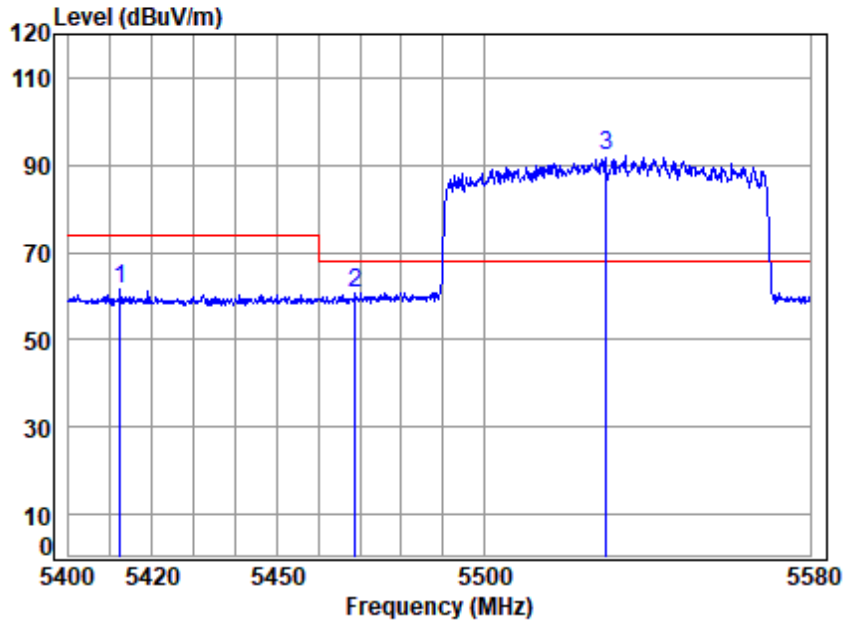

Site : chamber
 Condition: 3m HORIZONTAL
 Job No : 00750AT\00751AT
 Mode : 5530 Band edge
 : 5G WIFI 11AX80 996 RU

		Cable	Ant	Preamp	Read	Limit	Over	
	Freq	Loss	Factor	Factor	Level	Level	Line	Limit
	MHz	dB	dB/m	dB	dBuV	dBuV/m	dBuV/m	dB
1	5412.231	7.62	34.52	35.01	54.46	61.59	74.00	-12.41 peak
2	5468.961	7.68	34.60	35.01	53.27	60.54	68.20	-7.66 peak
3 q	5530.000	7.73	34.60	35.01	84.93	92.25	68.20	24.05 peak



Unless otherwise agreed in writing, this document is issued by the Company subject to its General Conditions of Service printed overleaf, available on request or accessible at <http://www.sgs.com/en/Terms-and-Conditions.aspx> and, for electronic format documents, subject to Terms and Conditions for Electronic Documents at <http://www.sgs.com/en/Terms-and-Conditions/Terms-e-Documents.aspx>. Attention is drawn to the limitation of liability, indemnification and jurisdiction issues defined therein. Any holder of this document is advised that information contained hereon reflects the Company's findings at the time of its intervention only and within the limits of Client's instructions, if any. The Company's sole responsibility is to its Client and this document does not exonerate parties to a transaction from exercising all their rights and obligations under the transaction documents. This document cannot be reproduced except in full, without prior written approval of the Company. Any unauthorized alteration, forgery or falsification of the content or appearance of this document is unlawful and offenders may be prosecuted to the fullest extent of the law. Unless otherwise stated the results shown in this test report refer only to the sample(s) tested and such sample(s) are retained for 30 days only.

Test Mode: 07; Polarity: Horizontal; Modulation:802.11ax; Bandwidth:80MHz; Channel:Low

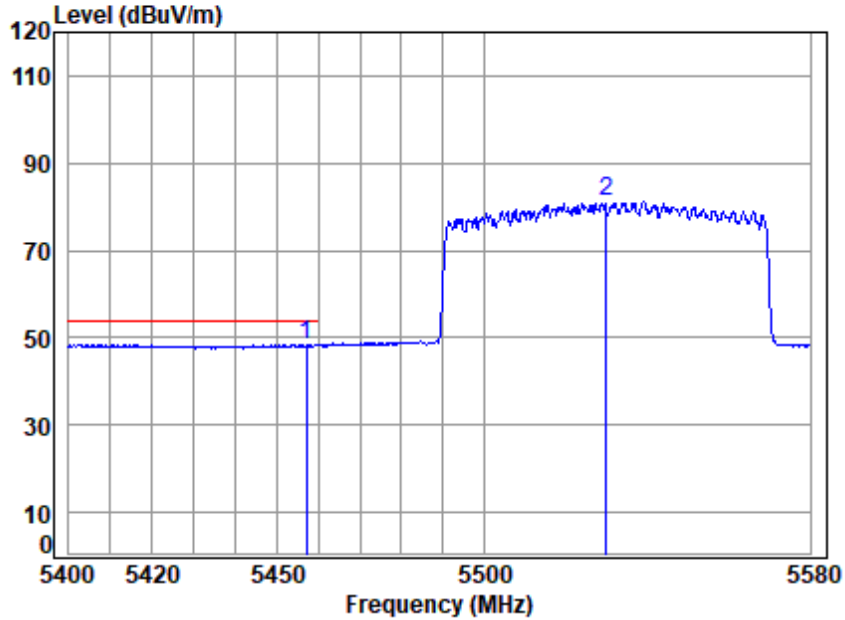

Site : chamber
 Condition: 3m HORIZONTAL
 Job No : 00750AT\00751AT
 Mode : 5530 Band edge
 : 5G WIFI 11AX80 996 RU

	Cable	Ant	Preamp	Read	Limit	Over		
Freq	Loss	Factor	Factor	Level	Level	Line	Limit	Remark
MHz	dB	dB/m	dB	dBuV	dBuV/m	dBuV/m	dB	
1 q 5457.138	7.67	34.60	35.01	41.18	48.44	54.00	-5.56	Average
2 5530.000	7.73	34.60	35.01	74.12	81.44	-----	-----	Average



Unless otherwise agreed in writing, this document is issued by the Company subject to its General Conditions of Service printed overleaf, available on request or accessible at <http://www.sgs.com/en/Terms-and-Conditions.aspx> and, for electronic format documents, subject to Terms and Conditions for Electronic Documents at <http://www.sgs.com/en/Terms-and-Conditions/Terms-e-Documents.aspx>. Attention is drawn to the limitation of liability, indemnification and jurisdiction issues defined therein. Any holder of this document is advised that information contained hereon reflects the Company's findings at the time of its intervention only and within the limits of Client's instructions, if any. The Company's sole responsibility is to its Client and this document does not exonerate parties to a transaction from exercising all their rights and obligations under the transaction documents. This document cannot be reproduced except in full, without prior written approval of the Company. Any unauthorized alteration, forgery or falsification of the content or appearance of this document is unlawful and offenders may be prosecuted to the fullest extent of the law. Unless otherwise stated the results shown in this test report refer only to the sample(s) tested and such sample(s) are retained for 30 days only.

Test Mode: 07; Polarity: Vertical; Modulation:802.11ax; Bandwidth:80MHz; Channel:Low

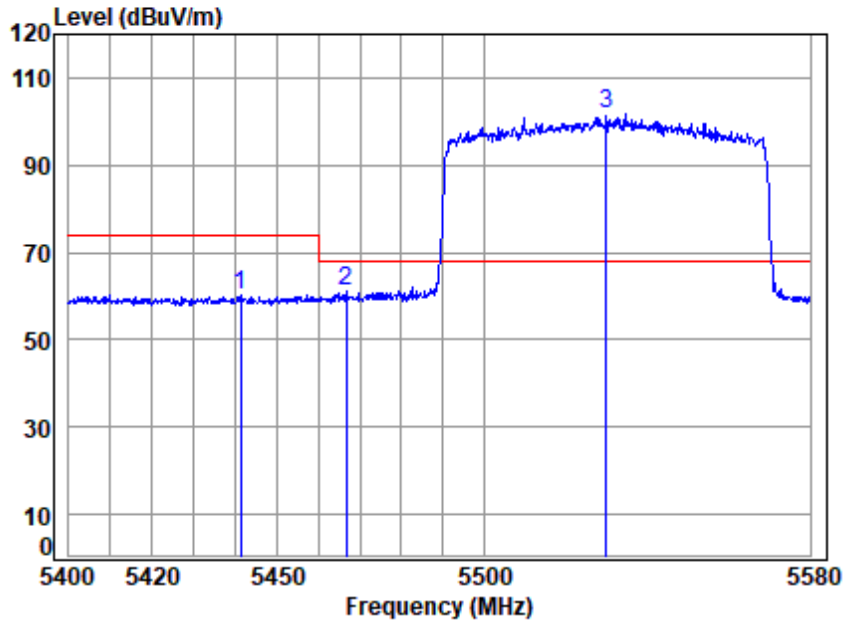

Site : chamber
 Condition: 3m VERTICAL
 Job No : 00750AT\00751AT
 Mode : 5530 Band edge
 : 5G WIFI 11AX80 996 RU

	Cable	Ant	Preamp	Read	Limit	Over	
Freq	Loss	Factor	Factor	Level	Level	Line	Limit
MHz	dB	dB/m	dB	dBuV	dBuV/m	dBuV/m	dB
1	7.65	34.58	35.01	52.94	60.16	74.00	-13.84
2	7.67	34.60	35.01	53.71	60.97	68.20	-7.23
3 q	7.73	34.60	35.01	94.20	101.52	68.20	33.32



Unless otherwise agreed in writing, this document is issued by the Company subject to its General Conditions of Service printed overleaf, available on request or accessible at <http://www.sgs.com/en/Terms-and-Conditions.aspx> and, for electronic format documents, subject to Terms and Conditions for Electronic Documents at <http://www.sgs.com/en/Terms-and-Conditions/Terms-e-Documents.aspx>. Attention is drawn to the limitation of liability, indemnification and jurisdiction issues defined therein. Any holder of this document is advised that information contained hereon reflects the Company's findings at the time of its intervention only and within the limits of Client's instructions, if any. The Company's sole responsibility is to its Client and this document does not exonerate parties to a transaction from exercising all their rights and obligations under the transaction documents. This document cannot be reproduced except in full, without prior written approval of the Company. Any unauthorized alteration, forgery or falsification of the content or appearance of this document is unlawful and offenders may be prosecuted to the fullest extent of the law. Unless otherwise stated the results shown in this test report refer only to the sample(s) tested and such sample(s) are retained for 30 days only.

Test Mode: 07; Polarity: Vertical; Modulation:802.11ax; Bandwidth:80MHz; Channel:Low

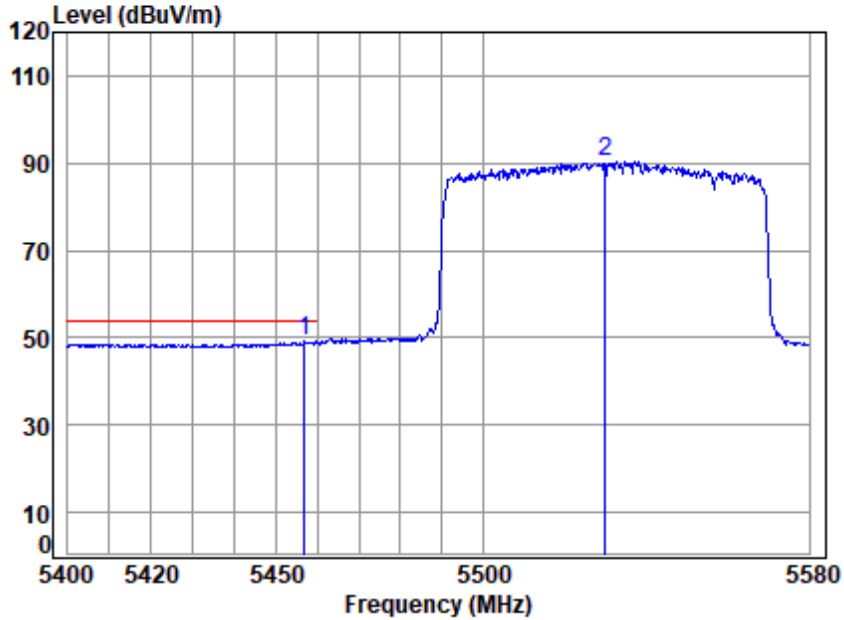

Site : chamber
 Condition: 3m VERTICAL
 Job No : 00750AT\00751AT
 Mode : 5530 Band edge
 : 5G WIFI 11AX80 996 RU

	Cable	Ant	Preamp	Read	Limit	Over		
Freq	Loss	Factor	Factor	Level	Level	Line	Limit	Remark
MHz	dB	dB/m	dB	dBuV	dBuV/m	dBuV/m	dB	
1 q 5456.780	7.67	34.60	35.01	41.85	49.11	54.00	-4.89	Average
2 5530.000	7.73	34.60	35.01	83.16	90.48	-----	-----	Average



Unless otherwise agreed in writing, this document is issued by the Company subject to its General Conditions of Service printed overleaf, available on request or accessible at <http://www.sgs.com/en/Terms-and-Conditions.aspx> and, for electronic format documents, subject to Terms and Conditions for Electronic Documents at <http://www.sgs.com/en/Terms-and-Conditions/Terms-e-Documents.aspx>. Attention is drawn to the limitation of liability, indemnification and jurisdiction issues defined therein. Any holder of this document is advised that information contained hereon reflects the Company's findings at the time of its intervention only and within the limits of Client's instructions, if any. The Company's sole responsibility is to its Client and this document does not exonerate parties to a transaction from exercising all their rights and obligations under the transaction documents. This document cannot be reproduced except in full, without prior written approval of the Company. Any unauthorized alteration, forgery or falsification of the content or appearance of this document is unlawful and offenders may be prosecuted to the fullest extent of the law. Unless otherwise stated the results shown in this test report refer only to the sample(s) tested and such sample(s) are retained for 30 days only.

Test Mode: 07; Polarity: Horizontal; Modulation:802.11ax; Bandwidth:80MHz; Channel:High

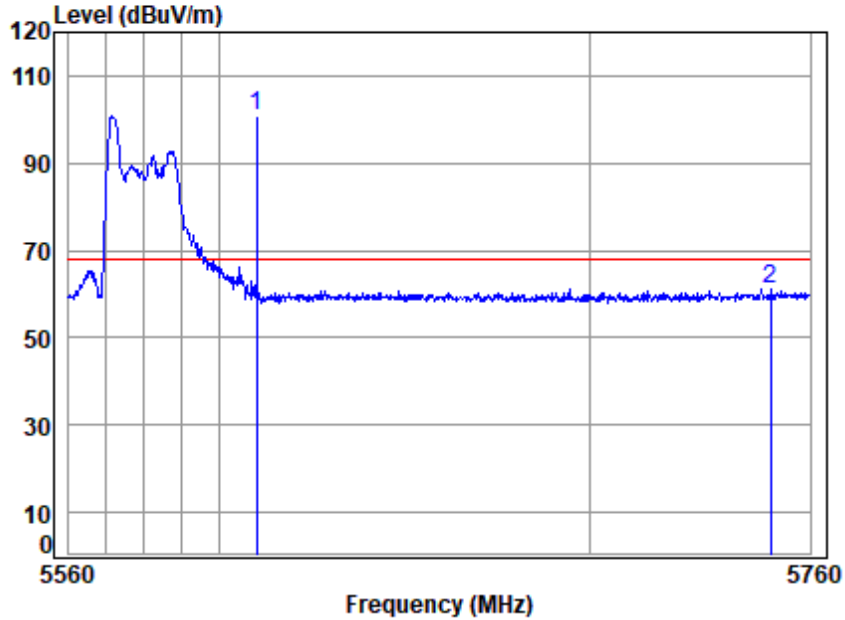

Site : chamber
 Condition: 3m HORIZONTAL
 Job No : 00750AT\00751AT
 Mode : 5610 Band edge
 : 5G WIFI 11AX80 26 RU

	Cable	Ant	Preamp	Read	Limit	Over	
Freq	Loss	Factor	Factor	Level	Level	Line	Limit
MHz	dB	dB/m	dB	dBuV	dBuV/m	dBuV/m	dB
1 q 5610.000	7.81	34.50	35.02	93.66	100.95	68.20	32.75 peak
2 5749.222	7.94	34.50	35.03	53.55	60.96	68.20	-7.24 peak



Unless otherwise agreed in writing, this document is issued by the Company subject to its General Conditions of Service printed overleaf, available on request or accessible at <http://www.sgs.com/en/Terms-and-Conditions.aspx> and, for electronic format documents, subject to Terms and Conditions for Electronic Documents at <http://www.sgs.com/en/Terms-and-Conditions/Terms-e-Documents.aspx>. Attention is drawn to the limitation of liability, indemnification and jurisdiction issues defined therein. Any holder of this document is advised that information contained hereon reflects the Company's findings at the time of its intervention only and within the limits of Client's instructions, if any. The Company's sole responsibility is to its Client and this document does not exonerate parties to a transaction from exercising all their rights and obligations under the transaction documents. This document cannot be reproduced except in full, without prior written approval of the Company. Any unauthorized alteration, forgery or falsification of the content or appearance of this document is unlawful and offenders may be prosecuted to the fullest extent of the law. Unless otherwise stated the results shown in this test report refer only to the sample(s) tested and such sample(s) are retained for 30 days only.

Test Mode: 07; Polarity: Vertical; Modulation:802.11ax; Bandwidth:80MHz; Channel:High

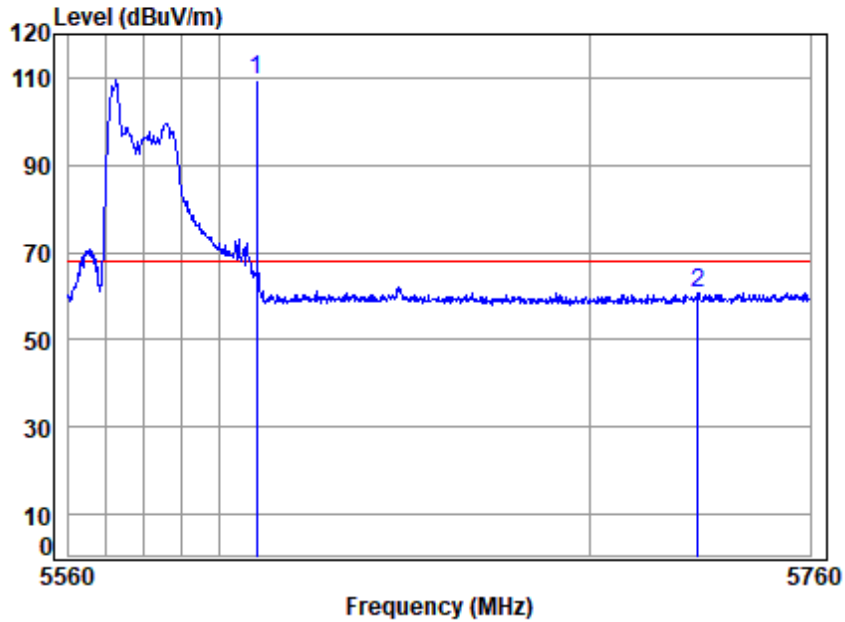

Site : chamber
 Condition: 3m VERTICAL
 Job No : 00750AT\00751AT
 Mode : 5610 Band edge
 : 5G WIFI 11AX80 26 RU

	Cable	Ant	Preamp	Read	Limit	Over	
Freq	Loss	Factor	Factor	Level	Level	Line	Limit
MHz	dB	dB/m	dB	dBuV	dBuV/m	dBuV/m	dB
1 q 5610.000	7.81	34.50	35.02	102.15	109.44	68.20	41.24 Peak
2 5729.345	7.92	34.50	35.02	53.37	60.77	68.20	-7.43 Peak



Unless otherwise agreed in writing, this document is issued by the Company subject to its General Conditions of Service printed overleaf, available on request or accessible at <http://www.sgs.com/en/Terms-and-Conditions.aspx> and, for electronic format documents, subject to Terms and Conditions for Electronic Documents at <http://www.sgs.com/en/Terms-and-Conditions/Terms-e-Documents.aspx>. Attention is drawn to the limitation of liability, indemnification and jurisdiction issues defined therein. Any holder of this document is advised that information contained hereon reflects the Company's findings at the time of its intervention only and within the limits of Client's instructions, if any. The Company's sole responsibility is to its Client and this document does not exonerate parties to a transaction from exercising all their rights and obligations under the transaction documents. This document cannot be reproduced except in full, without prior written approval of the Company. Any unauthorized alteration, forgery or falsification of the content or appearance of this document is unlawful and offenders may be prosecuted to the fullest extent of the law. Unless otherwise stated the results shown in this test report refer only to the sample(s) tested and such sample(s) are retained for 30 days only.

Test Mode: 07; Polarity: Horizontal; Modulation:802.11ax; Bandwidth:80MHz; Channel:High

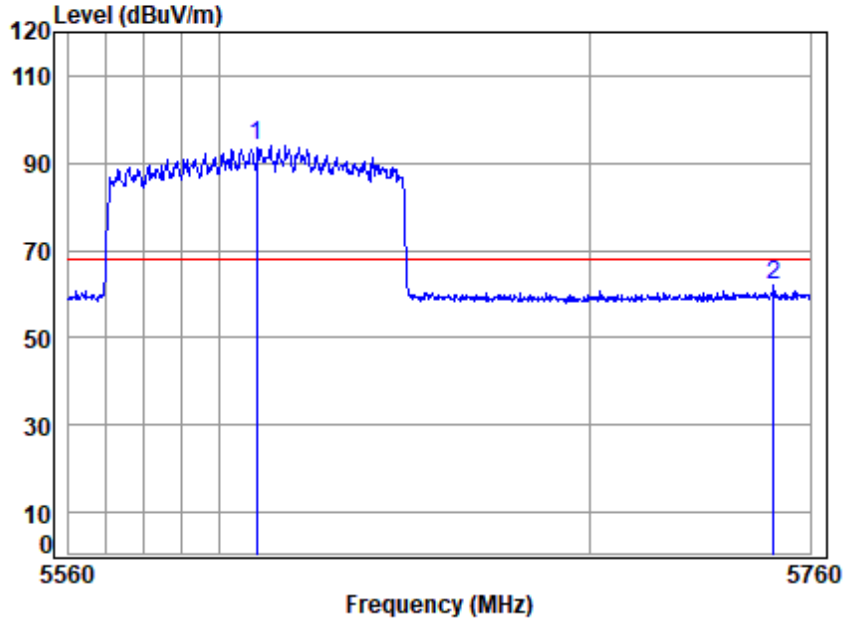

Site : chamber
 Condition: 3m HORIZONTAL
 Job No : 00750AT\00751AT
 Mode : 5610 Band edge
 : 5G WIFI 11AX80 996 RU

	Cable	Ant	Preamp	Read	Limit	Over		
Freq	Loss	Factor	Factor	Level	Level	Line	Limit	Remark
MHz	dB	dB/m	dB	dBuV	dBuV/m	dBuV/m	dB	
1 q 5610.000	7.81	34.50	35.02	86.53	93.82	68.20	25.62	peak
2 5750.035	7.94	34.50	35.03	54.68	62.09	68.20	-6.11	peak



Unless otherwise agreed in writing, this document is issued by the Company subject to its General Conditions of Service printed overleaf, available on request or accessible at <http://www.sgs.com/en/Terms-and-Conditions.aspx> and, for electronic format documents, subject to Terms and Conditions for Electronic Documents at <http://www.sgs.com/en/Terms-and-Conditions/Terms-e-Documents.aspx>. Attention is drawn to the limitation of liability, indemnification and jurisdiction issues defined therein. Any holder of this document is advised that information contained hereon reflects the Company's findings at the time of its intervention only and within the limits of Client's instructions, if any. The Company's sole responsibility is to its Client and this document does not exonerate parties to a transaction from exercising all their rights and obligations under the transaction documents. This document cannot be reproduced except in full, without prior written approval of the Company. Any unauthorized alteration, forgery or falsification of the content or appearance of this document is unlawful and offenders may be prosecuted to the fullest extent of the law. Unless otherwise stated the results shown in this test report refer only to the sample(s) tested and such sample(s) are retained for 30 days only.

Test Mode: 07; Polarity: Vertical; Modulation:802.11ax; Bandwidth:80MHz; Channel:High

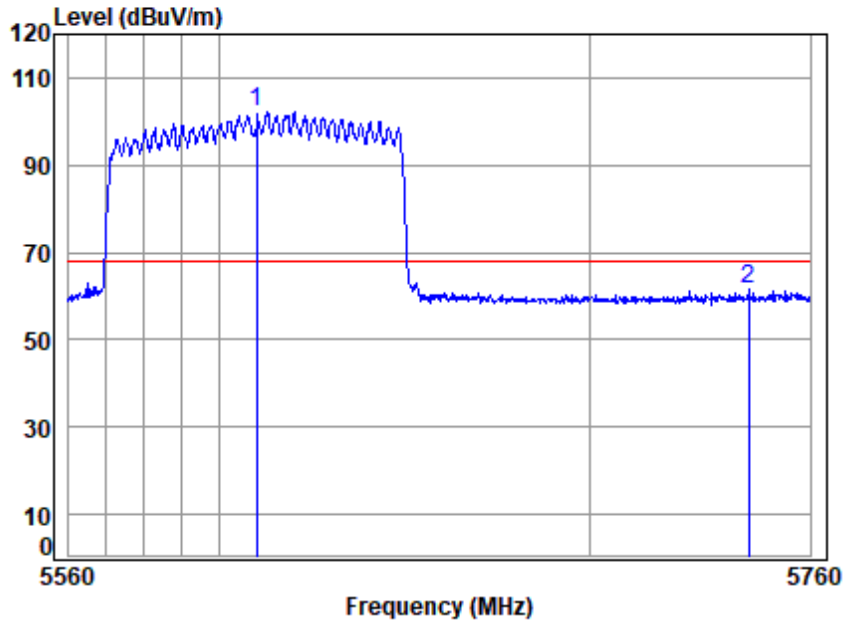

Site : chamber
 Condition: 3m VERTICAL
 Job No : 00750AT\00751AT
 Mode : 5610 Band edge
 : 5G WIFI 11AX80 996 RU

	Cable	Ant	Preamp	Read	Limit	Over		
Freq	Loss	Factor	Factor	Level	Level	Line	Limit	Remark
MHz	dB	dB/m	dB	dBuV	dBuV/m	dBuV/m	dB	
1 q 5610.000	7.81	34.50	35.02	95.13	102.42	68.20	34.22	Peak
2 5743.130	7.93	34.50	35.03	54.13	61.53	68.20	-6.67	Peak



Unless otherwise agreed in writing, this document is issued by the Company subject to its General Conditions of Service printed overleaf, available on request or accessible at <http://www.sgs.com/en/Terms-and-Conditions.aspx> and, for electronic format documents, subject to Terms and Conditions for Electronic Documents at <http://www.sgs.com/en/Terms-and-Conditions/Terms-e-Documents.aspx>. Attention is drawn to the limitation of liability, indemnification and jurisdiction issues defined therein. Any holder of this document is advised that information contained hereon reflects the Company's findings at the time of its intervention only and within the limits of Client's instructions, if any. The Company's sole responsibility is to its Client and this document does not exonerate parties to a transaction from exercising all their rights and obligations under the transaction documents. This document cannot be reproduced except in full, without prior written approval of the Company. Any unauthorized alteration, forgery or falsification of the content or appearance of this document is unlawful and offenders may be prosecuted to the fullest extent of the law. Unless otherwise stated the results shown in this test report refer only to the sample(s) tested and such sample(s) are retained for 30 days only.

Test Mode: 08; Polarity: Horizontal; Modulation:802.11a; Bandwidth:20MHz; Channel:Low

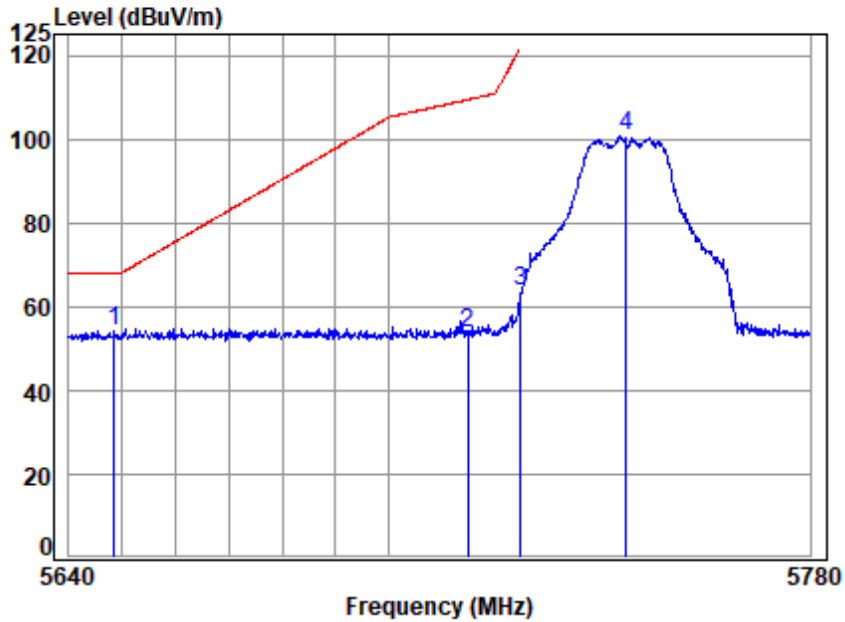

Site : chamber
 Condition: 3m HORIZONTAL
 Job No : 00750AT\00751AT
 Mode : 5745 Band edge
 : 5G WIFI 11A

		Cable	Ant	Preamp	Read	Limit	Over	
Freq		Loss	Factor	Factor	Level	Level	Line	Limit
	MHz	dB	dB/m	dB	dBuV	dBuV/m	dBuV/m	dB
1	5648.442	7.85	34.50	35.02	46.82	54.15	68.20	-14.05 peak
2	5715.000	7.91	34.50	35.02	46.28	53.67	109.40	-55.73 peak
3	5725.000	7.92	34.50	35.02	56.52	63.92	122.20	-58.28 peak
4	5745.000	7.93	34.50	35.03	93.20	100.60	-----	----- peak



Unless otherwise agreed in writing, this document is issued by the Company subject to its General Conditions of Service printed overleaf, available on request or accessible at <http://www.sgs.com/en/Terms-and-Conditions.aspx> and, for electronic format documents, subject to Terms and Conditions for Electronic Documents at <http://www.sgs.com/en/Terms-and-Conditions/Terms-e-Documents.aspx>. Attention is drawn to the limitation of liability, indemnification and jurisdiction issues defined therein. Any holder of this document is advised that information contained hereon reflects the Company's findings at the time of its intervention only and within the limits of Client's instructions, if any. The Company's sole responsibility is to its Client and this document does not exonerate parties to a transaction from exercising all their rights and obligations under the transaction documents. This document cannot be reproduced except in full, without prior written approval of the Company. Any unauthorized alteration, forgery or falsification of the content or appearance of this document is unlawful and offenders may be prosecuted to the fullest extent of the law. Unless otherwise stated the results shown in this test report refer only to the sample(s) tested and such sample(s) are retained for 30 days only.

Test Mode: 08; Polarity: Vertical; Modulation:802.11a; Bandwidth:20MHz; Channel:Low

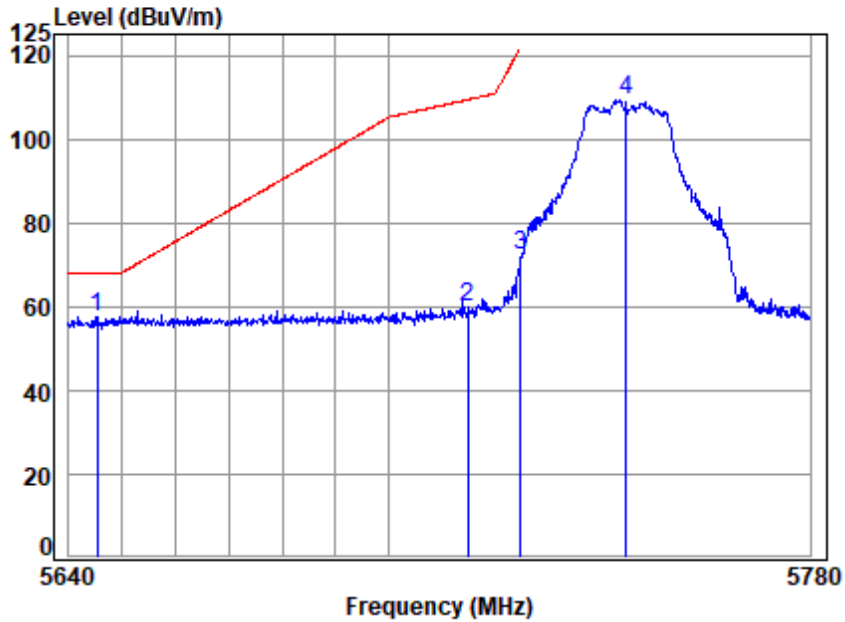

Site : chamber
 Condition: 3m VERTICAL
 Job No : 00750AT\00751AT
 Mode : 5745 Band edge
 : 5G WIFI 11A

		Cable	Ant	Preamp	Read	Limit	Over	
	Freq	Loss	Factor	Factor	Level	Level	Line	Limit
	MHz	dB	dB/m	dB	dBuV	dBuV/m	dBuV/m	dB
1	q 5645.257	7.84	34.50	35.02	50.12	57.44	68.20	-10.76 peak
2	5715.000	7.91	34.50	35.02	52.32	59.71	109.40	-49.69 peak
3	5725.000	7.92	34.50	35.02	64.98	72.38	122.20	-49.82 peak
4	5745.000	7.93	34.50	35.03	101.97	109.37	-----	----- peak



Unless otherwise agreed in writing, this document is issued by the Company subject to its General Conditions of Service printed overleaf, available on request or accessible at <http://www.sgs.com/en/Terms-and-Conditions.aspx> and, for electronic format documents, subject to Terms and Conditions for Electronic Documents at <http://www.sgs.com/en/Terms-and-Conditions/Terms-e-Documents.aspx>. Attention is drawn to the limitation of liability, indemnification and jurisdiction issues defined therein. Any holder of this document is advised that information contained hereon reflects the Company's findings at the time of its intervention only and within the limits of Client's instructions, if any. The Company's sole responsibility is to its Client and this document does not exonerate parties to a transaction from exercising all their rights and obligations under the transaction documents. This document cannot be reproduced except in full, without prior written approval of the Company. Any unauthorized alteration, forgery or falsification of the content or appearance of this document is unlawful and offenders may be prosecuted to the fullest extent of the law. Unless otherwise stated the results shown in this test report refer only to the sample(s) tested and such sample(s) are retained for 30 days only.

Test Mode: 08; Polarity: Horizontal; Modulation:802.11a; Bandwidth:20MHz; Channel:High

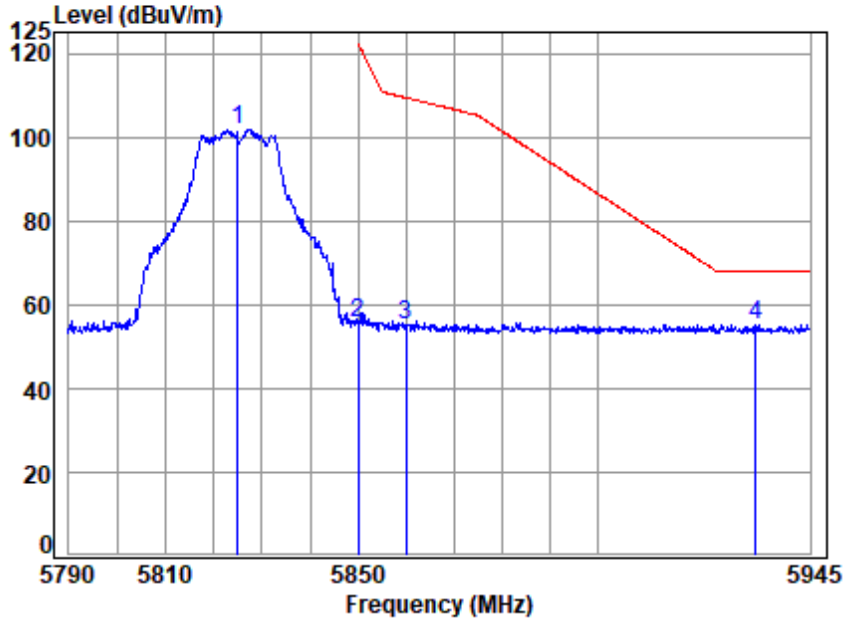

Site : chamber
 Condition: 3m HORIZONTAL
 Job No : 00750AT\00751AT
 Mode : 5825 Band edge
 : 5G WIFI 11A

	Freq	Cable Loss	Ant Factor	Preamp Factor	Read Level	Limit Level	Over Limit	Remark
	MHz	dB	dB/m	dB	dBuV	dBuV/m	dBuV/m	dB
1	5825.000	8.01	34.65	35.03	94.27	101.90	-----	peak
2	5850.000	8.03	34.70	35.03	47.76	55.46	122.20	-66.74 peak
3	5860.000	8.04	34.72	35.03	47.41	55.14	109.40	-54.26 peak
4 q	5933.389	8.10	34.87	35.04	47.23	55.16	68.20	-13.04 peak



Unless otherwise agreed in writing, this document is issued by the Company subject to its General Conditions of Service printed overleaf, available on request or accessible at <http://www.sgs.com/en/Terms-and-Conditions.aspx> and, for electronic format documents, subject to Terms and Conditions for Electronic Documents at <http://www.sgs.com/en/Terms-and-Conditions/Terms-e-Documents.aspx>. Attention is drawn to the limitation of liability, indemnification and jurisdiction issues defined therein. Any holder of this document is advised that information contained hereon reflects the Company's findings at the time of its intervention only and within the limits of Client's instructions, if any. The Company's sole responsibility is to its Client and this document does not exonerate parties to a transaction from exercising all their rights and obligations under the transaction documents. This document cannot be reproduced except in full, without prior written approval of the Company. Any unauthorized alteration, forgery or falsification of the content or appearance of this document is unlawful and offenders may be prosecuted to the fullest extent of the law. Unless otherwise stated the results shown in this test report refer only to the sample(s) tested and such sample(s) are retained for 30 days only.
 Attention: To check the authenticity of testing /inspection report & certificate, please contact us at telephone: (86-755) 8307 1443, or email: CN_Doccheck@sgs.com

Test Mode: 08; Polarity: Vertical; Modulation:802.11a; Bandwidth:20MHz; Channel:High

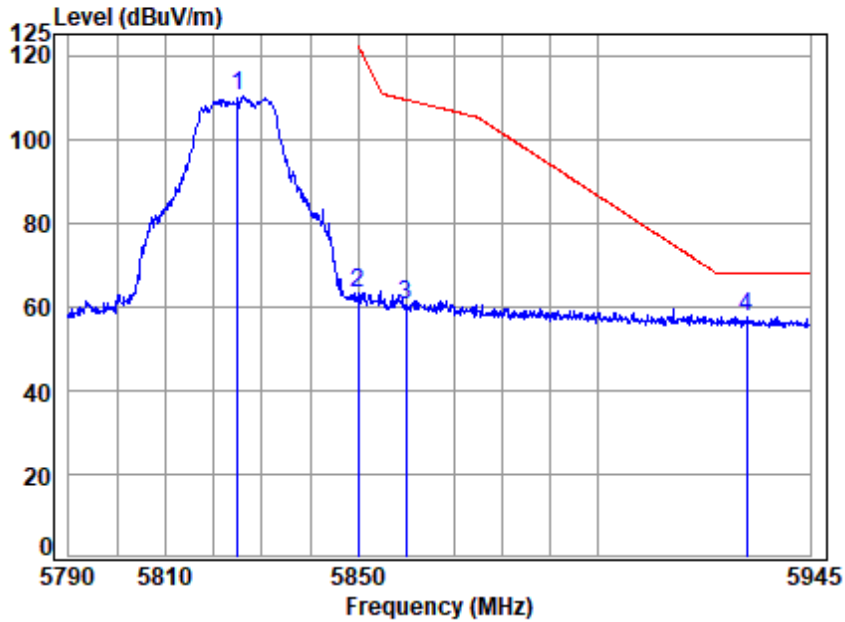

Site : chamber
 Condition: 3m VERTICAL
 Job No : 00750AT\00751AT
 Mode : 5825 Band edge
 : 5G WIFI 11A

		Cable	Ant	Preamp	Read	Limit	Over		
Freq		Loss	Factor	Factor	Level	Level	Line	Limit	Remark
	MHz	dB	dB/m	dB	dBuV	dBuV/m	dBuV/m	dB	
1	5825.000	8.01	34.65	35.03	102.65	110.28	-----	-----	peak
2	5850.000	8.03	34.70	35.03	55.31	63.01	122.20	-59.19	peak
3	5860.000	8.04	34.72	35.03	52.64	60.37	109.40	-49.03	peak
4 q	5931.508	8.10	34.86	35.04	49.68	57.60	68.20	-10.60	peak



Unless otherwise agreed in writing, this document is issued by the Company subject to its General Conditions of Service printed overleaf, available on request or accessible at <http://www.sgs.com/en/Terms-and-Conditions.aspx> and, for electronic format documents, subject to Terms and Conditions for Electronic Documents at <http://www.sgs.com/en/Terms-and-Conditions/Terms-e-Documents.aspx>. Attention is drawn to the limitation of liability, indemnification and jurisdiction issues defined therein. Any holder of this document is advised that information contained hereon reflects the Company's findings at the time of its intervention only and within the limits of Client's instructions, if any. The Company's sole responsibility is to its Client and this document does not exonerate parties to a transaction from exercising all their rights and obligations under the transaction documents. This document cannot be reproduced except in full, without prior written approval of the Company. Any unauthorized alteration, forgery or falsification of the content or appearance of this document is unlawful and offenders may be prosecuted to the fullest extent of the law. Unless otherwise stated the results shown in this test report refer only to the sample(s) tested and such sample(s) are retained for 30 days only.
 Attention: To check the authenticity of testing / inspection report & certificate, please contact us at telephone: (86-755) 8307 1443, or email: CN_Doccheck@sgs.com

Test Mode: 08; Polarity: Horizontal; Modulation:802.11n; Bandwidth:20MHz; Channel:Low

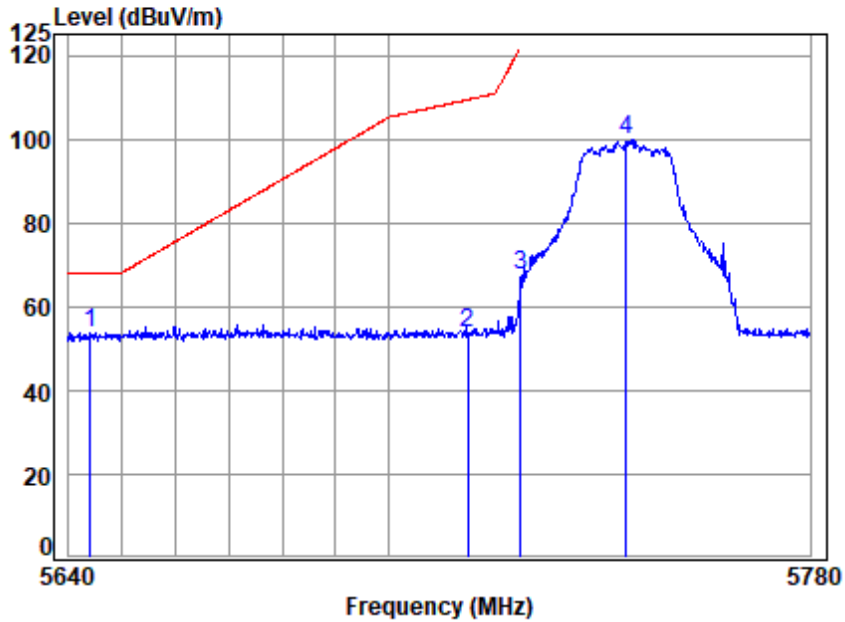

Site : chamber
 Condition: 3m HORIZONTAL
 Job No : 00750AT\00751AT
 Mode : 5745 Band edge
 : 5G WIFI 11N20

		Cable	Ant	Preamp	Read	Limit	Over	
	Freq	Loss	Factor	Factor	Level	Level	Line	Limit
	MHz	dB	dB/m	dB	dBuV	dBuV/m	dBuV/m	dB
1	q 5644.012	7.84	34.50	35.02	46.46	53.78	68.20	-14.42 peak
2	5715.000	7.91	34.50	35.02	46.10	53.49	109.40	-55.91 peak
3	5725.000	7.92	34.50	35.02	59.91	67.31	122.20	-54.89 peak
4	5745.000	7.93	34.50	35.03	92.30	99.70	-----	----- peak



Unless otherwise agreed in writing, this document is issued by the Company subject to its General Conditions of Service printed overleaf, available on request or accessible at <http://www.sgs.com/en/Terms-and-Conditions.aspx> and, for electronic format documents, subject to Terms and Conditions for Electronic Documents at <http://www.sgs.com/en/Terms-and-Conditions/Terms-e-Documents.aspx>. Attention is drawn to the limitation of liability, indemnification and jurisdiction issues defined therein. Any holder of this document is advised that information contained hereon reflects the Company's findings at the time of its intervention only and within the limits of Client's instructions, if any. The Company's sole responsibility is to its Client and this document does not exonerate parties to a transaction from exercising all their rights and obligations under the transaction documents. This document cannot be reproduced except in full, without prior written approval of the Company. Any unauthorized alteration, forgery or falsification of the content or appearance of this document is unlawful and offenders may be prosecuted to the fullest extent of the law. Unless otherwise stated the results shown in this test report refer only to the sample(s) tested and such sample(s) are retained for 30 days only.

Test Mode: 08; Polarity: Vertical; Modulation:802.11n; Bandwidth:20MHz; Channel:Low

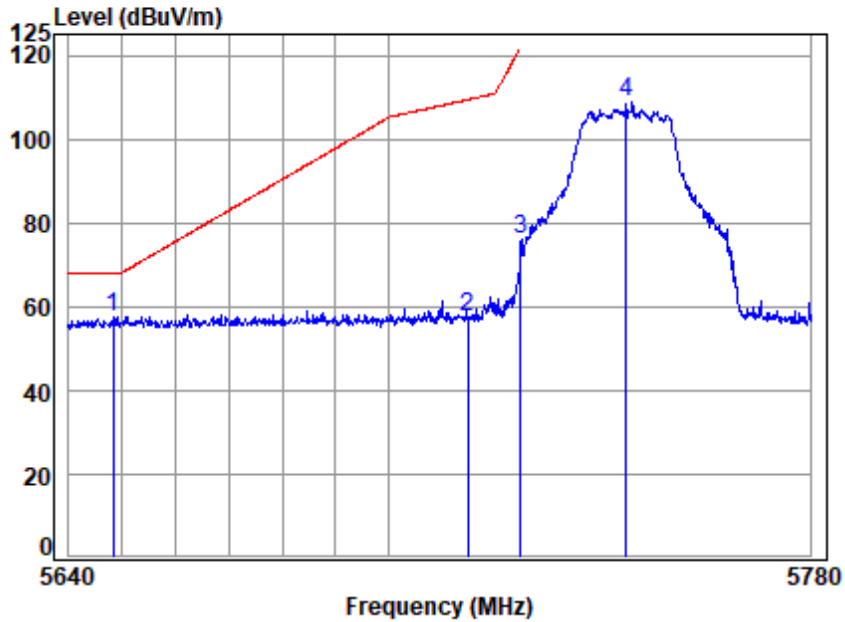

Site : chamber
 Condition: 3m VERTICAL
 Job No : 00750AT\00751AT
 Mode : 5745 Band edge
 : 5G WIFI 11N20

		Cable	Ant	Preamp	Read	Limit	Over		
Freq	Loss	Factor	Factor	Factor	Level	Level	Line	Limit	Remark
MHz	dB	dB/m	dB/m	dB	dBuV	dBuV/m	dBuV/m	dB	
1 q 5648.304	7.85	34.50	35.02	50.29	57.62	68.20	-10.58	peak	
2 5715.000	7.91	34.50	35.02	50.05	57.44	109.40	-51.96	peak	
3 5725.000	7.92	34.50	35.02	68.59	75.99	122.20	-46.21	peak	
4 5745.000	7.93	34.50	35.03	101.41	108.81	-----	-----	peak	



Unless otherwise agreed in writing, this document is issued by the Company subject to its General Conditions of Service printed overleaf, available on request or accessible at <http://www.sgs.com/en/Terms-and-Conditions.aspx> and, for electronic format documents, subject to Terms and Conditions for Electronic Documents at <http://www.sgs.com/en/Terms-and-Conditions/Terms-e-Documents.aspx>. Attention is drawn to the limitation of liability, indemnification and jurisdiction issues defined therein. Any holder of this document is advised that information contained hereon reflects the Company's findings at the time of its intervention only and within the limits of Client's instructions, if any. The Company's sole responsibility is to its Client and this document does not exonerate parties to a transaction from exercising all their rights and obligations under the transaction documents. This document cannot be reproduced except in full, without prior written approval of the Company. Any unauthorized alteration, forgery or falsification of the content or appearance of this document is unlawful and offenders may be prosecuted to the fullest extent of the law. Unless otherwise stated the results shown in this test report refer only to the sample(s) tested and such sample(s) are retained for 30 days only.

Test Mode: 08; Polarity: Horizontal; Modulation:802.11n; Bandwidth:20MHz; Channel:High

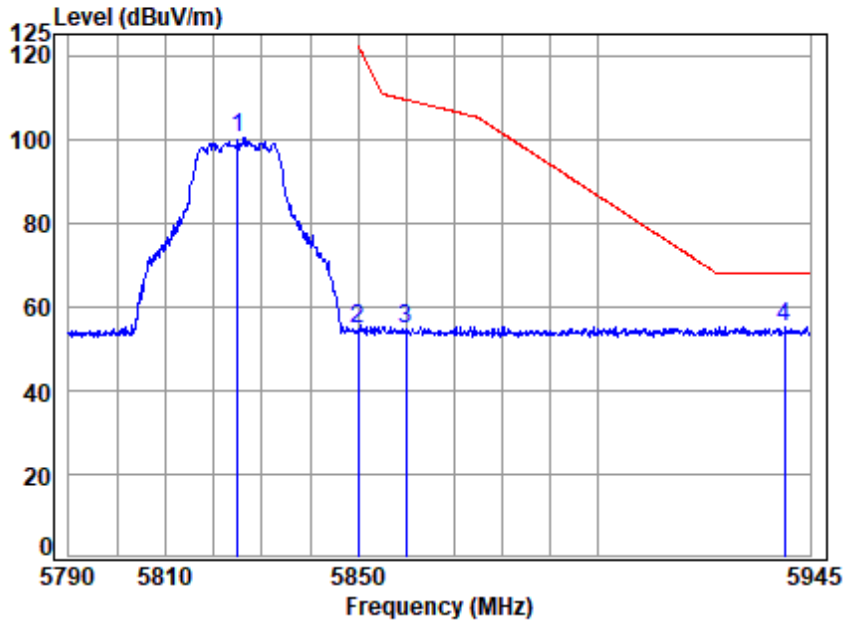

Site : chamber
 Condition: 3m HORIZONTAL
 Job No : 00750AT\00751AT
 Mode : 5825 Band edge
 : 5G WIFI 11N20

	Freq	Cable Loss	Ant Factor	Preamp Factor	Read Level	Limit Level	Over Line	Over Limit	Remark
	MHz	dB	dB/m	dB	dBuV	dBuV/m	dBuV/m	dB	
1	5825.000	8.01	34.65	35.03	92.80	100.43	-----	-----	peak
2	5850.000	8.03	34.70	35.03	46.75	54.45	122.20	-67.75	peak
3	5860.000	8.04	34.72	35.03	46.97	54.70	109.40	-54.70	peak
4 q	5939.663	8.11	34.88	35.04	47.21	55.16	68.20	-13.04	peak



Unless otherwise agreed in writing, this document is issued by the Company subject to its General Conditions of Service printed overleaf, available on request or accessible at <http://www.sgs.com/en/Terms-and-Conditions.aspx> and, for electronic format documents, subject to Terms and Conditions for Electronic Documents at <http://www.sgs.com/en/Terms-and-Conditions/Terms-e-Documents.aspx>. Attention is drawn to the limitation of liability, indemnification and jurisdiction issues defined therein. Any holder of this document is advised that information contained hereon reflects the Company's findings at the time of its intervention only and within the limits of Client's instructions, if any. The Company's sole responsibility is to its Client and this document does not exonerate parties to a transaction from exercising all their rights and obligations under the transaction documents. This document cannot be reproduced except in full, without prior written approval of the Company. Any unauthorized alteration, forgery or falsification of the content or appearance of this document is unlawful and offenders may be prosecuted to the fullest extent of the law. Unless otherwise stated the results shown in this test report refer only to the sample(s) tested and such sample(s) are retained for 30 days only.
 Attention: To check the authenticity of testing /inspection report & certificate, please contact us at telephone: (86-755) 8307 1443, or email: CN_Doccheck@sgs.com

Test Mode: 08; Polarity: Vertical; Modulation:802.11n; Bandwidth:20MHz; Channel:High

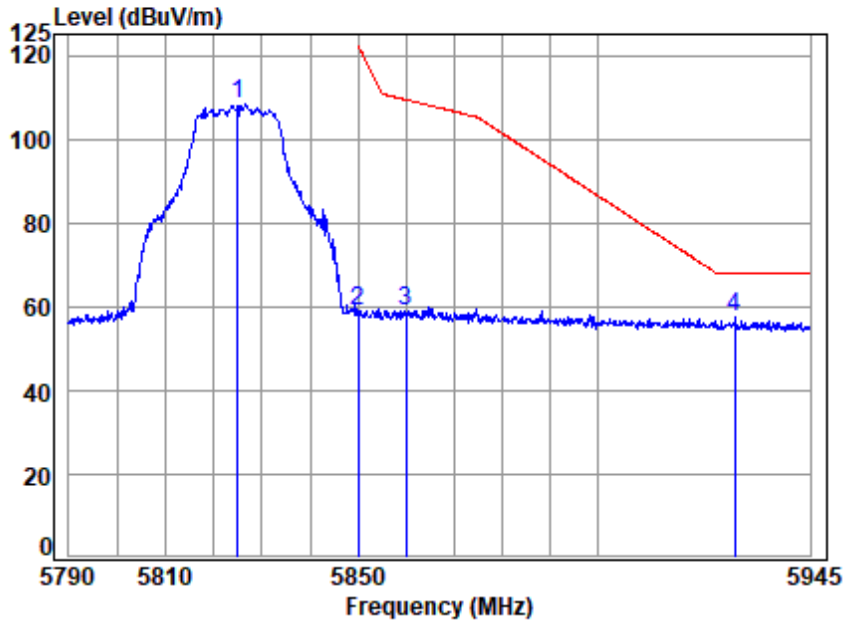

Site : chamber
 Condition: 3m VERTICAL
 Job No : 00750AT\00751AT
 Mode : 5825 Band edge
 : 5G WIFI 11N20

		Cable	Ant	Preamp	Read	Limit	Over		
Freq		Loss	Factor	Factor	Level	Level	Line	Limit	Remark
	MHz	dB	dB/m	dB	dBuV	dBuV/m	dBuV/m	dB	
1	5825.000	8.01	34.65	35.03	100.59	108.22	-----	-----	peak
2	5850.000	8.03	34.70	35.03	51.11	58.81	122.20	-63.39	peak
3	5860.000	8.04	34.72	35.03	51.14	58.87	109.40	-50.53	peak
4 q	5929.158	8.10	34.86	35.04	49.50	57.42	68.20	-10.78	peak



Unless otherwise agreed in writing, this document is issued by the Company subject to its General Conditions of Service printed overleaf, available on request or accessible at <http://www.sgs.com/en/Terms-and-Conditions.aspx> and, for electronic format documents, subject to Terms and Conditions for Electronic Documents at <http://www.sgs.com/en/Terms-and-Conditions/Terms-e-Documents.aspx>. Attention is drawn to the limitation of liability, indemnification and jurisdiction issues defined therein. Any holder of this document is advised that information contained hereon reflects the Company's findings at the time of its intervention only and within the limits of Client's instructions, if any. The Company's sole responsibility is to its Client and this document does not exonerate parties to a transaction from exercising all their rights and obligations under the transaction documents. This document cannot be reproduced except in full, without prior written approval of the Company. Any unauthorized alteration, forgery or falsification of the content or appearance of this document is unlawful and offenders may be prosecuted to the fullest extent of the law. Unless otherwise stated the results shown in this test report refer only to the sample(s) tested and such sample(s) are retained for 30 days only.
 Attention: To check the authenticity of testing / inspection report & certificate, please contact us at telephone: (86-755) 8307 1443, or email: CN.Doccheck@sgs.com

Test Mode: 08; Polarity: Horizontal; Modulation:802.11n; Bandwidth:40MHz; Channel:Low

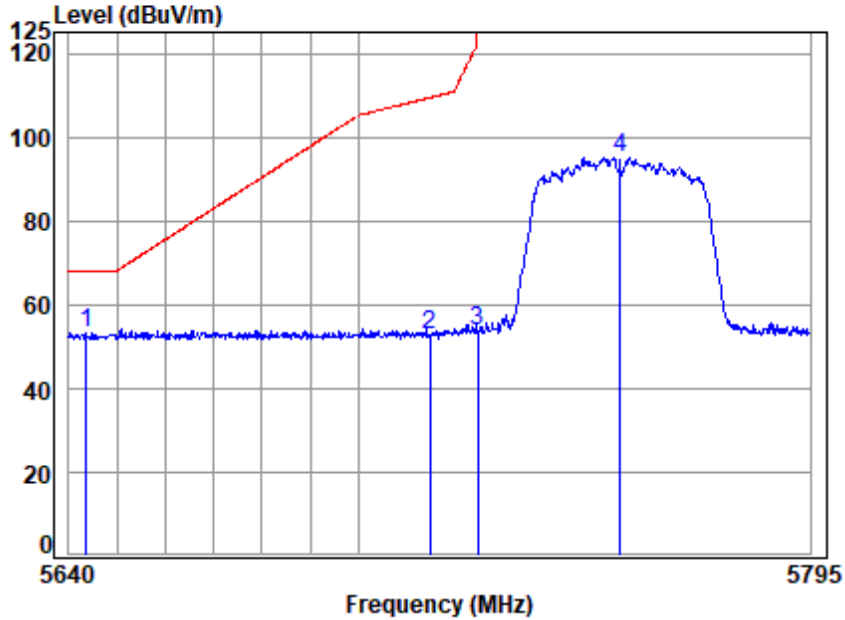

Site : chamber
 Condition: 3m HORIZONTAL
 Job No : 00750AT\00751AT
 Mode : 5755 Band edge
 : 5G WIFI 11N40

		Cable	Ant	Preamp	Read	Limit	Over	
Peak	Freq	Loss	Factor	Factor	Level	Level	Line	Limit
	MHz	dB	dB/m	dB	dBuV	dBuV/m	dBuV/m	dB
1	5643.671	7.84	34.50	35.02	46.09	53.41	68.20	-14.79 peak
2	5715.000	7.91	34.50	35.02	45.40	52.79	109.40	-56.61 peak
3	5725.000	7.92	34.50	35.02	46.41	53.81	122.20	-68.39 peak
4	5755.000	7.94	34.51	35.03	87.82	95.24	-----	----- peak



Unless otherwise agreed in writing, this document is issued by the Company subject to its General Conditions of Service printed overleaf, available on request or accessible at <http://www.sgs.com/en/Terms-and-Conditions.aspx> and, for electronic format documents, subject to Terms and Conditions for Electronic Documents at <http://www.sgs.com/en/Terms-and-Conditions/Terms-e-Documents.aspx>. Attention is drawn to the limitation of liability, indemnification and jurisdiction issues defined therein. Any holder of this document is advised that information contained hereon reflects the Company's findings at the time of its intervention only and within the limits of Client's instructions, if any. The Company's sole responsibility is to its Client and this document does not exonerate parties to a transaction from exercising all their rights and obligations under the transaction documents. This document cannot be reproduced except in full, without prior written approval of the Company. Any unauthorized alteration, forgery or falsification of the content or appearance of this document is unlawful and offenders may be prosecuted to the fullest extent of the law. Unless otherwise stated the results shown in this test report refer only to the sample(s) tested and such sample(s) are retained for 30 days only.
 Attention: To check the authenticity of testing /inspection report & certificate, please contact us at telephone: (86-755) 8307 1443, or email: CN.Doccheck@sgs.com

Test Mode: 08; Polarity: Vertical; Modulation:802.11n; Bandwidth:40MHz; Channel:Low

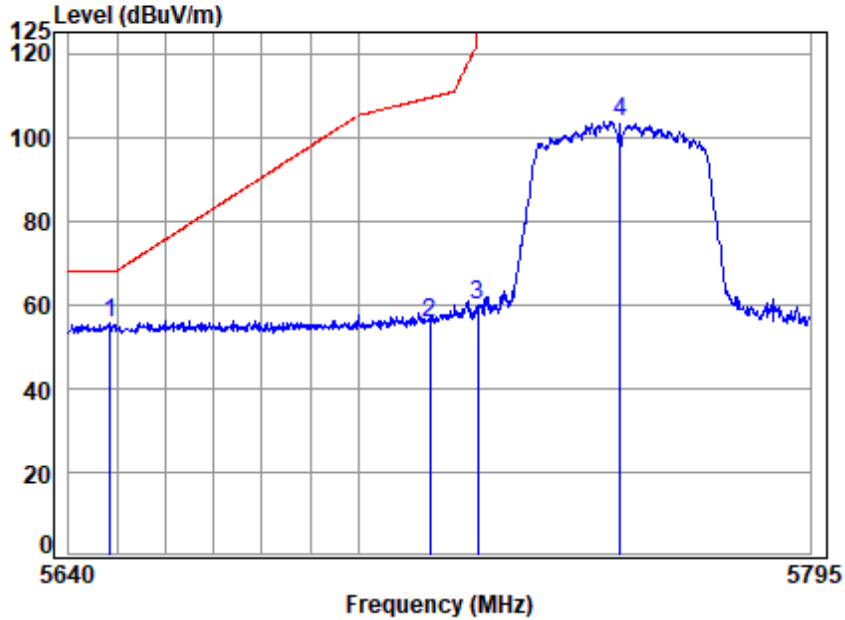

Site : chamber
 Condition: 3m VERTICAL
 Job No : 00750AT\00751AT
 Mode : 5755 Band edge
 : 5G WIFI 11N40

		Cable	Ant	Preamp	Read	Limit	Over	
	Freq	Loss	Factor	Factor	Level	Level	Line	Limit
	MHz	dB	dB/m	dB	dBuV	dBuV/m	dBuV/m	dB
1	q 5648.569	7.85	34.50	35.02	48.13	55.46	68.20	-12.74 peak
2	5715.000	7.91	34.50	35.02	48.11	55.50	109.40	-53.90 peak
3	5725.000	7.92	34.50	35.02	52.46	59.86	122.20	-62.34 peak
4	5755.000	7.94	34.51	35.03	96.14	103.56	-----	----- peak



Unless otherwise agreed in writing, this document is issued by the Company subject to its General Conditions of Service printed overleaf, available on request or accessible at <http://www.sgs.com/en/Terms-and-Conditions.aspx> and, for electronic format documents, subject to Terms and Conditions for Electronic Documents at <http://www.sgs.com/en/Terms-and-Conditions/Terms-e-Documents.aspx>. Attention is drawn to the limitation of liability, indemnification and jurisdiction issues defined therein. Any holder of this document is advised that information contained hereon reflects the Company's findings at the time of its intervention only and within the limits of Client's instructions, if any. The Company's sole responsibility is to its Client and this document does not exonerate parties to a transaction from exercising all their rights and obligations under the transaction documents. This document cannot be reproduced except in full, without prior written approval of the Company. Any unauthorized alteration, forgery or falsification of the content or appearance of this document is unlawful and offenders may be prosecuted to the fullest extent of the law. Unless otherwise stated the results shown in this test report refer only to the sample(s) tested and such sample(s) are retained for 30 days only.

Test Mode: 08; Polarity: Horizontal; Modulation:802.11n; Bandwidth:40MHz; Channel:High

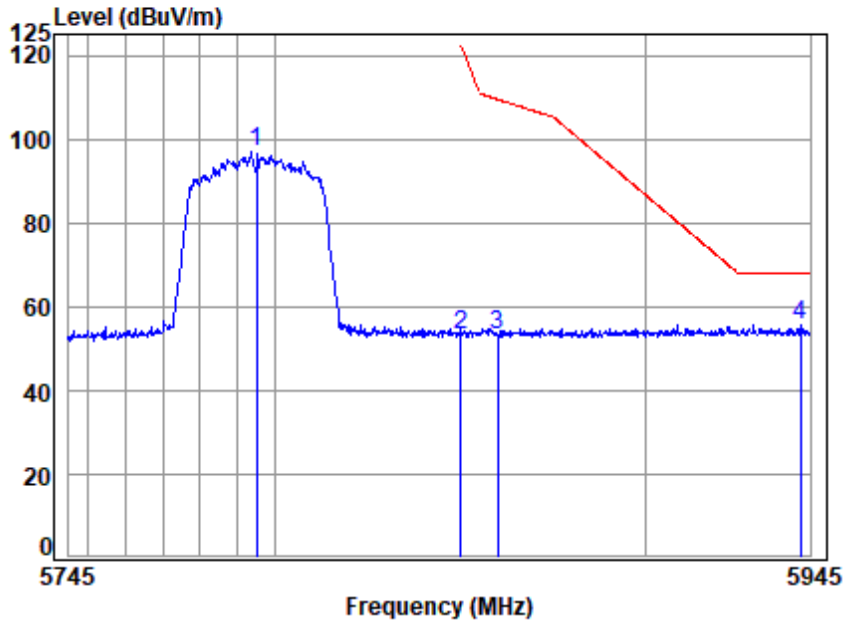

Site : chamber
 Condition: 3m HORIZONTAL
 Job No : 00750AT\00751AT
 Mode : 5795 Band edge
 : 5G WIFI 11N40

	Freq	Cable Loss	Ant Factor	Preamp Factor	Read Level	Limit Level	Limit Line	Over Limit	Remark
	MHz	dB	dB/m	dB	dBuV	dBuV/m	dBuV/m	dB	
1	5795.000	7.98	34.59	35.03	89.28	96.82	-----	-----	peak
2	5850.000	8.03	34.70	35.03	45.52	53.22	122.20	-68.98	peak
3	5860.000	8.04	34.72	35.03	45.73	53.46	109.40	-55.94	peak
4 q	5942.356	8.11	34.88	35.04	47.62	55.57	68.20	-12.63	peak



Unless otherwise agreed in writing, this document is issued by the Company subject to its General Conditions of Service printed overleaf, available on request or accessible at <http://www.sgs.com/en/Terms-and-Conditions.aspx> and, for electronic format documents, subject to Terms and Conditions for Electronic Documents at <http://www.sgs.com/en/Terms-and-Conditions/Terms-e-Documents.aspx>. Attention is drawn to the limitation of liability, indemnification and jurisdiction issues defined therein. Any holder of this document is advised that information contained hereon reflects the Company's findings at the time of its intervention only and within the limits of Client's instructions, if any. The Company's sole responsibility is to its Client and this document does not exonerate parties to a transaction from exercising all their rights and obligations under the transaction documents. This document cannot be reproduced except in full, without prior written approval of the Company. Any unauthorized alteration, forgery or falsification of the content or appearance of this document is unlawful and offenders may be prosecuted to the fullest extent of the law. Unless otherwise stated the results shown in this test report refer only to the sample(s) tested and such sample(s) are retained for 30 days only.

Test Mode: 08; Polarity: Vertical; Modulation:802.11n; Bandwidth:40MHz; Channel:High

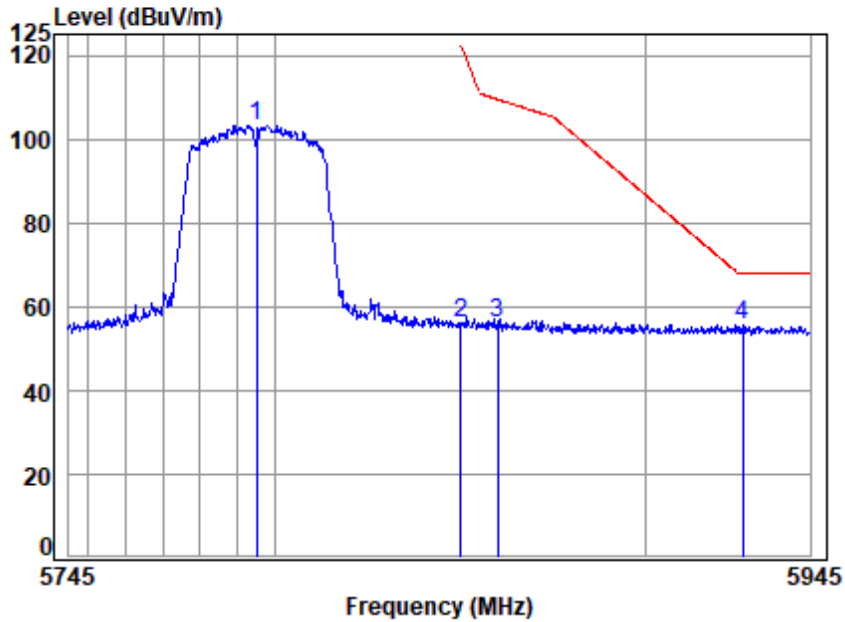

Site : chamber
 Condition: 3m VERTICAL
 Job No : 00750AT\00751AT
 Mode : 5795 Band edge
 : 5G WIFI 11N40

		Cable	Ant	Preamp	Read	Limit	Over	
	Freq	Loss	Factor	Factor	Level	Line	Limit	Remark
	MHz	dB	dB/m	dB	dBuV	dBuV/m	dBuV/m	dB
1	5795.000	7.98	34.59	35.03	95.81	103.35	-----	----- peak
2	5850.000	8.03	34.70	35.03	48.52	56.22	122.20	-65.98 peak
3	5860.000	8.04	34.72	35.03	48.36	56.09	109.40	-53.31 peak
4 q	5926.516	8.10	34.85	35.04	47.52	55.43	68.20	-12.77 peak



Unless otherwise agreed in writing, this document is issued by the Company subject to its General Conditions of Service printed overleaf, available on request or accessible at <http://www.sgs.com/en/Terms-and-Conditions.aspx> and, for electronic format documents, subject to Terms and Conditions for Electronic Documents at <http://www.sgs.com/en/Terms-and-Conditions/Terms-e-Documents.aspx>. Attention is drawn to the limitation of liability, indemnification and jurisdiction issues defined therein. Any holder of this document is advised that information contained hereon reflects the Company's findings at the time of its intervention only and within the limits of Client's instructions, if any. The Company's sole responsibility is to its Client and this document does not exonerate parties to a transaction from exercising all their rights and obligations under the transaction documents. This document cannot be reproduced except in full, without prior written approval of the Company. Any unauthorized alteration, forgery or falsification of the content or appearance of this document is unlawful and offenders may be prosecuted to the fullest extent of the law. Unless otherwise stated the results shown in this test report refer only to the sample(s) tested and such sample(s) are retained for 30 days only.

Test Mode: 08; Polarity: Horizontal; Modulation:802.11ac; Bandwidth:20MHz; Channel:Low

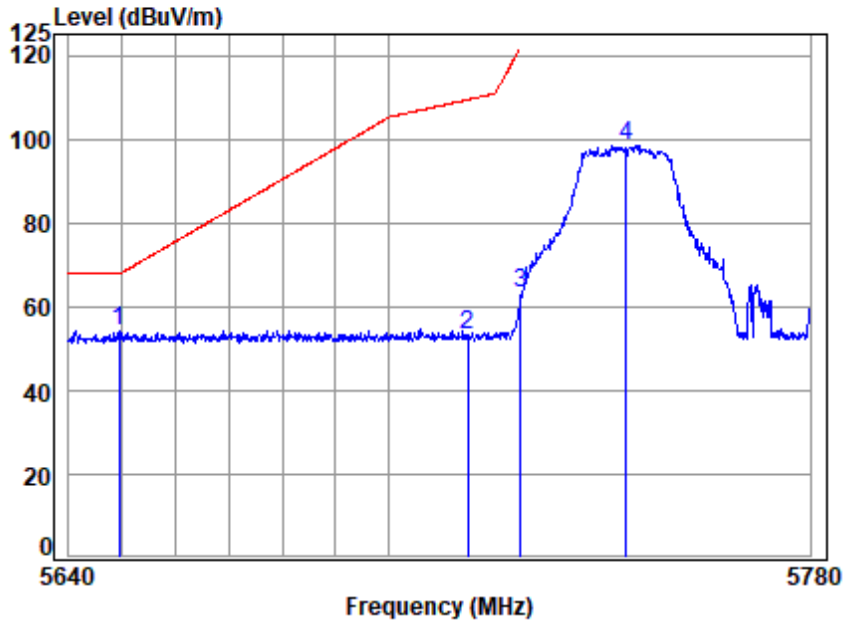

Site : chamber
 Condition: 3m HORIZONTAL
 Job No : 00750AT\00751AT
 Mode : 5745 Band edge
 : 5G WIFI 11AC20

		Cable	Ant	Preamp	Read	Limit	Over		
Freq	Loss	Factor	Factor	Factor	Level	Level	Line	Limit	Remark
MHz	dB	dB/m	dB/m	dB	dBuV	dBuV/m	dBuV/m	dB	
1 q 5649.412	7.85	34.50	35.02	46.82	54.15	68.20	-14.05	peak	
2 5715.000	7.91	34.50	35.02	45.78	53.17	109.40	-56.23	peak	
3 5725.000	7.92	34.50	35.02	55.73	63.13	122.20	-59.07	peak	
4 5745.000	7.93	34.50	35.03	91.04	98.44	-----	-----	peak	



Unless otherwise agreed in writing, this document is issued by the Company subject to its General Conditions of Service printed overleaf, available on request or accessible at <http://www.sgs.com/en/Terms-and-Conditions.aspx> and, for electronic format documents, subject to Terms and Conditions for Electronic Documents at <http://www.sgs.com/en/Terms-and-Conditions/Terms-e-Documents.aspx>. Attention is drawn to the limitation of liability, indemnification and jurisdiction issues defined therein. Any holder of this document is advised that information contained hereon reflects the Company's findings at the time of its intervention only and within the limits of Client's instructions, if any. The Company's sole responsibility is to its Client and this document does not exonerate parties to a transaction from exercising all their rights and obligations under the transaction documents. This document cannot be reproduced except in full, without prior written approval of the Company. Any unauthorized alteration, forgery or falsification of the content or appearance of this document is unlawful and offenders may be prosecuted to the fullest extent of the law. Unless otherwise stated the results shown in this test report refer only to the sample(s) tested and such sample(s) are retained for 30 days only.

Test Mode: 08; Polarity: Vertical; Modulation:802.11ac; Bandwidth:20MHz; Channel:Low

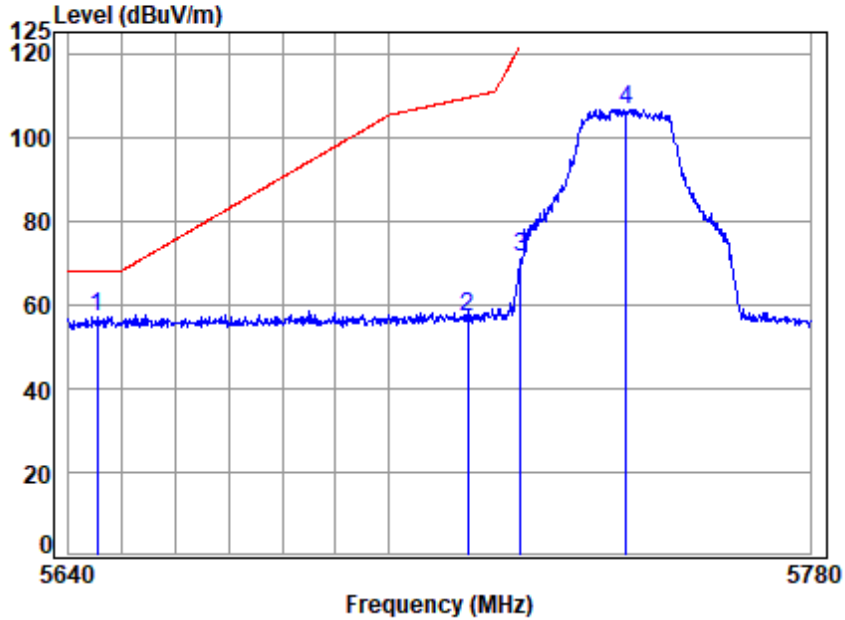

Site : chamber
 Condition: 3m VERTICAL
 Job No : 00750AT\00751AT
 Mode : 5745 Band edge
 : 5G WIFI 11AC20

		Cable	Ant	Preamp	Read	Limit	Over	
	Freq	Loss	Factor	Factor	Level	Level	Line	Limit
	MHz	dB	dB/m	dB	dBuV	dBuV/m	dBuV/m	dB
1	q 5645.257	7.84	34.50	35.02	49.79	57.11	68.20	-11.09 peak
2	5715.000	7.91	34.50	35.02	49.88	57.27	109.40	-52.13 peak
3	5725.000	7.92	34.50	35.02	63.69	71.09	122.20	-51.11 peak
4	5745.000	7.93	34.50	35.03	99.29	106.69	-----	----- peak



Unless otherwise agreed in writing, this document is issued by the Company subject to its General Conditions of Service printed overleaf, available on request or accessible at <http://www.sgs.com/en/Terms-and-Conditions.aspx> and, for electronic format documents, subject to Terms and Conditions for Electronic Documents at <http://www.sgs.com/en/Terms-and-Conditions/Terms-e-Documents.aspx>. Attention is drawn to the limitation of liability, indemnification and jurisdiction issues defined therein. Any holder of this document is advised that information contained hereon reflects the Company's findings at the time of its intervention only and within the limits of Client's instructions, if any. The Company's sole responsibility is to its Client and this document does not exonerate parties to a transaction from exercising all their rights and obligations under the transaction documents. This document cannot be reproduced except in full, without prior written approval of the Company. Any unauthorized alteration, forgery or falsification of the content or appearance of this document is unlawful and offenders may be prosecuted to the fullest extent of the law. Unless otherwise stated the results shown in this test report refer only to the sample(s) tested and such sample(s) are retained for 30 days only.

Test Mode: 08; Polarity: Horizontal; Modulation:802.11ac; Bandwidth:20MHz; Channel:High

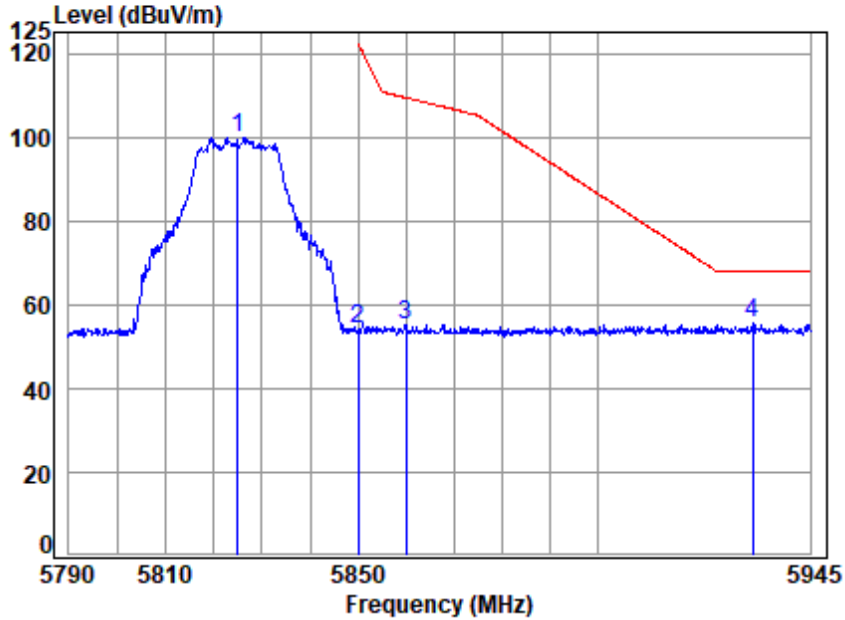

Site : chamber
 Condition: 3m HORIZONTAL
 Job No : 00750AT\00751AT
 Mode : 5825 Band edge
 : 5G WIFI 11AC20

	Freq	Cable Loss	Ant Factor	Preamp Factor	Read Level	Limit Level	Limit Line	Over Limit	Remark
	MHz	dB	dB/m	dB	dBuV	dBuV/m	dBuV/m	dB	
1	5825.000	8.01	34.65	35.03	92.39	100.02	-----	-----	peak
2	5850.000	8.03	34.70	35.03	46.51	54.21	122.20	-67.99	peak
3	5860.000	8.04	34.72	35.03	47.63	55.36	109.40	-54.04	peak
4 q	5932.762	8.10	34.87	35.04	47.68	55.61	68.20	-12.59	peak



Unless otherwise agreed in writing, this document is issued by the Company subject to its General Conditions of Service printed overleaf, available on request or accessible at <http://www.sgs.com/en/Terms-and-Conditions.aspx> and, for electronic format documents, subject to Terms and Conditions for Electronic Documents at <http://www.sgs.com/en/Terms-and-Conditions/Terms-e-Documents.aspx>. Attention is drawn to the limitation of liability, indemnification and jurisdiction issues defined therein. Any holder of this document is advised that information contained hereon reflects the Company's findings at the time of its intervention only and within the limits of Client's instructions, if any. The Company's sole responsibility is to its Client and this document does not exonerate parties to a transaction from exercising all their rights and obligations under the transaction documents. This document cannot be reproduced except in full, without prior written approval of the Company. Any unauthorized alteration, forgery or falsification of the content or appearance of this document is unlawful and offenders may be prosecuted to the fullest extent of the law. Unless otherwise stated the results shown in this test report refer only to the sample(s) tested and such sample(s) are retained for 30 days only.

Test Mode: 08; Polarity: Vertical; Modulation:802.11ac; Bandwidth:20MHz; Channel:High

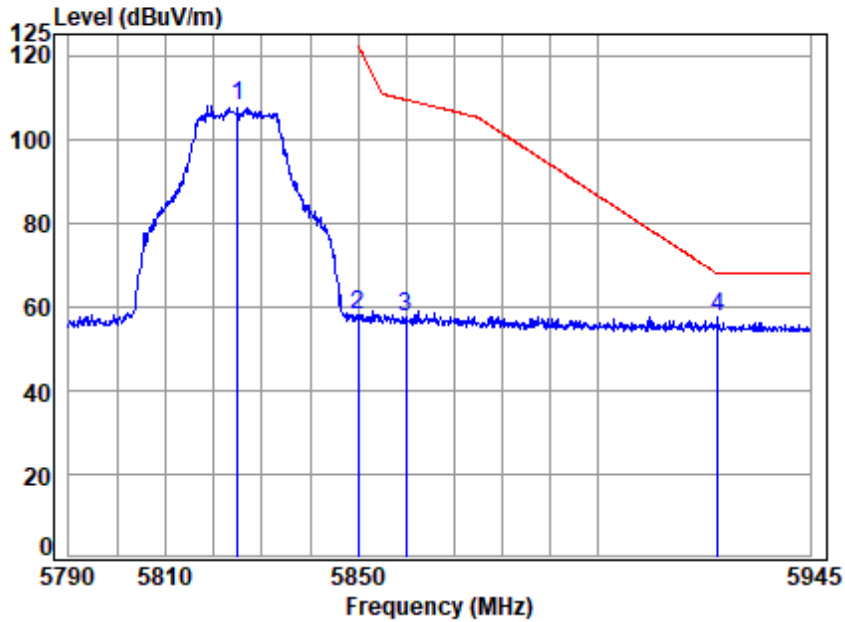

Site : chamber
 Condition: 3m VERTICAL
 Job No : 00750AT\00751AT
 Mode : 5825 Band edge
 : 5G WIFI 11AC20

		Cable	Ant	Preamp	Read	Limit	Over		
Freq		Loss	Factor	Factor	Level	Level	Line	Limit	Remark
	MHz	dB	dB/m	dB	dBuV	dBuV/m	dBuV/m	dB	
1	5825.000	8.01	34.65	35.03	100.11	107.74	-----	-----	peak
2	5850.000	8.03	34.70	35.03	50.23	57.93	122.20	-64.27	peak
3	5860.000	8.04	34.72	35.03	49.82	57.55	109.40	-51.85	peak
4 q	5925.557	8.09	34.85	35.04	49.42	57.32	68.20	-10.88	peak



Unless otherwise agreed in writing, this document is issued by the Company subject to its General Conditions of Service printed overleaf, available on request or accessible at <http://www.sgs.com/en/Terms-and-Conditions.aspx> and, for electronic format documents, subject to Terms and Conditions for Electronic Documents at <http://www.sgs.com/en/Terms-and-Conditions/Terms-e-Documents.aspx>. Attention is drawn to the limitation of liability, indemnification and jurisdiction issues defined therein. Any holder of this document is advised that information contained hereon reflects the Company's findings at the time of its intervention only and within the limits of Client's instructions, if any. The Company's sole responsibility is to its Client and this document does not exonerate parties to a transaction from exercising all their rights and obligations under the transaction documents. This document cannot be reproduced except in full, without prior written approval of the Company. Any unauthorized alteration, forgery or falsification of the content or appearance of this document is unlawful and offenders may be prosecuted to the fullest extent of the law. Unless otherwise stated the results shown in this test report refer only to the sample(s) tested and such sample(s) are retained for 30 days only.

Test Mode: 08; Polarity: Horizontal; Modulation:802.11ac; Bandwidth:40MHz; Channel:Low

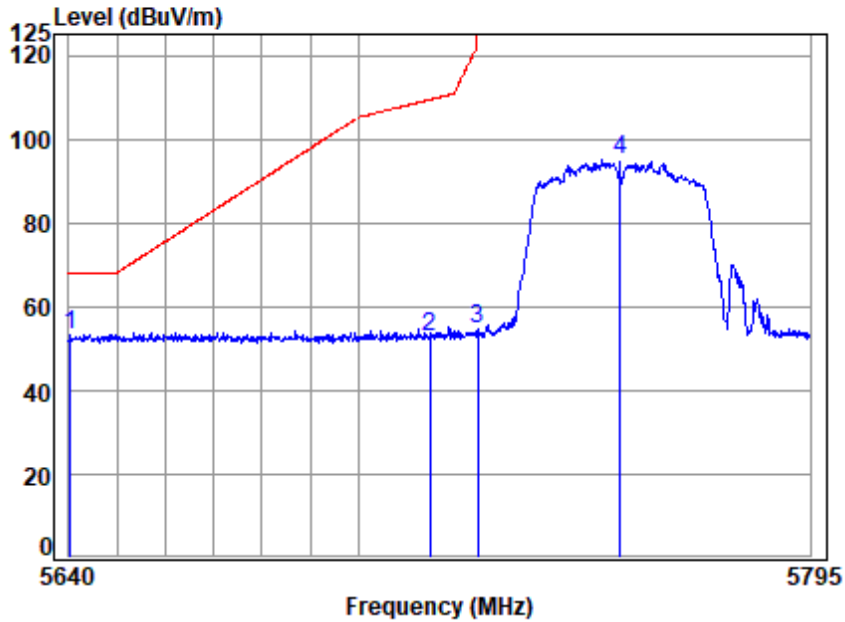

Site : chamber
 Condition: 3m HORIZONTAL
 Job No : 00750AT\00751AT
 Mode : 5755 Band edge
 : 5G WIFI 11AC40

		Cable	Ant	Preamp	Read	Limit	Over	
Freq		Loss	Factor	Factor	Level	Level	Line	Limit
	MHz	dB	dB/m	dB	dBuV	dBuV/m	dBuV/m	dB
1 q	5640.306	7.84	34.50	35.02	46.04	53.36	68.20	-14.84 peak
2	5715.000	7.91	34.50	35.02	45.33	52.72	109.40	-56.68 peak
3	5725.000	7.92	34.50	35.02	47.11	54.51	122.20	-67.69 peak
4	5755.000	7.94	34.51	35.03	87.46	94.88	-----	----- peak



Unless otherwise agreed in writing, this document is issued by the Company subject to its General Conditions of Service printed overleaf, available on request or accessible at <http://www.sgs.com/en/Terms-and-Conditions.aspx> and, for electronic format documents, subject to Terms and Conditions for Electronic Documents at <http://www.sgs.com/en/Terms-and-Conditions/Terms-e-Documents.aspx>. Attention is drawn to the limitation of liability, indemnification and jurisdiction issues defined therein. Any holder of this document is advised that information contained hereon reflects the Company's findings at the time of its intervention only and within the limits of Client's instructions, if any. The Company's sole responsibility is to its Client and this document does not exonerate parties to a transaction from exercising all their rights and obligations under the transaction documents. This document cannot be reproduced except in full, without prior written approval of the Company. Any unauthorized alteration, forgery or falsification of the content or appearance of this document is unlawful and offenders may be prosecuted to the fullest extent of the law. Unless otherwise stated the results shown in this test report refer only to the sample(s) tested and such sample(s) are retained for 30 days only.

Test Mode: 08; Polarity: Vertical; Modulation:802.11ac; Bandwidth:40MHz; Channel:Low

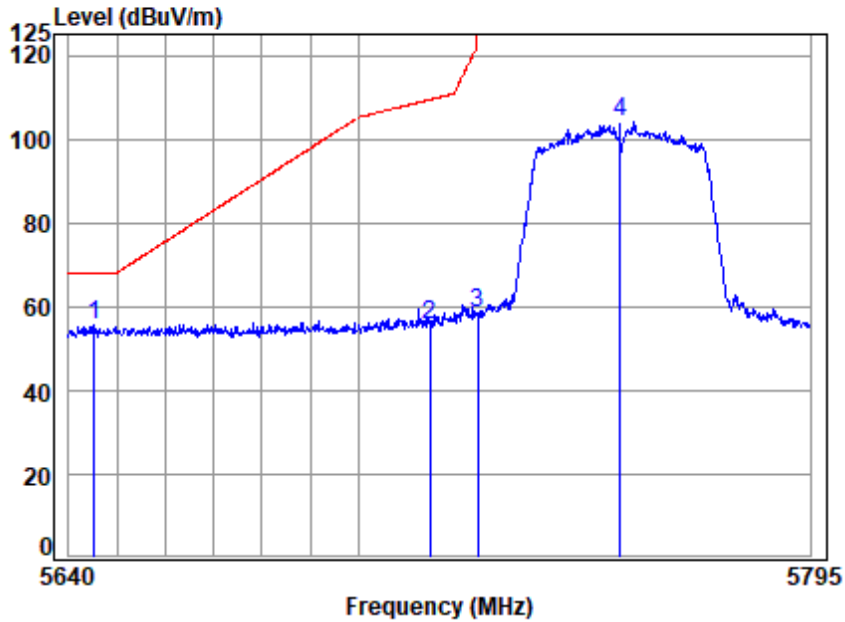

Site : chamber
 Condition: 3m VERTICAL
 Job No : 00750AT\00751AT
 Mode : 5755 Band edge
 : 5G WIFI 11AC40

	Freq	Cable Loss	Ant Factor	Preamp Factor	Read Level	Limit Level	Over Limit	Remark
	MHz	dB	dB/m	dB	dBuV	dBuV/m	dBuV/m	dB
1	5645.354	7.84	34.50	35.02	48.15	55.47	68.20	-12.73 peak
2	5715.000	7.91	34.50	35.02	48.17	55.56	109.40	-53.84 peak
3	5725.000	7.92	34.50	35.02	51.28	58.68	122.20	-63.52 peak
4	5755.000	7.94	34.51	35.03	96.62	104.04	-----	----- peak



Unless otherwise agreed in writing, this document is issued by the Company subject to its General Conditions of Service printed overleaf, available on request or accessible at <http://www.sgs.com/en/Terms-and-Conditions.aspx> and, for electronic format documents, subject to Terms and Conditions for Electronic Documents at <http://www.sgs.com/en/Terms-and-Conditions/Terms-e-Documents.aspx>. Attention is drawn to the limitation of liability, indemnification and jurisdiction issues defined therein. Any holder of this document is advised that information contained hereon reflects the Company's findings at the time of its intervention only and within the limits of Client's instructions, if any. The Company's sole responsibility is to its Client and this document does not exonerate parties to a transaction from exercising all their rights and obligations under the transaction documents. This document cannot be reproduced except in full, without prior written approval of the Company. Any unauthorized alteration, forgery or falsification of the content or appearance of this document is unlawful and offenders may be prosecuted to the fullest extent of the law. Unless otherwise stated the results shown in this test report refer only to the sample(s) tested and such sample(s) are retained for 30 days only.
 Attention: To check the authenticity of testing /inspection report & certificate, please contact us at telephone: (86-755) 8307 1443, or email: CN_Doccheck@sgs.com

Test Mode: 08; Polarity: Horizontal; Modulation:802.11ac; Bandwidth:40MHz; Channel:High

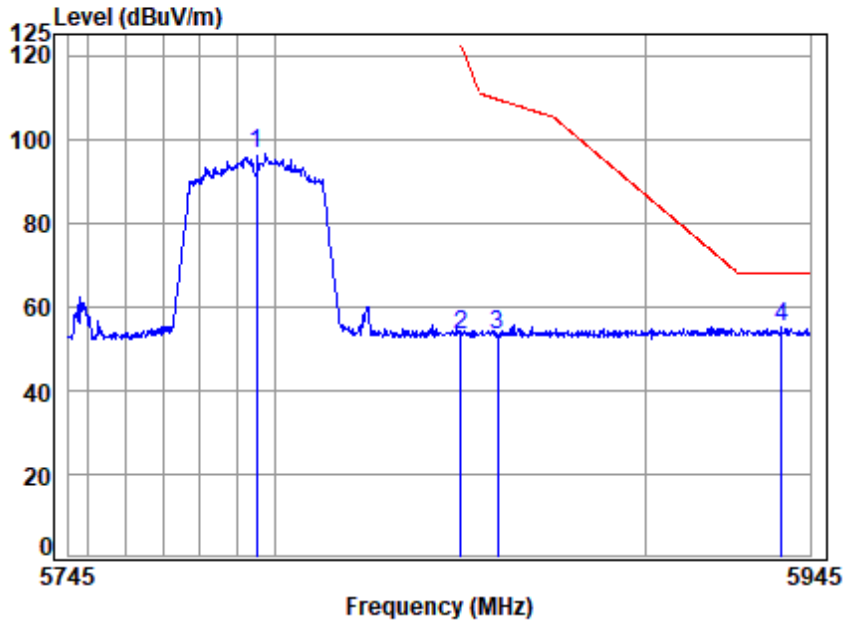

Site : chamber
 Condition: 3m HORIZONTAL
 Job No : 00750AT\00751AT
 Mode : 5795 Band edge
 : 5G WIFI 11AC40

	Freq	Cable Loss	Ant Factor	Preamp Factor	Read Level	Limit Level	Limit Line	Over Limit	Remark
	MHz	dB	dB/m	dB	dBuV	dBuV/m	dBuV/m	dB	
1	5795.000	7.98	34.59	35.03	88.71	96.25	-----	-----	peak
2	5850.000	8.03	34.70	35.03	45.44	53.14	122.20	-69.06	peak
3	5860.000	8.04	34.72	35.03	45.72	53.45	109.40	-55.95	peak
4 q	5937.071	8.11	34.87	35.04	46.98	54.92	68.20	-13.28	peak



Unless otherwise agreed in writing, this document is issued by the Company subject to its General Conditions of Service printed overleaf, available on request or accessible at <http://www.sgs.com/en/Terms-and-Conditions.aspx> and, for electronic format documents, subject to Terms and Conditions for Electronic Documents at <http://www.sgs.com/en/Terms-and-Conditions/Terms-e-Documents.aspx>. Attention is drawn to the limitation of liability, indemnification and jurisdiction issues defined therein. Any holder of this document is advised that information contained hereon reflects the Company's findings at the time of its intervention only and within the limits of Client's instructions, if any. The Company's sole responsibility is to its Client and this document does not exonerate parties to a transaction from exercising all their rights and obligations under the transaction documents. This document cannot be reproduced except in full, without prior written approval of the Company. Any unauthorized alteration, forgery or falsification of the content or appearance of this document is unlawful and offenders may be prosecuted to the fullest extent of the law. Unless otherwise stated the results shown in this test report refer only to the sample(s) tested and such sample(s) are retained for 30 days only.

Test Mode: 08; Polarity: Vertical; Modulation:802.11ac; Bandwidth:40MHz; Channel:High

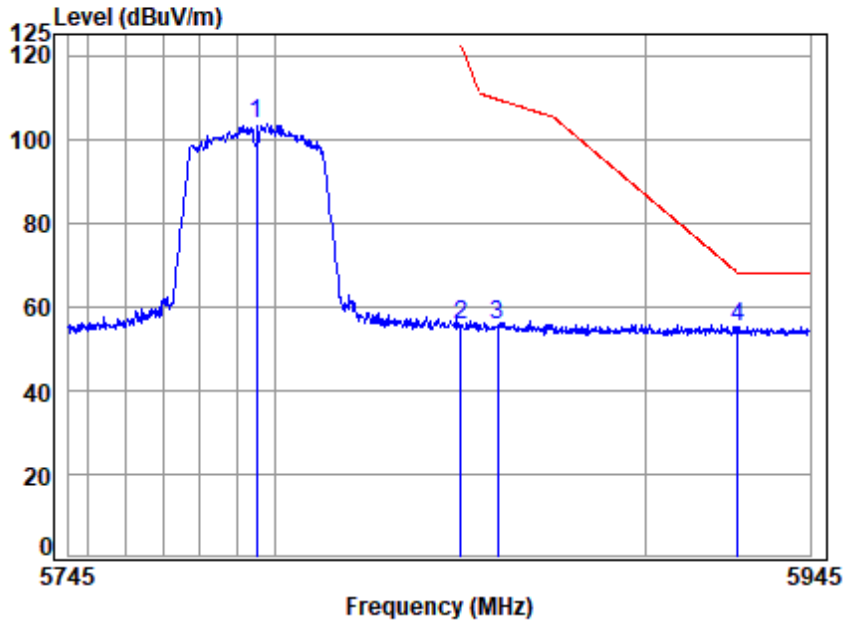

Site : chamber
 Condition: 3m VERTICAL
 Job No : 00750AT\00751AT
 Mode : 5795 Band edge
 : 5G WIFI 11AC40

		Cable	Ant	Preamp	Read	Limit	Over	
	Freq	Loss	Factor	Factor	Level	Line	Limit	Remark
	MHz	dB	dB/m	dB	dBuV	dBuV/m	dBuV/m	dB
1	5795.000	7.98	34.59	35.03	95.87	103.41	-----	----- peak
2	5850.000	8.03	34.70	35.03	47.68	55.38	122.20	-66.82 peak
3	5860.000	8.04	34.72	35.03	48.04	55.77	109.40	-53.63 peak
4 q	5925.299	8.09	34.85	35.04	47.11	55.01	68.20	-13.19 peak



Unless otherwise agreed in writing, this document is issued by the Company subject to its General Conditions of Service printed overleaf, available on request or accessible at <http://www.sgs.com/en/Terms-and-Conditions.aspx> and, for electronic format documents, subject to Terms and Conditions for Electronic Documents at <http://www.sgs.com/en/Terms-and-Conditions/Terms-e-Documents.aspx>. Attention is drawn to the limitation of liability, indemnification and jurisdiction issues defined therein. Any holder of this document is advised that information contained hereon reflects the Company's findings at the time of its intervention only and within the limits of Client's instructions, if any. The Company's sole responsibility is to its Client and this document does not exonerate parties to a transaction from exercising all their rights and obligations under the transaction documents. This document cannot be reproduced except in full, without prior written approval of the Company. Any unauthorized alteration, forgery or falsification of the content or appearance of this document is unlawful and offenders may be prosecuted to the fullest extent of the law. Unless otherwise stated the results shown in this test report refer only to the sample(s) tested and such sample(s) are retained for 30 days only.

Test Mode: 08; Polarity: Horizontal; Modulation:802.11ac; Bandwidth:80MHz; Channel:middle

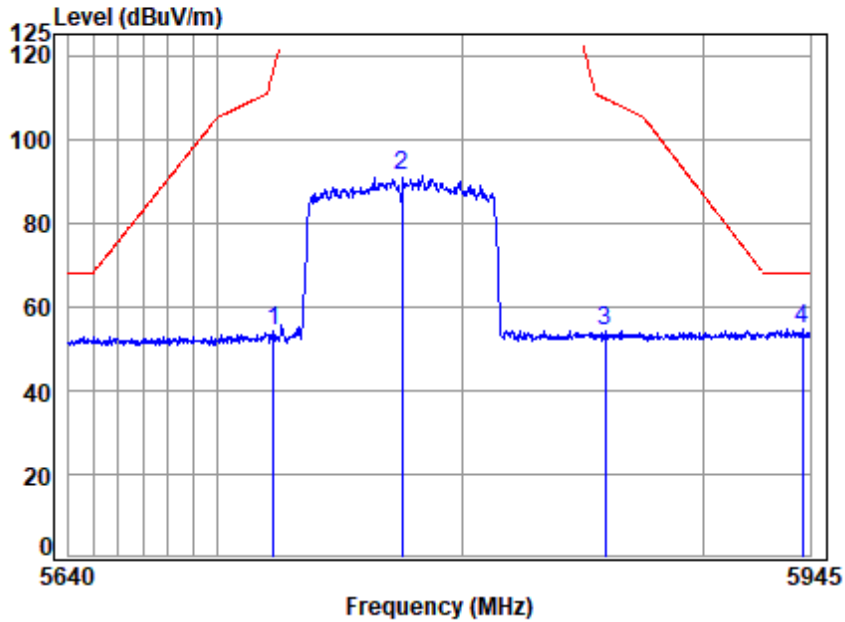

Site : chamber
 Condition: 3m HORIZONTAL
 Job No : 00750AT\00751AT
 Mode : 5775 Band edge
 : 5G WIFI 11AC80

		Cable	Ant	Preamp	Read	Limit	Over	
Freq		Loss	Factor	Factor	Level	Level	Line	Limit
	MHz	dB	dB/m	dB	dBuV	dBuV/m	dBuV/m	dB
1	5722.582	7.91	34.50	35.02	46.76	54.15	116.69	-62.54 peak
2	5775.000	7.96	34.55	35.03	83.82	91.30	-----	----- peak
3	5859.209	8.04	34.72	35.03	46.49	54.22	109.62	-55.40 peak
4 q	5941.870	8.11	34.88	35.04	46.82	54.77	68.20	-13.43 peak



Unless otherwise agreed in writing, this document is issued by the Company subject to its General Conditions of Service printed overleaf, available on request or accessible at <http://www.sgs.com/en/Terms-and-Conditions.aspx> and, for electronic format documents, subject to Terms and Conditions for Electronic Documents at <http://www.sgs.com/en/Terms-and-Conditions/Terms-e-Documents.aspx>. Attention is drawn to the limitation of liability, indemnification and jurisdiction issues defined therein. Any holder of this document is advised that information contained hereon reflects the Company's findings at the time of its intervention only and within the limits of Client's instructions, if any. The Company's sole responsibility is to its Client and this document does not exonerate parties to a transaction from exercising all their rights and obligations under the transaction documents. This document cannot be reproduced except in full, without prior written approval of the Company. Any unauthorized alteration, forgery or falsification of the content or appearance of this document is unlawful and offenders may be prosecuted to the fullest extent of the law. Unless otherwise stated the results shown in this test report refer only to the sample(s) tested and such sample(s) are retained for 30 days only.

Test Mode: 08; Polarity: Vertical; Modulation:802.11ac; Bandwidth:80MHz; Channel:middle

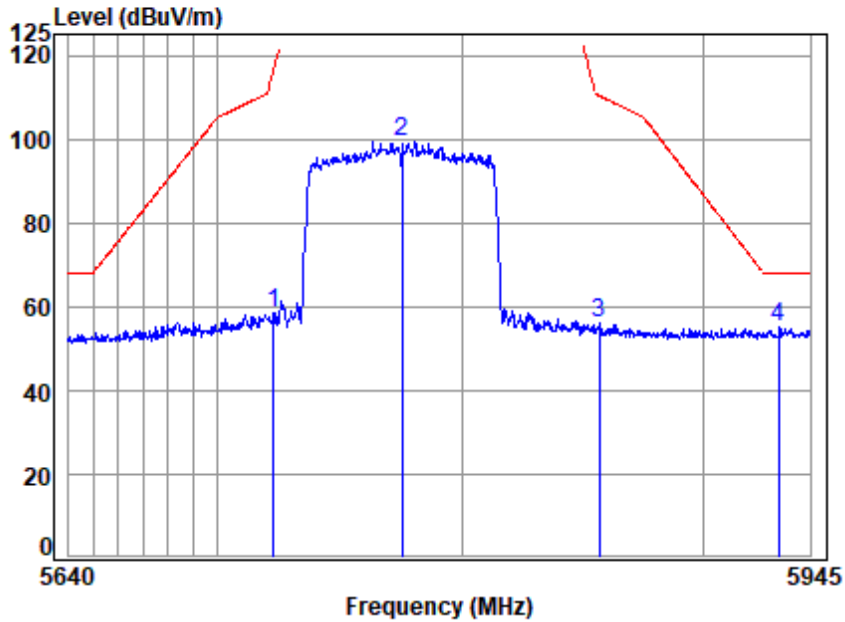

Site : chamber
 Condition: 3m VERTICAL
 Job No : 00750AT\00751AT
 Mode : 5775 Band edge
 : 5G WIFI 11AC80

		Cable	Ant	Preamp	Read	Limit	Over	
Freq		Loss	Factor	Factor	Level	Level	Line	Limit
	MHz	dB	dB/m	dB	dBuV	dBuV/m	dBuV/m	dB
1	5722.582	7.91	34.50	35.02	51.19	58.58	116.69	-58.11 peak
2	5775.000	7.96	34.55	35.03	91.68	99.16	-----	----- peak
3	5856.432	8.03	34.71	35.03	48.17	55.88	110.40	-54.52 peak
4 q	5931.864	8.10	34.86	35.04	47.27	55.19	68.20	-13.01 peak



Unless otherwise agreed in writing, this document is issued by the Company subject to its General Conditions of Service printed overleaf, available on request or accessible at <http://www.sgs.com/en/Terms-and-Conditions.aspx> and, for electronic format documents, subject to Terms and Conditions for Electronic Documents at <http://www.sgs.com/en/Terms-and-Conditions/Terms-e-Documents.aspx>. Attention is drawn to the limitation of liability, indemnification and jurisdiction issues defined therein. Any holder of this document is advised that information contained hereon reflects the Company's findings at the time of its intervention only and within the limits of Client's instructions, if any. The Company's sole responsibility is to its Client and this document does not exonerate parties to a transaction from exercising all their rights and obligations under the transaction documents. This document cannot be reproduced except in full, without prior written approval of the Company. Any unauthorized alteration, forgery or falsification of the content or appearance of this document is unlawful and offenders may be prosecuted to the fullest extent of the law. Unless otherwise stated the results shown in this test report refer only to the sample(s) tested and such sample(s) are retained for 30 days only.

Test Mode: 08; Polarity: Horizontal; Modulation:802.11ax; Bandwidth:20MHz; Channel:Low

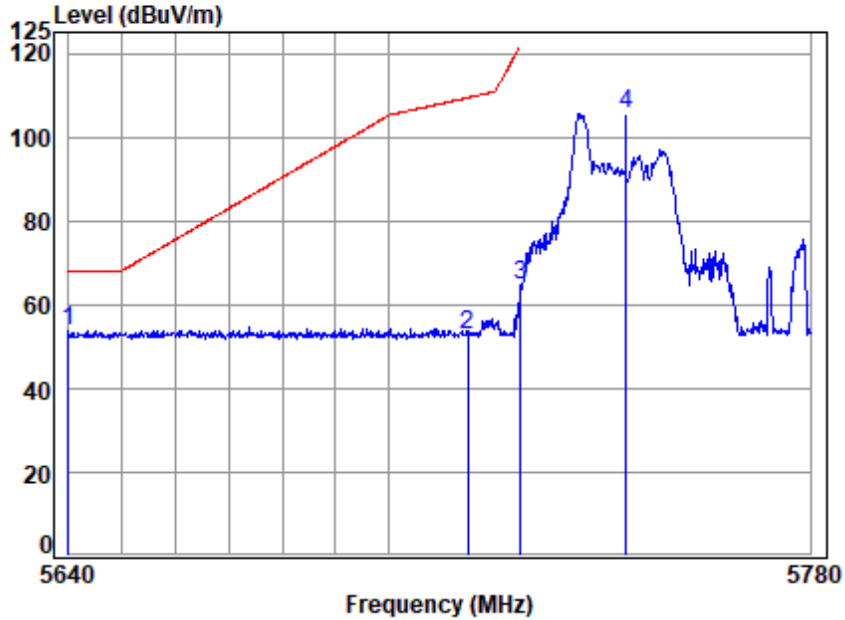

Site : chamber
 Condition: 3m HORIZONTAL
 Job No : 00750AT\00751AT
 Mode : 5745 Band edge
 : 5G WIFI 11AX20 26 RU

	Cable	Ant	Preamp	Read	Limit	Over		
Freq	Loss	Factor	Factor	Level	Level	Line	Limit	Remark
MHz	dB	dB/m	dB	dBuV	dBuV/m	dBuV/m	dB	
1 q 5640.000	7.84	34.50	35.02	46.45	53.77	68.20	-14.43	peak
2 5715.000	7.91	34.50	35.02	45.51	52.90	109.40	-56.50	peak
3 5725.000	7.92	34.50	35.02	57.21	64.61	122.20	-57.59	peak
4 5745.000	7.93	34.50	35.03	98.03	105.43	-----	-----	peak



Unless otherwise agreed in writing, this document is issued by the Company subject to its General Conditions of Service printed overleaf, available on request or accessible at <http://www.sgs.com/en/Terms-and-Conditions.aspx> and, for electronic format documents, subject to Terms and Conditions for Electronic Documents at <http://www.sgs.com/en/Terms-and-Conditions/Terms-e-Documents.aspx>. Attention is drawn to the limitation of liability, indemnification and jurisdiction issues defined therein. Any holder of this document is advised that information contained hereon reflects the Company's findings at the time of its intervention only and within the limits of Client's instructions, if any. The Company's sole responsibility is to its Client and this document does not exonerate parties to a transaction from exercising all their rights and obligations under the transaction documents. This document cannot be reproduced except in full, without prior written approval of the Company. Any unauthorized alteration, forgery or falsification of the content or appearance of this document is unlawful and offenders may be prosecuted to the fullest extent of the law. Unless otherwise stated the results shown in this test report refer only to the sample(s) tested and such sample(s) are retained for 30 days only.

Test Mode: 08; Polarity: Vertical; Modulation:802.11ax; Bandwidth:20MHz; Channel:Low

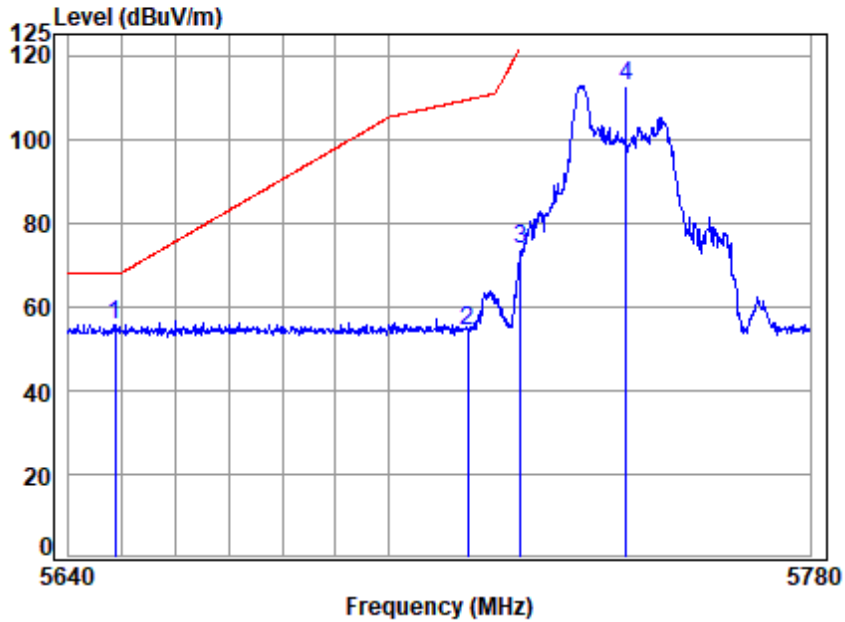

Site : chamber
 Condition: 3m VERTICAL
 Job No : 00750AT\00751AT
 Mode : 5745 Band edge
 : 5G WIFI 11AX20 26 RU

	Cable	Ant	Preamp	Read	Limit	Over		
Freq	Loss	Factor	Factor	Level	Level	Line	Limit	Remark
MHz	dB	dB/m	dB	dBuV	dBuV/m	dBuV/m	dB	
1 q 5648.719	7.85	34.50	35.02	48.34	55.67	68.20	-12.53	peak
2 5715.000	7.91	34.50	35.02	46.82	54.21	109.40	-55.19	peak
3 5725.000	7.92	34.50	35.02	66.11	73.51	122.20	-48.69	peak
4 5745.000	7.93	34.50	35.03	105.39	112.79	-----	-----	peak



Unless otherwise agreed in writing, this document is issued by the Company subject to its General Conditions of Service printed overleaf, available on request or accessible at <http://www.sgs.com/en/Terms-and-Conditions.aspx> and, for electronic format documents, subject to Terms and Conditions for Electronic Documents at <http://www.sgs.com/en/Terms-and-Conditions/Terms-e-Documents.aspx>. Attention is drawn to the limitation of liability, indemnification and jurisdiction issues defined therein. Any holder of this document is advised that information contained hereon reflects the Company's findings at the time of its intervention only and within the limits of Client's instructions, if any. The Company's sole responsibility is to its Client and this document does not exonerate parties to a transaction from exercising all their rights and obligations under the transaction documents. This document cannot be reproduced except in full, without prior written approval of the Company. Any unauthorized alteration, forgery or falsification of the content or appearance of this document is unlawful and offenders may be prosecuted to the fullest extent of the law. Unless otherwise stated the results shown in this test report refer only to the sample(s) tested and such sample(s) are retained for 30 days only.

Test Mode: 08; Polarity: Horizontal; Modulation:802.11ax; Bandwidth:20MHz; Channel:Low

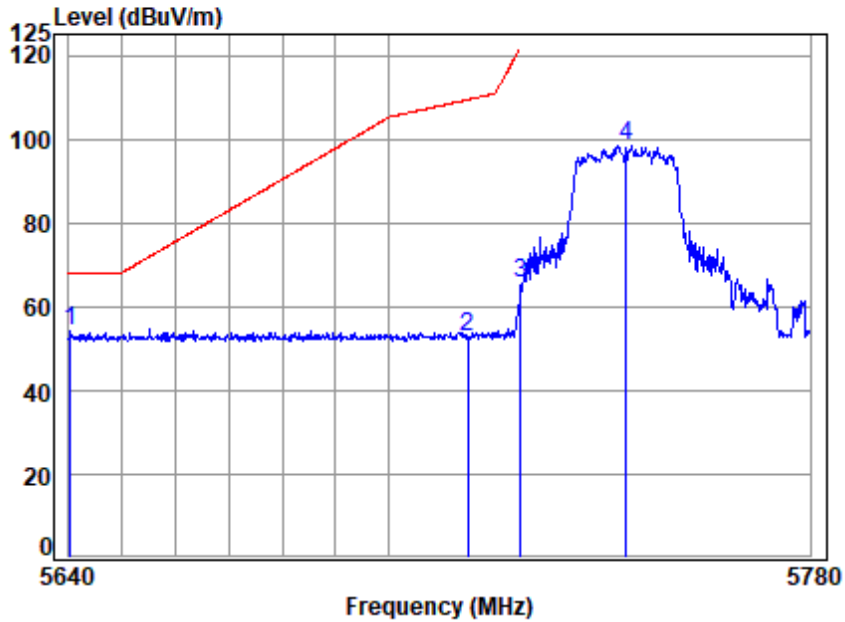

Site : chamber
 Condition: 3m HORIZONTAL
 Job No : 00750AT\00751AT
 Mode : 5745 Band edge
 : 5G WIFI 11AX20 242 RU

	Cable	Ant	Preamp	Read	Limit	Over		
Freq	Loss	Factor	Factor	Level	Level	Line	Limit	Remark
MHz	dB	dB/m	dB	dBuV	dBuV/m	dBuV/m	dB	
1 q 5640.276	7.84	34.50	35.02	46.69	54.01	68.20	-14.19	peak
2 5715.000	7.91	34.50	35.02	45.31	52.70	109.40	-56.70	peak
3 5725.000	7.92	34.50	35.02	58.02	65.42	122.20	-56.78	peak
4 5745.000	7.93	34.50	35.03	91.17	98.57	-----	-----	peak



Unless otherwise agreed in writing, this document is issued by the Company subject to its General Conditions of Service printed overleaf, available on request or accessible at <http://www.sgs.com/en/Terms-and-Conditions.aspx> and, for electronic format documents, subject to Terms and Conditions for Electronic Documents at <http://www.sgs.com/en/Terms-and-Conditions/Terms-e-Documents.aspx>. Attention is drawn to the limitation of liability, indemnification and jurisdiction issues defined therein. Any holder of this document is advised that information contained hereon reflects the Company's findings at the time of its intervention only and within the limits of Client's instructions, if any. The Company's sole responsibility is to its Client and this document does not exonerate parties to a transaction from exercising all their rights and obligations under the transaction documents. This document cannot be reproduced except in full, without prior written approval of the Company. Any unauthorized alteration, forgery or falsification of the content or appearance of this document is unlawful and offenders may be prosecuted to the fullest extent of the law. Unless otherwise stated the results shown in this test report refer only to the sample(s) tested and such sample(s) are retained for 30 days only.
 Attention: To check the authenticity of testing /inspection report & certificate, please contact us at telephone: (86-755) 8307 1443, or email: CN.Doccheck@sgs.com

Test Mode: 08; Polarity: Vertical; Modulation:802.11ax; Bandwidth:20MHz; Channel:Low

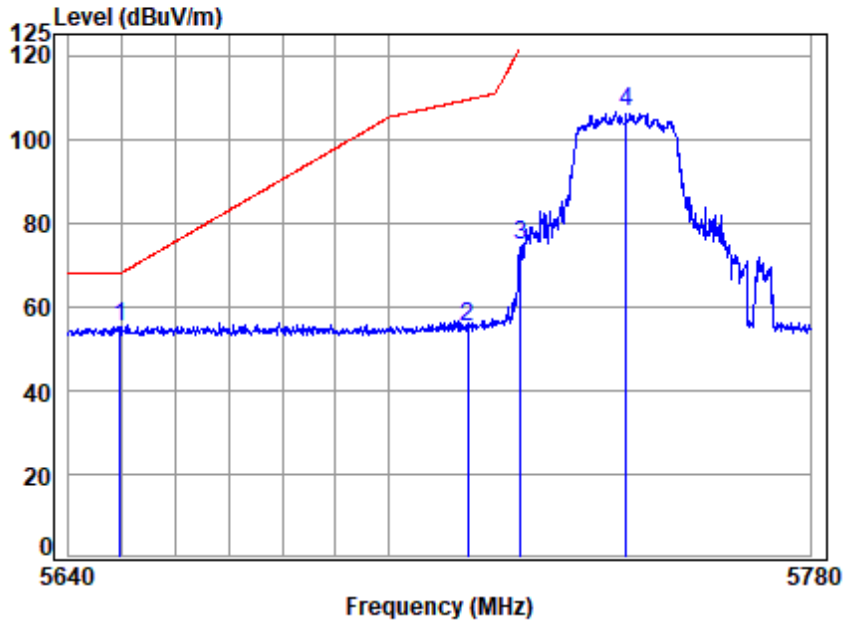

Site : chamber
 Condition: 3m VERTICAL
 Job No : 00750AT\00751AT
 Mode : 5745 Band edge
 : 5G WIFI 11AX20 242 RU

	Cable	Ant	Preamp	Read	Limit	Over		
Freq	Loss	Factor	Factor	Level	Level	Line	Limit	Remark
MHz	dB	dB/m	dB	dBuV	dBuV/m	dBuV/m	dB	
1 q 5649.688	7.85	34.50	35.02	47.91	55.24	68.20	-12.96	peak
2 5715.000	7.91	34.50	35.02	47.90	55.29	109.40	-54.11	peak
3 5725.000	7.92	34.50	35.02	67.45	74.85	122.20	-47.35	peak
4 5745.000	7.93	34.50	35.03	98.95	106.35	-----	-----	peak



Unless otherwise agreed in writing, this document is issued by the Company subject to its General Conditions of Service printed overleaf, available on request or accessible at <http://www.sgs.com/en/Terms-and-Conditions.aspx> and, for electronic format documents, subject to Terms and Conditions for Electronic Documents at <http://www.sgs.com/en/Terms-and-Conditions/Terms-e-Documents.aspx>. Attention is drawn to the limitation of liability, indemnification and jurisdiction issues defined therein. Any holder of this document is advised that information contained hereon reflects the Company's findings at the time of its intervention only and within the limits of Client's instructions, if any. The Company's sole responsibility is to its Client and this document does not exonerate parties to a transaction from exercising all their rights and obligations under the transaction documents. This document cannot be reproduced except in full, without prior written approval of the Company. Any unauthorized alteration, forgery or falsification of the content or appearance of this document is unlawful and offenders may be prosecuted to the fullest extent of the law. Unless otherwise stated the results shown in this test report refer only to the sample(s) tested and such sample(s) are retained for 30 days only.

Test Mode: 08; Polarity: Horizontal; Modulation:802.11ax; Bandwidth:20MHz; Channel:High

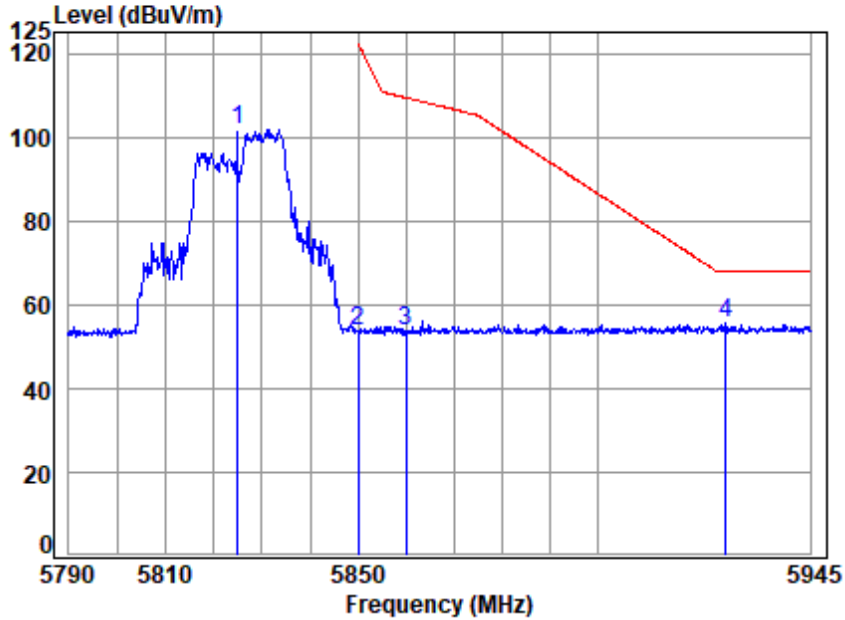

Site : chamber
 Condition: 3m HORIZONTAL
 Job No : 00750AT\00751AT
 Mode : 5825 Band edge
 : 5G WIFI 11AX20 106 RU

		Cable	Ant	Preamp	Read	Limit	Over		
	Freq	Loss	Factor	Factor	Level	Level	Line	Limit	
	MHz	dB	dB/m	dB	dBuV	dBuV/m	dBuV/m	dB	
1	5825.000	8.01	34.65	35.03	94.28	101.91	-----	-----	peak
2	5850.000	8.03	34.70	35.03	46.07	53.77	122.20	-68.43	peak
3	5860.000	8.04	34.72	35.03	45.95	53.68	109.40	-55.72	peak
4 q	5927.123	8.10	34.85	35.04	47.52	55.43	68.20	-12.77	peak



Unless otherwise agreed in writing, this document is issued by the Company subject to its General Conditions of Service printed overleaf, available on request or accessible at <http://www.sgs.com/en/Terms-and-Conditions.aspx> and, for electronic format documents, subject to Terms and Conditions for Electronic Documents at <http://www.sgs.com/en/Terms-and-Conditions/Terms-e-Documents.aspx>. Attention is drawn to the limitation of liability, indemnification and jurisdiction issues defined therein. Any holder of this document is advised that information contained hereon reflects the Company's findings at the time of its intervention only and within the limits of Client's instructions, if any. The Company's sole responsibility is to its Client and this document does not exonerate parties to a transaction from exercising all their rights and obligations under the transaction documents. This document cannot be reproduced except in full, without prior written approval of the Company. Any unauthorized alteration, forgery or falsification of the content or appearance of this document is unlawful and offenders may be prosecuted to the fullest extent of the law. Unless otherwise stated the results shown in this test report refer only to the sample(s) tested and such sample(s) are retained for 30 days only.

Test Mode: 08; Polarity: Vertical; Modulation:802.11ax; Bandwidth:20MHz; Channel:High

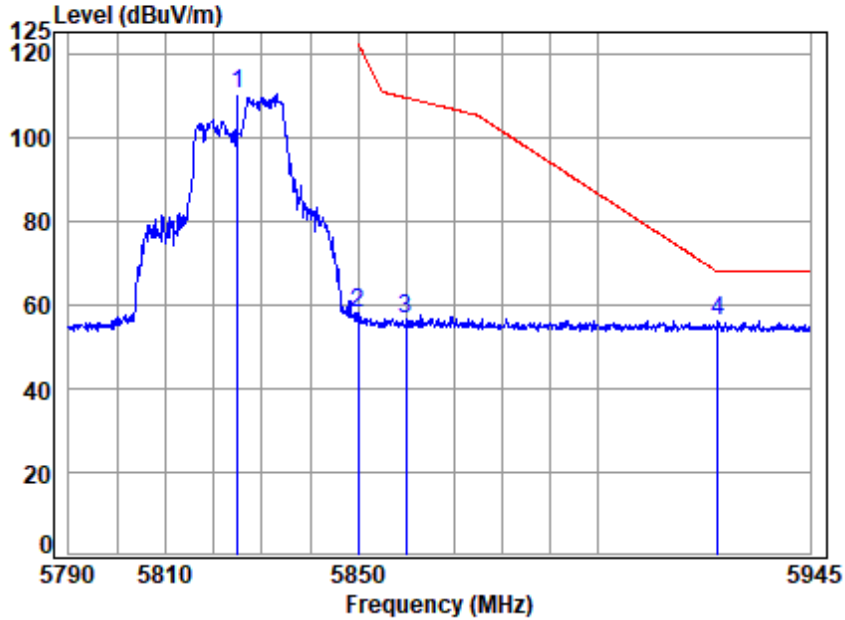

Site : chamber
 Condition: 3m VERTICAL
 Job No : 00750AT\00751AT
 Mode : 5825 Band edge
 : 5G WIFI 11AX20 106 RU

		Cable	Ant	Preamp	Read	Limit	Over		
Freq	Loss	Factor	Factor	Factor	Level	Level	Line	Limit	Remark
MHz	dB	dB/m	dB/m	dB	dBuV	dBuV/m	dBuV/m	dB	
1	5825.000	8.01	34.65	35.03	102.65	110.28	-----	-----	peak
2	5850.000	8.03	34.70	35.03	50.18	57.88	122.20	-64.32	peak
3	5860.000	8.04	34.72	35.03	48.68	56.41	109.40	-52.99	peak
4 q	5925.557	8.09	34.85	35.04	48.23	56.13	68.20	-12.07	peak



Unless otherwise agreed in writing, this document is issued by the Company subject to its General Conditions of Service printed overleaf, available on request or accessible at <http://www.sgs.com/en/Terms-and-Conditions.aspx> and, for electronic format documents, subject to Terms and Conditions for Electronic Documents at <http://www.sgs.com/en/Terms-and-Conditions/Terms-e-Documents.aspx>. Attention is drawn to the limitation of liability, indemnification and jurisdiction issues defined therein. Any holder of this document is advised that information contained hereon reflects the Company's findings at the time of its intervention only and within the limits of Client's instructions, if any. The Company's sole responsibility is to its Client and this document does not exonerate parties to a transaction from exercising all their rights and obligations under the transaction documents. This document cannot be reproduced except in full, without prior written approval of the Company. Any unauthorized alteration, forgery or falsification of the content or appearance of this document is unlawful and offenders may be prosecuted to the fullest extent of the law. Unless otherwise stated the results shown in this test report refer only to the sample(s) tested and such sample(s) are retained for 30 days only.

Test Mode: 08; Polarity: Horizontal; Modulation:802.11ax; Bandwidth:20MHz; Channel:High

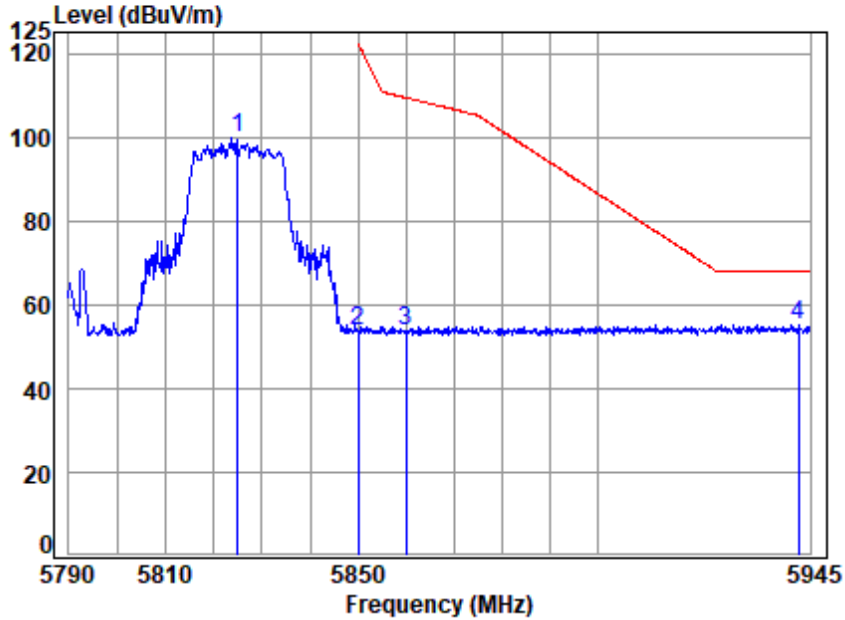

Site : chamber
 Condition: 3m HORIZONTAL
 Job No : 00750AT\00751AT
 Mode : 5825 Band edge
 : 5G WIFI 11AX20 242 RU

		Cable	Ant	Preamp	Read	Limit	Over		
Freq		Loss	Factor	Factor	Level	Level	Line	Limit	
	MHz	dB	dB/m	dB	dBuV	dBuV/m	dBuV/m	dB	
1	5825.000	8.01	34.65	35.03	92.20	99.83	-----	-----	peak
2	5850.000	8.03	34.70	35.03	46.19	53.89	122.20	-68.31	peak
3	5860.000	8.04	34.72	35.03	46.17	53.90	109.40	-55.50	peak
4 q	5942.645	8.11	34.89	35.04	47.36	55.32	68.20	-12.88	peak



Unless otherwise agreed in writing, this document is issued by the Company subject to its General Conditions of Service printed overleaf, available on request or accessible at <http://www.sgs.com/en/Terms-and-Conditions.aspx> and, for electronic format documents, subject to Terms and Conditions for Electronic Documents at <http://www.sgs.com/en/Terms-and-Conditions/Terms-e-Documents.aspx>. Attention is drawn to the limitation of liability, indemnification and jurisdiction issues defined therein. Any holder of this document is advised that information contained hereon reflects the Company's findings at the time of its intervention only and within the limits of Client's instructions, if any. The Company's sole responsibility is to its Client and this document does not exonerate parties to a transaction from exercising all their rights and obligations under the transaction documents. This document cannot be reproduced except in full, without prior written approval of the Company. Any unauthorized alteration, forgery or falsification of the content or appearance of this document is unlawful and offenders may be prosecuted to the fullest extent of the law. Unless otherwise stated the results shown in this test report refer only to the sample(s) tested and such sample(s) are retained for 30 days only.

Test Mode: 08; Polarity: Vertical; Modulation:802.11ax; Bandwidth:20MHz; Channel:High

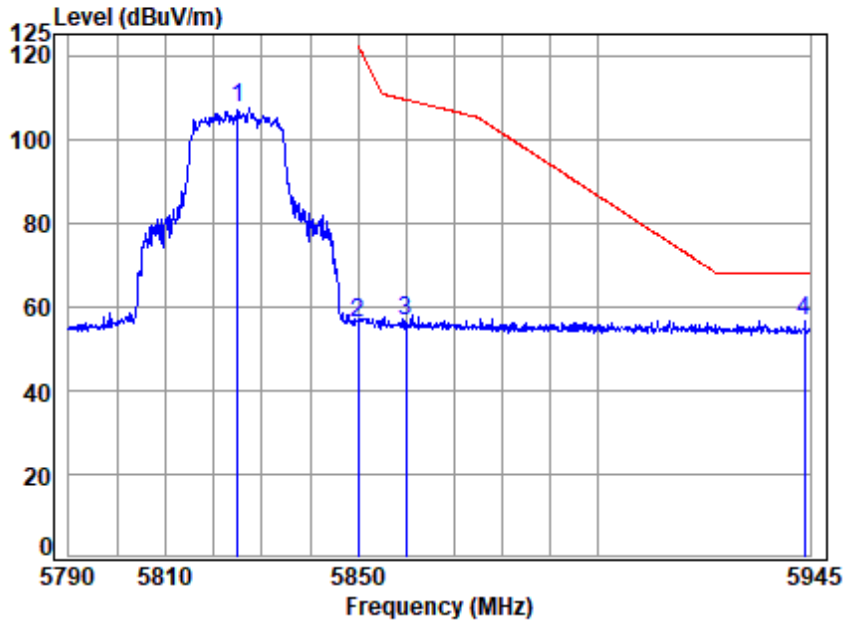

Site : chamber
 Condition: 3m VERTICAL
 Job No : 00750AT\00751AT
 Mode : 5825 Band edge
 : 5G WIFI 11AX20 242 RU

		Cable	Ant	Preamp	Read	Limit	Over		
Freq	Loss	Factor	Factor	Factor	Level	Level	Line	Limit	Remark
MHz	dB	dB/m	dB/m	dB	dBuV	dBuV/m	dBuV/m	dB	
1	5825.000	8.01	34.65	35.03	99.62	107.25	-----	-----	peak
2	5850.000	8.03	34.70	35.03	48.50	56.20	122.20	-66.00	peak
3	5860.000	8.04	34.72	35.03	48.77	56.50	109.40	-52.90	peak
4 q	5943.901	8.11	34.89	35.04	48.54	56.50	68.20	-11.70	peak



Unless otherwise agreed in writing, this document is issued by the Company subject to its General Conditions of Service printed overleaf, available on request or accessible at <http://www.sgs.com/en/Terms-and-Conditions.aspx> and, for electronic format documents, subject to Terms and Conditions for Electronic Documents at <http://www.sgs.com/en/Terms-and-Conditions/Terms-e-Documents.aspx>. Attention is drawn to the limitation of liability, indemnification and jurisdiction issues defined therein. Any holder of this document is advised that information contained hereon reflects the Company's findings at the time of its intervention only and within the limits of Client's instructions, if any. The Company's sole responsibility is to its Client and this document does not exonerate parties to a transaction from exercising all their rights and obligations under the transaction documents. This document cannot be reproduced except in full, without prior written approval of the Company. Any unauthorized alteration, forgery or falsification of the content or appearance of this document is unlawful and offenders may be prosecuted to the fullest extent of the law. Unless otherwise stated the results shown in this test report refer only to the sample(s) tested and such sample(s) are retained for 30 days only.

Test Mode: 08; Polarity: Horizontal; Modulation:802.11ax; Bandwidth:40MHz; Channel:Low

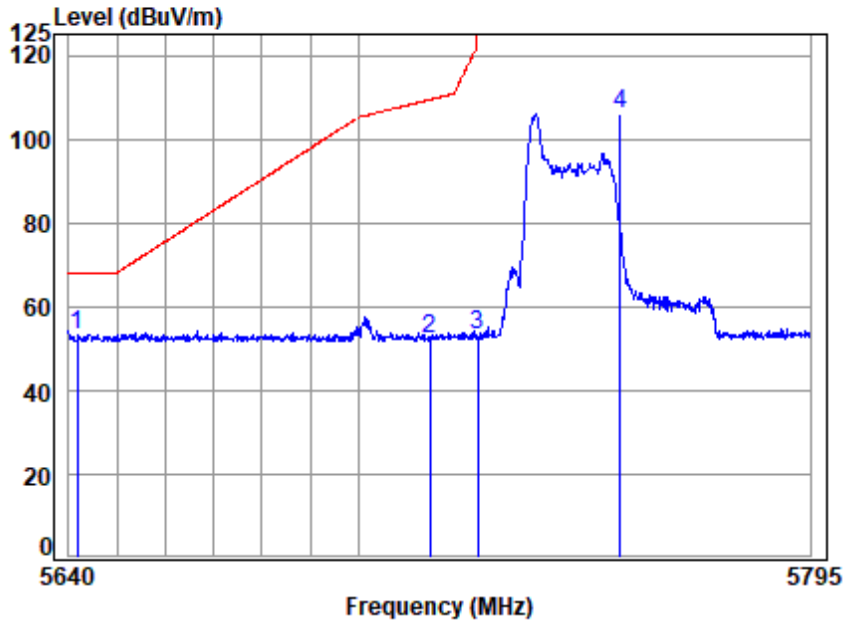

Site : chamber
 Condition: 3m HORIZONTAL
 Job No : 00750AT\00751AT
 Mode : 5755 Band edge
 : 5G WIFI 11AX40 26 RU

	Cable	Ant	Preamp	Read	Limit	Over		
Freq	Loss	Factor	Factor	Level	Level	Line	Limit	Remark
MHz	dB	dB/m	dB	dBuV	dBuV/m	dBuV/m	dB	
1 q 5641.835	7.84	34.50	35.02	46.05	53.37	68.20	-14.83	peak
2 5715.000	7.91	34.50	35.02	45.00	52.39	109.40	-57.01	peak
3 5725.000	7.92	34.50	35.02	45.91	53.31	122.20	-68.89	peak
4 5755.000	7.94	34.51	35.03	98.61	106.03	-----	-----	peak



Unless otherwise agreed in writing, this document is issued by the Company subject to its General Conditions of Service printed overleaf, available on request or accessible at <http://www.sgs.com/en/Terms-and-Conditions.aspx> and, for electronic format documents, subject to Terms and Conditions for Electronic Documents at <http://www.sgs.com/en/Terms-and-Conditions/Terms-e-Documents.aspx>. Attention is drawn to the limitation of liability, indemnification and jurisdiction issues defined therein. Any holder of this document is advised that information contained hereon reflects the Company's findings at the time of its intervention only and within the limits of Client's instructions, if any. The Company's sole responsibility is to its Client and this document does not exonerate parties to a transaction from exercising all their rights and obligations under the transaction documents. This document cannot be reproduced except in full, without prior written approval of the Company. Any unauthorized alteration, forgery or falsification of the content or appearance of this document is unlawful and offenders may be prosecuted to the fullest extent of the law. Unless otherwise stated the results shown in this test report refer only to the sample(s) tested and such sample(s) are retained for 30 days only.

Test Mode: 08; Polarity: Vertical; Modulation:802.11ax; Bandwidth:40MHz; Channel:Low

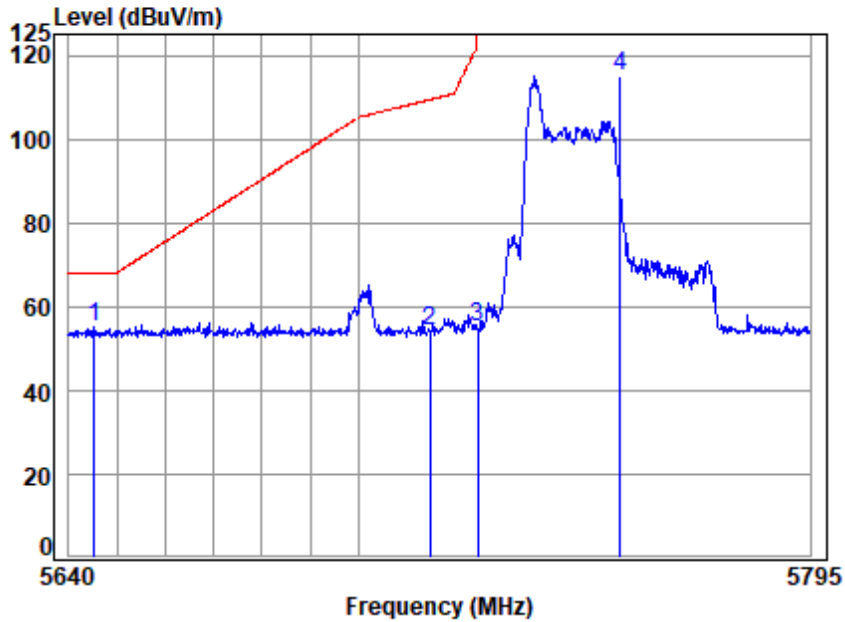

Site : chamber
 Condition: 3m VERTICAL
 Job No : 00750AT\00751AT
 Mode : 5755 Band edge
 : 5G WIFI 11AX40 26 RU

	Cable	Ant	Preamp	Read	Limit	Over		
Freq	Loss	Factor	Factor	Level	Level	Line	Limit	Remark
MHz	dB	dB/m	dB	dBuV	dBuV/m	dBuV/m	dB	
1 q 5645.201	7.84	34.50	35.02	47.65	54.97	68.20	-13.23	peak
2 5715.000	7.91	34.50	35.02	46.85	54.24	109.40	-55.16	peak
3 5725.000	7.92	34.50	35.02	47.58	54.98	122.20	-67.22	peak
4 5755.000	7.94	34.51	35.03	107.45	114.87	-----	-----	peak



Unless otherwise agreed in writing, this document is issued by the Company subject to its General Conditions of Service printed overleaf, available on request or accessible at <http://www.sgs.com/en/Terms-and-Conditions.aspx> and, for electronic format documents, subject to Terms and Conditions for Electronic Documents at <http://www.sgs.com/en/Terms-and-Conditions/Terms-e-Documents.aspx>. Attention is drawn to the limitation of liability, indemnification and jurisdiction issues defined therein. Any holder of this document is advised that information contained hereon reflects the Company's findings at the time of its intervention only and within the limits of Client's instructions, if any. The Company's sole responsibility is to its Client and this document does not exonerate parties to a transaction from exercising all their rights and obligations under the transaction documents. This document cannot be reproduced except in full, without prior written approval of the Company. Any unauthorized alteration, forgery or falsification of the content or appearance of this document is unlawful and offenders may be prosecuted to the fullest extent of the law. Unless otherwise stated the results shown in this test report refer only to the sample(s) tested and such sample(s) are retained for 30 days only.

Test Mode: 08; Polarity: Horizontal; Modulation:802.11ax; Bandwidth:40MHz; Channel:Low

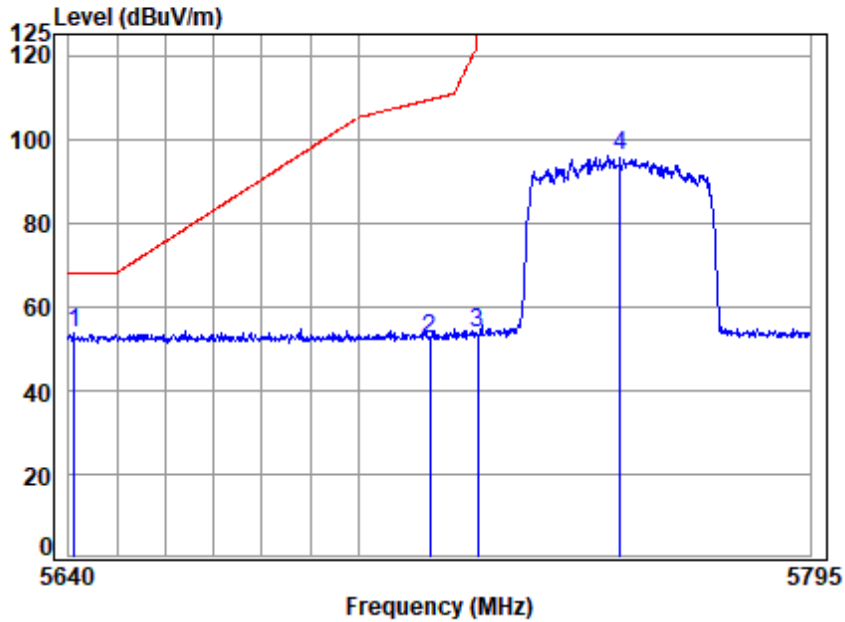

Site : chamber
 Condition: 3m HORIZONTAL
 Job No : 00750AT\00751AT
 Mode : 5755 Band edge
 : 5G WIFI 11AX40 484 RU

	Cable	Ant	Preamp	Read	Limit	Over		
Freq	Loss	Factor	Factor	Level	Level	Line	Limit	Remark
MHz	dB	dB/m	dB	dBuV	dBuV/m	dBuV/m	dB	
1 q 5641.070	7.84	34.50	35.02	46.34	53.66	68.20	-14.54	peak
2 5715.000	7.91	34.50	35.02	45.02	52.41	109.40	-56.99	peak
3 5725.000	7.92	34.50	35.02	46.40	53.80	122.20	-68.40	peak
4 5755.000	7.94	34.51	35.03	88.72	96.14	-----	-----	peak



Unless otherwise agreed in writing, this document is issued by the Company subject to its General Conditions of Service printed overleaf, available on request or accessible at <http://www.sgs.com/en/Terms-and-Conditions.aspx> and, for electronic format documents, subject to Terms and Conditions for Electronic Documents at <http://www.sgs.com/en/Terms-and-Conditions/Terms-e-Documents.aspx>. Attention is drawn to the limitation of liability, indemnification and jurisdiction issues defined therein. Any holder of this document is advised that information contained hereon reflects the Company's findings at the time of its intervention only and within the limits of Client's instructions, if any. The Company's sole responsibility is to its Client and this document does not exonerate parties to a transaction from exercising all their rights and obligations under the transaction documents. This document cannot be reproduced except in full, without prior written approval of the Company. Any unauthorized alteration, forgery or falsification of the content or appearance of this document is unlawful and offenders may be prosecuted to the fullest extent of the law. Unless otherwise stated the results shown in this test report refer only to the sample(s) tested and such sample(s) are retained for 30 days only.

Test Mode: 08; Polarity: Vertical; Modulation:802.11ax; Bandwidth:40MHz; Channel:Low

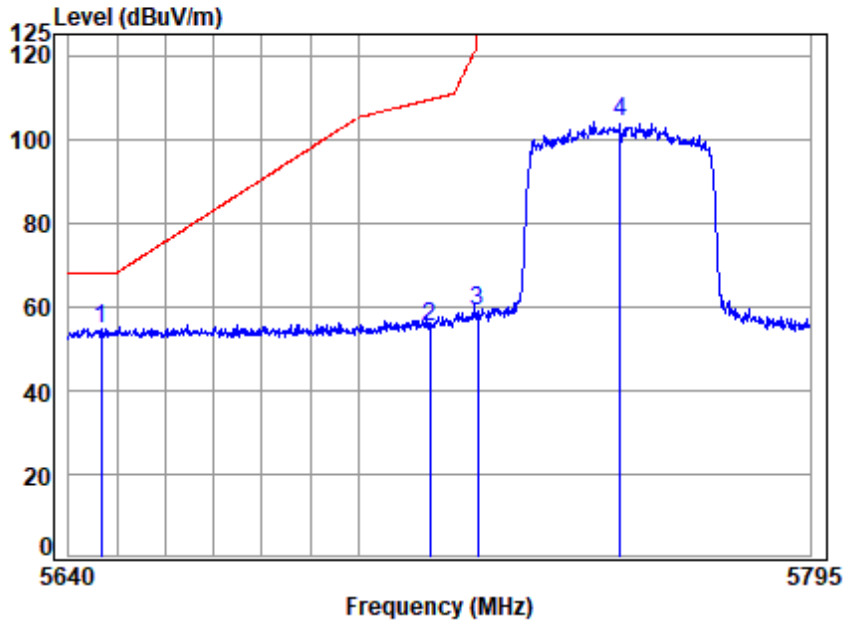

Site : chamber
 Condition: 3m VERTICAL
 Job No : 00750AT\00751AT
 Mode : 5755 Band edge
 : 5G WIFI 11AX40 484 RU

		Cable	Ant	Preamp	Read	Limit	Over	
	Freq	Loss	Factor	Factor	Level	Level	Line	Limit
	MHz	dB	dB/m	dB	dBuV	dBuV/m	dBuV/m	dB
1	q 5646.732	7.84	34.50	35.02	47.31	54.63	68.20	-13.57 peak
2	5715.000	7.91	34.50	35.02	47.90	55.29	109.40	-54.11 peak
3	5725.000	7.92	34.50	35.02	51.40	58.80	122.20	-63.40 peak
4	5755.000	7.94	34.51	35.03	96.55	103.97	-----	----- peak



Unless otherwise agreed in writing, this document is issued by the Company subject to its General Conditions of Service printed overleaf, available on request or accessible at <http://www.sgs.com/en/Terms-and-Conditions.aspx> and, for electronic format documents, subject to Terms and Conditions for Electronic Documents at <http://www.sgs.com/en/Terms-and-Conditions/Terms-e-Documents.aspx>. Attention is drawn to the limitation of liability, indemnification and jurisdiction issues defined therein. Any holder of this document is advised that information contained hereon reflects the Company's findings at the time of its intervention only and within the limits of Client's instructions, if any. The Company's sole responsibility is to its Client and this document does not exonerate parties to a transaction from exercising all their rights and obligations under the transaction documents. This document cannot be reproduced except in full, without prior written approval of the Company. Any unauthorized alteration, forgery or falsification of the content or appearance of this document is unlawful and offenders may be prosecuted to the fullest extent of the law. Unless otherwise stated the results shown in this test report refer only to the sample(s) tested and such sample(s) are retained for 30 days only.

Test Mode: 08; Polarity: Horizontal; Modulation:802.11ax; Bandwidth:40MHz; Channel:High

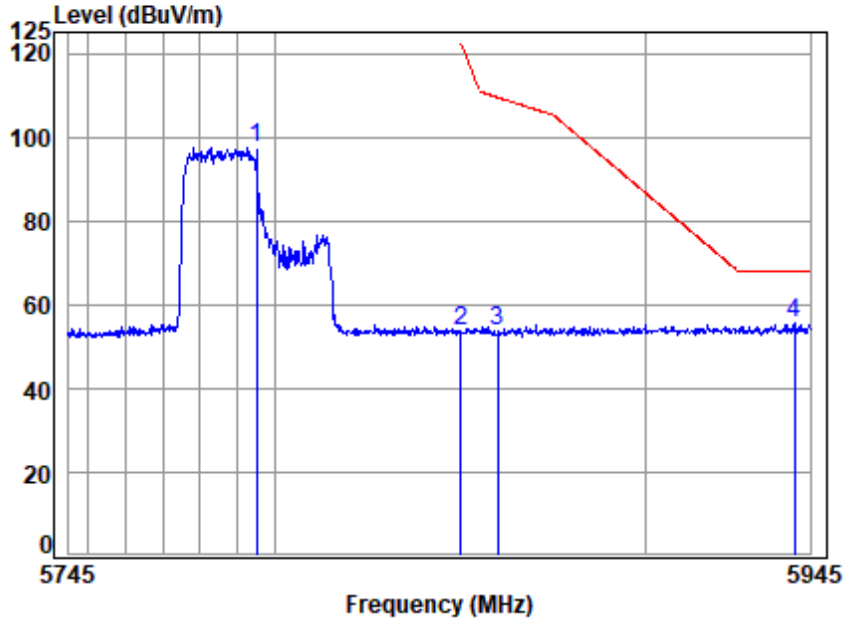

Site : chamber
 Condition: 3m HORIZONTAL
 Job No : 00750AT\00751AT
 Mode : 5795 Band edge
 : 5G WIFI 11AX40 242 RU

		Cable	Ant	Preamp	Read	Limit	Over		
Freq	Loss	Factor	Factor	Factor	Level	Level	Line	Limit	Remark
MHz	dB	dB/m	dB	dB	dBuV	dBuV/m	dBuV/m	dB	
1	5795.000	7.98	34.59	35.03	89.90	97.44	-----	-----	peak
2	5850.000	8.03	34.70	35.03	46.19	53.89	122.20	-68.31	peak
3	5860.000	8.04	34.72	35.03	46.21	53.94	109.40	-55.46	peak
4 q	5940.729	8.11	34.88	35.04	47.47	55.42	68.20	-12.78	peak



Unless otherwise agreed in writing, this document is issued by the Company subject to its General Conditions of Service printed overleaf, available on request or accessible at <http://www.sgs.com/en/Terms-and-Conditions.aspx> and, for electronic format documents, subject to Terms and Conditions for Electronic Documents at <http://www.sgs.com/en/Terms-and-Conditions/Terms-e-Documents.aspx>. Attention is drawn to the limitation of liability, indemnification and jurisdiction issues defined therein. Any holder of this document is advised that information contained hereon reflects the Company's findings at the time of its intervention only and within the limits of Client's instructions, if any. The Company's sole responsibility is to its Client and this document does not exonerate parties to a transaction from exercising all their rights and obligations under the transaction documents. This document cannot be reproduced except in full, without prior written approval of the Company. Any unauthorized alteration, forgery or falsification of the content or appearance of this document is unlawful and offenders may be prosecuted to the fullest extent of the law. Unless otherwise stated the results shown in this test report refer only to the sample(s) tested and such sample(s) are retained for 30 days only.

Test Mode: 08; Polarity: Vertical; Modulation:802.11ax; Bandwidth:40MHz; Channel:High

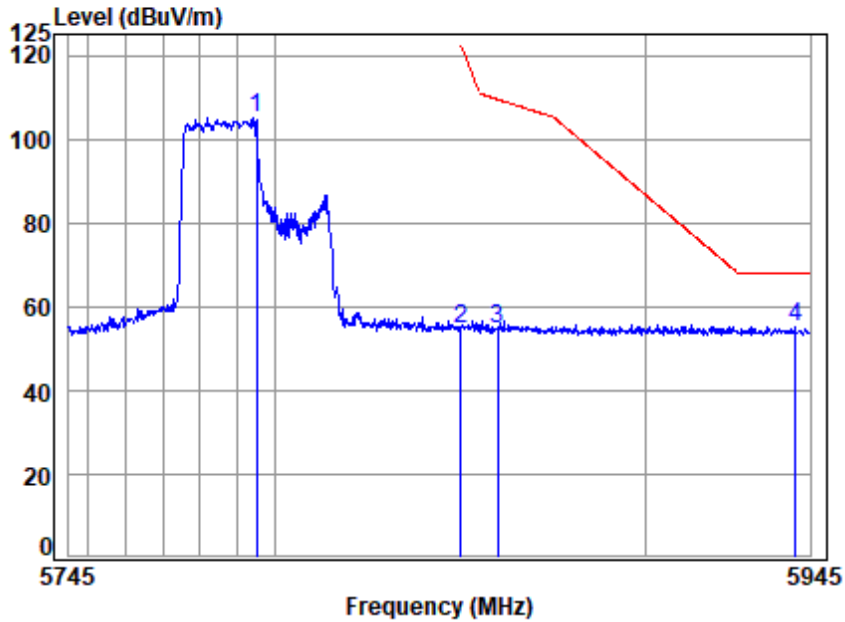

Site : chamber
 Condition: 3m VERTICAL
 Job No : 00750AT\00751AT
 Mode : 5795 Band edge
 : 5G WIFI 11AX40 242 RU

		Cable	Ant	Preamp	Read	Limit	Over	
Freq	Loss	Factor	Factor	Factor	Level	Line	Limit	Remark
MHz	dB	dB/m	dB	dB	dBuV	dBuV/m	dBuV/m	dB
1	5795.000	7.98	34.59	35.03	97.45	104.99	-----	----- peak
2	5850.000	8.03	34.70	35.03	46.74	54.44	122.20	-67.76 peak
3	5860.000	8.04	34.72	35.03	46.84	54.57	109.40	-54.83 peak
4 q	5940.933	8.11	34.88	35.04	47.40	55.35	68.20	-12.85 peak



Unless otherwise agreed in writing, this document is issued by the Company subject to its General Conditions of Service printed overleaf, available on request or accessible at <http://www.sgs.com/en/Terms-and-Conditions.aspx> and, for electronic format documents, subject to Terms and Conditions for Electronic Documents at <http://www.sgs.com/en/Terms-and-Conditions/Terms-e-Documents.aspx>. Attention is drawn to the limitation of liability, indemnification and jurisdiction issues defined therein. Any holder of this document is advised that information contained hereon reflects the Company's findings at the time of its intervention only and within the limits of Client's instructions, if any. The Company's sole responsibility is to its Client and this document does not exonerate parties to a transaction from exercising all their rights and obligations under the transaction documents. This document cannot be reproduced except in full, without prior written approval of the Company. Any unauthorized alteration, forgery or falsification of the content or appearance of this document is unlawful and offenders may be prosecuted to the fullest extent of the law. Unless otherwise stated the results shown in this test report refer only to the sample(s) tested and such sample(s) are retained for 30 days only.

Test Mode: 08; Polarity: Horizontal; Modulation:802.11ax; Bandwidth:40MHz; Channel:High

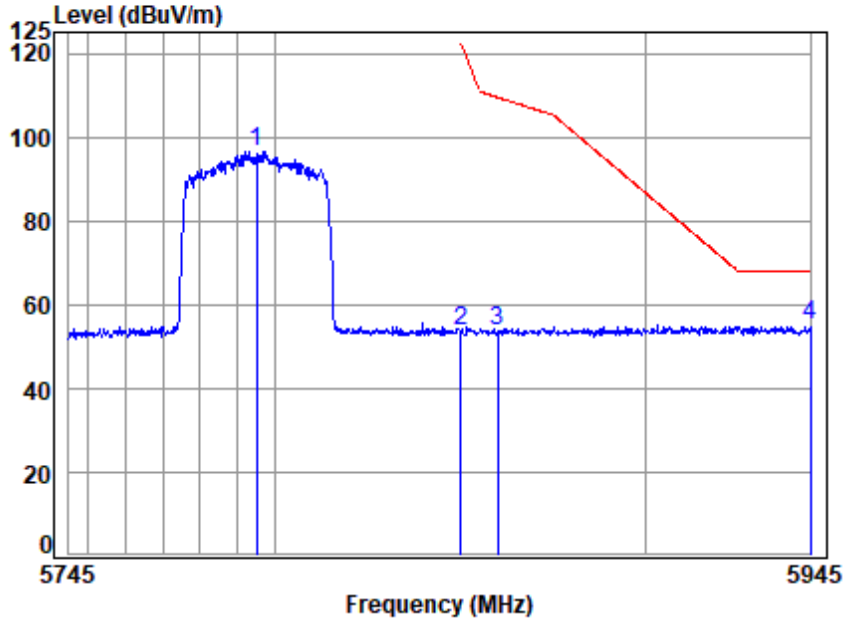

Site : chamber
 Condition: 3m HORIZONTAL
 Job No : 00750AT\00751AT
 Mode : 5795 Band edge
 : 5G WIFI 11AX40 484 RU

		Cable	Ant	Preamp	Read	Limit	Over		
Freq	Loss	Factor	Factor	Factor	Level	Level	Line	Limit	Remark
MHz	dB	dB/m	dB	dB	dBuV	dBuV/m	dBuV/m	dB	
1	5795.000	7.98	34.59	35.03	88.91	96.45	-----	-----	peak
2	5850.000	8.03	34.70	35.03	46.15	53.85	122.20	-68.35	peak
3	5860.000	8.04	34.72	35.03	46.09	53.82	109.40	-55.58	peak
4 q	5945.000	8.11	34.89	35.04	47.02	54.98	68.20	-13.22	peak



Unless otherwise agreed in writing, this document is issued by the Company subject to its General Conditions of Service printed overleaf, available on request or accessible at <http://www.sgs.com/en/Terms-and-Conditions.aspx> and, for electronic format documents, subject to Terms and Conditions for Electronic Documents at <http://www.sgs.com/en/Terms-and-Conditions/Terms-e-Documents.aspx>. Attention is drawn to the limitation of liability, indemnification and jurisdiction issues defined therein. Any holder of this document is advised that information contained hereon reflects the Company's findings at the time of its intervention only and within the limits of Client's instructions, if any. The Company's sole responsibility is to its Client and this document does not exonerate parties to a transaction from exercising all their rights and obligations under the transaction documents. This document cannot be reproduced except in full, without prior written approval of the Company. Any unauthorized alteration, forgery or falsification of the content or appearance of this document is unlawful and offenders may be prosecuted to the fullest extent of the law. Unless otherwise stated the results shown in this test report refer only to the sample(s) tested and such sample(s) are retained for 30 days only.

Test Mode: 08; Polarity: Vertical; Modulation:802.11ax; Bandwidth:40MHz; Channel:High

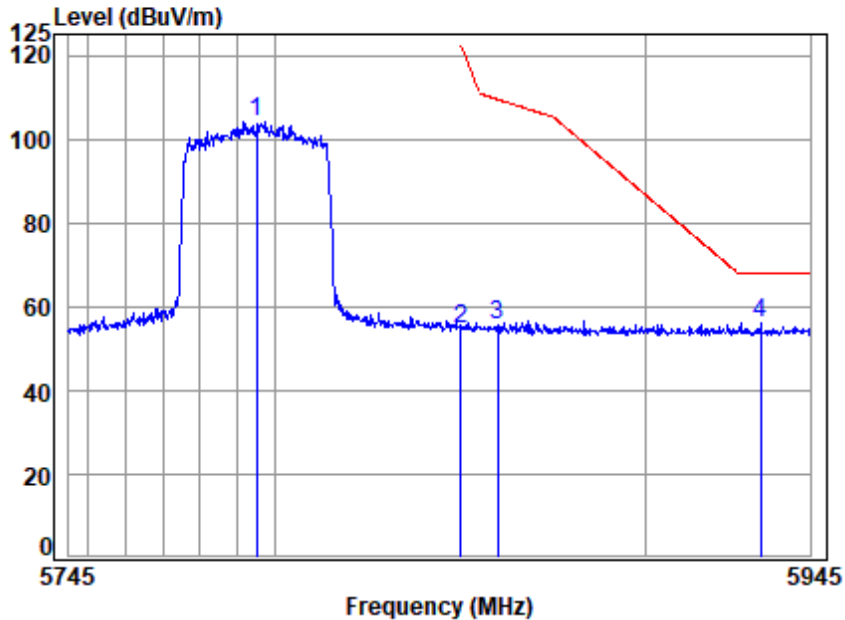

Site : chamber
 Condition: 3m VERTICAL
 Job No : 00750AT\00751AT
 Mode : 5795 Band edge
 : 5G WIFI 11AX40 484 RU

		Cable	Ant	Preamp	Read	Limit	Over		
Freq	Loss	Factor	Factor	Factor	Level	Level	Line	Limit	Remark
MHz	dB	dB/m	dB/m	dB	dBuV	dBuV/m	dBuV/m	dB	
1	5795.000	7.98	34.59	35.03	96.62	104.16	-----	-----	peak
2	5850.000	8.03	34.70	35.03	47.04	54.74	122.20	-67.46	peak
3	5860.000	8.04	34.72	35.03	47.67	55.40	109.40	-54.00	peak
4 q	5931.385	8.10	34.86	35.04	48.37	56.29	68.20	-11.91	peak



Test Mode: 08; Polarity: Horizontal; Modulation:802.11ax; Bandwidth:80MHz; Channel:middle

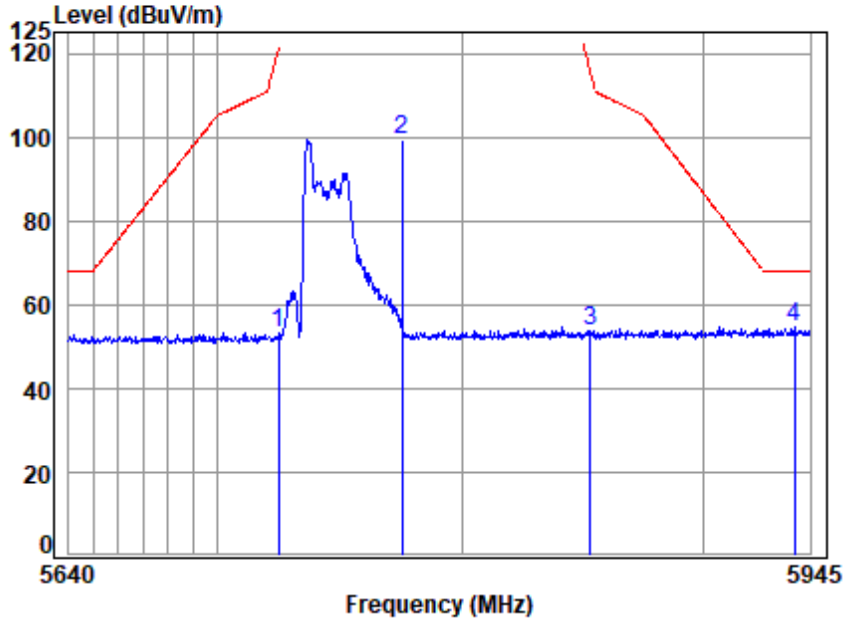

Site : chamber
 Condition: 3m HORIZONTAL
 Job No : 00750AT\00751AT
 Mode : 5775 Band edge
 : 5G WIFI 11AX80 26 RU

	Cable	Ant	Preamp	Read	Limit	Over		
Freq	Loss	Factor	Factor	Level	Level	Line	Limit	Remark
MHz	dB	dB/m	dB	dBuV	dBuV/m	dBuV/m	dB	
1	5724.691	7.92	34.50	35.02	45.74	53.14	121.50	-68.36 peak
2	5775.000	7.96	34.55	35.03	91.85	99.33	-----	----- peak
3	5852.732	8.03	34.71	35.03	46.16	53.87	115.97	-62.10 peak
4 q	5938.429	8.11	34.88	35.04	46.62	54.57	68.20	-13.63 peak



Unless otherwise agreed in writing, this document is issued by the Company subject to its General Conditions of Service printed overleaf, available on request or accessible at <http://www.sgs.com/en/Terms-and-Conditions.aspx> and, for electronic format documents, subject to Terms and Conditions for Electronic Documents at <http://www.sgs.com/en/Terms-and-Conditions/Terms-e-Documents.aspx>. Attention is drawn to the limitation of liability, indemnification and jurisdiction issues defined therein. Any holder of this document is advised that information contained hereon reflects the Company's findings at the time of its intervention only and within the limits of Client's instructions, if any. The Company's sole responsibility is to its Client and this document does not exonerate parties to a transaction from exercising all their rights and obligations under the transaction documents. This document cannot be reproduced except in full, without prior written approval of the Company. Any unauthorized alteration, forgery or falsification of the content or appearance of this document is unlawful and offenders may be prosecuted to the fullest extent of the law. Unless otherwise stated the results shown in this test report refer only to the sample(s) tested and such sample(s) are retained for 30 days only.
 Attention: To check the authenticity of testing /inspection report & certificate, please contact us at telephone: (86-755) 8307 1443, or email: CN.Doccheck@sgs.com

Test Mode: 08; Polarity: Vertical; Modulation:802.11ax; Bandwidth:80MHz; Channel:middle

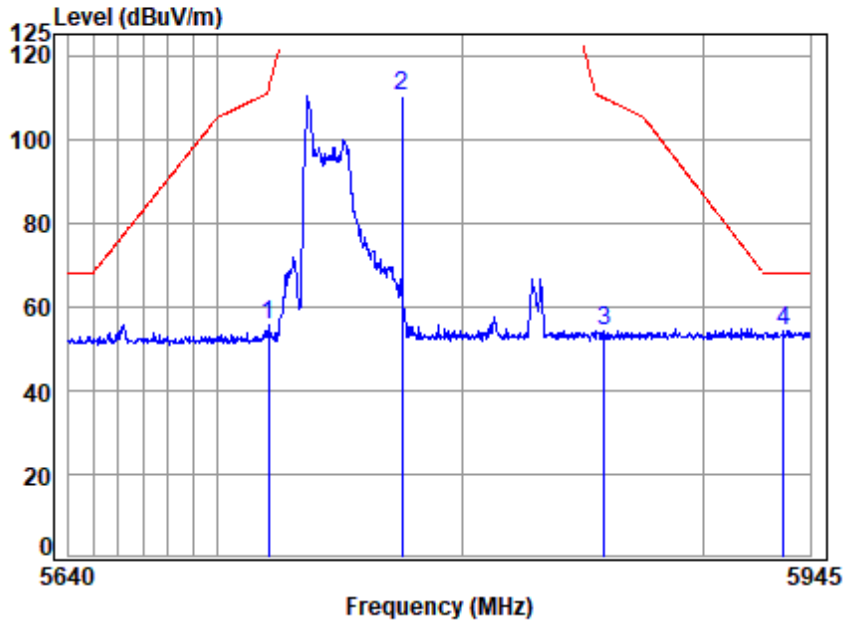

Site : chamber
 Condition: 3m VERTICAL
 Job No : 00750AT\00751AT
 Mode : 5775 Band edge
 : 5G WIFI 11AX80 26 RU

	Cable	Ant	Preamp	Read	Limit	Over		
Freq	Loss	Factor	Factor	Level	Level	Line	Limit	Remark
MHz	dB	dB/m	dB	dBuV	dBuV/m	dBuV/m	dB	
1	5720.472	7.91	34.50	35.02	48.06	55.45	111.88	-56.43 peak
2	5775.000	7.96	34.55	35.03	102.73	110.21	-----	----- peak
3	5858.900	8.04	34.72	35.03	46.45	54.18	109.71	-55.53 peak
4	q 5933.739	8.10	34.87	35.04	46.23	54.16	68.20	-14.04 peak



Unless otherwise agreed in writing, this document is issued by the Company subject to its General Conditions of Service printed overleaf, available on request or accessible at <http://www.sgs.com/en/Terms-and-Conditions.aspx> and, for electronic format documents, subject to Terms and Conditions for Electronic Documents at <http://www.sgs.com/en/Terms-and-Conditions/Terms-e-Documents.aspx>. Attention is drawn to the limitation of liability, indemnification and jurisdiction issues defined therein. Any holder of this document is advised that information contained hereon reflects the Company's findings at the time of its intervention only and within the limits of Client's instructions, if any. The Company's sole responsibility is to its Client and this document does not exonerate parties to a transaction from exercising all their rights and obligations under the transaction documents. This document cannot be reproduced except in full, without prior written approval of the Company. Any unauthorized alteration, forgery or falsification of the content or appearance of this document is unlawful and offenders may be prosecuted to the fullest extent of the law. Unless otherwise stated the results shown in this test report refer only to the sample(s) tested and such sample(s) are retained for 30 days only.

Test Mode: 08; Polarity: Horizontal; Modulation:802.11ax; Bandwidth:80MHz; Channel:middle

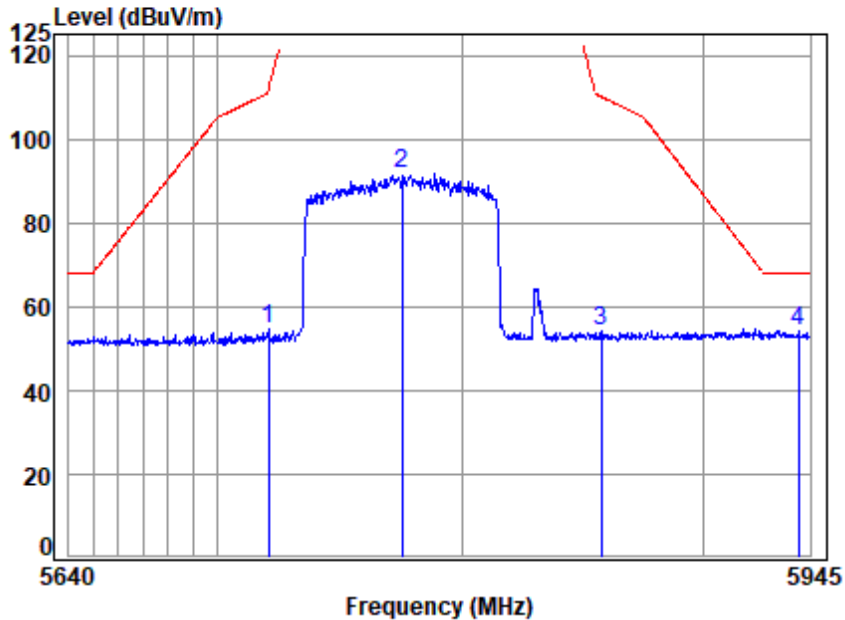

Site : chamber
 Condition: 3m HORIZONTAL
 Job No : 00750AT\00751AT
 Mode : 5775 Band edge
 : 5G WIFI 11AX80 996 RU

		Cable	Ant	Preamp	Read	Limit	Over		
Freq	Loss	Factor	Factor	Factor	Level	Level	Line	Limit	Remark
MHz	dB	dB/m	dB	dB	dBuV	dBuV/m	dBuV/m	dB	
1	5720.472	7.91	34.50	35.02	47.14	54.53	111.88	-57.35	peak
2	5775.000	7.96	34.55	35.03	84.16	91.64	-----	-----	peak
3	5857.666	8.03	34.72	35.03	46.39	54.11	110.05	-55.94	peak
4 q	5939.993	8.11	34.88	35.04	46.24	54.19	68.20	-14.01	peak



Unless otherwise agreed in writing, this document is issued by the Company subject to its General Conditions of Service printed overleaf, available on request or accessible at <http://www.sgs.com/en/Terms-and-Conditions.aspx> and, for electronic format documents, subject to Terms and Conditions for Electronic Documents at <http://www.sgs.com/en/Terms-and-Conditions/Terms-e-Documents.aspx>. Attention is drawn to the limitation of liability, indemnification and jurisdiction issues defined therein. Any holder of this document is advised that information contained hereon reflects the Company's findings at the time of its intervention only and within the limits of Client's instructions, if any. The Company's sole responsibility is to its Client and this document does not exonerate parties to a transaction from exercising all their rights and obligations under the transaction documents. This document cannot be reproduced except in full, without prior written approval of the Company. Any unauthorized alteration, forgery or falsification of the content or appearance of this document is unlawful and offenders may be prosecuted to the fullest extent of the law. Unless otherwise stated the results shown in this test report refer only to the sample(s) tested and such sample(s) are retained for 30 days only.
 Attention: To check the authenticity of testing /inspection report & certificate, please contact us at telephone: (86-755) 8307 1443, or email: CN_Doccheck@sgs.com

Test Mode: 08; Polarity: Vertical; Modulation:802.11ax; Bandwidth:80MHz; Channel:middle

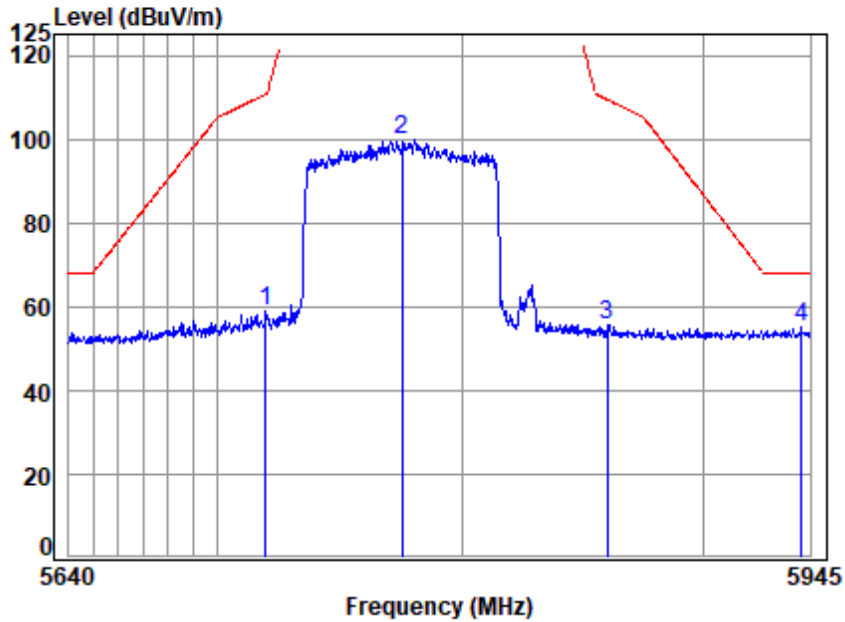

Site : chamber
 Condition: 3m VERTICAL
 Job No : 00750AT\00751AT
 Mode : 5775 Band edge
 : 5G WIFI 11AX80 996 RU

		Cable	Ant	Preamp	Read	Limit	Over		
Freq	Loss	Factor	Factor	Factor	Level	Level	Line	Limit	Remark
MHz	dB	dB/m	dB	dBuV	dBuV/m	dBuV/m	dB		
1	5719.568	7.91	34.50	35.02	51.66	59.05	110.68	-51.63	peak
2	5775.000	7.96	34.55	35.03	92.50	99.98	-----	-----	peak
3	5859.826	8.04	34.72	35.03	47.99	55.72	109.45	-53.73	peak
4 q	5941.244	8.11	34.88	35.04	47.11	55.06	68.20	-13.14	peak



Unless otherwise agreed in writing, this document is issued by the Company subject to its General Conditions of Service printed overleaf, available on request or accessible at <http://www.sgs.com/en/Terms-and-Conditions.aspx> and, for electronic format documents, subject to Terms and Conditions for Electronic Documents at <http://www.sgs.com/en/Terms-and-Conditions/Terms-e-Documents.aspx>. Attention is drawn to the limitation of liability, indemnification and jurisdiction issues defined therein. Any holder of this document is advised that information contained hereon reflects the Company's findings at the time of its intervention only and within the limits of Client's instructions, if any. The Company's sole responsibility is to its Client and this document does not exonerate parties to a transaction from exercising all their rights and obligations under the transaction documents. This document cannot be reproduced except in full, without prior written approval of the Company. Any unauthorized alteration, forgery or falsification of the content or appearance of this document is unlawful and offenders may be prosecuted to the fullest extent of the law. Unless otherwise stated the results shown in this test report refer only to the sample(s) tested and such sample(s) are retained for 30 days only.
 Attention: To check the authenticity of testing /inspection report & certificate, please contact us at telephone: (86-755) 8307 1443, or email: CN.Doccheck@sgs.com

7.10 Frequency Stability

Test Requirement 47 CFR Part 15, Subpart E 15.407 (g)
 Test Method: ANSI C63.10 (2013) Section 6.8

7.10.1 E.U.T. Operation

Operating Environment:
 Temperature: 23.9 °C Humidity: 44.0 % RH Atmospheric Pressure: 1015 mbar

7.10.2 Test Mode Description

Pre-scan / Final test	Mode Code	Description
Final test	05	TX mode (U-NII-1)_Keep the EUT in continuously transmitting mode with all modulation types. All data rates for each modulation type have been tested and found the data rate @ 6Mbps is the worst case of IEEE 802.11a; data rate @ MCS0 is the worst case of IEEE 802.11n(HT20); data rate @ MCS0 is the worst case of IEEE 802.11n(HT40); data rate @ MCS0 is the worst case of IEEE 802.11ac(VHT20); data rate @ MCS0 is the worst case of IEEE 802.11ac(VHT40); data rate @ MCS0 is the worst case of IEEE 802.11ac(VHT80), data rate @ MCS0 is the worst case of IEEE 802.11ax(HEW20); data rate @ MCS0 is the worst case of IEEE 802.11ax(HEW40); data rate @ MCS0 is the worst case of IEEE 802.11ax(HEW80), final test modes are considering the modulation and worse data rates. Only the data of worst case is recorded in the report.
Final test	06	TX mode (U-NII-2A)_Keep the EUT in continuously transmitting mode with all modulation types. All data rates for each modulation type have been tested and found the data rate @ 6Mbps is the worst case of IEEE 802.11a; data rate @ MCS0 is the worst case of IEEE 802.11n(HT20); data rate @ MCS0 is the worst case of IEEE 802.11n(HT40); data rate @ MCS0 is the worst case of IEEE 802.11ac(VHT20); data rate @ MCS0 is the worst case of IEEE 802.11ac(VHT40); data rate @ MCS0 is the worst case of IEEE 802.11ac(VHT80), data rate @ MCS0 is the worst case of IEEE 802.11ax(HEW20); data rate @ MCS0 is the worst case of IEEE 802.11ax(HEW40); data rate @ MCS0 is the worst case of IEEE 802.11ax(HEW80), final test modes are considering the modulation and worse data rates. Only the data of worst case is recorded in the report.
Final test	07	TX mode (U-NII-2C)_Keep the EUT in continuously transmitting mode with all modulation types. All data rates for each modulation type have been tested and found the data rate @ 6Mbps is the worst case of IEEE 802.11a; data rate @ MCS0 is the worst case of IEEE 802.11n(HT20); data rate @ MCS0 is the worst case of IEEE 802.11n(HT40); data rate @ MCS0 is the worst case of IEEE 802.11ac(VHT20); data rate @ MCS0 is the worst case of IEEE 802.11ac(VHT40); data rate @ MCS0 is the worst case of IEEE 802.11ac(VHT80); data rate @ MCS0 is the worst case of IEEE 802.11ax(HEW20); data rate @ MCS0 is the worst case of IEEE 802.11ax(HEW40); data rate @ MCS0 is the worst case of IEEE 802.11ax(HEW80), final test modes are considering the modulation and worse data rates. Only the data of worst case is recorded in the report.
Final test	08	TX mode (U-NII-3)_Keep the EUT in continuously transmitting mode with all modulation types. All data rates for each modulation type have been tested and found the data rate @ 6Mbps is the worst case of IEEE 802.11a; data rate @ MCS0



Unless otherwise agreed in writing, this document is issued by the Company subject to its General Conditions of Service printed overleaf, available on request or accessible at <http://www.sgs.com/en/Terms-and-Conditions.aspx> and, for electronic format documents, subject to Terms and Conditions for Electronic Documents at <http://www.sgs.com/en/Terms-and-Conditions/Terms-e-Documents.aspx>. Attention is drawn to the limitation of liability, indemnification and jurisdiction issues defined therein. Any holder of this document is advised that information contained hereon reflects the Company's findings at the time of its intervention only and within the limits of Client's instructions, if any. The Company's sole responsibility is to its Client and this document does not exonerate parties to a transaction from exercising all their rights and obligations under the transaction documents. This document cannot be reproduced except in full, without prior written approval of the Company. Any unauthorized alteration, forgery or falsification of the content or appearance of this document is unlawful and offenders may be prosecuted to the fullest extent of the law. Unless otherwise stated the results shown in this test report refer only to the sample(s) tested and such sample(s) are retained for 30 days only.
 Attention: To check the authenticity of testing /inspection report & certificate, please contact us at telephone: (86-755) 8307 1443, or email: CN_Doccheck@sgs.com
 No.1 Workshop, M-10, Middle Section, Science & Technology Park, Shenzhen, China 518057 t (86-755) 26012053 f (86-755) 26710594 www.sgsgroup.com.cn
 中国·深圳·科技园中区M-10栋一号厂房 邮编: 518057 t (86-755) 26012053 f (86-755) 26710594 sgs.china@sgs.com

	<p>is the worst case of IEEE 802.11n(HT20); data rate @ MCS0 is the worst case of IEEE 802.11n(HT40); data rate @ MCS0 is the worst case of IEEE 802.11ac(VHT20); data rate @ MCS0 is the worst case of IEEE 802.11ac(VHT40); data rate @ MCS0 is the worst case of IEEE 802.11ac(VHT80); data rate @ MCS0 is the worst case of IEEE 802.11ax(HEW20); data rate @ MCS0 is the worst case of IEEE 802.11ax(HEW40); data rate @ MCS0 is the worst case of IEEE 802.11ax(HEW80), final test modes are considering the modulation and worse data rates. Only the data of worst case is recorded in the report.</p>
--	--

7.10.3 Test Setup Diagram

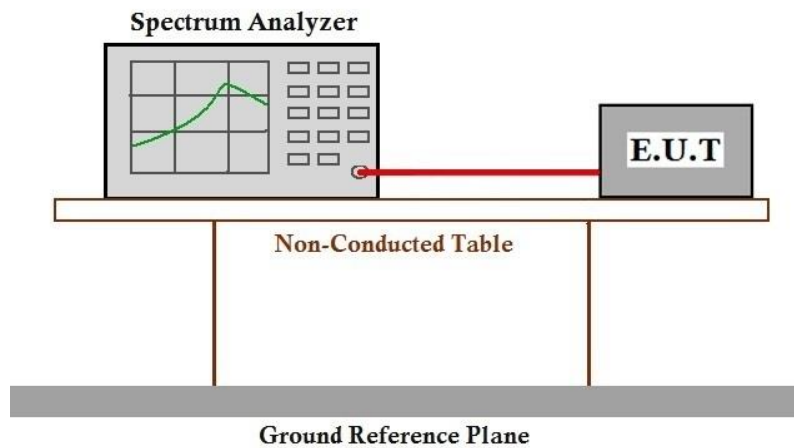

7.10.4 Measurement Procedure and Data

Please Refer to Appendix for Details



7.11 Channel Move Time

Test Requirement KDB 905462 D02 Section 5.1
 Test Method: KDB 905462 D02 Section 7.8.3

Limit:

Test item	Limit	Applicability	
		Master Device or client with Radar Detection	Client without Radar Detection
Non-occupancy period	Minimum 30 minutes	Yes	Not required
Channel Availability Check Time	60 seconds	Yes	Not required
Channel Move Time	10 seconds See Note 1.	Yes	Yes
Channel Closing Transmission Time	200 milliseconds + an aggregate of 60 milliseconds over remaining 10 second period. See Notes 1 and 2.	Yes	Yes
U-NII Detection Bandwidth	Minimum 100% of the U-NII 99% transmission power bandwidth. See Note 3.	Yes	Not required

Note 1: Channel Move Time and the Channel Closing Transmission Time should be performed with Radar Type 0. The measurement timing begins at the end of the Radar Type 0 burst.

Note 2: The Channel Closing Transmission Time is comprised of 200 milliseconds starting at the beginning of the Channel Move Time plus any additional intermittent control signals required to facilitate a Channel move (an aggregate of 60 milliseconds) during the remainder of the 10 second period. The aggregate duration of control signals will not count quiet periods in between transmissions.

Note 3: During the U-NII Detection Bandwidth detection test, radar type 0 should be used. For each frequency step the minimum percentage of detection is 90 percent. Measurements are performed with no data traffic.

7.11.1 E.U.T. Operation

Operating Environment:

Temperature: 23.9 °C Humidity: 44.0 % RH Atmospheric Pressure: 1015 mbar



Unless otherwise agreed in writing, this document is issued by the Company subject to its General Conditions of Service printed overleaf, available on request or accessible at <http://www.sgs.com/en/Terms-and-Conditions.aspx> and, for electronic format documents, subject to Terms and Conditions for Electronic Documents at <http://www.sgs.com/en/Terms-and-Conditions/Terms-e-Documents.aspx>. Attention is drawn to the limitation of liability, indemnification and jurisdiction issues defined therein. Any holder of this document is advised that information contained hereon reflects the Company's findings at the time of its intervention only and within the limits of Client's instructions, if any. The Company's sole responsibility is to its Client and this document does not exonerate parties to a transaction from exercising all their rights and obligations under the transaction documents. This document cannot be reproduced except in full, without prior written approval of the Company. Any unauthorized alteration, forgery or falsification of the content or appearance of this document is unlawful and offenders may be prosecuted to the fullest extent of the law. Unless otherwise stated the results shown in this test report refer only to the sample(s) tested and such sample(s) are retained for 30 days only.
 Attention: To check the authenticity of testing /inspection report & certificate, please contact us at telephone: (86-755) 8307 1443, or email: CN.Doccheck@sgs.com

7.11.2 Test Mode Description

Pre-scan / Final test	Mode Code	Description
Final test	09	Normal operating_Keep the EUT communication with the companion device.

7.11.3 Test Setup Diagram

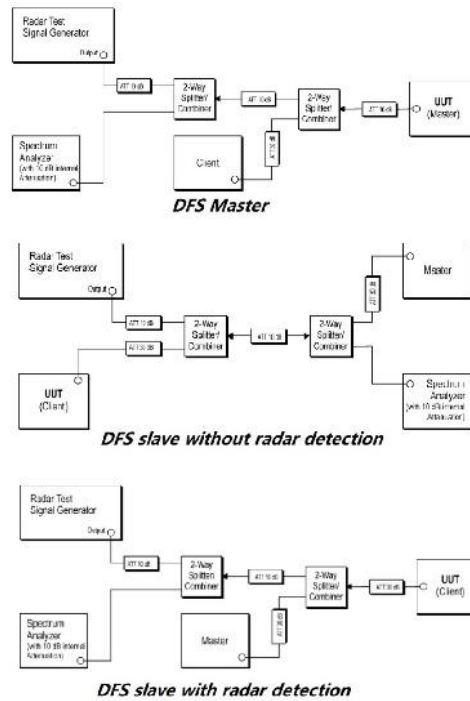

Unless otherwise agreed in writing, this document is issued by the Company subject to its General Conditions of Service printed overleaf, available on request or accessible at <http://www.sgs.com/en/Terms-and-Conditions.aspx> and, for electronic format documents, subject to Terms and Conditions for Electronic Documents at <http://www.sgs.com/en/Terms-and-Conditions/Terms-e-Documents.aspx>. Attention is drawn to the limitation of liability, indemnification and jurisdiction issues defined therein. Any holder of this document is advised that information contained hereon reflects the Company's findings at the time of its intervention only and within the limits of Client's instructions, if any. The Company's sole responsibility is to its Client and this document does not exonerate parties to a transaction from exercising all their rights and obligations under the transaction documents. This document cannot be reproduced except in full, without prior written approval of the Company. Any unauthorized alteration, forgery or falsification of the content or appearance of this document is unlawful and offenders may be prosecuted to the fullest extent of the law. Unless otherwise stated the results shown in this test report refer only to the sample(s) tested and such sample(s) are retained for 30 days only.

Attention: To check the authenticity of testing /inspection report & certificate, please contact us at telephone: (86-755) 8307 1443, or email: CN.Doccheck@sgs.com

7.11.4 Measurement Procedure and Data

- 1) The radar pulse generator is setup to provide a pulse at frequency that the master and client are operating. A type 0 radar pulse with a 1us pulse width and a 1428us PRI is used for the testing.
- 2) The vector signal generator is adjusted to provide the radar burst (18 pulses) at the level of approximately -61dBm at the antenna port of the master device.
- 3) A trigger is provided from the pulse generator to the DFS monitoring system in order to capture the traffic and the occurrence of the radar pulse.
- 4) EUT will associate with the master at channel. The file "iperf.exe" specified by the FCC is streamed from the PC 2 through the master and the client device to the PC 1 and played in full motion video using Media Player Classic Ver. 6.4.8.6 in order to properly load the network for the entire period of the test.
- 5) When radar burst with a level equal to the DFS Detection Threshold +1dB is generated on the operating channel of the U-NII device. At time T0 the radar waveform generator sends a burst of pulse of the radar waveform at Detection Threshold +1dB.
- 6) Observe the transmissions of the EUT at the end of the radar Burst on the Operating Channel. Measure and record the transmissions from the UUT during the observation time (Channel Move Time). One 15 seconds plot is reported for the Short Pulse Radar Type 0. The plot for the Short Pulse Radar Types start at the end of the radar burst. The Channel Move Time will be calculated based on the zoom in 600ms plot of the Short Pulse Radar Type.
- 7) Measurement of the aggregate duration of the Channel Closed Transmission Time method. With the spectrum analyzer set to zero span tuned to the center frequency of the EUT operating channel at the radar simulated frequency, peak detection, and max hold, the dwell time per bin is given by: $Dwell (0.3ms) = S (12000ms) / B (4000)$; where Dwell is the dwell time per spectrum analyzer sampling bin, S is sweep time and B is the number of spectrum analyzer sampling bins. An upper bound of the aggregate duration of the intermittent control signals of Channel Closing Transmission Time is calculated by: $C (ms) = N \times Dwell (0.3ms)$; where C is the Closing Time, N is the number of spectrum analyzer sampling bins (intermittent control signals) showing a U-NII transmission and Dwell is the dwell time per bin.
- 8) Measurement the EUT for more than 30 minutes following the channel move time to verify that no transmission or beacons occur on this channel.

Please Refer to Appendix for Details



7.12 Channel Closing Transmission Time

Test Requirement KDB 905462 D02 Section 5.1
 Test Method: KDB 905462 D02 Section 7.8.3

Limit:

Test item	Limit	Applicability	
		Master Device or client with Radar Detection	Client without Radar Detection
Non-occupancy period	Minimum 30 minutes	Yes	Not required
Channel Availability Check Time	60 seconds	Yes	Not required
Channel Move Time	10 seconds See Note 1.	Yes	Yes
Channel Closing Transmission Time	200 milliseconds + an aggregate of 60 milliseconds over remaining 10 second period. See Notes 1 and 2.	Yes	Yes
U-NII Detection Bandwidth	Minimum 100% of the U-NII 99% transmission power bandwidth. See Note 3.	Yes	Not required

Note 1: Channel Move Time and the Channel Closing Transmission Time should be performed with Radar Type 0. The measurement timing begins at the end of the Radar Type 0 burst.

Note 2: The Channel Closing Transmission Time is comprised of 200 milliseconds starting at the beginning of the Channel Move Time plus any additional intermittent control signals required to facilitate a Channel move (an aggregate of 60 milliseconds) during the remainder of the 10 second period. The aggregate duration of control signals will not count quiet periods in between transmissions.

Note 3: During the U-NII Detection Bandwidth detection test, radar type 0 should be used. For each frequency step the minimum percentage of detection is 90 percent. Measurements are performed with no data traffic.

7.12.1 E.U.T. Operation

Operating Environment:

Temperature: 23.9 °C Humidity: 44.0 % RH Atmospheric Pressure: 1015 mbar



Unless otherwise agreed in writing, this document is issued by the Company subject to its General Conditions of Service printed overleaf, available on request or accessible at <http://www.sgs.com/en/Terms-and-Conditions.aspx> and, for electronic format documents, subject to Terms and Conditions for Electronic Documents at <http://www.sgs.com/en/Terms-and-Conditions/Terms-e-Documents.aspx>. Attention is drawn to the limitation of liability, indemnification and jurisdiction issues defined therein. Any holder of this document is advised that information contained hereon reflects the Company's findings at the time of its intervention only and within the limits of Client's instructions, if any. The Company's sole responsibility is to its Client and this document does not exonerate parties to a transaction from exercising all their rights and obligations under the transaction documents. This document cannot be reproduced except in full, without prior written approval of the Company. Any unauthorized alteration, forgery or falsification of the content or appearance of this document is unlawful and offenders may be prosecuted to the fullest extent of the law. Unless otherwise stated the results shown in this test report refer only to the sample(s) tested and such sample(s) are retained for 30 days only.
 Attention: To check the authenticity of testing /inspection report & certificate, please contact us at telephone: (86-755) 8307 1443, or email: CN.Doccheck@sgs.com

7.12.2 Test Mode Description

Pre-scan / Final test	Mode Code	Description
Final test	09	Normal operating_Keep the EUT communication with the companion device.

7.12.3 Test Setup Diagram

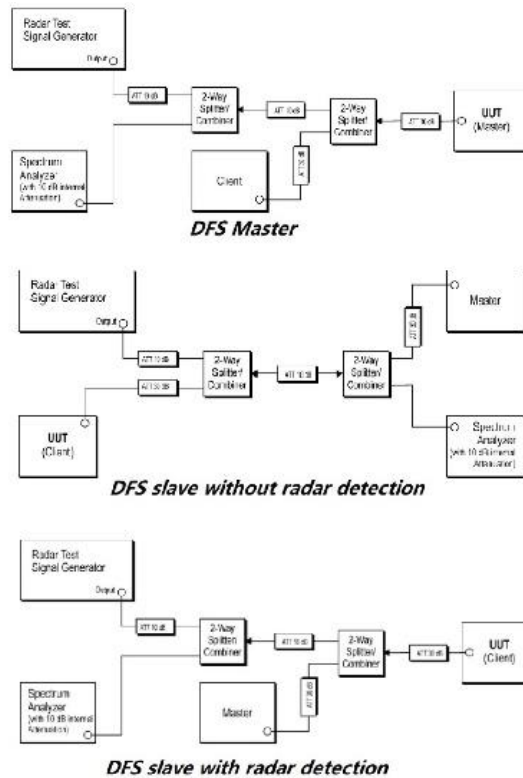

Unless otherwise agreed in writing, this document is issued by the Company subject to its General Conditions of Service printed overleaf, available on request or accessible at <http://www.sgs.com/en/Terms-and-Conditions.aspx> and, for electronic format documents, subject to Terms and Conditions for Electronic Documents at <http://www.sgs.com/en/Terms-and-Conditions/Terms-e-Documents.aspx>. Attention is drawn to the limitation of liability, indemnification and jurisdiction issues defined therein. Any holder of this document is advised that information contained hereon reflects the Company's findings at the time of its intervention only and within the limits of Client's instructions, if any. The Company's sole responsibility is to its Client and this document does not exonerate parties to a transaction from exercising all their rights and obligations under the transaction documents. This document cannot be reproduced except in full, without prior written approval of the Company. Any unauthorized alteration, forgery or falsification of the content or appearance of this document is unlawful and offenders may be prosecuted to the fullest extent of the law. Unless otherwise stated the results shown in this test report refer only to the sample(s) tested and such sample(s) are retained for 30 days only.

Attention: To check the authenticity of testing / inspection report & certificate, please contact us at telephone: (86-755) 8307 1443, or email: CN.Doccheck@sgs.com

7.12.4 Measurement Procedure and Data

- 1) The radar pulse generator is setup to provide a pulse at frequency that the master and client are operating. A type 0 radar pulse with a 1us pulse width and a 1428us PRI is used for the testing.
- 2) The vector signal generator is adjusted to provide the radar burst (18 pulses) at the level of approximately -61dBm at the antenna port of the master device.
- 3) A trigger is provided from the pulse generator to the DFS monitoring system in order to capture the traffic and the occurrence of the radar pulse.
- 4) EUT will associate with the master at channel. The file "iperf.exe" specified by the FCC is streamed from the PC 2 through the master and the client device to the PC 1 and played in full motion video using Media Player Classic Ver. 6.4.8.6 in order to properly load the network for the entire period of the test.
- 5) When radar burst with a level equal to the DFS Detection Threshold +1dB is generated on the operating channel of the U-NII device. At time T0 the radar waveform generator sends a burst of pulse of the radar waveform at Detection Threshold +1dB.
- 6) Observe the transmissions of the EUT at the end of the radar Burst on the Operating Channel. Measure and record the transmissions from the UUT during the observation time (Channel Move Time). One 15 seconds plot is reported for the Short Pulse Radar Type 0. The plot for the Short Pulse Radar Types start at the end of the radar burst. The Channel Move Time will be calculated based on the zoom in 600ms plot of the Short Pulse Radar Type.
- 7) Measurement of the aggregate duration of the Channel Closed Transmission Time method. With the spectrum analyzer set to zero span tuned to the center frequency of the EUT operating channel at the radar simulated frequency, peak detection, and max hold, the dwell time per bin is given by: $Dwell (0.3ms) = S (12000ms) / B (4000)$; where Dwell is the dwell time per spectrum analyzer sampling bin, S is sweep time and B is the number of spectrum analyzer sampling bins. An upper bound of the aggregate duration of the intermittent control signals of Channel Closing Transmission Time is calculated by: $C (ms) = N \times Dwell (0.3ms)$; where C is the Closing Time, N is the number of spectrum analyzer sampling bins (intermittent control signals) showing a U-NII transmission and Dwell is the dwell time per bin.
- 8) Measurement the EUT for more than 30 minutes following the channel move time to verify that no transmission or beacons occur on this channel.

Please Refer to Appendix for Details



Unless otherwise agreed in writing, this document is issued by the Company subject to its General Conditions of Service printed overleaf, available on request or accessible at <http://www.sgs.com/en/Terms-and-Conditions.aspx> and, for electronic format documents, subject to Terms and Conditions for Electronic Documents at <http://www.sgs.com/en/Terms-and-Conditions/Terms-e-Documents.aspx>. Attention is drawn to the limitation of liability, indemnification and jurisdiction issues defined therein. Any holder of this document is advised that information contained hereon reflects the Company's findings at the time of its intervention only and within the limits of Client's instructions, if any. The Company's sole responsibility is to its Client and this document does not exonerate parties to a transaction from exercising all their rights and obligations under the transaction documents. This document cannot be reproduced except in full, without prior written approval of the Company. Any unauthorized alteration, forgery or falsification of the content or appearance of this document is unlawful and offenders may be prosecuted to the fullest extent of the law. Unless otherwise stated the results shown in this test report refer only to the sample(s) tested and such sample(s) are retained for 30 days only.
Attention: To check the authenticity of testing /inspection report & certificate, please contact us at telephone: (86-755) 8307 1443, or email: CN.Doccheck@sgs.com

7.13 Radiated Emissions (Below 1GHz)

Test Requirement 47 CFR Part 15, Subpart C 15.209 & Subpart E 15.407(b)
 Test Method: KDB 789033 D02 II G
 Measurement Distance: 3m

Limit:

Frequency(MHz)	Field strength(microvolts/meter)	Measurement distance(meters)
0.009-0.490	2400/F(kHz)	300
0.490-1.705	24000/F(kHz)	30
1.705-30.0	30	30
30-88	100	3
88-216	150	3
216-960	200	3
960-1000	500	3

7.13.1 E.U.T. Operation

Operating Environment:

Temperature: 22.3 °C Humidity: 57.6 % RH Atmospheric Pressure: 1015 mbar

7.13.2 Test Mode Description

Pre-scan / Final test	Mode Code	Description
Final test	05	TX mode (U-NII-1)_Keep the EUT in continuously transmitting mode with all modulation types. All data rates for each modulation type have been tested and found the data rate @ 6Mbps is the worst case of IEEE 802.11a; data rate @ MCS0 is the worst case of IEEE 802.11n(HT20); data rate @ MCS0 is the worst case of IEEE 802.11n(HT40); data rate @ MCS0 is the worst case of IEEE 802.11ac(VHT20); data rate @ MCS0 is the worst case of IEEE 802.11ac(VHT40); data rate @ MCS0 is the worst case of IEEE 802.11ac(VHT80), data rate @ MCS0 is the worst case of IEEE 802.11ax(HEW20); data rate @ MCS0 is the worst case of IEEE 802.11ax(HEW40); data rate @ MCS0 is the worst case of IEEE 802.11ax(HEW80), final test modes are considering the modulation and worse data rates. Only the data of worst case is recorded in the report.
Pre-scan	06	TX mode (U-NII-2A)_Keep the EUT in continuously transmitting mode with all modulation types. All data rates for each modulation type have been tested and found the data rate @ 6Mbps is the worst case of IEEE 802.11a; data rate @ MCS0 is the worst case of IEEE 802.11n(HT20); data rate @ MCS0 is the worst case of IEEE 802.11n(HT40); data rate @ MCS0 is the worst case of IEEE 802.11ac(VHT20); data rate @ MCS0 is the worst case of IEEE 802.11ac(VHT40); data rate @ MCS0 is the worst case of IEEE 802.11ac(VHT80), data rate @ MCS0 is the worst case of IEEE 802.11ax(HEW20); data rate @ MCS0 is the worst case of



Unless otherwise agreed in writing, this document is issued by the Company subject to its General Conditions of Service printed overleaf, available on request or accessible at <http://www.sgs.com/en/Terms-and-Conditions.aspx> and, for electronic format documents, subject to Terms and Conditions for Electronic Documents at <http://www.sgs.com/en/Terms-and-Conditions/Terms-e-Documents.aspx>. Attention is drawn to the limitation of liability, indemnification and jurisdiction issues defined therein. Any holder of this document is advised that information contained hereon reflects the Company's findings at the time of its intervention only and within the limits of Client's instructions, if any. The Company's sole responsibility is to its Client and this document does not exonerate parties to a transaction from exercising all their rights and obligations under the transaction documents. This document cannot be reproduced except in full, without prior written approval of the Company. Any unauthorized alteration, forgery or falsification of the content or appearance of this document is unlawful and offenders may be prosecuted to the fullest extent of the law. Unless otherwise stated the results shown in this test report refer only to the sample(s) tested and such sample(s) are retained for 30 days only.
 Attention: To check the authenticity of testing /inspection report & certificate, please contact us at telephone: (86-755) 8307 1443, or email: CN_Doccheck@sgs.com

SGS-CSTC Standards Technical Services Co., Ltd. Shenzhen Branch

SZEMC-TRF-01 Rev. A/0 Aug01,2022

Report No.: SZCR230300075005

Page: 548 of 978

		IEEE 802.11ax(HEW40); data rate @ MCS0 is the worst case of IEEE 802.11ax(HEW80), final test modes are considering the modulation and worse data rates. Only the data of worst case is recorded in the report.
Pre-scan	07	TX mode (U-NII-2C)_Keep the EUT in continuously transmitting mode with all modulation types. All data rates for each modulation type have been tested and found the data rate @ 6Mbps is the worst case of IEEE 802.11a; data rate @ MCS0 is the worst case of IEEE 802.11n(HT20); data rate @ MCS0 is the worst case of IEEE 802.11n(HT40); data rate @ MCS0 is the worst case of IEEE 802.11ac(VHT20); data rate @ MCS0 is the worst case of IEEE 802.11ac(VHT40); data rate @ MCS0 is the worst case of IEEE 802.11ac(VHT80); data rate @ MCS0 is the worst case of IEEE 802.11ax(HEW20); data rate @ MCS0 is the worst case of IEEE 802.11ax(HEW40); data rate @ MCS0 is the worst case of IEEE 802.11ax(HEW80), final test modes are considering the modulation and worse data rates. Only the data of worst case is recorded in the report.
Pre-scan	08	TX mode (U-NII-3)_Keep the EUT in continuously transmitting mode with all modulation types. All data rates for each modulation type have been tested and found the data rate @ 6Mbps is the worst case of IEEE 802.11a; data rate @ MCS0 is the worst case of IEEE 802.11n(HT20); data rate @ MCS0 is the worst case of IEEE 802.11n(HT40); data rate @ MCS0 is the worst case of IEEE 802.11ac(VHT20); data rate @ MCS0 is the worst case of IEEE 802.11ac(VHT40); data rate @ MCS0 is the worst case of IEEE 802.11ac(VHT80); data rate @ MCS0 is the worst case of IEEE 802.11ax(HEW20); data rate @ MCS0 is the worst case of IEEE 802.11ax(HEW40); data rate @ MCS0 is the worst case of IEEE 802.11ax(HEW80), final test modes are considering the modulation and worse data rates. Only the data of worst case is recorded in the report.



SGS-CSTC Standards Technical Services Co., Ltd.
Shenzhen Branch

Unless otherwise agreed in writing, this document is issued by the Company subject to its General Conditions of Service printed overleaf, available on request or accessible at <http://www.sgs.com/en/Terms-and-Conditions.aspx> and, for electronic format documents, subject to Terms and Conditions for Electronic Documents at <http://www.sgs.com/en/Terms-and-Conditions/Terms-e-Documents.aspx>. Attention is drawn to the limitation of liability, indemnification and jurisdiction issues defined therein. Any holder of this document is advised that information contained hereon reflects the Company's findings at the time of its intervention only and within the limits of Client's instructions, if any. The Company's sole responsibility is to its Client and this document does not exonerate parties to a transaction from exercising all their rights and obligations under the transaction documents. This document cannot be reproduced except in full, without prior written approval of the Company. Any unauthorized alteration, forgery or falsification of the content or appearance of this document is unlawful and offenders may be prosecuted to the fullest extent of the law. Unless otherwise stated the results shown in this test report refer only to the sample(s) tested and such sample(s) are retained for 30 days only.
Attention: To check the authenticity of testing / inspection report & certificate, please contact us at telephone: (86-755) 8307 1443, or email: CN.Doccheck@sgs.com

No.1 Workshop, M-10, Middle Section, Science & Technology Park, Shenzhen, China 518057 t (86-755) 26012053 f (86-755) 26710594 www.sgs.com.cn
中国·深圳·科技园中区M-10栋一号厂房 邮编: 518057 t (86-755) 26012053 f (86-755) 26710594 sgs.china@sgs.com

7.13.3 Test Setup Diagram

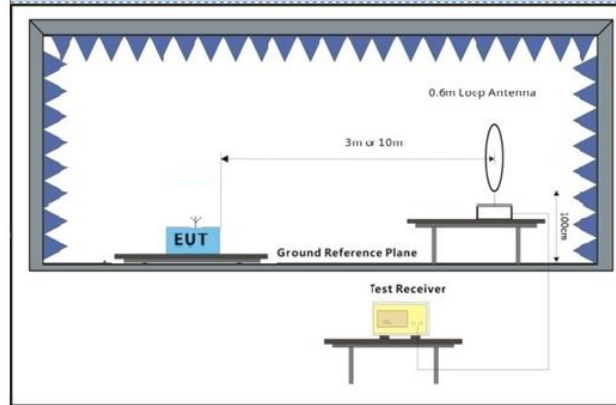

Below 30MHz

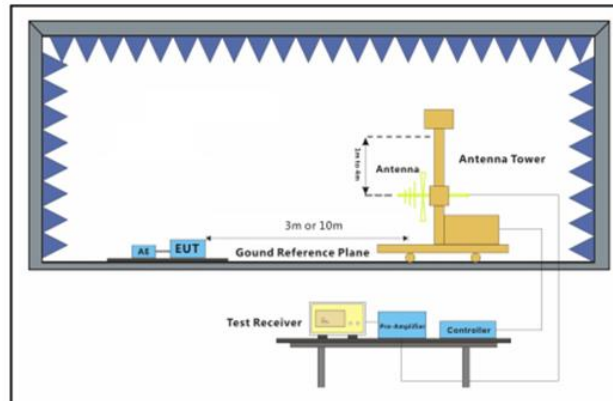

30MHz-1GHz



7.13.4 Measurement Procedure and Data

- a. For below 1GHz, the EUT was placed on the top of a rotating table 0.8 meters above the ground at a 3 meter semi-anechoic chamber. The table was rotated 360 degrees to determine the position of the highest radiation.
- b. The EUT was set 3 or 10 meters away from the interference-receiving antenna, which was mounted on the top of a variable-height antenna tower.
- c. The antenna height is varied from one meter to four meters above the ground to determine the maximum value of the field strength. Both horizontal and vertical polarizations of the antenna are set to make the measurement.
- d. For each suspected emission, the EUT was arranged to its worst case and then the antenna was tuned to heights from 1 meter to 4 meters (for the test frequency of below 30MHz, the antenna was tuned to heights 1 meter) and the rotatable table was turned from 0 degrees to 360 degrees to find the maximum reading.
- e. The test-receiver system was set to Peak Detect Function and Specified Bandwidth with Maximum Hold Mode.
- f. If the emission level of the EUT in peak mode was 10dB lower than the limit specified, then testing could be stopped and the peak values of the EUT would be reported. Otherwise the emissions that did not have 10dB margin would be re-tested one by one using quasi-peak method as specified and then reported in a data sheet.
- g. Test the EUT in the lowest channel, the middle channel, the Highest channel.
- h. The radiation measurements are performed in X, Y, Z axis positioning for Transmitting mode, and found the X axis positioning which it is the worst case.
- i. Repeat above procedures until all frequencies measured was complete.

Remark:

1. Level= Read Level+ Cable Loss+ Antenna Factor- Preamp Factor
2. For emission below 1GHz, through the pre-scan found the worst case is the lowest channel of 802.11a. Only the worst case is recorded in the report.
3. Scan from 9kHz to 30MHz, the disturbance below 30MHz was very low. The points marked on above plots are the highest emissions could be found when testing, so only above points had been displayed. The amplitude of spurious emissions from the radiator which are attenuated more than 20dB below the limit need not be reported.
4. The disturbance below 1GHz was very low and the harmonics were the highest point could be found when testing, so only the above harmonics had been displayed.



Test Mode: 05; Polarity: Horizontal Modulation: 802.11a; Channel: Low

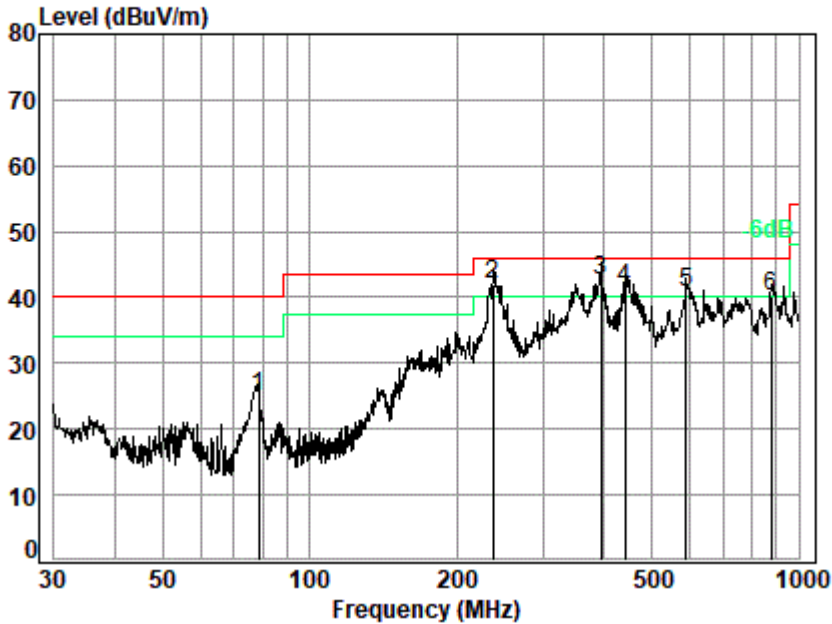

Site : chamber
 Condition: 3m HORIZONTAL
 Job No. : 00750AT/00751AT
 Test Mode: 05

	Ant	Cable	Preamp	Read	Limit	Over		
Freq	Factor	Loss	Factor	Level	Level	Line	Limit	Remark
MHz	dB/m	dB	dB	dBuV	dBuV/m	dBuV/m	dB	
1	78.69	10.57	1.00	27.07	40.49	24.99	40.00	-15.01 QP
2	237.48	17.72	1.85	26.45	49.00	42.12	46.00	-3.88 QP
3 q	393.47	21.57	2.46	26.48	44.92	42.47	46.00	-3.53 QP
4	441.74	21.29	2.62	26.63	44.14	41.42	46.00	-4.58 QP
5	588.91	24.65	3.09	27.07	40.11	40.78	46.00	-5.22 QP
6	878.32	28.37	3.95	25.99	33.70	40.03	46.00	-5.97 QP



Unless otherwise agreed in writing, this document is issued by the Company subject to its General Conditions of Service printed overleaf, available on request or accessible at <http://www.sgs.com/en/Terms-and-Conditions.aspx> and, for electronic format documents, subject to Terms and Conditions for Electronic Documents at <http://www.sgs.com/en/Terms-and-Conditions/Terms-e-Documents.aspx>. Attention is drawn to the limitation of liability, indemnification and jurisdiction issues defined therein. Any holder of this document is advised that information contained hereon reflects the Company's findings at the time of its intervention only and within the limits of Client's instructions, if any. The Company's sole responsibility is to its Client and this document does not exonerate parties to a transaction from exercising all their rights and obligations under the transaction documents. This document cannot be reproduced except in full, without prior written approval of the Company. Any unauthorized alteration, forgery or falsification of the content or appearance of this document is unlawful and offenders may be prosecuted to the fullest extent of the law. Unless otherwise stated the results shown in this test report refer only to the sample(s) tested and such sample(s) are retained for 30 days only.
 Attention: To check the authenticity of testing / inspection report & certificate, please contact us at telephone: (86-755) 8307 1443, or email: CN.Doccheck@sgs.com

Test Mode: 05; Polarity: Vertical Modulation: 802.11a; Channel: Low

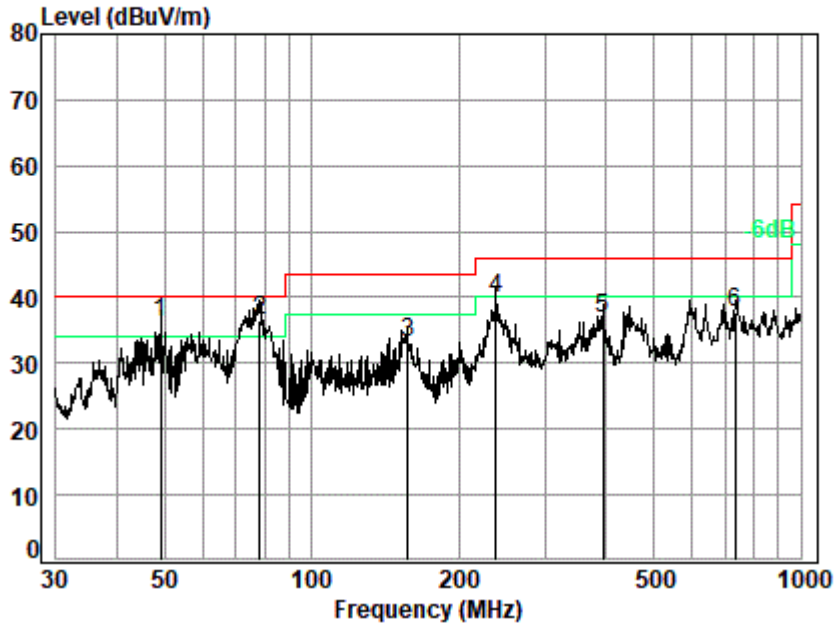

Site : chamber
 Condition: 3m VERTICAL
 Job No. : 00750AT/00751AT
 Test Mode: 05

	Ant	Cable	Preamp	Read	Limit	Over	
Freq	Factor	Loss	Factor	Level	Level	Line	Limit Remark
MHz	dB/m	dB	dB	dBuV	dBuV/m	dBuV/m	dB
1	49.19	12.69	0.78	27.17	49.82	36.12	40.00 -3.88 QP
2 q	78.41	10.55	1.00	27.07	51.93	36.41	40.00 -3.59 QP
3	157.01	13.70	1.45	26.77	44.77	33.15	43.50 -10.35 QP
4	238.31	17.76	1.85	26.45	46.57	39.73	46.00 -6.27 QP
5	393.47	21.57	2.46	26.48	39.25	36.80	46.00 -9.20 QP
6	734.49	26.75	3.51	26.56	33.88	37.58	46.00 -8.42 QP



Unless otherwise agreed in writing, this document is issued by the Company subject to its General Conditions of Service printed overleaf, available on request or accessible at <http://www.sgs.com/en/Terms-and-Conditions.aspx> and, for electronic format documents, subject to Terms and Conditions for Electronic Documents at <http://www.sgs.com/en/Terms-and-Conditions/Terms-e-Documents.aspx>. Attention is drawn to the limitation of liability, indemnification and jurisdiction issues defined therein. Any holder of this document is advised that information contained hereon reflects the Company's findings at the time of its intervention only and within the limits of Client's instructions, if any. The Company's sole responsibility is to its Client and this document does not exonerate parties to a transaction from exercising all their rights and obligations under the transaction documents. This document cannot be reproduced except in full, without prior written approval of the Company. Any unauthorized alteration, forgery or falsification of the content or appearance of this document is unlawful and offenders may be prosecuted to the fullest extent of the law. Unless otherwise stated the results shown in this test report refer only to the sample(s) tested and such sample(s) are retained for 30 days only.

8 Test Setup Photo

Refer to Appendix - Test Setup Photo for SZCR2303000750AT

9 EUT Constructional Details (EUT Photos)

Refer to External and Internal Photos for SZCR2303000750AT



10 Appendix

1. Duty Cycle

1.1 Ant1

1.1.1 Test Result

Ant1									
Mode	Tx Type	Frequency (MHz)	RU	RU Pos	T_on (ms)	Period (ms)	Duty Cycle (%)	Duty Cycle Correction Factor (dB)	Max. DC Variation (%)
802.11a	MIMO	5180	/	/	1.393	1.435	97.07	0.13	0.03
		5200	/	/	1.394	1.436	97.08	0.13	0.03
		5240	/	/	1.395	1.437	97.08	0.13	0.03
		5260	/	/	1.394	1.436	97.08	0.13	0.03
		5300	/	/	1.394	1.436	97.08	0.13	0.03
		5320	/	/	1.394	1.436	97.08	0.13	0.03
		5500	/	/	1.394	1.436	97.08	0.13	0.03
		5580	/	/	1.394	1.436	97.08	0.13	0.03
		5700	/	/	1.394	1.436	97.08	0.13	0.03
		5745	/	/	1.394	1.436	97.08	0.13	0.00
		5785	/	/	1.394	1.436	97.08	0.13	0.03
5825	/	/	1.394	1.436	97.08	0.13	0.03		
802.11n (HT20)	MIMO	5180	/	/	1.302	1.335	97.53	0.11	0.03
		5200	/	/	1.302	1.335	97.53	0.11	0.00
		5240	/	/	1.303	1.336	97.53	0.11	0.03
		5260	/	/	1.302	1.334	97.60	0.11	0.03
		5300	/	/	1.302	1.335	97.53	0.11	0.00
		5320	/	/	1.302	1.334	97.60	0.11	0.00
		5500	/	/	1.302	1.335	97.53	0.11	0.03
		5580	/	/	1.302	1.335	97.53	0.11	0.00
		5700	/	/	1.302	1.335	97.53	0.11	0.00
		5745	/	/	1.301	1.929	67.44	1.71	16.41
		5785	/	/	1.301	1.929	67.44	1.71	0.37
5825	/	/	1.302	1.335	97.53	0.11	0.03		
802.11n (HT40)	MIMO	5190	/	/	0.648	1.286	50.39	2.98	0.38
		5230	/	/	0.650	1.286	50.54	2.96	0.39
		5270	/	/	0.649	1.286	50.47	2.97	0.36



Unless otherwise agreed in writing, this document is issued by the Company subject to its General Conditions of Service printed overleaf, available on request or accessible at <http://www.sgs.com/en/Terms-and-Conditions.aspx> and, for electronic format documents, subject to Terms and Conditions for Electronic Documents at <http://www.sgs.com/en/Terms-and-Conditions/Terms-e-Documents.aspx>. Attention is drawn to the limitation of liability, indemnification and jurisdiction issues defined therein. Any holder of this document is advised that information contained hereon reflects the Company's findings at the time of its intervention only and within the limits of Client's instructions, if any. The Company's sole responsibility is to its Client and this document does not exonerate parties to a transaction from exercising all their rights and obligations under the transaction documents. This document cannot be reproduced except in full, without prior written approval of the Company. Any unauthorized alteration, forgery or falsification of the content or appearance of this document is unlawful and offenders may be prosecuted to the fullest extent of the law. Unless otherwise stated the results shown in this test report refer only to the sample(s) tested and such sample(s) are retained for 30 days only.

Attention: To check the authenticity of testing /inspection report & certificate, please contact us at telephone: (86-755) 8307 1443, or email: CN_Doccheck@sgs.com

		5310	/	/	0.650	1.286	50.54	2.96	0.39
		5510	/	/	0.650	1.286	50.54	2.96	5.50
		5550	/	/	0.648	0.683	94.88	0.23	0.03
		5670	/	/	0.648	0.683	94.88	0.23	0.07
		5755	/	/	0.649	0.683	95.02	0.22	0.03
		5795	/	/	0.649	0.683	95.02	0.22	0.04
802.11ac (VHT20)	MIMO	5180	/	/	0.682	0.716	95.25	0.21	0.09
		5200	/	/	0.681	0.716	95.11	0.22	0.12
		5240	/	/	0.680	0.716	94.97	0.22	0.09
		5260	/	/	0.682	0.716	95.25	0.21	0.13
		5300	/	/	0.682	0.715	95.38	0.21	0.09
		5320	/	/	0.683	0.716	95.39	0.20	0.13
		5500	/	/	0.681	0.716	95.11	0.22	0.13
		5580	/	/	0.682	0.715	95.38	0.21	0.12
		5700	/	/	0.680	0.716	94.97	0.22	0.13
		5745	/	/	0.680	0.715	95.10	0.22	0.09
		5785	/	/	0.681	0.716	95.11	0.22	0.12
		5825	/	/	0.682	0.716	95.25	0.21	0.13
802.11ac (VHT40)	MIMO	5190	/	/	0.354	0.585	60.51	2.18	31.03
		5230	/	/	0.355	0.585	60.68	2.17	31.16
		5270	/	/	0.354	0.594	59.60	2.25	31.95
		5310	/	/	0.354	0.585	60.51	2.18	31.00
		5510	/	/	0.355	0.594	59.76	2.24	32.07
		5550	/	/	0.355	0.595	59.66	2.24	32.04
		5670	/	/	0.352	0.585	60.17	2.21	30.90
		5755	/	/	0.683	0.716	95.39	0.20	0.09
5795	/	/	0.355	0.585	60.68	2.17	31.19		
802.11ac (VHT80)	MIMO	5210	/	/	0.190	0.664	28.61	5.43	56.53
		5290	/	/	0.189	0.664	28.46	5.46	56.49
		5530	/	/	0.191	0.637	29.98	5.23	55.69
		5610	/	/	0.189	0.826	22.88	6.41	0.26
		5775	/	/	0.191	0.637	29.98	5.23	55.70
802.11ax (HEW20)	MIMO	5180	RU242	Left	0.525	1.288	40.76	3.90	0.29
		5200	RU242	Left	0.524	0.829	63.21	1.99	0.73
		5240	RU242	Left	0.526	1.289	40.81	3.89	0.32
		5260	RU242	Left	0.524	1.288	40.68	3.91	0.32
		5300	RU242	Left	0.525	0.829	63.33	1.98	0.73
		5320	RU242	Left	0.525	1.342	39.12	4.08	1.93
		5500	RU242	Left	0.524	1.342	39.05	4.08	1.93
5580	RU242	Left	0.525	1.288	40.76	3.90	0.38		



Unless otherwise agreed in writing, this document is issued by the Company subject to its General Conditions of Service printed overleaf, available on request or accessible at <http://www.sgs.com/en/Terms-and-Conditions.aspx> and, for electronic format documents, subject to Terms and Conditions for Electronic Documents at <http://www.sgs.com/en/Terms-and-Conditions/Terms-e-Documents.aspx>. Attention is drawn to the limitation of liability, indemnification and jurisdiction issues defined therein. Any holder of this document is advised that information contained hereon reflects the Company's findings at the time of its intervention only and within the limits of Client's instructions, if any. The Company's sole responsibility is to its Client and this document does not exonerate parties to a transaction from exercising all their rights and obligations under the transaction documents. This document cannot be reproduced except in full, without prior written approval of the Company. Any unauthorized alteration, forgery or falsification of the content or appearance of this document is unlawful and offenders may be prosecuted to the fullest extent of the law. Unless otherwise stated the results shown in this test report refer only to the sample(s) tested and such sample(s) are retained for 30 days only.

Attention: To check the authenticity of testing / inspection report & certificate, please contact us at telephone: (86-755) 8307 1443, or email: CN_Doccheck@sgs.com

SGS-CSTC Standards Technical Services Co., Ltd. Shenzhen Branch

SZEMC-TRF-01 Rev. A/0 Aug01,2022

Report No.: SZCR230300075005

Page: 556 of 978

		5700	RU242	Left	0.525	1.288	40.76	3.90	0.32
		5745	RU242	Left	0.526	1.288	40.84	3.89	0.29
		5785	RU242	Left	0.525	1.316	39.89	3.99	1.10
		5825	RU242	Left	0.524	1.288	40.68	3.91	0.29
802.11ax (HEW40)	MIMO	5190	RU484	Left	0.526	1.441	36.50	4.38	0.24
		5230	RU484	Left	0.525	1.495	35.12	4.54	1.60
		5270	RU484	Left	0.526	1.441	36.50	4.38	0.23
		5310	RU484	Left	0.526	1.496	35.16	4.54	1.56
		5510	RU484	Left	0.525	1.504	34.91	4.57	1.75
		5550	RU484	Left	0.525	1.441	36.43	4.39	0.21
		5670	RU484	Left	0.526	1.441	36.50	4.38	0.26
		5755	RU484	Left	0.526	1.441	36.50	4.38	0.24
802.11ax (HEW80)	MIMO	5795	RU484	Left	0.526	1.441	36.50	4.38	17.08
		5210	RU996	Left	0.290	1.196	24.25	6.15	0.21
		5290	RU996	Left	0.290	1.196	24.25	6.15	0.21
		5530	RU996	Left	0.290	1.206	24.05	6.19	0.40
		5610	RU996	Left	0.290	1.196	24.25	6.15	7.38
		5775	RU996	Left	0.290	1.196	24.25	6.15	0.21



SGS-CSTC Standards Technical Services Co., Ltd.
Shenzhen Branch

Unless otherwise agreed in writing, this document is issued by the Company subject to its General Conditions of Service printed overleaf, available on request or accessible at <http://www.sgs.com/en/Terms-and-Conditions.aspx> and, for electronic format documents, subject to Terms and Conditions for Electronic Documents at <http://www.sgs.com/en/Terms-and-Conditions/Terms-e-Documents.aspx>. Attention is drawn to the limitation of liability, indemnification and jurisdiction issues defined therein. Any holder of this document is advised that information contained hereon reflects the Company's findings at the time of its intervention only and within the limits of Client's instructions, if any. The Company's sole responsibility is to its Client and this document does not exonerate parties to a transaction from exercising all their rights and obligations under the transaction documents. This document cannot be reproduced except in full, without prior written approval of the Company. Any unauthorized alteration, forgery or falsification of the content or appearance of this document is unlawful and offenders may be prosecuted to the fullest extent of the law. Unless otherwise stated the results shown in this test report refer only to the sample(s) tested and such sample(s) are retained for 30 days only.
Attention: To check the authenticity of testing / inspection report & certificate, please contact us at telephone: (86-755) 8307 1443, or email: CN.Doccheck@sgs.com

No.1 Workshop, M-10, Middle Section, Science & Technology Park, Shenzhen, China 518057 t (86-755) 26012053 f (86-755) 26710594 www.sgs.com.cn
中国·深圳·科技园中区M-10栋一号厂房 邮编: 518057 t (86-755) 26012053 f (86-755) 26710594 sgs.china@sgs.com

1.1.2 Test Graph

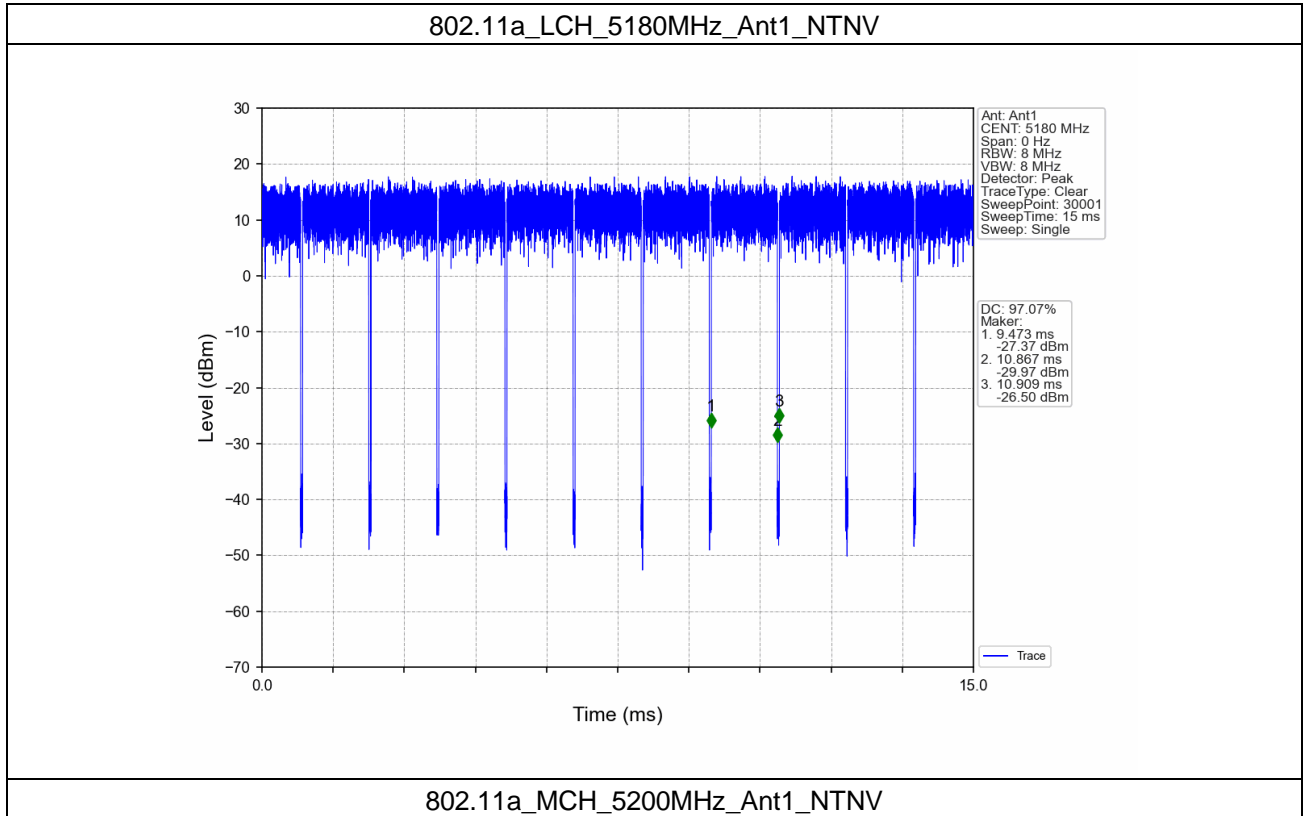

Unless otherwise agreed in writing, this document is issued by the Company subject to its General Conditions of Service printed overleaf, available on request or accessible at <http://www.sgs.com/en/Terms-and-Conditions.aspx> and, for electronic format documents, subject to Terms and Conditions for Electronic Documents at <http://www.sgs.com/en/Terms-and-Conditions/Terms-e-Documents.aspx>. Attention is drawn to the limitation of liability, indemnification and jurisdiction issues defined therein. Any holder of this document is advised that information contained hereon reflects the Company's findings at the time of its intervention only and within the limits of Client's instructions, if any. The Company's sole responsibility is to its Client and this document does not exonerate parties to a transaction from exercising all their rights and obligations under the transaction documents. This document cannot be reproduced except in full, without prior written approval of the Company. Any unauthorized alteration, forgery or falsification of the content or appearance of this document is unlawful and offenders may be prosecuted to the fullest extent of the law. Unless otherwise stated the results shown in this test report refer only to the sample(s) tested and such sample(s) are retained for 30 days only.

Attention: To check the authenticity of testing / inspection report & certificate, please contact us at telephone: (86-755) 8307 1443, or email: CN.Doccheck@sgs.com

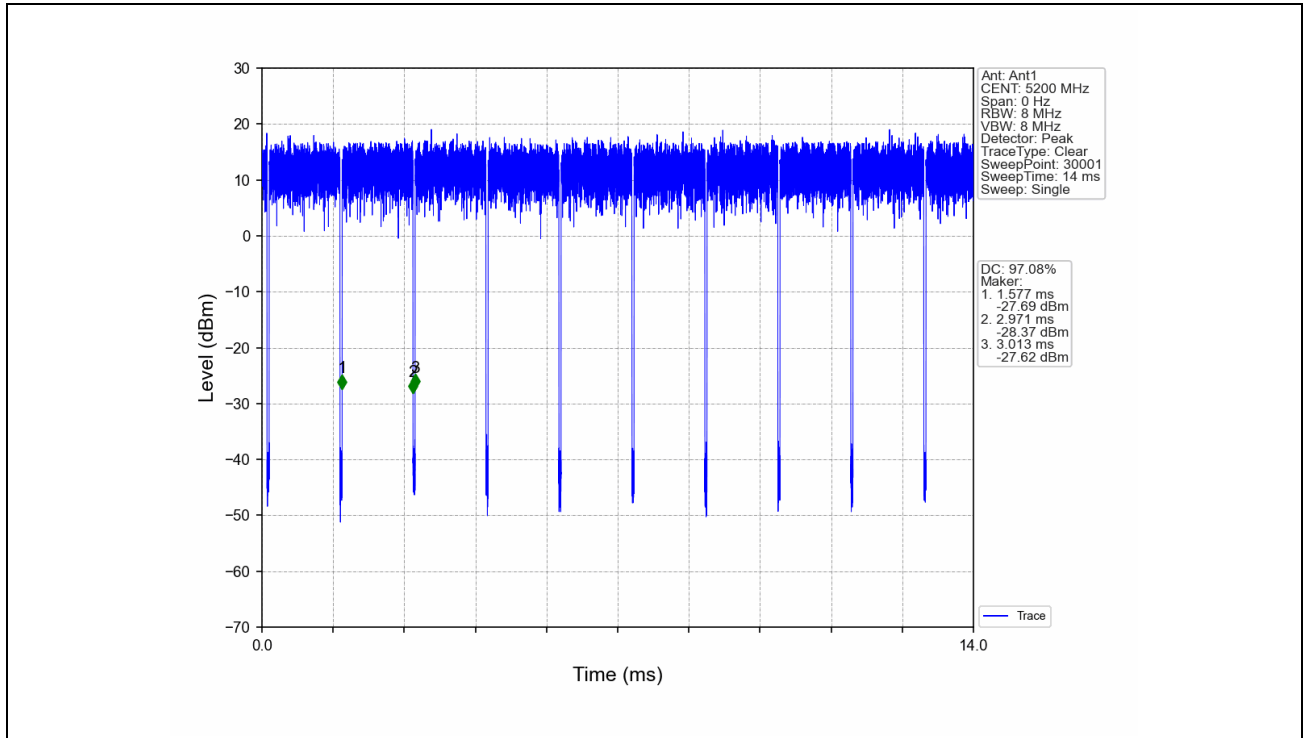

Unless otherwise agreed in writing, this document is issued by the Company subject to its General Conditions of Service printed overleaf, available on request or accessible at <http://www.sgs.com/en/Terms-and-Conditions.aspx> and, for electronic format documents, subject to Terms and Conditions for Electronic Documents at <http://www.sgs.com/en/Terms-and-Conditions/Terms-e-Documents.aspx>. Attention is drawn to the limitation of liability, indemnification and jurisdiction issues defined therein. Any holder of this document is advised that information contained hereon reflects the Company's findings at the time of its intervention only and within the limits of Client's instructions, if any. The Company's sole responsibility is to its Client and this document does not exonerate parties to a transaction from exercising all their rights and obligations under the transaction documents. This document cannot be reproduced except in full, without prior written approval of the Company. Any unauthorized alteration, forgery or falsification of the content or appearance of this document is unlawful and offenders may be prosecuted to the fullest extent of the law. Unless otherwise stated the results shown in this test report refer only to the sample(s) tested and such sample(s) are retained for 30 days only.

Attention: To check the authenticity of testing / inspection report & certificate, please contact us at telephone: (86-755) 8307 1443, or email: CN.Doccheck@sgs.com

802.11a_HCH_5240MHz_Ant1_NTNV

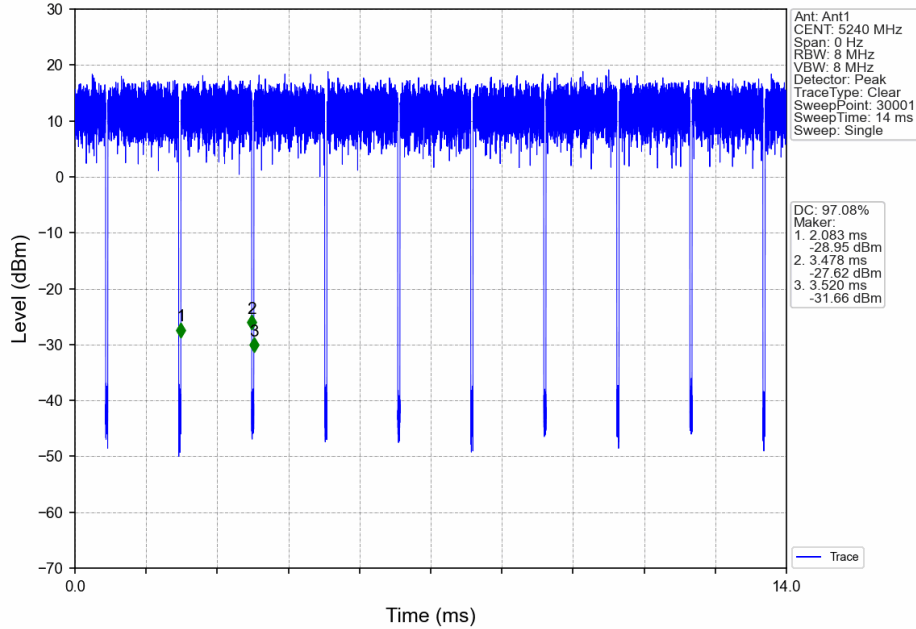

802.11a_LCH_5260MHz_Ant1_NTNV

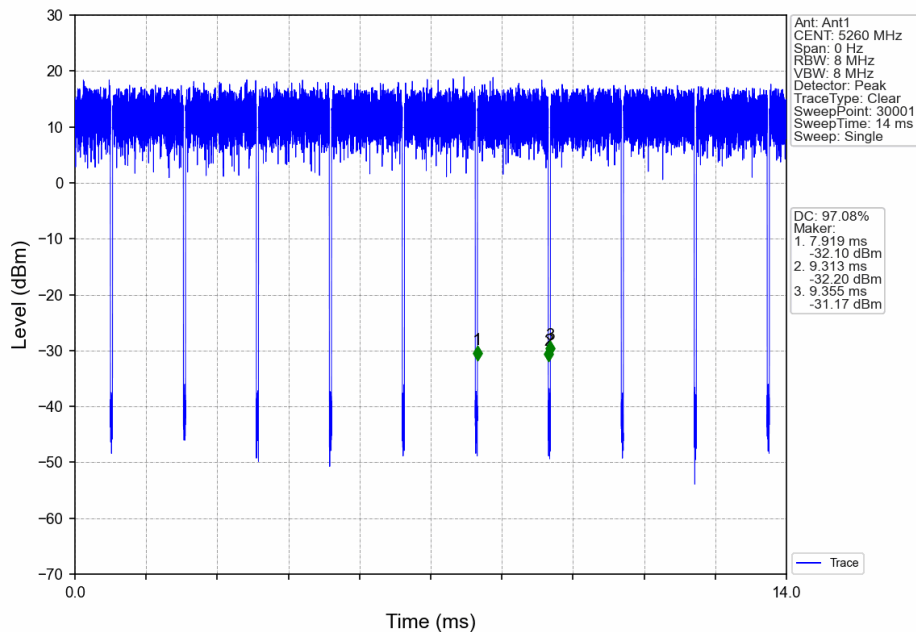

Unless otherwise agreed in writing, this document is issued by the Company subject to its General Conditions of Service printed overleaf, available on request or accessible at <http://www.sgs.com/en/Terms-and-Conditions.aspx> and, for electronic format documents, subject to Terms and Conditions for Electronic Documents at <http://www.sgs.com/en/Terms-and-Conditions/Terms-e-Documents.aspx>. Attention is drawn to the limitation of liability, indemnification and jurisdiction issues defined therein. Any holder of this document is advised that information contained hereon reflects the Company's findings at the time of its intervention only and within the limits of Client's instructions, if any. The Company's sole responsibility is to its Client and this document does not exonerate parties to a transaction from exercising all their rights and obligations under the transaction documents. This document cannot be reproduced except in full, without prior written approval of the Company. Any unauthorized alteration, forgery or falsification of the content or appearance of this document is unlawful and offenders may be prosecuted to the fullest extent of the law. Unless otherwise stated the results shown in this test report refer only to the sample(s) tested and such sample(s) are retained for 30 days only.

Attention: To check the authenticity of testing /inspection report & certificate, please contact us at telephone: (86-755) 8307 1443, or email: CN.Doccheck@sgs.com

802.11a_MCH_5300MHz_Ant1_NTNV

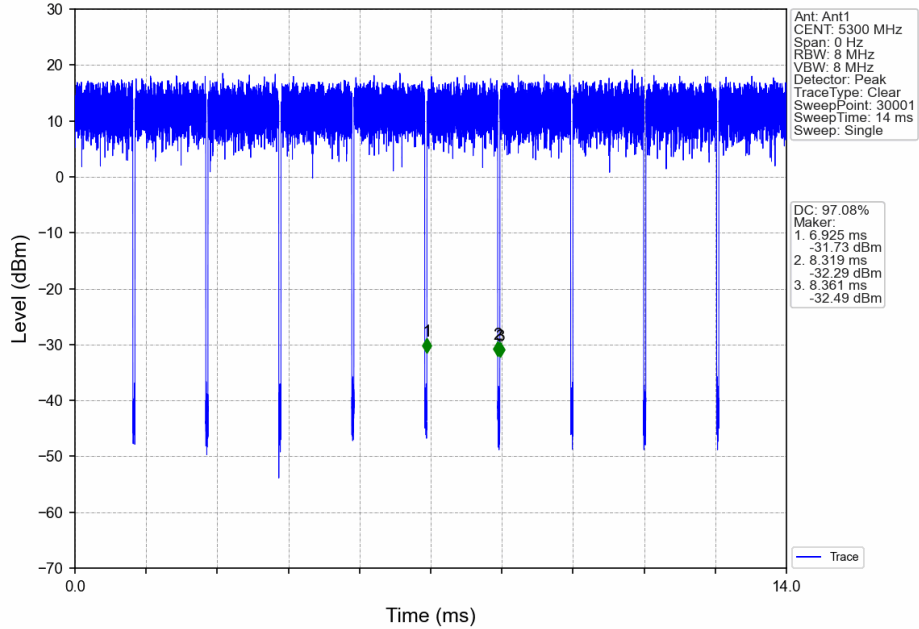

802.11a_HCH_5320MHz_Ant1_NTNV

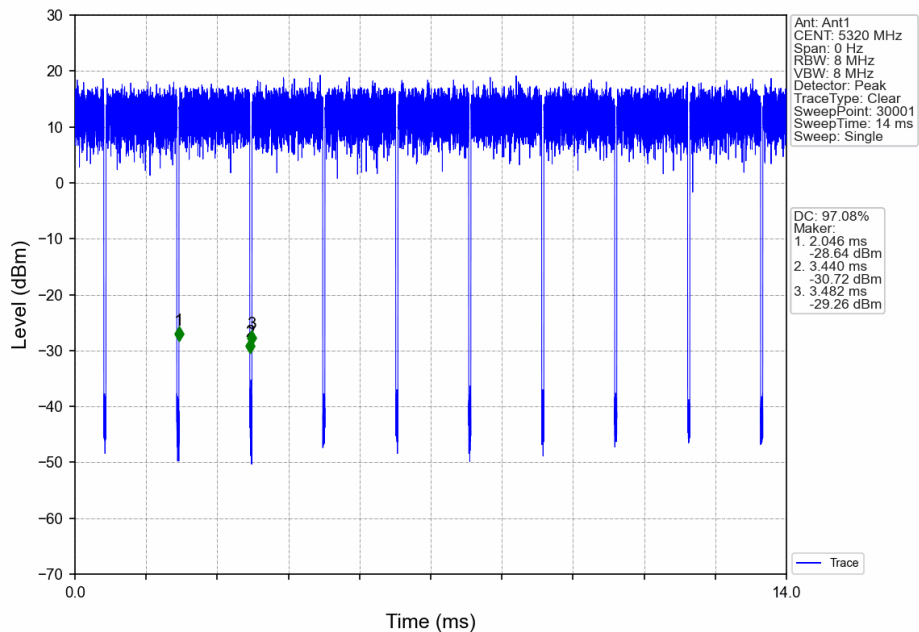

Unless otherwise agreed in writing, this document is issued by the Company subject to its General Conditions of Service printed overleaf, available on request or accessible at <http://www.sgs.com/en/Terms-and-Conditions.aspx> and, for electronic format documents, subject to Terms and Conditions for Electronic Documents at <http://www.sgs.com/en/Terms-and-Conditions/Terms-e-Documents.aspx>. Attention is drawn to the limitation of liability, indemnification and jurisdiction issues defined therein. Any holder of this document is advised that information contained hereon reflects the Company's findings at the time of its intervention only and within the limits of Client's instructions, if any. The Company's sole responsibility is to its Client and this document does not exonerate parties to a transaction from exercising all their rights and obligations under the transaction documents. This document cannot be reproduced except in full, without prior written approval of the Company. Any unauthorized alteration, forgery or falsification of the content or appearance of this document is unlawful and offenders may be prosecuted to the fullest extent of the law. Unless otherwise stated the results shown in this test report refer only to the sample(s) tested and such sample(s) are retained for 30 days only.

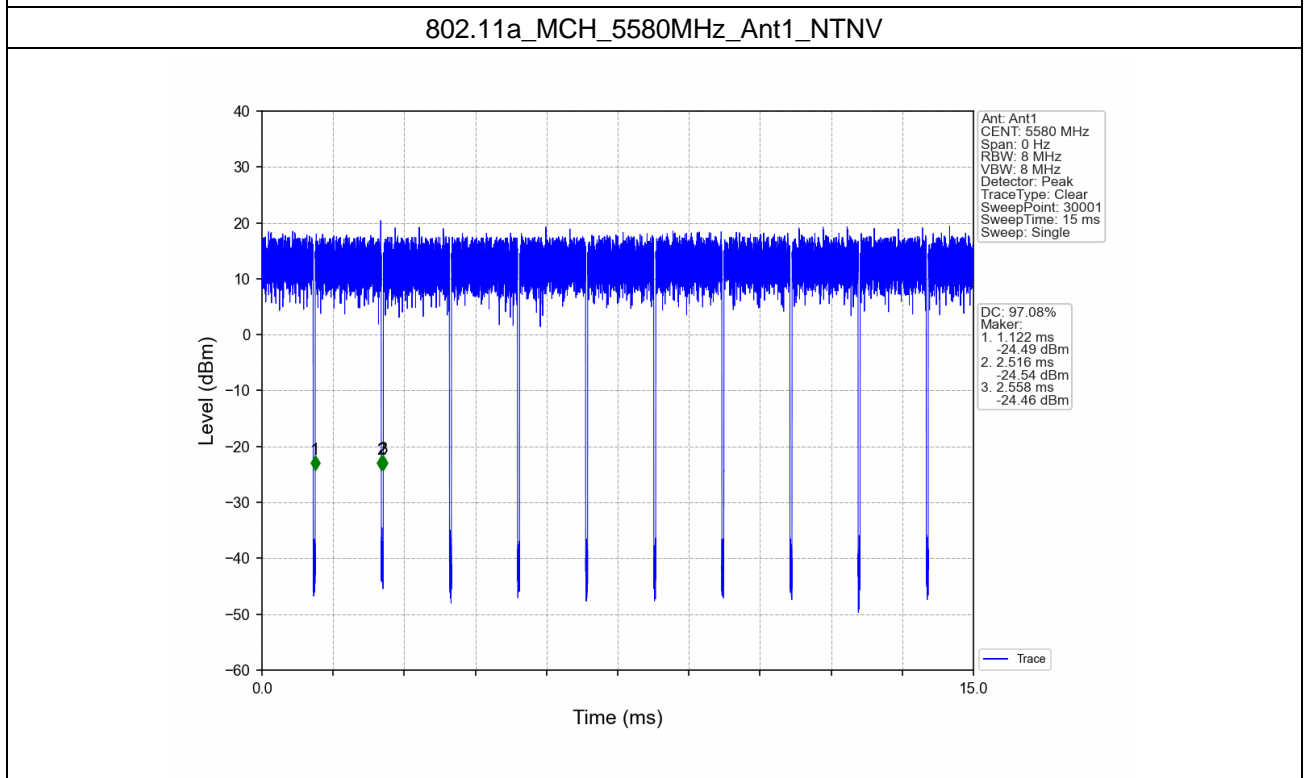
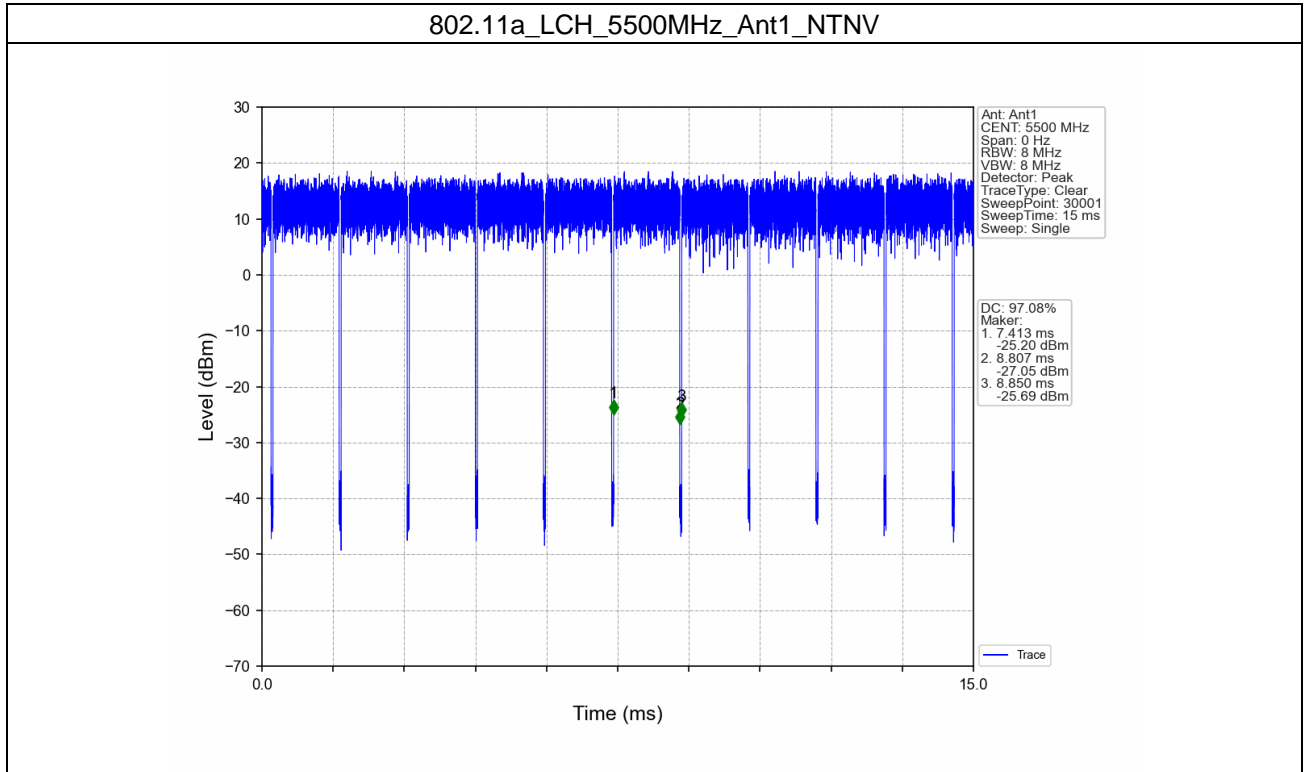

Unless otherwise agreed in writing, this document is issued by the Company subject to its General Conditions of Service printed overleaf, available on request or accessible at <http://www.sgs.com/en/Terms-and-Conditions.aspx> and, for electronic format documents, subject to Terms and Conditions for Electronic Documents at <http://www.sgs.com/en/Terms-and-Conditions/Terms-e-Documents.aspx>. Attention is drawn to the limitation of liability, indemnification and jurisdiction issues defined therein. Any holder of this document is advised that information contained hereon reflects the Company's findings at the time of its intervention only and within the limits of Client's instructions, if any. The Company's sole responsibility is to its Client and this document does not exonerate parties to a transaction from exercising all their rights and obligations under the transaction documents. This document cannot be reproduced except in full, without prior written approval of the Company. Any unauthorized alteration, forgery or falsification of the content or appearance of this document is unlawful and offenders may be prosecuted to the fullest extent of the law. Unless otherwise stated the results shown in this test report refer only to the sample(s) tested and such sample(s) are retained for 30 days only.

802.11a_HCH_5700MHz_Ant1_NTNV

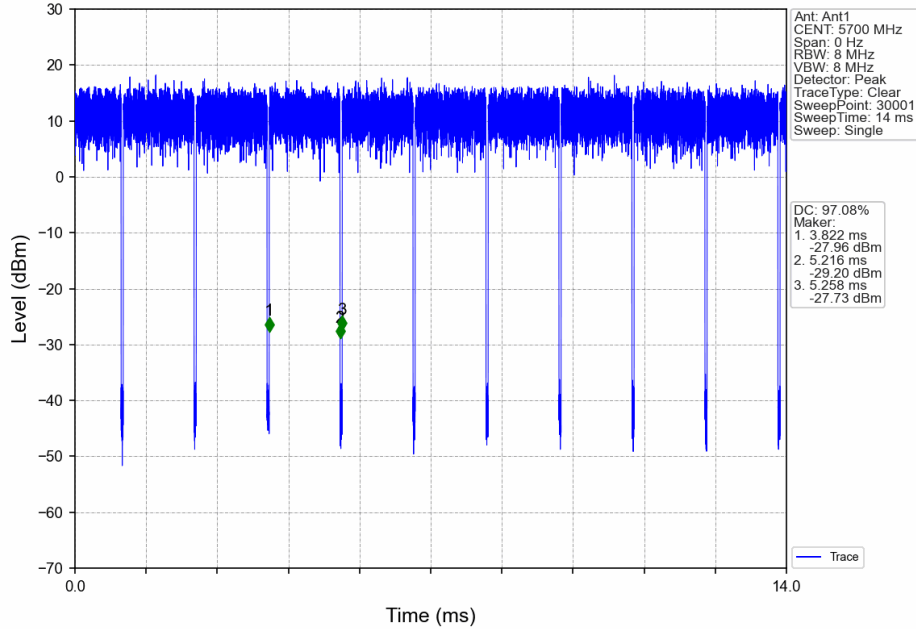

802.11a_LCH_5745MHz_Ant1_NTNV

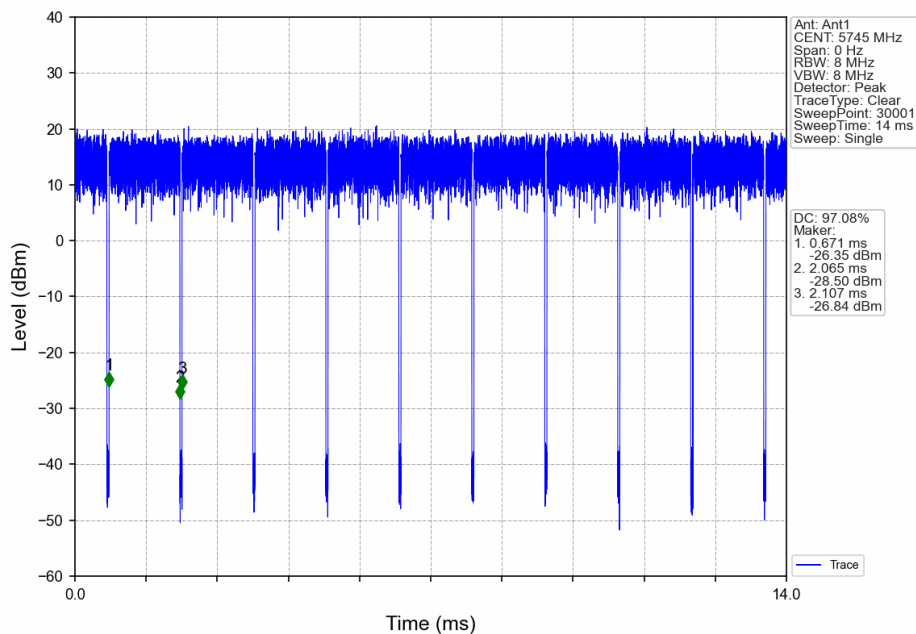

Unless otherwise agreed in writing, this document is issued by the Company subject to its General Conditions of Service printed overleaf, available on request or accessible at <http://www.sgs.com/en/Terms-and-Conditions.aspx> and, for electronic format documents, subject to Terms and Conditions for Electronic Documents at <http://www.sgs.com/en/Terms-and-Conditions/Terms-e-Documents.aspx>. Attention is drawn to the limitation of liability, indemnification and jurisdiction issues defined therein. Any holder of this document is advised that information contained hereon reflects the Company's findings at the time of its intervention only and within the limits of Client's instructions, if any. The Company's sole responsibility is to its Client and this document does not exonerate parties to a transaction from exercising all their rights and obligations under the transaction documents. This document cannot be reproduced except in full, without prior written approval of the Company. Any unauthorized alteration, forgery or falsification of the content or appearance of this document is unlawful and offenders may be prosecuted to the fullest extent of the law. Unless otherwise stated the results shown in this test report refer only to the sample(s) tested and such sample(s) are retained for 30 days only.

Attention: To check the authenticity of testing /inspection report & certificate, please contact us at telephone: (86-755) 8307 1443, or email: CN.Doccheck@sgs.com

802.11a_MCH_5785MHz_Ant1_NTNV

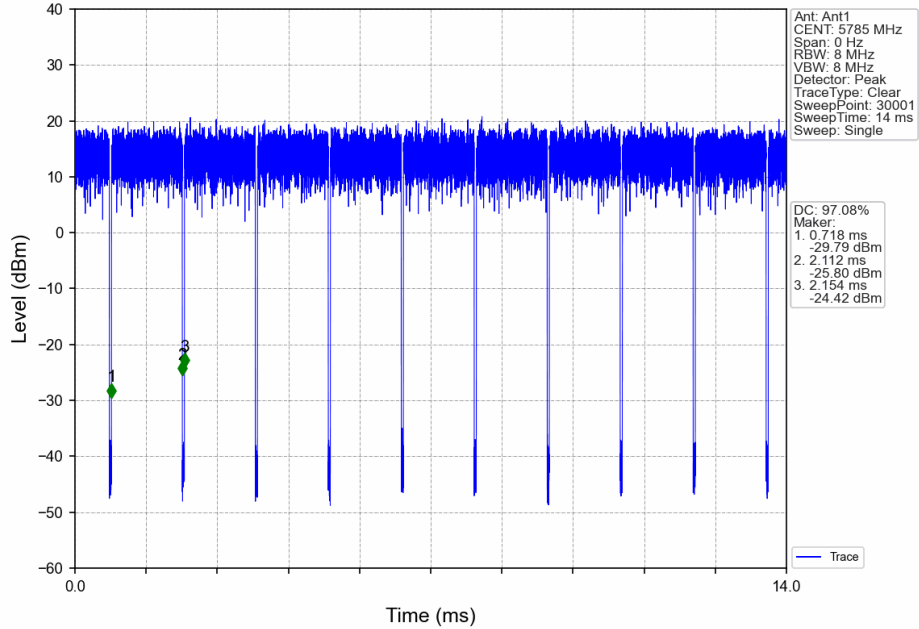

802.11a_HCH_5825MHz_Ant1_NTNV

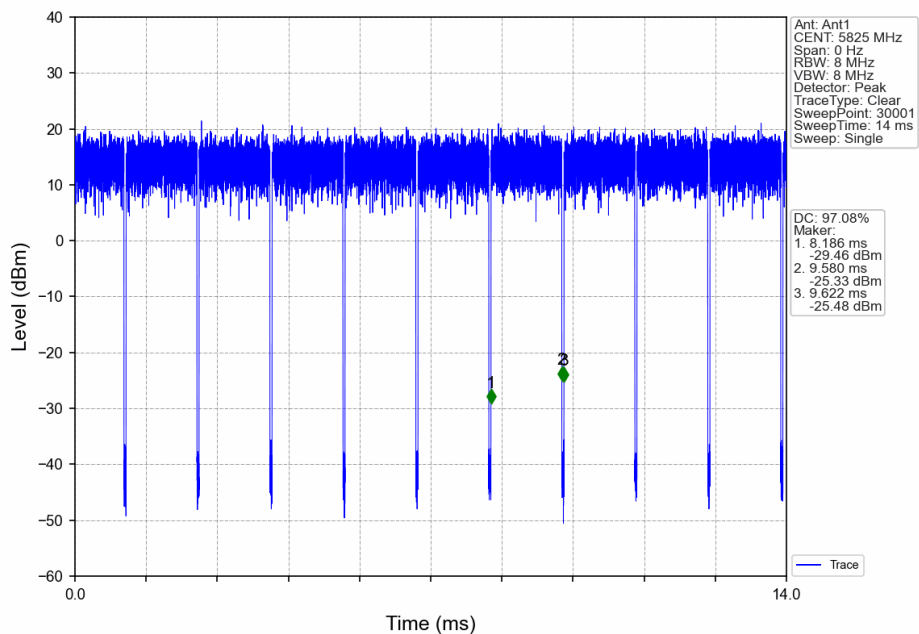

Unless otherwise agreed in writing, this document is issued by the Company subject to its General Conditions of Service printed overleaf, available on request or accessible at <http://www.sgs.com/en/Terms-and-Conditions.aspx> and, for electronic format documents, subject to Terms and Conditions for Electronic Documents at <http://www.sgs.com/en/Terms-and-Conditions/Terms-e-Documents.aspx>. Attention is drawn to the limitation of liability, indemnification and jurisdiction issues defined therein. Any holder of this document is advised that information contained hereon reflects the Company's findings at the time of its intervention only and within the limits of Client's instructions, if any. The Company's sole responsibility is to its Client and this document does not exonerate parties to a transaction from exercising all their rights and obligations under the transaction documents. This document cannot be reproduced except in full, without prior written approval of the Company. Any unauthorized alteration, forgery or falsification of the content or appearance of this document is unlawful and offenders may be prosecuted to the fullest extent of the law. Unless otherwise stated the results shown in this test report refer only to the sample(s) tested and such sample(s) are retained for 30 days only.

Attention: To check the authenticity of testing /inspection report & certificate, please contact us at telephone: (86-755) 8307 1443, or email: CN.Doccheck@sgs.com

802.11n(HT20)_LCH_5180MHz_Ant1_NTNV

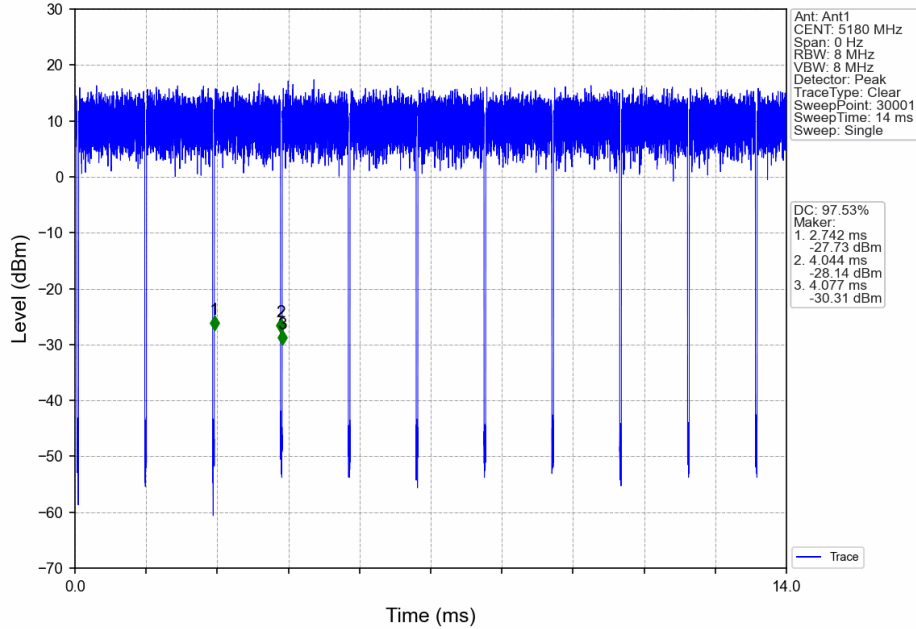

802.11n(HT20)_MCH_5200MHz_Ant1_NTNV

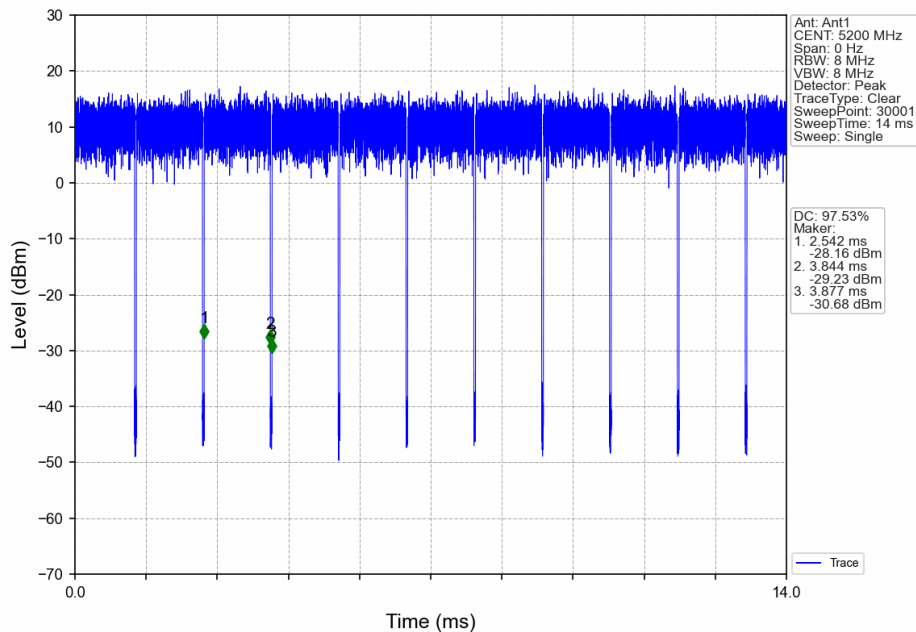

Unless otherwise agreed in writing, this document is issued by the Company subject to its General Conditions of Service printed overleaf, available on request or accessible at <http://www.sgs.com/en/Terms-and-Conditions.aspx> and, for electronic format documents, subject to Terms and Conditions for Electronic Documents at <http://www.sgs.com/en/Terms-and-Conditions/Terms-e-Documents.aspx>. Attention is drawn to the limitation of liability, indemnification and jurisdiction issues defined therein. Any holder of this document is advised that information contained hereon reflects the Company's findings at the time of its intervention only and within the limits of Client's instructions, if any. The Company's sole responsibility is to its Client and this document does not exonerate parties to a transaction from exercising all their rights and obligations under the transaction documents. This document cannot be reproduced except in full, without prior written approval of the Company. Any unauthorized alteration, forgery or falsification of the content or appearance of this document is unlawful and offenders may be prosecuted to the fullest extent of the law. Unless otherwise stated the results shown in this test report refer only to the sample(s) tested and such sample(s) are retained for 30 days only.

Attention: To check the authenticity of testing /inspection report & certificate, please contact us at telephone: (86-755) 8307 1443, or email: CN.Doccheck@sgs.com

802.11n(HT20)_HCH_5240MHz_Ant1_NTNV

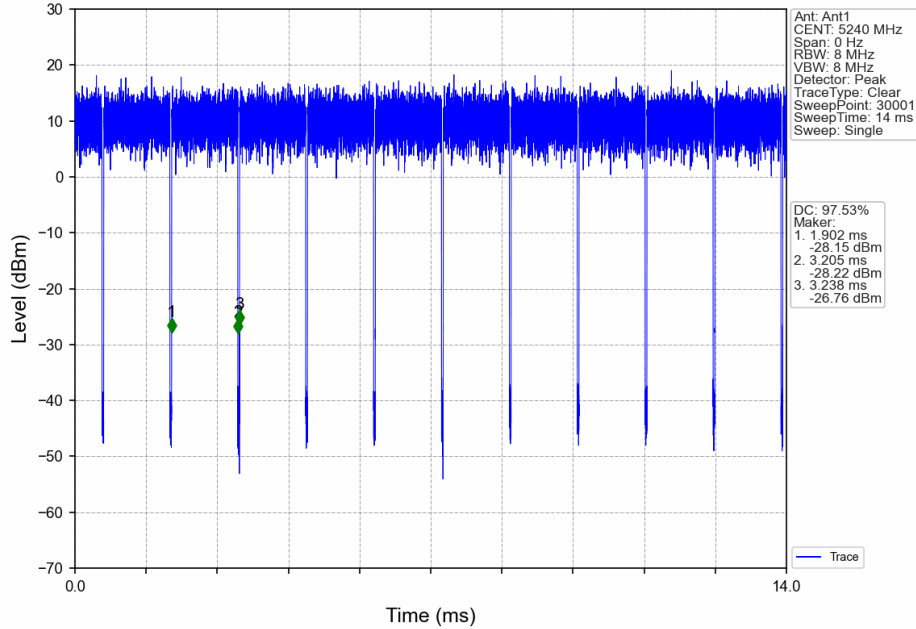

802.11n(HT20)_LCH_5260MHz_Ant1_NTNV

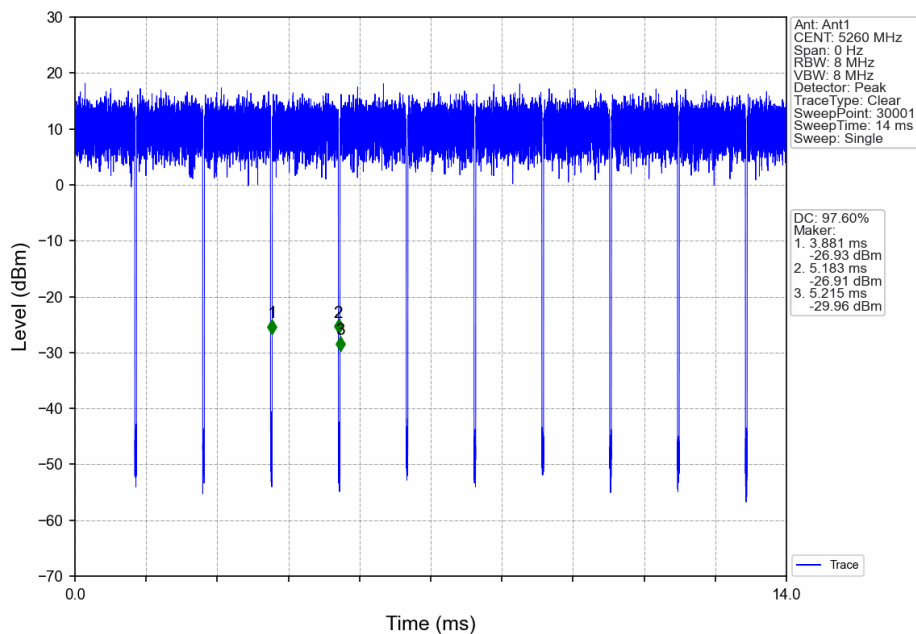

Unless otherwise agreed in writing, this document is issued by the Company subject to its General Conditions of Service printed overleaf, available on request or accessible at <http://www.sgs.com/en/Terms-and-Conditions.aspx> and, for electronic format documents, subject to Terms and Conditions for Electronic Documents at <http://www.sgs.com/en/Terms-and-Conditions/Terms-e-Documents.aspx>. Attention is drawn to the limitation of liability, indemnification and jurisdiction issues defined therein. Any holder of this document is advised that information contained hereon reflects the Company's findings at the time of its intervention only and within the limits of Client's instructions, if any. The Company's sole responsibility is to its Client and this document does not exonerate parties to a transaction from exercising all their rights and obligations under the transaction documents. This document cannot be reproduced except in full, without prior written approval of the Company. Any unauthorized alteration, forgery or falsification of the content or appearance of this document is unlawful and offenders may be prosecuted to the fullest extent of the law. Unless otherwise stated the results shown in this test report refer only to the sample(s) tested and such sample(s) are retained for 30 days only.

Attention: To check the authenticity of testing /inspection report & certificate, please contact us at telephone: (86-755) 8307 1443, or email: CN.Doccheck@sgs.com

802.11n(HT20)_MCH_5300MHz_Ant1_NTNV

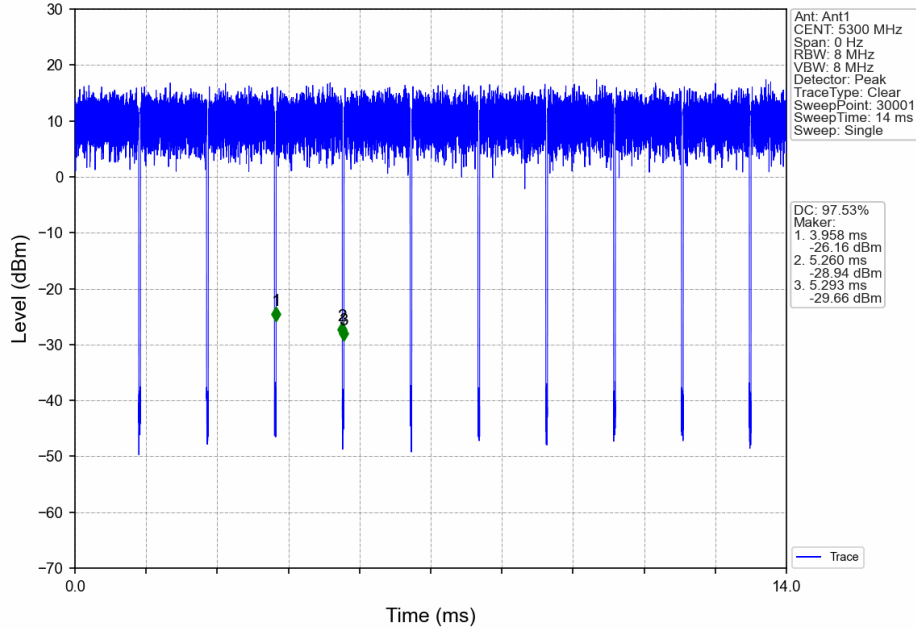

802.11n(HT20)_HCH_5320MHz_Ant1_NTNV

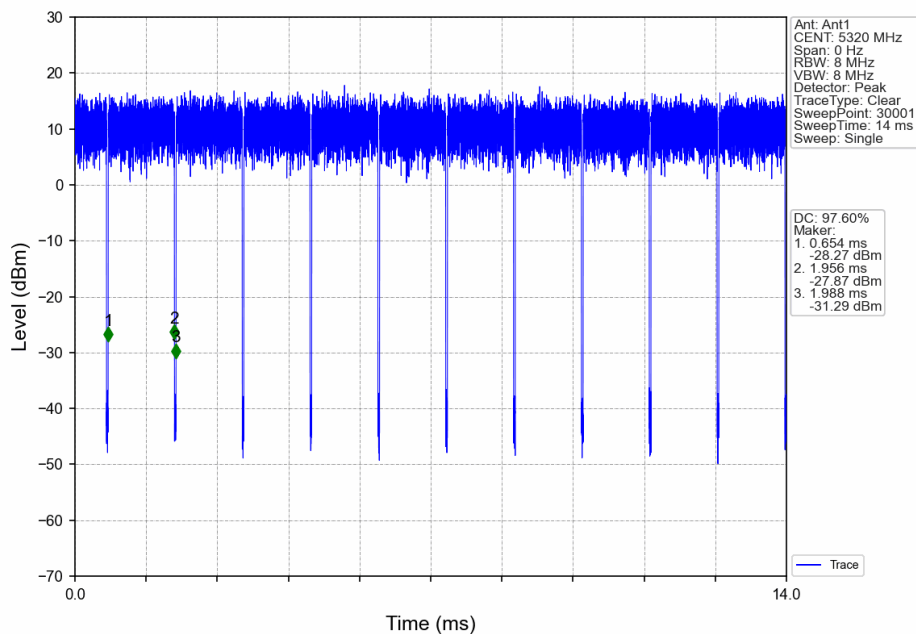

Unless otherwise agreed in writing, this document is issued by the Company subject to its General Conditions of Service printed overleaf, available on request or accessible at <http://www.sgs.com/en/Terms-and-Conditions.aspx> and, for electronic format documents, subject to Terms and Conditions for Electronic Documents at <http://www.sgs.com/en/Terms-and-Conditions/Terms-e-Documents.aspx>. Attention is drawn to the limitation of liability, indemnification and jurisdiction issues defined therein. Any holder of this document is advised that information contained hereon reflects the Company's findings at the time of its intervention only and within the limits of Client's instructions, if any. The Company's sole responsibility is to its Client and this document does not exonerate parties to a transaction from exercising all their rights and obligations under the transaction documents. This document cannot be reproduced except in full, without prior written approval of the Company. Any unauthorized alteration, forgery or falsification of the content or appearance of this document is unlawful and offenders may be prosecuted to the fullest extent of the law. Unless otherwise stated the results shown in this test report refer only to the sample(s) tested and such sample(s) are retained for 30 days only.

Attention: To check the authenticity of testing /inspection report & certificate, please contact us at telephone: (86-755) 8307 1443, or email: CN.Doccheck@sgs.com

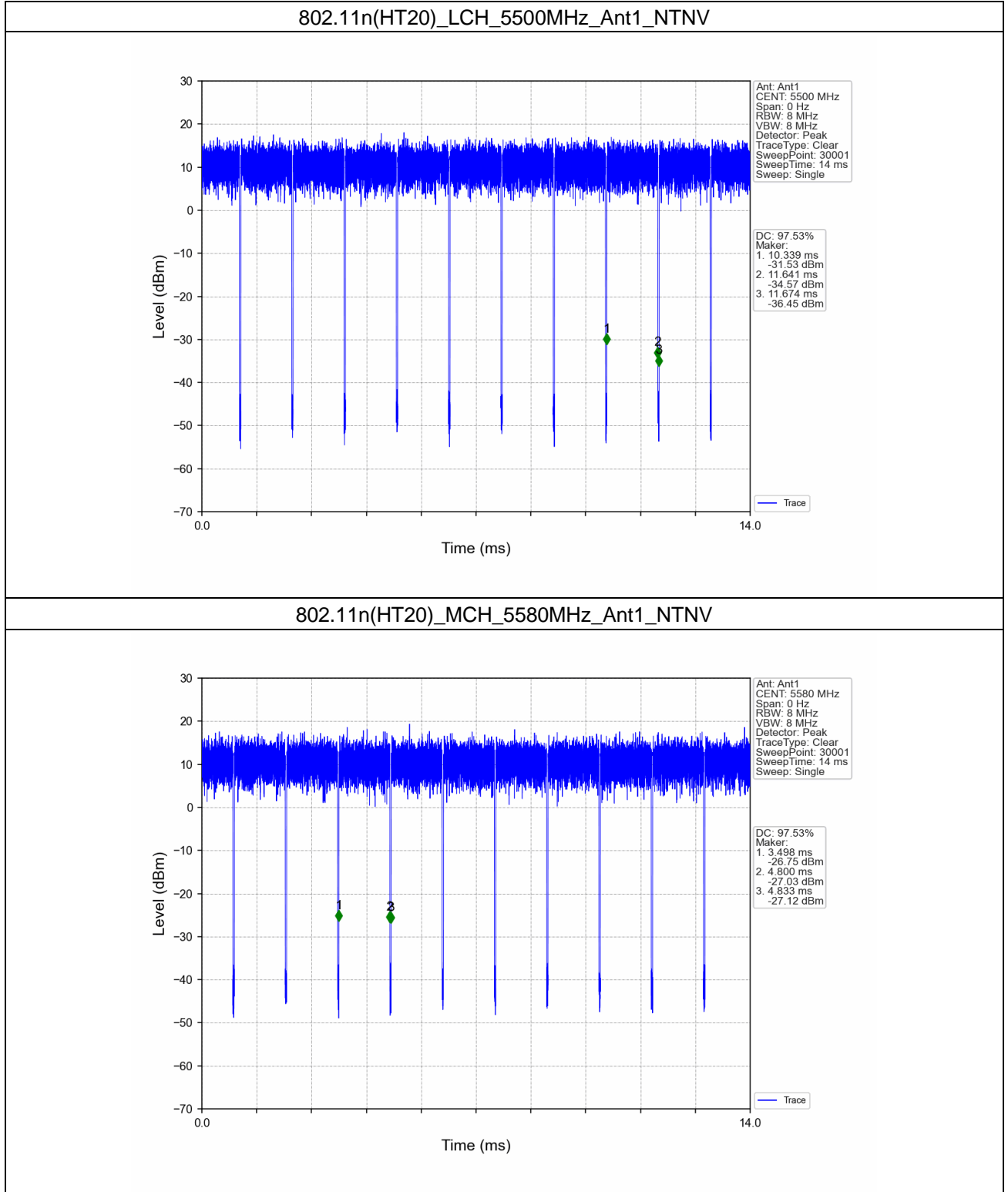

Unless otherwise agreed in writing, this document is issued by the Company subject to its General Conditions of Service printed overleaf, available on request or accessible at <http://www.sgs.com/en/Terms-and-Conditions.aspx> and, for electronic format documents, subject to Terms and Conditions for Electronic Documents at <http://www.sgs.com/en/Terms-and-Conditions/Terms-e-Documents.aspx>. Attention is drawn to the limitation of liability, indemnification and jurisdiction issues defined therein. Any holder of this document is advised that information contained hereon reflects the Company's findings at the time of its intervention only and within the limits of Client's instructions, if any. The Company's sole responsibility is to its Client and this document does not exonerate parties to a transaction from exercising all their rights and obligations under the transaction documents. This document cannot be reproduced except in full, without prior written approval of the Company. Any unauthorized alteration, forgery or falsification of the content or appearance of this document is unlawful and offenders may be prosecuted to the fullest extent of the law. Unless otherwise stated the results shown in this test report refer only to the sample(s) tested and such sample(s) are retained for 30 days only.

Attention: To check the authenticity of testing /inspection report & certificate, please contact us at telephone: (86-755) 8307 1443, or email: CN.Doccheck@sgs.com

802.11n(HT20)_HCH_5700MHz_Ant1_NTNV

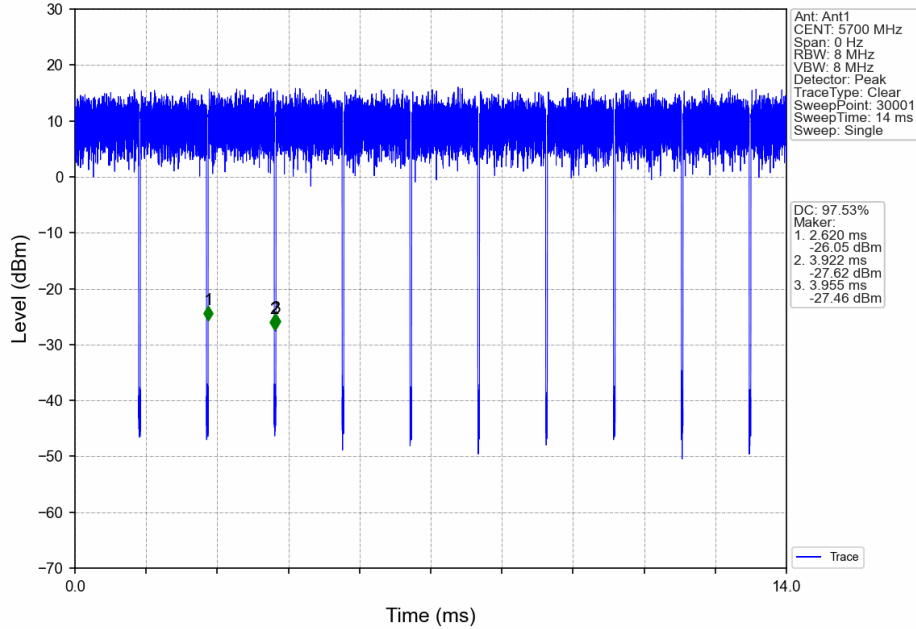

802.11n(HT20)_LCH_5745MHz_Ant1_NTNV

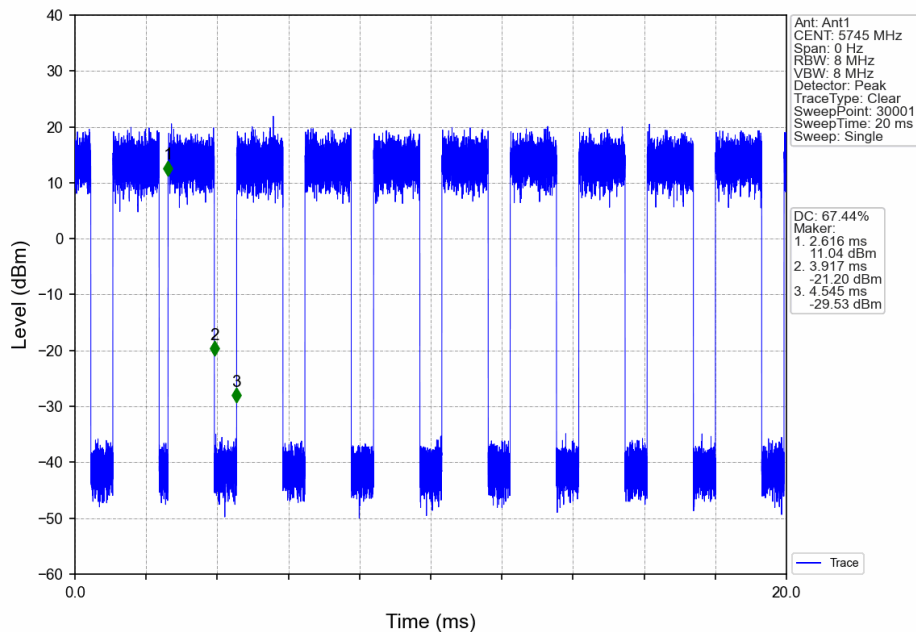

Unless otherwise agreed in writing, this document is issued by the Company subject to its General Conditions of Service printed overleaf, available on request or accessible at <http://www.sgs.com/en/Terms-and-Conditions.aspx> and, for electronic format documents, subject to Terms and Conditions for Electronic Documents at <http://www.sgs.com/en/Terms-and-Conditions/Terms-e-Documents.aspx>. Attention is drawn to the limitation of liability, indemnification and jurisdiction issues defined therein. Any holder of this document is advised that information contained hereon reflects the Company's findings at the time of its intervention only and within the limits of Client's instructions, if any. The Company's sole responsibility is to its Client and this document does not exonerate parties to a transaction from exercising all their rights and obligations under the transaction documents. This document cannot be reproduced except in full, without prior written approval of the Company. Any unauthorized alteration, forgery or falsification of the content or appearance of this document is unlawful and offenders may be prosecuted to the fullest extent of the law. Unless otherwise stated the results shown in this test report refer only to the sample(s) tested and such sample(s) are retained for 30 days only.

Attention: To check the authenticity of testing /inspection report & certificate, please contact us at telephone: (86-755) 8307 1443, or email: CN.Doccheck@sgs.com

802.11n(HT20)_MCH_5785MHz_Ant1_NTNV

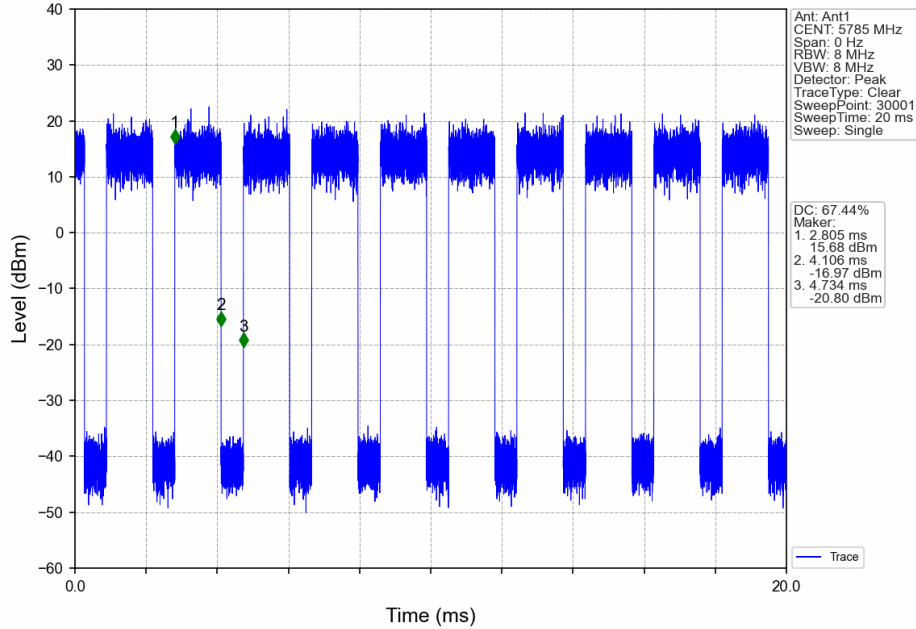

802.11n(HT20)_HCH_5825MHz_Ant1_NTNV

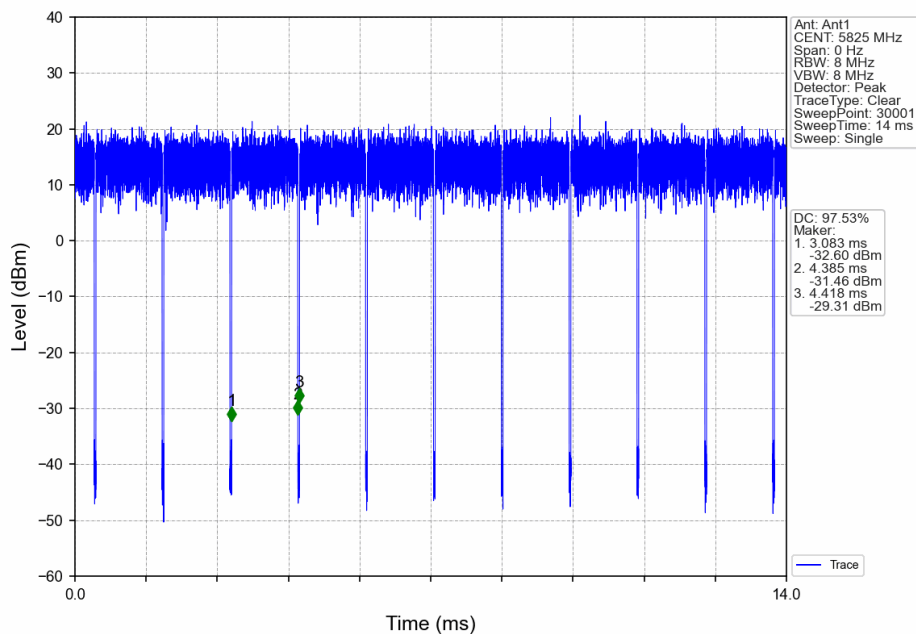

Unless otherwise agreed in writing, this document is issued by the Company subject to its General Conditions of Service printed overleaf, available on request or accessible at <http://www.sgs.com/en/Terms-and-Conditions.aspx> and, for electronic format documents, subject to Terms and Conditions for Electronic Documents at <http://www.sgs.com/en/Terms-and-Conditions/Terms-e-Documents.aspx>. Attention is drawn to the limitation of liability, indemnification and jurisdiction issues defined therein. Any holder of this document is advised that information contained hereon reflects the Company's findings at the time of its intervention only and within the limits of Client's instructions, if any. The Company's sole responsibility is to its Client and this document does not exonerate parties to a transaction from exercising all their rights and obligations under the transaction documents. This document cannot be reproduced except in full, without prior written approval of the Company. Any unauthorized alteration, forgery or falsification of the content or appearance of this document is unlawful and offenders may be prosecuted to the fullest extent of the law. Unless otherwise stated the results shown in this test report refer only to the sample(s) tested and such sample(s) are retained for 30 days only.

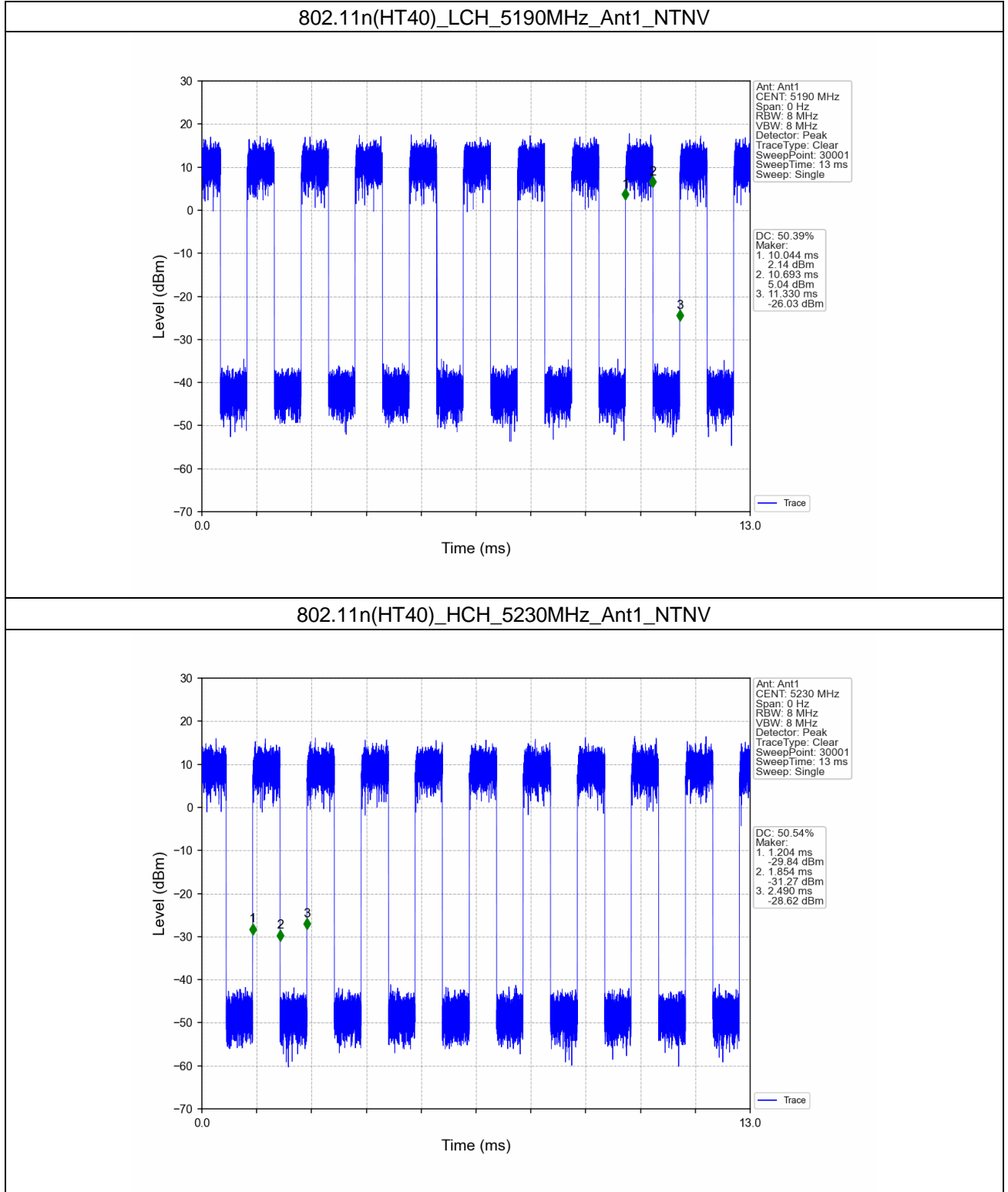

Unless otherwise agreed in writing, this document is issued by the Company subject to its General Conditions of Service printed overleaf, available on request or accessible at <http://www.sgs.com/en/Terms-and-Conditions.aspx> and, for electronic format documents, subject to Terms and Conditions for Electronic Documents at <http://www.sgs.com/en/Terms-and-Conditions/Terms-e-Documents.aspx>. Attention is drawn to the limitation of liability, indemnification and jurisdiction issues defined therein. Any holder of this document is advised that information contained hereon reflects the Company's findings at the time of its intervention only and within the limits of Client's instructions, if any. The Company's sole responsibility is to its Client and this document does not exonerate parties to a transaction from exercising all their rights and obligations under the transaction documents. This document cannot be reproduced except in full, without prior written approval of the Company. Any unauthorized alteration, forgery or falsification of the content or appearance of this document is unlawful and offenders may be prosecuted to the fullest extent of the law. Unless otherwise stated the results shown in this test report refer only to the sample(s) tested and such sample(s) are retained for 30 days only.

Attention: To check the authenticity of testing /inspection report & certificate, please contact us at telephone: (86-755) 8307 1443, or email: CN.Doccheck@sgs.com

802.11n(HT40)_LCH_5270MHz_Ant1_NTNV

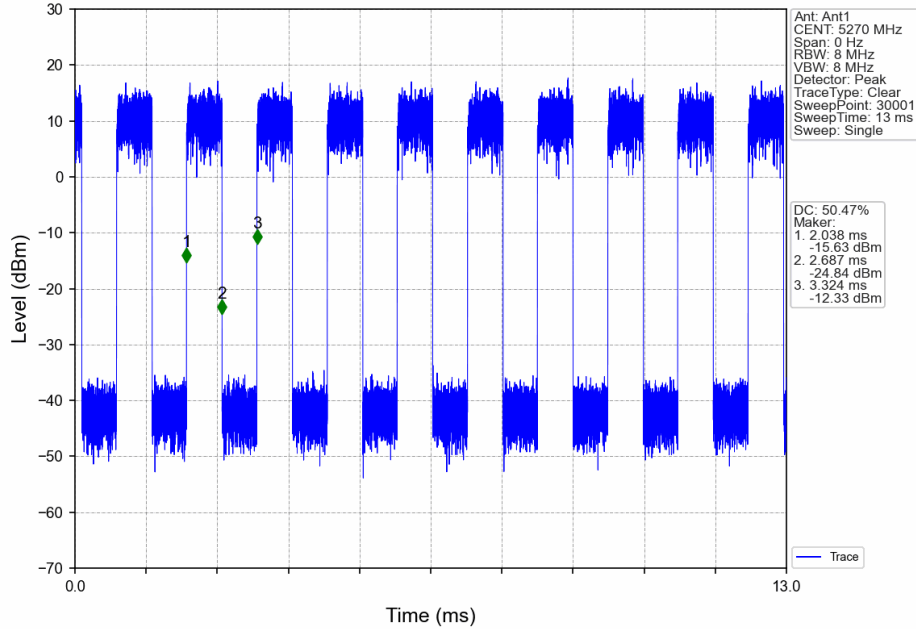

802.11n(HT40)_HCH_5310MHz_Ant1_NTNV

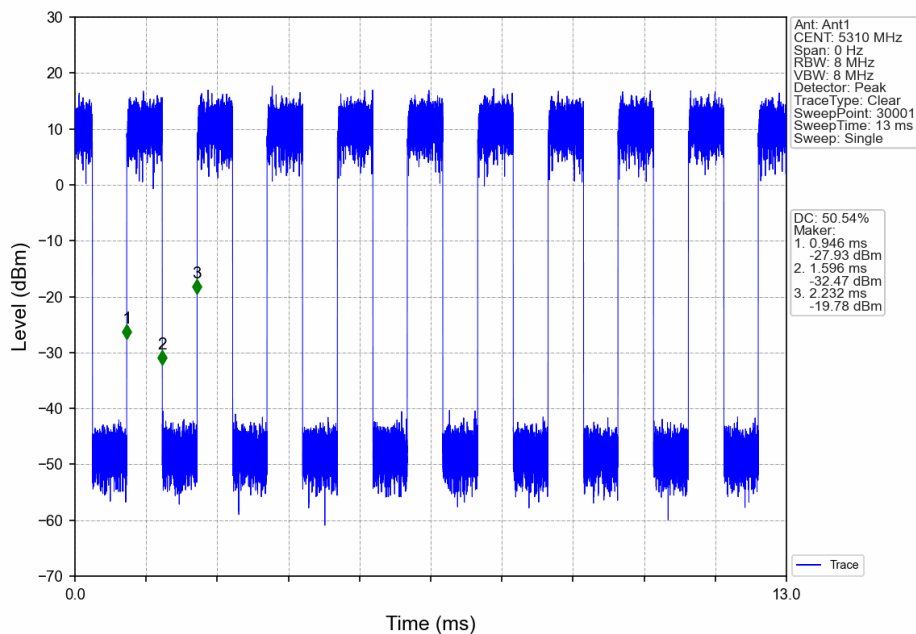

Unless otherwise agreed in writing, this document is issued by the Company subject to its General Conditions of Service printed overleaf, available on request or accessible at <http://www.sgs.com/en/Terms-and-Conditions.aspx> and, for electronic format documents, subject to Terms and Conditions for Electronic Documents at <http://www.sgs.com/en/Terms-and-Conditions/Terms-e-Documents.aspx>. Attention is drawn to the limitation of liability, indemnification and jurisdiction issues defined therein. Any holder of this document is advised that information contained hereon reflects the Company's findings at the time of its intervention only and within the limits of Client's instructions, if any. The Company's sole responsibility is to its Client and this document does not exonerate parties to a transaction from exercising all their rights and obligations under the transaction documents. This document cannot be reproduced except in full, without prior written approval of the Company. Any unauthorized alteration, forgery or falsification of the content or appearance of this document is unlawful and offenders may be prosecuted to the fullest extent of the law. Unless otherwise stated the results shown in this test report refer only to the sample(s) tested and such sample(s) are retained for 30 days only.

Attention: To check the authenticity of testing /inspection report & certificate, please contact us at telephone: (86-755) 8307 1443, or email: CN.Doccheck@sgs.com

802.11n(HT40)_LCH_5510MHz_Ant1_NTNV

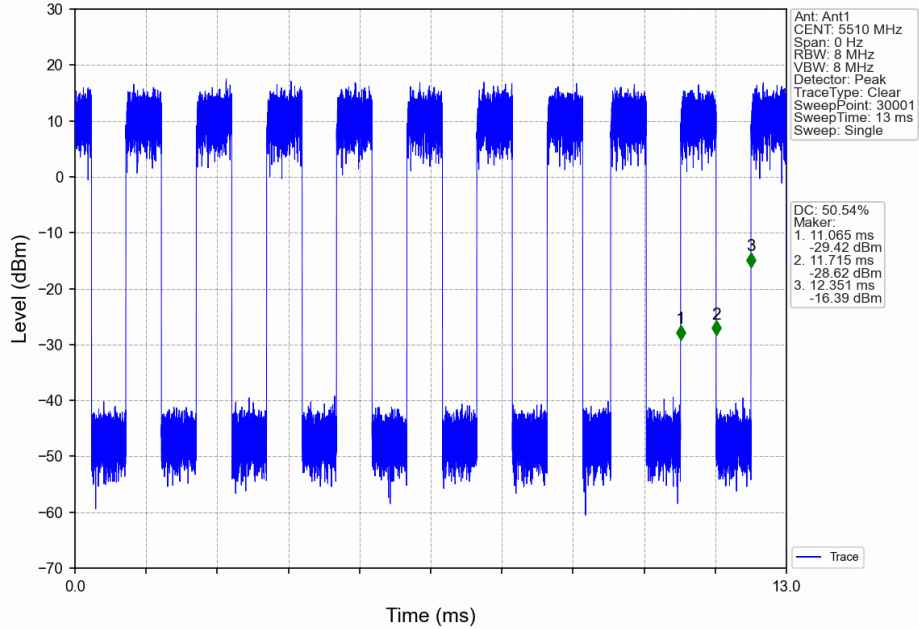

802.11n(HT40)_MCH_5550MHz_Ant1_NTNV

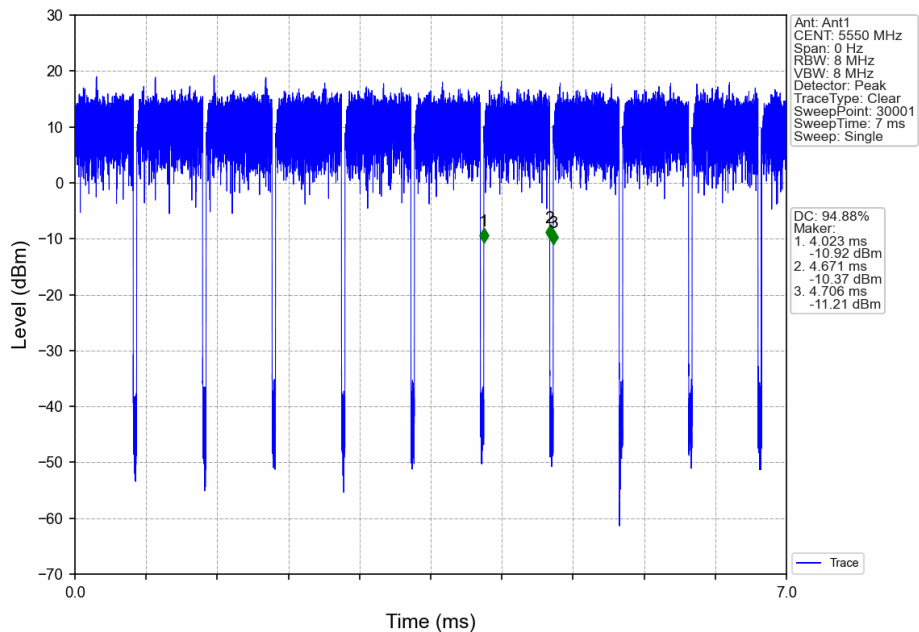

Unless otherwise agreed in writing, this document is issued by the Company subject to its General Conditions of Service printed overleaf, available on request or accessible at <http://www.sgs.com/en/Terms-and-Conditions.aspx> and, for electronic format documents, subject to Terms and Conditions for Electronic Documents at <http://www.sgs.com/en/Terms-and-Conditions/Terms-e-Documents.aspx>. Attention is drawn to the limitation of liability, indemnification and jurisdiction issues defined therein. Any holder of this document is advised that information contained hereon reflects the Company's findings at the time of its intervention only and within the limits of Client's instructions, if any. The Company's sole responsibility is to its Client and this document does not exonerate parties to a transaction from exercising all their rights and obligations under the transaction documents. This document cannot be reproduced except in full, without prior written approval of the Company. Any unauthorized alteration, forgery or falsification of the content or appearance of this document is unlawful and offenders may be prosecuted to the fullest extent of the law. Unless otherwise stated the results shown in this test report refer only to the sample(s) tested and such sample(s) are retained for 30 days only.

Attention: To check the authenticity of testing /inspection report & certificate, please contact us at telephone: (86-755) 8307 1443, or email: CN.Doccheck@sgs.com

802.11n(HT40)_HCH_5670MHz_Ant1_NTNV

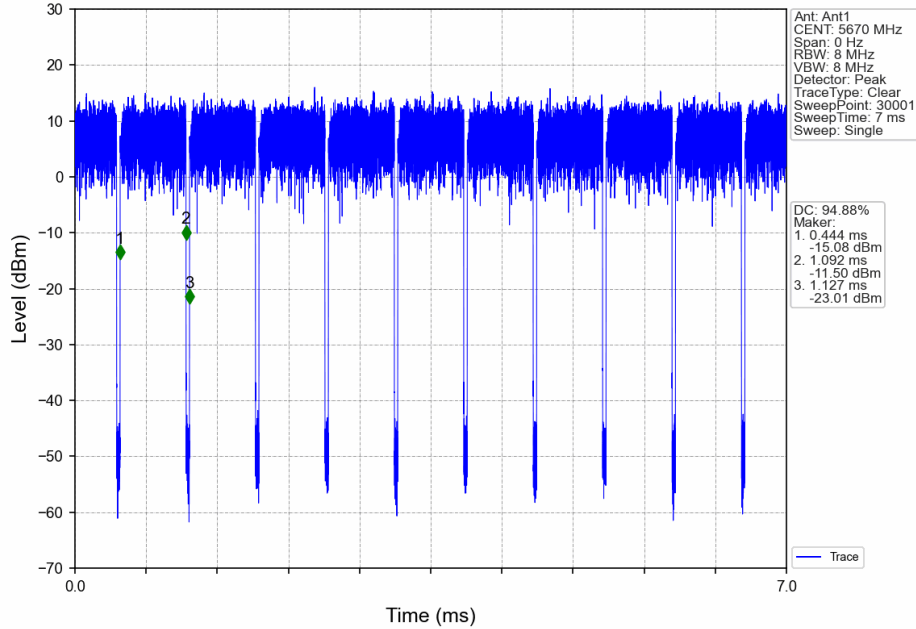

802.11n(HT40)_LCH_5755MHz_Ant1_NTNV

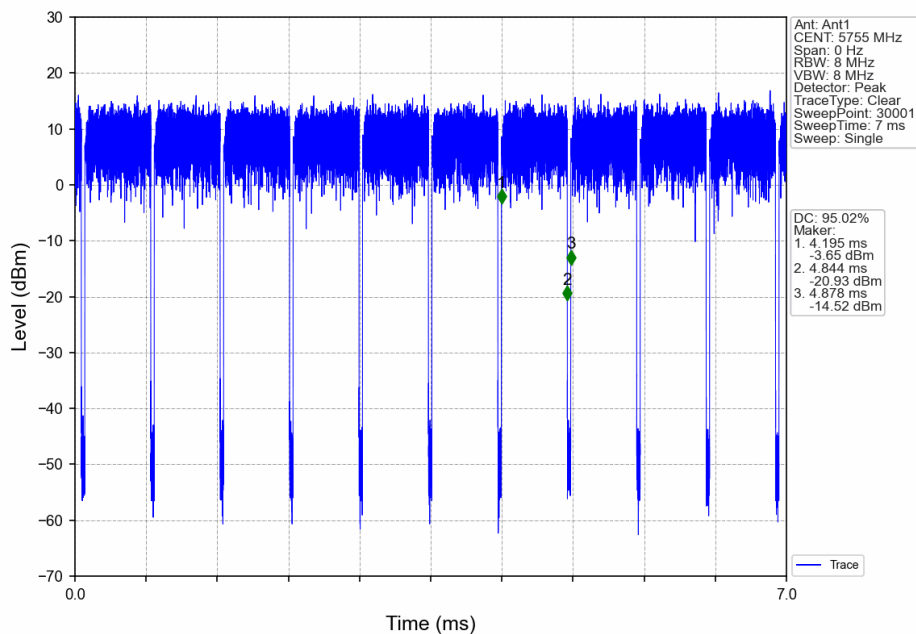

Unless otherwise agreed in writing, this document is issued by the Company subject to its General Conditions of Service printed overleaf, available on request or accessible at <http://www.sgs.com/en/Terms-and-Conditions.aspx> and, for electronic format documents, subject to Terms and Conditions for Electronic Documents at <http://www.sgs.com/en/Terms-and-Conditions/Terms-e-Documents.aspx>. Attention is drawn to the limitation of liability, indemnification and jurisdiction issues defined therein. Any holder of this document is advised that information contained hereon reflects the Company's findings at the time of its intervention only and within the limits of Client's instructions, if any. The Company's sole responsibility is to its Client and this document does not exonerate parties to a transaction from exercising all their rights and obligations under the transaction documents. This document cannot be reproduced except in full, without prior written approval of the Company. Any unauthorized alteration, forgery or falsification of the content or appearance of this document is unlawful and offenders may be prosecuted to the fullest extent of the law. Unless otherwise stated the results shown in this test report refer only to the sample(s) tested and such sample(s) are retained for 30 days only.

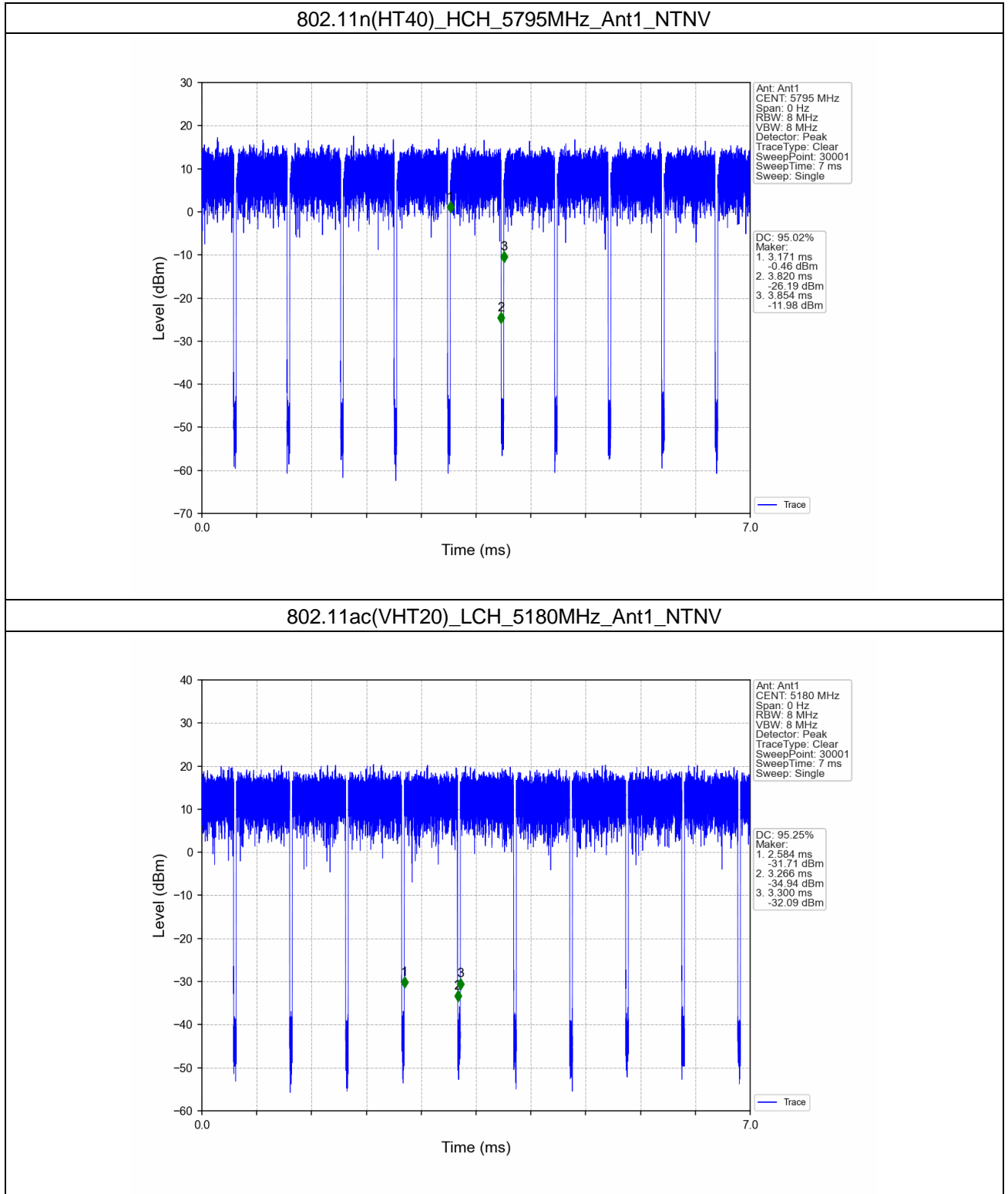

Unless otherwise agreed in writing, this document is issued by the Company subject to its General Conditions of Service printed overleaf, available on request or accessible at <http://www.sgs.com/en/Terms-and-Conditions.aspx> and, for electronic format documents, subject to Terms and Conditions for Electronic Documents at <http://www.sgs.com/en/Terms-and-Conditions/Terms-e-Documents.aspx>. Attention is drawn to the limitation of liability, indemnification and jurisdiction issues defined therein. Any holder of this document is advised that information contained hereon reflects the Company's findings at the time of its intervention only and within the limits of Client's instructions, if any. The Company's sole responsibility is to its Client and this document does not exonerate parties to a transaction from exercising all their rights and obligations under the transaction documents. This document cannot be reproduced except in full, without prior written approval of the Company. Any unauthorized alteration, forgery or falsification of the content or appearance of this document is unlawful and offenders may be prosecuted to the fullest extent of the law. Unless otherwise stated the results shown in this test report refer only to the sample(s) tested and such sample(s) are retained for 30 days only.

Attention: To check the authenticity of testing /inspection report & certificate, please contact us at telephone: (86-755) 8307 1443, or email: CN.Doccheck@sgs.com

802.11ac(VHT20)_MCH_5200MHz_Ant1_NTNV

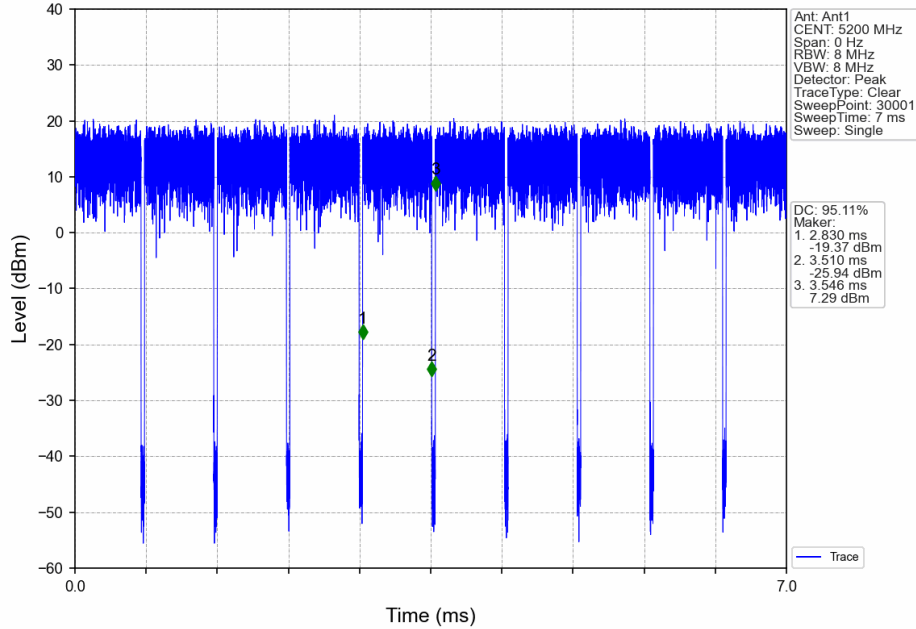

802.11ac(VHT20)_HCH_5240MHz_Ant1_NTNV

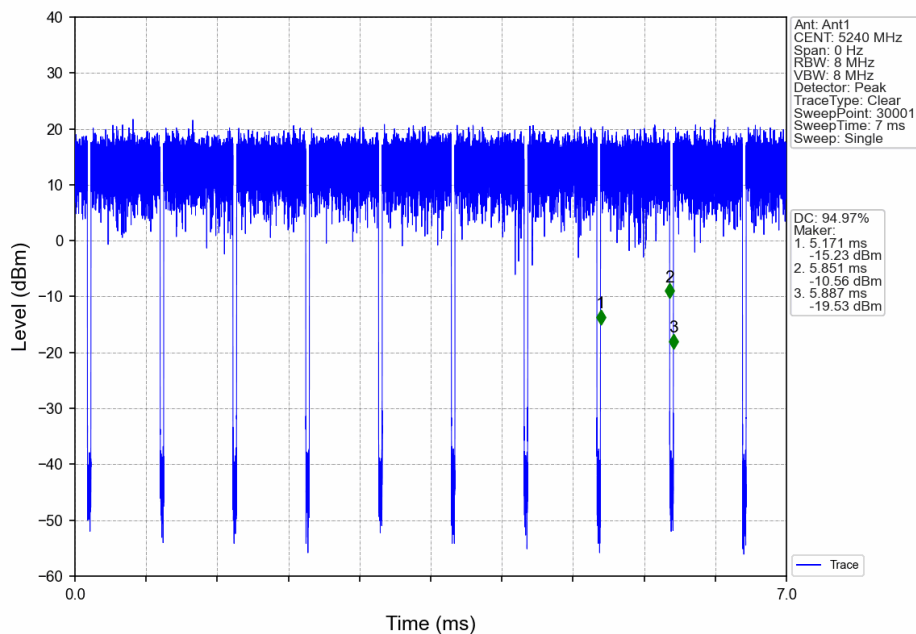

Unless otherwise agreed in writing, this document is issued by the Company subject to its General Conditions of Service printed overleaf, available on request or accessible at <http://www.sgs.com/en/Terms-and-Conditions.aspx> and, for electronic format documents, subject to Terms and Conditions for Electronic Documents at <http://www.sgs.com/en/Terms-and-Conditions/Terms-e-Documents.aspx>. Attention is drawn to the limitation of liability, indemnification and jurisdiction issues defined therein. Any holder of this document is advised that information contained hereon reflects the Company's findings at the time of its intervention only and within the limits of Client's instructions, if any. The Company's sole responsibility is to its Client and this document does not exonerate parties to a transaction from exercising all their rights and obligations under the transaction documents. This document cannot be reproduced except in full, without prior written approval of the Company. Any unauthorized alteration, forgery or falsification of the content or appearance of this document is unlawful and offenders may be prosecuted to the fullest extent of the law. Unless otherwise stated the results shown in this test report refer only to the sample(s) tested and such sample(s) are retained for 30 days only.

Attention: To check the authenticity of testing /inspection report & certificate, please contact us at telephone: (86-755) 8307 1443, or email: CN.Doccheck@sgs.com