

FCC AND IC CERTIFICATION TEST REPORT

FOR

Applicant	:	Harman International Industries, Incorporated
Address	:	8500 Balboa Boulevard, Northridge, CA 91329, UNITED STATES
Equipment under Test	:	Car amplifier
Model No	:	GTR-102, K2
Trade Mark	:	JBL/Infinity
FCC ID	:	APIJBLGTR102
IC	:	6132A-JBLGTR102
Manufacturer	:	Harman International Industries, Incorporated
Address	:	8500 Balboa Boulevard, Northridge, CA 91329, UNITED STATES

Issued By: Dongguan Dongdian Testing Service Co., Ltd.

Add: No. 17, Zongbu Road 2, Songshan Lake Sci&Tech, Industry Park, Dongguan City,
Guangdong Province, China, 523808

Tel: +86-0769-22891499 [Http://www.dgddt.com](http://www.dgddt.com)

REPORT

TABLE OF CONTENTS

- Test report declares.....4
- 1. Summary of test results 5
- 2. General test information..... 6
 - 2.1. Description of EUT 6
 - 2.2. Accessories of EUT..... 6
 - 2.3. Assistant equipment used for test 6
 - 2.4. Block diagram of EUT configuration for test 6
 - 2.5. Test environment conditions 7
 - 2.6. Deviations of test standard 7
 - 2.7. Test laboratory..... 7
 - 2.8. Measurement uncertainty 8
- 3. Maximum Peak Output Power 8
 - 3.1. Test equipment 8
 - 3.2. Block diagram of test setup 8
 - 3.3. Limits 9
 - 3.4. Test Procedure..... 9
 - 3.5. Test Result..... 9
- 4. 20dB Bandwidth and 99% Bandwidth..... 10
 - 4.1. Test equipment 10
 - 4.2. Block diagram of test setup 10
 - 4.3. Limits 10
 - 4.4. Test Procedure..... 10
 - 4.5. Test Result..... 11
 - 4.6. Original test data 11
- 5. Carrier Frequency Separation..... 18
 - 5.1. Test equipment 18
 - 5.2. Block diagram of test setup 18
 - 5.3. Limits 18
 - 5.4. Test Procedure..... 18
 - 5.5. Test Result..... 18
 - 5.6. Original test data 19
- 6. Number Of Hopping Channel 20
 - 6.1. Test equipment 20
 - 6.2. Block diagram of test setup 20
 - 6.3. Limits 20
 - 6.4. Test Procedure..... 20
 - 6.5. Test Result..... 20

6.6.	Original test data	21
7.	Dwell Time.....	22
7.1.	Test equipment	22
7.2.	Block diagram of test setup	22
7.3.	Limits	22
7.4.	Test Procedure.....	22
7.5.	Test Result.....	23
7.6.	Original test data	24
8.	Radiated emission	27
8.1.	Test equipment	27
8.2.	Block diagram of test setup	27
8.3.	Limit	29
8.4.	Test Procedure.....	30
8.5.	Test result	31
9.	Band Edge Compliance (radiated method)	35
9.1.	Test equipment	35
9.2.	Block diagram of test setup	35
9.3.	Limit	35
9.4.	Test Procedure.....	35
9.5.	Test result	36
10.	Band Edge Compliance (conducted method)	44
10.1.	Test equipment	44
10.2.	Block diagram of test setup	44
10.3.	Limit	44
10.4.	Test result	44
10.5.	Original test data	44
11.	Power Line Conducted Emission	48
11.1.	Test equipment	48
11.2.	Block diagram of test setup	48
11.3.	Power Line Conducted Emission Limits(Class B)	48
11.4.	Test Procedure.....	48
11.5.	Test Result.....	49
12.	Antenna Requirements	49
12.1.	Limit	49
12.2.	Result.....	49

TEST REPORT DECLARE

Applicant	:	Harman International Industries, Incorporated
Address	:	8500 Balboa Boulevard, Northridge, CA 91329, UNITED STATES
Equipment under Test	:	Car amplifier
Model No	:	GTR-102, K2
Trade Mark	:	JBL/Infinity
FCC ID	:	APIJBLGTR102
IC	:	6132A-JBLGTR102
Manufacturer	:	Harman International Industries, Incorporated
Address	:	8500 Balboa Boulevard, Northridge, CA 91329, UNITED STATES

Test Standard Used:

FCC Rules and Regulations Part 15 Subpart C: 2015, 2015, RSS-247 Issue 1 May 2015.

Test procedure used:

ANSI C63.10:2013, ANSI C63.4:2014, RSS-Gen Issue 4, Nov. 2014.

We Declare:

The equipment described above is tested by Dongguan Dongdian Testing Service Co., Ltd and in the configuration tested the equipment complied with the standards specified above. The test results are contained in this test report and Dongguan Dongdian Testing Service Co., Ltd is assumed of full responsibility for the accuracy and completeness of these tests.

After test and evaluation, our opinion is that the equipment provided for test compliance with the requirement of the above FCC&IC standards.

Report No:	DDT-R15Q0807-2E2		
Date of Test:	Aug. 14, 2015~Aug. 20, 2015	Date of Report:	Aug. 20, 2015

Prepared By:

Leo Liu/Engineer

Kevin Peng/EMC Manager

Note: This report applies to above tested sample only. This report shall not be reproduced in parts without written approval of Dongguan Dongdian Testing Service Co., Ltd.

1. Summary of test results

Description of Test Item	Standard	Results
Maximum Peak Output Power	FCC Part 15: 15.247(b)(1) ANSI C63.10 :2013 ANSI C63.4:2014 RSS-247 Issue 1 clause 5.1	PASS
20dB Bandwidth and 99% Bandwidth	FCC Part 15: 15.215 ANSI C63.10 :2013 ANSI C63.4:2014 RSS-247 Issue 1 clause 5.1	PASS
Carrier Frequency Separation	FCC Part 15: 15.247(a)(1) ANSI C63.10 :2013 ANSI C63.4:2014 RSS-247 Issue 1 clause 5.1	PASS
Number Of Hopping Channel	FCC Part 15: 15.247(a)(1)(iii) ANSI C63.10 :2013 ANSI C63.4:2014 RSS-247 Issue 1 clause 5.1	PASS
Dwell Time	FCC Part 15: 15.247(a)(1)(iii) ANSI C63.10 :2013 ANSI C63.4:2014 RSS-247 Issue 1 clause 5.1	PASS
Radiated Emission	FCC Part 15: 15.209 FCC Part 15: 15.247(d) ANSI C63.10 :2013 ANSI C63.4:2014 RSS-247 Issue 1 clause 5.1 RSS-Gen Issue 4 clause 7.2.2 RSS-Gen Issue 4 clause 7.2.5	PASS
Band Edge Compliance	FCC Part 15: 15.247(d) ANSI C63.10 :2013 ANSI C63.4:2014 RSS-247 Issue 1 clause 5.1 RSS-Gen Issue 4 clause 7.2.2 RSS-Gen Issue 4 clause 7.2.5	PASS
Power Line Conducted Emissions	FCC Part 15: 15.207 ANSI C63.10 :2013 ANSI C63.4:2014 RSS-Gen Issue 4 clause 7.2.4	N/A
Antenna requirement	FCC Part 15: 15.203 ANSI C63.4:2014 RSS-Gen Issue 4 clause 7.1.2	PASS

Remark: N/A is an abbreviation for Not Applicable.

2. General test information

2.1. Description of EUT

EUT* Name	:	Car amplifier
Model Number	:	GTR-102, K2
Difference of Model	:	All models are electrically identical, only the appearance, color, trade name and model No. are different .So we prepare GTR-102 for test only.
EUT function description	:	Please reference user manual of this device
Power supply	:	DC 12V
Radio Specification	:	Bluetooth V3.0 (BDR/EDR)
Operation frequency	:	2402MHz -2480MHz
Modulation	:	GFSK, $\pi/4$ QPSK, 8-DPSK
Data rate	:	1Mbps, 2Mbps, 3Mbps
Antenna Type	:	Integrated PCB antenna, maximum PK gain: 0.72dBi
Date of Receipt	:	2015/8/14
Sample Type	:	Series production

Note : EUT is the ab. of equipment under test.

2.2. Accessories of EUT

Description of Accessories	Manufacturer	Model number or Type	Serial No.	Other
/	/	/	/	/

2.3. Assistant equipment used for test

Description of Assistant equipment	Manufacturer	Model number or Type	EMC Compliance	Other
/	/	/	/	/

2.4. Block diagram of EUT configuration for test



The test software was used to control EUT work in Continuous TX mode, and select test channel, wireless mode as blow table.

Tested mode, channel, information		
Mode	Channel	Frequency (MHz)
GFSK hopping on Tx Mode	CH0 to CH78	2402 to 2480
$\pi/4$ QPSK Hopping on TX mode	CH0 to CH78	2402 to 2480
8-DPSK hopping on Tx Mode	CH0 to CH78	2402 to 2480
GFSK hopping off Tx Mode	CH0	2402
	CH39	2441
	CH78	2480
$\pi/4$ QPSK hopping off Tx Mode	CH0	2402
	CH39	2441
	CH78	2480
8-DPSK hopping off Tx Mode	CH0	2402
	CH39	2441
	CH78	2480

Note: For $\pi/4$ QPSK its same modulation type with 8-DPSK, and based exploratory test, there is no significant difference of that two types test result, so except output power, all other items final test were only performed with the worse case 8-DPSK and GFSK.

Test software for active EUT

Software	Manufacturer	Model No.	Version	Memo
CSR BlueSuite	Cambridge Silicon Radio Limited	BlueTest3	2.4.8	/

2.5. Test environment conditions

During the measurement the environmental conditions were within the listed ranges:

Temperature range:	21-25°C
Humidity range:	40-75%
Pressure range:	86-106kPa

2.6. Deviations of test standard

No Deviation

2.7. Test laboratory

Dongguan Dongdian Testing Service Co., Ltd

Add: No. 17, Zongbu Road 2, Songshan Lake Sci&Tech, Industry Park, Dongguan City, Guangdong Province, China, 523808 Tel: +86-0769-22891499 <http://www.dgddt.com>

FCC Registration Number: 270092

2.8. Measurement uncertainty

Test Item	Uncertainty
Bandwidth	±1.1%
Peak Output Power(Conducted)(Spectrum analyzer)	0.86dB(10 MHz ≤ f < 3.6GHz);
	1.38dB(3.6GHz ≤ f < 8GHz)
Peak Output Power(Conducted)(Power Sensor)	0.74dB
Power Spectral Density	0.74dB(10 MHz ≤ f < 3.6GHz);
	1.38dB(3.6GHz ≤ f < 8GHz)
Conducted spurious emissions	0.86dB(10 MHz ≤ f < 3.6GHz);
	1.40dB(3.6GHz ≤ f < 8GHz)
	1.66dB(8GHz ≤ f < 22GHz)
Uncertainty for radio frequency (RBW<20KHz)	3×10 ⁻⁸
Temperature	±0.4℃
Humidity	±2%
Uncertainty for Radiation Emission test (30MHz-1GHz)	±3.14 dB (Antenna Polarize: V)
	±3.16 dB (Antenna Polarize: H)
Uncertainty for Radiation Emission test (1GHz-18GHz)	±4.14dB(1-6GHz)
	±4.46dB (6GHz-18Gz)
Uncertainty for Power line conduction emission test	2.44dB (150KHz-30MHz)
Note: This uncertainty represents an expanded uncertainty expressed at approximately the 95% confidence level using a coverage factor of k=2.	

Note: This uncertainty represents an expanded uncertainty expressed at approximately the 95% confidence level using a coverage factor of k=2.

3. Maximum Peak Output Power

3.1. Test equipment

Item	Equipment	Manufacturer	Model No.	Serial No.	Last Cal.	Cal. Interval
1	Spectrum analyzer	R&S	FSU	1166.1660.26	2014/10/25	1 Year
2	Attenuator	Mini-Circuits	BW-S10W2	101109	2014/10/25	1 Year
3	RF Cable	Micable	C10-01-01-1	100309	2014/10/25	1 Year

3.2. Block diagram of test setup

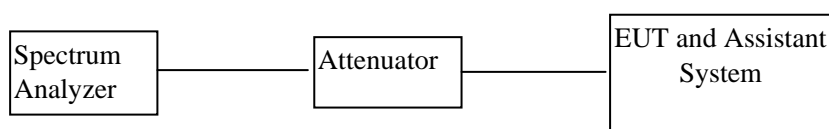

3.3. Limits

For frequency hopping systems operating in the 2400-2483.5 MHz band employing at least 75 non-overlapping hopping channels, and all frequency hopping systems in the 5725-5850 MHz band: 1 watt. For all other frequency hopping systems in the 2400-2483.5 MHz band: 0.125 watts, the e.i.r.p shall not exceed 4W.

3.4. Test Procedure

- (1) Configure EUT and assistant system according clause 2.4 and 3.2
- (2) Connect EUT's antenna output to spectrum analyzer by RF cable.
- (3) Configure EUT work in test mode as stated in clause 2.4.
- (4) Measure the maximum output power of EUT by spectrum analyzer with PK detector and RBW=2MHz(above 20dB bandwidth of measured signal), VBW=3MHz

Note: The attenuator loss was inputted into spectrum analyzer as amplitude offset.

3.5. Test Result

EUT: Car amplifier		M/N: GTR-102		
Mode	Freq (MHz)	Result (dBm)	Limit (dBm)	Conclusion
GFSK	2402	1.86	30	PASS
	2441	1.33	30	PASS
	2480	0.88	30	PASS
$\pi/4$ QPSK	2402	0.66	21	PASS
	2441	-0.32	21	PASS
	2480	-0.93	21	PASS
8-DPSK	2402	0.89	21	PASS
	2441	-0.05	21	PASS
	2480	-0.86	21	PASS
Test Date : 2015/8/14		Test Engineer : Leo		

4. 20dB Bandwidth and 99% Bandwidth

4.1. Test equipment

Item	Equipment	Manufacturer	Model No.	Serial No.	Last Cal.	Cal. Interval
1	Spectrum analyzer	R&S	FSU	1166.1660.26	2014/10/25	1 Year
2	Attenuator	Mini-Circuits	BW-S10W2	101109	2014/10/25	1 Year
3	RF Cable	Micable	C10-01-01-1	100309	2014/10/25	1 Year

4.2. Block diagram of test setup

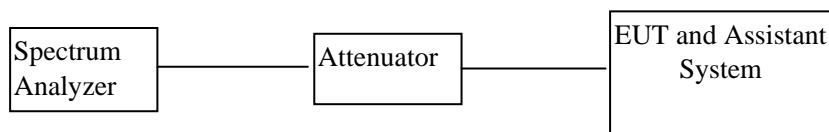

4.3. Limits

Intentional radiators operating under the alternative provisions to the general emission limits, as contained in § 15.217 through 15.257 and in Subpart E of this part, must be designed to ensure that the 20 dB bandwidth of the emission, or whatever bandwidth may otherwise be specified in the specific rule section under which the equipment operates, is contained within the frequency band designated in the rule section under which the equipment is operated.

4.4. Test Procedure

- (1) Configure EUT and assistant system according clause 2.4 and 4.2.
- (2) Connect EUT's antenna output to spectrum analyzer by RF cable.
- (3) Configure EUT work in test mode as stated in clause 2.4.
- (4) The bandwidth of the fundamental frequency was measured by spectrum analyzer with 30 kHz RBW and 100 kHz VBW. The 20dB bandwidth is defined as the total spectrum the power of which is higher than peak power minus 20dB.

4.5. Test Result

EUT: Car amplifier		M/N: GTR-102				
Mode	Freq (MHz)	20dB bandwidth Result (MHz)	99% bandwidth Result (MHz)	Limit (MHz)	Margin (MHz)	Conclusion
GFSK	2402	0.832	0.861	/	/	PASS
	2441	0.837	0.861	/	/	PASS
	2480	0.875	0.861	/	/	PASS
8-DPSK	2402	1.284	1.173	/	/	PASS
	2441	1.284	1.168	/	/	PASS
	2480	1.284	1.163	/	/	PASS

Test Date : 2015/8/14 Test Engineer: Leo

4.6. Original test data

GFSK Mode (20dB bandwidth)

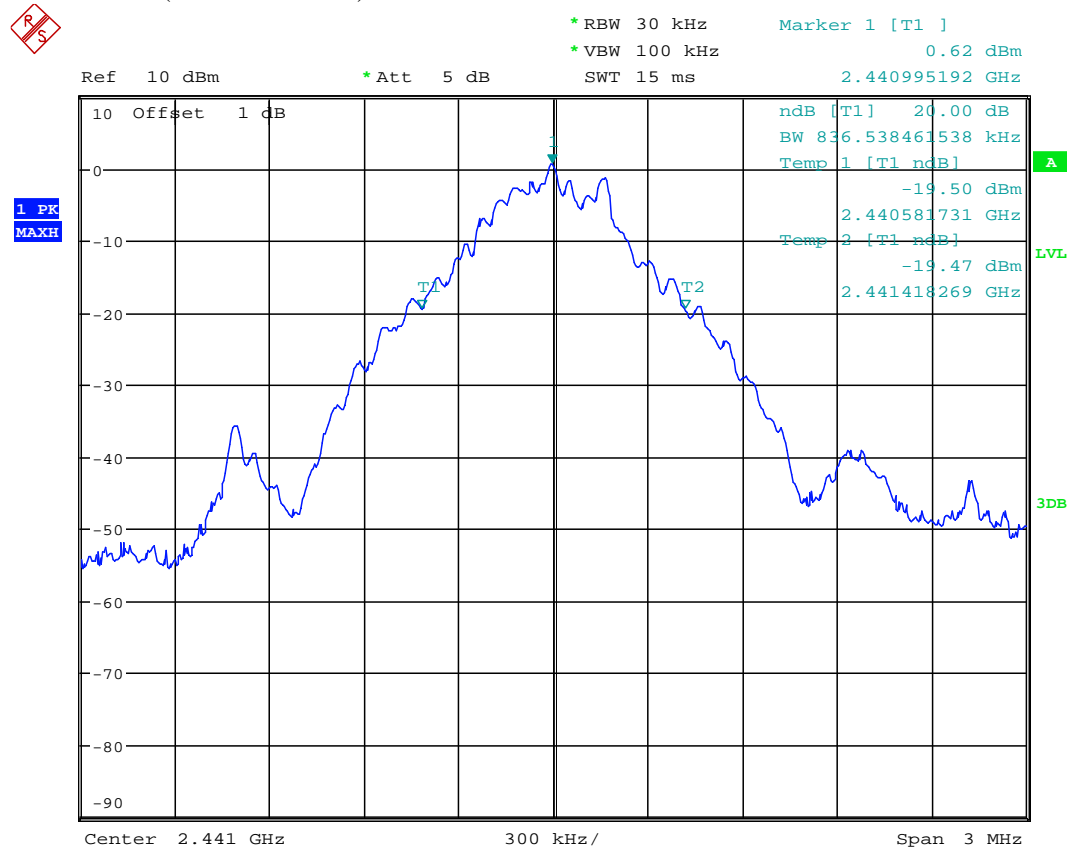

8-DPSK Mode (20dB bandwidth)

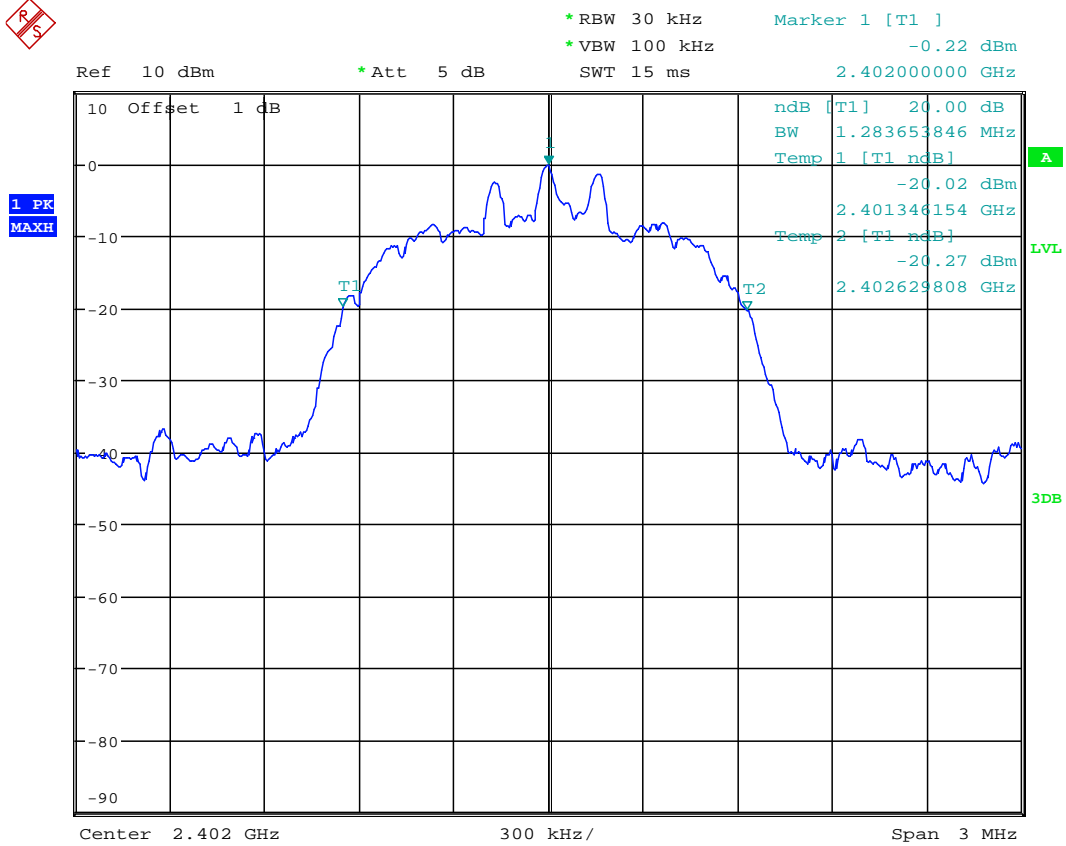
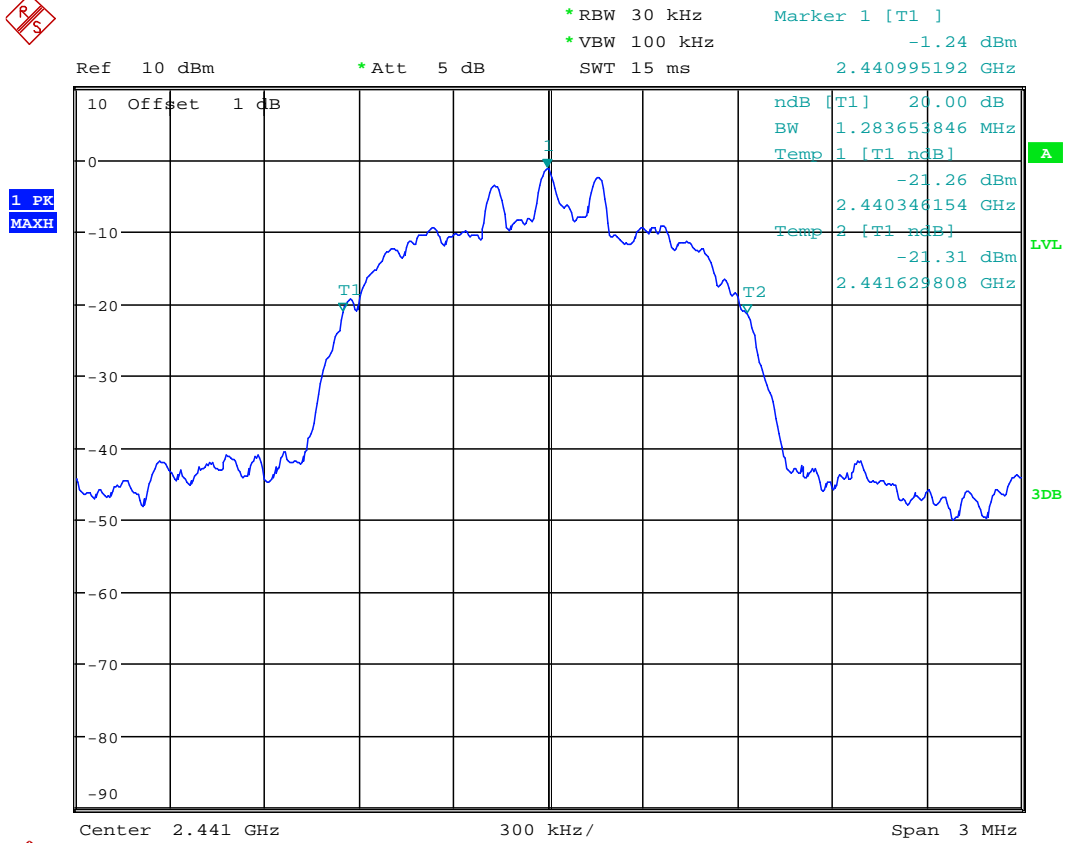

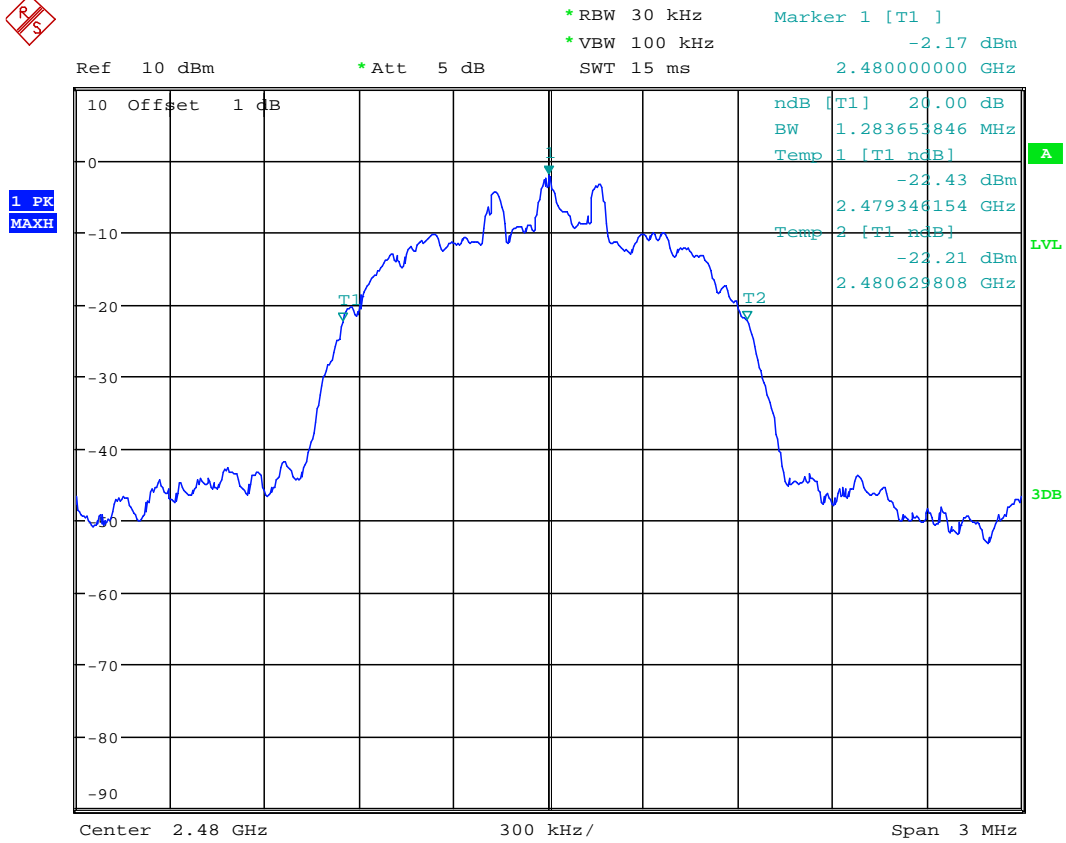

GFSK (99% bandwidth)

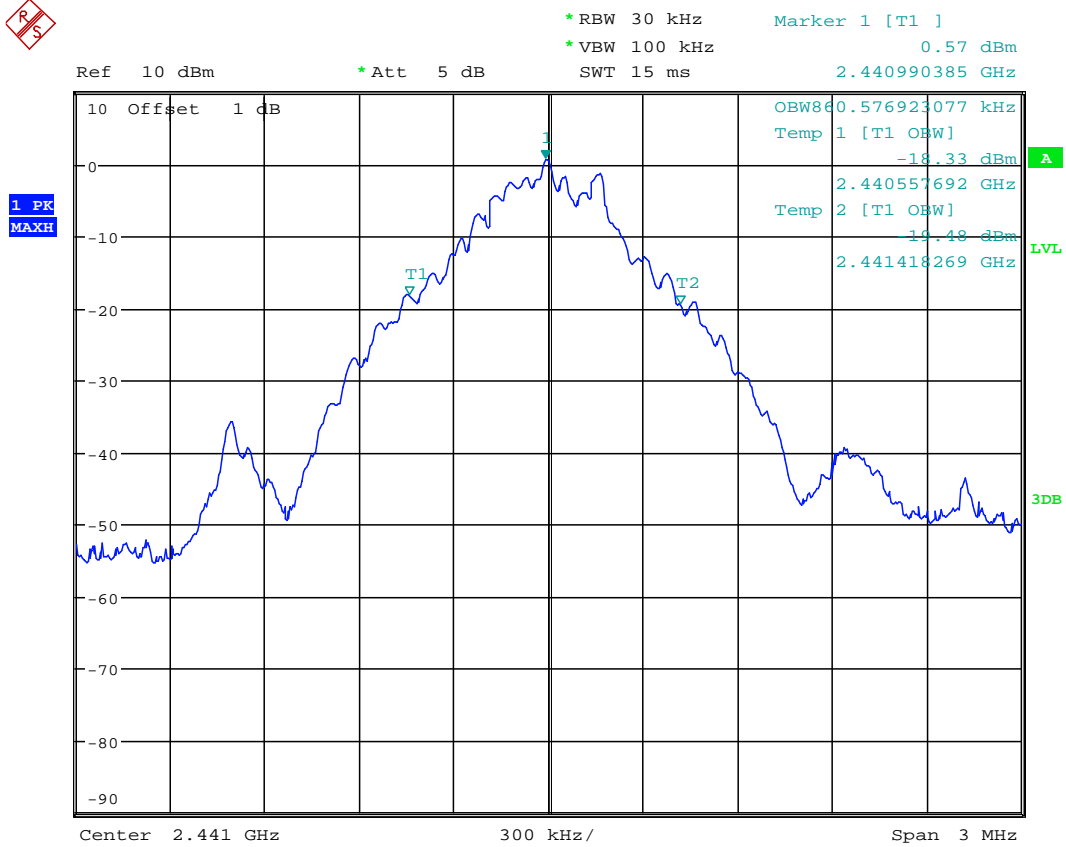



1 PK
MAXH

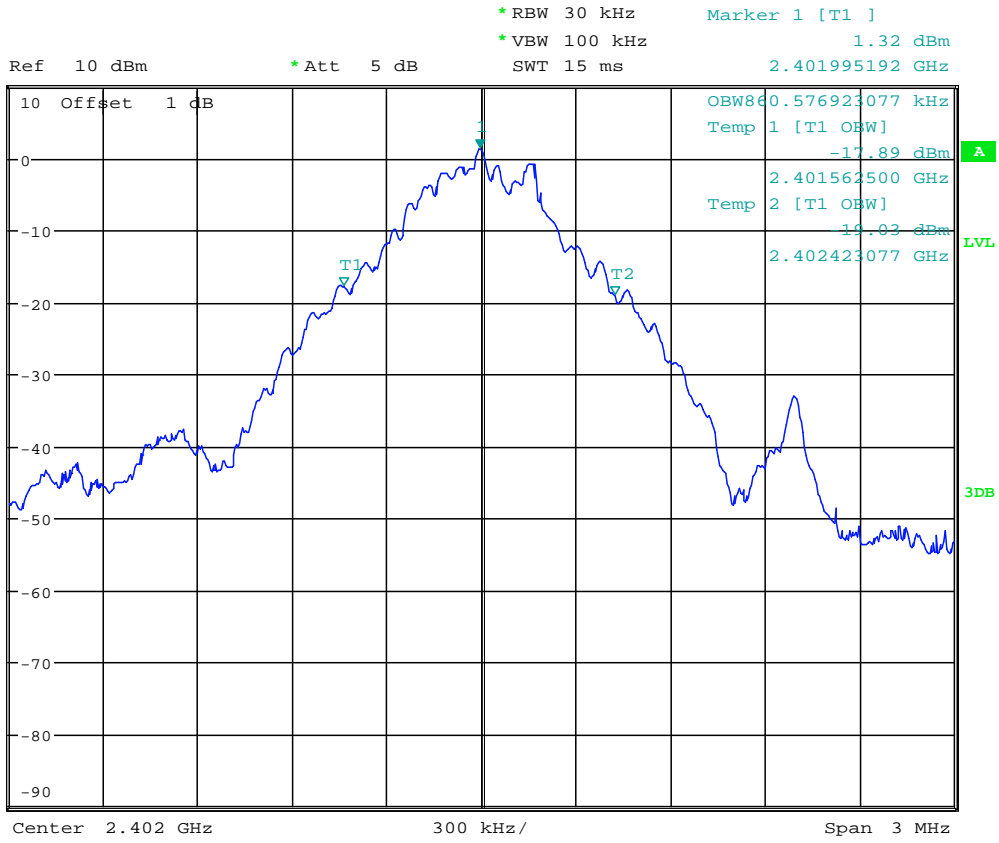

1 PK
MAXH

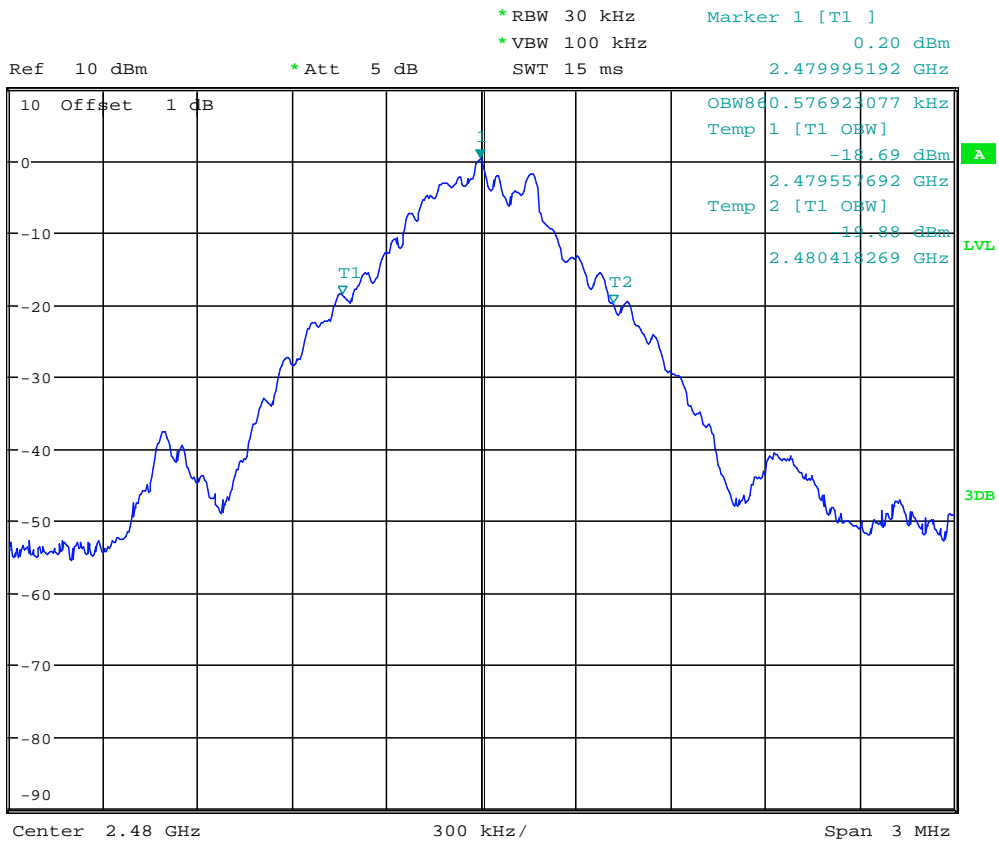

8-DPSK (99% bandwidth)

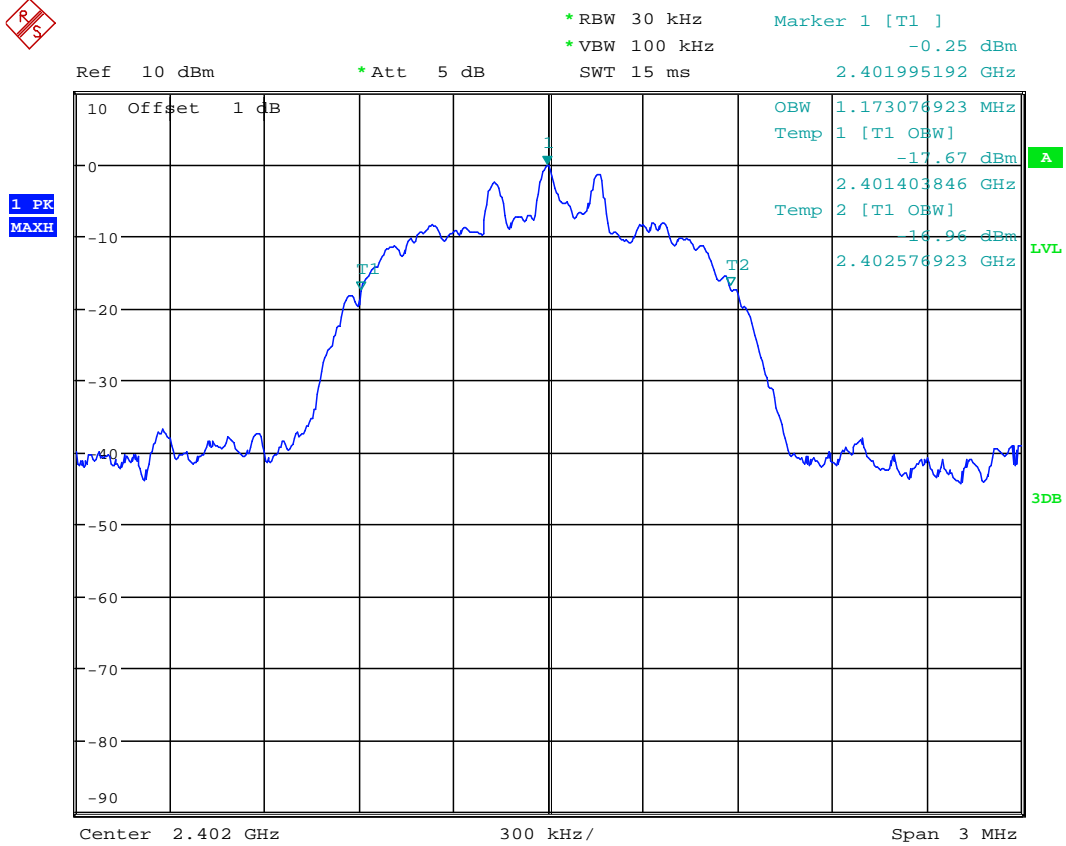
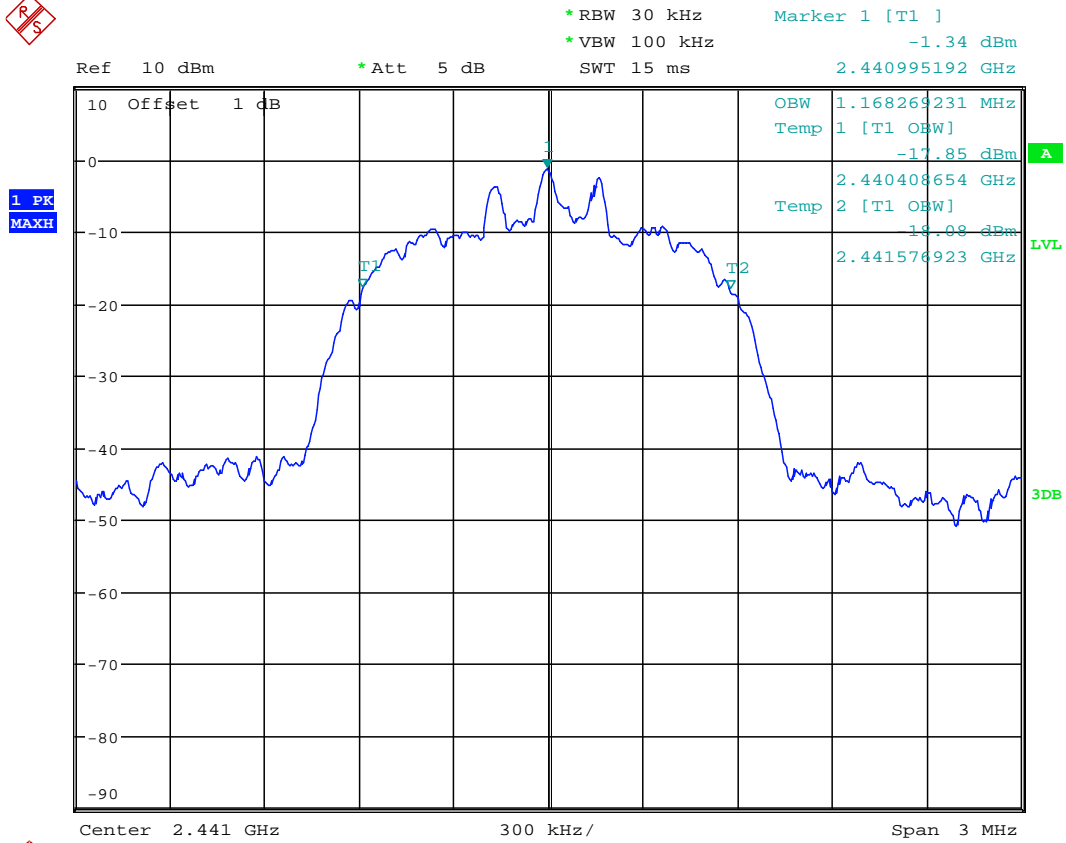

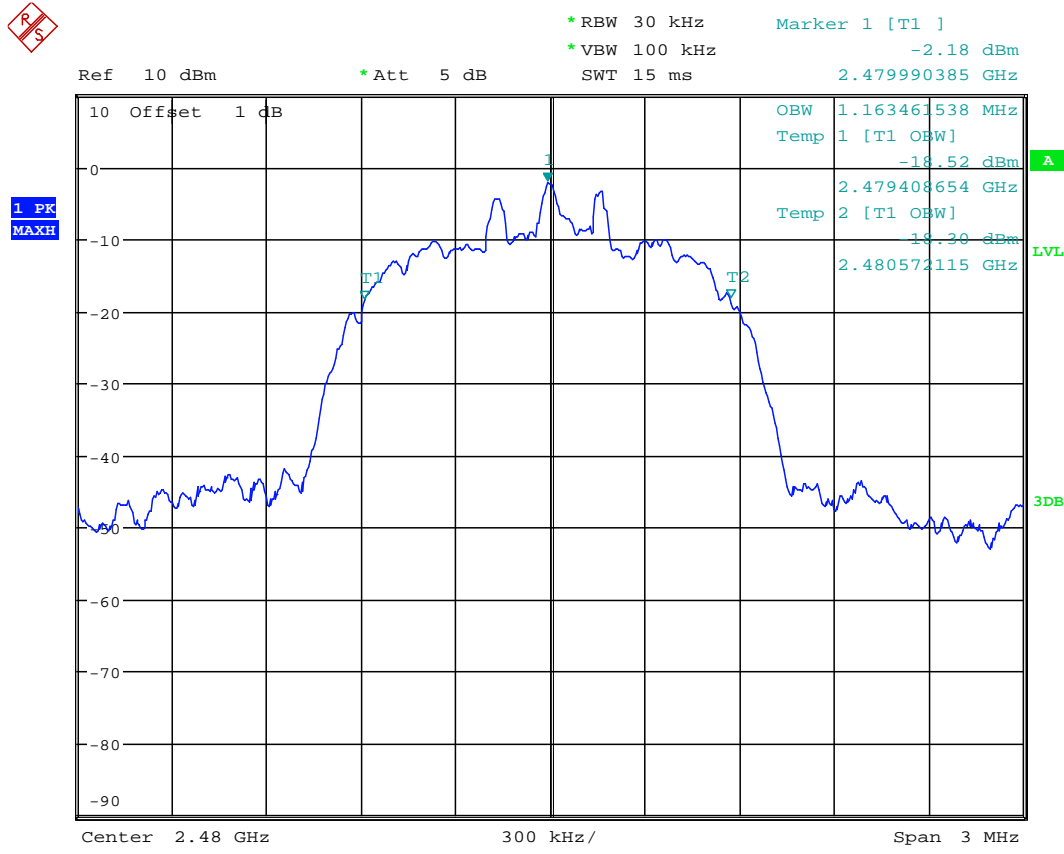

5. Carrier Frequency Separation

5.1. Test equipment

Item	Equipment	Manufacturer	Model No.	Serial No.	Last Cal.	Cal. Interval
1	Spectrum analyzer	R&S	FSU	1166.1660.26	2014/10/25	1 Year
2	Attenuator	Mini-Circuits	BW-S10W2	101109	2014/10/25	1 Year
3	RF Cable	Micable	C10-01-01-1	100309	2014/10/25	1 Year

5.2. Block diagram of test setup

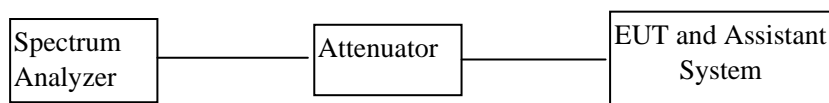

5.3. Limits

Frequency hopping systems shall have hopping channel carrier frequencies separated by a minimum of 25 kHz or the 20 dB bandwidth of the hopping channel, whichever is greater. Alternatively, frequency hopping systems operating in the 2400-2483.5 MHz band may have hopping channel carrier frequencies that are separated by 25 kHz or two-thirds of the 20 dB bandwidth of the hopping channel, whichever is greater, provided the systems operate with an output power no greater than 125 mW.

5.4. Test Procedure

- (1) Configure EUT and assistant system according clause 2.4 and 5.2
- (2) Connect EUT's antenna output to spectrum analyzer by RF cable.
- (3) Configure EUT work in test mode as stated in clause 2.4.
- (4) The carrier frequency was measured by spectrum analyzer with 100 KHz RBW and 300KHz VBW.

5.5. Test Result

EUT: Car amplifier M/N: GTR-102				
Mode	Channel separation (MHz)	20dB Bandwidth (MHz)	Limit (MHz) 2/3 of 20dB bandwidth	Conclusion
GFSK	1.02	0.875	0.583	PASS
8-DPSK	1	1.284	0.856	PASS
Test Date : 2015/8/14			Test Engineer : Leo	

5.6. Original test data

GFSK

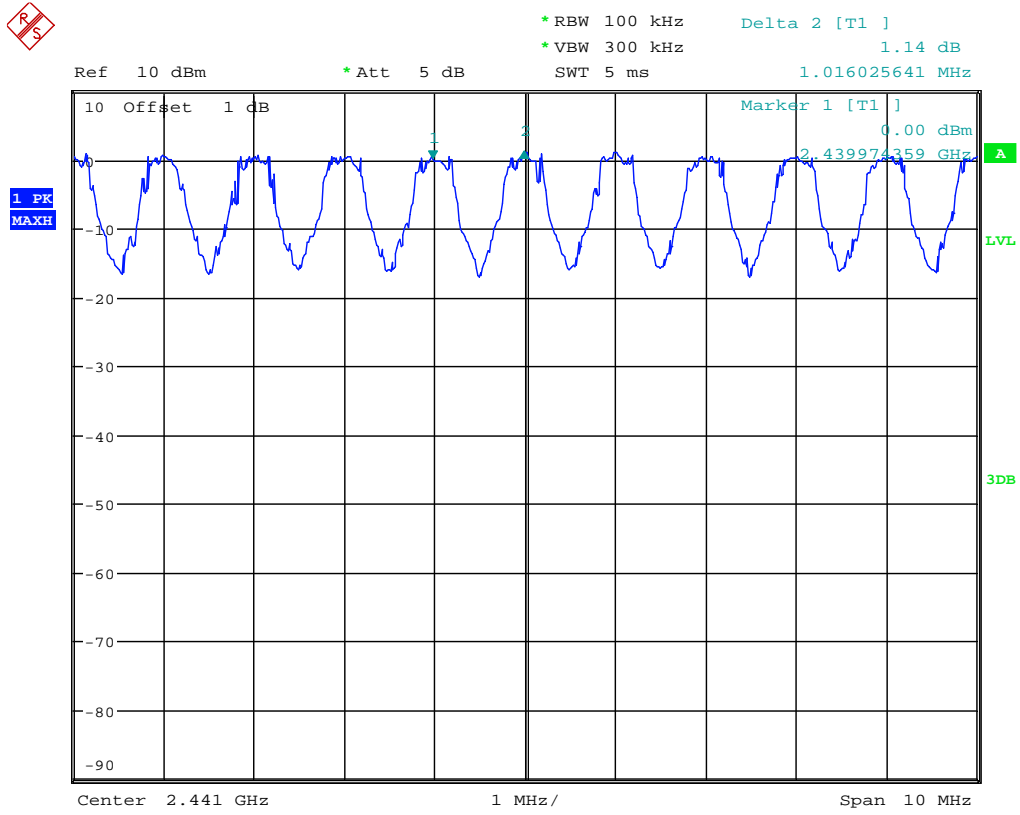

8-DPSK

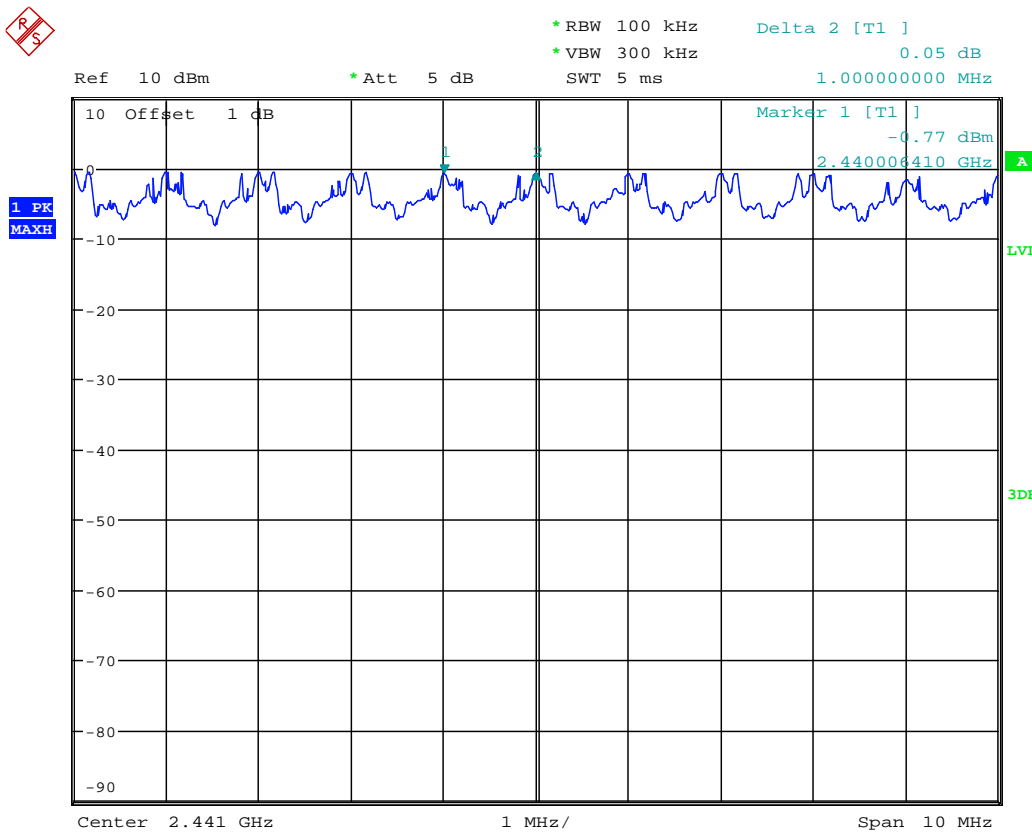

6. Number Of Hopping Channel

6.1. Test equipment

Item	Equipment	Manufacturer	Model No.	Serial No.	Last Cal.	Cal. Interval
1	Spectrum analyzer	R&S	FSU	1166.1660.26	2014/10/25	1 Year
2	Attenuator	Mini-Circuits	BW-S10W2	101109	2014/10/25	1 Year
3	RF Cable	Micable	C10-01-01-1	100309	2014/10/25	1 Year

6.2. Block diagram of test setup

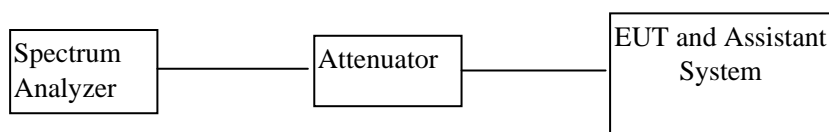

6.3. Limits

Frequency hopping systems in the 2400-2483.5 MHz band shall use at least 15 channels.

6.4. Test Procedure

- (1) Configure EUT and assistant system according clause 2.4 and 6.2
- (2) Connect EUT's antenna output to spectrum analyzer by RF cable.
- (3) Configure EUT work in test mode as stated in clause 2.4.
- (4) The number of hopping channel was measured by spectrum analyzer with 100 kHz RBW and 300KHz VBW.

6.5. Test Result

EUT: Car amplifier		M/N: GTR-102	
Mode	Number of hopping channel	Limit	Conclusion
GFSK	79	>15	PASS
8-DPSK	79	>15	PASS
Test Date : 2015/8/14		Test Engineer : Leo	

6.6. Original test data

GFSK:

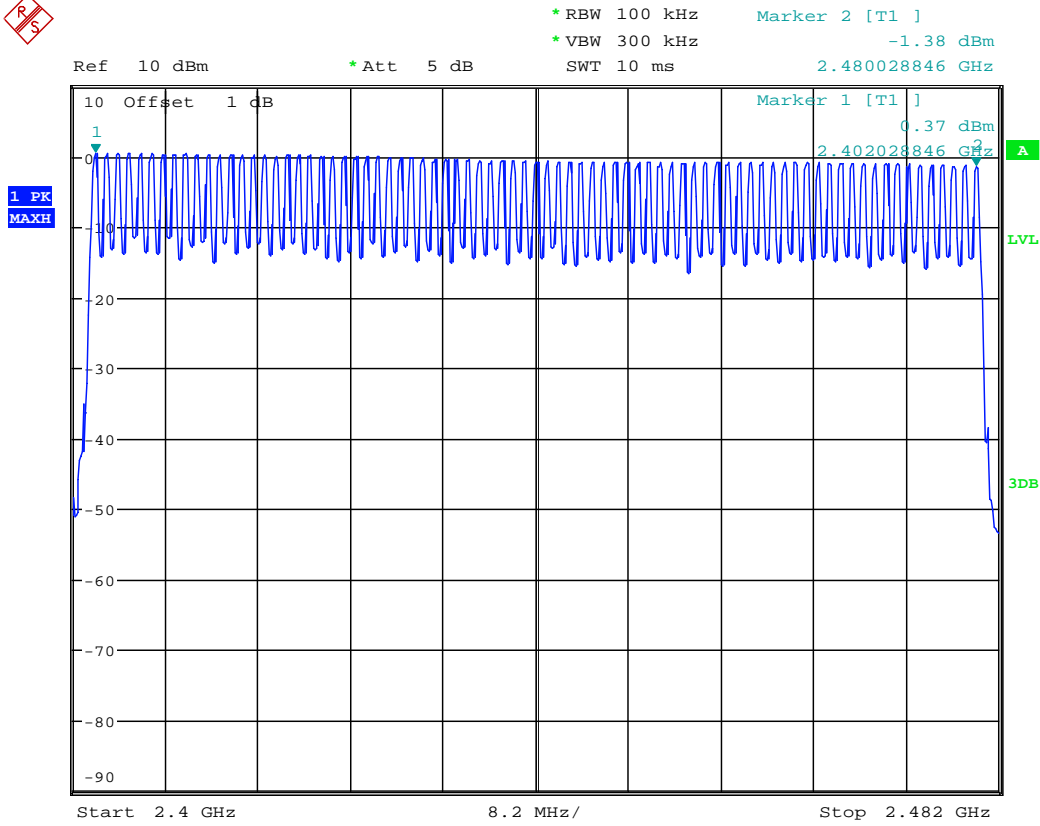

8-DPSK:

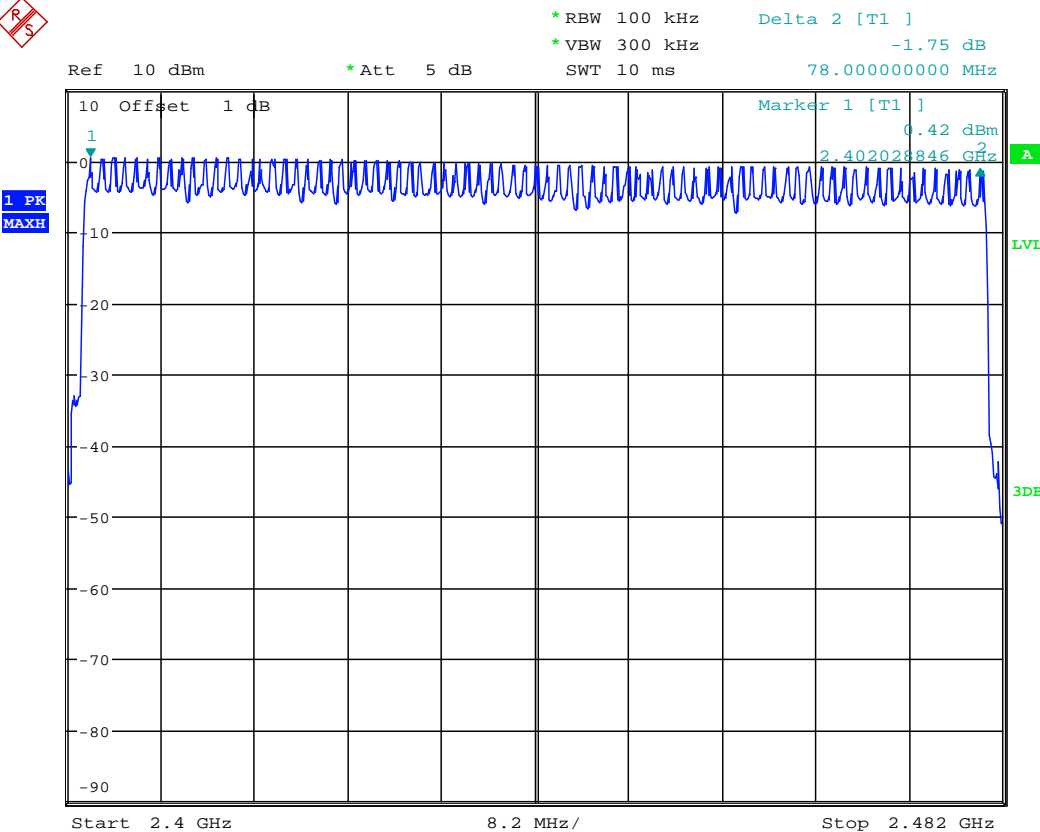

7. Dwell Time

7.1. Test equipment

Item	Equipment	Manufacturer	Model No.	Serial No.	Last Cal.	Cal. Interval
1	Spectrum analyzer	R&S	FSU	1166.1660.26	2014/10/25	1 Year
2	Attenuator	Mini-Circuits	BW-S10W2	101109	2014/10/25	1 Year
3	RF Cable	Micable	C10-01-01-1	100309	2014/10/25	1 Year

7.2. Block diagram of test setup

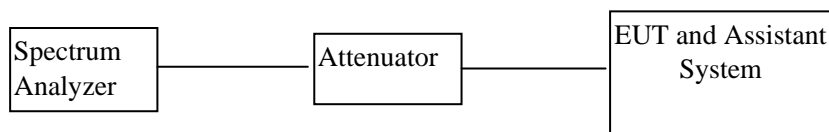

7.3. Limits

The average time of occupancy on any channel shall not be greater than 0.4 seconds within a period of 0.4 seconds multiplied by the number of hopping channels employed.

7.4. Test Procedure

- (1) Configure EUT and assistant system according clause 2.3 and 7.2
- (2) Connect EUT's antenna output to spectrum analyzer by RF cable.
- (3) Configure EUT work in test mode as stated in clause 2.3.
- (4) Measure the hopping number and on time of each pulse with spectrum analyzer in zero span set, and calculate dwell time with formula Dwell time = total hops *pulse's on time.

DH1 Packet permit maximum $1600 / 79 / 2 = 10.12$ hops per second in each channel (1 time slot RX, 1 time slot TX). So, total hops is $10.12 \times 31.6 = 320$.

DH3 Packet permit maximum $1600 / 79 / 4 = 5.06$ hops per second in each channel (3 time slots RX, 1 time slot TX). So, total hops is $5.06 \times 31.6 = 160$.

DH5 Packet permit maximum $1600 / 79 / 6 = 3.37$ hops per second in each channel (5 time slots RX, 1 time slot TX). So, total hops is $3.37 \times 31.6 = 106.6$.

3DH1 Packet permit maximum $1600 / 79 / 2 = 10.12$ hops per second in each channel (1 time slot RX, 1 time slot TX). So, total hops is $10.12 \times 31.6 = 320$.

3DH3 Packet permit maximum $1600 / 79 / 4 = 5.06$ hops per second in each channel (3 time slots RX, 1 time slot TX). So, total hops is $5.06 \times 31.6 = 160$.

3DH5 Packet permit maximum $1600 / 79 / 6 = 3.37$ hops per second in each channel (5 time slots RX, 1 time slot TX). So, total hops is $3.37 \times 31.6 = 106.6$.

7.5. Test Result

EUT: Car amplifier			M/N: GTR-102		
Mode	Dwell time	Pulse's on time	Total hops	Limit	Conclusion
DH1	127.68ms	0.399ms	320	<400ms	PASS
DH3	265.44ms	1.659ms	160	<400ms	PASS
DH5	309.25ms	2.901ms	106.6	<400ms	PASS
3-DH1	131.84ms	0.412ms	320	<400ms	PASS
3-DH3	266.08ms	1.663ms	160	<400ms	PASS
3-DH5	308.39ms	2.893ms	106.6	<400ms	PASS
Test Date : 2015/8/14			Test Engineer : Leo		
Note: Dwell time = total hops *pulse's on time.					

7.6. Original test data

DH1



RBW 1 MHz Marker 1 [T1]
* VBW 1 MHz -0.98 dBm
Ref 10 dBm * Att 5 dB SWT 1 ms 399.038462 μ s

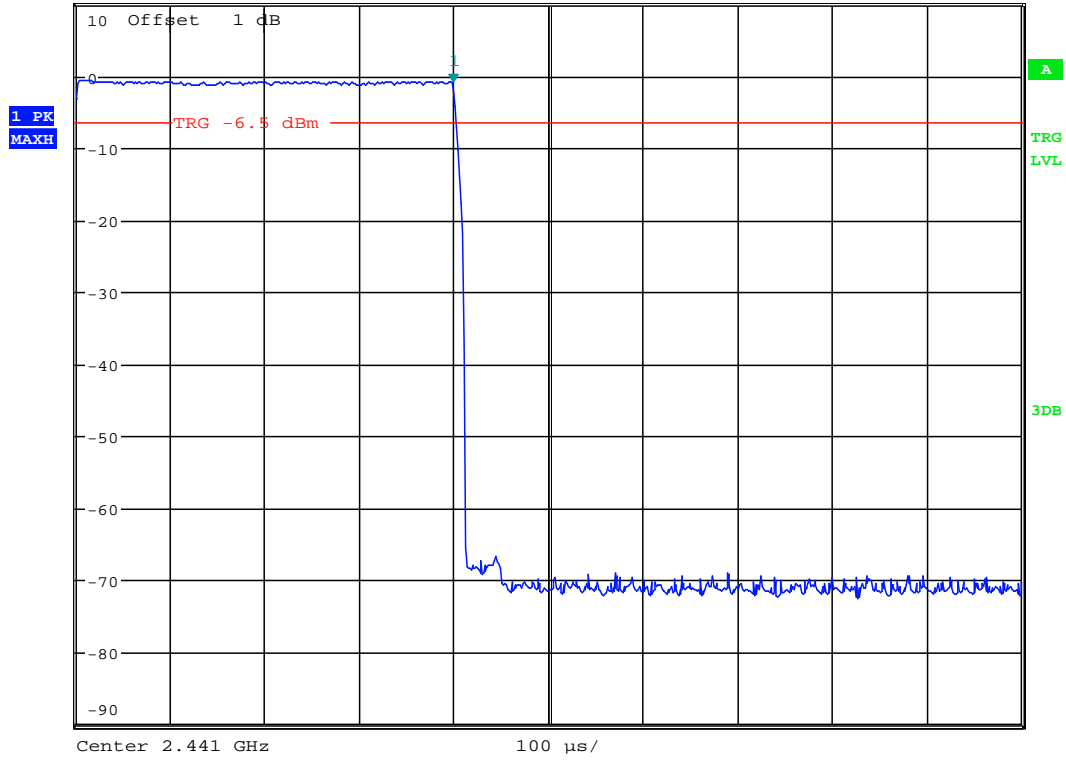

DH3



RBW 1 MHz Marker 1 [T1]
* VBW 1 MHz -0.92 dBm
Ref 10 dBm * Att 5 dB SWT 3 ms 1.658654 ms

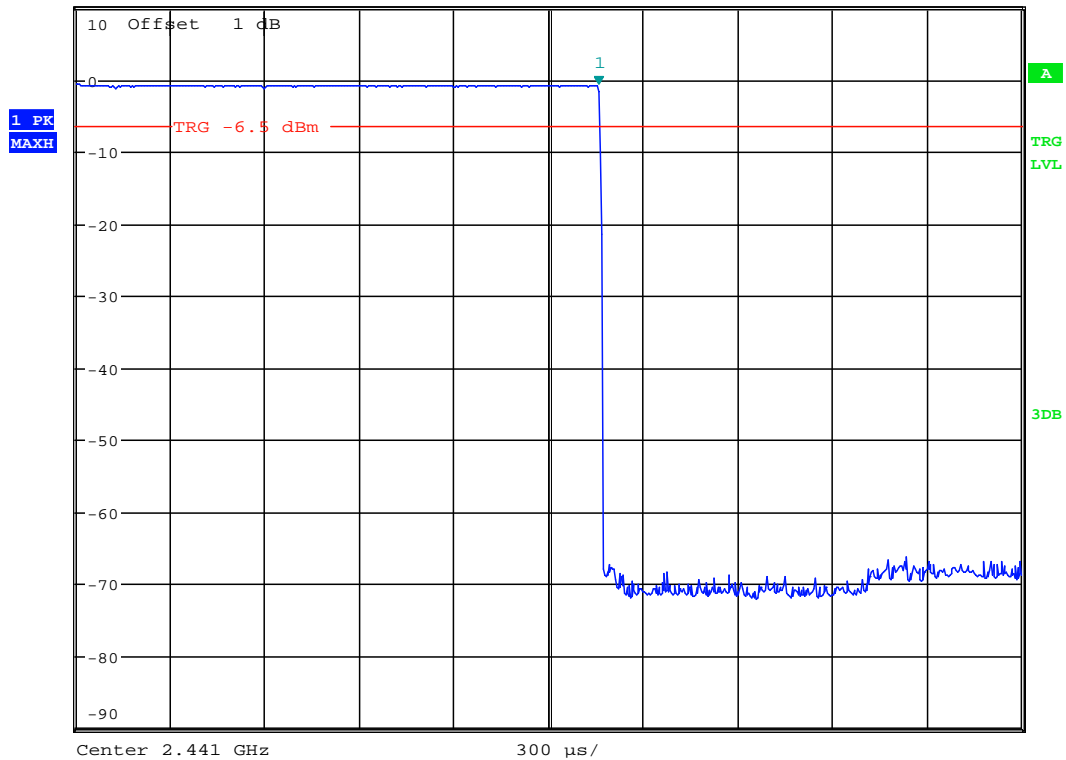

DH5

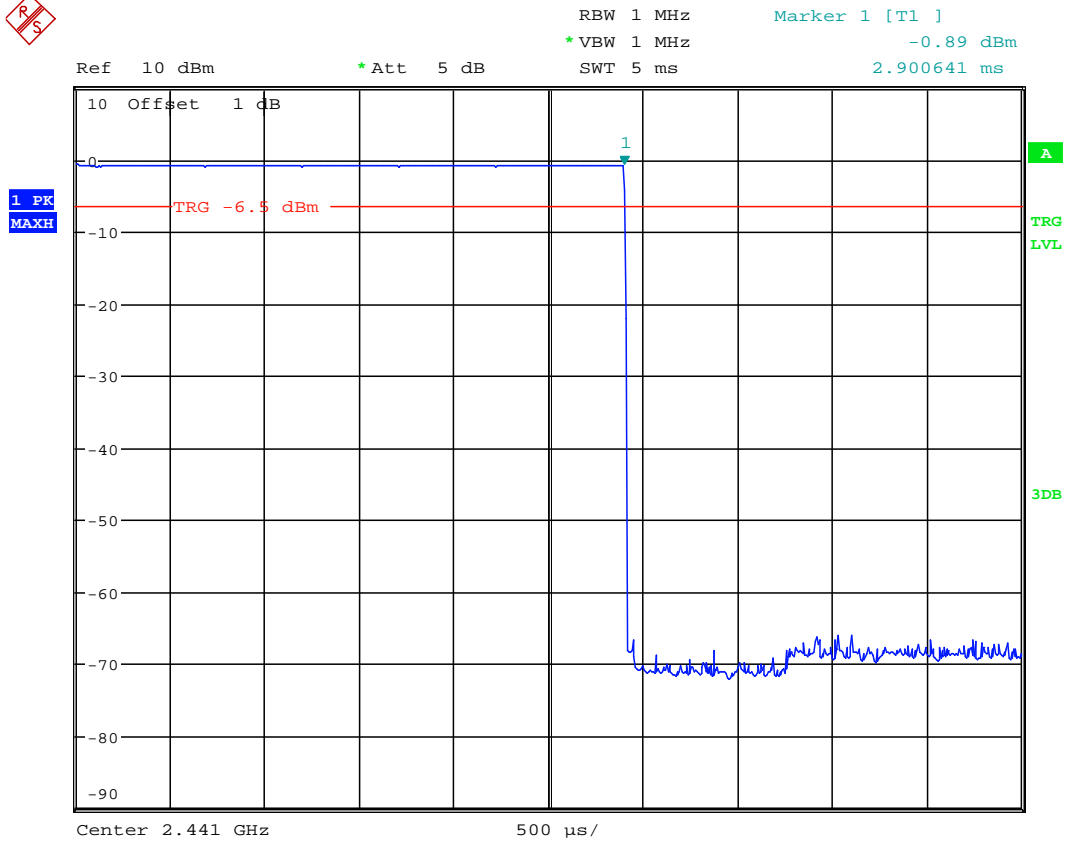

3-DH1

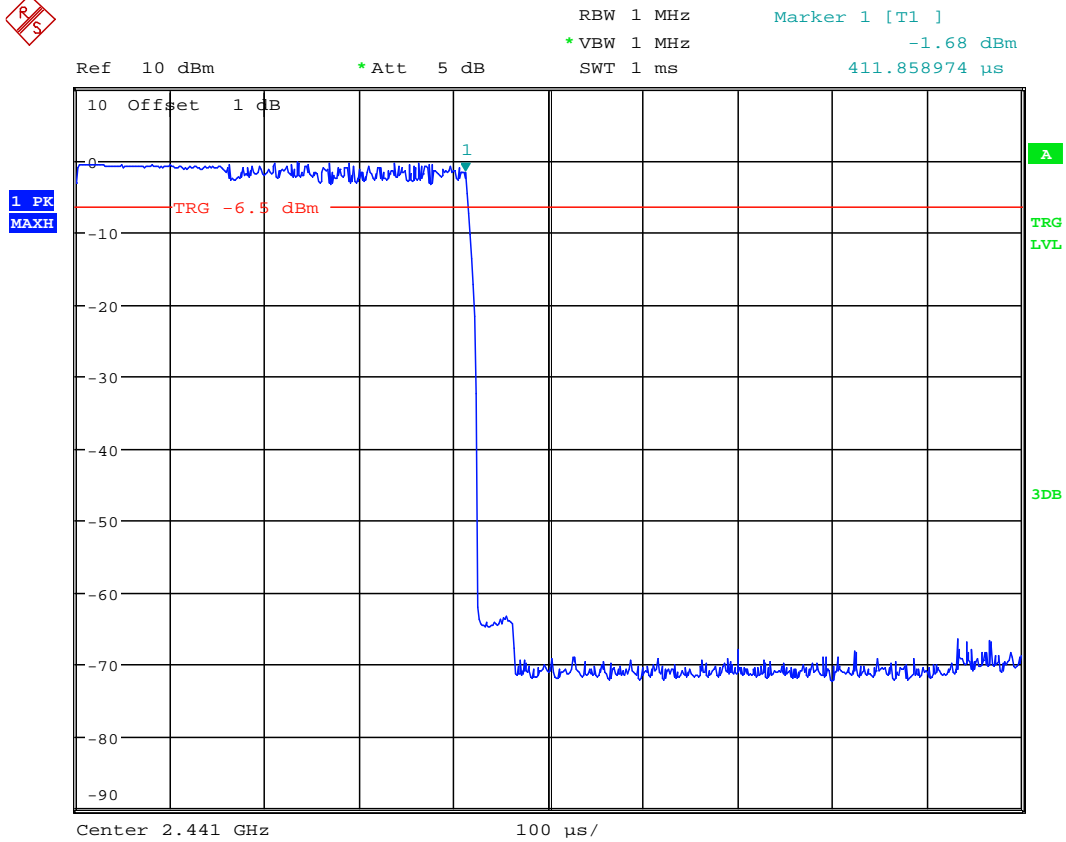

3-DH3

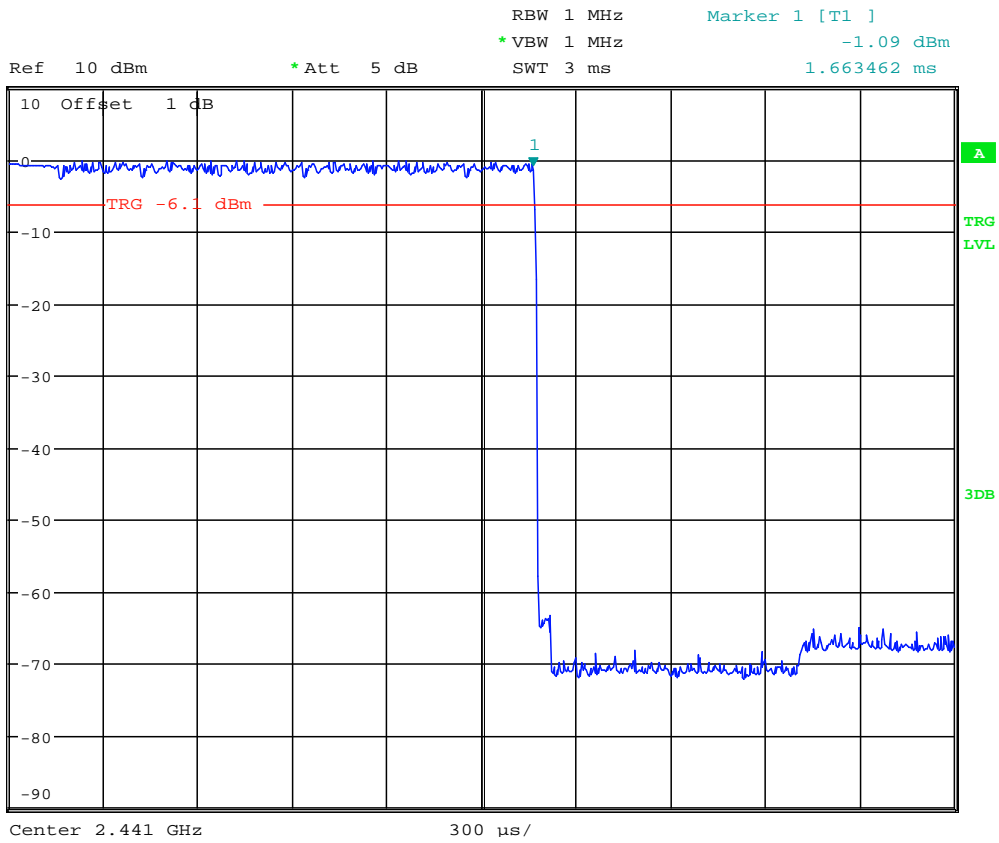

3-DH5

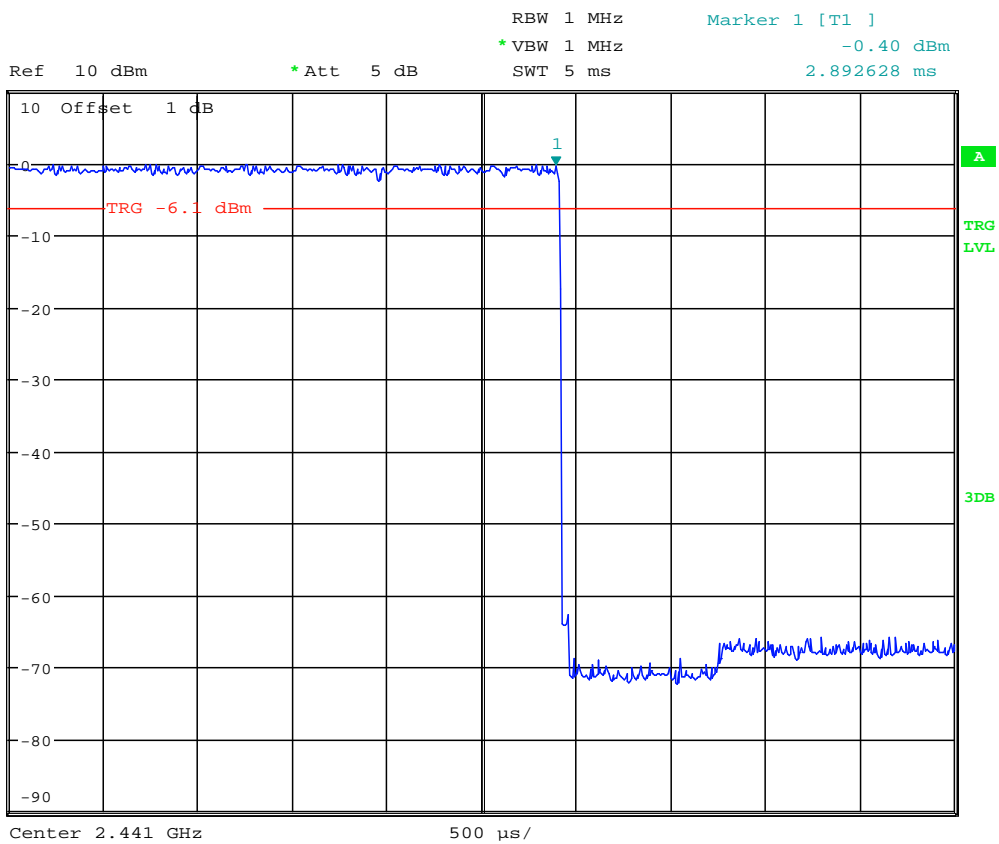

8. Radiated emission

8.1. Test equipment

Item	Equipment	Manufacturer	Model No.	Serial No.	Last Cal.	Cal. Interval
1	EMI Test Receiver	R&S	ESU8	100316	2014/10/25	1 Year
2	Spectrum analyzer	R&S	FSU	1166.1660.26	2014/10/25	1 Year
3	Loop antenna	TESEQ	HLA6120	20129	2015/05/30	1 Year
4	Trilog Broadband Antenna	Schwarzbeck	VULB9163	9163-462	2015/05/30	1 Year
5	Double Ridged Horn Antenna	R&S	HF907	100276	2014/11/01	1 Year
6	Horn Antenna	EMCO	3116	00060095	2015/05/30	1 Year
7	Pre-amplifier	A.H.	PAM-1840VH	562	2014/10/25	1 Year
8	RF Cable	R&S	R01	10403	2014/10/25	1 Year
9	RF Cable	R&S	R02	10512	2014/10/25	1 Year
10	Test software	Audix	E3	V 6.11111b	/	/

8.2. Block diagram of test setup

In 3m Anechoic Chamber Test Setup Diagram for 9KHz-30MHz

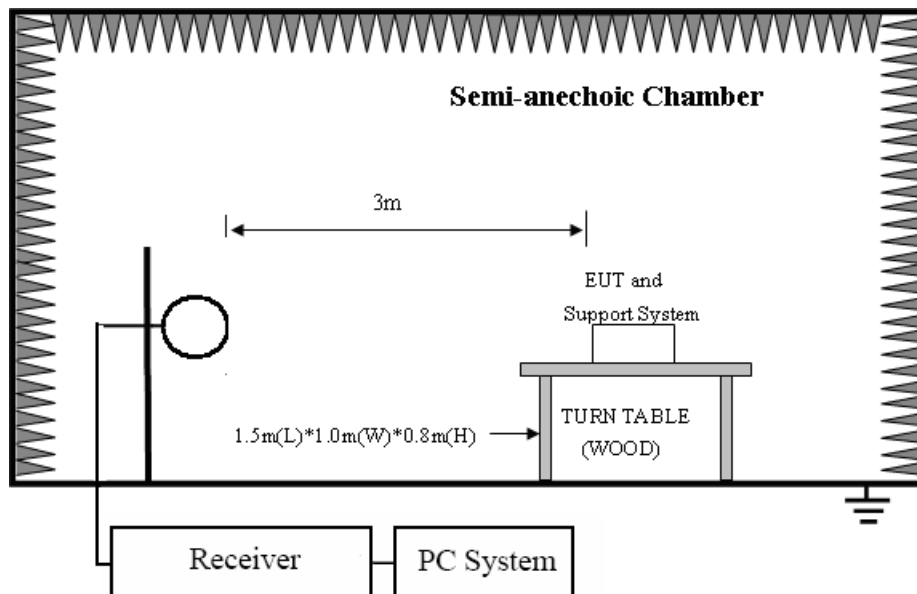

In 3m Anechoic Chamber Test Setup Diagram for below 1GHz

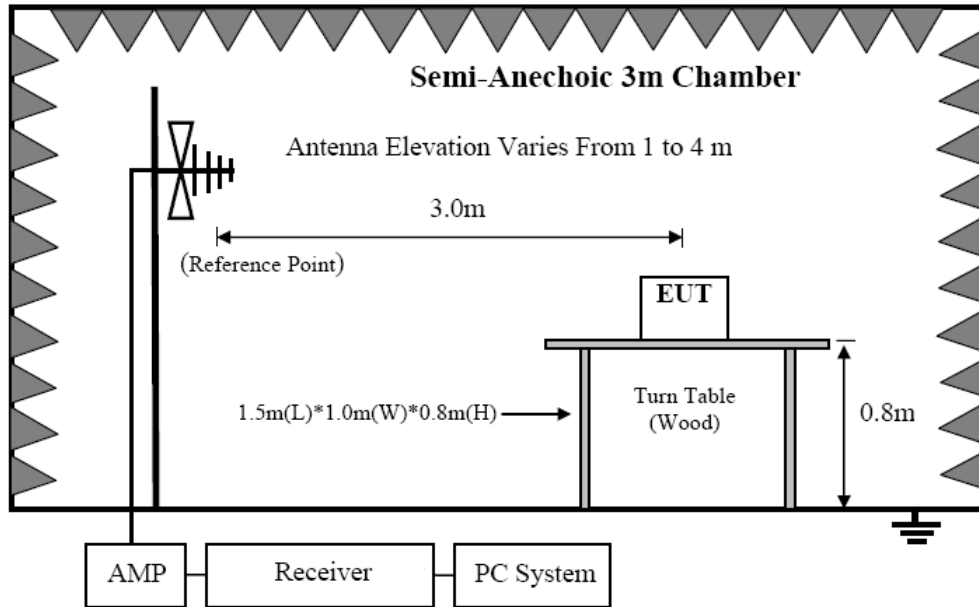

In 3m Anechoic Chamber Test Setup Diagram for frequency above 1GHz

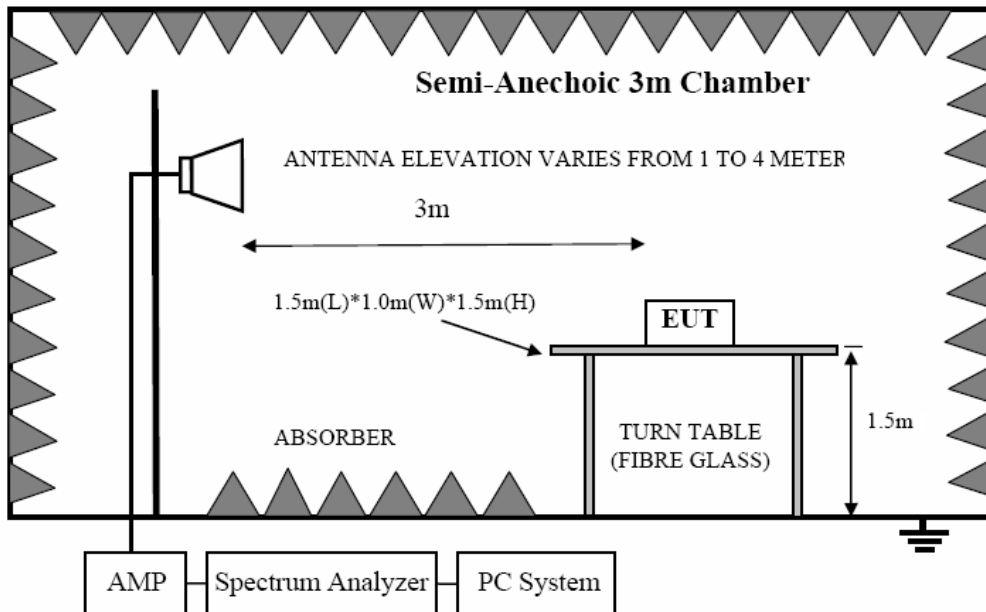

Note: For harmonic emissions test a appropriate high pass filter was inserted in the input port of AMP.

8.3. Limit

8.3.1 FCC 15.205 Restricted frequency band

MHz	MHz	MHz	GHz
0.090 - 0.110	16.42 - 16.423	399.9 - 410	4.5 - 5.15
¹ 0.495 - 0.505	16.69475 - 16.69525	608 - 614	5.35 - 5.46
2.1735 - 2.1905	16.80425 - 16.80475	960 - 1240	7.25 - 7.75
4.125 - 4.128	25.5 - 25.67	1300 - 1427	8.025 - 8.5
4.17725 - 4.17775	37.5 - 38.25	1435 - 1626.5	9.0 - 9.2
4.20725 - 4.20775	73 - 74.6	1645.5 - 1646.5	9.3 - 9.5
6.215 - 6.218	74.8 - 75.2	1660 - 1710	10.6 - 12.7
6.26775 - 6.26825	108 - 121.94	1718.8 - 1722.2	13.25 - 13.4
6.31175 - 6.31225	123 - 138	2200 - 2300	14.47 - 14.5
8.291 - 8.294	149.9 - 150.05	2310 - 2390	15.35 - 16.2
8.362 - 8.366	156.52475 - 156.52525	2483.5 - 2500	17.7 - 21.4
8.37625 - 8.38675	156.7 - 156.9	2690 - 2900	22.01 - 23.12
8.41425 - 8.41475	162.0125 - 167.17	3260 - 3267	23.6 - 24.0
12.29 - 12.293	167.72 - 173.2	3332 - 3339	31.2 - 31.8
12.51975 - 12.52025	240 - 285	3345.8 - 3358	36.43 - 36.5
12.57675 - 12.57725	322 - 335.4	3600 - 4400	(²)

8.3.2 FCC 15.209 Limit.

FREQUENCY MHz	DISTANCE Meters	FIELD STRENGTHS LIMIT	
		μV/m	dB(μV)/m
0.009 ~ 0.490	300	2400/F(KHz)	67.6-20log(F)
0.490 ~ 1.705	30	24000/F(KHz)	87.6-20log(F)
1.705 ~ 30.0	30	30	29.54
30 ~ 88	3	100	40.0
88 ~ 216	3	150	43.5
216 ~ 960	3	200	46.0
960 ~ 1000	3	500	54.0
Above 1000	3	74.0 dB(μV)/m (Peak) 54.0 dB(μV)/m (Average)	

Note: (1)The emission limits shown in the above table are based on measurements employing a CISPR QP detector except for the frequency bands 9-90KHz, 110-490KHz and above 1000MHz. Radiated emissions limits in these three bands are based on measurements employing an average detector.

(2) At frequencies below 30MHz, measurement may be performed at a distance closer then that specified, and the limit at closer measurement distance can be extrapolated by below formula:

$$\text{Limit}_{3m}(\text{dBuV/m}) = \text{Limit}_{30m}(\text{dBuV/m}) + 40\text{Log}(30m/3m)$$

8.3.3 Limit for this EUT

All the emissions appearing within 15.205 restricted frequency bands shall not exceed the limits shown in 15.209, all the other emissions shall be at least 20dB below the fundamental emissions, or comply with 15.209 limits.

8.4. Test Procedure

- (1) EUT was placed on a non-metallic table, 150 cm above the ground plane inside a semi-anechoic chamber.
- (2) Setup EUT and assistant system according clause 2.4 and 8.2
- (3) Test antenna was located 3m from the EUT on an adjustable mast, and the antenna used as below table.

Test frequency range	Test antenna used
9KHz-30MHz	Active Loop antenna
30MHz-1GHz	Trilog Broadband Antenna
1GHz-18GHz	Double Ridged Horn Antenna(1GHz-18GHz)
18GHz-40GHz	Horn Antenna(18GHz-40GHz)

According ANSI C63.10:2013 clause 6.4.4.2 and 6.5.3, for measurements below 30 MHz, the loop antenna was positioned with its plane vertical from the EUT and rotated about its vertical axis for maximum response at each azimuth position around the EUT. And the loop antenna also be positioned with its plane horizontal at the specified distance from the EUT. The center of the loop is 1 m above the ground. for measurement above 30MHz, the Trilog Broadband Antenna or Horn Antenna was located 3m from EUT, Measurements were made with the antenna positioned in both the horizontal and vertical planes of Polarization, and the measurement antenna was varied from 1 m to 4 m. in height above the reference ground plane to obtain the maximum signal strength.

- (4) Below pre-scan procedure was first performed in order to find prominent frequency spectrum radiated emissions from 9KHz to 25GHz:

- (a) Scanning the peak frequency spectrum with the antenna specified in step (3), and the EUT was rotated 360 degree, the antenna height was varied from 1m to 4m(Except loop antenna, it's fixed 1m above ground.)

- (b) Change work frequency or channel of device if practicable.

- (c) Change modulation type of device if practicable.

- (d) Change power supply range from 85% to 115% of the rated supply voltage

- (e) Rotated EUT though three orthogonal axes to determine the attitude of EUT arrangement produces highest emissions.

Spectrum frequency from 9KHz to 25GHz (tenth harmonic of fundamental frequency) was investigated, and no any obvious emission were detected from 18GHz to 25GHz, so below final test was performed with frequency range from 9KHz to 18GHz.

- (5) For final emissions measurements at each frequency of interest, the EUT was rotated and the antenna height was varied between 1m and 4m in order to maximize the emission. Measurements in both horizontal and vertical polarities were made and the data was recorded. In order to find the maximum emission, the relative positions of equipments and all of the interface cables were changed according to ANSI C63.10 2013 on Radiated Emission test.
- (6) The emissions from 9KHz to 1GHz were measured based on CISPR QP detector except for the

frequency bands 9-90KHz, 110-490KHz, for emissions from 9KHz-90KHz,110KHz-490KHz and above 1GHz were measured based on average detector, for emissions above 1GHz, peak emissions also be measured and need comply with Peak limit.

- (7) The emissions from 9KHz to 1GHz, QP or average values were measured with EMI receiver with below RBW

Frequency band	RBW
9KHz-150KHz	200Hz
150KHz-30MHz	9KHz
30MHz-1GHz	120KHz

- (8) For emissions above 1GHz, both Peak and Average level were measured with Spectrum Analyzer, and the RBW is set at 1MHz, VBW is set at 3MHz for Peak measure; RMS detector RBW 1MHz VBW 3MHz for Average measure(according ANSI C63.10:2013 clause 4.2.3.2.3 procedure for average measure).

- (9) X axis, Y axis, Z axis are tested, and worse setup X axis is reported.

8.5. Test result

PASS. (See below detailed test result)

All the emissions except fundamental emission from 9 KHz to 25GHz were comply with 8.3.2 limit.

Note1: According exploratory test no any obvious emission were detected from 9KHz to 30MHz and 18GHz to 25GHz, so the final test was performed with frequency range from 30MHz to 18GHz and recorded in below.

Note2: For emissions below 1GHz, according exploratory explorer test, when change Tx mode and channel, have no distinct influence on emissions level, so for emissions below 1GHz, the final test was only performed with EUT working in GFSK, Tx 2441MHz mode.

Note3: For emissions above 1GHz. If peak results comply with AV limit, AV Result is deemed to comply with AV limit.

Radiated Emission test (below 1GHz)

TR-4-E-009 Radiated Emission Test Result

Test Site	: DDT 3m Chamber	E:\2015 Report Data\15Q0807-2\RE.EM6
Test Date	: 2015-08-15	Tested By : Jerry
EUT	: Car amplifier	Model Number : GTR-102
Power Supply	: DC 12V	Test Mode : Tx mode
Condition	: Temp:24.5'C,Humi:55%, Press:100.1kPa	Antenna/Distance : 2014 VULB 9163/3m/VERTICAL
Memo	:	

Data: 1

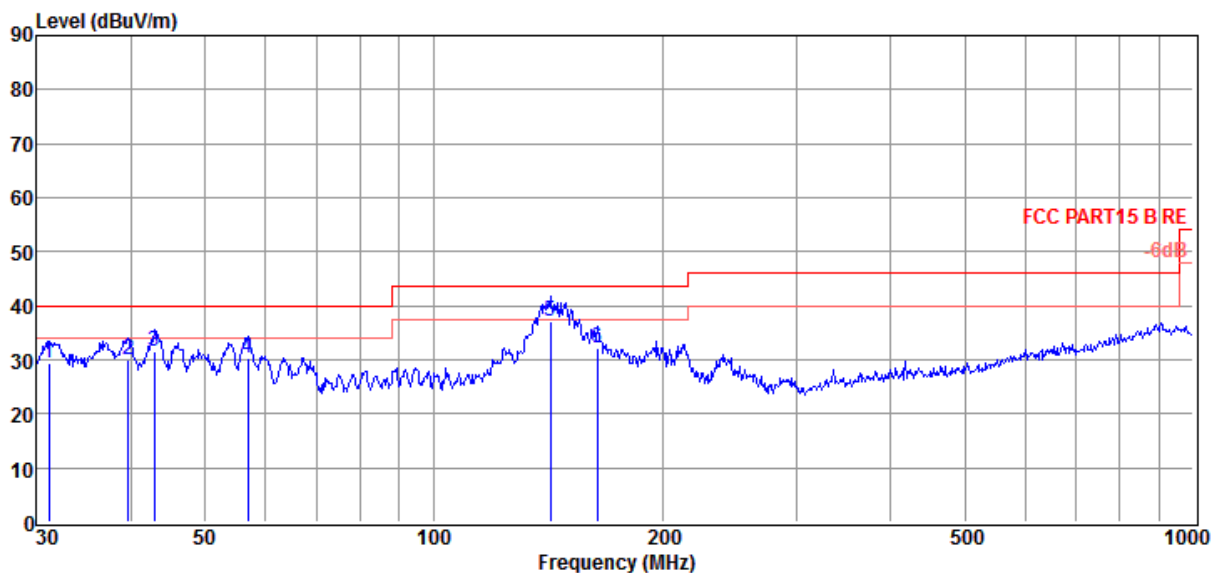

Item (Mark)	Freq (MHz)	Read Level (dBμV)	Antenna Factor (dB/m)	Cable Loss (dB)	Result Level (dBμV/m)	Limit Line (dBμV/m)	Over Limit (dB)	Detector	Polarization
1	31.18	16.58	11.95	0.92	29.45	40.00	-10.55	QP	VERTICAL
2	39.58	14.96	14.00	0.99	29.95	40.00	-10.05	QP	VERTICAL
3	42.90	15.61	14.90	1.02	31.53	40.00	-8.47	QP	VERTICAL
4	56.99	15.41	13.90	1.11	30.42	40.00	-9.58	QP	VERTICAL
5	142.32	26.50	8.83	1.71	37.04	43.50	-6.46	QP	VERTICAL
6	164.33	21.47	8.63	1.98	32.08	43.50	-11.42	QP	VERTICAL

Note: 1. Result Level = Read Level + Antenna Factor + Cable loss.
 2. If Peak Result complies with QP limit, QP Result is deemed to comply with QP limit.
 3. Test setup: RBW: 120 kHz, VBW: 300 kHz, Sweep time: auto.

TR-4-E-009 Radiated Emission Test Result

Test Site	: DDT 3m Chamber	E:\2015 Report Data\15Q0807-2\RE.EM6	
Test Date	: 2015-08-15	Tested By	: Jerry
EUT	: DC 12V	Model Number	: GTR-102
Power Supply	: DC 12V	Test Mode	: Tx mode
Condition	: Temp:24.5'C,Humi:55%, Press:100.1kPa	Antenna/Distance	: 2014 VULB 9163/3m/HORIZONTAL
Memo	:		

Data: 2

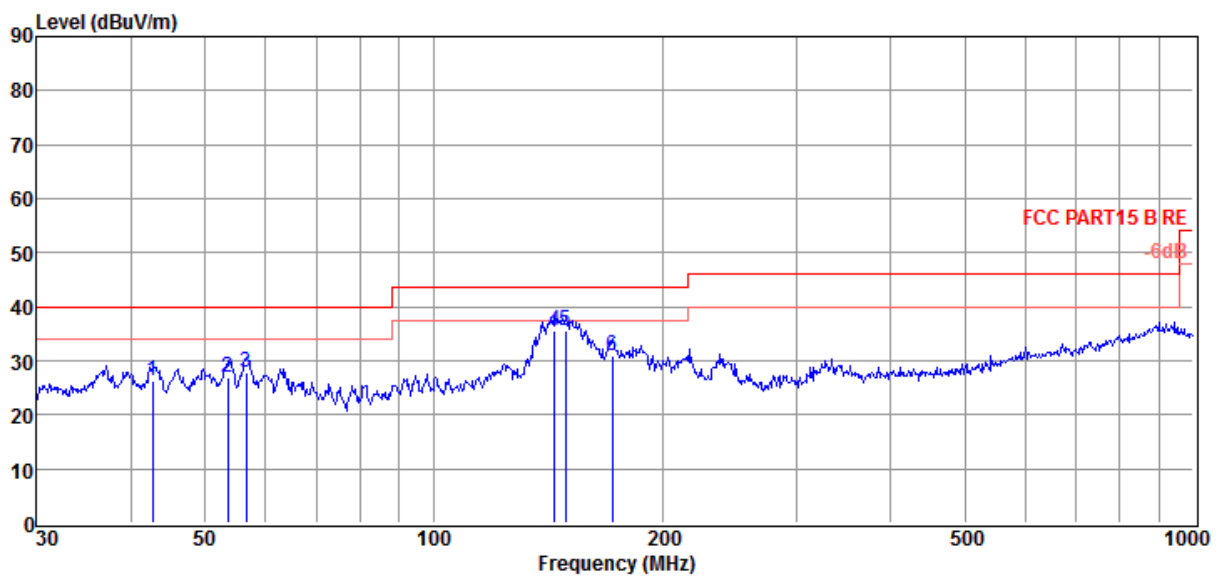

Item (Mark)	Freq (MHz)	Read Level (dBμV)	Antenna Factor (dB/m)	Cable Loss dB	Result Level (dBμV/m)	Limit Line (dBμV/m)	Over Limit (dB)	Detector	Polarization
1	42.60	10.29	14.90	1.02	26.21	40.00	-13.79	QP	HORIZONTAL
2	53.51	11.57	14.20	1.09	26.86	40.00	-13.14	QP	HORIZONTAL
3	56.59	12.72	13.90	1.11	27.73	40.00	-12.27	QP	HORIZONTAL
4	144.34	25.01	8.75	1.73	35.49	43.50	-8.01	QP	HORIZONTAL
5	148.96	25.00	8.67	1.80	35.47	43.50	-8.03	QP	HORIZONTAL
6	172.00	20.05	8.83	2.03	30.91	43.50	-12.59	QP	HORIZONTAL

- Note: 1. Result Level = Read Level + Antenna Factor + Cable loss.
 2. If Peak Result complies with QP limit, QP Result is deemed to comply with QP limit.
 3. Test setup: RBW: 120 kHz, VBW: 300 kHz, Sweep time: auto.

Radiated Emission test (above 1GHz)

Freq (MHz)	Read level (dB μ V)	Antenna Factor (dB/m)	PRM Factor (dB)	Cable Loss (dB)	Result Level (dB μ V/m)	Limit (dB μ V/m)	Margin (dB)	Detector type	Polarization
GFSK Tx mode 2402MHz									
4804.00	33.67	35.40	29.13	8.09	48.03	74.00	-25.97	Peak	HORIZONTAL
8089.00	35.35	37.53	31.28	10.39	51.99	74.00	-22.01	Peak	HORIZONTAL
8769.00	35.49	37.75	32.28	10.53	51.49	74.00	-22.51	Peak	HORIZONTAL
4804.00	31.97	35.40	29.13	8.09	46.33	74.00	-27.67	Peak	VERTICAL
7562.00	33.64	37.41	30.42	10.15	50.78	74.00	-23.22	Peak	VERTICAL
13461.00	33.92	40.16	35.42	12.98	51.64	74.00	-22.36	Peak	VERTICAL
GFSK Tx mode 2441MHz									
4882.00	32.68	35.51	29.08	8.14	47.25	74.00	-26.75	Peak	HORIZONTAL
6933.00	34.51	36.98	29.41	9.82	51.90	74.00	-22.10	Peak	HORIZONTAL
7409.00	34.40	37.35	30.03	10.04	51.76	74.00	-22.24	Peak	HORIZONTAL
4882.00	35.00	35.51	29.08	8.14	49.57	74.00	-24.43	Peak	VERTICAL
6933.00	33.85	36.98	29.41	9.82	51.24	74.00	-22.76	Peak	VERTICAL
7664.00	34.86	37.43	30.61	10.21	51.89	74.00	-22.11	Peak	VERTICAL
GFSK Tx mode 2480MHz									
4960.00	33.35	35.64	29.04	8.18	48.13	74.00	-25.87	Peak	HORIZONTAL
6984.00	34.60	37.07	29.42	9.84	52.09	74.00	-21.91	Peak	HORIZONTAL
11540.00	34.36	38.91	34.39	12.10	50.98	74.00	-23.02	Peak	HORIZONTAL
4960.00	32.00	35.64	29.04	8.18	46.78	74.00	-27.22	Peak	VERTICAL
7256.00	34.07	37.26	29.74	9.95	51.54	74.00	-22.46	Peak	VERTICAL
12084.00	34.89	39.12	34.58	12.33	51.76	74.00	-22.24	Peak	VERTICAL
Result: Pass									
Test Date : 2015/8/19					Test Engineer : Leo				

Note: 1.30MHz~18GHz: (Scan with GFSK, $\pi/4$ QPSK, 8-DPSK, the worst case is GFSK Mode)

2. Result Level = Read Level + Antenna Factor + Cable loss - PRM Factor.

3. Test setup: RBW: 1MHz, VBW: 3MHz, Sweep time: auto.

9. Band Edge Compliance (radiated method)

9.1. Test equipment

Item	Equipment	Manufacturer	Model No.	Serial No.	Last Cal.	Cal. Interval
1	EMI Test Receiver	R&S	ESU8	100316	2014/10/25	1 Year
2	Spectrum analyzer	R&S	FSU	1166.1660.26	2014/10/25	1 Year
3	Trilog Broadband Antenna	Schwarzbeck	VULB9163	9163-462	2015/05/30	1 Year
4	Double Ridged Horn Antenna	R&S	HF907	100276	2014/11/01	1 Year
5	Pre-amplifier	A.H.	PAM0-0118	360	2015/05/30	1 Year
6	RF Cable	R&S	R01	10403	2014/10/25	1 Year
7	RF Cable	R&S	R02	10512	2014/10/25	1 Year
8	Test software	Audix	E3	V 6.11111b	/	/

9.2. Block diagram of test setup

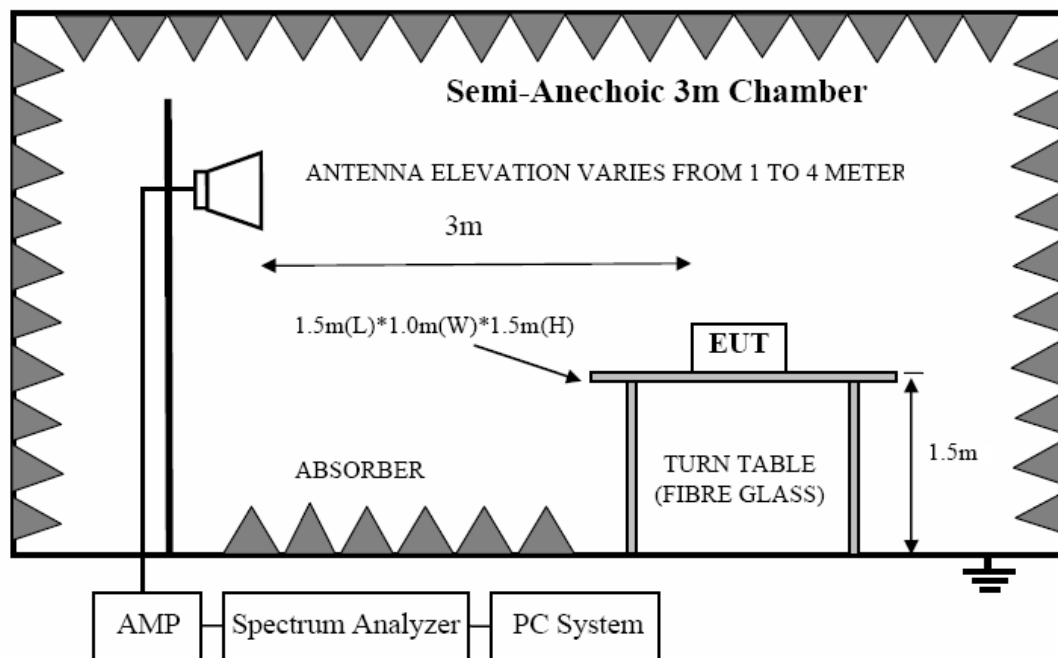

9.3. Limit

All restriction band should comply with 15.209, other emission should be at least 20dB below the fundamental.

9.4. Test Procedure

Same with clause 8.4 except change investigated frequency range from 2310MHz to 2415MHz and 2475MHz to 2500MHz.

Remark: All restriction band have been tested, and only the worse case is shown in report.

9.5. Test result

PASS. (See below detailed test result)

Remark: hopping on and hopping off mode all have been test, hopping off mode is worse and reported only.

TR-4-E-009 Radiated Emission Test Result

Test Site : DDT 3m Chamber **E:** \2015 Report Data\15Q0807-2\RF.EM6
Test Date : 2015-08-19 **Tested By** : Toby
EUT : Car amplifier **Model Number** : GTR-102
Power Supply : DC 12V **Test Mode** : Tx mode GFSK CH0
Condition : Temp:24.5'C,Humi:55%, **Antenna/Distance** : 2014 HF907/3m/HORIZONTAL
 Press:100.1kPa
Memo :

Data: 3

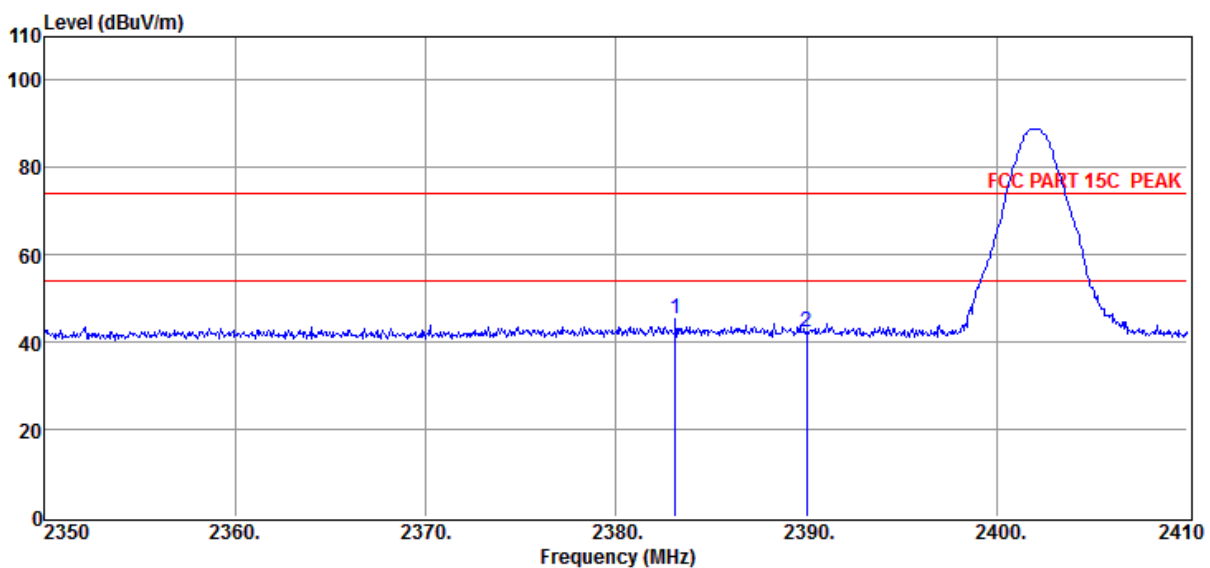

Item (Mark)	Freq (MHz)	Read Level (dBμV)	Antenna Factor (dB/m)	PRM Factor dB	Cable Loss dB	Result Level (dBμV/m)	Limit Line (dBμV/m)	Over Limit (dB)	Detector	Polarization
1	2383.12	40.48	29.94	30.21	5.17	45.38	74.00	-28.62	Peak	HORIZONTAL
2	2390.00	37.38	29.99	30.21	5.17	42.33	74.00	-31.67	Peak	HORIZONTAL

- Note: 1. Result Level = Read Level + Antenna Factor + Cable loss - PRM Factor.
 2. If Peak Result complies with AV limit, AV Result is deemed to comply with AV limit.
 3. Test setup: RBW: 1 MHz, VBW: 3 MHz, Sweep time: auto.

TR-4-E-009 Radiated Emission Test Result

Test Site : DDT 3m Chamber	E:\2015 Report Data\15Q0807-2\RF.EM6
Test Date : 2015-08-19	Tested By : Toby
EUT : Car amplifier	Model Number : GTR-102
Power Supply : DC 12V	Test Mode : Tx mode GFSK CH0
Condition : Temp:24.5'C,Humi:55%, Press:100.1kPa	Antenna/Distance : 2014 HF907/3m/VERTICAL
Memo :	

Data: 4

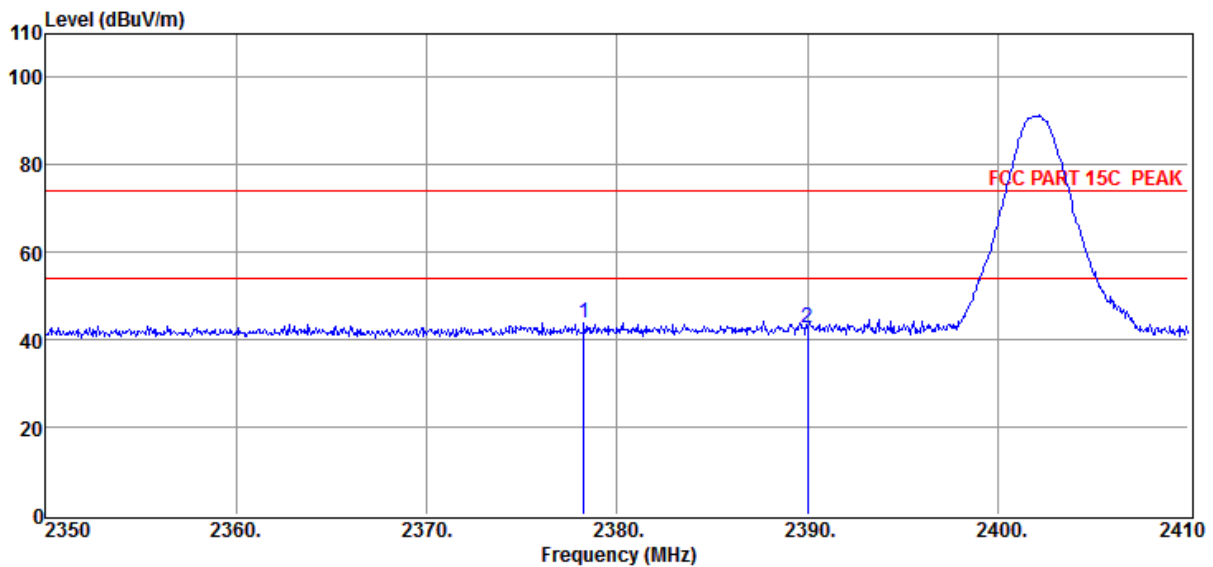

Item (Mark)	Freq (MHz)	Read Level (dBμV)	Antenna Factor (dB/m)	PRM Factor dB	Cable Loss dB	Result Level (dBμV/m)	Limit Line (dBμV/m)	Over Limit (dB)	Detector	Polarization
1	2378.26	38.90	29.94	30.21	5.17	43.80	74.00	-30.20	Peak	VERTICAL
2	2390.00	37.68	29.99	30.21	5.17	42.63	74.00	-31.37	Peak	VERTICAL

- Note: 1. Result Level = Read Level + Antenna Factor + Cable loss - PRM Factor.
 2. If Peak Result complies with AV limit, AV Result is deemed to comply with AV limit.
 3. Test setup: RBW: 1 MHz, VBW: 3 MHz, Sweep time: auto.

TR-4-E-009 Radiated Emission Test Result

Test Site	: DDT 3m Chamber	E:\2015 Report Data\15Q0807-2\RF.EM6
Test Date	: 2015-08-19	Tested By : Toby
EUT	: Car amplifier	Model Number : GTR-102
Power Supply	: DC 12V	Test Mode : Tx mode GFSK CH78
Condition	: Temp:24.5'C,Humi:55%, Press:100.1kPa	Antenna/Distance : 2014 HF907/3m/HORIZONTAL
Memo	:	

Data: 9

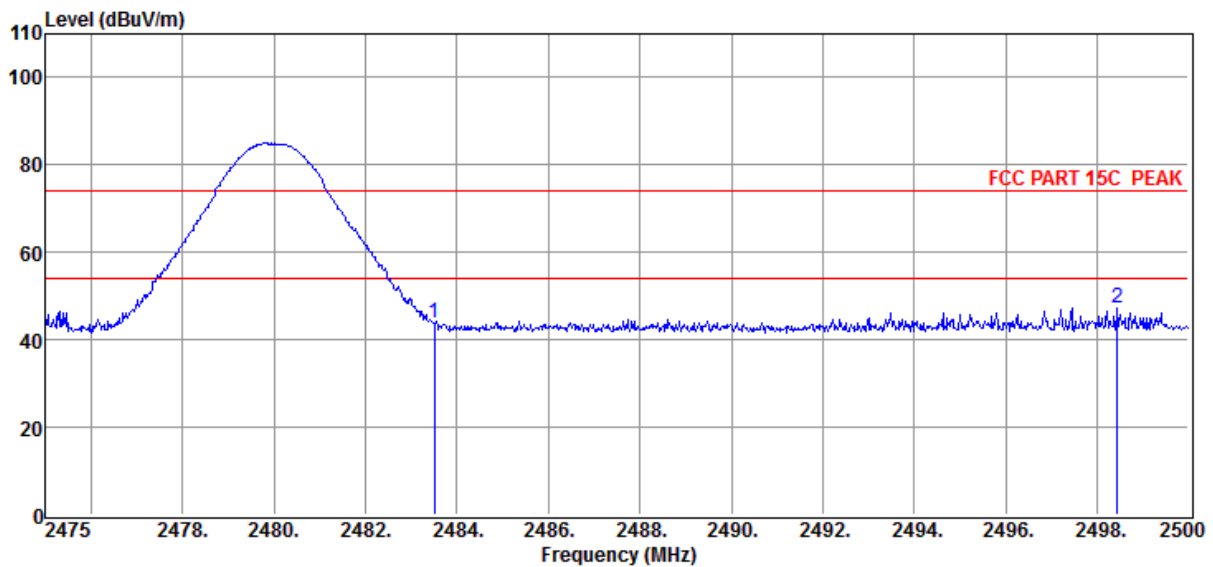

Item (Mark)	Freq (MHz)	Read Level (dBμV)	Antenna Factor (dB/m)	PRM Factor dB	Cable Loss dB	Result Level (dBμV/m)	Limit Line (dBμV/m)	Over Limit (dB)	Detector	Polarization
1	2483.50	38.52	30.25	30.25	5.31	43.83	74.00	-30.17	Peak	HORIZONTAL
2	2498.45	41.91	30.30	30.27	5.38	47.32	74.00	-26.68	Peak	HORIZONTAL

- Note: 1. Result Level = Read Level + Antenna Factor + Cable loss - PRM Factor.
 2. If Peak Result complies with AV limit, AV Result is deemed to comply with AV limit.
 3. Test setup: RBW: 1 MHz, VBW: 3 MHz, Sweep time: auto.

TR-4-E-009 Radiated Emission Test Result

Test Site : DDT 3m Chamber	E:\2015 Report Data\15Q0807-2\RF.EM6
Test Date : 2015-08-19	Tested By : Toby
EUT : Car amplifier	Model Number : GTR-102
Power Supply : DC 12V	Test Mode : Tx mode GFSK CH78
Condition : Temp:24.5'C,Humi:55%, Press:100.1kPa	Antenna/Distance : 2014 HF907/3m/VERTICAL
Memo :	

Data: 10

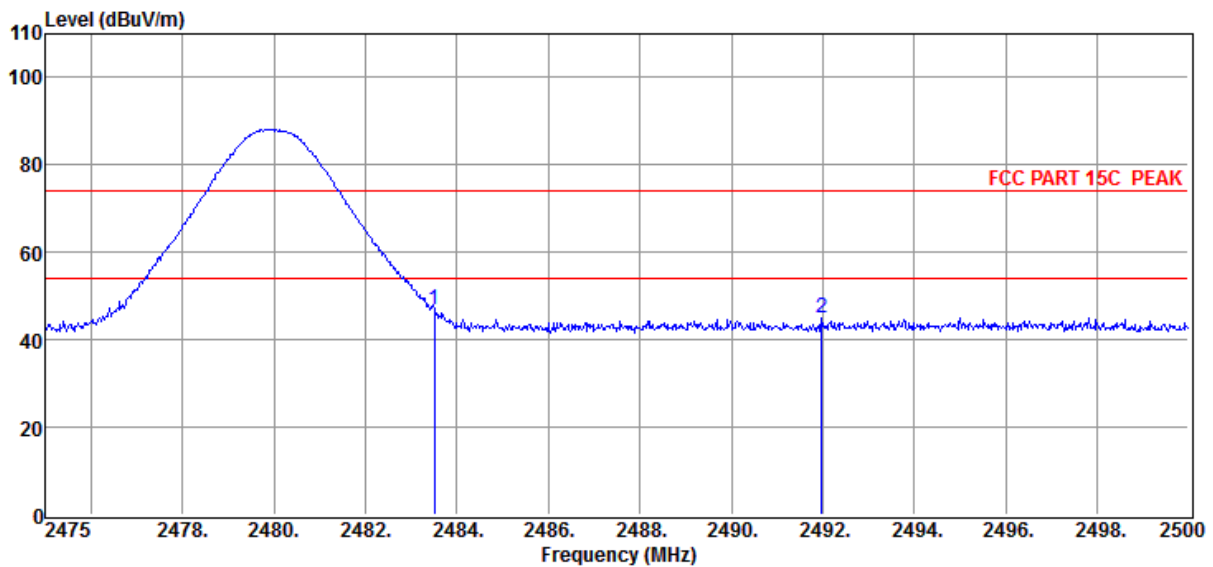

Item (Mark)	Freq (MHz)	Read Level (dBμV)	Antenna Factor (dB/m)	PRM Factor dB	Cable Loss dB	Result Level (dBμV/m)	Limit Line (dBμV/m)	Over Limit (dB)	Detector	Polarization
1	2483.50	41.43	30.25	30.25	5.31	46.74	74.00	-27.26	Peak	VERTICAL
2	2491.98	39.52	30.30	30.25	5.31	44.88	74.00	-29.12	Peak	VERTICAL

- Note: 1. Result Level = Read Level + Antenna Factor + Cable loss - PRM Factor.
 2. If Peak Result complies with AV limit, AV Result is deemed to comply with AV limit.
 3. Test setup: RBW: 1 MHz, VBW: 3 MHz, Sweep time: auto.

TR-4-E-009 Radiated Emission Test Result

Test Site : DDT 3m Chamber	E:\2015 Report Data\15Q0807-2\RF.EM6
Test Date : 2015-08-19	Tested By : Toby
EUT : Car amplifier	Model Number : GTR-102
Power Supply : DC 12V	Test Mode : Tx mode 8-DPSK CH0
Condition : Temp:24.5'C,Humi:55%, Press:100.1kPa	Antenna/Distance : 2014 HF907/3m/HORIZONTAL
Memo :	

Data: 13

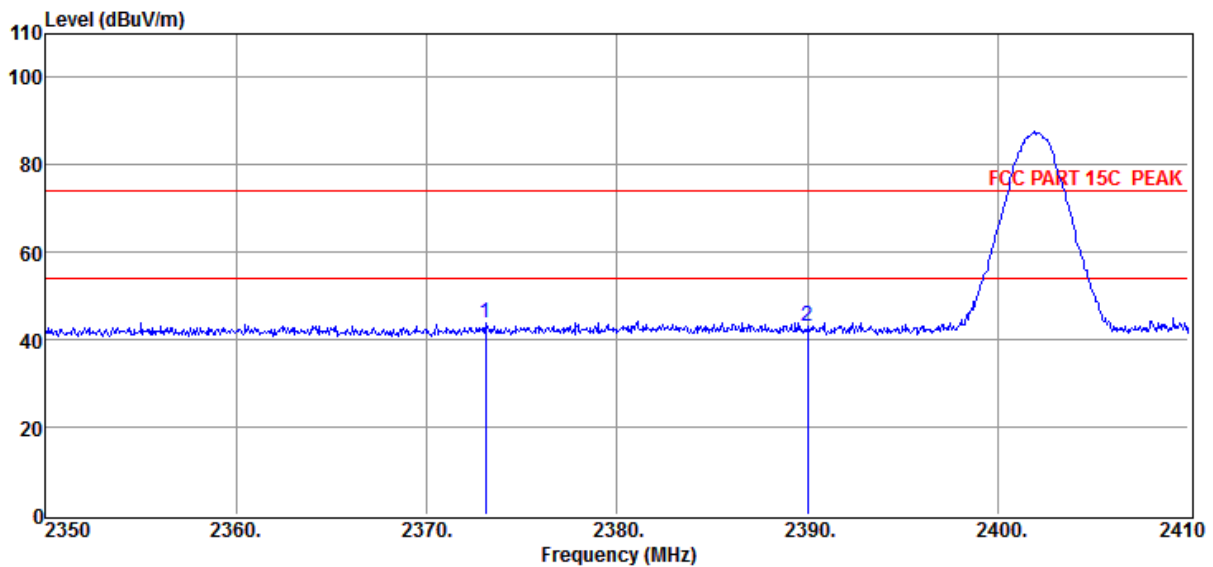

Item (Mark)	Freq (MHz)	Read Level (dBμV)	Antenna Factor (dB/m)	PRM Factor dB	Cable Loss dB	Result Level (dBμV/m)	Limit Line (dBμV/m)	Over Limit (dB)	Detector	Polarization
1	2373.10	38.98	29.94	30.19	5.11	43.84	74.00	-30.16	Peak	HORIZONTAL
2	2390.00	38.30	29.99	30.21	5.17	43.25	74.00	-30.75	Peak	HORIZONTAL

- Note: 1. Result Level = Read Level + Antenna Factor + Cable loss - PRM Factor.
 2. If Peak Result complies with AV limit, AV Result is deemed to comply with AV limit.
 3. Test setup: RBW: 1 MHz, VBW: 3 MHz, Sweep time: auto.

TR-4-E-009 Radiated Emission Test Result

Test Site : DDT 3m Chamber	E:\2015 Report Data\15Q0807-2\RF.EM6
Test Date : 2015-08-19	Tested By : Toby
EUT : Car amplifier	Model Number : GTR-102
Power Supply : DC 12V	Test Mode : Tx mode 8-DPSK CH0
Condition : Temp:24.5'C,Humi:55%, Press:100.1kPa	Antenna/Distance : 2014 HF907/3m/VERTICAL
Memo :	

Data: 14

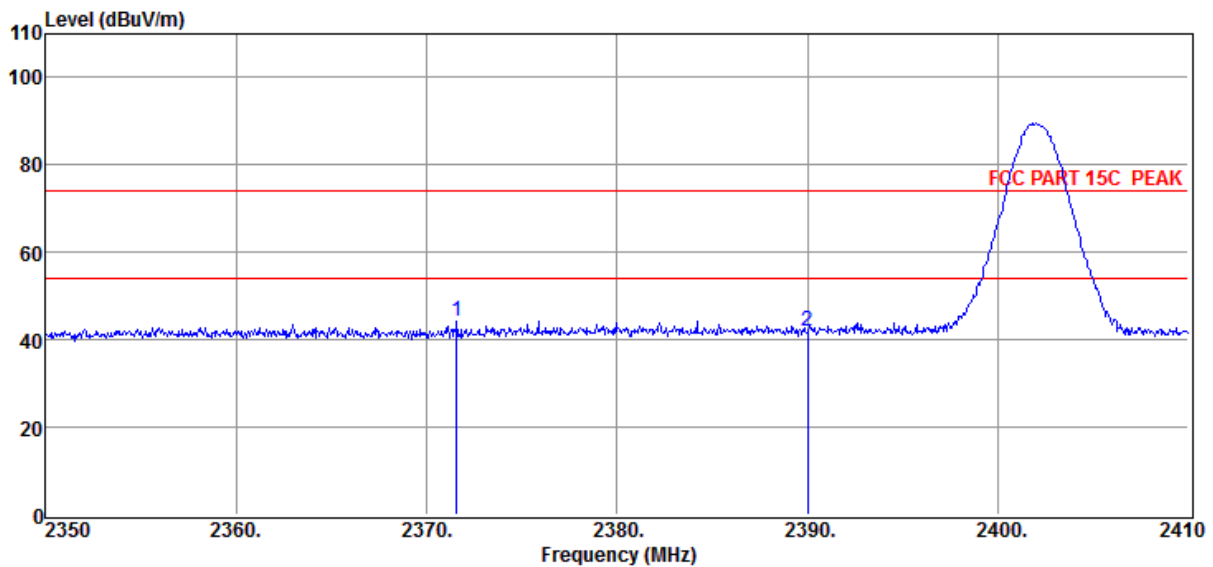

Item (Mark)	Freq (MHz)	Read Level (dBμV)	Antenna Factor (dB/m)	PRM Factor dB	Cable Loss dB	Result Level (dBμV/m)	Limit Line (dBμV/m)	Over Limit (dB)	Detector	Polarization
1	2371.60	39.25	29.94	30.19	5.11	44.11	74.00	-29.89	Peak	VERTICAL
2	2390.00	36.97	29.99	30.21	5.17	41.92	74.00	-32.08	Peak	VERTICAL

- Note: 1. Result Level = Read Level + Antenna Factor + Cable loss - PRM Factor.
 2. If Peak Result complies with AV limit, AV Result is deemed to comply with AV limit.
 3. Test setup: RBW: 1 MHz, VBW: 3 MHz, Sweep time: auto.

TR-4-E-009 Radiated Emission Test Result

Test Site	: DDT 3m Chamber	E:	\2015 Report Data\15Q0807-2\RF.EM6
Test Date	: 2015-08-19	Tested By	: Toby
EUT	: Car amplifier	Model Number	: GTR-102
Power Supply	: DC 12V	Test Mode	: Tx mode 8-DPSK CH78
Condition	: Temp:24.5'C,Humi:55%, Press:100.1kPa	Antenna/Distance	: 2014 HF907/3m/VERTICAL
Memo	:		

Data: 19

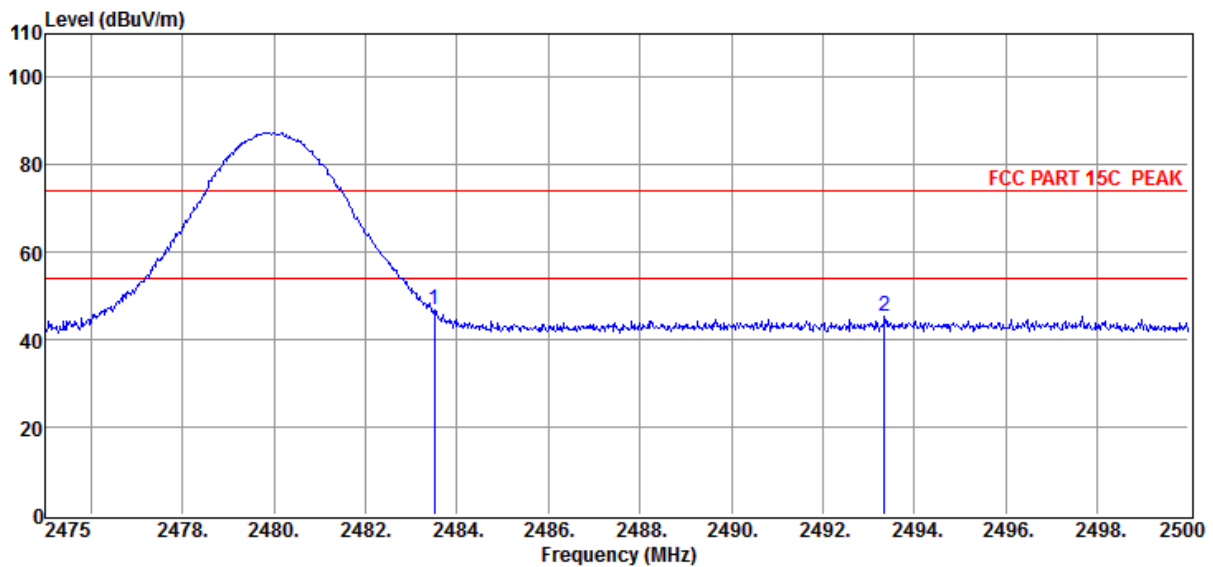

Item (Mark)	Freq (MHz)	Read Level (dBμV)	Antenna Factor (dB/m)	PRM Factor dB	Cable Loss dB	Result Level (dBμV/m)	Limit Line (dBμV/m)	Over Limit (dB)	Detector	Polarization
1	2483.50	41.59	30.25	30.25	5.31	46.90	74.00	-27.10	Peak	VERTICAL
2	2493.35	39.82	30.30	30.25	5.31	45.18	74.00	-28.82	Peak	VERTICAL

- Note: 1. Result Level = Read Level + Antenna Factor + Cable loss - PRM Factor.
 2. If Peak Result complies with AV limit, AV Result is deemed to comply with AV limit.
 3. Test setup: RBW: 1 MHz, VBW: 3 MHz, Sweep time: auto.

TR-4-E-009 Radiated Emission Test Result

Test Site	: DDT 3m Chamber	E:\2015 Report Data\15Q0807-2\RF.EM6
Test Date	: 2015-08-19	Tested By : Toby
EUT	: Car amplifier	Model Number : GTR-102
Power Supply	: DC 12V	Test Mode : Tx mode 8-DPSK CH78
Condition	: Temp:24.5'C,Humi:55%, Press:100.1kPa	Antenna/Distance : 2014 HF907/3m/HORIZONTAL
Memo	:	

Data: 20

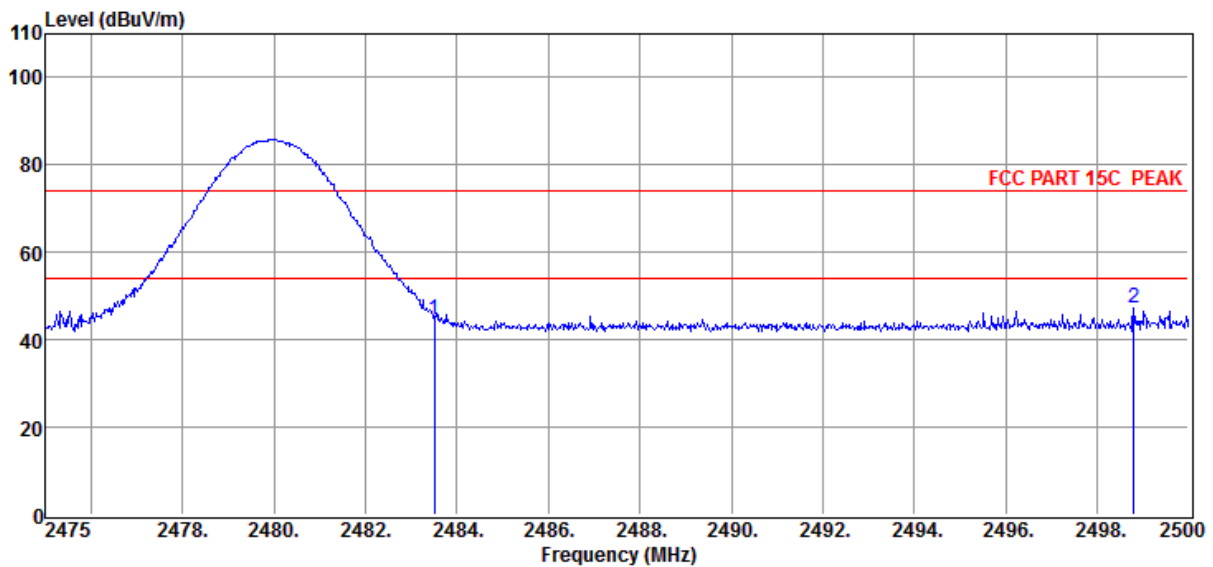

Item (Mark)	Freq (MHz)	Read Level (dBμV)	Antenna Factor (dB/m)	PRM Factor dB	Cable Loss dB	Result Level (dBμV/m)	Limit Line (dBμV/m)	Over Limit (dB)	Detector	Polarization
1	2483.50	39.48	30.25	30.25	5.31	44.79	74.00	-29.21	Peak	HORIZONTAL
2	2498.80	42.01	30.30	30.27	5.38	47.42	74.00	-26.58	Peak	HORIZONTAL

- Note: 1. Result Level = Read Level + Antenna Factor + Cable loss - PRM Factor.
 2. If Peak Result complies with AV limit, AV Result is deemed to comply with AV limit.
 3. Test setup: RBW: 1 MHz, VBW: 3 MHz, Sweep time: auto.

10. Band Edge Compliance (conducted method)

10.1. Test equipment

Item	Equipment	Manufacturer	Model No.	Serial No.	Last Cal.	Cal. Interval
1	Spectrum analyzer	R&S	FSU	1166.1660.26	2014/10/25	1 Year
2	Attenuator	Mini-Circuits	BW-S10W2	101109	2014/10/25	1 Year
3	RF Cable	Micable	C10-01-01-1	100309	2014/10/25	1 Year

10.2. Block diagram of test setup

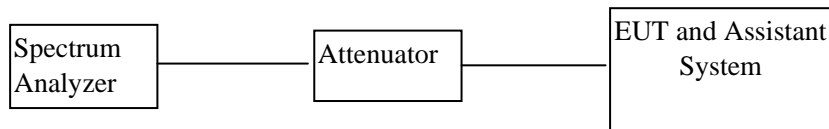

10.3. Limit

All restriction band should comply with 15.209, other emission should be at least 20dB below the fundamental.

10.4. Test result

EUT: Car amplifier M/N: GTR-102		
Mode	Freq (MHz)	Conclusion
GFSK	Hopping off 2402	PASS
	Hopping off 2480	PASS
	Hopping on	PASS
8-DPSK	Hopping off 2402	PASS
	Hopping off 2480	PASS
	Hopping on	PASS
Test Date : 2015/8/14		Test Engineer : Leo

10.5. Original test data

GFSK

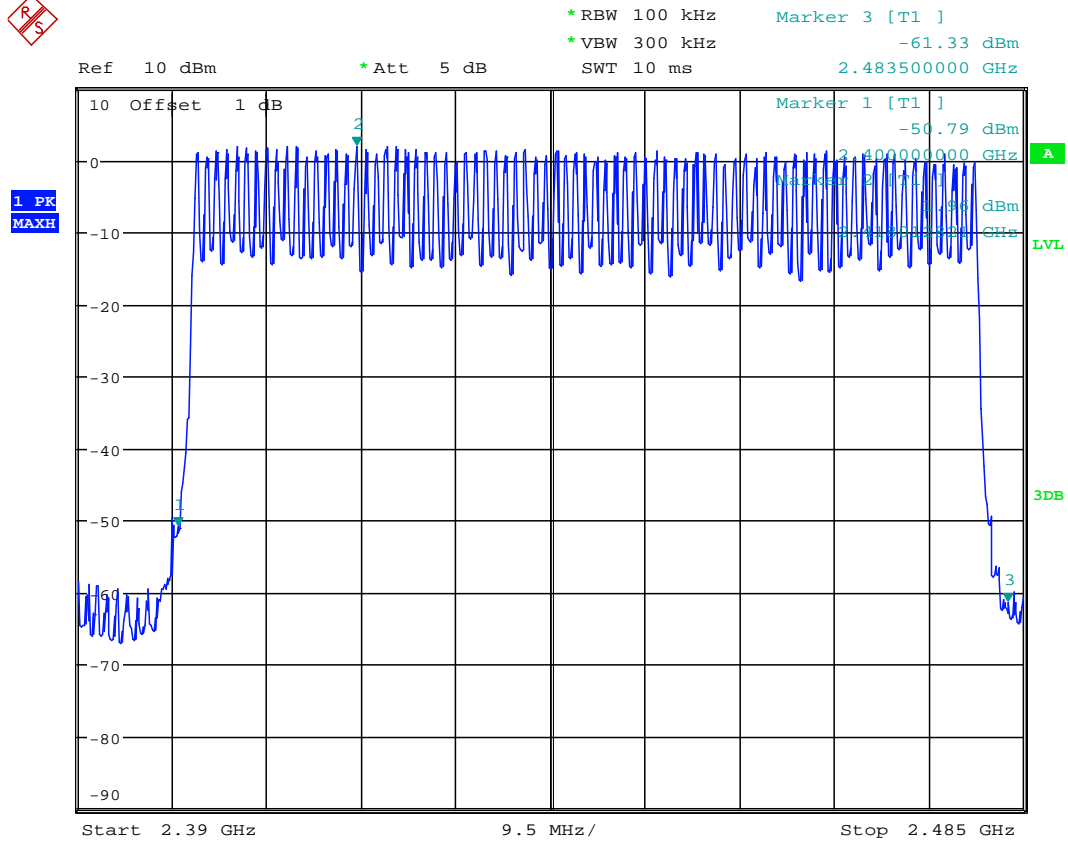

8-DPSK

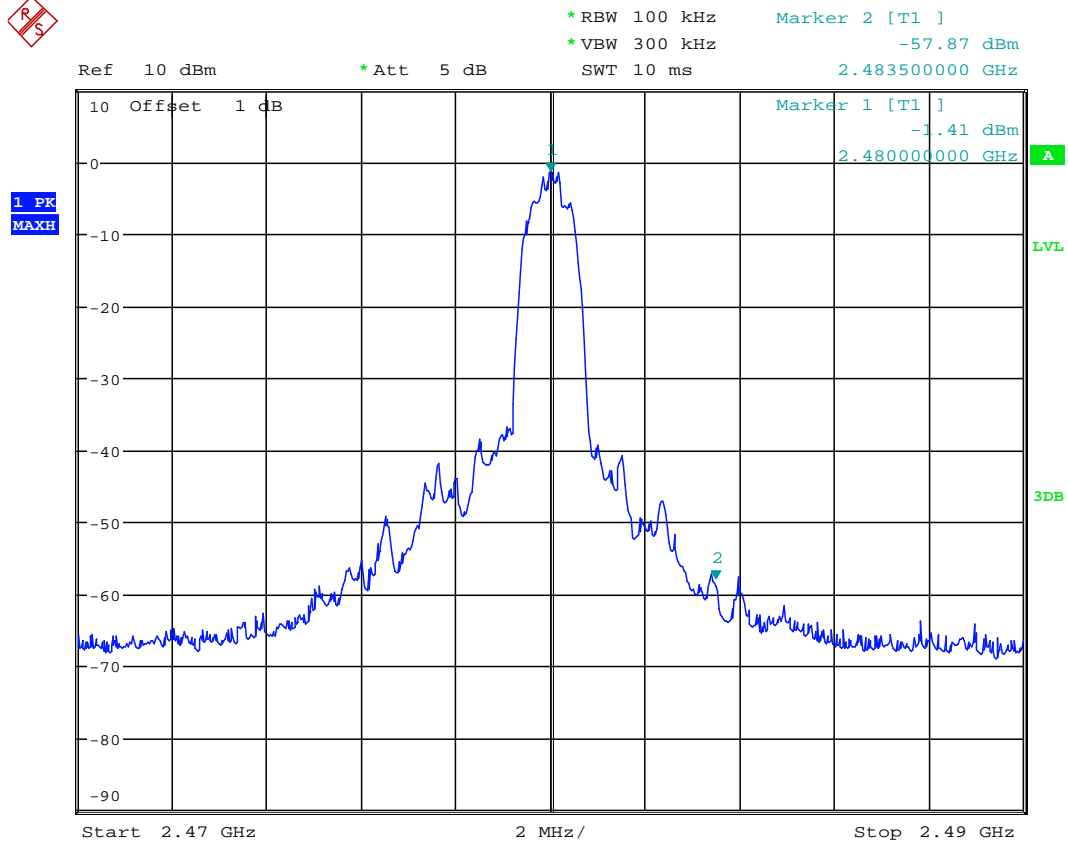

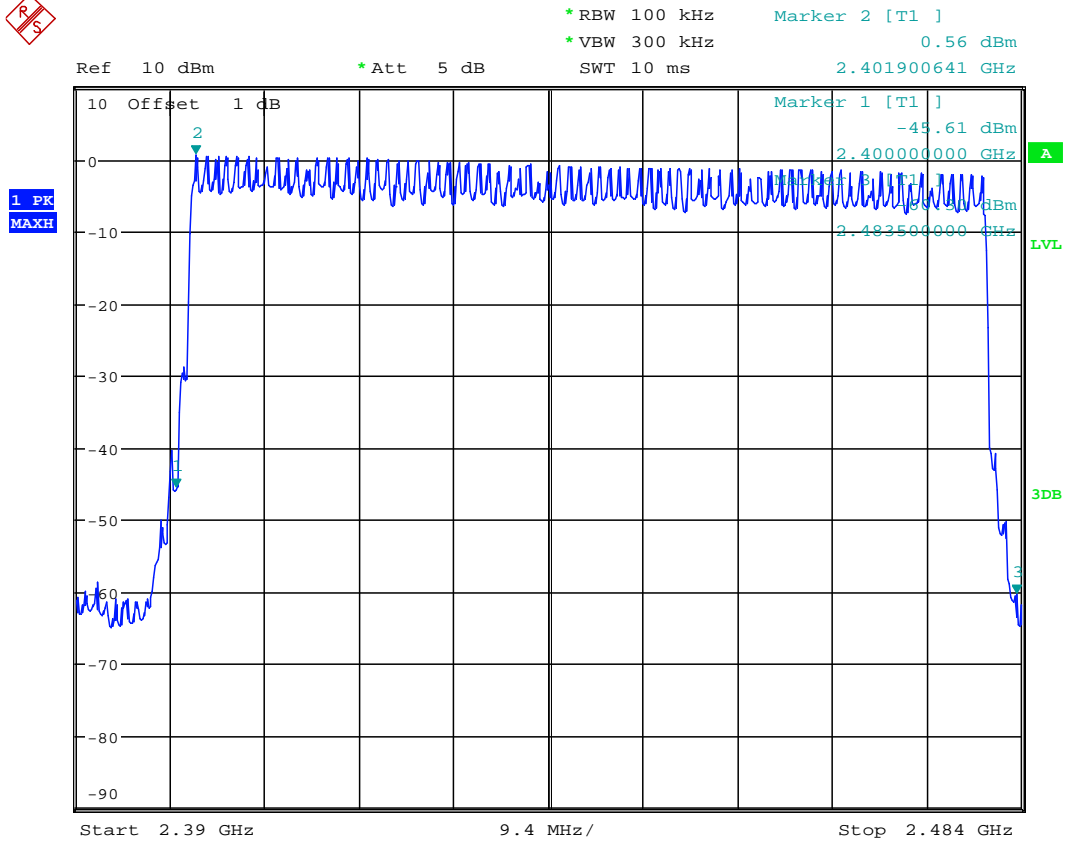
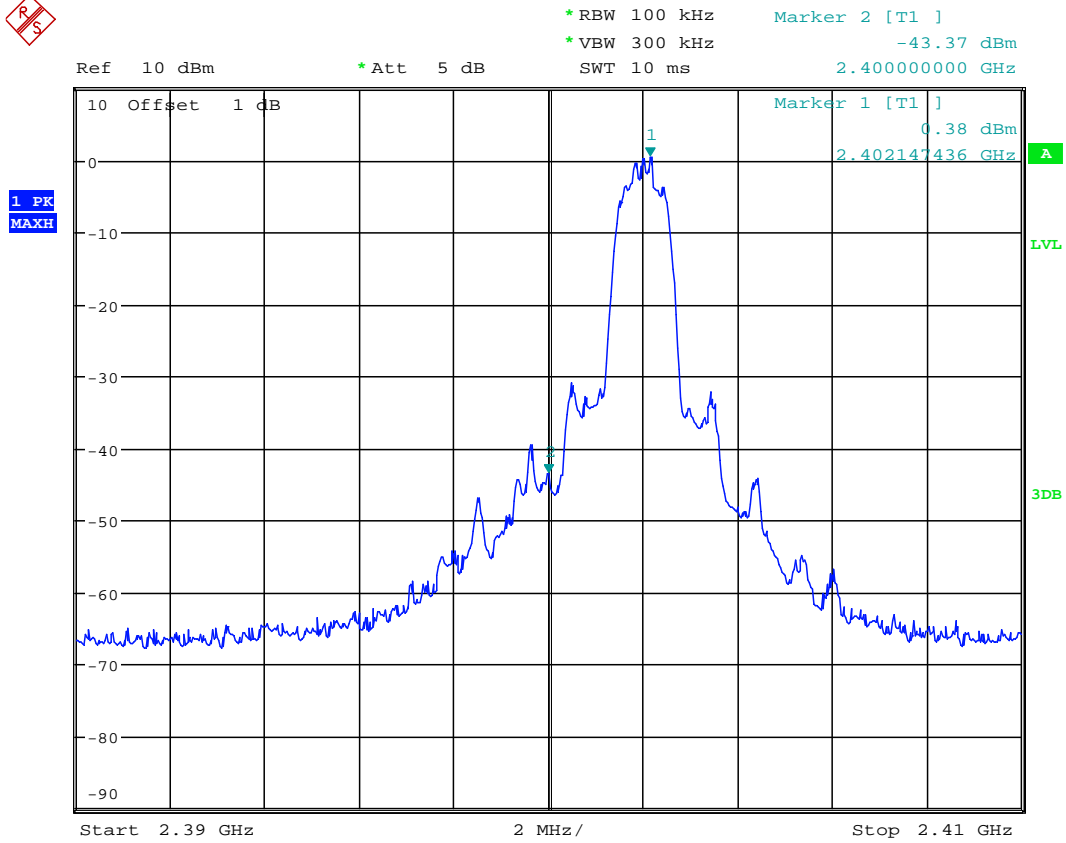

11. Power Line Conducted Emission

11.1. Test equipment

Item	Equipment	Manufacturer	Model No.	Serial No.	Last Cal.	Cal. Interval
1	Test Receiver	R&S	ESU8	100316	2014/10/25	1 Year
2	LISN 1	R&S	ENV216	101109	2014/10/25	1 Year
3	LISN 2	R&S	ESH2-Z5	100309	2014/10/25	1 Year
4	Pulse Limiter	R&S	ESH3-Z2	101242	2014/10/25	1 Year
5	Test software	Audix	E3	V 6.11111b	/	/

11.2. Block diagram of test setup

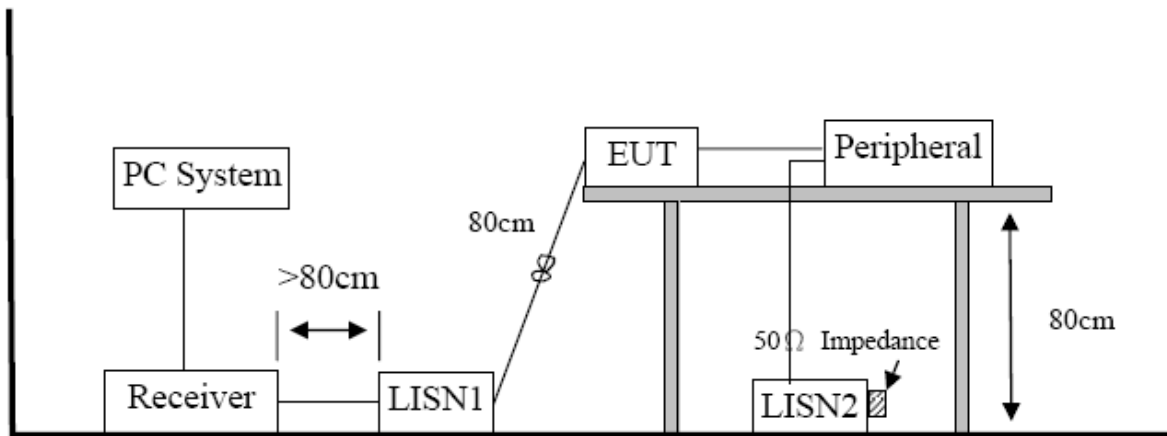

11.3. Power Line Conducted Emission Limits(Class B)

Frequency	Quasi-Peak Level dB(μ V)	Average Level dB(μ V)
150kHz ~ 500kHz	66 ~ 56*	56 ~ 46*
500kHz ~ 5MHz	56	46
5MHz ~ 30MHz	60	50

Note 1: * Decreasing linearly with logarithm of frequency.

Note 2: The lower limit shall apply at the transition frequencies.

11.4. Test Procedure

The EUT and Support equipment, if needed, were put placed on a non-metallic table, 80cm above the ground plane.

Configuration EUT to simulate typical usage as described in clause 2.4 and test equipment as described in clause 10.2 of this report.

All I/O cables were positioned to simulate typical actual usage as per ANSI C63.4.

All support equipment power received from a second LISN.

Emissions were measured on each current carrying line of the EUT using an EMI Test Receiver connected to the LISN powering the EUT.

The Receiver scanned from 150 kHz to 30MHz for emissions in each of the test modes.

During the above scans, the emissions were maximized by cable manipulation.

The test mode(s) described in clause 2.4 were scanned during the preliminary test.

After the preliminary scan, we found the test mode producing the highest emission level.

The EUT configuration and worse cable configuration of the above highest emission levels were recorded for reference of the final test.

EUT and support equipment were set up on the test bench as per the configuration with highest emission level in the preliminary test.

A scan was taken on both power lines, Neutral and Line, recording at least the six highest emissions.

Emission frequency and amplitude were recorded into a computer in which correction factors were used to calculate the emission level and compare reading to the applicable limit.

The test data of the worst-case condition(s) was recorded.

The bandwidth of test receiver is set at 9 KHz.

11.5. Test Result

Not Applicable

12. Antenna Requirements

12.1. Limit

For intentional device, according to FCC 47 CFR Section 15.203, an intentional radiator shall be designed to ensure that no antenna other than that furnished by the responsible party shall be used with the device.

And according to FCC 47 CFR Section 15.247 (b), if transmitting antennas of directional gain greater than 6dBi are used, the power shall be reduced by the amount in dB that the directional gain of the antenna exceeds 6dBi.

12.2. Result

The antennas used for this product are PCB antenna and that no antenna other than that furnished by the responsible party shall be used with the device, the maximum peak gain of the transmit antenna is only 0.72dBi.

END OF REPORT