



FCC 47 CFR PART 15 SUBPART C

TEST REPORT

For

PORTABLE BLUETOOTH SPEAKER

Model: JBL GO FF

Brand: JBL

Test Report Number:

C141112Z01-RP1-1

Prepared for

Harman International Industries, Inc.

8500 Balboa Blvd, Northridge, CA 91329, UNITED STATES

Prepared by

COMPLIANCE CERTIFICATION SERVICES (SHENZHEN) INC.

**No.10-1, Mingkeda Logistics Park, No.18, Huanguan South Rd.,
Guan Lan Town, Baoan District, Shenzhen China**

TEL: 86-755-28055000

FAX: 86-755-28055221

Issued Date: November 29, 2014



Note: This report shall not be reproduced except in full, without the written approval of Compliance Certification Services Inc. This document may be altered or revised by Compliance Certification Services Inc. personnel only, and shall be noted in the revision section of the document. The client should not use it to claim product endorsement by TAF, A2LA, NVLAP, NIST, CNAS or any government agencies. The test result of this report relate only to the tested sample identified in this report.



Revision History

Rev.	Issue Date	Revisions	Effect Page	Revised By
00	November 29, 2014	Initial Issue	ALL	Sabrina Wang



TABLE OF CONTENTS

1. TEST RESULT CERTIFICATION4

2. EUT DESCRIPTION.....5

3. TEST METHODOLOGY.....6

 3.1 DESCRIPTION OF TEST MODES6

4. FACILITIES AND ACCREDITATIONS7

 4.1 FACILITIES7

 4.2 ACCREDITATIONS.....7

 4.3 MEASUREMENT UNCERTAINTY7

5. SETUP OF EQUIPMENT UNDER TEST8

 5.1 SETUP CONFIGURATION OF EUT8

 5.2 SUPPORT EQUIPMENT8

6. FCC PART 15.247 REQUIREMENTS9

 6.1 20DB BANDWIDTH9

 6.2 PEAK POWER.....14

 6.3 PEAK POWER SPECTRAL DENSITY16

 6.4 BAND EDGES MEASUREMENT.....17

 6.5 FREQUENCY SEPARATION27

 6.6 NUMBER OF HOPPING FREQUENCY30

 6.7 TIME OF OCCUPANCY (DWELL TIME).....32

 6.8 SPURIOUS EMISSIONS39

 6.9 POWERLINE CONDUCTED EMISSIONS.....57



1. TEST RESULT CERTIFICATION

Product:	PORTABLE BLUETOOTH SPEAKER
Model:	JBL GO FF
Brand:	JBL
Tested:	November 12~29, 2014
Applicant:	Harman International Industries, Inc. 8500 Balboa Blvd, Northridge, CA 91329, UNITED STATES
Manufacturer:	Harman International Industries, Inc. 8500 Balboa Blvd, Northridge, CA 91329, UNITED STATES

APPLICABLE STANDARDS	
STANDARD	TEST RESULT
FCC 47 CFR Part 15 Subpart C	No non-compliance noted

We hereby certify that:

The above equipment was tested by Compliance Certification Services Inc. The test data, data evaluation, test procedures, and equipment configurations shown in this report were made in accordance with the procedures given in ANSI C63.4:2009 and the energy emitted by the sample EUT tested as described in this report is in compliance with conducted and radiated emission limits of FCC Rules Part 15.207, 15.209 and 15.247.

The test results of this report relate only to the tested sample EUT identified in this report.

Approved by:

Sunday Hu
Supervisor of EMC Dept.
Compliance Certification Service Inc.

Reviewed by:

Ruby Zhang
Supervisor of Report Dept.
Compliance Certification Service Inc.



2. EUT DESCRIPTION

Product	PORTABLE BLUETOOTH SPEAKER
Model Number	JBL GO FF
Brand	JBL
Model Discrepancy	N/A
Identify Number	C141112Z01-RP1-1
Power Supply	DC3.7V 610mAh 2.26Wh supply by the battery 1# or DC3.7V 600mAh 2.22Wh supply by the battery 2# or DC5V supplied by PC
Battery Manufacturer /Model No.	Battery 1: Li-ion / GSP072035 O/P: 3.7Vdc, 610mAh 2.26Wh Battery 2: McNair / MLP722337 O/P: 3.7Vdc, 600mAh 2.22Wh
Received Date	November 12, 2014
Frequency Range	2402 ~ 2480 MHz
Transmit Power	GFSK : 7.70dBm 8DPSK : 7.04dBm
Modulation Technique	FHSS (GFSK for 1Mbps, $\pi/4$ -DQPSK for 2Mbps, 8DPSK for 3Mbps)
Number of Channels	79 Channels
Antenna Specification	PCB antenna with 2.1dBi gain (Max)
Temperature Range	0°C ~ +40°C
Hardware Version	V0.5
Software Version	V0.4

Note: This submittal(s) (test report) is intended for FCC ID: APIJBLGOFF filing to comply with Section 15.207, 15.209 and 15.247 of the FCC Part 15, Subpart C Rules.



3. TEST METHODOLOGY

3.1 DESCRIPTION OF TEST MODES

The EUT has been tested under operating condition.
Test program used to control the EUT for staying in continuous transmitting and receiving mode is programmed.

Test Item	Test mode	Worse mode
Conducted Emission	Mode 1: Charge + Aux + BT + battery 1#	<input checked="" type="checkbox"/>
	Mode 2: Charge + BT + battery 1#	<input type="checkbox"/>
	Mode 3: Charge + Aux + BT + battery 2#	<input type="checkbox"/>
	Mode 4: Charge + BT + battery 2#	<input type="checkbox"/>
Radiated Emission	Mode 1: TX	<input checked="" type="checkbox"/>

Channel Low (2402MHz) 、Mid (2441MHz) and High (2480MHz) were chosen for pre-testing for GFSK 、 $\pi/4$ -DQPSK and 8DPSK, GFSK and 8DPSK were the worse case and print in the report.



4. FACILITIES AND ACCREDITATIONS

4.1 FACILITIES

All measurement facilities used to collect the measurement data are located at

- No.10-1, Mingkeda Logistics Park, No.18, Huanguan South Rd., Guan Lan Town, Baoan District, Shenzhen, China**

The sites are constructed in conformance with the requirements of ANSI C63.4:2009, ANSI C63.7 and CISPR Publication 22. All receiving equipment conforms to CISPR Publication 16-1, "Radio Interference Measuring Apparatus and Measurement Methods."

4.2 ACCREDITATIONS

Our laboratories are accredited and approved by the following accreditation body according to ISO/IEC 17025.

USA	A2LA
China	CNAS

The measuring facility of laboratories has been authorized or registered by the following approval agencies.

USA	FCC
Japan	VCCI(C-3478, R-3135, T-652, G-624)
Canada	INDUSTRY CANADA
Taiwan	BSMI

Copies of granted accreditation certificates are available for downloading from our web site, <http://www.ccsrf.com>

4.3 MEASUREMENT UNCERTAINTY

Where relevant, the following measurement uncertainty levels have been estimated for tests performed on the EUT as specified in CISPR 16-4-2:

Parameter	Uncertainty
Radiated Emission, 30 to 200 MHz Test Site : 966(2)	+/-3.6880dB
Radiated Emission, 200 to 1000 MHz Test Site : 966(2)	+/-3.6695dB
Radiated Emission, 1 to 8 GHz	+/-5.1782dB
Radiated Emission, 8 to 18 GHz	+/-5.2173dB
Conducted Emissions	+/-3.6836dB
Band Width	178kHz
Peak Output Power MU	+/-1.906dB
Band Edge MU	+/-0.182dB
Channel Separation MU	416.178Hz
Duty Cycle MU	0.054ms
Frequency Stability MU	226Hz

This uncertainty represents an expanded uncertainty expressed at approximately the 95% confidence level using a coverage factor of k=2.

The measured result is above (below) the specification limit by a margin less than the measurement uncertainty; it is therefore not possible to state compliance based on the 95% level of confidence. However, the result indicates that compliance (non-compliance) is more probable than non-compliance) with the specification limit.



5. SETUP OF EQUIPMENT UNDER TEST

5.1 SETUP CONFIGURATION OF EUT

See test photographs attached in Appendix 1 for the actual connections between EUT and support equipment.

5.2 SUPPORT EQUIPMENT

No.	Equipment	Model No.	Serial No.	FCC	Brand	Data Cable	Power Cord
1	Notebook	B475	WB04861612	DoC	LENOVO	Unshielded 1.00m	N/A
2	Earphone	N/A	N/A	DoC	N/A	Unshielded 1.50m	

Notes:

Grounding was established in accordance with the manufacturer's requirements and conditions for the intended use.



6. FCC PART 15.247 REQUIREMENTS

6.1 20DB BANDWIDTH

None; for reporting purpose only.

MEASUREMENT EQUIPMENT USED

Name of Equipment	Manufacturer	Model	Serial Number	Last Calibration	Due Calibration
Spectrum Analyzer	Agilent	E4446A	US44300399	03/01/2014	03/01/2015

Remark: Each piece of equipment is scheduled for calibration once a year.

TEST CONFIGURATION

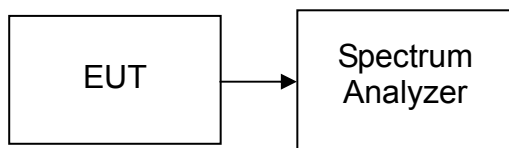

TEST PROCEDURE

1. Place the EUT on the table and set it in the transmitting mode.
2. Remove the antenna from the EUT, then connect a low loss RF cable from antenna port to the spectrum analyzer.
3. Set the spectrum analyzer as RBW=30kHz, VBW=100kHz, Span=3MHz, Sweep = auto.
4. Mark the peak frequency and 20dB (upper and lower) frequency.
5. Repeat until all the test channels are investigated.

TEST RESULTS

No non-compliance noted



Test plot

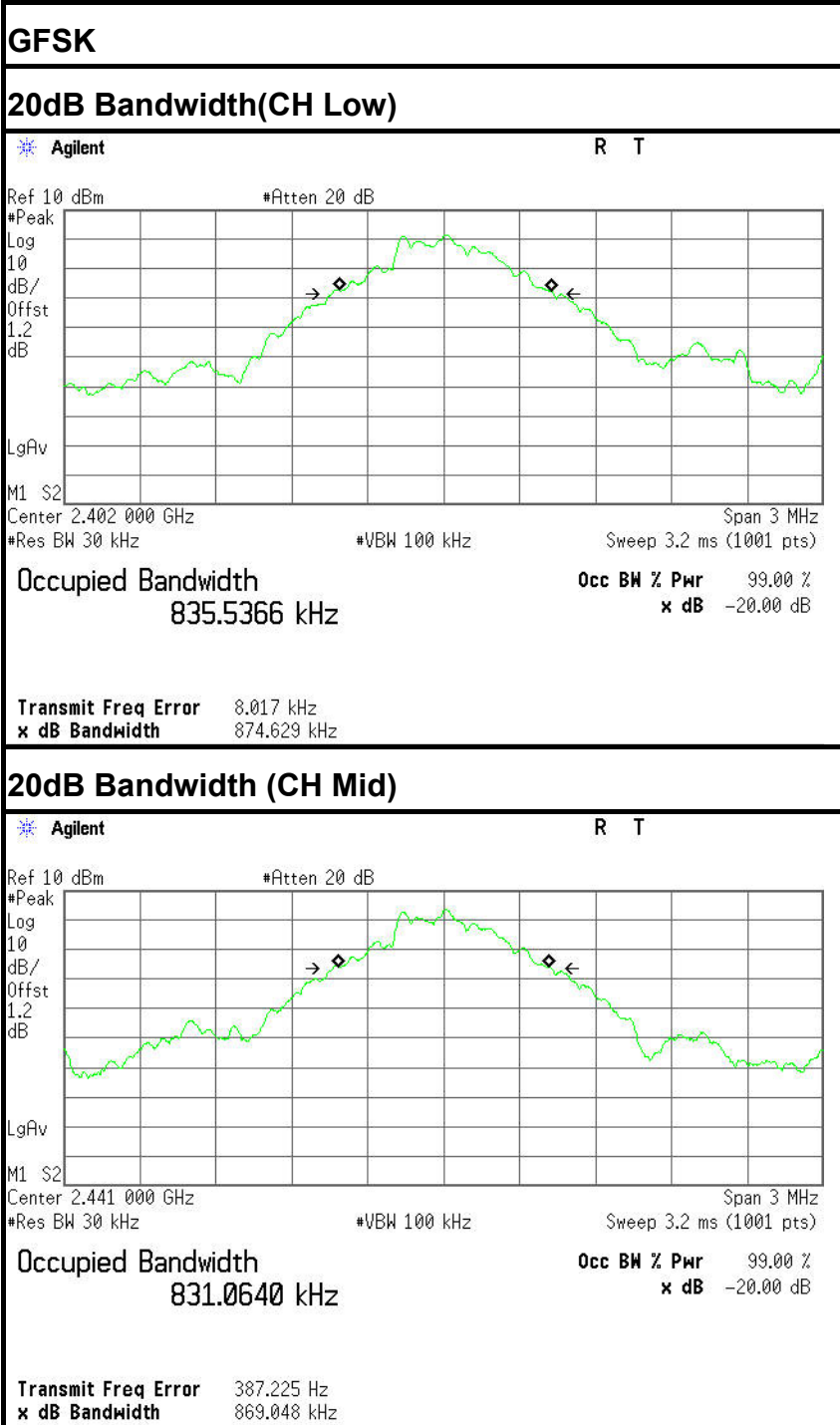

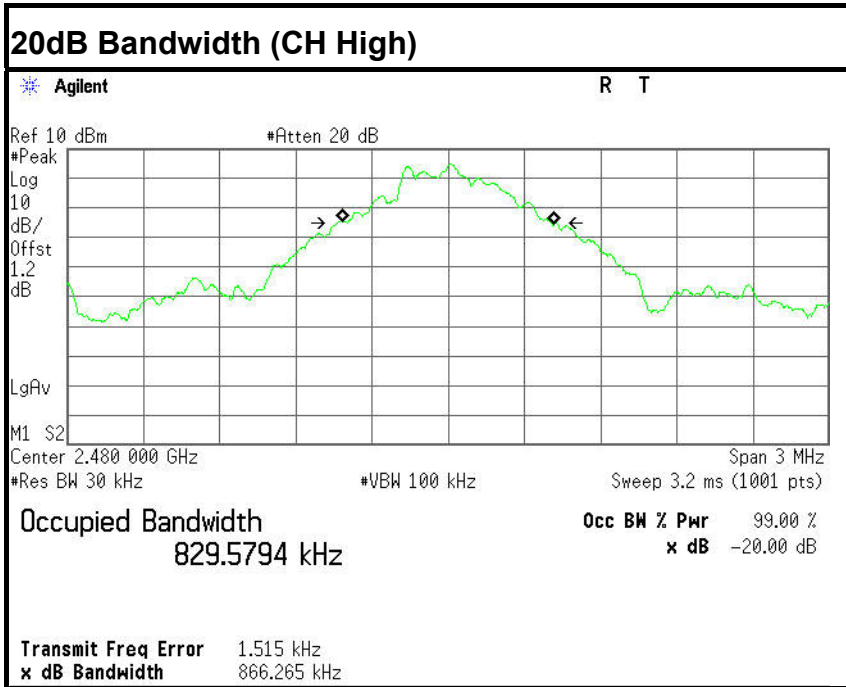



Test plot

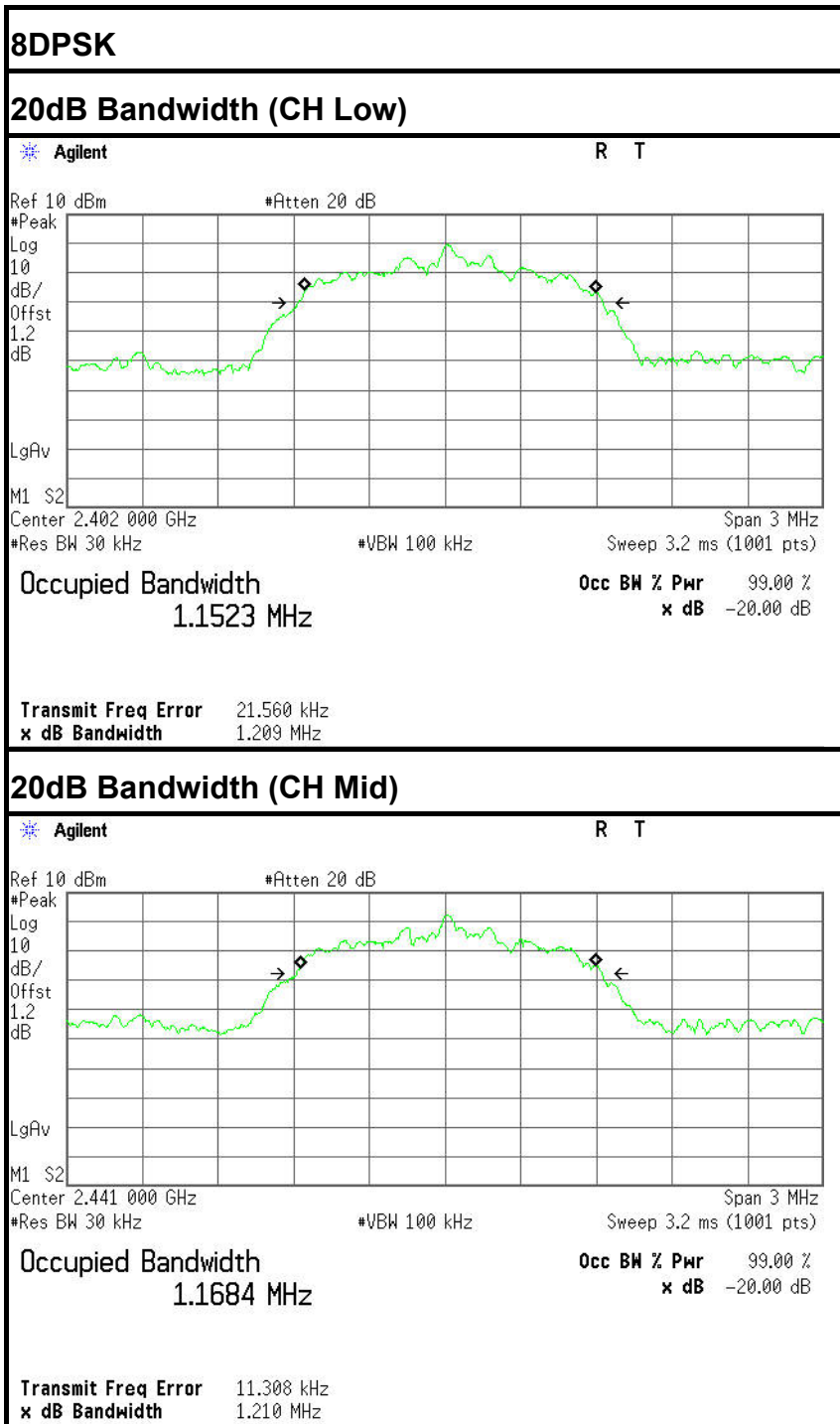

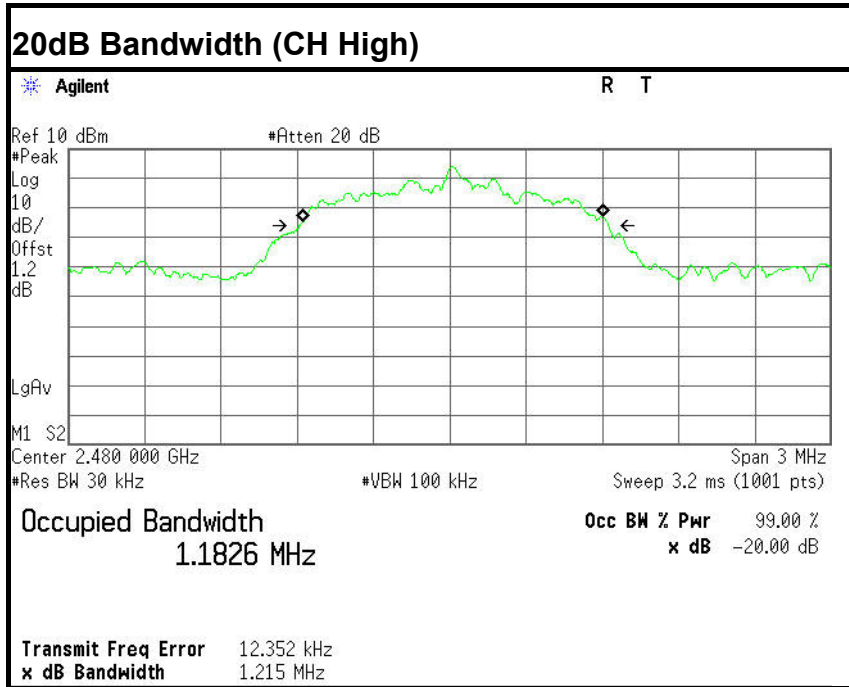



6.2 PEAK POWER

LIMIT

The maximum peak output power of the intentional radiator shall not exceed the following:

1. For frequency hopping systems operating in the 2400-2483.5 MHz band employing at least 75 non-overlapping hopping channels: 1 watt. For all other frequency hopping systems in the 2400-2483.5 MHz band: 0.125 watts.
2. Except as shown in paragraphs (b)(3) (i), (ii) and (iii) of this section, if transmitting antennas of directional gain greater than 6dBi are used the peak output power from the intentional radiator shall be reduced below the stated values in paragraphs (b)(1) or (b)(2) of this section, as appropriate, by the amount in dB that the directional gain of the antenna exceeds 6dBi.
3. The conducted output power limit specified in paragraph (b) of this section is based on the use of antennas with directional gains that do not exceed 6 dBi. Except as shown in paragraph (c) of this section, if transmitting antennas of directional gain greater than 6 dBi are used, the conducted output power from the intentional radiator shall be reduced below the stated values in paragraphs (b)(1), (b)(2), and (b)(3) of this section, as appropriate, by the amount in dB that the directional gain of the antenna exceeds 6 dBi.

MEASUREMENT EQUIPMENT USED

Name of Equipment	Manufacturer	Model	Serial Number	Last Calibration	Due Calibration
Power Meter	Anritsu	ML2495A	1204003	03/01/2014	03/01/2015
Spectrum Analyzer	R&S	FSU	200409	09/23/2014	09/22/2015

Remark: Each piece of equipment is scheduled for calibration once a year.

Test Configuration

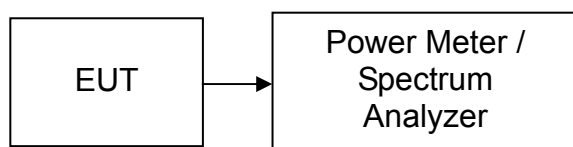

TEST PROCEDURE

The transmitter output is connected to the RF Power Meter. The RF Power Meter is set to the peak power detection.



TEST RESULTS

No non-compliance noted

Test Data

GFSK

Channel	Frequency (MHz)	Reading Power (dBm)	Cable loss (dB)	Output Power (dBm)	Output Power (W)	Limit (W)	Result
Low	2402	0.36	3.50	3.86	0.00243	1	PASS
Mid	2441	3.62	3.50	7.12	0.00515		PASS
High	2480	4.20	3.50	7.70	0.00589		PASS

8DPSK

Channel	Frequency (MHz)	Reading Power (dBm)	Cable loss (dB)	Output Power (dBm)	Output Power (W)	Limit (W)	Result
Low	2402	0.01	3.50	3.51	0.00224	1	PASS
Mid	2441	2.91	3.50	6.41	0.00438		PASS
High	2480	3.54	3.50	7.04	0.00506		PASS



6.3 PEAK POWER SPECTRAL DENSITY

LIMIT

1. For direct sequence systems, the peak power spectral density conducted from the intentional radiator to the antenna shall not be greater than 8dBm in any 3kHz band during any time interval of continuous transmission.
2. The direct sequence operating of the hybrid system, with the frequency hopping operation turned off, shall comply with the power density requirements of paragraph (d) of this section.

MEASUREMENT EQUIPMENT USED

Name of Equipment	Manufacturer	Model	Serial Number	Last Calibration	Due Calibration
Spectrum Analyzer	Agilent	E4446A	US44300399	03/01/2014	03/01/2015

Remark: Each piece of equipment is scheduled for calibration once a year.

Test Configuration

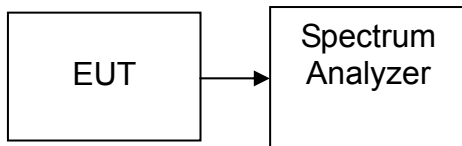

TEST PROCEDURE

1. Set analyzer center frequency to DTS channel center frequency.
2. Set the span to 1.5 times the DTS bandwidth.
3. Set the RBW to: $3\text{ kHz} \leq \text{RBW} \leq 100\text{ kHz}$.
4. Set the VBW $\geq 3 \times \text{RBW}$.
5. Detector = peak.
6. Sweep time = auto couple.
7. Trace mode = max hold.
8. Allow trace to fully stabilize.
9. Use the peak marker function to determine the maximum amplitude level within the RBW.
10. If measured value exceeds limit, reduce RBW (no less than 3 kHz) and repeat.

TEST RESULTS

Not applicable. Since EUT is the Bluetooth device.



6.4 BAND EDGES MEASUREMENT

LIMIT

According to §15.247(c), in any 100 kHz bandwidth outside the frequency bands in which the spread spectrum intentional radiator is operating, the radio frequency power that is produced by the intentional radiator shall be at least 20dB below that in the 100kHz bandwidth within the band that contains the highest level of the desired power. In addition, radiated emissions which fall in the restricted bands, as defined in §15.205(a), must also comply with the radiated emission limits specified in 15.209(a).

MEASUREMENT EQUIPMENT USED

Radiated Emission Test Site 966 (2)					
Name of Equipment	Manufacturer	Model Number	Serial Number	Last Calibration	Due Calibration
Spectrum Analyzer	Agilent	E4446A	US44300399	03/01/2014	03/01/2015
EMI TEST RECEIVER	ROHDE&SCHWARZ	ESCI	100783	03/09/2014	03/08/2015
Amplifier	MITEQ	AM-1604-3000	1123808	03/18/2014	03/17/2015
High Noise Amplifier	Agilent	8449B	3008A01838	03/18/2014	03/17/2015
Board-Band Horn Antenna	Schwarzbeck	BBHA 9170	9170-497	07/10/2014	07/09/2015
Bilog Antenna	SCHAFFNER	CBL6143	5082	03/01/2014	03/01/2015
Horn Antenna	SCHWARZBECK	BBHA9120	D286	03/01/2014	03/01/2015
Loop Antenna	A, R, A	PLA-1030/B	1029	09/27/2014	09/26/2015
Turn Table	N/A	N/A	N/A	N.C.R	N.C.R
Controller	Sunol Sciences	SC104V	022310-1	N.C.R	N.C.R
Controller	CT	N/A	N/A	N.C.R	N.C.R
Temp. / Humidity Meter	Anymetre	JR913	N/A	02/28/2014	02/27/2015
Antenna Tower	SUNOL	TLT2	N/A	N.C.R	N.C.R
Test S/W	FARAD	LZ-RF / CCS-SZ-3A2			

Test Configuration

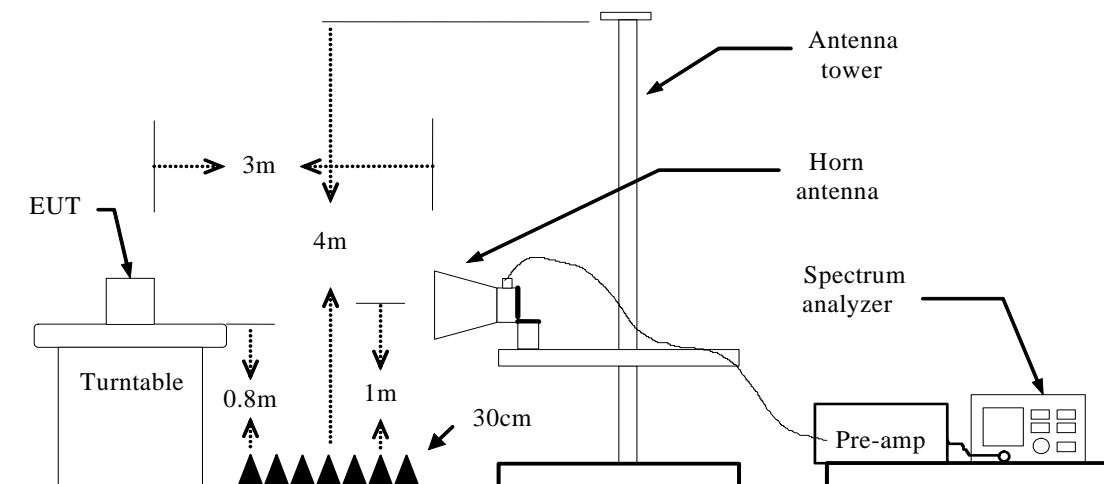



TEST PROCEDURE

1. The EUT is placed on a turntable, which is 0.8m above the ground plane.
2. The turntable shall be rotated for 360 degrees to determine the position of maximum emission level.
3. EUT is set 3m away from the receiving antenna, which is varied from 1m to 4m to find out the highest emission.
4. Set the spectrum analyzer in the following setting in order to capture the lower and upper band-edges of the emission:
 - (a) PEAK: RBW=VBW=1MHz / Sweep=AUTO
 - (b) AVERAGE: RBW=1MHz / VBW=2.2kHz / Sweep=AUTO
5. Repeat the procedures until all the PEAK and AVERAGE versus POLARIZATION are measured.

TEST RESULTS

Refer to attach spectrum analyzer data chart.



Test Data (GFSK)

Band Edges (CH-Low)

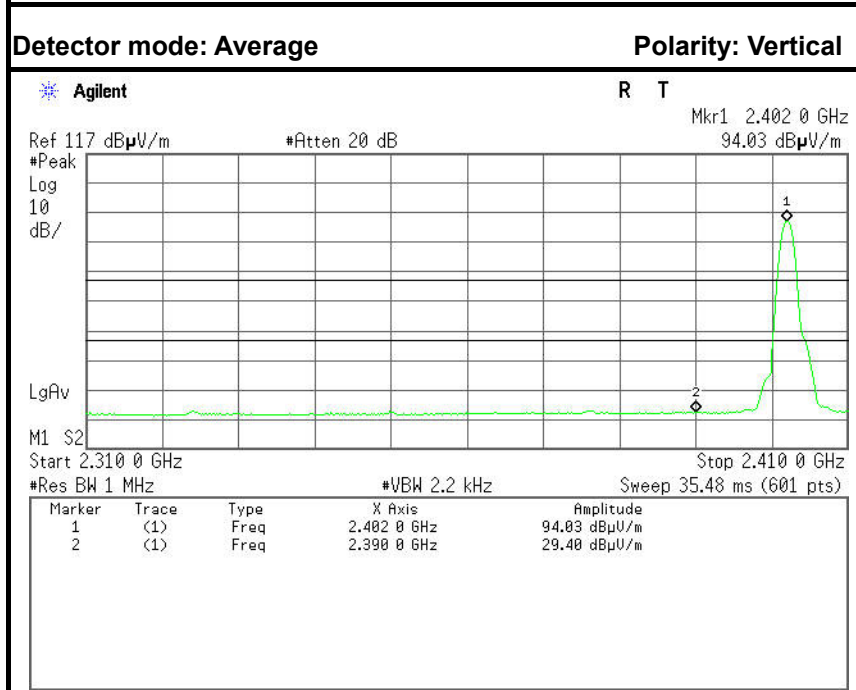
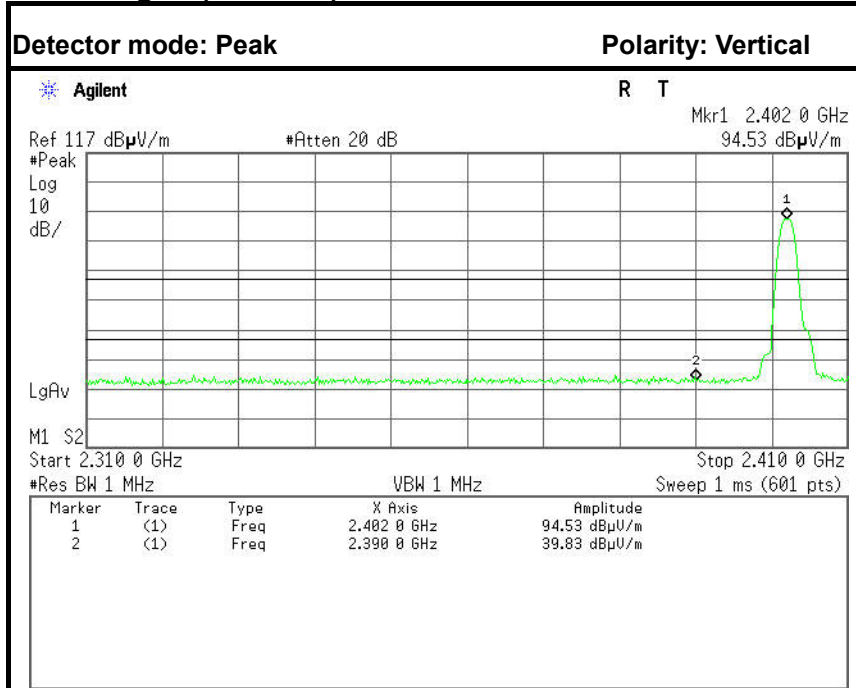

No.	Frequency (MHz)	Reading (dBuV)	Corrected (dB)	Result (dBuV)	Limit (dBuV)	Margin (dB)	Detector	Antenna Pole
1	2390.0000	33.23	-6.60	39.83	74.00	-34.17	Peak	Vertical
2	2390.0000	22.80	-6.60	29.40	54.00	-24.60	Average	Vertical

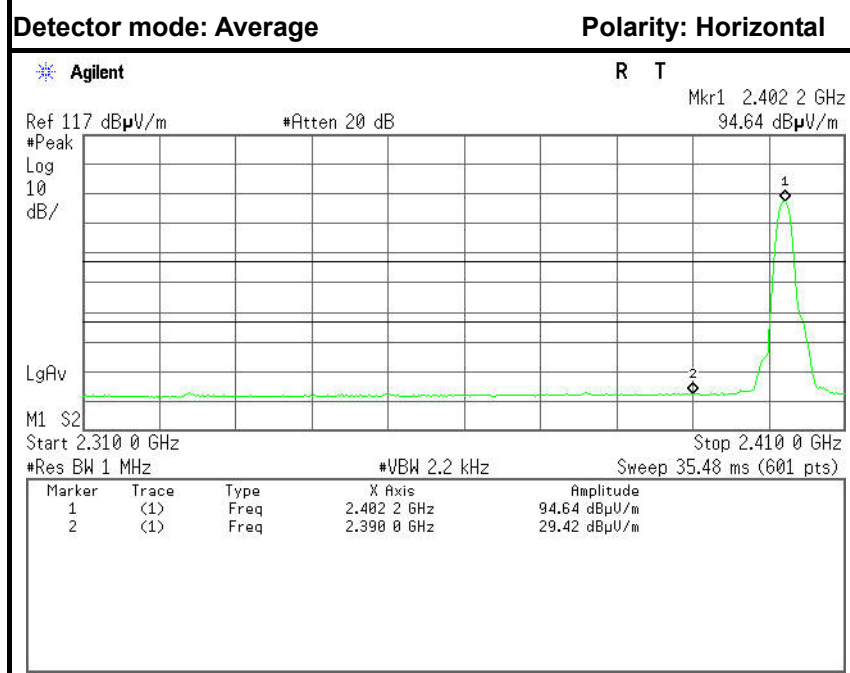
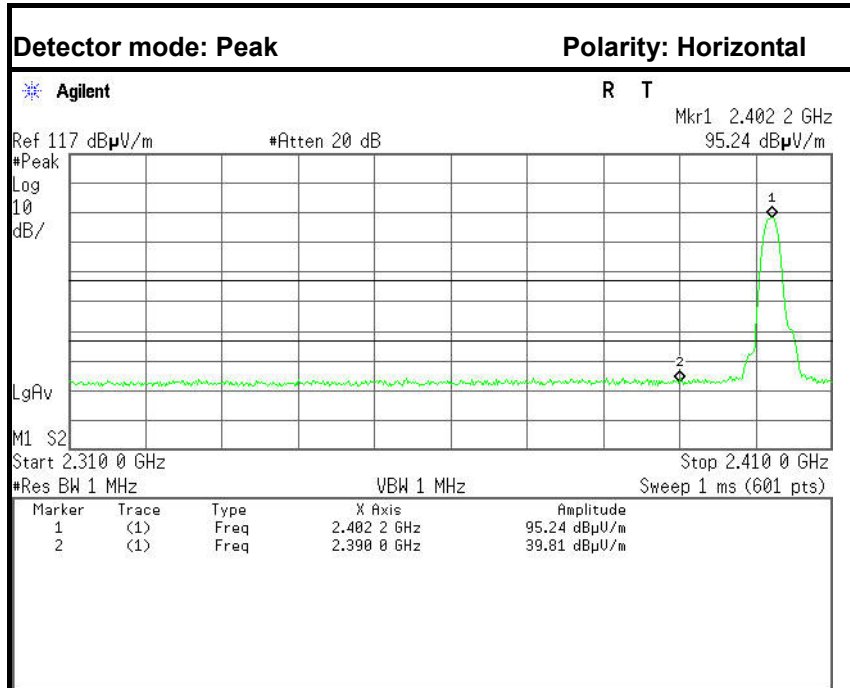

No.	Frequency (MHz)	Reading (dBuV)	Corrected (dB)	Result (dBuV)	Limit (dBuV)	Margin (dB)	Detector	Antenna Pole
1	2390.0000	33.21	-6.60	39.81	74.00	-34.19	Peak	Horizontal
2	2390.0000	22.82	-6.60	29.42	54.00	-24.58	Average	Horizontal



Band Edges (CH-High)

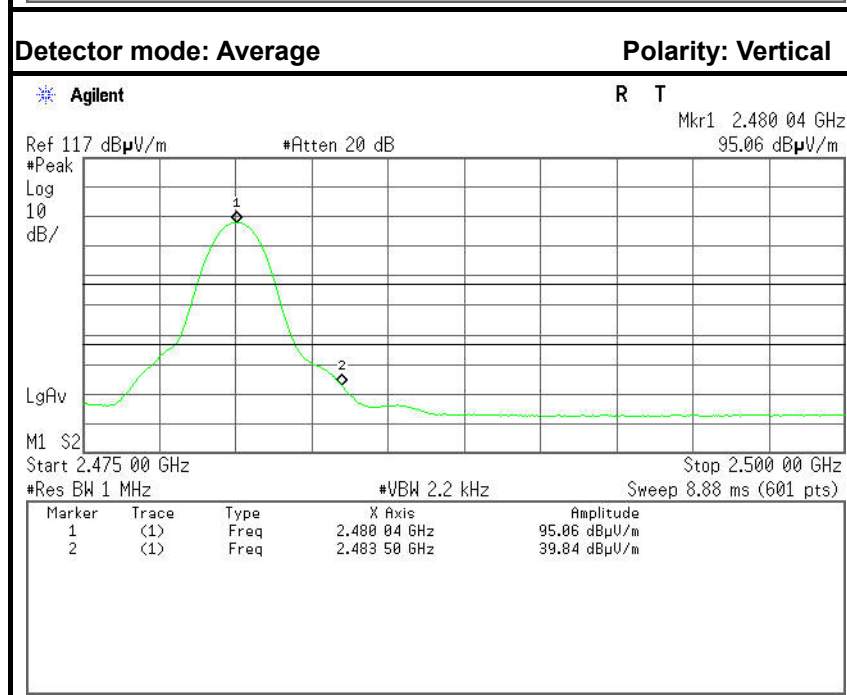
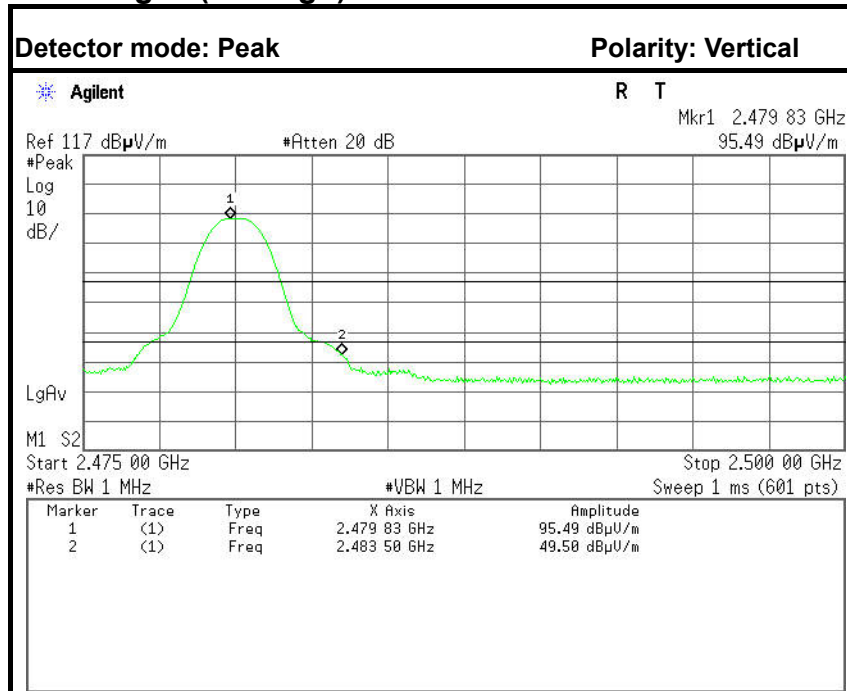

No.	Frequency (MHz)	Reading (dBuV)	Corrected (dB)	Result (dBuV)	Limit (dBuV)	Margin (dB)	Detector	Antenna Pole
1	2483.5000	43.26	-6.24	49.50	74.00	-24.50	Peak	Vertical
2	2483.5000	33.60	-6.24	39.84	54.00	-14.16	Average	Vertical

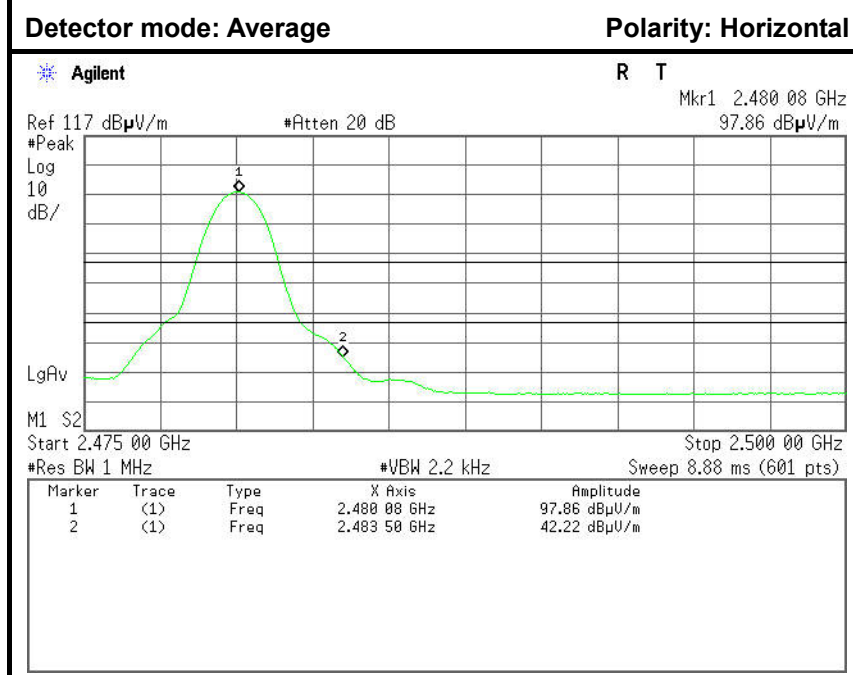
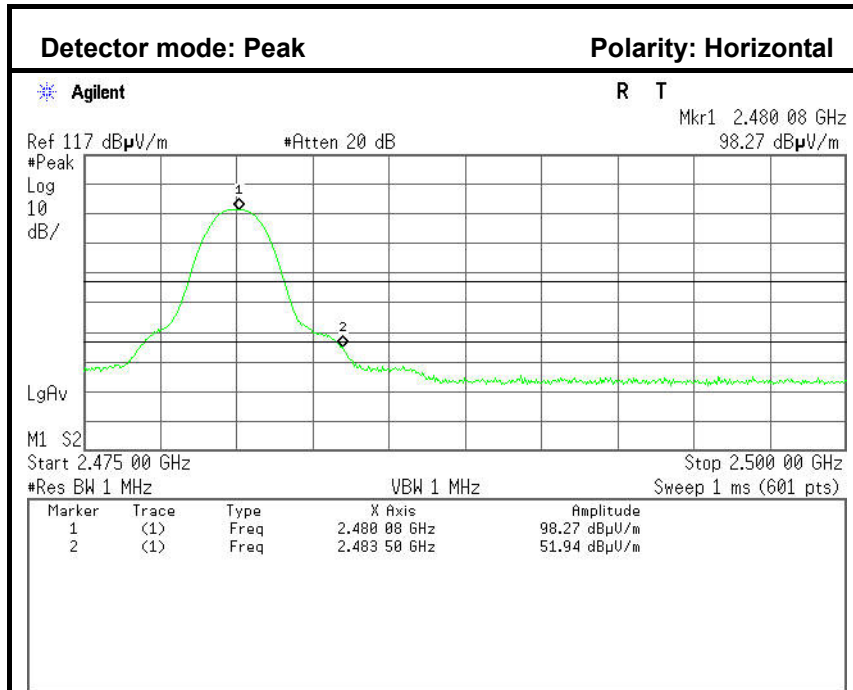

No.	Frequency (MHz)	Reading (dBuV)	Corrected (dB)	Result (dBuV)	Limit (dBuV)	Margin (dB)	Detector	Antenna Pole
1	2483.5000	45.70	-6.24	51.94	74.00	-22.06	Peak	Horizontal
2	2483.5000	35.98	-6.24	42.22	54.00	-11.78	Average	Horizontal



8DPSK

Band Edges (CH-Low)

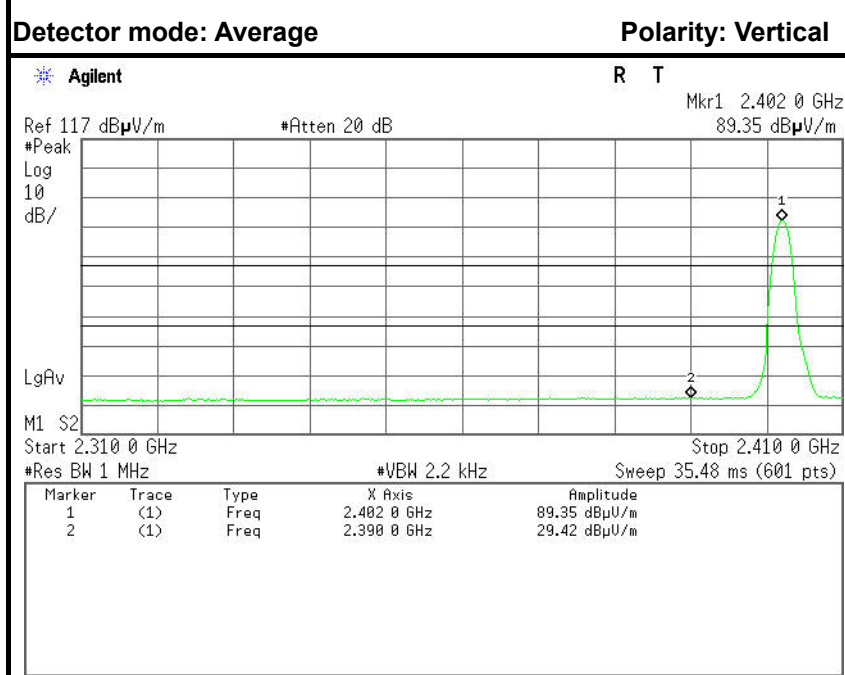
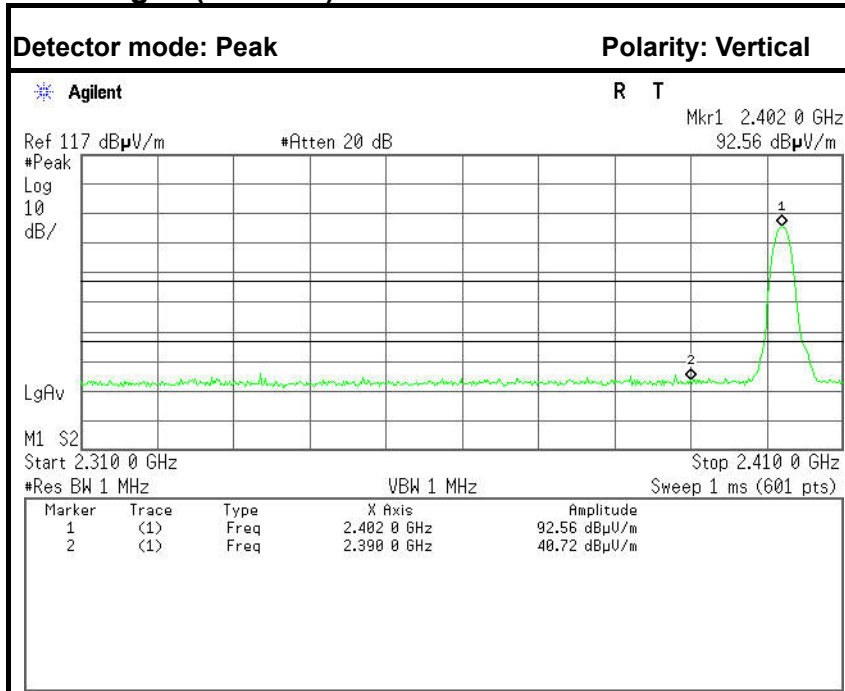

No.	Frequency (MHz)	Reading (dBµV)	Corrected (dB)	Result (dBµV)	Limit (dBµV)	Margin (dB)	Detector	Antenna Pole
1	2390.0000	34.12	-6.60	40.72	74.00	-33.28	Peak	Vertical
2	2390.0000	22.82	-6.60	29.42	54.00	-24.58	Average	Vertical

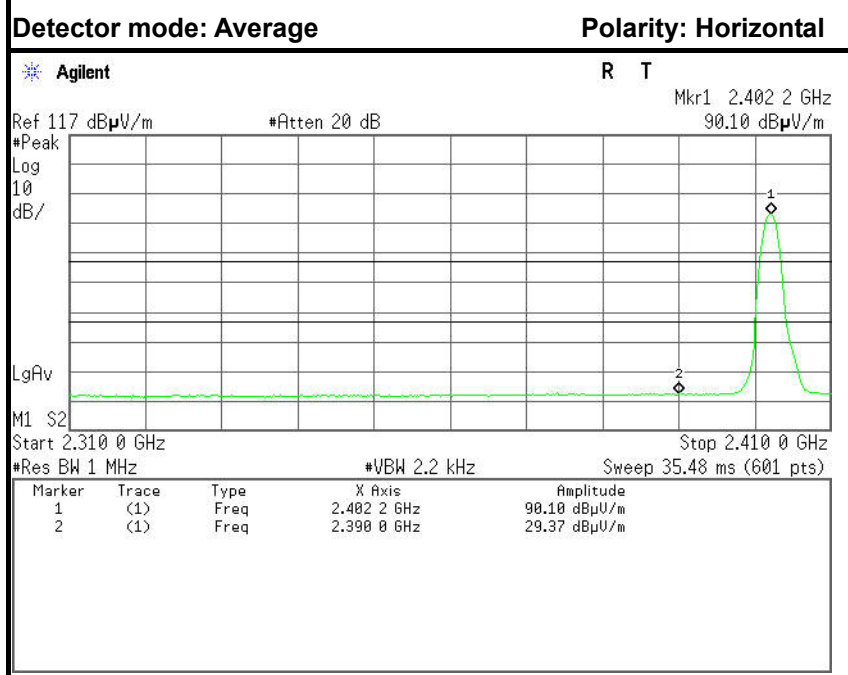
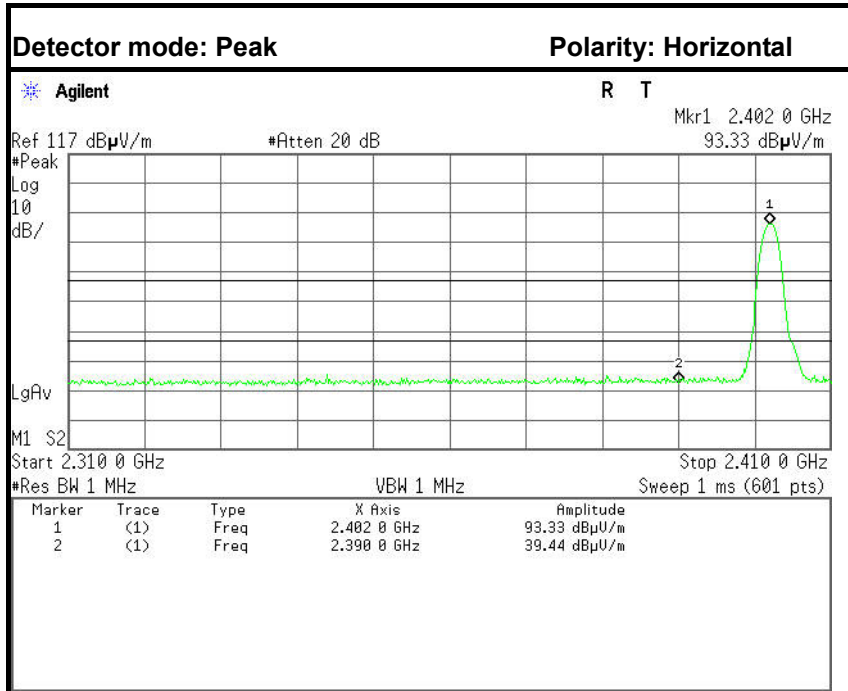

No.	Frequency (MHz)	Reading (dBuV)	Corrected (dB)	Result (dBuV)	Limit (dBuV)	Margin (dB)	Detector	Antenna Pole
1	2390.0000	32.84	-6.60	39.44	74.00	-34.56	Peak	Horizontal
2	2390.0000	22.77	-6.60	29.37	54.00	-24.63	Average	Horizontal



Band Edges (CH-High)

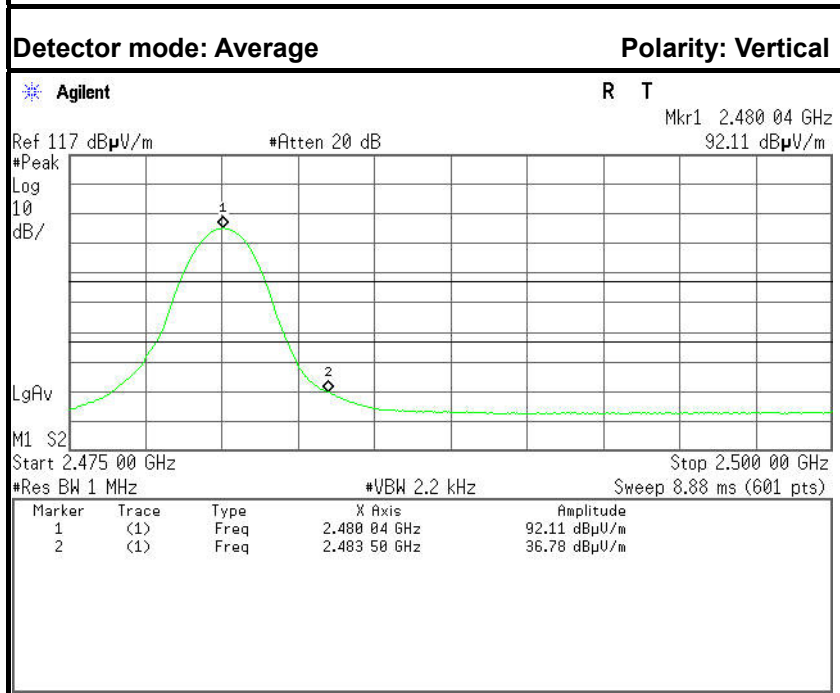
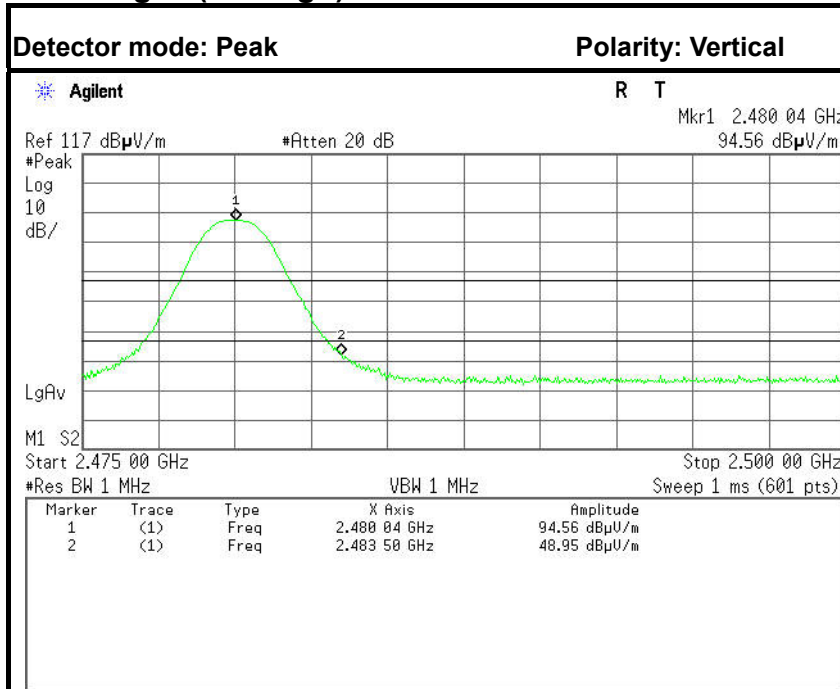

No.	Frequency (MHz)	Reading (dBuV)	Corrected (dB)	Result (dBuV)	Limit (dBuV)	Margin (dB)	Detector	Antenna Pole
1	2483.5000	42.71	-6.24	48.95	74.00	-25.05	Peak	Vertical
2	2483.5000	30.54	-6.24	36.78	54.00	-17.22	Average	Vertical

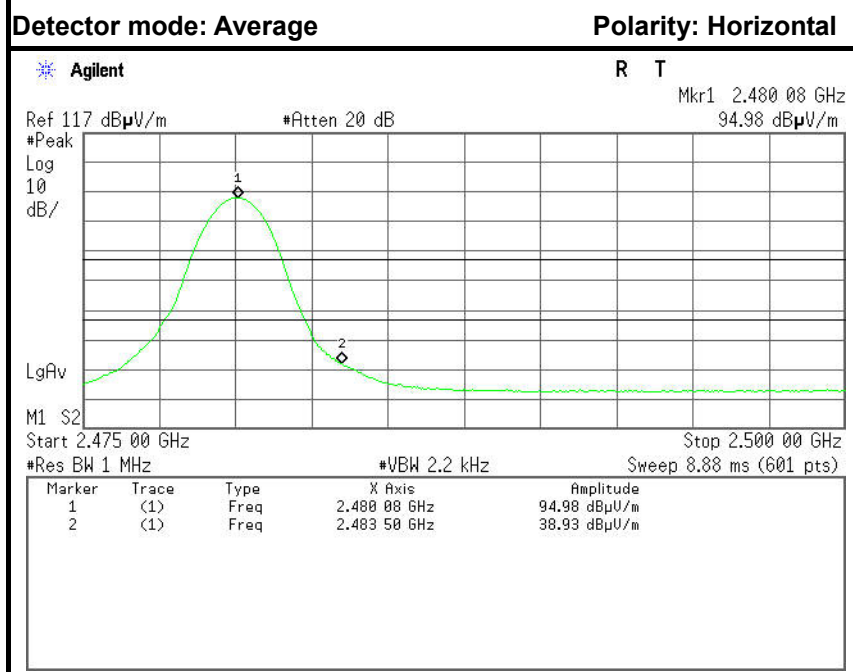
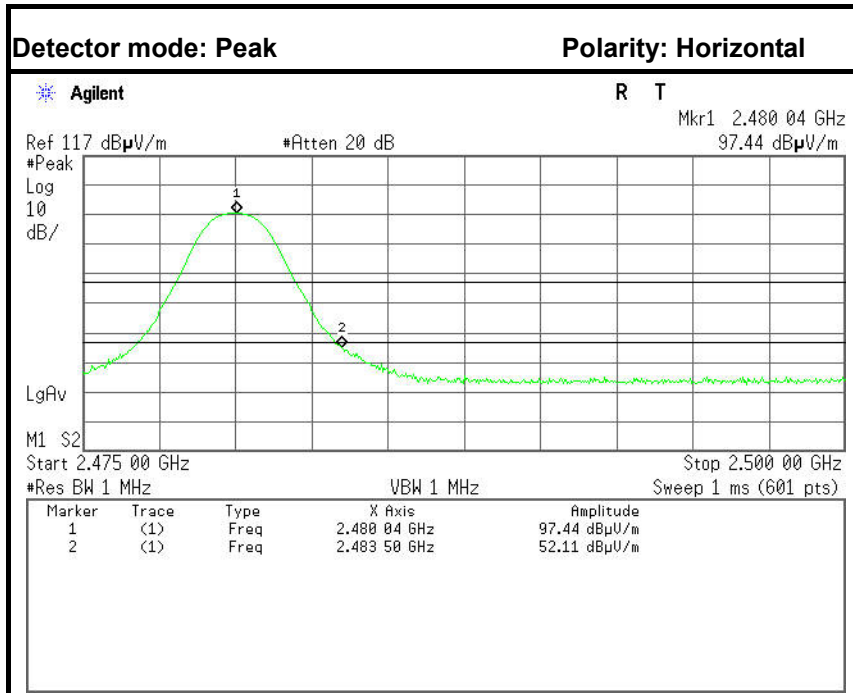

No.	Frequency (MHz)	Reading (dB μ V)	Corrected (dB)	Result (dB μ V)	Limit (dB μ V)	Margin (dB)	Detector	Antenna Pole
1	2483.5000	45.87	-6.24	52.11	74.00	-21.89	Peak	Horizontal
2	2483.5000	32.69	-6.24	38.93	54.00	-15.07	Average	Horizontal



6.5 FREQUENCY SEPARATION

LIMIT

According to §15.247(a)(1), Frequency hopping systems shall have hopping channel carrier frequencies separated by a minimum of 25 kHz or the 20 dB bandwidth of the hopping channel, whichever is greater. Alternatively, frequency hopping systems operating in the 2400-2483.5 MHz band may have hopping channel carrier frequencies that are separated by 25 kHz or two-thirds of the 20 dB bandwidth of the hopping channel, whichever is greater, provided the systems operate with an output power no greater than 125 mW.

MEASUREMENT EQUIPMENT USED

Name of Equipment	Manufacturer	Model	Serial Number	Last Calibration	Due Calibration
Spectrum Analyzer	Agilent	E4446A	US44300399	03/01/2014	03/01/2015

Remark: Each piece of equipment is scheduled for calibration once a year.

Test Configuration

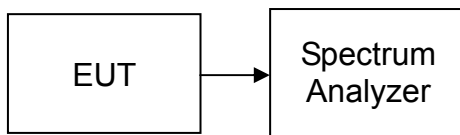

TEST PROCEDURE

1. Place the EUT on the table and set it in transmitting mode.
2. Remove the antenna from the EUT and then connect a low loss RF cable from the antenna port to the spectrum analyzer.
3. Set center frequency of spectrum analyzer = middle of hopping channel.
4. Set the spectrum analyzer as RBW=30kHz, VBW=30kHz, Adjust Span to 4 MHz, Sweep = auto.
5. Max hold. Mark 3 Peaks of hopping channel and record the 3 peaks frequency.

TEST RESULTS

No non-compliance noted

Test Data

GFSK

Channel Separation (MHz)	Two-thirds of the 20 dB Bandwidth (kHz)	Channel Separation Limit	Result
1.000	583.086	> Two-thirds of the 20 dB Bandwidth	Pass

8DPSK

Channel Separation (MHz)	Two-thirds of the 20 dB Bandwidth (kHz)	Channel Separation Limit	Result
1.000	810.000	> Two-thirds of the 20 dB Bandwidth	Pass



GFSK

Test Plot

Measurement of Channel Separation

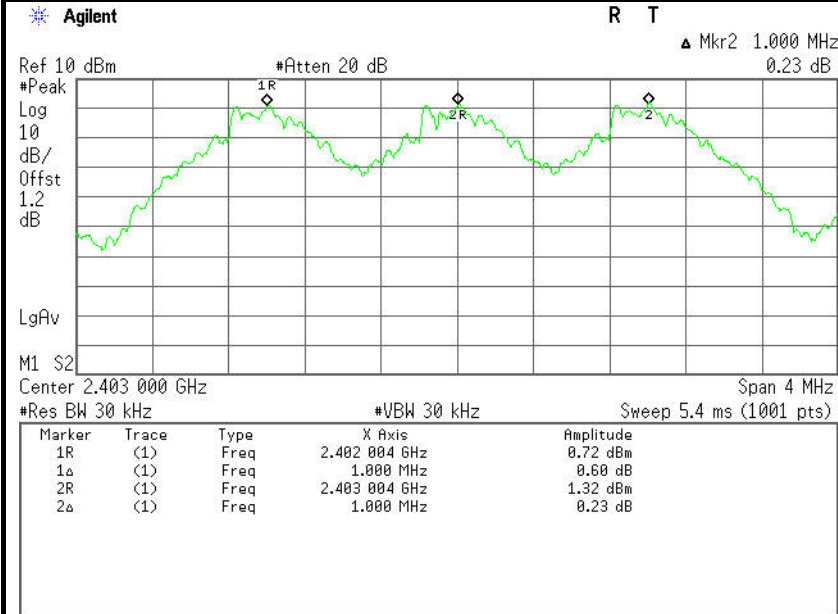

20 dB bandwidth(CH Low)

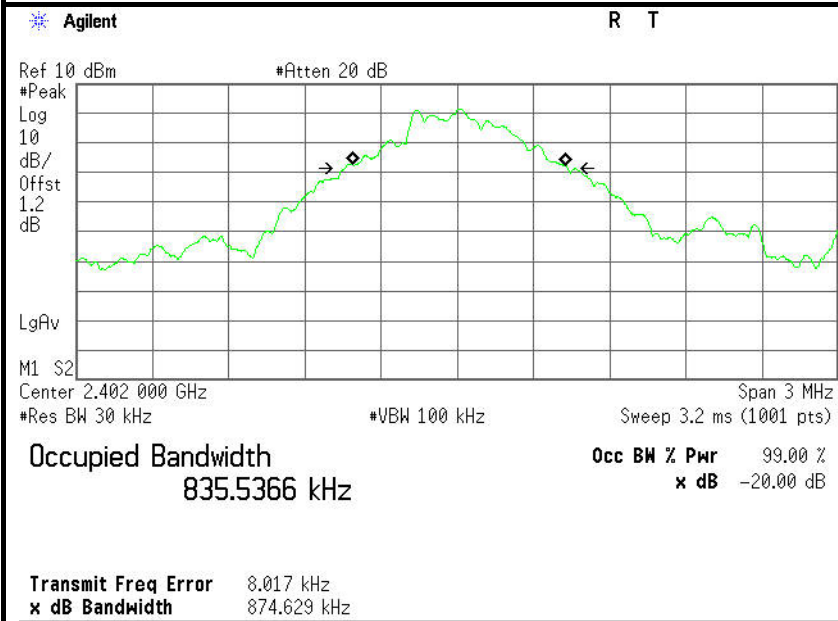



8DPSK

Test Plot

Measurement of Channel Separation

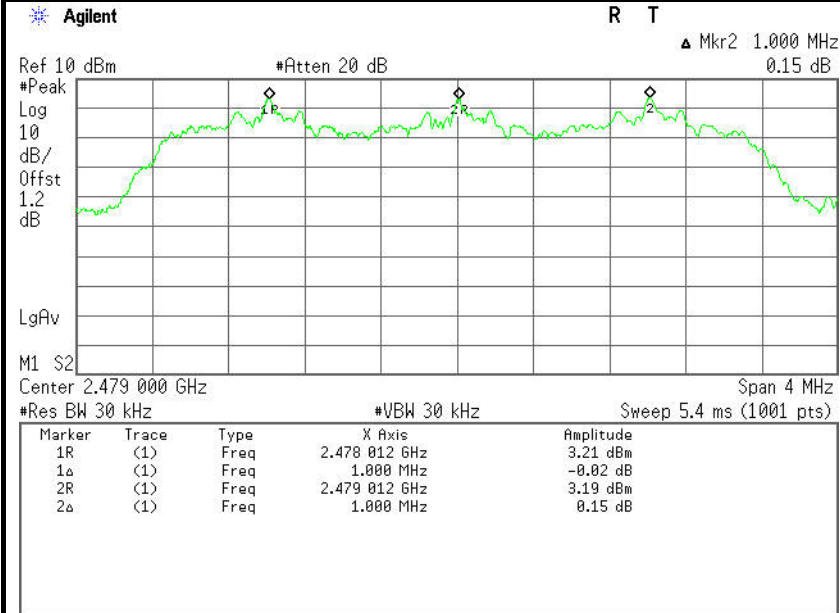

20 dB bandwidth(CH High)

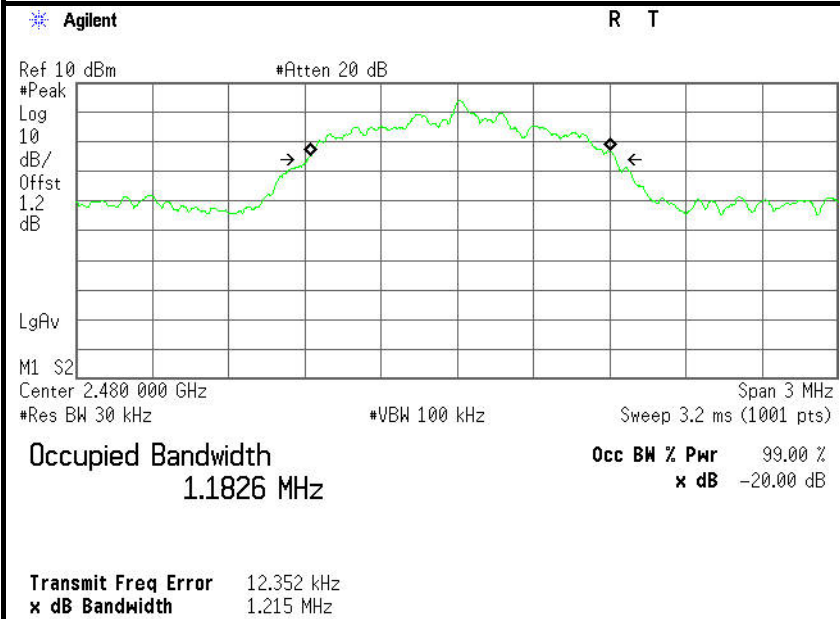



6.6 NUMBER OF HOPPING FREQUENCY

LIMIT

According to §15.247(a)(1)(ii), Frequency hopping systems operating in the 2400MHz-2483.5 MHz bands shall use at least 15 hopping frequencies.

MEASUREMENT EQUIPMENT USED

Name of Equipment	Manufacturer	Model	Serial Number	Last Calibration	Due Calibration
Spectrum Analyzer	Agilent	E4446A	US44300399	03/01/2014	03/01/2015

Remark: Each piece of equipment is scheduled for calibration once a year.

Test Configuration

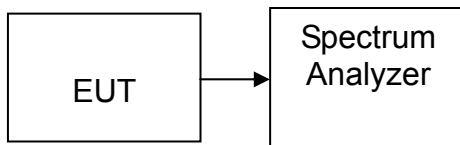

TEST PROCEDURE

1. Place the EUT on the table and set it in transmitting mode.
2. Remove the antenna from the EUT and then connect a low loss RF cable from the antenna port to the spectrum analyzer.
3. Set spectrum analyzer Start=2400MHz, Stop = 2483.5MHz, Sweep = 1ms.
4. Set the spectrum analyzer as RBW, VBW=300kHz,
5. Max hold, view and count how many channel in the band.

TEST RESULTS

No non-compliance noted

Test Data

Result (No. of CH)	Limit (No. of CH)	Result
79	>15	PASS



Test Plot

Channel Number

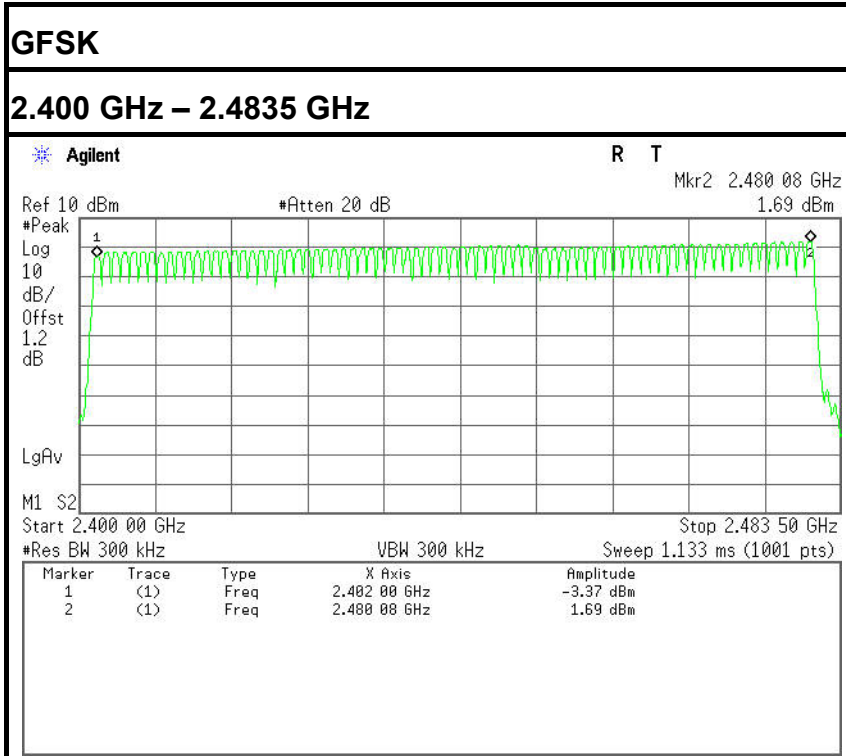

8DPSK

2.400 GHz – 2.4835 GHz

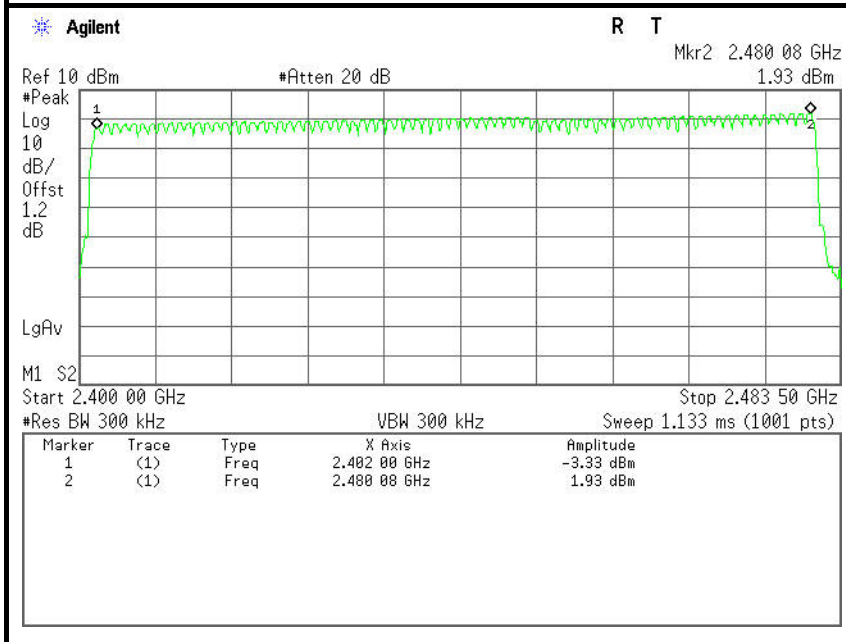



6.7 TIME OF OCCUPANCY (DWELL TIME)

LIMIT

According to §15.247(a)(1)(iii), Frequency hopping systems operating in the 2400MHz-2483.5 MHz bands. The average time of occupancy on any channels shall not greater than 0.4 s within a period 0.4 s multiplied by the number of hopping channels employed.

MEASUREMENT EQUIPMENT USED

Name of Equipment	Manufacturer	Model	Serial Number	Last Calibration	Due Calibration
Spectrum Analyzer	Agilent	E4446A	US44300399	03/01/2014	03/01/2015

Remark: Each piece of equipment is scheduled for calibration once a year.

Test Configuration

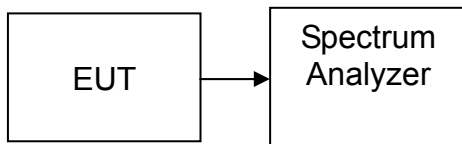

TEST PROCEDURE

1. Place the EUT on the table and set it in transmitting mode.
2. Remove the antenna from the EUT and then connect a low loss RF cable from the antenna port to the spectrum analyzer.
3. Set center frequency of spectrum analyzer = operating frequency.
4. Set the spectrum analyzer as RBW, VBW=1MHz, Span = 0Hz, Sweep = auto.
5. Repeat above procedures until all frequency measured were complete.



TEST RESULTS

No non-compliance noted

Test Data

GFSK

DH 1

CH Mid: $0.432 * (1600/2)/79 * 31.6 = 138.240(\text{ms})$

CH	Pulse Time (ms)	Total of Dwell (ms)	Period Time (s)	Limit (ms)	Result
Mid	0.432	138.240	31.60	400.00	PASS

DH 3

CH Mid: $1.701 * (1600/4)/79 * 31.6 = 272.160 (\text{ms})$

CH	Pulse Time (ms)	Total of Dwell (ms)	Period Time (s)	Limit (ms)	Result
Mid	1.701	272.160	31.60	400.00	PASS

DH 5

CH Mid: $2.945 * (1600/6)/79 * 31.6 = 314.133(\text{ms})$

CH	Pulse Time (ms)	Total of Dwell (ms)	Period Time (s)	Limit (ms)	Result
Mid	2.945	314.133	31.60	400.00	PASS



Test Data

8DPSK

DH 1

CH Mid: $0.444 * (1600/2)/79 * 31.6 = 142.080$ (ms)

CH	Pulse Time (ms)	Total of Dwell (ms)	Period Time (s)	Limit (ms)	Result
Mid	0.444	142.080	31.60	400.00	PASS

DH 3

CH Mid: $1.698 * (1600/4)/79 * 31.6 = 271.680$ (ms)

CH	Pulse Time (ms)	Total of Dwell (ms)	Period Time (s)	Limit (ms)	Result
Mid	1.698	271.680	31.60	400.00	PASS

DH 5

CH Mid: $2.950 * (1600/6)/79 * 31.6 = 314.667$ (ms)

CH	Pulse Time (ms)	Total of Dwell (ms)	Period Time (s)	Limit (ms)	Result
Mid	2.950	314.667	31.60	400.00	PASS



Test Plot

GFSK

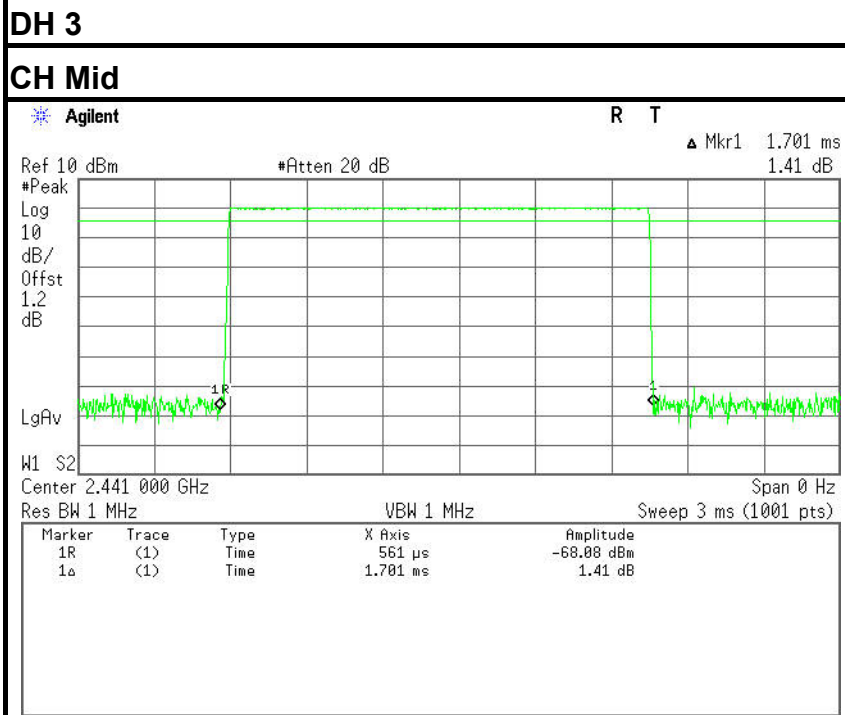
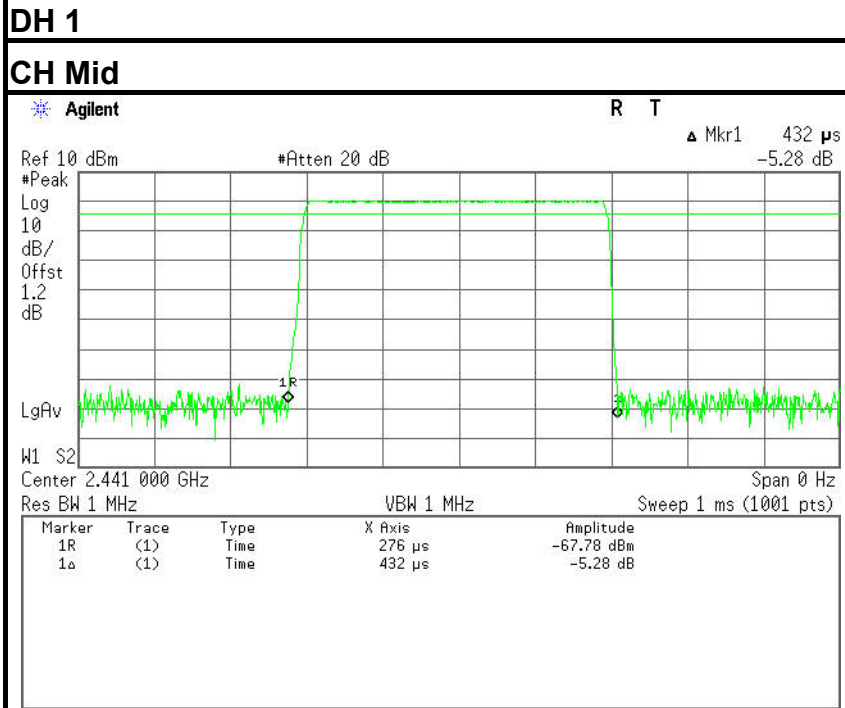

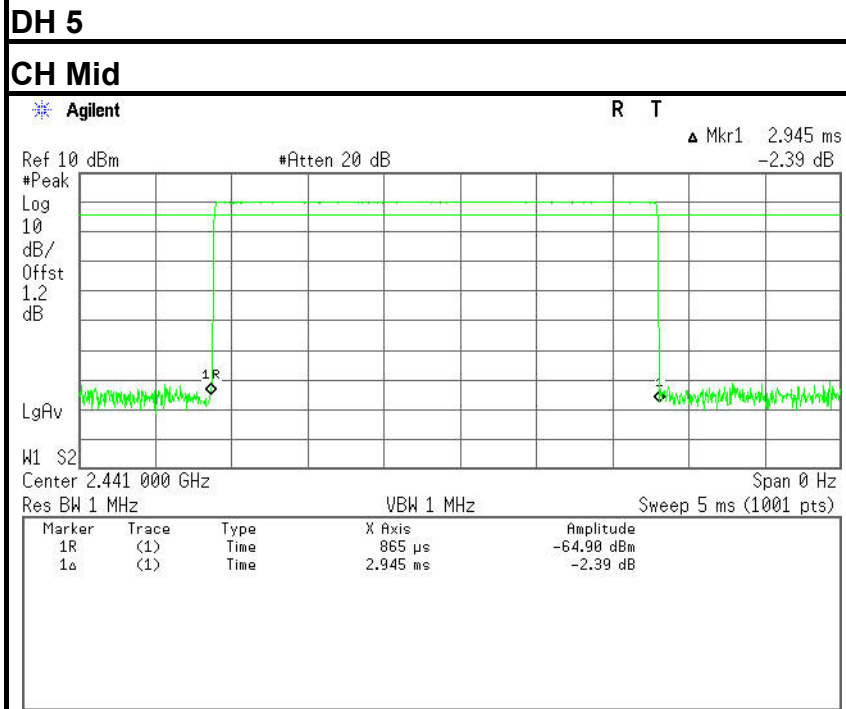



Test Plot
8DPSK

DH 1

CH Mid

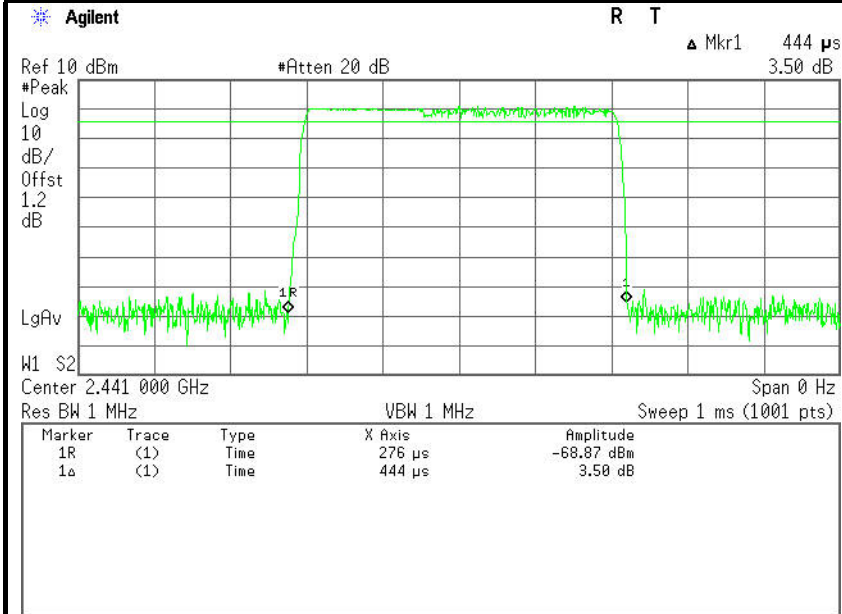

DH 3

CH Mid

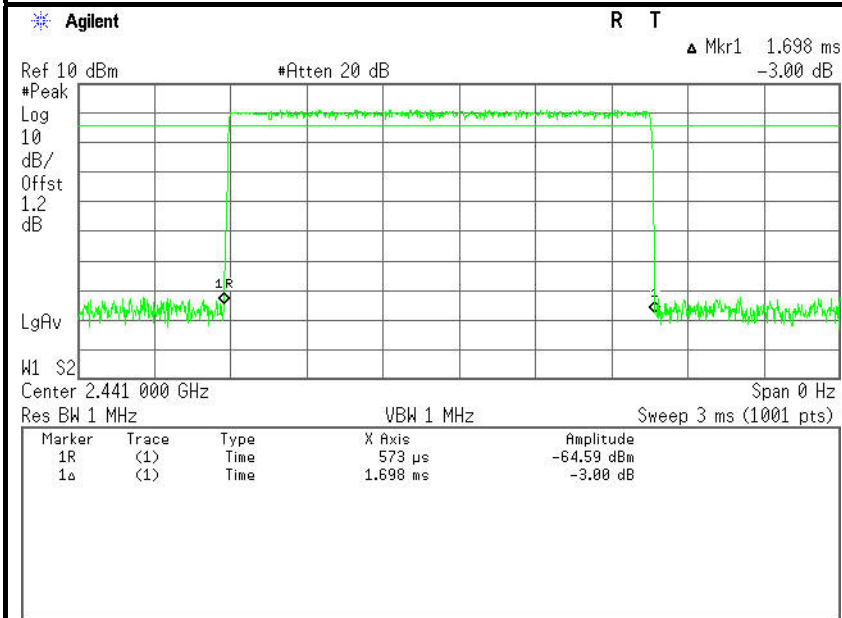

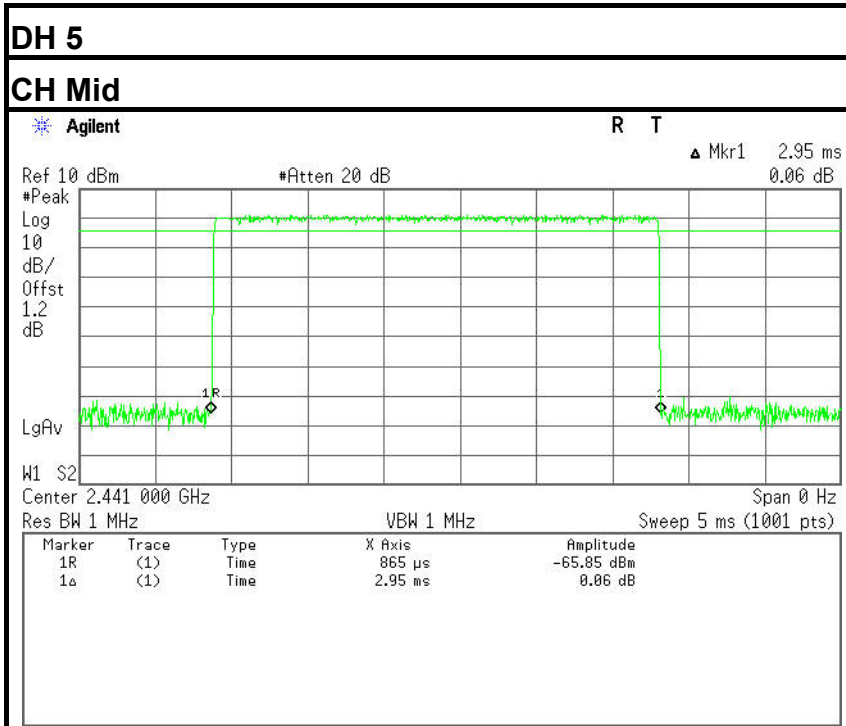



6.8 SPURIOUS EMISSIONS

6.8.1. CONDUCTED MEASUREMENT

LIMIT

In any 100 kHz bandwidth outside the frequency band in which the spread spectrum or digitally modulated intentional radiator is operating, the radio frequency power that is produced by the intentional radiator shall be at least 20 dB below that in the 100 kHz bandwidth within the band that contains the highest level of the desired power, based on either an RF conducted or a radiated measurement. Attenuation below the general limits specified in Section 15.209(a) is not required. In addition, radiated emissions which fall in the restricted bands, as defined in Section 15.205(a), must also comply with the radiated emission limits specified in Section 15.209(a) (see Section 15.205(c)).

MEASUREMENT EQUIPMENT USED

Name of Equipment	Manufacturer	Model	Serial Number	Last Calibration	Due Calibration
Spectrum Analyzer	Agilent	E4446A	US44300399	03/01/2014	03/01/2015

Remark: Each piece of equipment is scheduled for calibration once a year.

Test Configuration

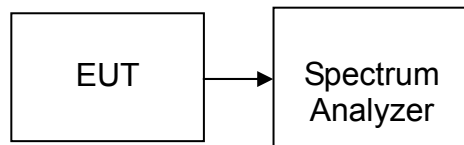

TEST PROCEDURE

Conducted RF measurements of the transmitter output were made to confirm that the EUT antenna port conducted emissions meet the specified limit and to identify any spurious signals that require further investigation or measurements on the radiated emissions site.

The transmitter output is connected to the spectrum analyzer. The resolution bandwidth is set to 100 kHz. The video bandwidth is set to 100 kHz.

Measurements are made over the 30MHz to 26GHz range with the transmitter set to the lowest, middle, and highest channels.

TEST RESULTS

No non-compliance noted

Remark: The hopping on mode and hopping off mode were chosen for pre-test and the hopping off mode was the worse case and print in the report.



Test Plot (GFSK)

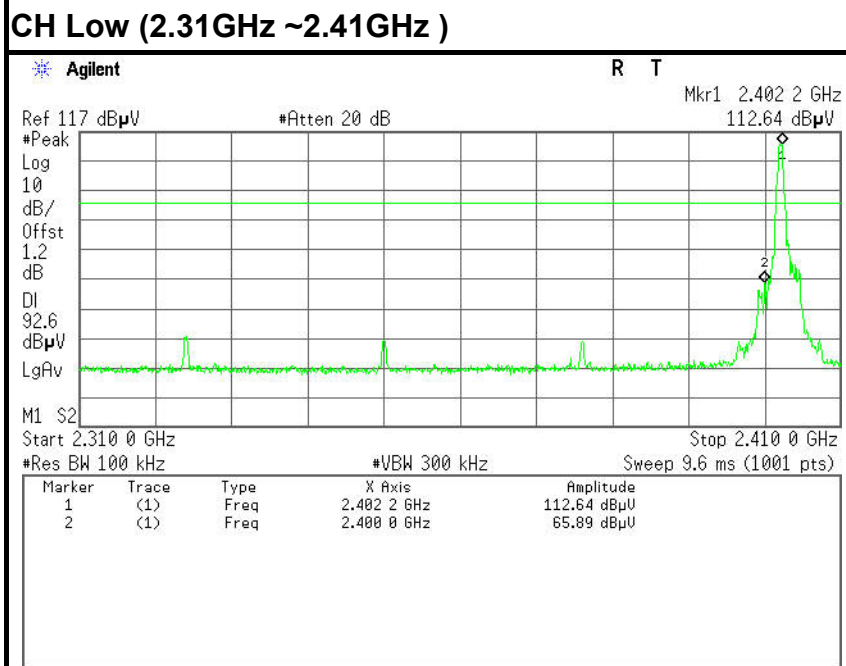
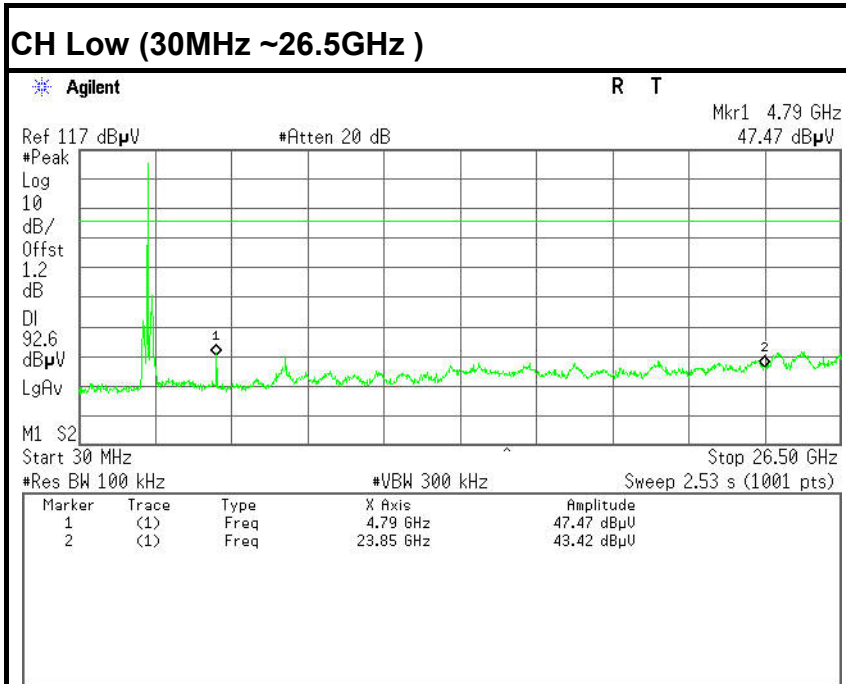

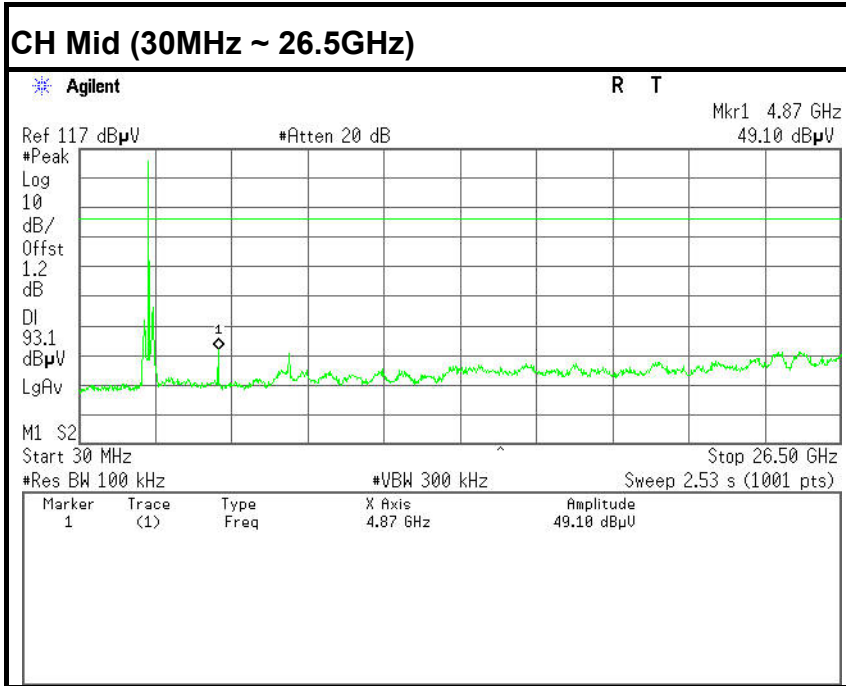



CH High (30MHz ~ 26.5GHz)

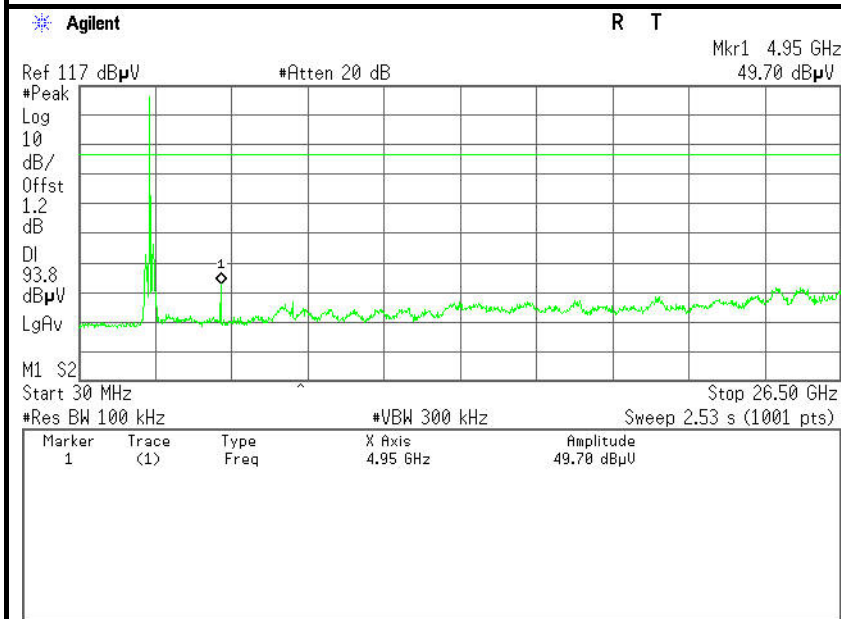

CH High (2.475GHz ~ 2.5GHz)

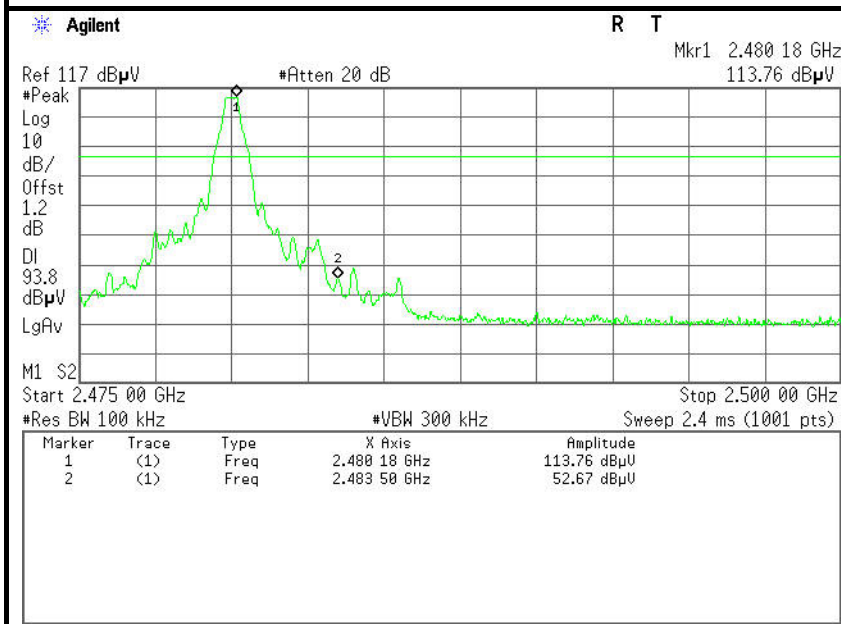



Test Plot (8DPSK)

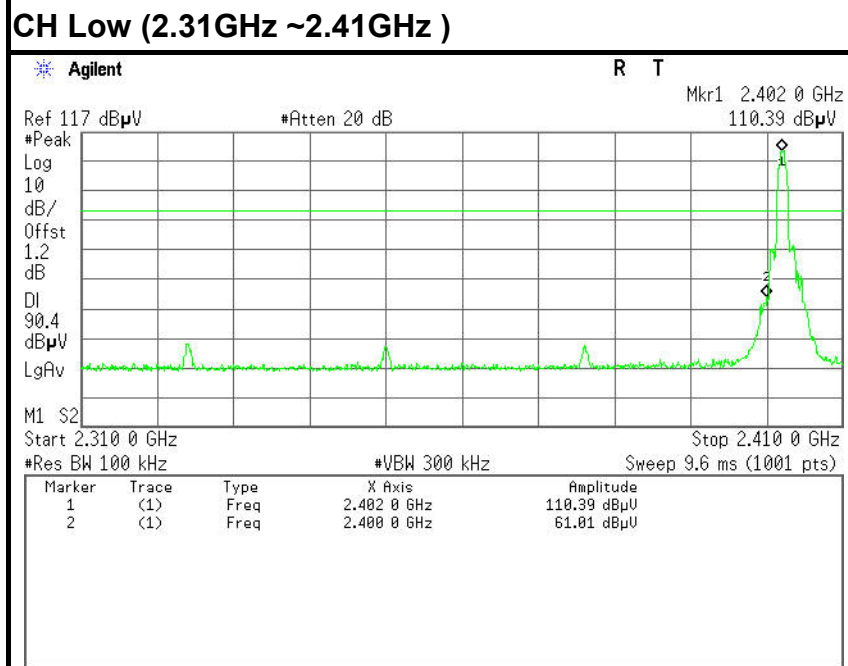
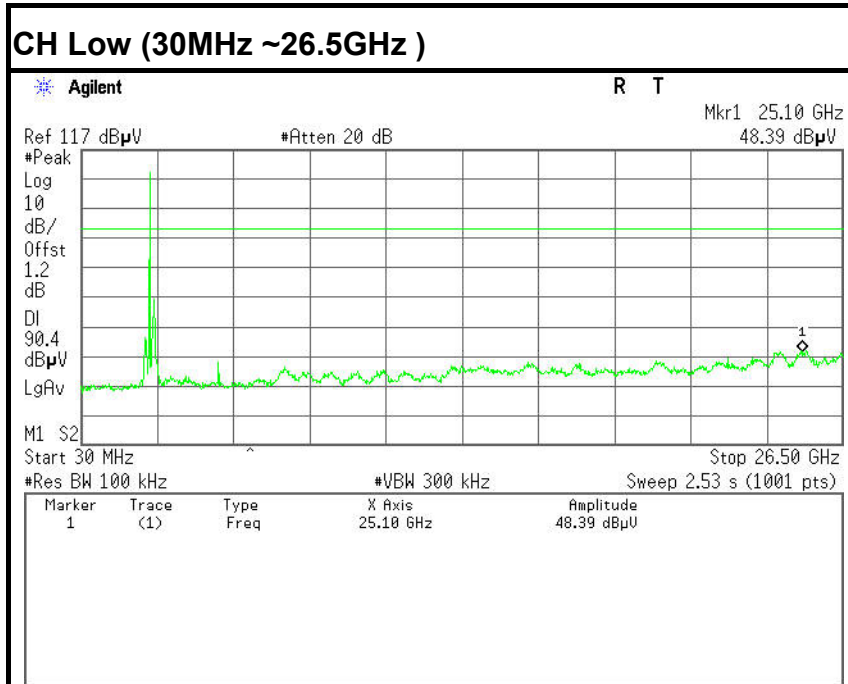

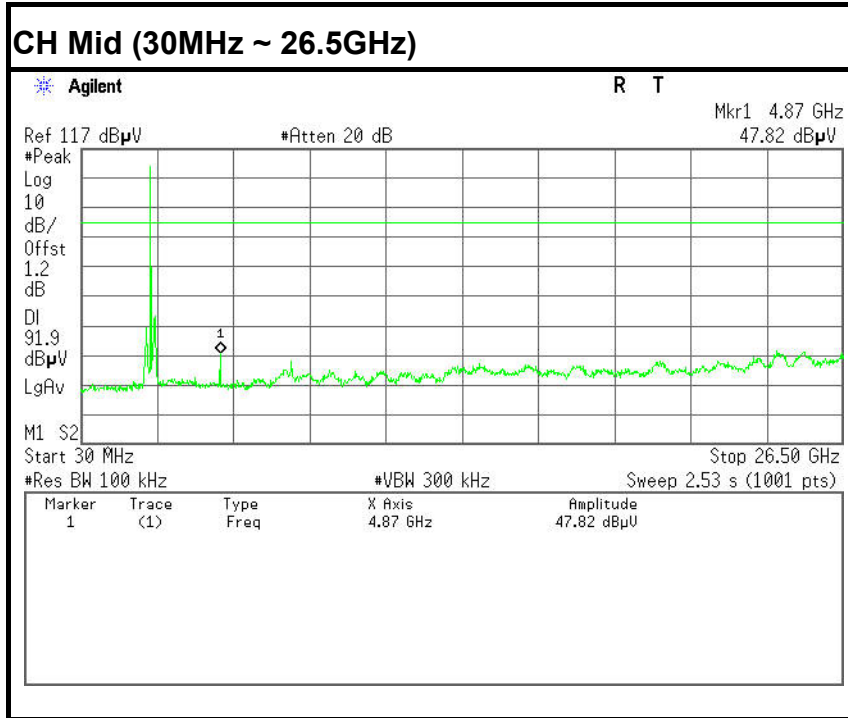



CH High (30MHz ~ 26.5GHz)

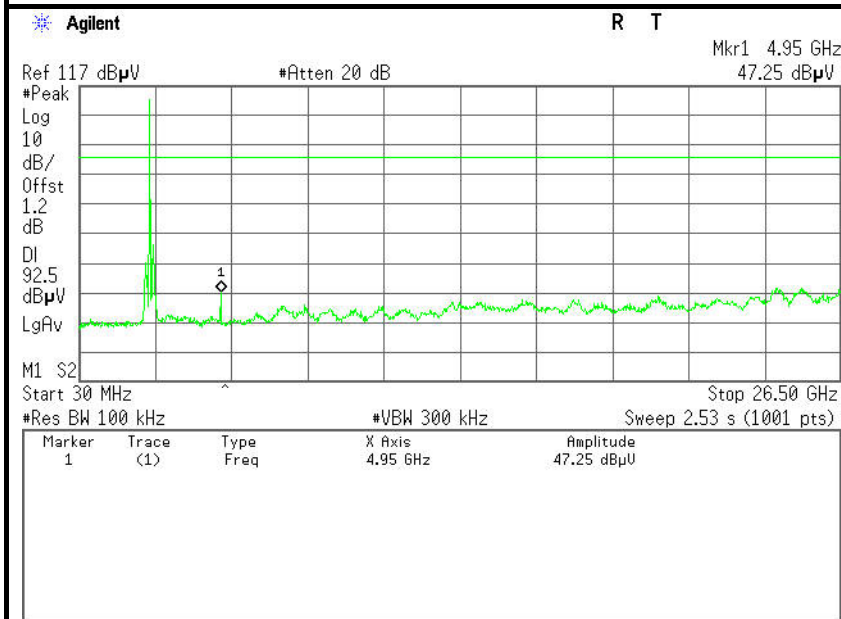

CH High (2.475GHz ~ 2.5GHz)

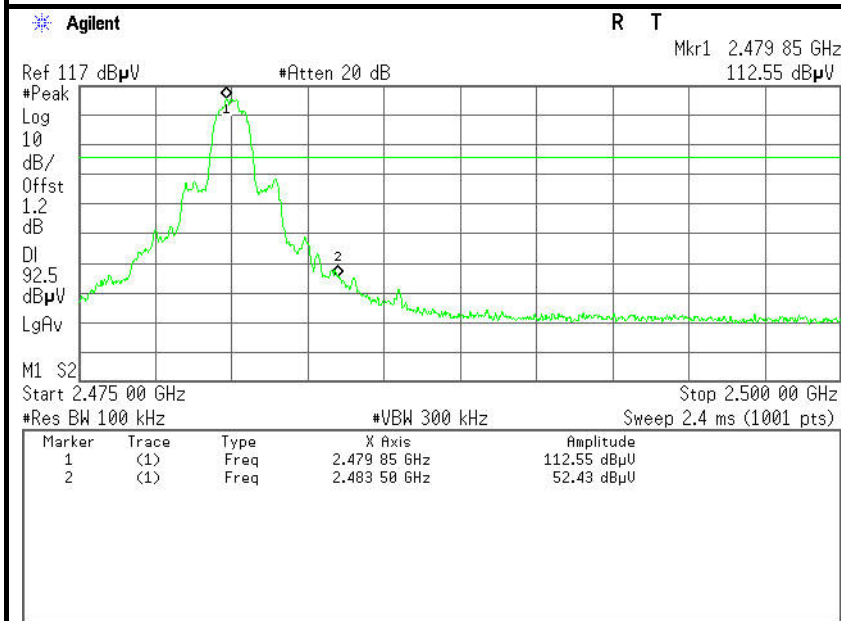



6.8.2. Radiated Emissions

LIMIT

1. Except as provided elsewhere in this Subpart, the emissions from an intentional radiator shall not exceed the field strength levels specified in the following table:

Frequency (MHz)	Field Strength (mV/m)	Measurement Distance (m)
0.009-0.490	2400/F(kHz)	300
0.490-1.705	24000/F(kHz)	30
1.705-30.0	30	30
30-88	100*	3
88-216	150*	3
216-960	200*	3
Above 960	500	3

Note: Except as provided in paragraph (g), fundamental emissions from intentional radiators operating under this Section shall not be located in the frequency bands 54-72 MHz, 76-88 MHz, 174-216 MHz or 470-806 MHz. However, operation within these frequency bands is permitted under other sections of this Part, e.g., Sections 15.231 and 15.241.

2. In the above emission table, the tighter limit applies at the band edges.

Frequency (Hz)	Field Strength (µV/m at 3-meter)	Field Strength (dBµV/m at 3-meter)
30-88	100	40
88-216	150	43.5
216-960	200	46
Above 960	500	54



MEASUREMENT EQUIPMENT USED

Radiated Emission Test Site 966 (2)					
Name of Equipment	Manufacturer	Model Number	Serial Number	Last Calibration	Due Calibration
PSA Series Spectrum Analyzer	Agilent	E4446A	US44300399	03/01/2014	03/01/2015
EMI TEST RECEIVER	ROHDE&SCHWARZ	ESCI	100783	03/09/2014	03/08/2015
Amplifier	MITEQ	AM-1604-3000	1123808	03/18/2014	03/17/2015
High Noise Amplifier	Agilent	8449B	3008A01838	03/18/2014	03/17/2015
Board-Band Horn Antenna	Schwarzbeck	BBHA 9170	9170-497	07/10/2014	07/09/2015
Bilog Antenna	SCHAFFNER	CBL6143	5082	03/01/2014	03/01/2015
Horn Antenna	SCHWARZBECK	BBHA9120	D286	03/01/2014	03/01/2015
Loop Antenna	A. R. A	PLA-1030/B	1029	09/27/2014	09/26/2015
Turn Table	N/A	N/A	N/A	N.C.R	N.C.R
Controller	Sunol Sciences	SC104V	022310-1	N.C.R	N.C.R
Controller	CT	N/A	N/A	N.C.R	N.C.R
Temp. / Humidity Meter	Anymetre	JR913	N/A	02/28/2014	02/27/2015
Antenna Tower	SUNOL	TLT2	N/A	N.C.R	N.C.R
Test S/W	FARAD	LZ-RF / CCS-SZ-3A2			

Remark: Each piece of equipment is scheduled for calibration once a year.

Test Configuration

Below 30MHz

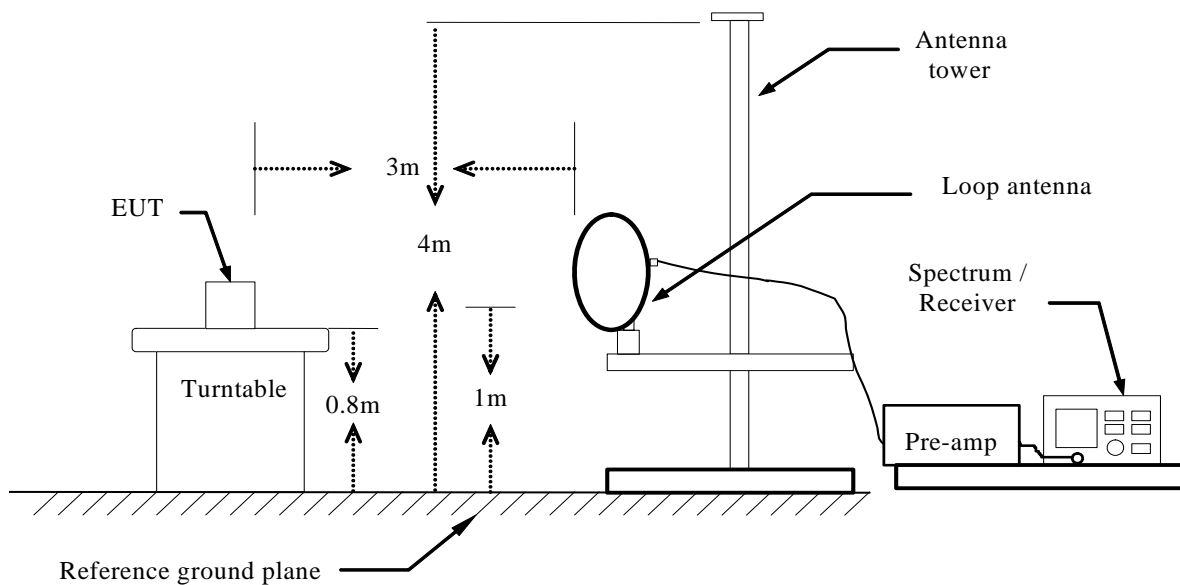



Below 1 GHz

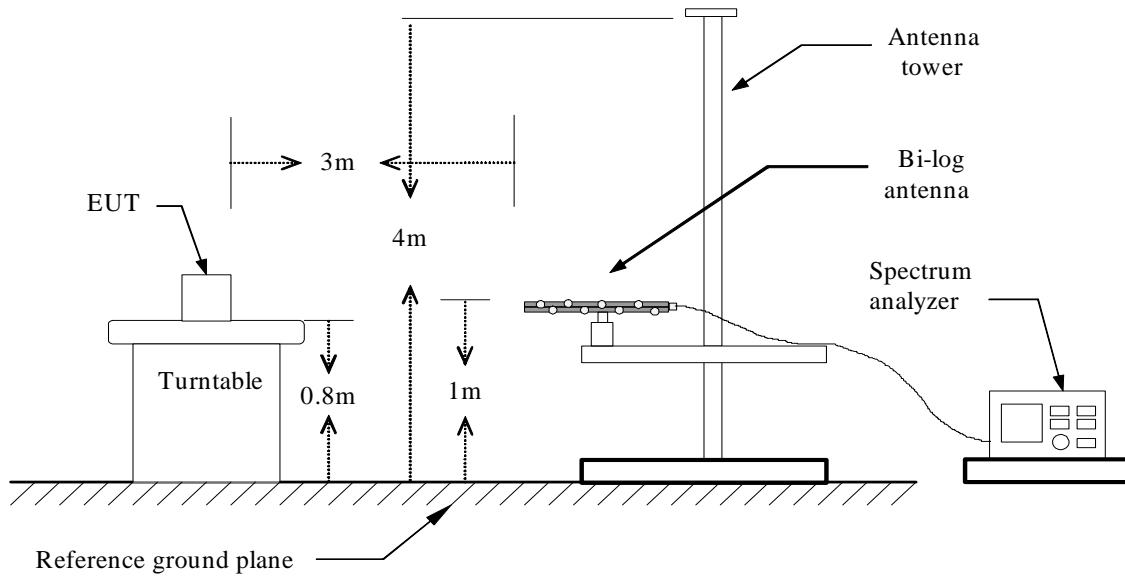

Above 1 GHz

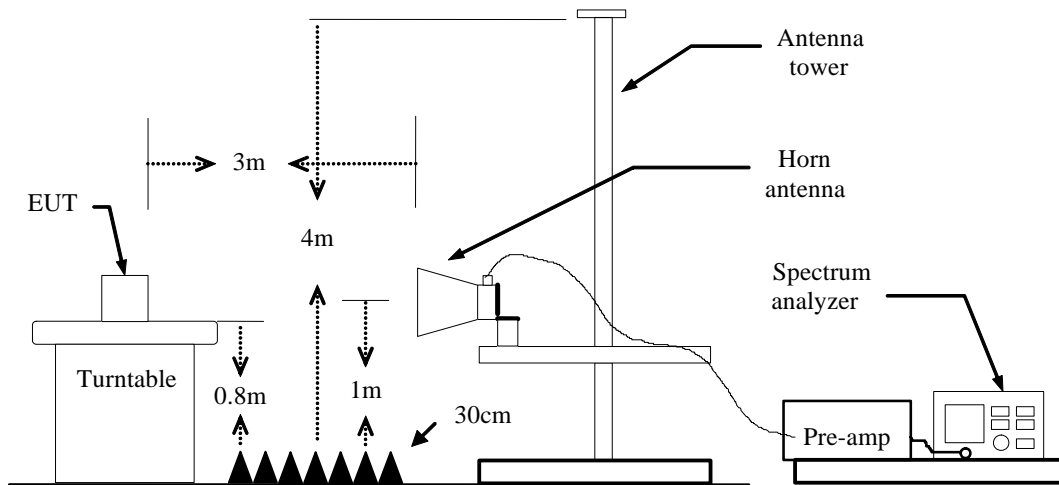



TEST PROCEDURE

1. The EUT is placed on a turntable, which is 0.8m above ground plane.
2. The turntable shall be rotated for 360 degrees to determine the position of maximum emission level.
3. EUT is set 3m away from the receiving antenna, which is varied from 1m to 4m to find out the highest emissions.
4. Maximum procedure was performed on the six highest emissions to ensure EUT compliance.
5. And also, each emission was to be maximized by changing the polarization of receiving antenna both horizontal and vertical.
6. Repeat above procedures until the measurements for all frequencies are complete.



TEST RESULTS

Below 1 GHz

Test Mode: TX

Tested by: Mack Li

Ambient temperature: 24°C Relative humidity: 52% RH Date: November 28, 2014

Frequency (MHz)	Reading (dBuV)	Correction Factor (dB/m)	Result (dBuV/m)	Limit (dBuV/m)	Margin (dB)	Antenna Pole (V/H)	Remark
38.5264	45.62	-15.72	29.90	40.00	-10.10	V	QP
475.0324	31.26	-14.54	16.72	46.00	-29.28	V	QP
574.1521	31.38	-13.06	18.32	46.00	-27.68	V	QP
638.8110	30.98	-12.47	18.51	46.00	-27.49	V	QP
777.6022	31.71	-11.20	20.51	46.00	-25.49	V	QP
848.4190	32.01	-10.70	21.31	46.00	-24.69	V	QP
38.4080	45.68	-15.68	30.00	40.00	-10.00	H	QP
395.0971	31.89	-16.26	15.63	46.00	-30.37	H	QP
477.2824	31.37	-14.46	16.91	46.00	-29.09	H	QP
547.0333	31.03	-13.15	17.88	46.00	-28.12	H	QP
707.0223	30.27	-11.91	18.36	46.00	-27.64	H	QP
834.8004	31.52	-10.66	20.86	46.00	-25.14	H	QP

****Remark:** No emission found between lowest internal used/generated frequency to 30MHz.

Notes:

1. Measuring frequencies from 9kHz to the 1GHz.
2. Radiated emissions measured in frequency range from 30MHz to 1GHz were made with an instrument using Peak/Quasi-peak detector mode.
3. Data of measurement within this frequency range shown " --- " in the table above means the reading of emissions are attenuated more than 20dB below the permissible limits or the field strength is too small to be measured.
4. The IF bandwidth of SPA between 30MHz to 1GHz was 120kHz.
5. Frequency (MHz). = Emission frequency in MHz
Reading (dBuV) = Receiver reading
Correction Factor(dB/m) = Antenna factor + Cable loss – Amplifier gain
Actual FS (dBuV/m) = Reading (dBuV) + Corr. Factor (dB/m)
Limit (dBuV/m) = Limit stated in standard
Margin(dB) = Measured (dBuV/m) – Limits (dBuV/m)
Antenna Pole(V/H) = Current carrying line of reading



Above 1 GHz
GFSK

Test Mode: TX(CH Low)

Tested by: Mack Li

Ambient temperature: 24°C Relative humidity: 52% RH Date: November 28, 2014

Frequency (MHz)	Reading (dBuV)	Correction Factor (dB/m)	Result (dBuV/m)	Limit (dBuV/m)	Margin (dB)	Antenna Pole (V/H)	Remark
1999.000	51.64	-5.01	46.63	74.00	-27.37	V	peak
3323.125	43.92	-0.82	43.10	74.00	-30.90	V	peak
4804.750	43.64	4.34	47.98	74.00	-26.02	V	peak
5577.625	39.67	5.90	45.57	74.00	-28.43	V	peak
7206.625	42.79	8.10	50.89	74.00	-23.11	V	peak
8032.375	39.82	9.63	49.45	74.00	-24.55	V	peak
1663.750	49.91	-6.56	43.35	74.00	-30.65	H	Peak
1996.750	52.25	-5.02	47.23	74.00	-26.77	H	Peak
3262.375	43.30	-0.92	42.38	74.00	-31.62	H	Peak
4804.750	46.42	4.34	50.76	74.00	-23.24	H	peak
5704.750	39.94	5.96	45.90	74.00	-28.10	H	peak
7206.625	42.87	8.10	50.97	74.00	-23.03	H	peak

Notes:

1. Measuring frequencies from 1 GHz to the 10th harmonic of highest fundamental frequency.
2. Measurements above show only up to 6 maximum emissions noted, or would be lesser if no specific emissions from the EUT are recorded (ie: margin>20dB from the applicable limit) and considered that's already beyond the background noise floor.
3. Radiated emissions measured in frequency above 1000MHz were made with an instrument using Peak detector mode and average detector mode of the emission shown in Actual FS column.
4. Spectrum setting:
 - a. Peak Setting 1GHz - 26GHz, RBW = 1MHz, VBW = 1MHz, Sweep time = 200 ms.
 - b. AV Setting 1GH z- 26GHz, RBW = 1MHz, VBW = 10Hz, Sweep time = 200 ms.
5. Frequency (MHz) = Emission frequency in MHz
 Reading (dBuV/m) =Uncorrected Analyzer / Receiver Reading
 Correction Factor (dB) = Antenna factor + Cable loss – Amplifier gain
 Limit (dBuV/m) = Limit stated in standard
 Margin (dB) = Result (dBuV/m)- Limit (dBuV/m)
 Pk = Peak Reading
 AV. = Average Reading
 Remark = Mark Peak Reading or Average Reading



Test Mode: TX(CH Mid)

Tested by: Mack Li

Ambient temperature: 24°C Relative humidity: 52% RH Date: November 28, 2014

Frequency (MHz)	Reading (dBuV)	Correction Factor (dB/m)	Result (dBuV/m)	Limit (dBuV/m)	Margin (dB)	Antenna Pole (V/H)	Remark
1999.000	51.13	-5.01	46.12	74.00	-27.88	V	peak
3323.125	44.58	-0.82	43.76	74.00	-30.24	V	peak
4882.375	43.20	4.60	47.80	74.00	-26.20	V	peak
6529.375	40.45	6.94	47.39	74.00	-26.61	V	peak
7322.500	41.37	8.33	49.70	74.00	-24.30	V	peak
8591.500	39.79	9.32	49.11	74.00	-24.89	V	peak
2000.125	50.90	-5.00	45.90	74.00	-28.10	H	Peak
3034.000	42.71	-1.30	41.41	74.00	-32.59	H	Peak
4425.625	40.77	3.09	43.86	74.00	-30.14	H	Peak
4882.375	46.77	4.60	51.37	74.00	-22.63	H	peak
5684.500	40.20	5.95	46.15	74.00	-27.85	H	peak
7323.625	43.36	8.33	51.69	74.00	-22.31	H	peak

Notes:

1. Measuring frequencies from 1 GHz to the 10th harmonic of highest fundamental frequency.
2. Measurements above show only up to 6 maximum emissions noted, or would be lesser if no specific emissions from the EUT are recorded (ie: margin>20dB from the applicable limit) and considered that's already beyond the background noise floor.
3. Radiated emissions measured in frequency above 1000MHz were made with an instrument using Peak detector mode and average detector mode of the emission shown in Actual FS column.
4. Spectrum setting:
 - a. Peak Setting 1GHz - 26GHz, RBW = 1MHz, VBW = 1MHz, Sweep time = 200 ms.
 - b. AV Setting 1GH z- 26GHz, RBW = 1MHz, VBW = 10Hz, Sweep time = 200 ms.
5. Frequency (MHz) = Emission frequency in MHz
 Reading (dBuV/m) =Uncorrected Analyzer / Receiver Reading
 Correction Factor (dB) = Antenna factor + Cable loss – Amplifier gain
 Limit (dBuV/m) = Limit stated in standard
 Margin (dB) = Result (dBuV/m)- Limit (dBuV/m)
 Pk = Peak Reading
 AV. = Average Reading
 Remark = Mark Peak Reading or Average Reading



Test Mode: TX(CH High)

Tested by: Mack Li

Ambient temperature: 24°C Relative humidity: 52% RH Date: November 28, 2014

Frequency (MHz)	Reading (dBuV)	Correction Factor (dB/m)	Result (dBuV/m)	Limit (dBuV/m)	Margin (dB)	Antenna Pole (V/H)	Remark
1997.875	51.20	-5.01	46.19	74.00	-27.81	V	peak
3322.000	44.56	-0.82	43.74	74.00	-30.26	V	peak
4960.000	43.63	4.85	48.48	74.00	-25.52	V	peak
6040.000	39.72	6.14	45.86	74.00	-28.14	V	peak
6625.000	39.79	7.09	46.88	74.00	-27.12	V	peak
7439.500	41.36	8.56	49.92	74.00	-24.08	V	peak
1997.875	50.86	-5.01	45.85	74.00	-28.15	H	Peak
3581.875	41.55	-0.17	41.38	74.00	-32.62	H	Peak
4960.000	46.64	4.85	51.49	74.00	-22.51	H	Peak
6194.125	40.69	6.39	47.08	74.00	-26.92	H	peak
7439.500	41.37	8.56	49.93	74.00	-24.07	H	peak
8681.500	40.13	9.28	49.41	74.00	-24.59	H	peak

Notes:

1. Measuring frequencies from 1 GHz to the 10th harmonic of highest fundamental frequency.
2. Measurements above show only up to 6 maximum emissions noted, or would be lesser if no specific emissions from the EUT are recorded (ie: margin>20dB from the applicable limit) and considered that's already beyond the background noise floor.
3. Radiated emissions measured in frequency above 1000MHz were made with an instrument using Peak detector mode and average detector mode of the emission shown in Actual FS column.
4. Spectrum setting:
 - a. Peak Setting 1GHz - 26GHz, RBW = 1MHz, VBW = 1MHz, Sweep time = 200 ms.
 - b. AV Setting 1GH z- 26GHz, RBW = 1MHz, VBW = 10Hz, Sweep time = 200 ms.
5. Frequency (MHz) = Emission frequency in MHz
 Reading (dBuV/m) =Uncorrected Analyzer / Receiver Reading
 Correction Factor (dB) = Antenna factor + Cable loss – Amplifier gain
 Limit (dBuV/m) = Limit stated in standard
 Margin (dB) = Result (dBuV/m)- Limit (dBuV/m)
 Pk = Peak Reading
 AV. = Average Reading
 Remark = Mark Peak Reading or Average Reading



8DPSK

Test Mode: TX(CH Low)

Tested by: Mack Li

Ambient temperature: 24°C Relative humidity: 52% RH Date: November 28, 2014

Frequency (MHz)	Reading (dBuV)	Correction Factor (dB/m)	Result (dBuV/m)	Limit (dBuV/m)	Margin (dB)	Antenna Pole (V/H)	Remark
1996.750	51.67	-5.02	46.65	74.00	-27.35	V	peak
3325.375	44.35	-0.81	43.54	74.00	-30.46	V	peak
4803.625	39.78	4.34	44.12	74.00	-29.88	V	peak
5699.125	39.52	5.95	45.47	74.00	-28.53	V	peak
7077.250	39.86	7.85	47.71	74.00	-26.29	V	peak
8027.875	38.85	9.63	48.48	74.00	-25.52	V	peak
2000.125	51.28	-5.00	46.28	74.00	-27.72	H	Peak
3992.500	39.73	1.56	41.29	74.00	-32.71	H	Peak
4804.750	41.61	4.34	45.95	74.00	-28.05	H	Peak
6209.875	39.36	6.42	45.78	74.00	-28.22	H	peak
7205.500	39.62	8.10	47.72	74.00	-26.28	H	peak
7980.625	38.94	9.61	48.55	74.00	-25.45	H	peak

Notes:

1. Measuring frequencies from 1 GHz to the 10th harmonic of highest fundamental frequency.
2. Measurements above show only up to 6 maximum emissions noted, or would be lesser if no specific emissions from the EUT are recorded (ie: margin>20dB from the applicable limit) and considered that's already beyond the background noise floor.
3. Radiated emissions measured in frequency above 1000MHz were made with an instrument using Peak detector mode and average detector mode of the emission shown in Actual FS column.
4. Spectrum setting:
 - a. Peak Setting 1GHz - 26GHz, RBW = 1MHz, VBW = 1MHz, Sweep time = 200 ms.
 - b. AV Setting 1GH z- 26GHz, RBW = 1MHz, VBW = 10Hz, Sweep time = 200 ms.
5. Frequency (MHz) = Emission frequency in MHz
 Reading (dBuV/m) =Uncorrected Analyzer / Receiver Reading
 Correction Factor (dB) = Antenna factor + Cable loss – Amplifier gain
 Limit (dBuV/m) = Limit stated in standard
 Margin (dB) = Result (dBuV/m)- Limit (dBuV/m)
 Pk = Peak Reading
 AV. = Average Reading
 Remark = Mark Peak Reading or Average Reading



Test Mode: TX(CH Mid)

Tested by: Mack Li

Ambient temperature: 24°C Relative humidity: 52% RH Date: November 28, 2014

Frequency (MHz)	Reading (dBuV)	Correction Factor (dB/m)	Result (dBuV/m)	Limit (dBuV/m)	Margin (dB)	Antenna Pole (V/H)	Remark
2000.125	52.14	-5.00	47.14	74.00	-26.86	V	peak
3327.625	44.01	-0.81	43.20	74.00	-30.80	V	peak
4388.500	40.38	2.96	43.34	74.00	-30.66	V	peak
4882.375	41.47	4.60	46.07	74.00	-27.93	V	peak
6013.000	38.99	6.10	45.09	74.00	-28.91	V	peak
7485.625	39.39	8.65	48.04	74.00	-25.96	V	peak
1996.750	50.02	-5.02	45.00	74.00	-29.00	H	Peak
3401.875	41.71	-0.68	41.03	74.00	-32.97	H	Peak
4882.375	44.22	4.60	48.82	74.00	-25.18	H	Peak
5516.875	39.82	5.88	45.70	74.00	-28.30	H	peak
6524.875	39.47	6.93	46.40	74.00	-27.60	H	peak
8002.000	39.35	9.65	49.00	74.00	-25.00	H	peak

Notes:

1. Measuring frequencies from 1 GHz to the 10th harmonic of highest fundamental frequency.
2. Measurements above show only up to 6 maximum emissions noted, or would be lesser if no specific emissions from the EUT are recorded (ie: margin>20dB from the applicable limit) and considered that's already beyond the background noise floor.
3. Radiated emissions measured in frequency above 1000MHz were made with an instrument using Peak detector mode and average detector mode of the emission shown in Actual FS column.
4. Spectrum setting:
 - a. Peak Setting 1GHz - 26GHz, RBW = 1MHz, VBW = 1MHz, Sweep time = 200 ms.
 - b. AV Setting 1GH z- 26GHz, RBW = 1MHz, VBW = 10Hz, Sweep time = 200 ms.
5. Frequency (MHz) = Emission frequency in MHz
 Reading (dBuV/m) =Uncorrected Analyzer / Receiver Reading
 Correction Factor (dB) = Antenna factor + Cable loss – Amplifier gain
 Limit (dBuV/m) = Limit stated in standard
 Margin (dB) = Result (dBuV/m)- Limit (dBuV/m)
 Pk = Peak Reading
 AV. = Average Reading
 Remark = Mark Peak Reading or Average Reading



Test Mode: TX(CH High)

Tested by: Mack Li

Ambient temperature: 24°C Relative humidity: 52% RH Date: November 28, 2014

Frequency (MHz)	Reading (dBuV)	Correction Factor (dB/m)	Result (dBuV/m)	Limit (dBuV/m)	Margin (dB)	Antenna Pole (V/H)	Remark
1663.750	51.29	-6.56	44.73	74.00	-29.27	V	peak
1999.000	52.07	-5.01	47.06	74.00	-26.94	V	peak
3212.875	42.99	-1.00	41.99	74.00	-32.01	V	peak
4960.000	42.27	4.85	47.12	74.00	-26.88	V	peak
6712.750	39.78	7.23	47.01	74.00	-26.99	V	peak
7904.125	40.17	9.46	49.63	74.00	-24.37	V	peak
1996.750	52.00	-5.02	46.98	74.00	-27.02	H	Peak
3581.875	41.96	-0.17	41.79	74.00	-32.21	H	Peak
4960.000	43.49	4.85	48.34	74.00	-25.66	H	Peak
5952.250	38.78	6.06	44.84	74.00	-29.16	H	peak
6931.000	38.98	7.59	46.57	74.00	-27.43	H	peak
7919.875	39.89	9.49	49.38	74.00	-24.62	H	peak

Notes:

1. Measuring frequencies from 1 GHz to the 10th harmonic of highest fundamental frequency.
2. Measurements above show only up to 6 maximum emissions noted, or would be lesser if no specific emissions from the EUT are recorded (ie: margin>20dB from the applicable limit) and considered that's already beyond the background noise floor.
3. Radiated emissions measured in frequency above 1000MHz were made with an instrument using Peak detector mode and average detector mode of the emission shown in Actual FS column.
4. Spectrum setting:
 - a. Peak Setting 1GHz - 26GHz, RBW = 1MHz, VBW = 1MHz, Sweep time = 200 ms.
 - b. AV Setting 1GH z- 26GHz, RBW = 1MHz, VBW = 10Hz, Sweep time = 200 ms.
5. Frequency (MHz) = Emission frequency in MHz
 Reading (dBuV/m) =Uncorrected Analyzer / Receiver Reading
 Correction Factor (dB) = Antenna factor + Cable loss – Amplifier gain
 Limit (dBuV/m) = Limit stated in standard
 Margin (dB) = Result (dBuV/m)- Limit (dBuV/m)
 Pk = Peak Reading
 AV. = Average Reading
 Remark = Mark Peak Reading or Average Reading



6.9 POWERLINE CONDUCTED EMISSIONS

LIMIT

For an intentional radiator which is designed to be connected to the public utility (AC) power line, the radio frequency voltage that is conducted back onto the AC power line on any frequency or frequencies within the band 150 kHz to 30 MHz shall not exceed 250 microvolts (The limit decreases linearly with the logarithm of the frequency in the range 0.15 MHz to 0.50 MHz). The limits at specific frequency range is listed as follows:

Frequency Range (MHz)	Limits (dBµV)	
	Quasi-peak	Average
0.15 to 0.50	66 to 56	56 to 46
0.50 to 5	56	46
5 to 30	60	50

Compliance with this provision shall be based on the measurement of the radio frequency voltage between each power line (LINE and NEUTRAL) and ground at the power terminals.

MEASUREMENT EQUIPMENT USED

Conducted Emission Test Site					
Name of Equipment	Manufacturer	Model Number	Serial Number	Last Calibration	Due Calibration
EMI TEST RECEIVER	ROHDE&SCHWARZ	ESCI	100783	03/09/2014	03/08/2015
LISN(EUT)	ROHDE&SCHWARZ	ENV216	101543-WX	04/20/2014	04/19/2015
LISN	EMCO	3825/2	8901-1459	03/09/2014	03/08/2015
Temp. / Humidity Meter	VICTOR	HTC-1	N/A	03/17/2014	03/16/2015
Test S/W	FARAD	EZ-EMC/ CCS-3A1-CE			

Remark: Each piece of equipment is scheduled for calibration once a year.



Test Configuration

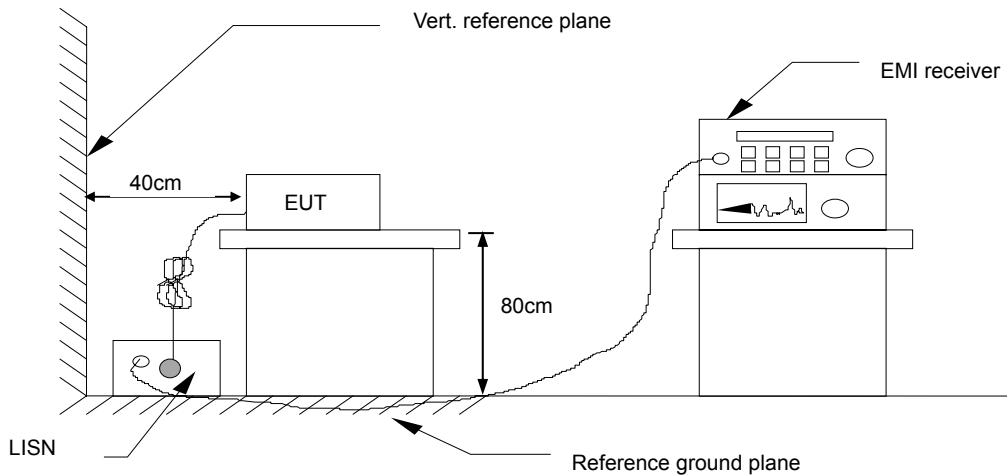

See test photographs attached in Appendix 1 for the actual connections between EUT and support equipment.

TEST PROCEDURE

1. The EUT was placed on a table, which is 0.8m above ground plane.
2. Maximum procedure was performed on the six highest emissions to ensure EUT compliance.
3. Repeat above procedures until all frequency measured were complete.

TEST RESULTS

The initial step in collecting conducted data is a spectrum analyzer peak scan of the measurement range. Significant peaks are then marked as shown on the following data page, and these signals are then quasi-peaked.



Test Data

Operation Mode: Charge + Aux + BT + battery 1# Test Date: November 12, 2014
Temperature: 22°C Humidity: 45% RH
Tested by: Mack Li

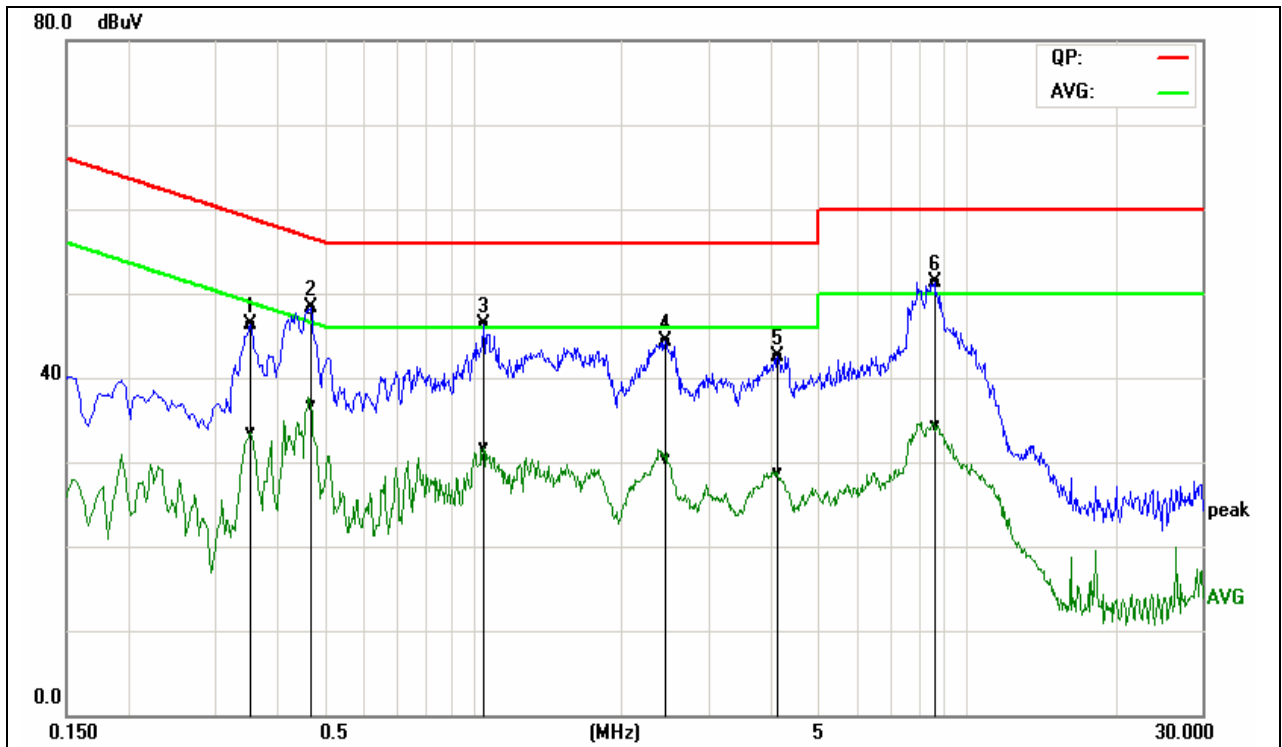

Table with 11 columns: Frequency (MHz), QuasiPeak Reading (dBuV), Average Reading (dBuV), Correction Factor (dB), QuasiPeak Result (dBuV), Average Result (dBuV), QuasiPeak Limit (dBuV), Average Limit (dBuV), QuasiPeak Margin (dB), Average Margin (dB), Line (L1/L2). It contains 6 rows of test data.

Note:

- 1. Measuring frequencies from 0.15 MHz to 30MHz.
2. The emissions measured in frequency range from 0.15 MHz to 30MHz were made with an instrument using Peak detector, Quasi-peak detector and average detector.
3. "----" denotes the emission level was or more than 2dB below the Average limit.
4. The IF bandwidth of SPA between 0.15MHz to 30MHz was 10kHz; the IF bandwidth of Test Receiver between 0.15MHz to 30MHz was 9kHz;
5. L1= Line One (Live Line)



Operation Mode: Charge + Aux + BT + battery 1# Test Date: November 12, 2014
 Temperature: 22°C Humidity: 45% RH
 Tested by: Mack Li

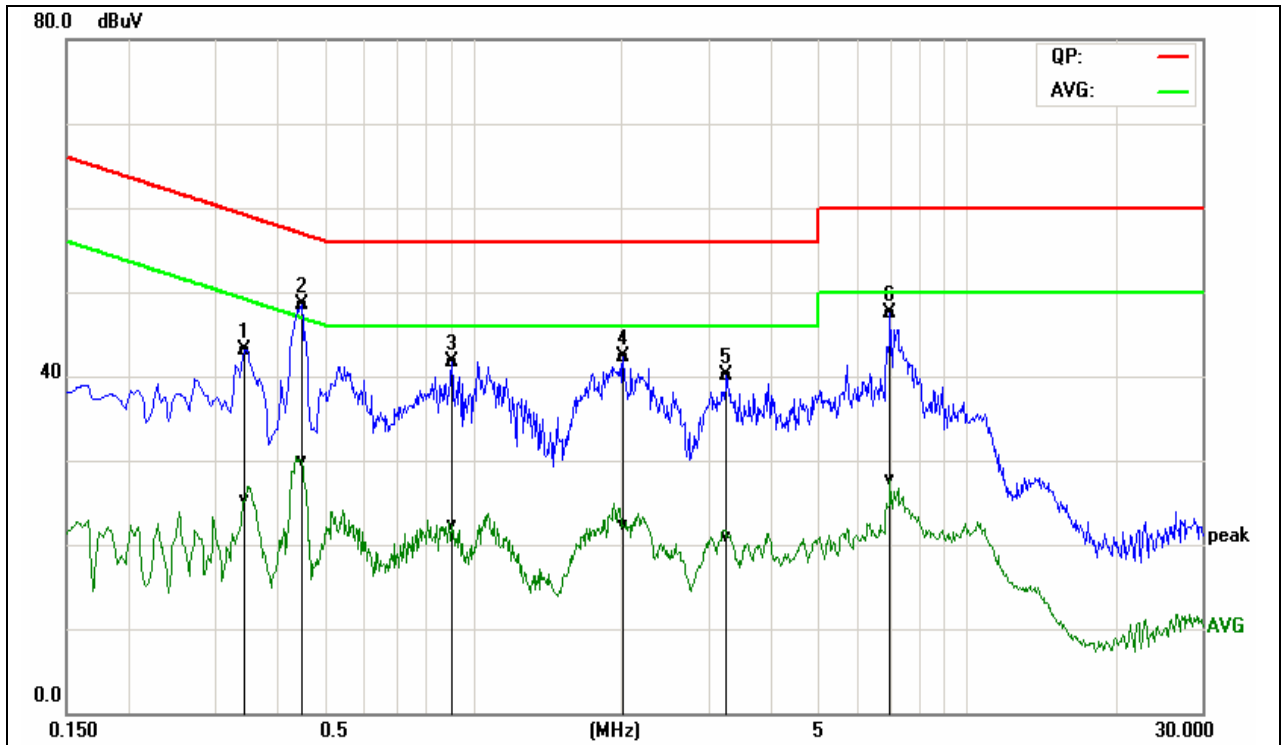

Frequency (MHz)	QuasiPeak Reading (dBuV)	Average Reading (dBuV)	Correction Factor (dB)	QuasiPeak Result (dBuV)	Average Result (dBuV)	QuasiPeak Limit (dBuV)	Average Limit (dBuV)	QuasiPeak Margin (dB)	Average Margin (dB)	Line (L1/L2)
0.3460	33.30	15.65	9.74	43.04	25.39	59.06	49.06	-16.02	-23.67	L2
0.4500	38.89	20.18	9.70	48.59	29.88	56.87	46.88	-8.28	-17.00	L2
0.9060	31.91	12.53	9.77	41.68	22.30	56.00	46.00	-14.32	-23.70	L2
2.0220	32.48	12.56	9.73	42.21	22.29	56.00	46.00	-13.79	-23.71	L2
3.2659	30.32	11.07	9.75	40.07	20.82	56.00	46.00	-15.93	-25.18	L2
7.0020	37.69	18.00	9.78	47.47	27.78	60.00	50.00	-12.53	-22.22	L2

Note:

1. Measuring frequencies from 0.15 MHz to 30MHz.
2. The emissions measured in frequency range from 0.15 MHz to 30MHz were made with an instrument using Peak detector, Quasi-peak detector and average detector.
3. "---" denotes the emission level was or more than 2dB below the Average limit.
4. The IF bandwidth of SPA between 0.15MHz to 30MHz was 10kHz; the IF bandwidth of Test Receiver between 0.15MHz to 30MHz was 9kHz;
5. L2= Line Two (Neutral Line)