

## FCC CERTIFICATION TEST REPORT

### FOR

<b>Applicant</b>	:	Harman International Industries, Inc.
<b>Address</b>	:	8500 Balboa Boulevard, Northridge, CA 91329, UNITED STATES
<b>Equipment under Test</b>	:	PORTABLE BLUETOOTH SPEAKER
<b>Model No.</b>	:	GO2H
<b>Trade Mark</b>	:	JBL
<b>FCC ID</b>	:	APIJBLGO2H
<b>IC</b>	:	6132A-JBLGO2H
<b>Manufacturer</b>	:	Harman International Industries, Inc.
<b>Address</b>	:	8500 Balboa Boulevard, Northridge, CA 91329, UNITED STATES

**Issued By: Dongguan Dongdian Testing Service Co., Ltd.**

**Add:** No. 17, Zongbu Road 2, Songshan Lake Sci&Tech, Industry Park, Dongguan  
City, Guangdong Province, China, 523808

**Tel:** +86-0769-38826678    **E-mail:** ddt@dgddt.com    <http://www.dgddt.com>

# REPORT

## TABLE OF CONTENTS

	Test report declares.....	4
1.	Summary of test results.....	6
2.	General test information.....	7
2.1.	Description of EUT.....	7
2.2.	Accessories of EUT.....	7
2.3.	Assistant equipment used for test.....	7
2.4.	Block diagram of EUT configuration for test.....	8
2.5.	Deviations of test standard.....	8
2.6.	Test environment conditions.....	8
2.7.	Test laboratory.....	9
2.8.	Measurement uncertainty.....	9
3.	Equipment used during test.....	10
4.	Maximum Peak Output Power.....	12
4.1.	Block diagram of test setup.....	12
4.2.	Limits.....	12
4.3.	Test Procedure.....	12
4.4.	Test Result.....	12
4.5.	Original test data.....	13
5.	20dB Bandwidth and 99% Bandwidth.....	16
5.1.	Block diagram of test setup.....	16
5.2.	Limits.....	16
5.3.	Test Procedure.....	16
5.4.	Test Result.....	16
5.5.	Original test data.....	17
6.	Carrier Frequency Separation.....	19
6.1.	Block diagram of test setup.....	19
6.2.	Limits.....	19
6.3.	Test Procedure.....	19
6.4.	Test Result.....	19
6.5.	Original test data.....	19
7.	Number Of Hopping Channel.....	20
7.1.	Block diagram of test setup.....	20
7.2.	Limits.....	20
7.3.	Test Procedure.....	20
7.4.	Test Result.....	20
7.5.	Original test data.....	20
8.	Dwell Time.....	21

8.1.	Block diagram of test setup.....	21
8.2.	Limits .....	21
8.3.	Test Procedure.....	21
8.4.	Test Result.....	21
9.	Band Edge Compliance (conducted method).....	23
9.1.	Block diagram of test setup.....	23
9.2.	Limit .....	23
9.3.	Test result .....	24
9.4.	Original test data.....	24
10.	Radiated emission .....	27
10.1.	Block diagram of test setup.....	27
10.2.	Limit .....	28
10.3.	Test Procedure.....	29
10.4.	Test result .....	30
11.	Band Edge Compliance (radiated method).....	43
11.1.	Block diagram of test setup.....	43
11.2.	Limit .....	43
11.3.	Test Procedure.....	43
11.4.	Test result .....	43
12.	Power Line Conducted Emission .....	52
12.1.	Block diagram of test setup.....	52
12.2.	Power Line Conducted Emission Limits .....	52
12.3.	Test Procedure.....	52
12.4.	Test Result.....	53
13.	Antenna Requirements .....	64
13.1.	Limit .....	64
13.2.	Result.....	64

## TEST REPORT DECLARE

<b>Applicant</b>	:	Harman International Industries, Inc.
<b>Address</b>	:	8500 Balboa Boulevard, Northridge, CA 91329, UNITED STATES
<b>Equipment under Test</b>	:	PORTABLE BLUETOOTH SPEAKER
<b>Model No.</b>	:	GO2H
<b>Trade mark</b>	:	JBL
<b>Manufacturer</b>	:	Harman International Industries, Inc.
<b>Address</b>	:	8500 Balboa Boulevard, Northridge, CA 91329, UNITED STATES

**Test Standard Used:**

FCC Rules and Regulations Part 15 Subpart C.

**Test procedure used:**

ANSI C63.10:2013.

**We Declare:**

The equipment described above is tested by Dongguan Dongdian Testing Service Co., Ltd. and in the configuration tested the equipment complied with the standards specified above. The test results are contained in this test report and Dongguan Dongdian Testing Service Co., Ltd. is assumed of full responsibility for the accuracy and completeness of these tests.

**After test and evaluation, our opinion is that the equipment provided for test compliance with the requirement of the above FCC standards.**

<b>Report No.:</b>	DDT-R18082902-1E1		
<b>Date of Receipt:</b>	Oct. 18, 2017, Apr. 13, 2017, Aug. 31, 2018, Mar. 04, 2020	<b>Date of Test:</b>	Oct. 18, 2017 ~ Nov. 02, 2017, Apr. 13, 2017 ~ Apr. 19, 2018, Aug. 31, 2018 ~ Sep. 09, 2018, Mar. 04, 2020 ~ Mar. 26, 2020

**Prepared By:**

*Bobo Chen*

**Bobo Chen/Engineer**

**Approved By:**



**Damon Hu/EMC Manager**

Note: This report applies to above tested sample only. This report shall not be reproduced in parts without written approval of Dongguan Dongdian Testing Service Co., Ltd.

## Revision history

Rev.	Revisions	Issue Date	Revised By
---	Initial issue	Nov. 06, 2017	
V1.0	There is power amplifier add in this report base on the original report: DDT-R17101804-1E2, this change doesn't influence the RF performance, so power line conducted and radiated emission (below 1GHz) were tested and updated in this report only.	Apr. 19, 2018	Ella Gong
V2.0	There is a new battery added in this report base on the original report: R18041303-1E2, this change doesn't influence the RF performance, so only power line conducted and radiated emission (below 1GHz) were tested and updated in this report only.	Sep. 09, 2018	Ella Gong
V3.0	This report added electrostatic discharge improvement plan and new battery based on the original report, this change based on engineering judgment that only power line conducted and radiated emission (below 1GHz), need to test, and the original test data retained in this report	Mar. 26, 2020	Bobo Chen

## 1. Summary of test results

Description of Test Item	Standard	Results
Maximum Peak Output Power	FCC Part 15: 15.247(b)(1) ANSI C63.10:2013 RSS-247 Issue 2	PASS
20dB Bandwidth and 99% Bandwidth	FCC Part 15: 15.215 ANSI C63.10:2013 RSS-247 Issue 2	PASS
Carrier Frequency Separation	FCC Part 15: 15.247(a)(1) ANSI C63.10:2013 RSS-247 Issue 2	PASS
Number Of Hopping Channel	FCC Part 15: 15.247(a)(1)(iii) ANSI C63.10:2013 RSS-247 Issue 2	PASS
Dwell Time	FCC Part 15: 15.247(a)(1)(iii) ANSI C63.10:2013 RSS-247 Issue 2	PASS
Radiated Emission	FCC Part 15: 15.209 FCC Part 15: 15.247(d) ANSI C63.10:2013 RSS-247 Issue 2 RSS-Gen Issue 5	PASS
Band Edge Compliance	FCC Part 15: 15.247(d) ANSI C63.10:2013 RSS-247 Issue 2 RSS-Gen Issue 5	PASS
Power Line Conducted Emissions	FCC Part 15: 15.207 ANSI C63.10:2013 RSS-Gen Issue 5	PASS
Antenna requirement	FCC Part 15: 15.203 RSS-Gen Issue 5	PASS

## 2. General test information

### 2.1. Description of EUT

EUT* Name	: PORTABLE BLUETOOTH SPEAKER
Model Number	: GO2H
EUT function description	: Please reference user manual of this device
Power supply	: DC 5V from external AC Adapter DC 3.7V built-in battery
Radio Specification	: Bluetooth V4.1 (only BDR/EDR)
Operation frequency	: 2402MHz -2480MHz
Modulation	: GFSK, $\pi/4$ QPSK, 8-DPSK
Data rate	: 1Mbps, 2Mbps, 3Mbps
Antenna Type	: Integrated antenna, maximum PK gain: 1.3dBi
Sample Type	: Series production

Note 1: EUT is the ab. of equipment under test.

### 2.2. Accessories of EUT

Description of Accessories	Manufacturer	Model number	Serial No.	Other
USB cable	Harman	N/A	N/A	Length: 0.3m, unshielded
Built-in Battery	McNair New Power Co., Ltd	GO2/MLP28415 4	3.7V,730mAh, 2.70Wh, lithium-ion polymer	Alternative
Built-in Battery	EVE Energy Co., Ltd	L0707-LF	3.7V,730mAh, 2.70Wh, Lithium-ion polymer	
Built-in Battery	Springpower Technology (Shenzhen) Co., Ltd.	304055	3.7V, 730 mAh, 2.701Wh, polymer lithium-ion battery	

New Battery information:

Description of Accessories	Manufacturer	Model number	Description	Remark
Built-in Battery	Guangzhou Great Power Energy & Technology Co., Ltd.	GSP383555 01	3.7V, 730mAh	N/A

### 2.3. Assistant equipment used for test

Assistant equipment	Manufacturer	Model number	Serial No.	Other
AC Adapter	Group Intellect Power Technology Limited	F5V-2.3C-1U	N/A	Input: AC 100-240V -50/60Hz, 0.5A; Output: DC 5V, 2.3A
Notebook	DELL	Latitude D610	FCC DOC	00045-534-136-300

## 2.4. Block diagram of EUT configuration for test

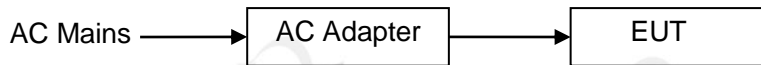

Test software: ASTTestTool.exe

The test software was used to control EUT work in Continuous TX mode, and select test channel, wireless mode as blow table.

Tested mode, channel, information		
Mode	Channel	Frequency (MHz)
GFSK hopping on Tx Mode	CH0 to CH78	2402 to 2480
$\pi/4$ QPSK Hopping on TX mode	CH0 to CH78	2402 to 2480
8-DPSK hopping on Tx Mode	CH0 to CH78	2402 to 2480
GFSK hopping off Tx Mode	CH0	2402
	CH39	2441
	CH78	2480
$\pi/4$ QPSK hopping off Tx Mode	CH0	2402
	CH39	2441
	CH78	2480
8-DPSK hopping off Tx Mode	CH0	2402
	CH39	2441
	CH78	2480

Note: For  $\pi/4$  QPSK its same modulation type with 8-DPSK, and based exploratory test, there is no significant difference of that two types test result, so except output power, all other items final test were only performed with the worse case 8-DPSK and GFSK.

## 2.5. Deviations of test standard

No Deviation.

## 2.6. Test environment conditions

During the measurement the environmental conditions were within the listed ranges:

Temperature range:	21-25°C
Humidity range:	40-75%
Pressure range:	86-106kPa

## 2.7. Test laboratory

Dongguan Dongdian Testing Service Co., Ltd

Add: No. 17, Zongbu Road 2, Songshan Lake Sci&Tech, Industry Park, Dongguan City, Guangdong Province, China, 523808 Tel: +86-0769-38826678 <http://www.dgddt.com>

CNAS Accreditation No. L6451; A2LA Accreditation No. 3870.01

Designation Number: CN1182; Test Firm Registration Number: 540522

Industry Canada site registration number: 10288A-1

## 2.8. Measurement uncertainty

Test Item	Uncertainty
Bandwidth	1.1%
Peak Output Power (Conducted)(Spectrum analyzer)	0.86dB (10 MHz ≤ f < 3.6GHz);
	1.38dB (3.6GHz ≤ f < 8GHz)
Peak Output Power (Conducted)(Power Sensor)	0.74dB
Dwell Time	0.6%
Conducted spurious emissions	0.86dB (10 MHz ≤ f < 3.6GHz);
	1.40dB (3.6GHz ≤ f < 8GHz)
	1.66dB (8GHz ≤ f < 22GHz)
Uncertainty for radio frequency (RBW<20KHz)	$3 \times 10^{-8}$
Temperature	0.4°C
Humidity	2%
Uncertainty for Radiation Emission test (30MHz-1GHz)	4.70 dB (Antenna Polarize: V)
	4.84 dB (Antenna Polarize: H)
Uncertainty for Radiation Emission test (1GHz-18GHz)	4.10dB(1-6GHz)
	4.40dB (6GHz-18Gz)
Uncertainty for Power line conduction emission test	3.32dB (150KHz-30MHz)
Note: This uncertainty represents an expanded uncertainty expressed at approximately the 95% confidence level using a coverage factor of k=2.	

### 3. Equipment used during test

Equipment	Manufacturer	Model No.	Serial No.	Last Cal.	Cal. Interval
<b>RF Connected Test (Tonscent RF Measurement System)</b>					
Spectrum analyzer	R&S	FSU26	1166.1660.26	Oct. 23, 2017	1 Year
Wideband Radio Communication tester	R&S	CMW500	155523	Oct. 21, 2017	1 Year
Vector Signal Generator	Agilent	E8267D	MY52098743	Oct. 23, 2017	1 Year
Vector Signal Generator	Agilent	N5182A	MY48180737	Oct. 21, 2017	1 Year
Power Sensor	Agilent	U2021XA	MY55150010	Oct. 21, 2017	1 Year
Power Sensor	Agilent	U2021XA	MY55150011	Oct. 21, 2017	1 Year
DC Power Source	MATRIS	MPS-3005L-3	D813058W	Oct. 21, 2017	1 Year
Attenuator	Mini-Circuits	BW-S10W2	101109	Oct. 21, 2017	1 Year
RF Cable	Micable	C10-01-01-1	100309	Oct. 21, 2017	1 Year
Temp&Humi Programmable	ZHIXIANG	ZXGDJS-150L	ZX170110-A	Oct. 21, 2017	1Year
Test Software	JS Tonscend	JS1120-2	Ver.2.5	N/A	N/A
USB Data acquisition	Agilent	U2531A	TW55043503	N/A	N/A
Auto control Unit	JS Tonscend	JS0806-2	158060010	N/A	N/A
<b>Radiated Emission Test chamber 1#</b>					
EMI Test Receiver	R&S	ESU8	100316	Oct. 21, 2017	1 Year
Spectrum analyzer	R&S	FSU26	1166.1660.26	Oct. 21, 2017	1 Year
Trilog Broadband Antenna	Schwarzbeck	VULB9163	9163-462	Oct. 27, 2017	1 Year
Active Loop antenna	Schwarzbeck	FMZB-1519	1519-038	Oct. 21, 2017	1 Year
Broadband Horn antenna	Schwarzbeck	BBHA 9170	BBHA 9170 #790	Aug. 11, 2017	1 Year
Double Ridged Horn Antenna	R&S	HF907	100276	Oct. 21, 2017	1 Year
Pre-amplifier	A.H.	PAM-0118	360	Oct. 21, 2017	1 Year
RF Cable	HUBSER	CP-X2	W11.03	Oct. 21, 2017	1 Year
RF Cable	HUBSER	CP-X1	W12.02	Oct. 21, 2017	1 Year
MI Cable	HUBSER	C10-01-01-1M	1091629	Oct. 21, 2017	1 Year
Test software	Audix	E3	V 6.11111b	N/A	N/A
<b>Power Line Conducted Emissions Test</b>					
Test Receiver	R&S	ESU8	100316	Oct. 21, 2017	1 Year
LISN 1	R&S	ENV216	101109	Oct. 21, 2017	1 Year
LISN 2	R&S	ESH2-Z5	100309	Oct. 21, 2017	1 Year
Pulse Limiter	R&S	ESH3-Z2	101242	Oct. 21, 2017	1 Year
CE Cable 1	HUBSER	ESU8/RF2	W10.01	Oct. 21, 2017	1 Year
Test software	Audix	E3	V 6.11111b	N/A	N/A

Equipment	Manufacturer	Model No.	Serial No.	Last Cal.	Cal. Interval
<b>RF Connected Test (Tonscend RF Measurement System)</b>					
Spectrum analyzer	R&S	FSU26	200071	Sep. 29, 2019	1 Year
Wideband Radio Communication tester	R&S	CMW500	117491	Jun. 25, 2019	1 Year
Vector Signal Generator	Agilent	E8267D	US49060192	Sep. 29, 2019	1 Year
Vector Signal Generator	Agilent	N5182A	MY48180737	Jun. 25, 2019	1 Year
Power Sensor	Agilent	U2021XA	MY55150010	Jun. 28, 2019	1 Year
Power Sensor	Agilent	U2021XA	MY55150011	Jun. 28, 2019	1 Year
DC Power Source	MATRIS	MPS-3005L-3	D813058W	Jun. 25, 2019	1 Year
RF Cable	Micable	C10-01-01-1	100309	Sep. 29, 2019	1 Year
Temp&Humi Programmable	ZHIXIANG	ZXGDJS-150L	ZX170110-A	Sep. 29, 2019	1 Year
Test Software	JS Tonscend	JS1120-3	Ver.2.7	N/A	N/A
<b>Radiation 1#chamber</b>					
EMI Test Receiver	R&S	ESU8	100316	Sep. 29, 2019	1 Year
Spectrum analyzer	Agilent	E4447A	MY50180031	Jun. 25, 2019	1 Year
Trilog Broadband Antenna	Schwarzbeck	VULB9163	9163-462	Nov. 15, 2019	1 Year
Active Loop antenna	Schwarzbeck	FMZB-1519	1519-038	Sep. 29, 2019	1 Year
Double Ridged Horn Antenna	R&S	HF907	100276	Nov. 15, 2019	1 Year
Broad Band Horn Antenna	Schwarzbeck	BBHA 9170	790	Sep. 29, 2019	1 Year
Pre-amplifier	A.H.	PAM-0118	360	Sep. 29, 2019	1 Year
Pre-amplifier	TERA-MW	TRLA-0040 G35	101303	Sep. 29, 2019	1 Year
RF Cable	HUBSER	CP-X2+ CP-X1	W11.03+ W12.02	Sep. 29, 2019	1 Year
RF Cable	N/A	SMAJ-SMAJ -1M+ 11M	17070133+17070131	Sep. 29, 2019	1 Year
MI Cable	HUBSER	C10-01-01-1 M	1091629	Sep. 29, 2019	1 Year
Test software	Audix	E3	V 6.11111b	N/A	N/A
<b>Power Line Conducted Emissions Test</b>					
EMI Test Receiver	R&S	ESU8	100316	Sep. 29, 2019	1 Year
LISN 1	R&S	ENV216	101109	Sep. 29, 2019	1 Year
LISN 2	R&S	ESH2-Z5	100309	Sep. 29, 2019	1 Year
Pulse Limiter	R&S	ESH3-Z2	101242	Sep. 29, 2019	1 Year
CE Cable 1	HUBSER	N/A	W10.01	Sep. 29, 2019	1 Year
Test software	Audix	E3	V 6.11111b	N/A	N/A

## 4. Maximum Peak Output Power

### 4.1. Block diagram of test setup

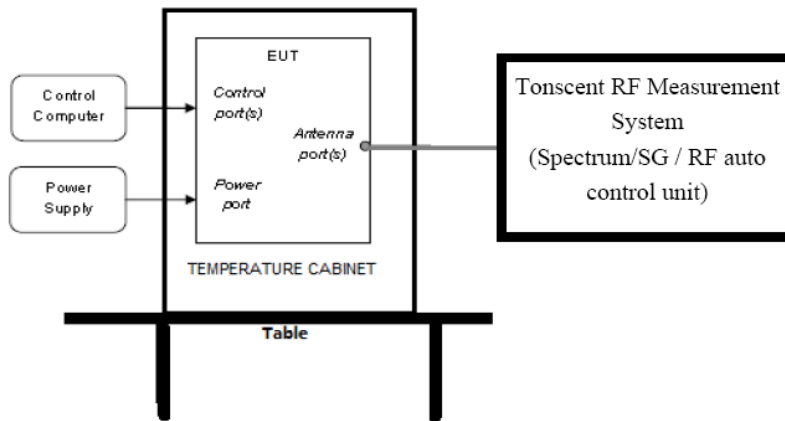

### 4.2. Limits

For frequency hopping systems operating in the 2400-2483.5 MHz band employing at least 75 non-overlapping hopping channels, and all frequency hopping systems in the 5725-5850 MHz band: 1 watt. For all other frequency hopping systems in the 2400-2483.5 MHz band: 0.125 watts, the e.i.r.p shall not exceed 4W.

### 4.3. Test Procedure

- (1) Connect EUT's antenna output to spectrum analyzer by RF cable.
- (2) Measure the maximum output power of EUT by spectrum analyzer with PK detector and RBW=3MHz(above 20dB bandwidth of measured signal), VBW=10MHz

Note: The attenuator loss was inputted into spectrum analyzer as amplitude offset.

### 4.4. Test Result

Mode	Freq (MHz)	Result (dBm)	Limit (dBm)	Conclusion
GFSK	2402	1.910	21	PASS
	2441	1.640	21	PASS
	2480	2.960	21	PASS
$\pi/4$ QPSK	2402	3.100	21	PASS
	2441	2.830	21	PASS
	2480	4.060	21	PASS
8-DPSK	2402	3.380	21	PASS
	2441	3.080	21	PASS
	2480	4.280	21	PASS

4.5. Original test data

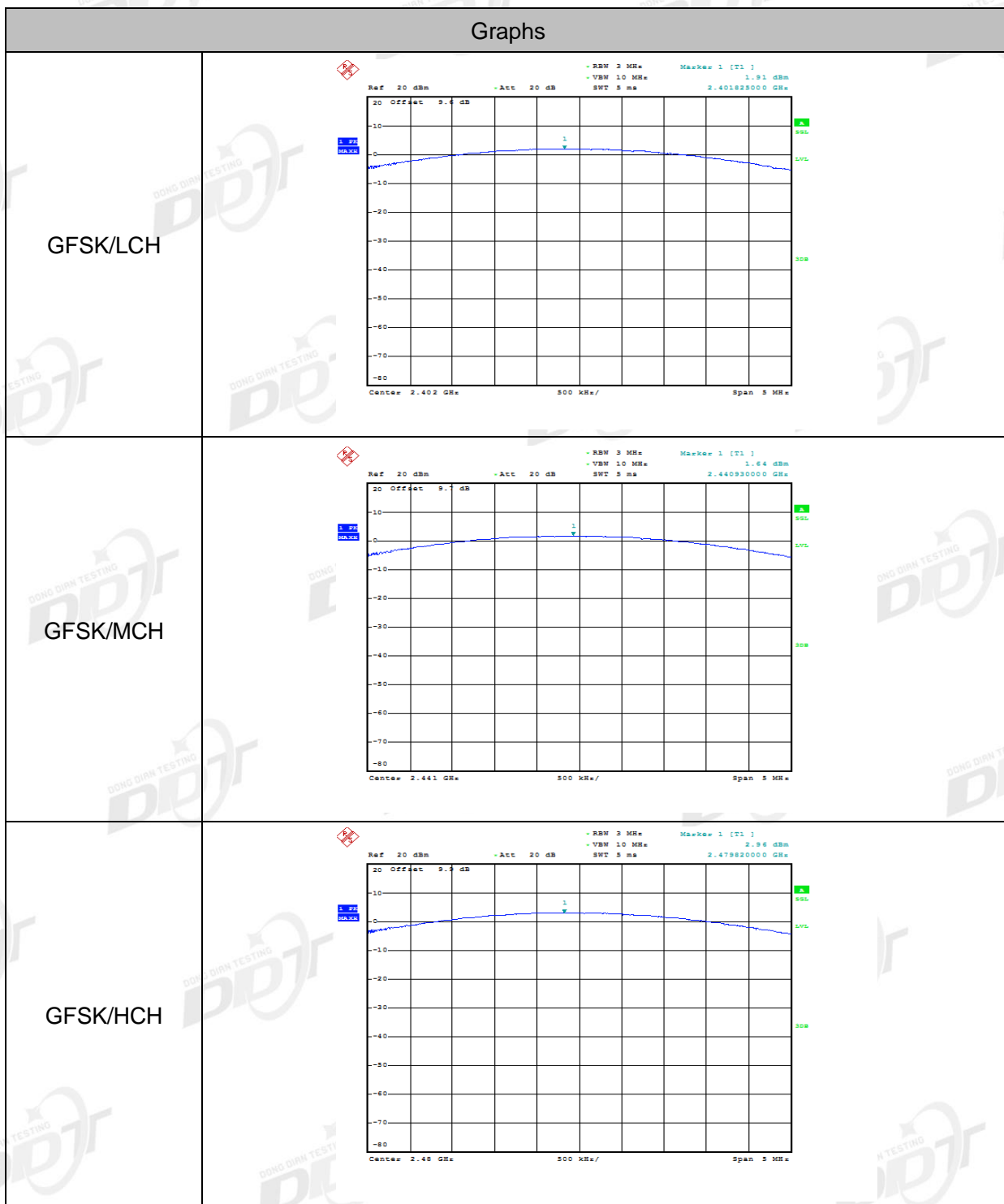

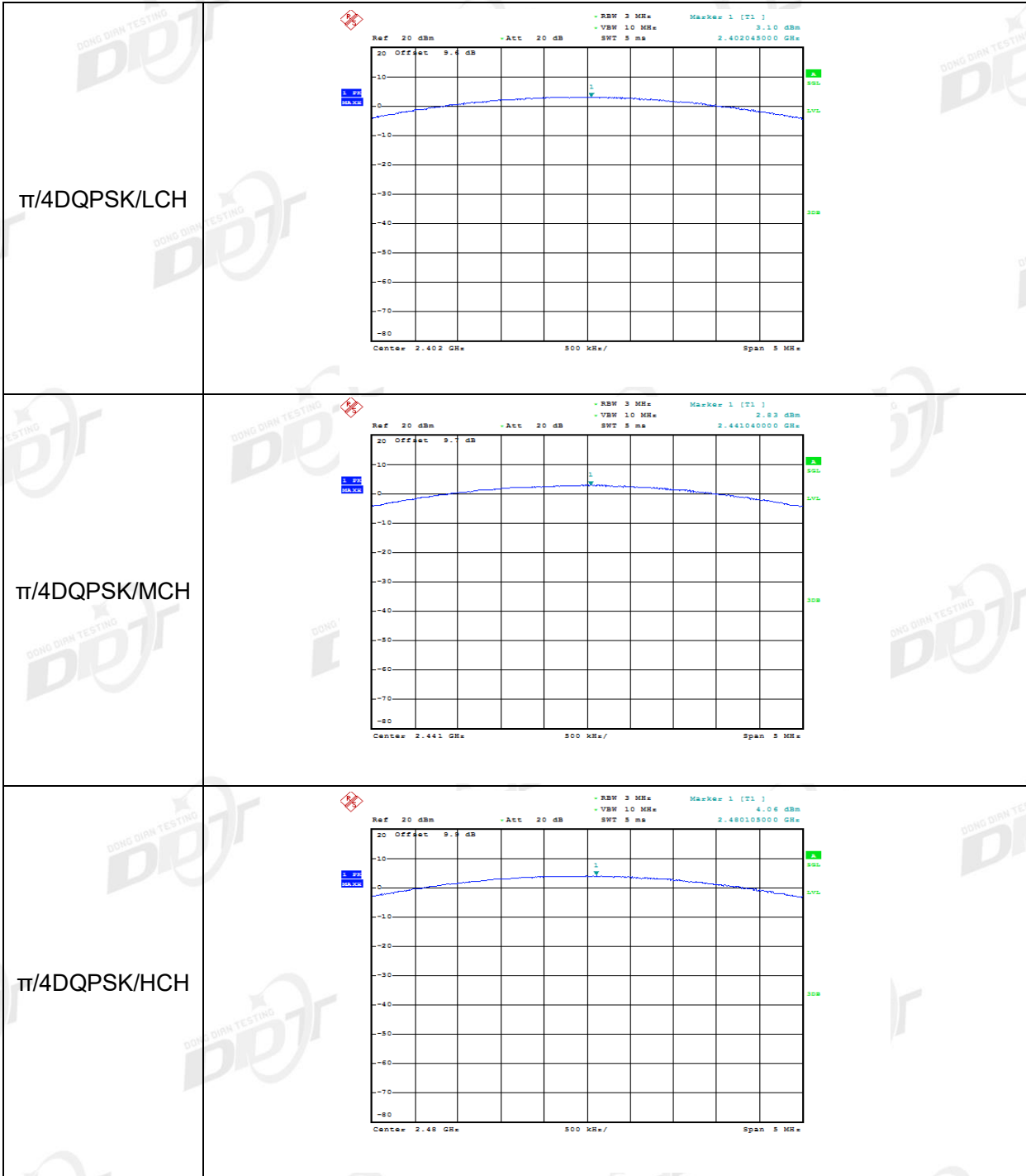

8DPSK/LCH

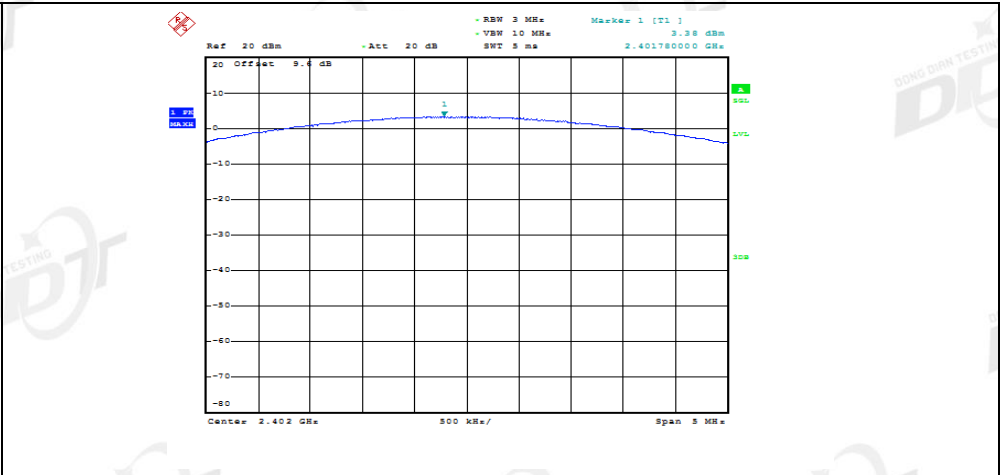

8DPSK/MCH

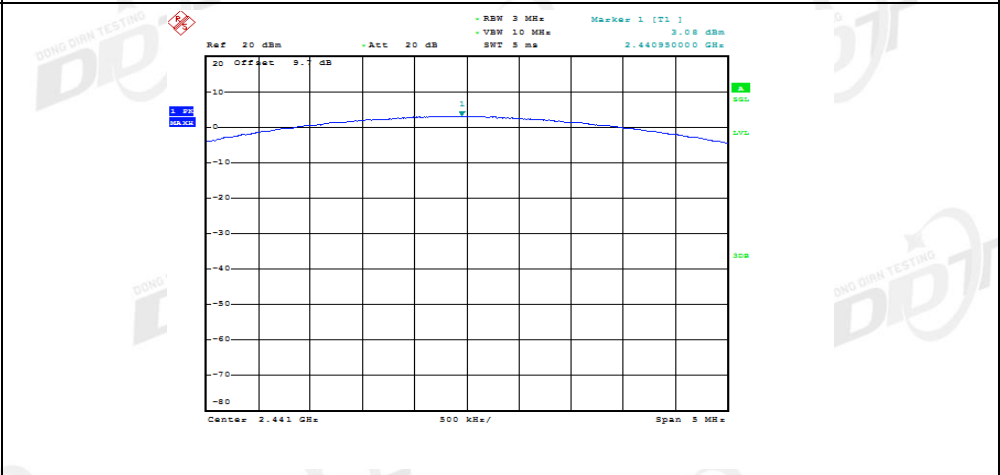

8DPSK/HCH

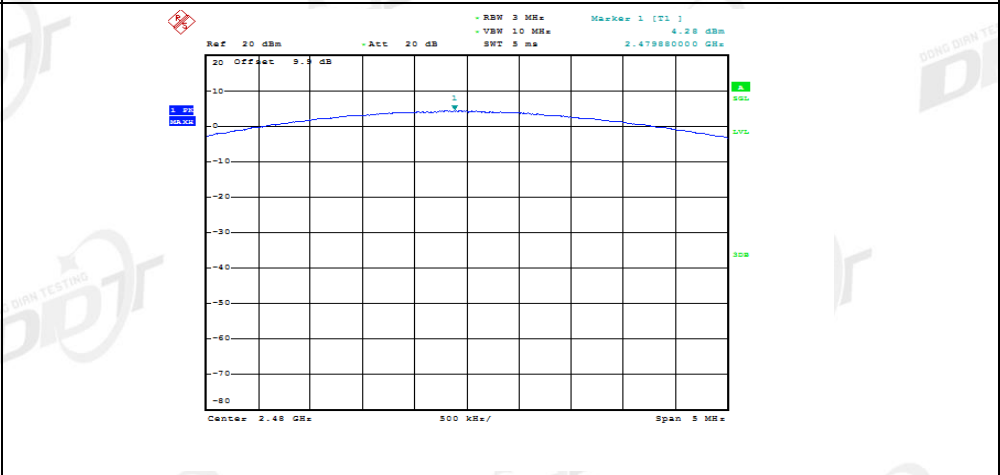

## 5. 20dB Bandwidth and 99% Bandwidth

### 5.1. Block diagram of test setup

Same as section 4.1

### 5.2. Limits

Intentional radiators operating under the alternative provisions to the general emission limits, as contained in § 15.217 through 15.257 and in Subpart E of this part, must be designed to ensure that the 20 dB bandwidth of the emission, or whatever bandwidth may otherwise be specified in the specific rule section under which the equipment operates, is contained within the frequency band designated in the rule section under which the equipment is operated.

### 5.3. Test Procedure

- (1) Connect EUT's antenna output to spectrum analyzer by RF cable.
- (2) The bandwidth of the fundamental frequency was measured by spectrum analyzer with 100 kHz RBW and 300 kHz VBW. The 20dB bandwidth is defined as the total spectrum the power of which is higher than peak power minus 20dB.

### 5.4. Test Result

Mode	Freq. (MHz)	20dB bandwidth Result (MHz)	99% bandwidth Result (MHz)	Conclusion
GFSK	2402	1.116	0.984	PASS
	2441	1.116	0.982	PASS
	2480	1.112	0.978	PASS
8-DPSK	2402	1.360	1.202	PASS
	2441	1.360	1.202	PASS
	2480	1.358	1.200	PASS

5.5. Original test data

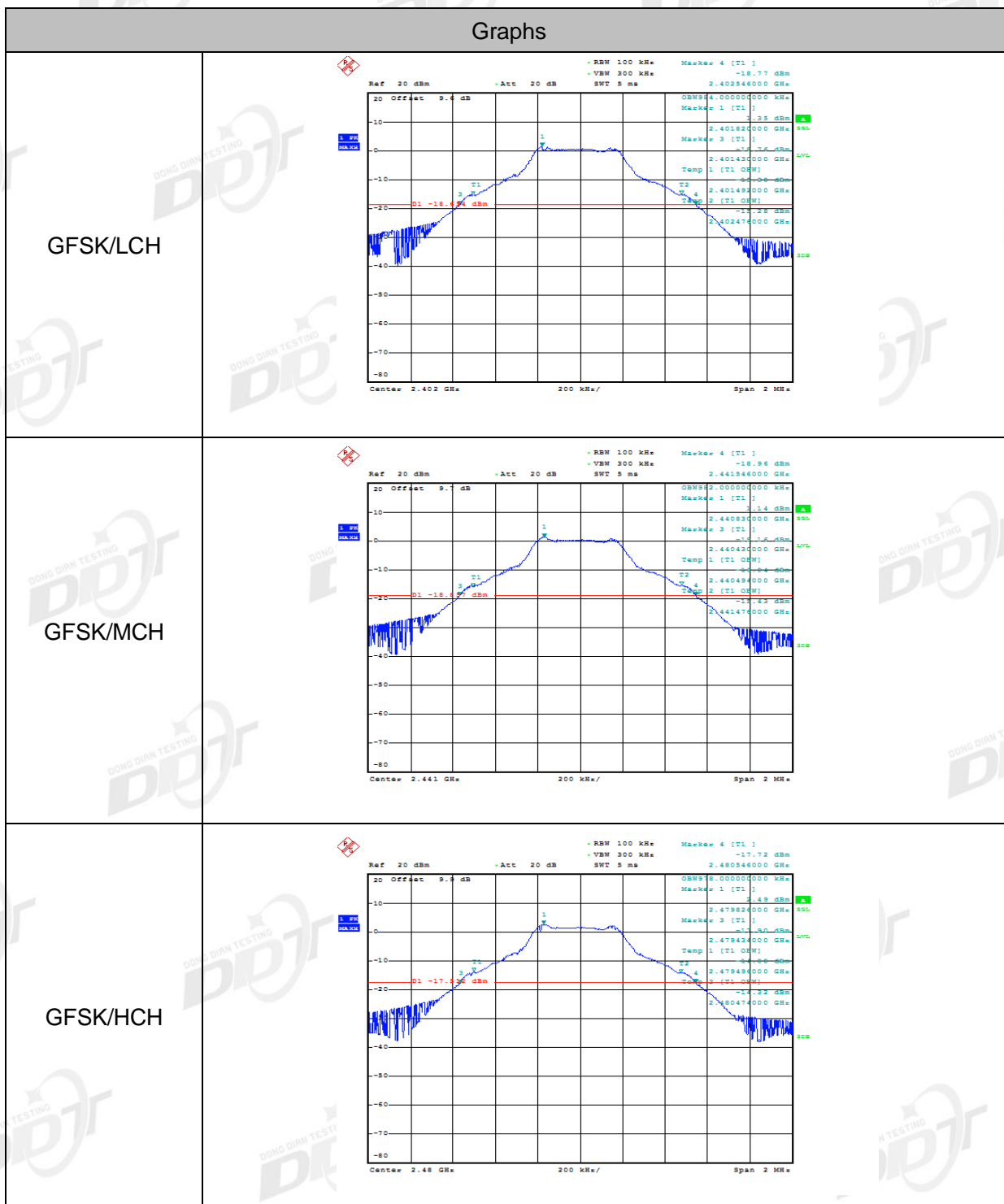

8DPSK/LCH

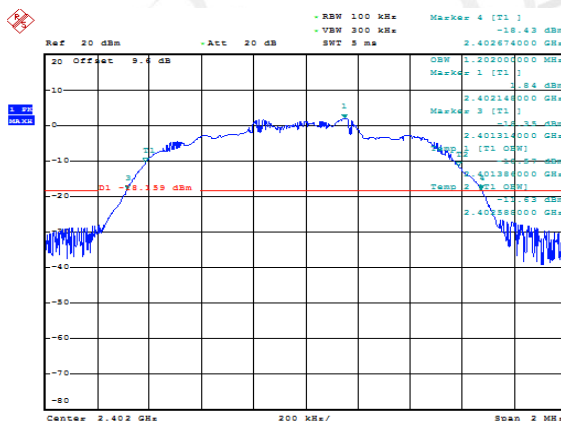

8DPSK/MCH

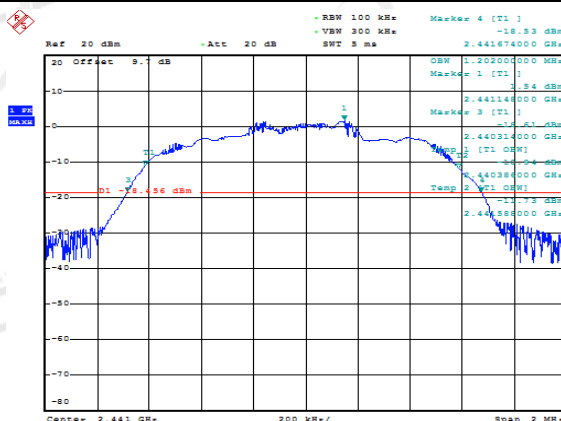

8DPSK/HCH

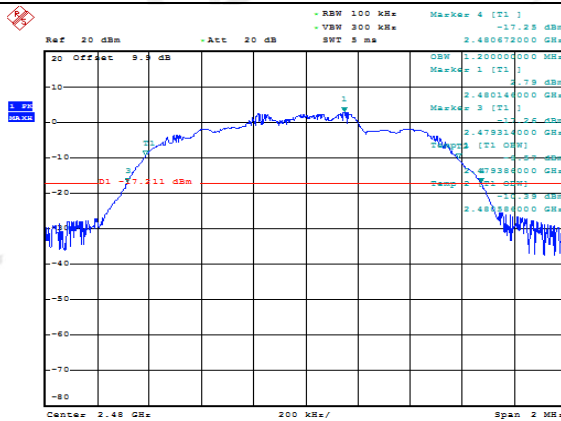

## 6. Carrier Frequency Separation

### 6.1. Block diagram of test setup

Same as section 4.1

### 6.2. Limits

Frequency hopping systems shall have hopping channel carrier frequencies separated by a minimum of 25 kHz or the 20 dB bandwidth of the hopping channel, whichever is greater. Alternatively, frequency hopping systems operating in the 2400-2483.5 MHz band may have hopping channel carrier frequencies that are separated by 25 kHz or two-thirds of the 20 dB bandwidth of the hopping channel, whichever is greater, provided the systems operate with an output power no greater than 125 mW.

### 6.3. Test Procedure

- (1) Connect EUT's antenna output to spectrum analyzer by RF cable.
- (2) The carrier frequency was measured by spectrum analyzer with 100 KHz RBW and 300 KHz VBW.

### 6.4. Test Result

Mode	Channel separation (MHz)	Limit (MHz) 2/3 of 20dB bandwidth	Conclusion
GFSK	1.002	≥ two-thirds of the 20 dB Bandwidth Of The Hopping Channel	PASS
8-DPSK	1.000	≥ two-thirds of the 20 dB Bandwidth Of The Hopping Channel	PASS

### 6.5. Original test data

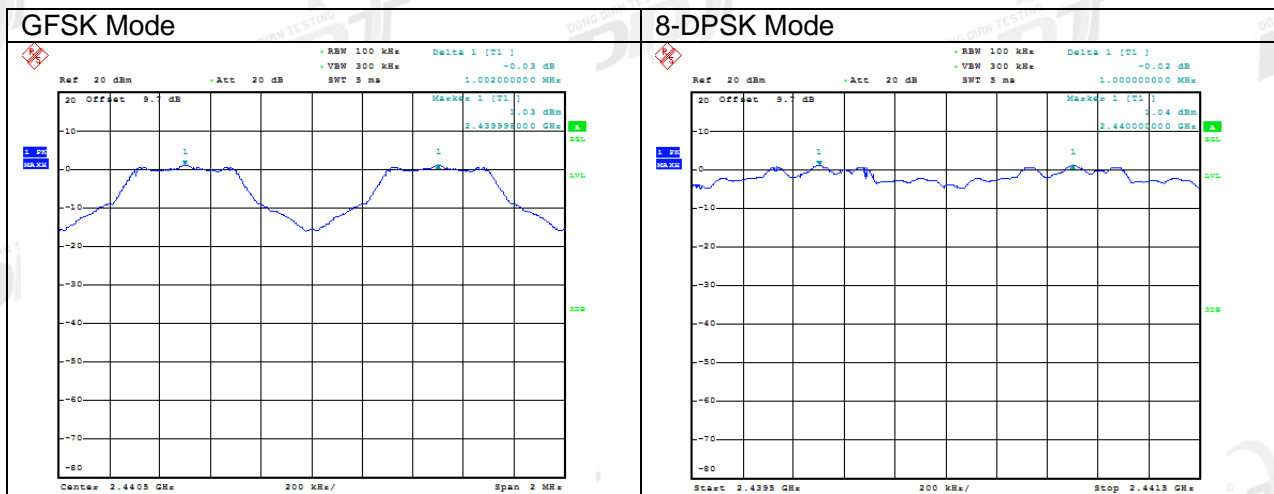

## 7. Number Of Hopping Channel

### 7.1. Block diagram of test setup

Same as section 4.1

### 7.2. Limits

Frequency hopping systems in the 2400-2483.5 MHz band shall use at least 15 channels.

### 7.3. Test Procedure

- (1) Connect EUT's antenna output to spectrum analyzer by RF cable.
- (2) The number of hopping channel was measured by spectrum analyzer with 100 kHz RBW and 300 kHz VBW.

### 7.4. Test Result

Mode	Number of hopping channel	Limit	Conclusion
GFSK	79	>15	PASS
8-DPSK	79	>15	PASS

### 7.5. Original test data



## 8. Dwell Time

### 8.1. Block diagram of test setup

Same as section 4.1

### 8.2. Limits

The average time of occupancy on any channel shall not be greater than 0.4 seconds within a period of 0.4 seconds multiplied by the number of hopping channels employed.

### 8.3. Test Procedure

- (1) Connect EUT's antenna output to spectrum analyzer by RF cable.
- (2) Measure the hopping number and on time of each pulse with spectrum analyzer in zero span set, and calculate dwell time with formula Dwell time = total hops \* pulse's on time.

DH1 Packet permit maximum  $1600 / 79 / 2 = 10.12$  hops per second in each channel (1 time slot RX, 1 time slot TX). So, total hops is  $10.12 \times 31.6 = 320$ .

DH3 Packet permit maximum  $1600 / 79 / 4 = 5.06$  hops per second in each channel (3 time slots RX, 1 time slot TX). So, total hops is  $5.06 \times 31.6 = 160$ .

DH5 Packet permit maximum  $1600 / 79 / 6 = 3.375$  hops per second in each channel (5 time slots RX, 1 time slot TX). So, total hops is  $3.375 \times 31.6 = 106.7$ .

3DH1 Packet permit maximum  $1600 / 79 / 2 = 10.12$  hops per second in each channel (1 time slot RX, 1 time slot TX). So, total hops is  $10.12 \times 31.6 = 320$ .

3DH3 Packet permit maximum  $1600 / 79 / 4 = 5.06$  hops per second in each channel (3 time slots RX, 1 time slot TX). So, total hops is  $5.06 \times 31.6 = 160$ .

3DH5 Packet permit maximum  $1600 / 79 / 6 = 3.375$  hops per second in each channel (5 time slots RX, 1 time slot TX). So, total hops is  $3.375 \times 31.6 = 106.7$ .

### 8.4. Test Result

Mode	Dwell time (s)	Pulse's on time (ms)	Total hops	Limit	Conclusion
DH1	0.118	0.37	320	<400ms	PASS
DH3	0.261	1.63	160	<400ms	PASS
DH5	0.305	2.86	106.7	<400ms	PASS
3-DH1	0.118	0.37	320	<400ms	PASS
3-DH3	0.259	1.62	160	<400ms	PASS
3-DH5	0.303	2.84	106.7	<400ms	PASS

Note: Dwell time = total hops \* pulse's on time.

Original test data

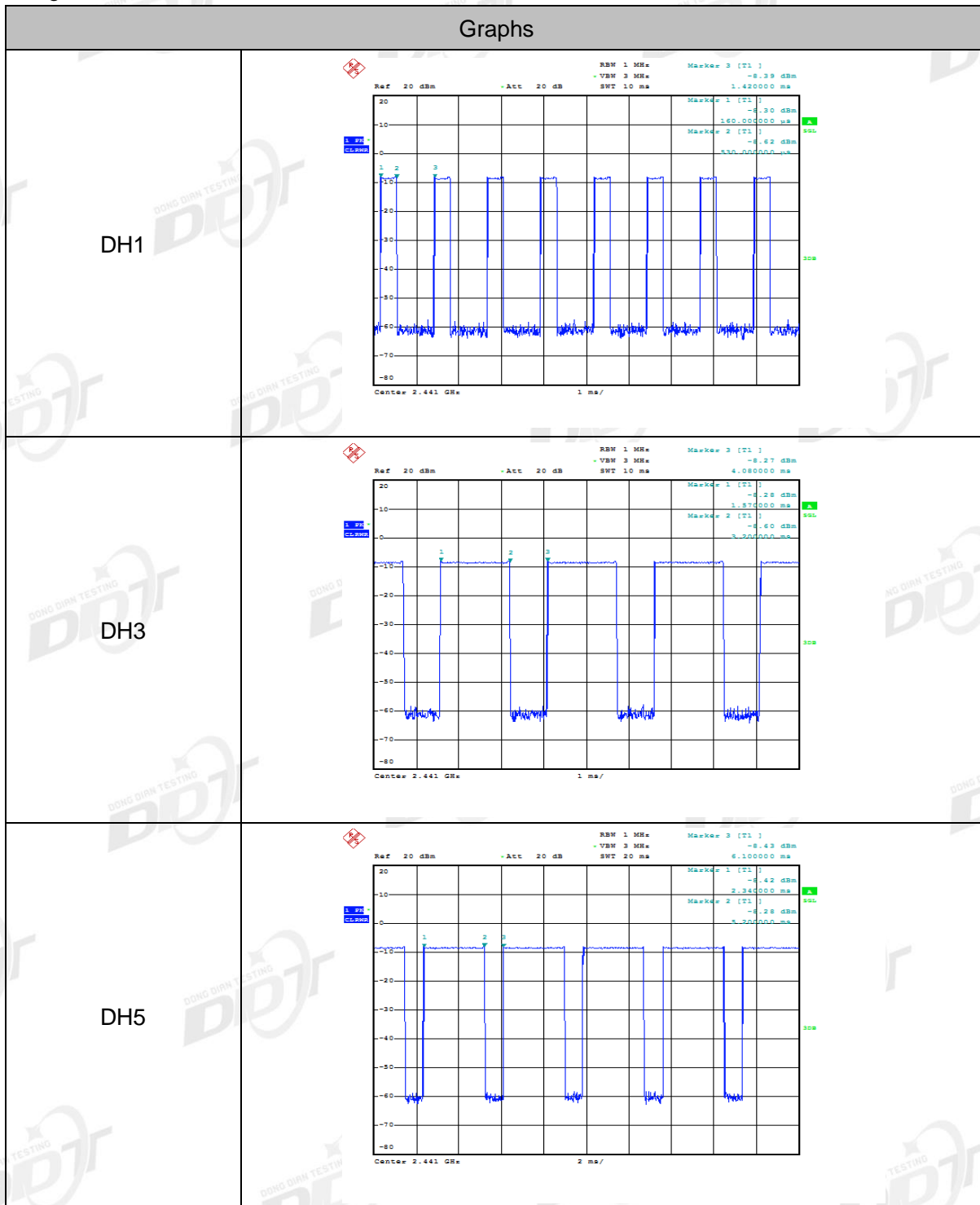

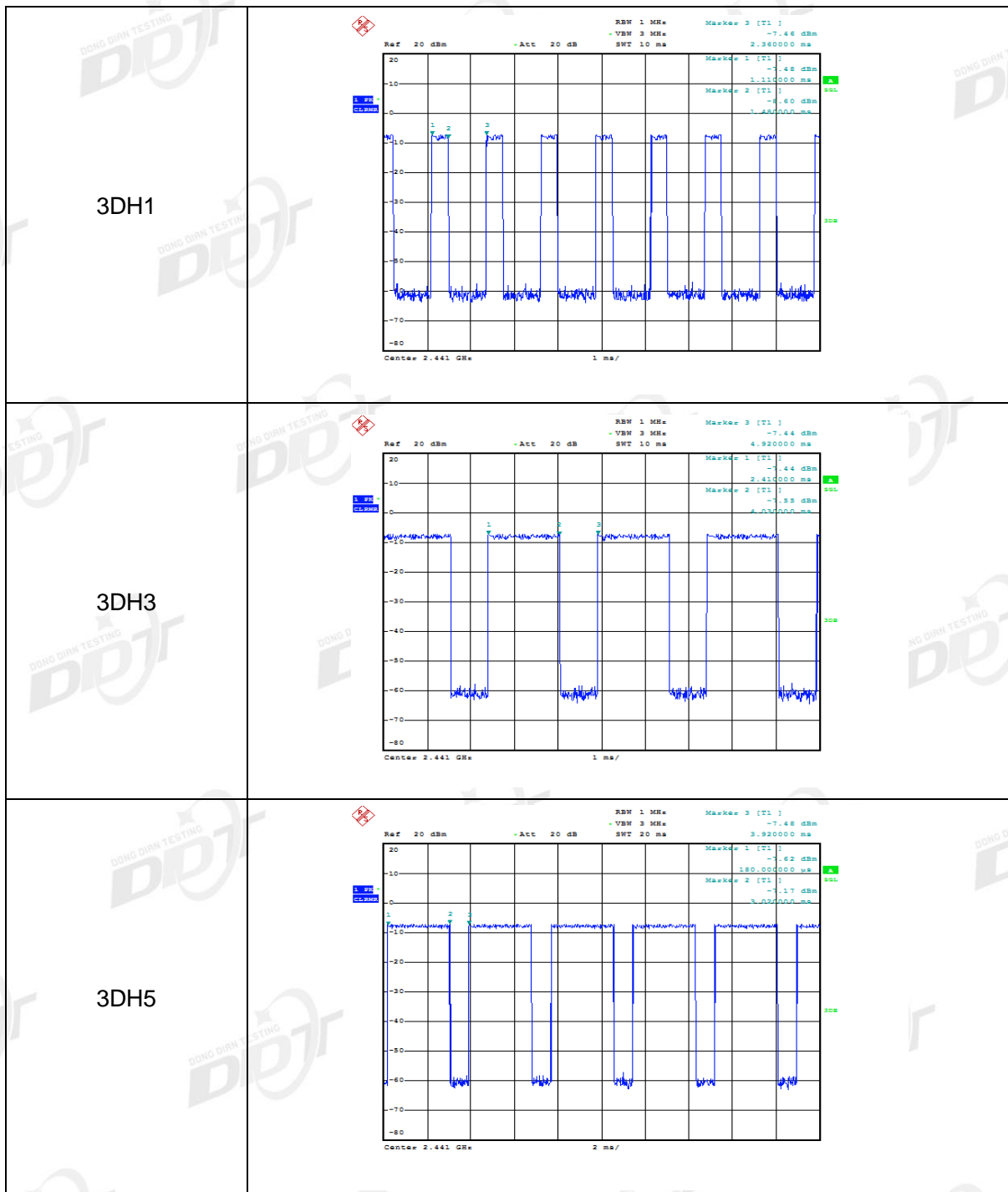

## 9. Band Edge Compliance (conducted method)

### 9.1. Block diagram of test setup

Same as section 4.1

### 9.2. Limit

All restriction band should comply with 15.209, other emission should be at least 20dB below the

fundamental.

### 9.3. Test result

Mode	Freq (MHz)	Conclusion
GFSK	Hopping off 2402	PASS
	Hopping off 2480	PASS
	Hopping on	PASS
8-DPSK	Hopping off 2402	PASS
	Hopping off 2480	PASS
	Hopping on	PASS

### 9.4. Original test data

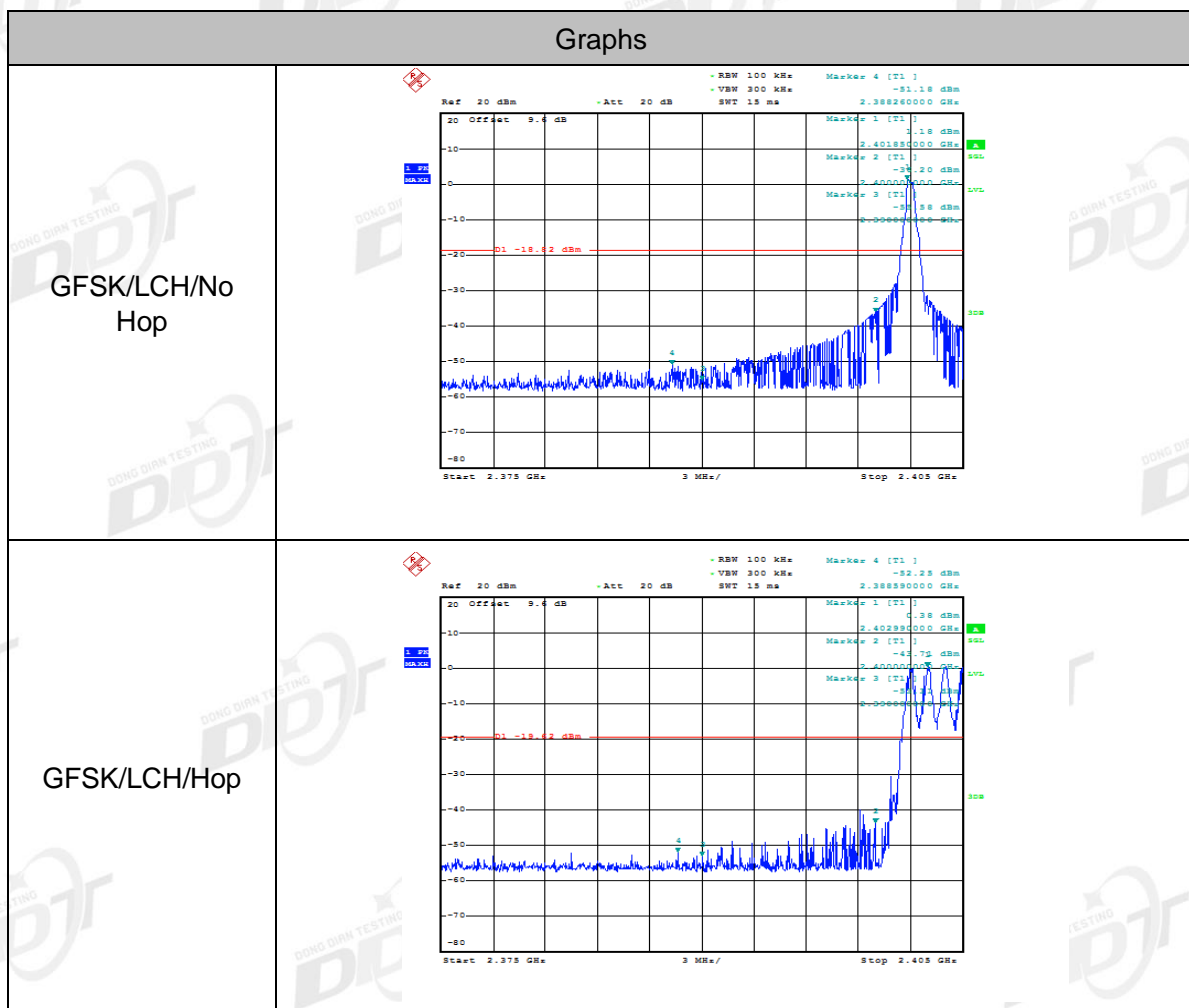

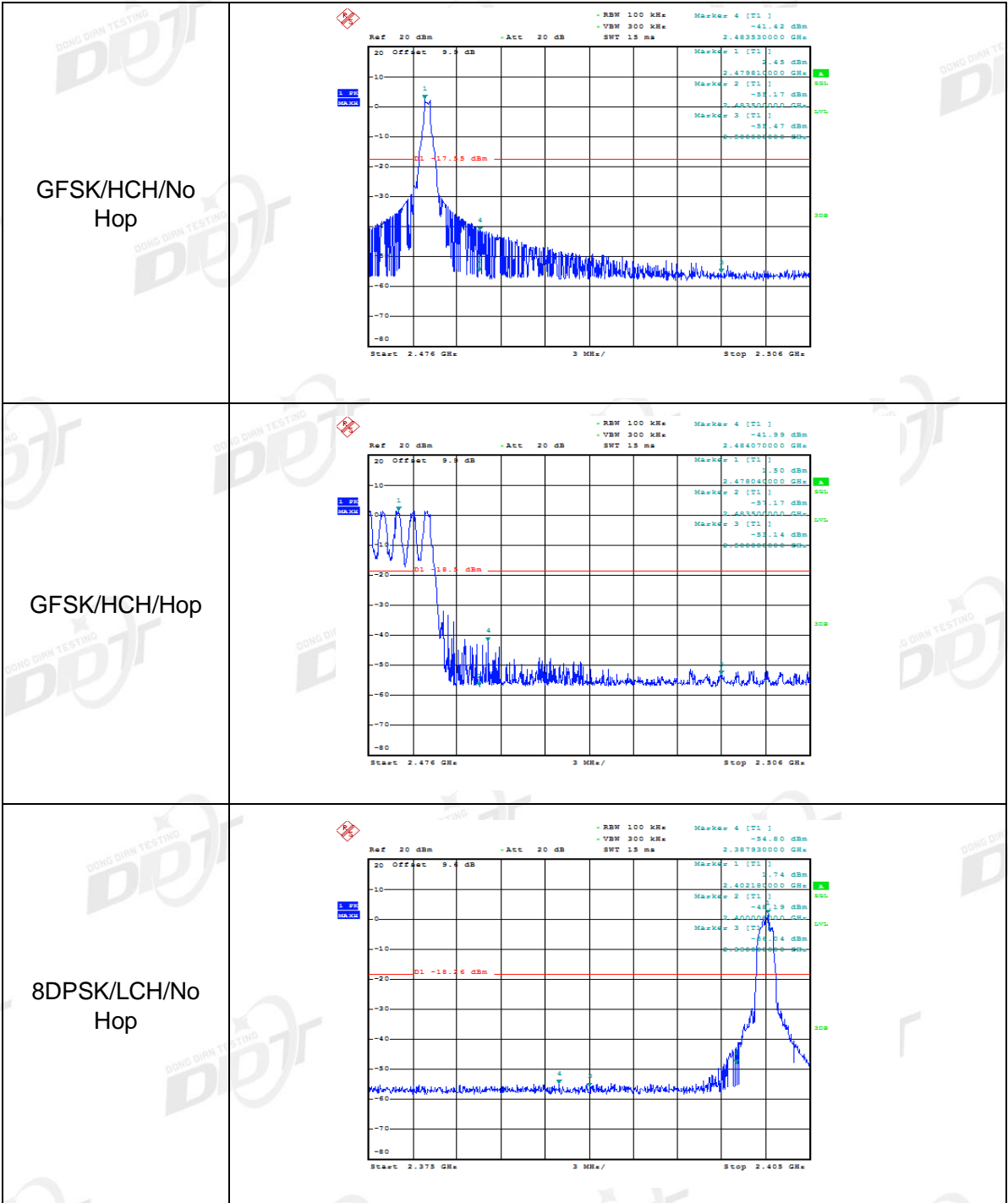

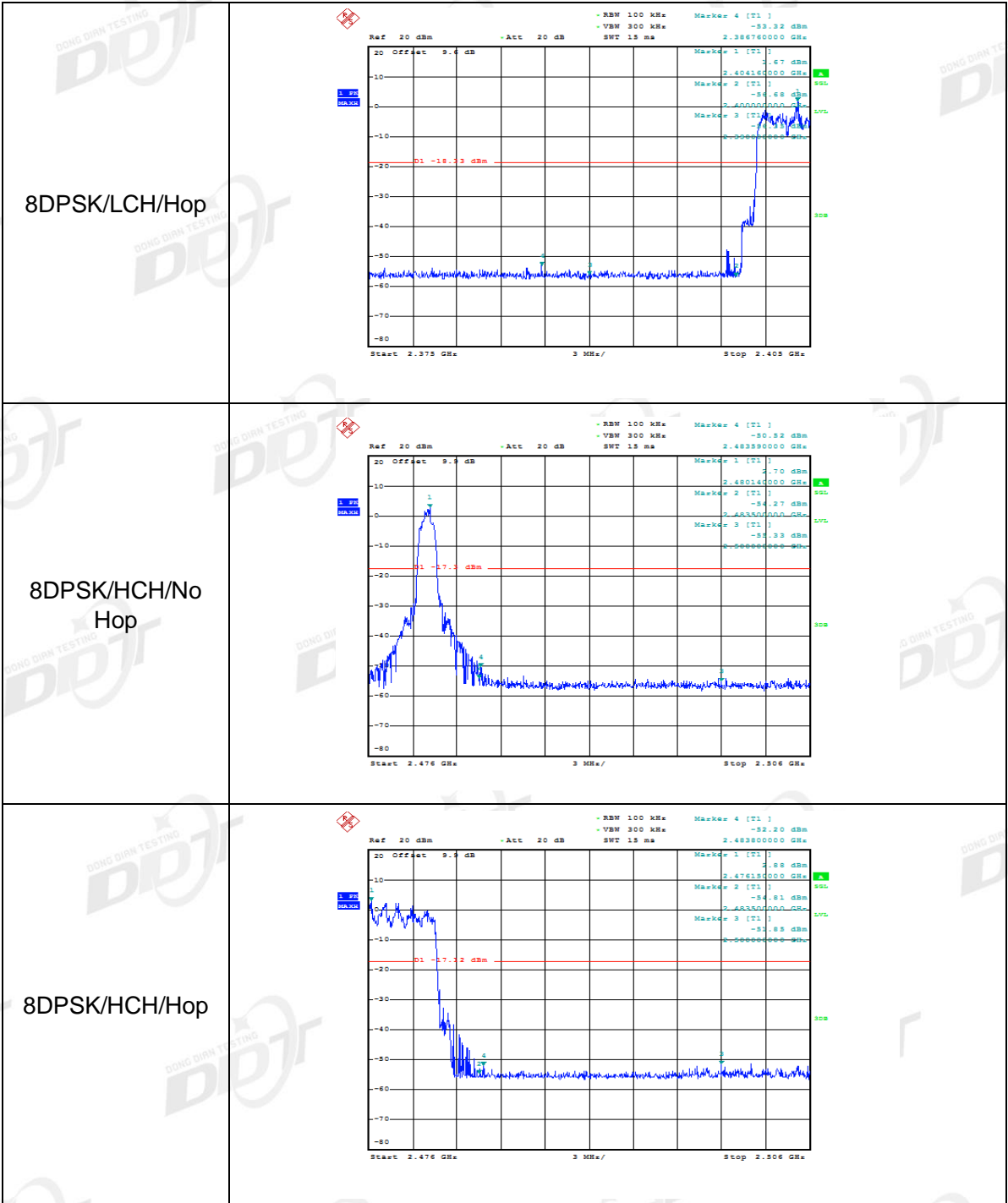

## 10. Radiated emission

### 10.1. Block diagram of test setup

In 3m Anechoic Chamber Test Setup Diagram for 9KHz-30MHz

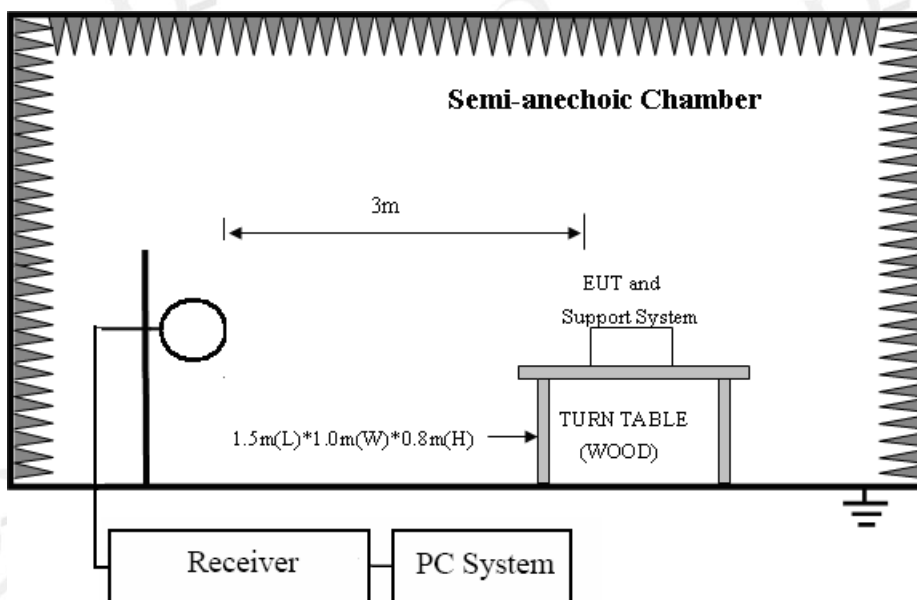

In 3m Anechoic Chamber Test Setup Diagram for below 1GHz

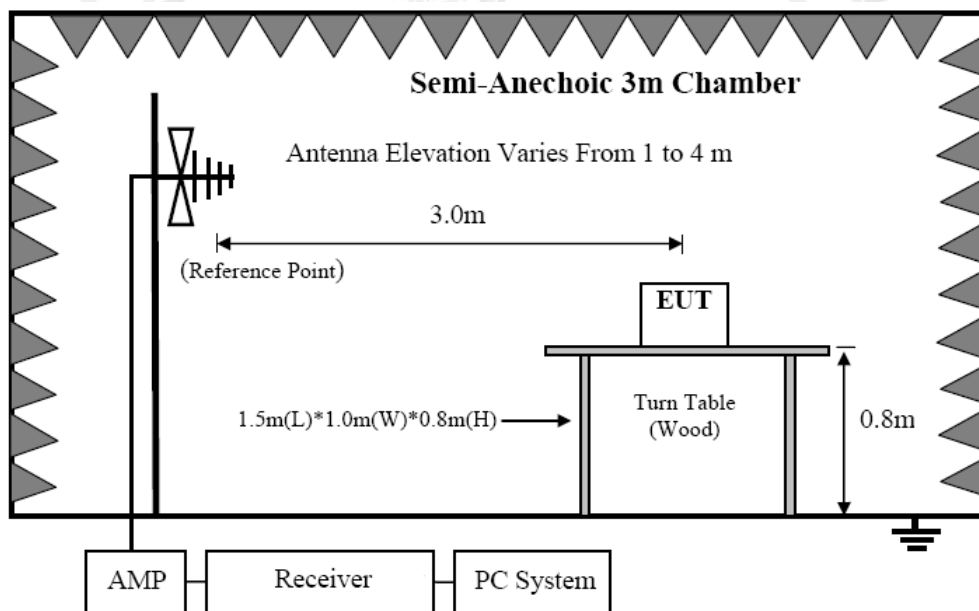

In 3m Anechoic Chamber Test Setup Diagram for frequency above 1GHz

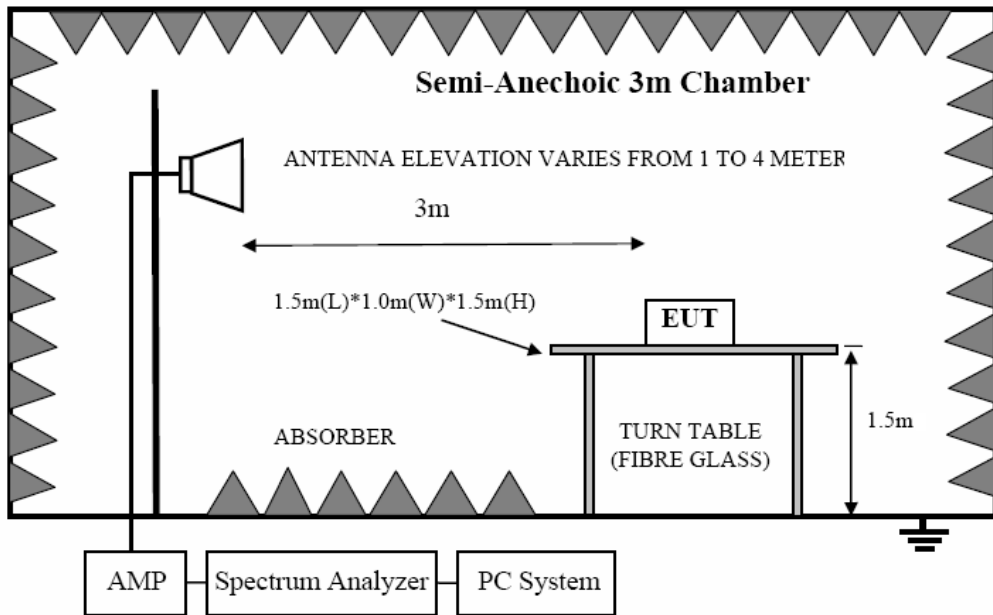

Note: For harmonic emissions test a appropriate high pass filter was inserted in the input port of AMP.

**10.2. Limit**

(1) FCC 15.205 Restricted frequency band

MHz	MHz	MHz	GHz
0.090 - 0.110	16.42 - 16.423	399.9 - 410	4.5 - 5.15
<sup>1</sup> 0.495 - 0.505	16.69475 - 16.69525	608 - 614	5.35 - 5.46
2.1735 - 2.1905	16.80425 - 16.80475	960 - 1240	7.25 - 7.75
4.125 - 4.128	25.5 - 25.67	1300 - 1427	8.025 - 8.5
4.17725 - 4.17775	37.5 - 38.25	1435 - 1626.5	9.0 - 9.2
4.20725 - 4.20775	73 - 74.6	1645.5 - 1646.5	9.3 - 9.5
6.215 - 6.218	74.8 - 75.2	1660 - 1710	10.6 - 12.7
6.26775 - 6.26825	108 - 121.94	1718.8 - 1722.2	13.25 - 13.4
6.31175 - 6.31225	123 - 138	2200 - 2300	14.47 - 14.5
8.291 - 8.294	149.9 - 150.05	2310 - 2390	15.35 - 16.2
8.362 - 8.366	156.52475 - 156.52525	2483.5 - 2500	17.7 - 21.4
8.37625 - 8.38675	156.7 - 156.9	2690 - 2900	22.01 - 23.12
8.41425 - 8.41475	162.0125 - 167.17	3260 - 3267	23.6 - 24.0
12.29 - 12.293	167.72 - 173.2	3332 - 3339	31.2 - 31.8
12.51975 - 12.52025	240 - 285	3345.8 - 3358	36.43 - 36.5
12.57675 - 12.57725	322 - 335.4	3600 - 4400	( <sup>2</sup> )

(2) FCC 15.209 Limit.

FREQUENCY MHz	DISTANCE Meters	FIELD STRENGTHS LIMIT	
		μV/m	dB(μV)/m
0.009 ~ 0.490	300	2400/F(KHz)	67.6-20log(F)
0.490 ~ 1.705	30	24000/F(KHz)	87.6-20log(F)
1.705 ~ 30.0	30	30	29.54
30 ~ 88	3	100	40.0
88 ~ 216	3	150	43.5
216 ~ 960	3	200	46.0
960 ~ 1000	3	500	54.0

Above 1000	3	74.0 dB( $\mu$ V)/m (Peak) 54.0 dB( $\mu$ V)/m (Average)
------------	---	---

Note: (1) The emission limits shown in the above table are based on measurements employing a CISPR QP detector except for the frequency bands 9-90KHz, 110-490KHz and above 1000MHz. Radiated emissions limits in these three bands are based on measurements employing an average detector.

(2) At frequencies below 30MHz, measurement may be performed at a distance closer than that specified, and the limit at closer measurement distance can be extrapolated by below formula:

$$\text{Limit}_{3m}(\text{dBuV/m}) = \text{Limit}_{30m}(\text{dBuV/m}) + 40\text{Log}(30m/3m)$$

(3) Limit for this EUT

All the emissions appearing within 15.205 restricted frequency bands shall not exceed the limits shown in 15.209, all the other emissions shall be at least 20dB below the fundamental emissions, or comply with 15.209 limits.

### 10.3. Test Procedure

- (1) EUT was placed on a non-metallic table, 150 cm above the ground plane inside a semi-anechoic chamber.
- (2) Test antenna was located 3m from the EUT on an adjustable mast, and the antenna used as below table.

Test frequency range	Test antenna used	Test antenna distance
9KHz-30MHz	Active Loop antenna	3m
30MHz-1GHz	Trilog Broadband Antenna	3m
1GHz-18GHz	Double Ridged Horn Antenna(1GHz-18GHz)	3m
18GHz-40GHz	Horn Antenna(18GHz-40GHz)	1m

According ANSI C63.10:2013 clause 6.4.4.2 and 6.5.3, for measurements below 30 MHz, the loop antenna was positioned with its plane vertical from the EUT and rotated about its vertical axis for maximum response at each azimuth position around the EUT. And the loop antenna also be positioned with its plane horizontal at the specified distance from the EUT. The center of the loop is 1 m above the ground. for measurement above 30MHz, the Trilog Broadband Antenna or Horn Antenna was located 3m from EUT, Measurements were made with the antenna positioned in both the horizontal and vertical planes of

Polarization, and the measurement antenna was varied from 1 m to 4 m. in height above the reference ground plane to obtain the maximum signal strength.

(3) Below pre-scan procedure was first performed in order to find prominent frequency spectrum radiated emissions from 9KHz to 25GHz:

- (a) Scanning the peak frequency spectrum with the antenna specified in step (3), and the EUT

was rotated 360 degree, the antenna height was varied from 1m to 4m(Except loop antenna, it's fixed 1m above ground.)

- (b) Change work frequency or channel of device if practicable.
- (c) Change modulation type of device if practicable.
- (d) Change power supply range from 85% to 115% of the rated supply voltage
- (e) Rotated EUT though three orthogonal axes to determine the attitude of EUT arrangement produces highest emissions.

Spectrum frequency from 9KHz to 25GHz (tenth harmonic of fundamental frequency) was investigated, and no any obvious emission were detected from 18GHz to 25GHz, so below final test was performed with frequency range from 9KHz to 18GHz.

- (4) For final emissions measurements at each frequency of interest, the EUT was rotated and the antenna height was varied between 1m and 4m in order to maximize the emission. Measurements in both horizontal and vertical polarities were made and the data was recorded. In order to find the maximum emission, the relative positions of equipments and all of the interface cables were changed according to ANSI C63.10 2013 on Radiated Emission test.
- (5) The emissions from 9KHz to 1GHz were measured based on CISPR QP detector except for the frequency bands 9-90KHz, 110-490KHz, for emissions from 9KHz-90KHz,110KHz-490KHz and above 1GHz were measured based on average detector, for emissions above 1GHz, peak emissions also be measured and need comply with Peak limit.
- (6) The emissions from 9KHz to 1GHz, QP or average values were measured with EMI receiver with below RBW.

Frequency band	RBW
9KHz-150KHz	200Hz
150KHz-30MHz	9KHz
30MHz-1GHz	120KHz

- (7) For emissions above 1GHz, both Peak and Average level were measured with Spectrum Analyzer, and the RBW is set at 1MHz, VBW is set at 3MHz for Peak measure; RMS detector RBW 1MHz VBW 3MHz for Average measure(according ANSI C63.10:2013 clause 4.2.3.2.3 procedure for average measure).
- (8) X axis, Y axis, Z axis are tested, and worse setup X axis is reported.

#### 10.4. Test result

##### **PASS. (See below detailed test result)**

All the emissions except fundamental emission from 9 KHz to 25GHz were comply with 15.209 limits.

Note1: According exploratory test no any obvious emission were detected from 9KHz to 30MHz and 18GHz to 25GHz.

Note2: For emissions below 1GHz, according exploratory explorer test, when change Tx mode and channel, have no distinct influence on emissions level, so for emissions below 1GHz, the

final test was only performed with EUT working in GFSK, Tx 2441MHz mode.

Note3: For emissions above 1GHz. If peak results comply with AV limit, AV Result is deemed to comply with AV limit.

## Radiated Emission test (below 1GHz) TR-4-E-009 Radiated Emission Test Result

<b>Test Site</b>	: DDT 3m Chamber 1#	<b>D:\2017 RE1# Report Data\Q17101804-1E\FCC 30M-1G.EM6</b>
<b>Test Date</b>	: 2017-10-23	<b>Tested By</b> : Bobo
<b>EUT</b>	: PORTABLE BLUETOOTH SPEAKER	<b>Model Number</b> : GO2H
<b>Power Supply</b>	: Battery	<b>Test Mode</b> : TX mode
<b>Condition</b>	: Temp:24.5°C,Humi:55%, Press:100.1kPa	<b>Antenna/Distance</b> : 2016 VULB9163 1#/3m/VERTICAL
<b>Memo</b>	: Battery model: GO2/MLP284154	

Data: 1

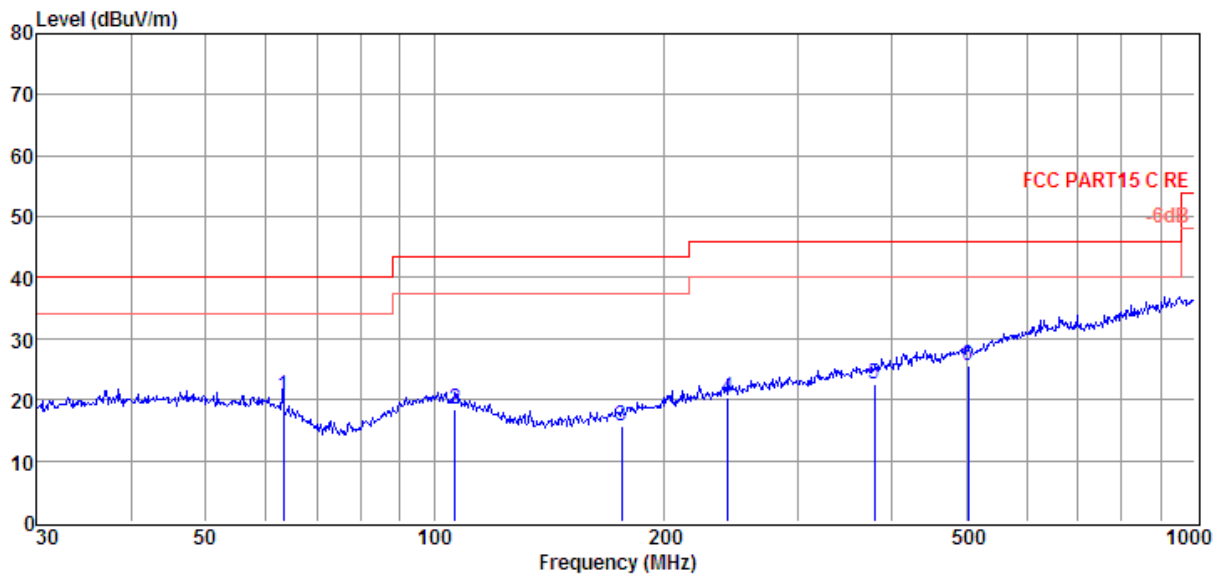

Item (Mark)	Freq. (MHz)	Read Level (dBμV)	Antenna Factor (dB/m)	Cable Loss (dB)	Result Level (dBμV/m)	Limit Line (dBμV/m)	Over Limit (dB)	Detector	Polarization
1	63.31	6.39	10.22	4.00	20.61	40.00	-19.39	QP	VERTICAL
2	106.39	2.53	11.43	4.34	18.30	43.50	-25.20	QP	VERTICAL
3	176.27	1.81	8.98	4.76	15.55	43.50	-27.95	QP	VERTICAL
4	243.38	2.99	12.17	5.11	20.27	46.00	-25.73	QP	VERTICAL
5	378.58	1.53	15.20	5.71	22.44	46.00	-23.56	QP	VERTICAL
6	502.94	1.94	17.50	6.18	25.62	46.00	-20.38	QP	VERTICAL

- Note: 1. Result Level = Read Level + Antenna Factor + Cable loss.  
 2. If Peak Result complies with QP limit, QP Result is deemed to comply with QP limit.  
 3. Test setup: RBW: 120 kHz, VBW: 300 kHz, Sweep time: auto.

## TR-4-E-009 Radiated Emission Test Result

**Test Site** : DDT 3m Chamber 1# D:\2017 RE1# Report Data\Q17101804-1E\FCC 30M-1G.EM6  
**Test Date** : 2017-10-23 **Tested By** : Bobo  
**EUT** : PORTABLE BLUETOOTH SPEAKER **Model Number** : GO2H  
**Power Supply** : Battery **Test Mode** : TX mode  
**Condition** : Temp:24.5'C,Humi:55%,  
 : Press:100.1kPa **Antenna/Distance** : 2016 VULB9163 1#/3m/HORIZONTAL  
**Memo** : Battery model: GO2/MLP284154

Data: 2

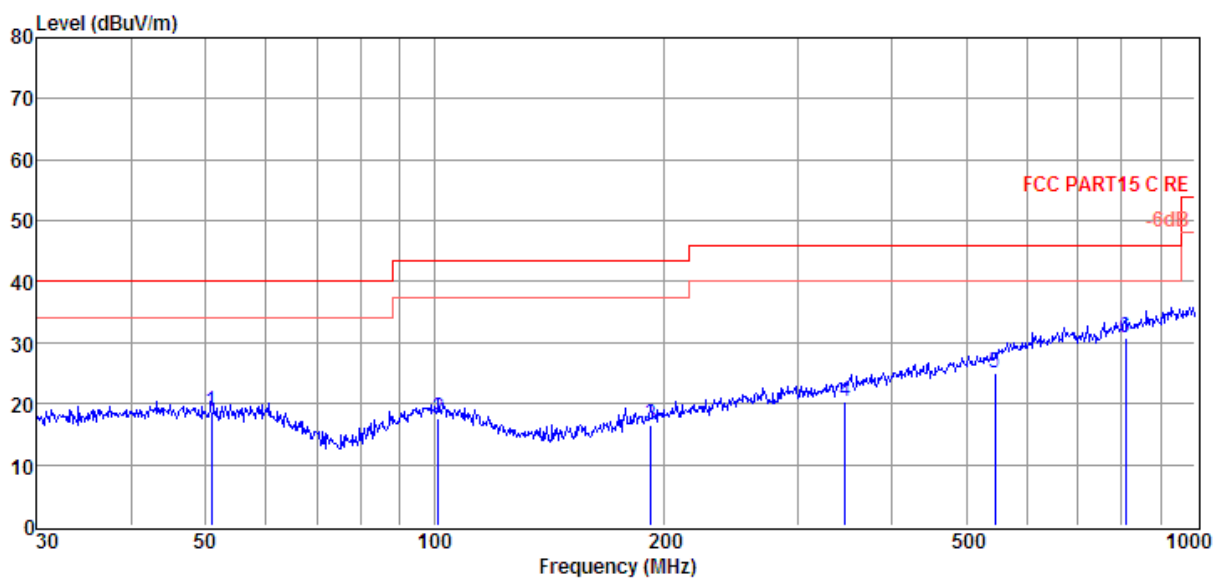

Item (Mark)	Freq. (MHz)	Read Level (dBuV)	Antenna Factor (dB/m)	Cable Loss (dB)	Result Level (dBuV/m)	Limit Line (dBuV/m)	Over Limit (dB)	Detector	Polarization
1	50.94	2.93	11.86	3.90	18.69	40.00	-21.31	QP	HORIZONTAL
2	101.29	1.30	11.90	4.31	17.51	43.50	-25.99	QP	HORIZONTAL
3	192.42	1.82	9.95	4.85	16.62	43.50	-26.88	QP	HORIZONTAL
4	346.81	0.13	14.70	5.58	20.41	46.00	-25.59	QP	HORIZONTAL
5	545.18	0.53	18.25	6.32	25.10	46.00	-20.90	QP	HORIZONTAL
6	810.27	2.41	21.21	7.15	30.77	46.00	-15.23	QP	HORIZONTAL

Note: 1. Result Level = Read Level + Antenna Factor + Cable loss.

2. If Peak Result complies with QP limit, QP Result is deemed to comply with QP limit.

3. Test setup: RBW: 120 kHz, VBW: 300 kHz, Sweep time: auto.

# TR-4-E-009 Radiated Emission Test Result

**Test Site** : DDT 3m Chamber 1# D:\2020 RE 1# Report data\Q20030310-1E G0 2\FCC BELOW 1G.EM6  
**Test Date** : 2020-03-05 **Tested By** : Jacky  
**EUT** : Bluetooth Speaker **Model Number** : JBL GO2  
**Power Supply** : Battery **Test Mode** : Tx mode  
**Condition** : Temp:24.5°C,Humi:55%,Press:100.1kPa **Antenna/Distance** : 2019 VULB 9163 1#/3m/VERTICAL  
**Memo** : Battery model: L0707-LF

Data: 9

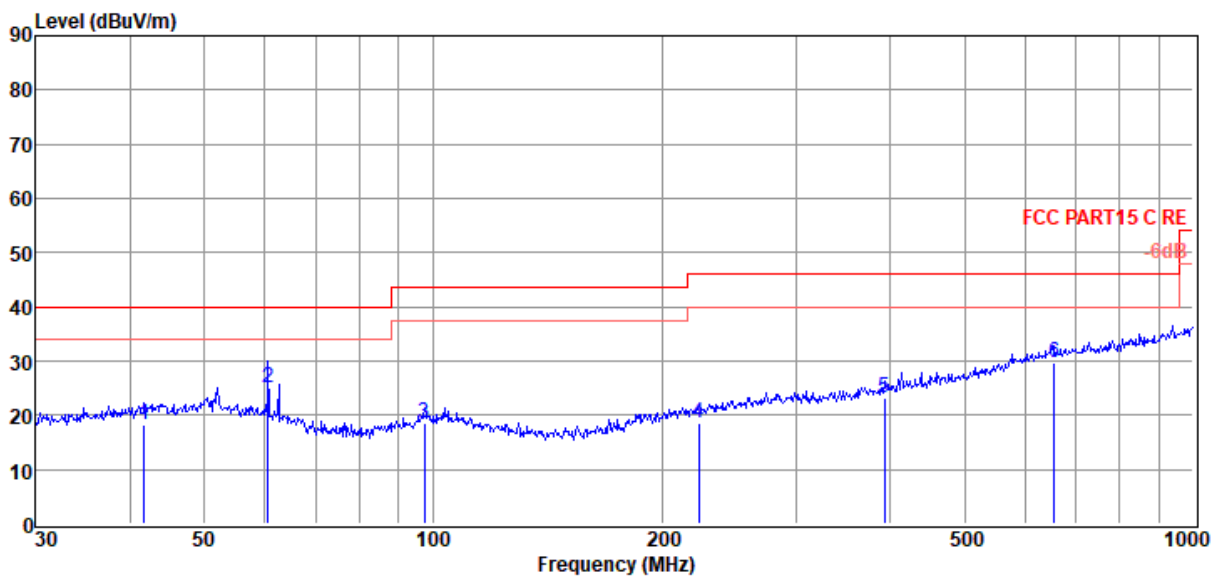

Item (Mark)	Freq. (MHz)	Read Level (dBuV)	Antenna Factor (dB/m)	Cable Loss (dB)	Result Level (dBuV/m)	Limit Line (dBuV/m)	Over Limit (dB)	Detector	Polarization
1	41.71	0.42	13.79	3.92	18.13	40.00	-21.87	QP	VERTICAL
2	60.70	8.20	12.74	4.10	25.04	40.00	-14.96	QP	VERTICAL
3	97.46	2.43	11.66	4.39	18.48	43.50	-25.02	QP	VERTICAL
4	223.73	1.24	12.15	5.16	18.55	46.00	-27.45	QP	VERTICAL
5	392.10	2.01	15.22	5.93	23.16	46.00	-22.84	QP	VERTICAL
6	656.53	3.28	19.61	6.94	29.83	46.00	-16.17	QP	VERTICAL

- Note: 1. Result Level = Read Level + Antenna Factor + Cable loss.  
 2. If Peak Result complies with QP limit, QP Result is deemed to comply with QP limit.  
 3. Test setup: RBW: 120 kHz, VBW: 300 kHz, Sweep time: auto.

## TR-4-E-009 Radiated Emission Test Result

**Test Site** : DDT 3m Chamber 1#

D:\2020 RE 1# Report data\Q20030310-1E G0 2\FCC BELOW  
1G.EM6

**Test Date** : 2020-03-05

**Tested By** : Jacky

**EUT** : Bluetooth Speaker

**Model Number** : JBL GO2

**Power Supply** : Battery

**Test Mode** : Tx mode

**Condition** : Temp:24.5°C,Humi:55%,Press:100.1kPa

**Antenna/Distance** : 2019 VULB 9163 1#/3m/HORIZONTAL

**Memo** : Battery model: L0707-LF

Data: 10

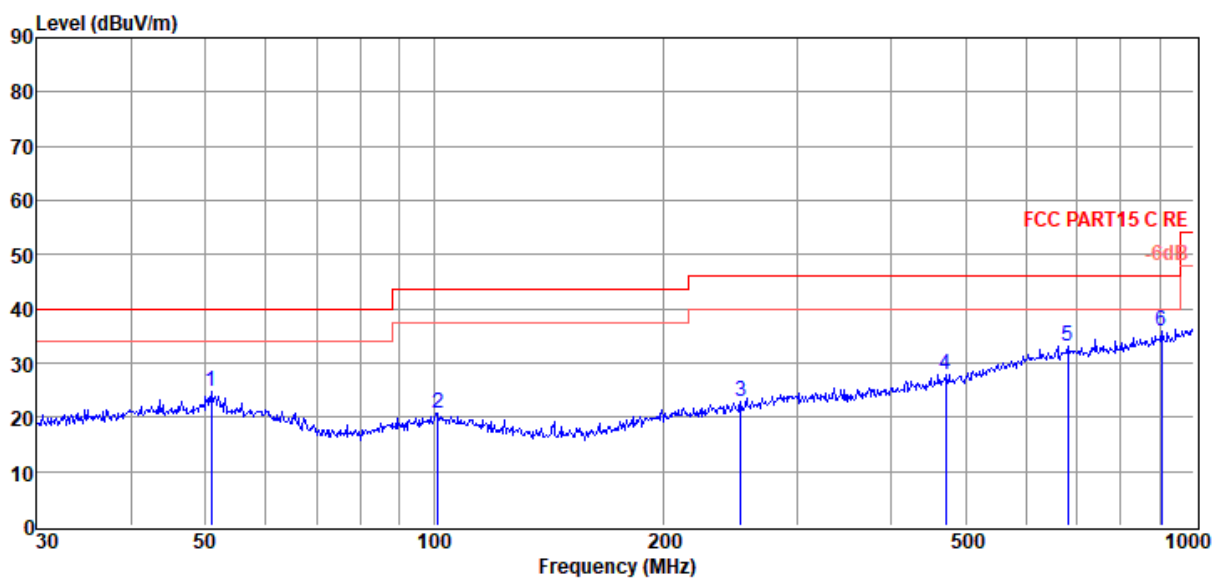

Item (Mark)	Freq. (MHz)	Read Level (dB $\mu$ V)	Antenna Factor (dB/m)	Cable Loss dB	Result Level (dB $\mu$ V/m)	Limit Line (dB $\mu$ V/m)	Over Limit (dB)	Detector	Polarization
1	50.94	6.64	14.08	4.00	24.72	40.00	-15.28	Peak	HORIZONTAL
2	101.29	4.49	11.82	4.42	20.73	43.50	-22.77	Peak	HORIZONTAL
3	252.95	4.73	12.96	5.31	23.00	46.00	-23.00	Peak	HORIZONTAL
4	470.52	5.02	16.68	6.24	27.94	46.00	-18.06	Peak	HORIZONTAL
5	682.35	6.42	19.78	7.02	33.22	46.00	-12.78	Peak	HORIZONTAL
6	906.48	6.15	21.87	7.71	35.73	46.00	-10.27	Peak	HORIZONTAL

Note: 1. Result Level = Read Level + Antenna Factor + Cable loss.

2. If Peak Result complies with QP limit, QP Result is deemed to comply with QP limit.

3. Test setup: RBW: 120 kHz, VBW: 300 kHz, Sweep time: auto.

# TR-4-E-009 Radiated Emission Test Result

**Test Site** : DDT 3m Chamber 1# **D:\2018 RE1# Report Data\Q18041303-1E\FCC BELOW1G.EM6**  
**Test Date** : 2018-04-17 **Tested By** : TALENT  
**EUT** : PORTABLE BLUETOOTH SPEAKER **Model Number** : GO2H  
**Power Supply** : Battery **Test Mode** : Tx mode  
**Condition** : Temp:24.5'C,Humi:55%,  
**Antenna/Distance** : 2017 VULB 9163 1#/3m/HORIZONTAL  
 Press:100.1kPa  
**Memo** : Add power amplifier

Data: 1

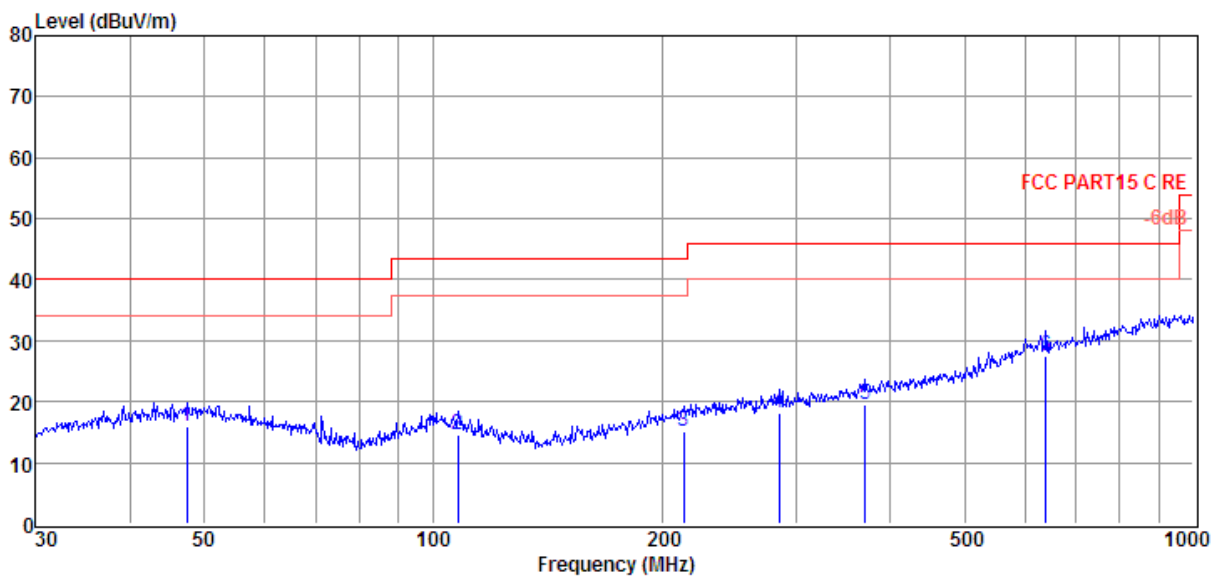

Item (Mark)	Freq. (MHz)	Read Level (dBuV)	Antenna Factor (dB/m)	Cable Loss (dB)	Result Level (dBuV/m)	Limit Line (dBuV/m)	Over Limit (dB)	Detector	Polarization
1	47.49	-1.61	13.52	3.96	15.87	40.00	-24.13	QP	HORIZONTAL
2	107.89	-0.59	10.54	4.48	14.43	43.50	-29.07	QP	HORIZONTAL
3	213.76	-1.69	11.80	5.10	15.21	43.50	-28.29	QP	HORIZONTAL
4	284.98	-0.44	13.07	5.46	18.09	46.00	-27.91	QP	HORIZONTAL
5	370.70	-1.00	14.70	5.84	19.54	46.00	-26.46	QP	HORIZONTAL
6	640.61	1.19	19.53	6.81	27.53	46.00	-18.47	QP	HORIZONTAL

- Note: 1. Result Level = Read Level + Antenna Factor + Cable loss.  
 2. If Peak Result complies with QP limit, QP Result is deemed to comply with QP limit.  
 3. Test setup: RBW: 120 kHz, VBW: 300 kHz, Sweep time: auto.

## TR-4-E-009 Radiated Emission Test Result

**Test Site** : DDT 3m Chamber 1# **D:\2018 RE1# Report Data\Q18041303-1E\FCC BELOW1G.EM6**  
**Test Date** : 2018-04-17 **Tested By** : TALENT  
**EUT** : PORTABLE BLUETOOTH SPEAKER **Model Number** : GO2H  
**Power Supply** : Battery **Test Mode** : Tx mode  
**Condition** : Temp:24.5'C,Humi:55%,  
**Antenna/Distance** : 2017 VULB 9163 1#/3m/VERTICAL  
 Press:100.1kPa  
**Memo** : Add power amplifier

Data: 2

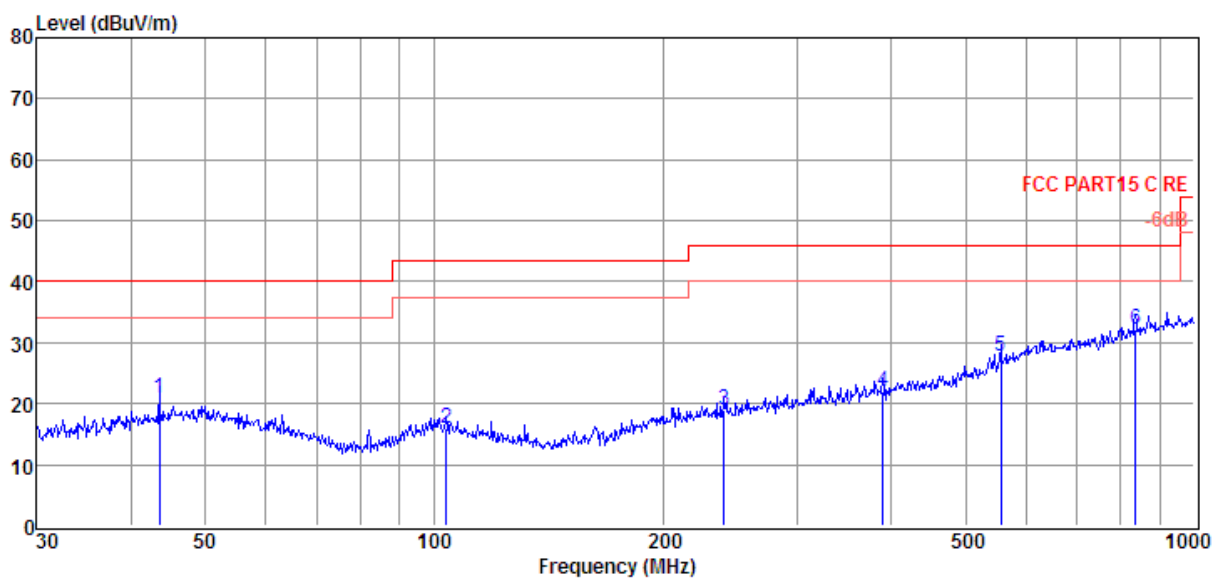

Item (Mark)	Freq. (MHz)	Read Level (dB $\mu$ V)	Antenna Factor (dB/m)	Cable Loss (dB)	Result Level (dB $\mu$ V/m)	Limit Line (dB $\mu$ V/m)	Over Limit (dB)	Detector	Polarization
1	43.51	3.90	13.05	3.92	20.87	40.00	-19.13	QP	VERTICAL
2	103.81	0.34	11.03	4.44	15.81	43.50	-27.69	QP	VERTICAL
3	240.83	1.44	12.32	5.25	19.01	46.00	-26.99	QP	VERTICAL
4	389.36	1.14	15.02	5.91	22.07	46.00	-23.93	QP	VERTICAL
5	556.77	3.09	18.62	6.12	27.83	46.00	-18.17	QP	VERTICAL
6	836.24	3.09	21.79	7.42	32.30	46.00	-13.70	QP	VERTICAL

Note: 1. Result Level = Read Level + Antenna Factor + Cable loss.

2. If Peak Result complies with QP limit, QP Result is deemed to comply with QP limit.

3. Test setup: RBW: 120 kHz, VBW: 300 kHz, Sweep time: auto.

# TR-4-E-009 Radiated Emission Test Result

**Test Site** : DDT 3m Chamber 1# **D:\2018 RE1# Report Data\Q18082902-1E\RE.EM6**  
**Test Date** : 2018-08-29 **Tested By** : Open  
**EUT** : PORTABLE BLUETOOTH SPEAKER **Model Number** : GO2H  
**Power Supply** : Battery **Test Mode** : TX mode  
**Condition** : Temp:24.5°C, Humi:55.5%,  
 Press:100.1kPa **Antenna/Distance** : 2017 VULB 9163 1#/3m/VERTICAL  
**Memo** : Battery model: 304055

Data: 7

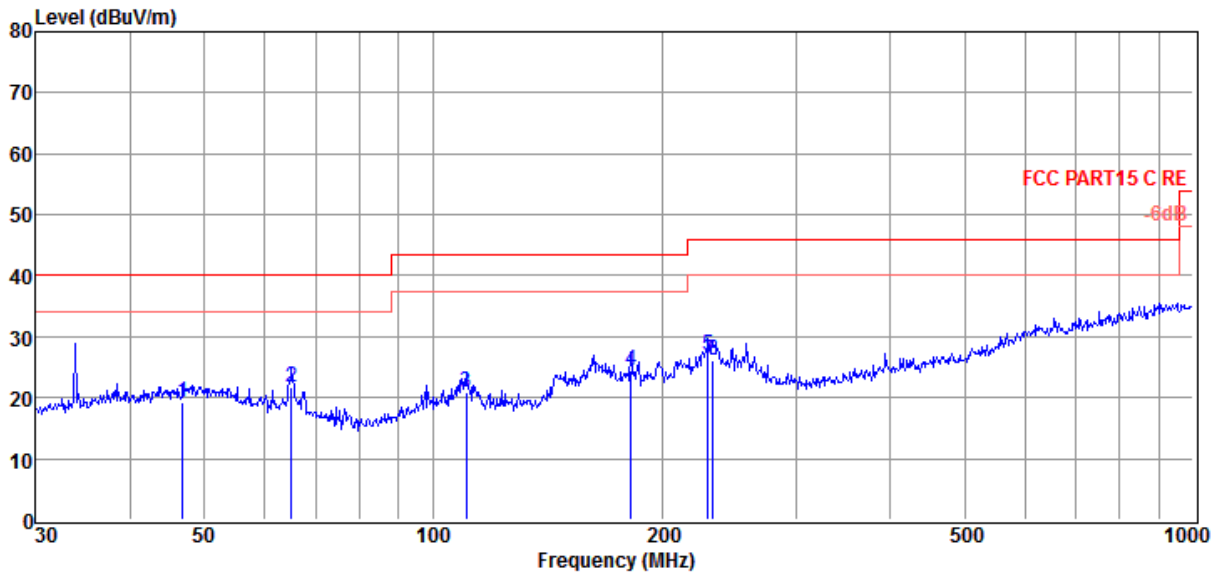

Item (Mark)	Freq. (MHz)	Read Level (dBμV)	Antenna Factor (dB/m)	Cable Loss (dB)	Result Level (dBμV/m)	Limit Line (dBμV/m)	Over Limit (dB)	Detector	Polarization
1	46.83	1.76	13.45	3.96	19.17	40.00	-20.83	QP	VERTICAL
2	65.11	7.46	10.23	4.14	21.83	40.00	-18.17	QP	VERTICAL
3	110.57	6.06	10.23	4.50	20.79	43.50	-22.71	QP	VERTICAL
4	181.92	9.76	9.88	4.94	24.58	43.50	-18.92	QP	VERTICAL
5	230.10	9.51	12.12	5.19	26.82	46.00	-19.18	QP	VERTICAL
6	233.35	8.69	12.18	5.21	26.08	46.00	-19.92	QP	VERTICAL

- Note: 1. Result Level = Read Level + Antenna Factor + Cable loss.  
 2. If Peak Result complies with QP limit, QP Result is deemed to comply with QP limit.  
 3. Test setup: RBW: 120 kHz, VBW: 300 kHz, Sweep time: auto.

# TR-4-E-009 Radiated Emission Test Result

**Test Site** : DDT 3m Chamber 1# **D:\2018 RE1# Report Data\Q18082902-1E\RE.EM6**  
**Test Date** : 2018-08-29 **Tested By** : Open  
**EUT** : PORTABLE BLUETOOTH SPEAKER **Model Number** : GO2H  
**Power Supply** : Battery **Test Mode** : TX mode  
**Condition** : Temp:24.5°C, Humi:55.5%, **Antenna/Distance** : 2017 VULB 9163 1#/3m/HORIZONTAL  
Press:100.1kPa  
**Memo** : Battery model: 304055

Data: 8

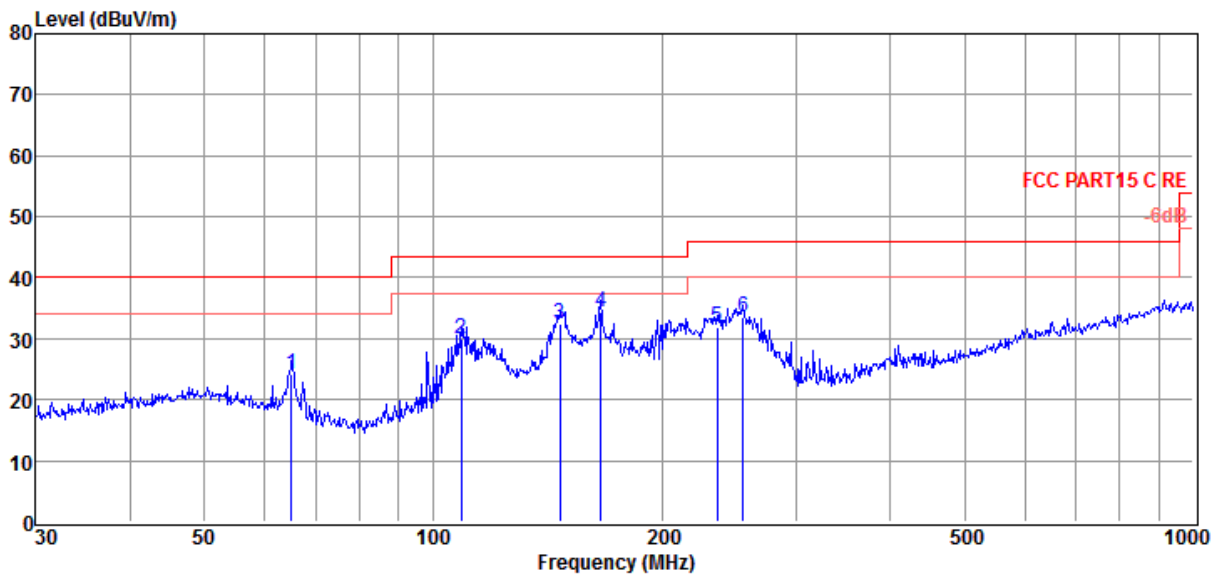

Item (Mark)	Freq. (MHz)	Read Level (dBμV)	Antenna Factor (dB/m)	Cable Loss (dB)	Result Level (dBμV/m)	Limit Line (dBμV/m)	Over Limit (dB)	Detector	Polarization
1	65.11	9.95	10.23	4.14	24.32	40.00	-15.68	QP	HORIZONTAL
2	109.03	14.96	10.41	4.49	29.86	43.50	-13.64	QP	HORIZONTAL
3	146.89	19.90	7.83	4.75	32.48	43.50	-11.02	QP	HORIZONTAL
4	166.07	20.43	8.95	4.86	34.24	43.50	-9.26	QP	HORIZONTAL
5	236.65	14.41	12.25	5.23	31.89	46.00	-14.11	QP	HORIZONTAL
6	255.62	15.56	12.59	5.32	33.47	46.00	-12.53	QP	HORIZONTAL

- Note: 1. Result Level = Read Level + Antenna Factor + Cable loss.  
 2. If Peak Result complies with QP limit, QP Result is deemed to comply with QP limit.  
 3. Test setup: RBW: 120 kHz, VBW: 300 kHz, Sweep time: auto.

# TR-4-E-009 Radiated Emission Test Result

**Test Site** : DDT 3m Chamber 1#

D:\2020 RE 1# Report data\Q20030310-1E G0 2\FCC BELOW 1G.EM6

**Test Date** : 2020-03-22

**Tested By** : Jacky

**EUT** : Bluetooth Speaker

**Model Number** : JBL GO2

**Power Supply** : Battery

**Test Mode** : Tx mode

**Condition** : Temp:24.5°C,Humi:55%,Press:100.1kPa

**Antenna/Distance** : 2019 VULB 9163 1#/3m/HORIZONTAL

**Memo** : Battery model: GSP383555 01

Data: 11

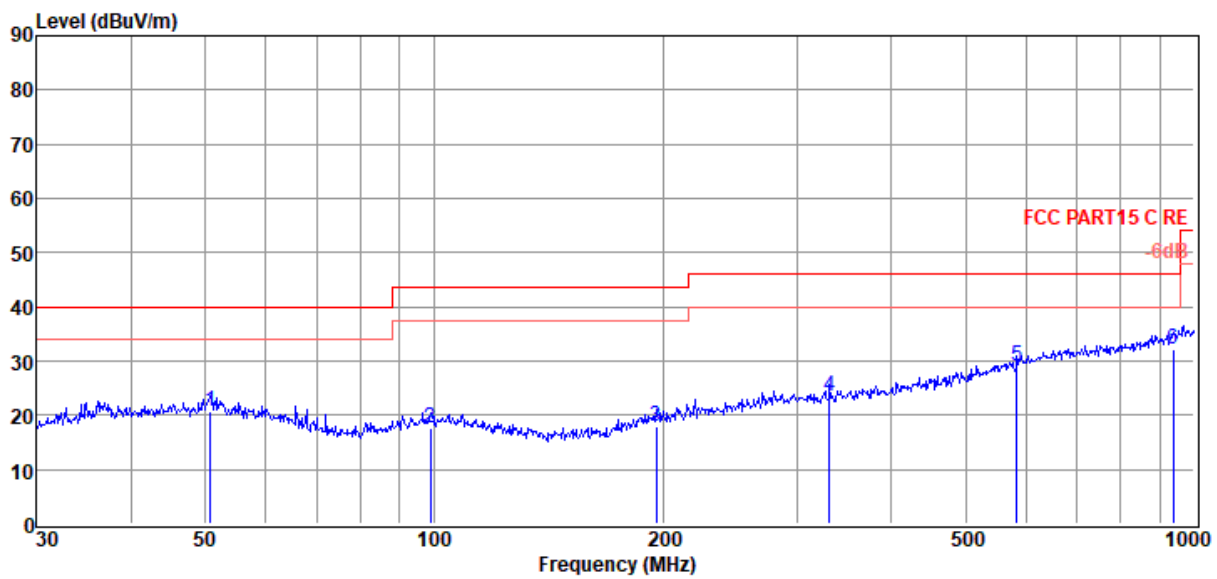

Item (Mark)	Freq. (MHz)	Read Level (dBuV)	Antenna Factor (dB/m)	Cable Loss (dB)	Result Level (dBuV/m)	Limit Line (dBuV/m)	Over Limit (dB)	Detector	Polarization
1	50.76	2.51	14.10	4.00	20.61	40.00	-19.39	QP	HORIZONTAL
2	98.83	1.30	11.79	4.40	17.49	43.50	-26.01	QP	HORIZONTAL
3	195.82	1.60	11.28	5.01	17.89	43.50	-25.61	QP	HORIZONTAL
4	331.36	3.40	14.51	5.67	23.58	46.00	-22.42	QP	HORIZONTAL
5	584.79	3.46	18.92	6.68	29.06	46.00	-16.94	QP	HORIZONTAL
6	938.83	2.17	22.20	7.80	32.17	46.00	-13.83	QP	HORIZONTAL

Note: 1. Result Level = Read Level + Antenna Factor + Cable loss.

2. If Peak Result complies with QP limit, QP Result is deemed to comply with QP limit.

3. Test setup: RBW: 120 kHz, VBW: 300 kHz, Sweep time: auto.

# TR-4-E-009 Radiated Emission Test Result

**Test Site** : DDT 3m Chamber 1# D:\2020 RE 1# Report data\Q20030310-1E G0 2\FCC BELOW 1G.EM6  
**Test Date** : 2020-03-22 **Tested By** : Jacky  
**EUT** : Bluetooth Speaker **Model Number** : JBL GO2  
**Power Supply** : Battery **Test Mode** : Tx mode  
**Condition** : Temp:24.5°C,Humi:55%,Press:100.1kPa **Antenna/Distance** : 2019 VULB 9163 1#/3m/VERTICAL  
**Memo** : Battery model: GSP383555 01

Data: 12

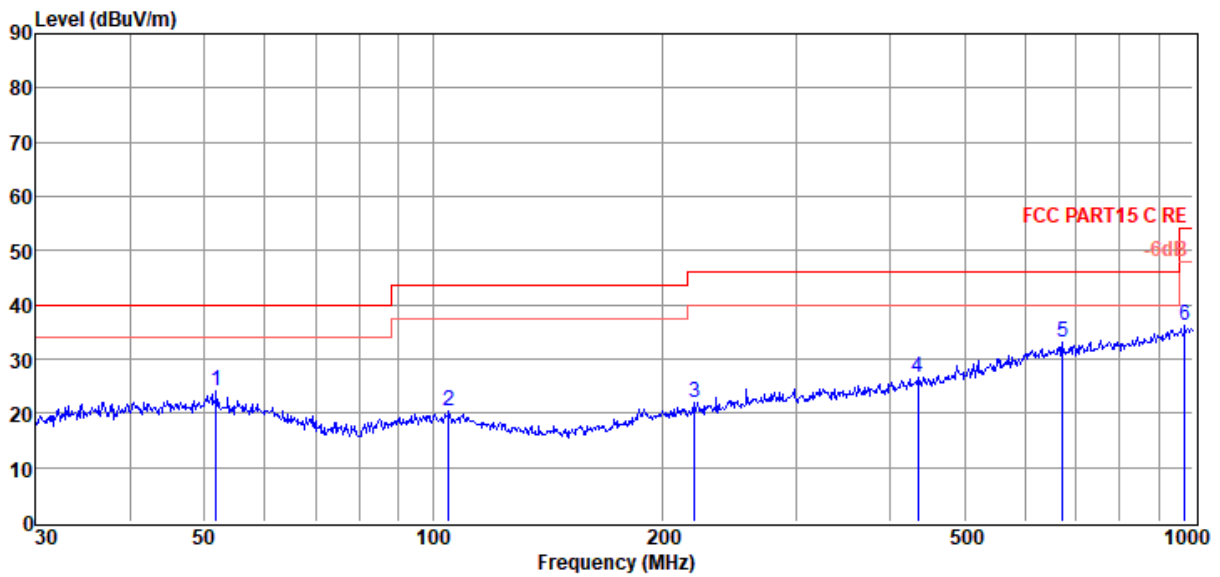

Item (Mark)	Freq. (MHz)	Read Level (dBμV)	Antenna Factor (dB/m)	Cable Loss (dB)	Result Level (dBμV/m)	Limit Line (dBμV/m)	Over Limit (dB)	Detector	Polarization
1	51.84	6.09	13.96	4.01	24.06	40.00	-15.94	QP	VERTICAL
2	104.90	4.22	11.60	4.45	20.27	43.50	-23.23	QP	VERTICAL
3	220.62	4.82	12.05	5.14	22.01	46.00	-23.99	QP	VERTICAL
4	434.07	4.43	16.00	6.10	26.53	46.00	-19.47	QP	VERTICAL
5	672.84	6.24	19.72	6.99	32.95	46.00	-13.05	QP	VERTICAL
6	975.75	5.68	22.57	7.90	36.15	54.00	-17.85	QP	VERTICAL

- Note: 1. Result Level = Read Level + Antenna Factor + Cable loss.  
 2. If Peak Result complies with QP limit, QP Result is deemed to comply with QP limit.  
 3. Test setup: RBW: 120 kHz, VBW: 300 kHz, Sweep time: auto.

**Radiated Emission test (above 1GHz)**

Freq. (MHz)	Read level (dB $\mu$ V)	Antenna Factor (dB/m)	PRM Factor (dB)	Cable Loss (dB)	Result Level (dB $\mu$ V/m)	Limit (dB $\mu$ V/m)	Margin (dB)	Detector type	Polarization
<b>GFSK Tx mode 2402MHz</b>									
4621.00	33.76	33.77	29.27	8.29	46.55	74.00	-27.45	Peak	HORIZONTAL
6406.00	32.63	35.65	29.66	9.88	48.50	74.00	-25.50	Peak	HORIZONTAL
7834.00	34.68	36.67	31.07	11.05	51.33	74.00	-22.67	Peak	HORIZONTAL
8735.00	34.97	36.35	32.07	11.73	50.98	74.00	-23.02	Peak	HORIZONTAL
9687.00	33.13	36.59	32.77	12.39	49.34	74.00	-24.66	Peak	HORIZONTAL
13206.00	33.91	39.01	35.54	14.73	52.11	74.00	-21.89	Peak	HORIZONTAL
4111.00	34.50	33.49	29.06	7.71	46.64	74.00	-27.36	Peak	VERTICAL
6406.00	32.25	35.65	29.66	9.88	48.12	74.00	-25.88	Peak	VERTICAL
7409.00	33.85	36.53	30.67	10.78	50.49	74.00	-23.51	Peak	VERTICAL
9041.00	34.07	37.41	32.34	11.87	51.01	74.00	-22.99	Peak	VERTICAL
10979.00	32.16	37.74	33.92	13.45	49.43	74.00	-24.57	Peak	VERTICAL
12934.00	33.53	38.74	35.67	14.67	51.27	74.00	-22.73	Peak	VERTICAL
<b>GFSK Tx mode 2441MHz</b>									
4060.00	34.85	33.45	29.05	7.67	46.92	74.00	-27.08	Peak	HORIZONTAL
6406.00	33.76	35.65	29.66	9.88	49.63	74.00	-24.37	Peak	HORIZONTAL
8004.00	34.39	36.69	31.13	11.13	51.08	74.00	-22.92	Peak	HORIZONTAL
8701.00	33.63	36.20	32.04	11.71	49.50	74.00	-24.50	Peak	HORIZONTAL
10911.00	32.07	37.56	33.74	13.37	49.26	74.00	-24.74	Peak	HORIZONTAL
12849.00	33.55	38.65	35.61	14.66	51.25	74.00	-22.75	Peak	HORIZONTAL
4825.00	33.83	33.73	29.32	8.50	46.74	74.00	-27.26	Peak	VERTICAL
6984.00	34.55	36.19	30.38	10.40	50.76	74.00	-23.24	Peak	VERTICAL
7970.00	34.17	36.69	31.12	11.12	50.86	74.00	-23.14	Peak	VERTICAL
8820.00	32.89	36.72	32.18	11.75	49.18	74.00	-24.82	Peak	VERTICAL
10724.00	32.41	37.04	33.51	13.05	48.99	74.00	-25.01	Peak	VERTICAL
12679.00	33.94	38.48	35.48	14.65	51.59	74.00	-22.41	Peak	VERTICAL
<b>GFSK Tx mode 2480MHz</b>									
4451.00	33.56	33.76	29.19	8.10	46.23	74.00	-27.77	Peak	HORIZONTAL
5760.00	32.44	34.86	29.21	9.43	47.52	74.00	-26.48	Peak	HORIZONTAL
7341.00	35.14	36.48	30.59	10.72	51.75	74.00	-22.25	Peak	HORIZONTAL
7919.00	33.10	36.68	31.10	11.09	49.77	74.00	-24.23	Peak	HORIZONTAL
10639.00	34.02	36.80	33.43	12.94	50.33	74.00	-23.67	Peak	HORIZONTAL
13104.00	33.40	38.91	35.64	14.70	51.37	74.00	-22.63	Peak	HORIZONTAL
4009.00	34.88	33.41	29.04	7.61	46.86	74.00	-27.14	Peak	VERTICAL
5794.00	33.01	34.88	29.21	9.48	48.16	74.00	-25.84	Peak	VERTICAL
7239.00	34.14	36.39	30.52	10.65	50.66	74.00	-23.34	Peak	VERTICAL
7970.00	34.21	36.69	31.12	11.12	50.90	74.00	-23.10	Peak	VERTICAL
10469.00	32.96	36.43	33.25	12.69	48.83	74.00	-25.17	Peak	VERTICAL
12050.00	32.61	37.67	34.82	14.26	49.72	74.00	-24.28	Peak	VERTICAL
<b>Result: Pass</b>									

Note: 1.30MHz~25GHz: (Scan with GFSK,  $\pi/4$  QPSK, 8-DPSK, the worst case is GFSK Mode)

2. Result Level = Read Level + Antenna Factor + Cable loss - PRM Factor.

3: For emissions above 1GHz. If peak results comply with AV limit, AV Result is deemed to comply with AV limit.

## 11. Band Edge Compliance (radiated method)

### 11.1. Block diagram of test setup

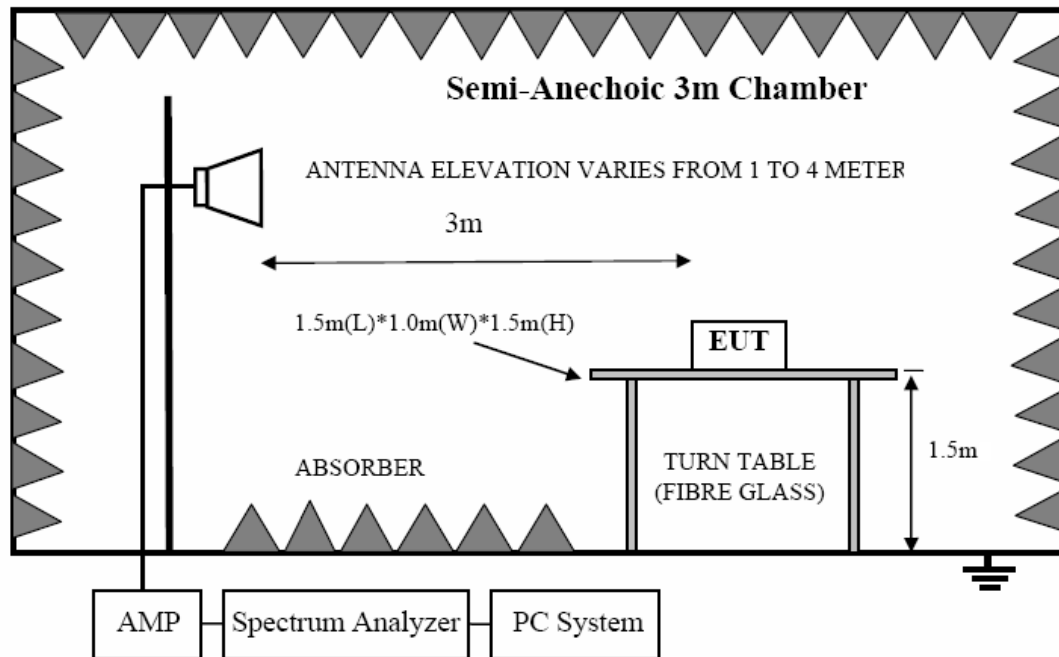

### 11.2. Limit

All restriction band should comply with 15.209, other emission should be at least 20dB below the fundamental.

### 11.3. Test Procedure

Same with clause 10.3 except change investigated frequency range from 2310MHz to 2415MHz and 2475MHz to 2500MHz.

Remark: All restriction band have been tested, and only the worse case is shown in report.

### 11.4. Test result

**PASS. (See below detailed test result)**

Remark: hopping on and hopping off mode all have been test, hopping off mode is worst and reported only.

# TR-4-E-009 Radiated Emission Test Result

**Test Site** : DDT 3m Chamber 1# D:\2017 RE1# Report Data\Q17101804-1E\FCC 1-18G.EM6  
**Test Date** : 2017-10-23 **Tested By** : Bobo  
**EUT** : PORTABLE BLUETOOTH SPEAKER **Model Number** : GO2H  
**Power Supply** : Battery **Test Mode** : TX mode 2402  
**Condition** : Temp:24.5°C,Humi:55%,  
 Press:100.1kPa **Antenna/Distance** : 2016 HF907/3m/VERTICAL  
**Memo** : GFSK

Data: 3

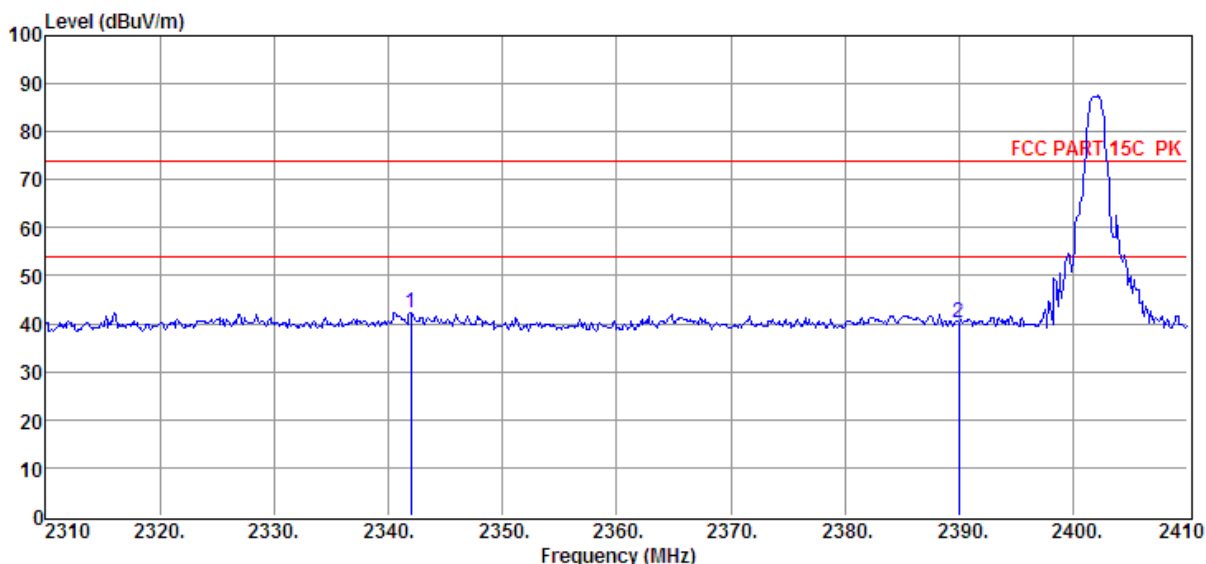

Item (Mark)	Freq. (MHz)	Read Level (dBμV)	Antenna Factor (dB/m)	PRM Factor (dB)	Cable Loss (dB)	Result Level (dBμV/m)	Limit Line (dBμV/m)	Over Limit (dB)	Detector	Polarization
1	2342.00	36.16	29.59	29.32	5.96	42.39	74.00	-31.61	Peak	VERTICAL
2	2390.00	33.96	29.78	29.42	6.03	40.35	74.00	-33.65	Peak	VERTICAL

- Note: 1. Result Level = Read Level + Antenna Factor + Cable loss - PRM Factor.  
 2. If Peak Result complies with AV limit, AV Result is deemed to comply with AV limit.  
 3. Test setup: RBW: 1 MHz, VBW: 3 MHz, Sweep time: auto.

# TR-4-E-009 Radiated Emission Test Result

**Test Site** : DDT 3m Chamber 1# D:\2017 RE1# Report Data\Q17101804-1E\FCC 1-18G.EM6  
**Test Date** : 2017-10-23 **Tested By** : Bobo  
**EUT** : PORTABLE BLUETOOTH SPEAKER **Model Number** : GO2H  
**Power Supply** : Battery **Test Mode** : TX mode 2402  
**Condition** : Temp:24.5°C,Humi:55%,  
Press:100.1kPa **Antenna/Distance** : 2016 HF907/3m/HORIZONTAL  
**Memo** : GFSK

Data: 4

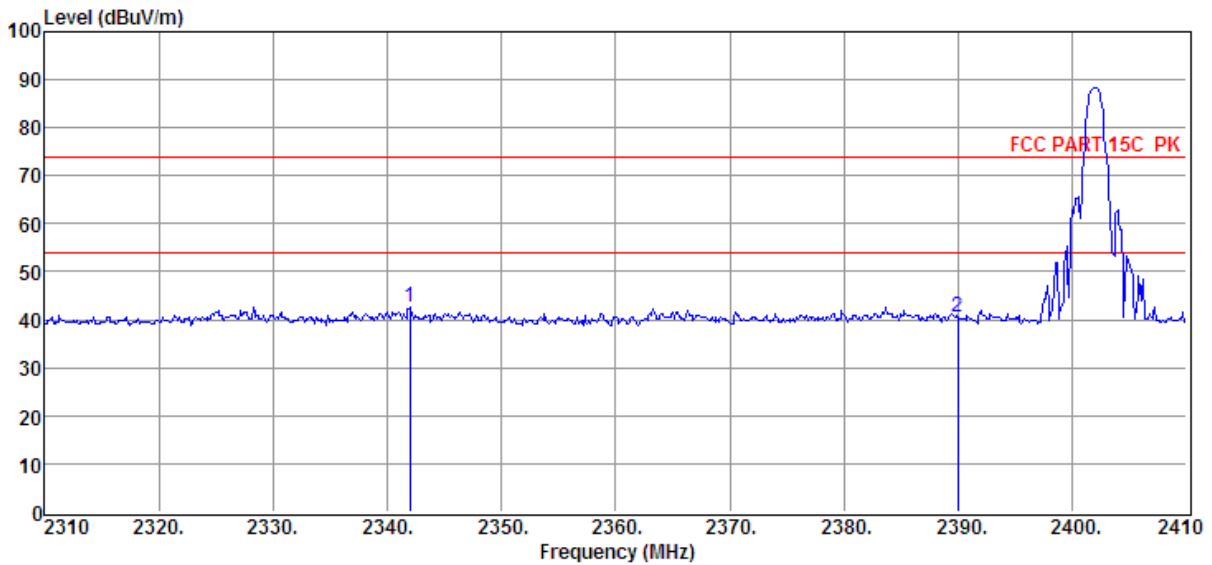

Item (Mark)	Freq. (MHz)	Read Level (dBμV)	Antenna Factor (dB/m)	PRM Factor (dB)	Cable Loss (dB)	Result Level (dBμV/m)	Limit Line (dBμV/m)	Over Limit (dB)	Detector	Polarization
1	2342.00	36.35	29.59	29.32	5.96	42.58	74.00	-31.42	Peak	HORIZONTAL
2	2390.00	34.11	29.78	29.42	6.03	40.50	74.00	-33.50	Peak	HORIZONTAL

- Note: 1. Result Level = Read Level + Antenna Factor + Cable loss - PRM Factor.  
 2. If Peak Result complies with AV limit, AV Result is deemed to comply with AV limit.  
 3. Test setup: RBW: 1 MHz, VBW: 3 MHz, Sweep time: auto.

# TR-4-E-009 Radiated Emission Test Result

**Test Site** : DDT 3m Chamber 1# D:\2017 RE1# Report Data\Q17101804-1E\FCC 1-18G.EM6  
**Test Date** : 2017-10-23 **Tested By** : Bobo  
**EUT** : PORTABLE BLUETOOTH SPEAKER **Model Number** : GO2H  
**Power Supply** : Battery **Test Mode** : TX mode 2480  
**Condition** : Temp:24.5°C,Humi:55%,  
Press:100.1kPa **Antenna/Distance** : 2016 HF907/3m/VERTICAL  
**Memo** : GFSK

Data: 9

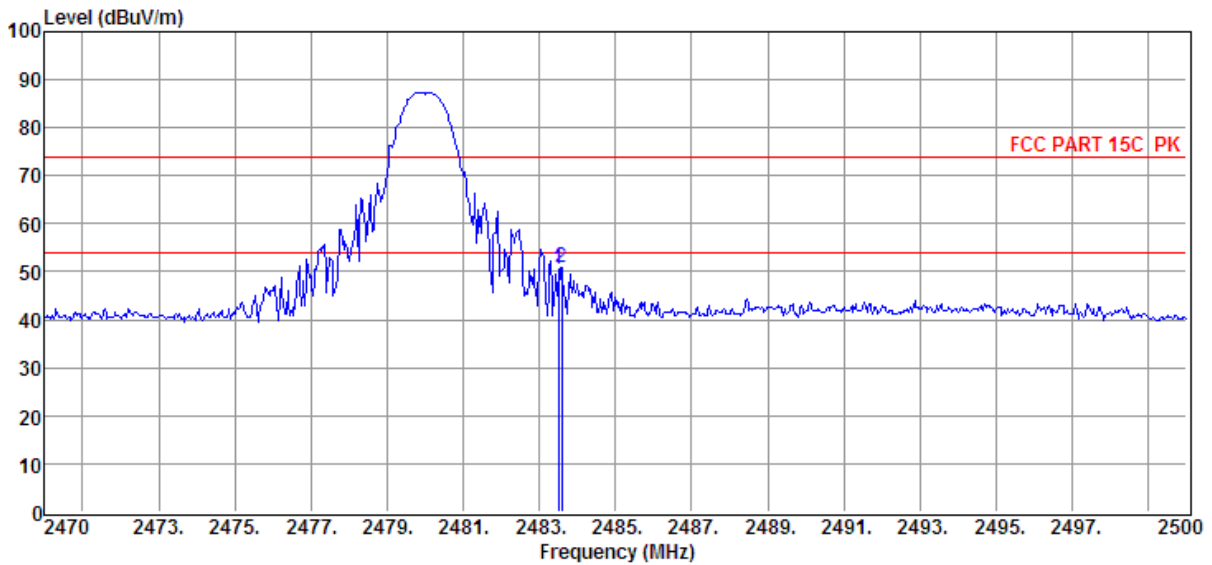

Item (Mark)	Freq. (MHz)	Read Level (dBμV)	Antenna Factor (dB/m)	PRM Factor (dB)	Cable Loss (dB)	Result Level (dBμV/m)	Limit Line (dBμV/m)	Over Limit (dB)	Detector	Polarization
1	2483.50	44.01	30.14	29.71	6.13	50.57	74.00	-23.43	Peak	VERTICAL
2	2483.59	44.23	30.14	29.71	6.13	50.79	74.00	-23.21	Peak	VERTICAL

- Note: 1. Result Level = Read Level + Antenna Factor + Cable loss - PRM Factor.  
 2. If Peak Result complies with AV limit, AV Result is deemed to comply with AV limit.  
 3. Test setup: RBW: 1 MHz, VBW: 3 MHz, Sweep time: auto.

# TR-4-E-009 Radiated Emission Test Result

**Test Site** : DDT 3m Chamber 1# **D:\2017 RE1# Report Data\Q17101804-1E\FCC 1-18G.EM6**  
**Test Date** : 2017-10-23 **Tested By** : Bobo  
**EUT** : PORTABLE BLUETOOTH SPEAKER **Model Number** : GO2H  
**Power Supply** : Battery **Test Mode** : TX mode 2480  
**Condition** : Temp:24.5°C,Humi:55%,  
Press:100.1kPa **Antenna/Distance** : 2016 HF907/3m/HORIZONTAL  
**Memo** : GFSK

Data: 10

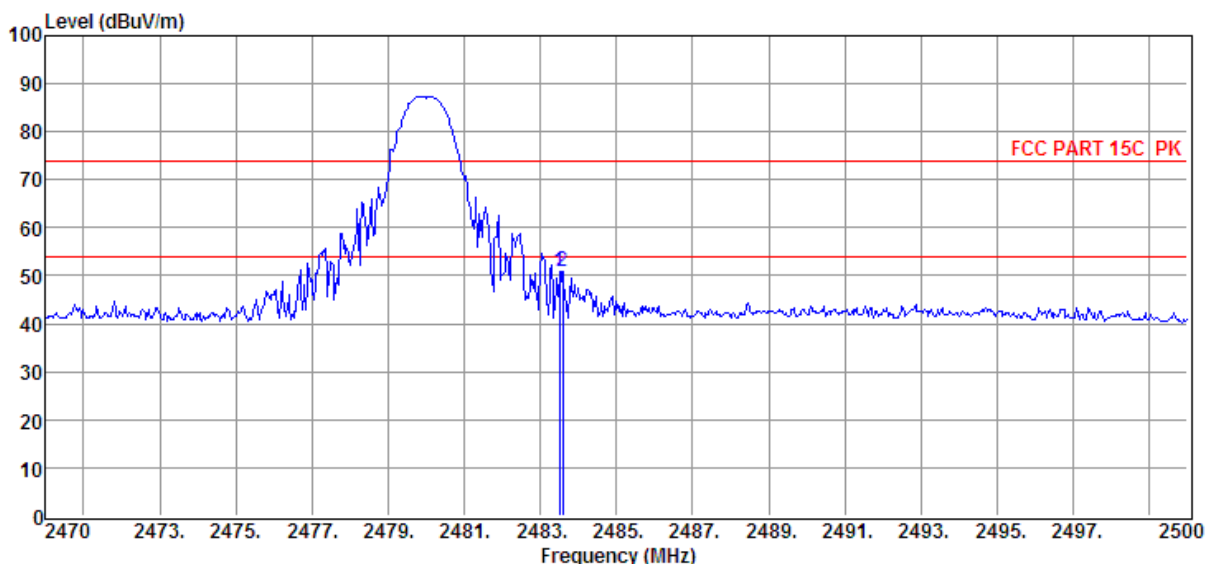

Item (Mark)	Freq. (MHz)	Read Level (dBμV)	Antenna Factor (dB/m)	PRM Factor (dB)	Cable Loss (dB)	Result Level (dBμV/m)	Limit Line (dBμV/m)	Over Limit (dB)	Detector	Polarization
1	2483.50	44.34	30.14	29.71	6.13	50.90	74.00	-23.10	Peak	HORIZONTAL
2	2483.59	44.23	30.14	29.71	6.13	50.79	74.00	-23.21	Peak	HORIZONTAL

- Note: 1. Result Level = Read Level + Antenna Factor + Cable loss - PRM Factor.  
 2. If Peak Result complies with AV limit, AV Result is deemed to comply with AV limit.  
 3. Test setup: RBW: 1 MHz, VBW: 3 MHz, Sweep time: auto.

# TR-4-E-009 Radiated Emission Test Result

**Test Site** : DDT 3m Chamber 1# D:\2017 RE1# Report Data\Q17101804-1E\FCC 1-18G.EM6  
**Test Date** : 2017-10-23 **Tested By** : Bobo  
**EUT** : PORTABLE BLUETOOTH SPEAKER **Model Number** : GO2H  
**Power Supply** : Battery **Test Mode** : TX mode 2480  
**Condition** : Temp:24.5°C,Humi:55%,  
**Antenna/Distance** : 2016 HF907/3m/VERTICAL  
 Press:100.1kPa  
**Memo** : 8-DPSK

Data: 13

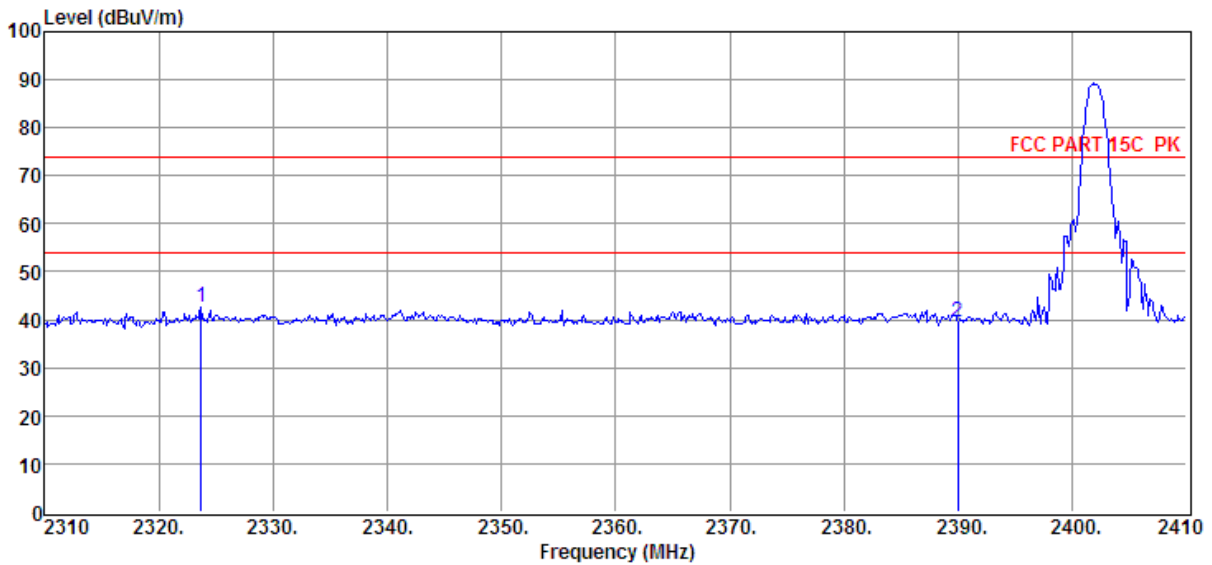

Item (Mark)	Freq. (MHz)	Read Level (dBμV)	Antenna Factor (dB/m)	PRM Facto r dB	Cable Loss dB	Result Level (dBμV/m)	Limit Line (dBμV/m)	Over Limit (dB)	Detecto r	Polarization
1	2323.70	36.36	29.51	29.30	5.94	42.51	74.00	-31.49	Peak	VERTICAL
2	2390.00	33.23	29.78	29.42	6.03	39.62	74.00	-34.38	Peak	VERTICAL

- Note: 1. Result Level = Read Level + Antenna Factor + Cable loss - PRM Factor.  
 2. If Peak Result complies with AV limit, AV Result is deemed to comply with AV limit.  
 3. Test setup: RBW: 1 MHz, VBW: 3 MHz, Sweep time: auto.

# TR-4-E-009 Radiated Emission Test Result

**Test Site** : DDT 3m Chamber 1# D:\2017 RE1# Report Data\Q17101804-1E\FCC 1-18G.EM6  
**Test Date** : 2017-10-23 **Tested By** : Bobo  
**EUT** : PORTABLE BLUETOOTH SPEAKER **Model Number** : GO2H  
**Power Supply** : Battery **Test Mode** : TX mode 2480  
**Condition** : Temp:24.5°C,Humi:55%,  
**Antenna/Distance** : 2016 HF907/3m/HORIZONTAL  
Press:100.1kPa  
**Memo** : 8-DPSK

Data: 14

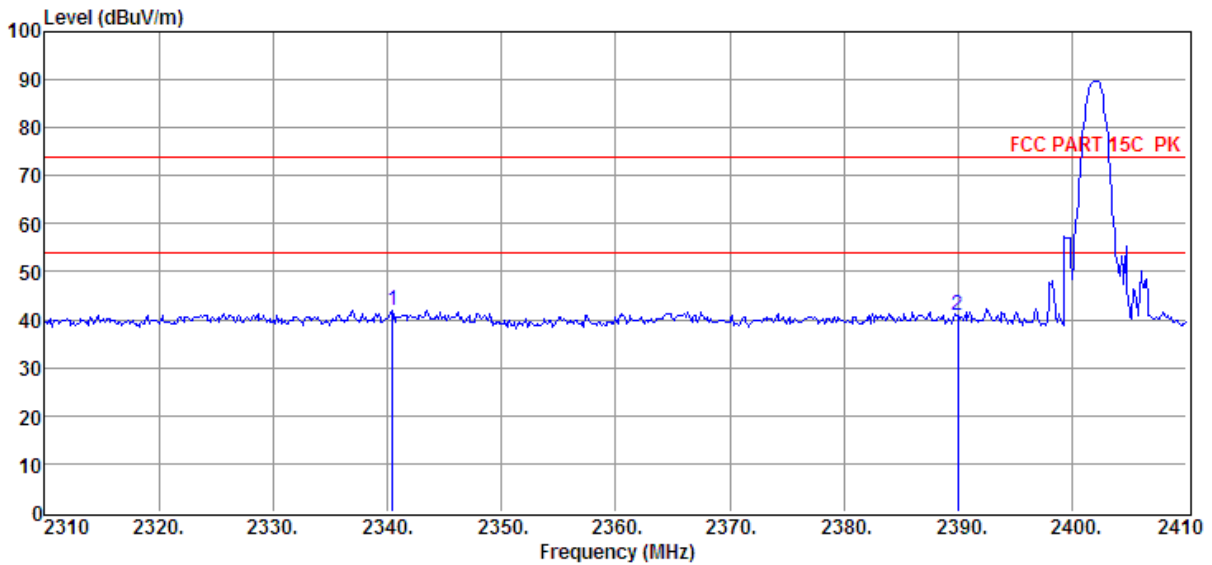

Item (Mark)	Freq. (MHz)	Read Level (dBμV)	Antenna Factor (dB/m)	PRM Factor (dB)	Cable Loss (dB)	Result Level (dBμV/m)	Limit Line (dBμV/m)	Over Limit (dB)	Detector	Polarization
1	2340.50	35.86	29.58	29.32	5.96	42.08	74.00	-31.92	Peak	HORIZONTAL
2	2390.00	34.46	29.78	29.42	6.03	40.85	74.00	-33.15	Peak	HORIZONTAL

- Note: 1. Result Level = Read Level + Antenna Factor + Cable loss - PRM Factor.  
 2. If Peak Result complies with AV limit, AV Result is deemed to comply with AV limit.  
 3. Test setup: RBW: 1 MHz, VBW: 3 MHz, Sweep time: auto.

# TR-4-E-009 Radiated Emission Test Result

**Test Site** : DDT 3m Chamber 1# D:\2017 RE1# Report Data\Q17101804-1E\FCC 1-18G.EM6  
**Test Date** : 2017-10-23 **Tested By** : Bobo  
**EUT** : PORTABLE BLUETOOTH SPEAKER **Model Number** : GO2H  
**Power Supply** : Battery **Test Mode** : TX mode 2480  
**Condition** : Temp:24.5°C,Humi:55%,  
**Antenna/Distance** : 2016 HF907/3m/VERTICAL  
Press:100.1kPa  
**Memo** : 8-DPSK

Data: 19

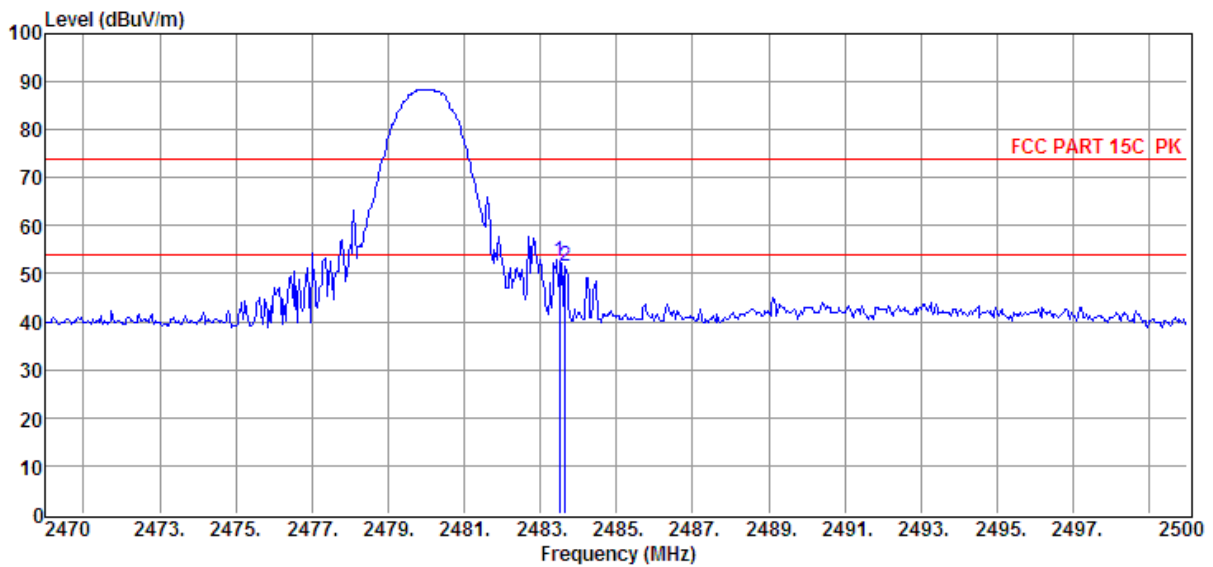

Item (Mark)	Freq. (MHz)	Read Level (dBμV)	Antenna Factor (dB/m)	PRM Factor (dB)	Cable Loss (dB)	Result Level (dBμV/m)	Limit Line (dBμV/m)	Over Limit (dB)	Detector	Polarization
1	2483.50	46.03	30.14	29.71	6.13	52.59	74.00	-21.41	Peak	VERTICAL
2	2483.65	44.99	30.14	29.71	6.13	51.55	74.00	-22.45	Peak	VERTICAL

- Note: 1. Result Level = Read Level + Antenna Factor + Cable loss - PRM Factor.  
 2. If Peak Result complies with AV limit, AV Result is deemed to comply with AV limit.  
 3. Test setup: RBW: 1 MHz, VBW: 3 MHz, Sweep time: auto.

# TR-4-E-009 Radiated Emission Test Result

**Test Site** : DDT 3m Chamber 1# D:\2017 RE1# Report Data\Q17101804-1E\FCC 1-18G.EM6  
**Test Date** : 2017-10-23 **Tested By** : Bobo  
**EUT** : PORTABLE BLUETOOTH SPEAKER **Model Number** : GO2H  
**Power Supply** : Battery **Test Mode** : TX mode 2480  
**Condition** : Temp:24.5°C,Humi:55%,  
 Press:100.1kPa **Antenna/Distance** : 2016 HF907/3m/HORIZONTAL  
**Memo** : 8-DPSK

Data: 20

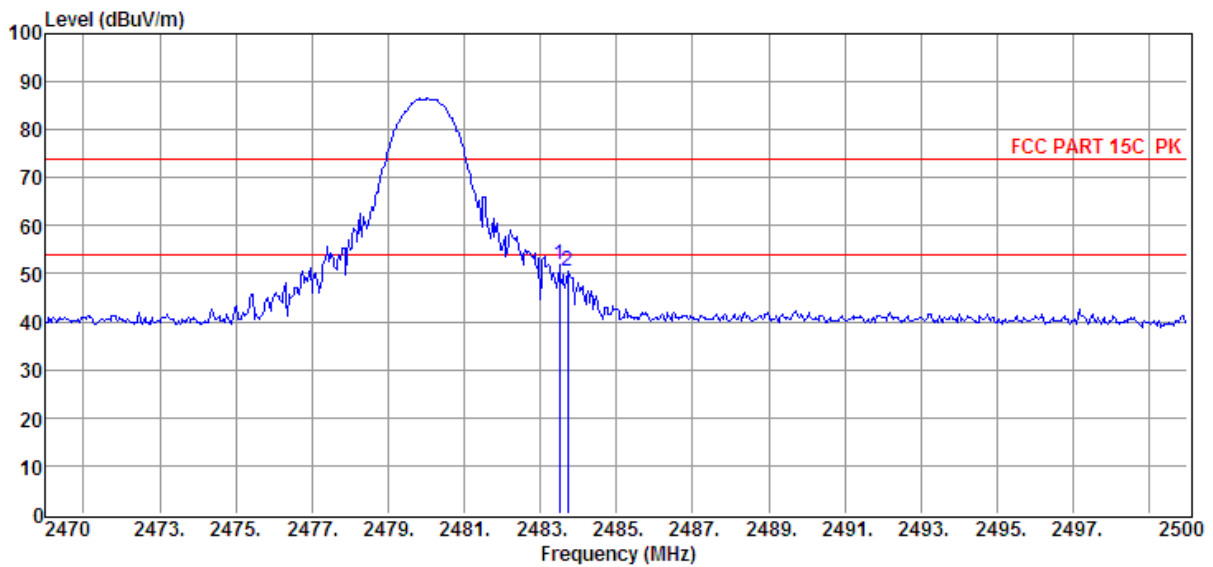

Item (Mark)	Freq. (MHz)	Read Level (dBμV)	Antenna Factor (dB/m)	PRM Factor (dB)	Cable Loss (dB)	Result Level (dBμV/m)	Limit Line (dBμV/m)	Over Limit (dB)	Detector	Polarization
1	2483.50	45.34	30.14	29.71	6.13	51.90	74.00	-22.10	Peak	HORIZONTAL
2	2483.71	44.04	30.14	29.71	6.13	50.60	74.00	-23.40	Peak	HORIZONTAL

- Note: 1. Result Level = Read Level + Antenna Factor + Cable loss - PRM Factor.  
 2. If Peak Result complies with AV limit, AV Result is deemed to comply with AV limit.  
 3. Test setup: RBW: 1 MHz, VBW: 3 MHz, Sweep time: auto.

## 12. Power Line Conducted Emission

### 12.1. Block diagram of test setup

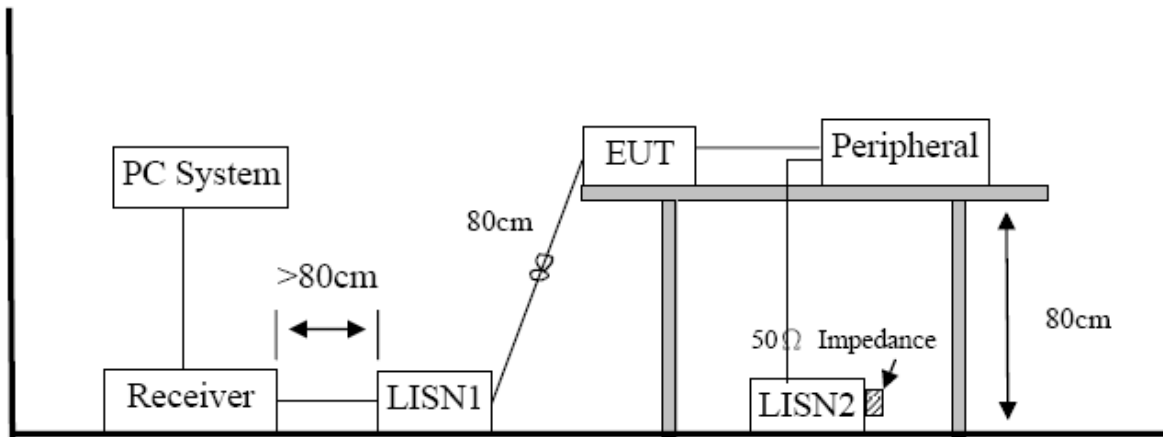

### 12.2. Power Line Conducted Emission Limits

Frequency	Quasi-Peak Level dB( $\mu$ V)	Average Level dB( $\mu$ V)
150kHz ~ 500kHz	66 ~ 56*	56 ~ 46*
500kHz ~ 5MHz	56	46
5MHz ~ 30MHz	60	50

Note 1: \* Decreasing linearly with logarithm of frequency.

Note 2: The lower limit shall apply at the transition frequencies.

### 12.3. Test Procedure

The EUT and Support equipment, if needed, were put placed on a non-metallic table, 80cm above the ground plane.

Configuration EUT to simulate typical usage as described in clause 2.4 and test equipment as described in clause 10.2 of this report.

All I/O cables were positioned to simulate typical actual usage as per ANSI C63.10.

All support equipment power received from a second LISN.

Emissions were measured on each current carrying line of the EUT using an EMI Test Receiver connected to the LISN powering the EUT.

The Receiver scanned from 150 kHz to 30MHz for emissions in each of the test modes.

During the above scans, the emissions were maximized by cable manipulation.

The test mode(s) described in clause 2.4 were scanned during the preliminary test.

After the preliminary scan, we found the test mode producing the highest emission level.

The EUT configuration and worse cable configuration of the above highest emission levels were

recorded for reference of the final test.

EUT and support equipment were set up on the test bench as per the configuration with highest emission level in the preliminary test.

A scan was taken on both power lines, Neutral and Line, recording at least the six highest emissions.

Emission frequency and amplitude were recorded into a computer in which correction factors were used to calculate the emission level and compare reading to the applicable limit.

The test data of the worst-case condition(s) was recorded.

The bandwidth of test receiver is set at 9 KHz.

#### **12.4. Test Result**

##### **PASS. (See below detailed test result)**

Note1: All emissions not reported below are too low against the prescribed limits.

Note2: "-----" means Peak detection; "-----" means Average detection

Note3: Pre-test AC conducted emission at both voltage AC 120V/60Hz and AC 240V/50Hz, recorded worst case (AC 120V/60Hz).

# TR-4-E-010 Conducted Emission Test Result

**Test Site** : DDT 1# Shield Room E:\2017 CE report data\Q17101804-1E\CE.EM6  
**Test Date** : 2017-10-23 **Tested By** : Lewis  
**EUT** : PORTABLE BLUETOOTH SPEAKER **Model Number** : GO2H  
**Power Supply** : AC 120V/60Hz **Test Mode** : TX mode  
**Condition** : Temp:24.5°C,Humi:55%,  
 : Press:100.1kPa **LISN** : 2016 ENV216/LINE  
**Memo** : Battery model: GO2/MLP284154

Data: 10

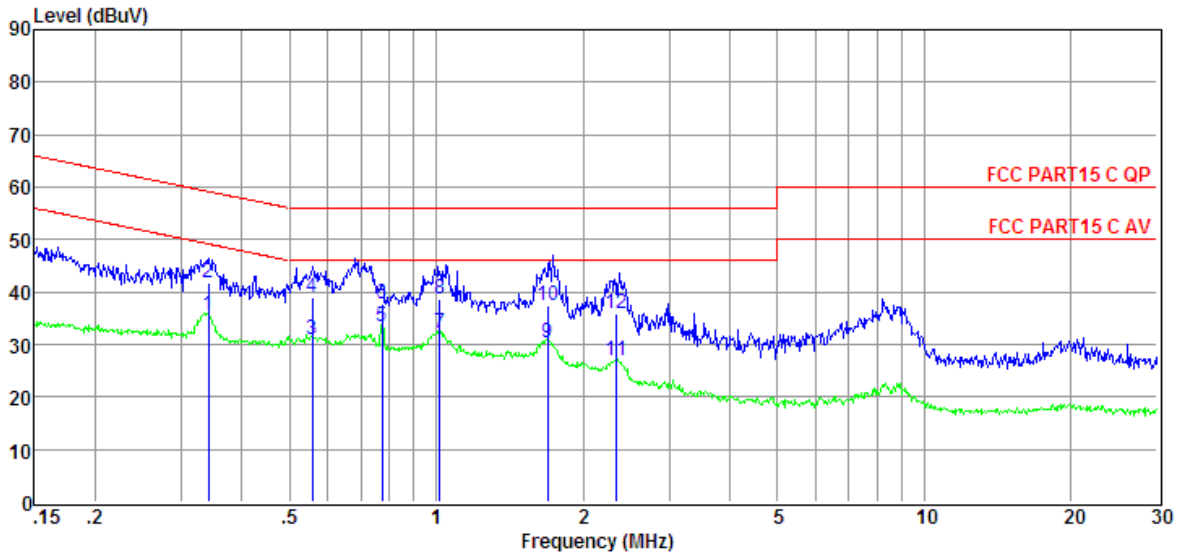

Item	Freq.	Read Level	LISN Factor	Cable Loss	Pulse Limiter Factor	Result Level	Limit Line	Over Limit	Detector	Phase
(Mark)	(MHz)	(dBμV)	(dB)	(dB)	(dB)	(dBμV)	(dBμV)	(dB)		
1	0.34	16.19	9.61	0.02	9.86	35.68	49.18	-13.50	Average	LINE
2	0.34	22.13	9.61	0.02	9.86	41.62	59.18	-17.56	QP	LINE
3	0.56	11.33	9.61	0.03	9.86	30.83	46.00	-15.17	Average	LINE
4	0.56	19.56	9.61	0.03	9.86	39.06	56.00	-16.94	QP	LINE
5	0.78	13.77	9.61	0.03	9.86	33.27	46.00	-12.73	Average	LINE
6	0.78	18.14	9.61	0.03	9.86	37.64	56.00	-18.36	QP	LINE
7	1.02	12.69	9.61	0.03	9.86	32.19	46.00	-13.81	Average	LINE
8	1.02	19.03	9.61	0.03	9.86	38.53	56.00	-17.47	QP	LINE
9	1.69	10.70	9.62	0.04	9.86	30.22	46.00	-15.78	Average	LINE
10	1.69	18.02	9.62	0.04	9.86	37.54	56.00	-18.46	QP	LINE
11	2.35	7.27	9.64	0.04	9.87	26.82	46.00	-19.18	Average	LINE
12	2.35	16.36	9.64	0.04	9.87	35.91	56.00	-20.09	QP	LINE

- Note: 1. Result Level = Read Level + LISN Factor + Pulse Limiter Factor + Cable loss.  
 2. If QP Result complies with AV limit, AV Result is deemed to comply with AV limit.  
 3. Test setup: RBW: 200 Hz (9 kHz—150 kHz), 9 kHz (150 kHz—30 MHz).  
 4. Step size: 80Hz (0.009MHz-0.15MHz), 4 kHz (0.15MHz-30MHz), Scan time: auto.

# TR-4-E-010 Conducted Emission Test Result

**Test Site** : DDT 1# Shield Room E:\2017 CE report data\Q17101804-1E\CE.EM6  
**Test Date** : 2017-10-23 **Tested By** : Lewis  
**EUT** : PORTABLE BLUETOOTH SPEAKER **Model Number** : GO2H  
**Power Supply** : AC 120V/60Hz **Test Mode** : TX mode  
**Condition** : Temp:24.5°C,Humi:55%,  
**LISN** : 2016 ENV216/NEUTRAL  
Press:100.1kPa  
**Memo** : Battery model: GO2/MLP284154

Data: 12

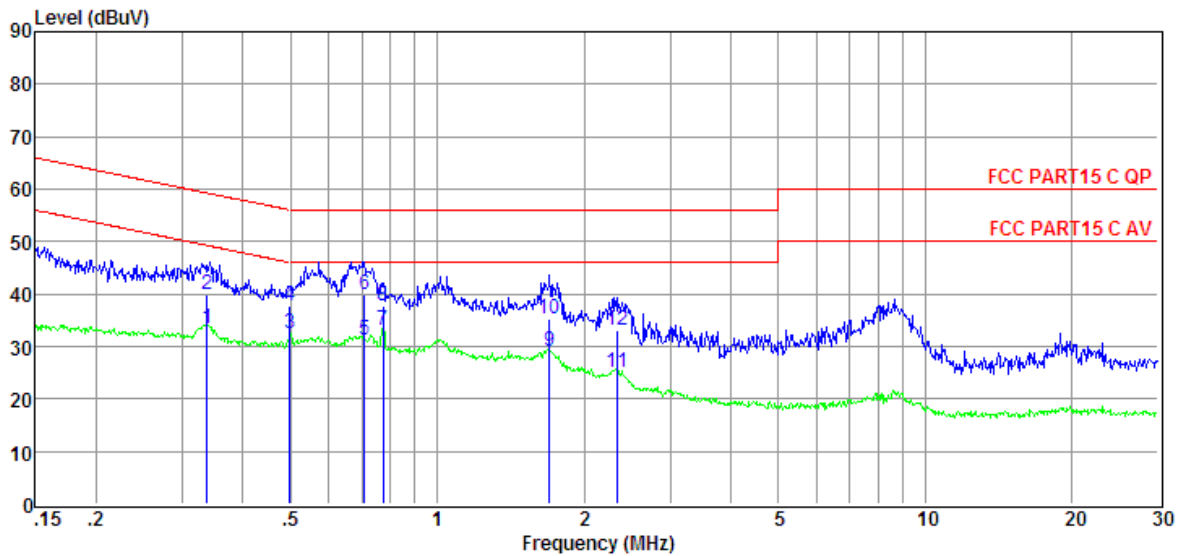

Item	Freq.	Read Level	LISN Factor	Cable Loss	Pulse Limiter Factor	Result Level	Limit Line	Over Limit	Detector	Phase
(Mark)	(MHz)	(dBμV)	(dB)	(dB)	(dB)	(dBμV)	(dBμV)	(dB)		
1	0.34	14.05	9.61	0.02	9.86	33.54	49.27	-15.73	Average	NEUTRAL
2	0.34	20.41	9.61	0.02	9.86	39.90	59.27	-19.37	QP	NEUTRAL
3	0.50	13.05	9.61	0.02	9.86	32.54	46.01	-13.47	Average	NEUTRAL
4	0.50	18.32	9.61	0.02	9.86	37.81	56.01	-18.20	QP	NEUTRAL
5	0.71	11.60	9.61	0.03	9.86	31.10	46.00	-14.90	Average	NEUTRAL
6	0.71	20.45	9.61	0.03	9.86	39.95	56.00	-16.05	QP	NEUTRAL
7	0.78	13.52	9.61	0.03	9.86	33.02	46.00	-12.98	Average	NEUTRAL
8	0.78	18.13	9.61	0.03	9.86	37.63	56.00	-18.37	QP	NEUTRAL
9	1.70	9.40	9.62	0.04	9.86	28.92	46.00	-17.08	Average	NEUTRAL
10	1.70	15.75	9.62	0.04	9.86	35.27	56.00	-20.73	QP	NEUTRAL
11	2.35	5.58	9.63	0.04	9.87	25.12	46.00	-20.88	Average	NEUTRAL
12	2.35	13.54	9.63	0.04	9.87	33.08	56.00	-22.92	QP	NEUTRAL

Note: 1. Result Level = Read Level + LISN Factor + Pulse Limiter Factor + Cable loss.

2. If QP Result complies with AV limit, AV Result is deemed to comply with AV limit.

3. Test setup: RBW: 200 Hz (9 kHz—150 kHz), 9 kHz (150 kHz—30 MHz).

4. Step size: 80Hz (0.009MHz-0.15MHz), 4 kHz (0.15MHz-30MHz), Scan time: auto.

# TR-4-E-010 Conducted Emission Test Result

**Test Site** : DDT 1# Shield Room D:\2020 CE report data\Q20030310-1E\20200305 CE.EM6  
**Test Date** : 2017-10-23 **Tested By** : Lewis  
**EUT** : PORTABLE BLUETOOTH SPEAKER **Model Number** : GO2H  
**Power Supply** : AC 120V/60Hz **Test Mode** : TX mode  
**Condition** : Temp:24.5°C, Humi:55.5%,  
 : Press:100.1kPa **LISN** : 2019 ENV216 1#/LINE  
**Memo** : Battery model: L0707-LF

Data: 18

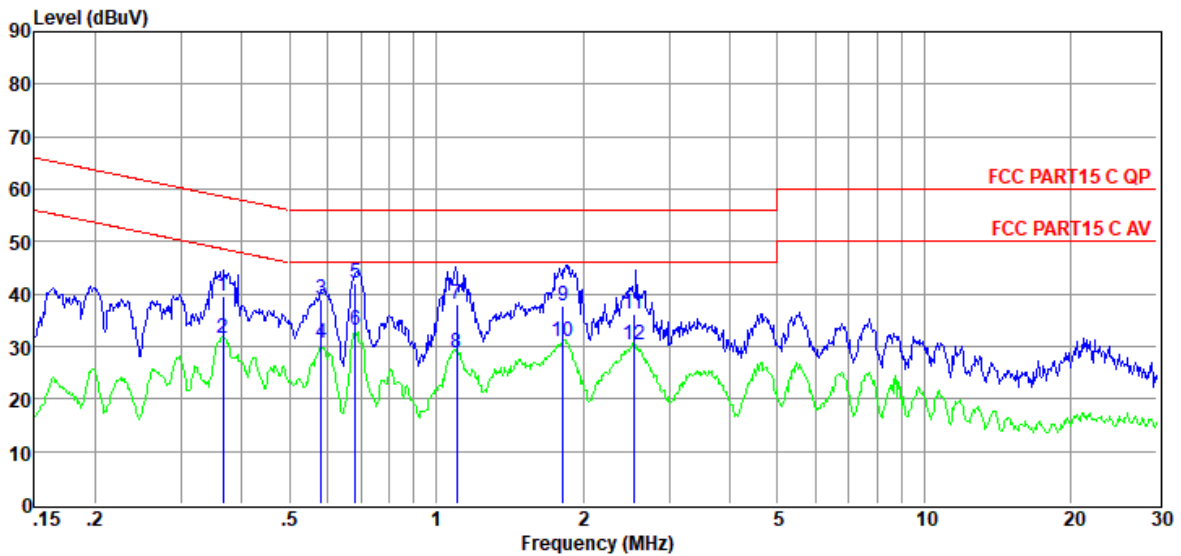

Item	Freq.	Read Level	LISN Factor	Cable Loss	Pulse Limiter Factor	Result Level	Limit Line	Over Limit	Detector	Phase
(Mark)	(MHz)	(dBμV)	(dB)	(dB)	(dB)	(dBμV)	(dBμV)	(dB)		
1	0.37	20.23	9.60	0.02	9.86	39.71	58.61	-18.90	QP	LINE
2	0.37	12.07	9.60	0.02	9.86	31.55	48.61	-17.06	Average	LINE
3	0.58	19.51	9.60	0.03	9.86	39.00	56.00	-17.00	QP	LINE
4	0.58	11.15	9.60	0.03	9.86	30.64	46.00	-15.36	Average	LINE
5	0.68	22.60	9.60	0.03	9.86	42.09	56.00	-13.91	QP	LINE
6	0.68	13.45	9.60	0.03	9.86	32.94	46.00	-13.06	Average	LINE
7	1.10	18.46	9.60	0.03	9.86	37.95	56.00	-18.05	QP	LINE
8	1.10	9.43	9.60	0.03	9.86	28.92	46.00	-17.08	Average	LINE
9	1.82	18.31	9.60	0.05	9.86	37.82	56.00	-18.18	QP	LINE
10	1.82	11.34	9.60	0.05	9.86	30.85	46.00	-15.15	Average	LINE
11	2.54	16.78	9.60	0.06	9.86	36.30	56.00	-19.70	QP	LINE
12	2.54	10.78	9.60	0.06	9.86	30.30	46.00	-15.70	Average	LINE

- Note: 1. Result Level = Read Level + LISN Factor + Pulse Limiter Factor + Cable loss.  
 2. If QP Result complies with AV limit, AV Result is deemed to comply with AV limit.  
 3. Test setup: RBW: 200 Hz (9 kHz—150 kHz), 9 kHz (150 kHz—30 MHz).  
 4. Step size: 80Hz (0.009MHz-0.15MHz), 4 kHz (0.15MHz-30MHz), Scan time: auto.

# TR-4-E-010 Conducted Emission Test Result

**Test Site** : DDT 1# Shield Room D:\2020 CE report data\Q20030310-1E\20200305 CE.EM6  
**Test Date** : 2017-10-23 **Tested By** : Lewis  
**EUT** : PORTABLE BLUETOOTH SPEAKER **Model Number** : GO2H  
**Power Supply** : AC 120V/60Hz **Test Mode** : TX mode  
**Condition** : Temp:24.5°C, Humi:55.5%,  
 : Press:100.1kPa **LISN** : 2019 ENV216 1#/NEUTRAL  
**Memo** : Battery model: L0707-LF

Data: 20

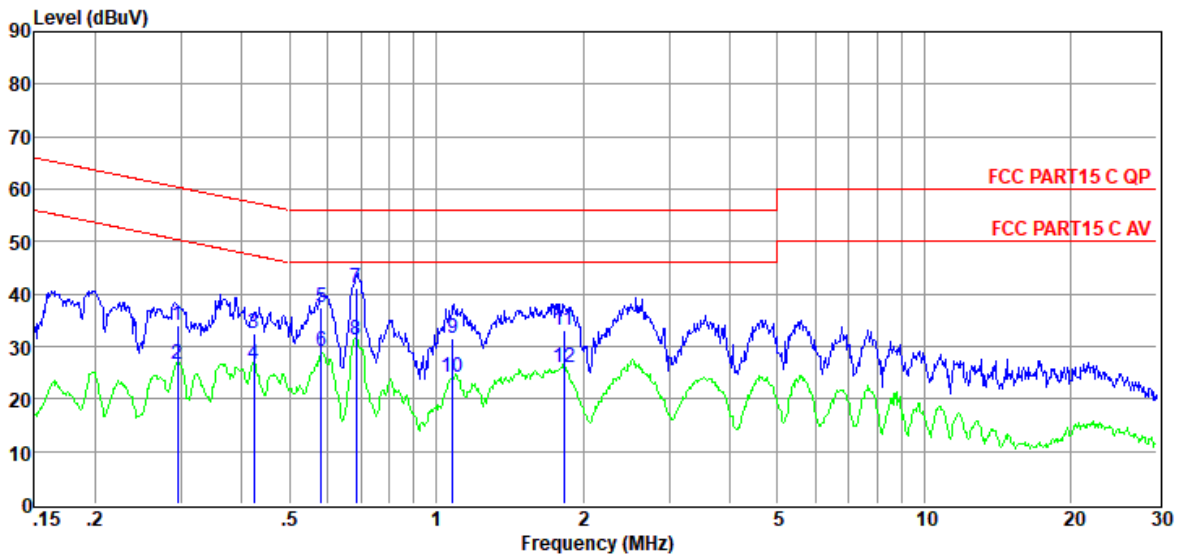

Item	Freq.	Read Level	LISN Factor	Cable Loss	Pulse Limiter Factor	Result Level	Limit Line	Over Limit	Detector	Phase
(Mark)	(MHz)	(dBμV)	(dB)	(dB)	(dB)	(dBμV)	(dBμV)	(dB)		
1	0.30	14.65	9.60	0.02	9.86	34.13	60.37	-26.24	QP	NEUTRAL
2	0.30	7.22	9.60	0.02	9.86	26.70	50.37	-23.67	Average	NEUTRAL
3	0.42	12.94	9.60	0.02	9.86	32.42	57.37	-24.95	QP	NEUTRAL
4	0.42	7.00	9.60	0.02	9.86	26.48	47.37	-20.89	Average	NEUTRAL
5	0.58	18.00	9.60	0.03	9.86	37.49	56.00	-18.51	QP	NEUTRAL
6	0.58	9.57	9.60	0.03	9.86	29.06	46.00	-16.94	Average	NEUTRAL
7	0.69	21.51	9.60	0.03	9.86	41.00	56.00	-15.00	QP	NEUTRAL
8	0.69	11.81	9.60	0.03	9.86	31.30	46.00	-14.70	Average	NEUTRAL
9	1.08	12.00	9.60	0.03	9.86	31.49	56.00	-24.51	QP	NEUTRAL
10	1.08	4.49	9.60	0.03	9.86	23.98	46.00	-22.02	Average	NEUTRAL
11	1.83	13.71	9.60	0.05	9.86	33.22	56.00	-22.78	QP	NEUTRAL
12	1.83	6.44	9.60	0.05	9.86	25.95	46.00	-20.05	Average	NEUTRAL

- Note: 1. Result Level = Read Level + LISN Factor + Pulse Limiter Factor + Cable loss.  
 2. If QP Result complies with AV limit, AV Result is deemed to comply with AV limit.  
 3. Test setup: RBW: 200 Hz (9 kHz—150 kHz), 9 kHz (150 kHz—30 MHz).  
 4. Step size: 80Hz (0.009MHz-0.15MHz), 4 kHz (0.15MHz-30MHz), Scan time: auto.

# TR-4-E-010 Conducted Emission Test Result

**Test Site** : DDT 1# Shield Room D:\2018 CE report data\Q18041203-1E\CE.EM6  
**Test Date** : 2018-04-14 **Tested By** : Jerry  
**EUT** : PORTABLE BLUETOOTH SPEAKER **Model Number** : GO2H  
**Power Supply** : AC 120V/60Hz **Test Mode** : Tx mode  
**Condition** : Temp:24.5°C,Humi:55%,  
**LISN** : 2017 ENV216/NEUTRAL  
Press:100.1kPa  
**Memo** : Add power amplifier

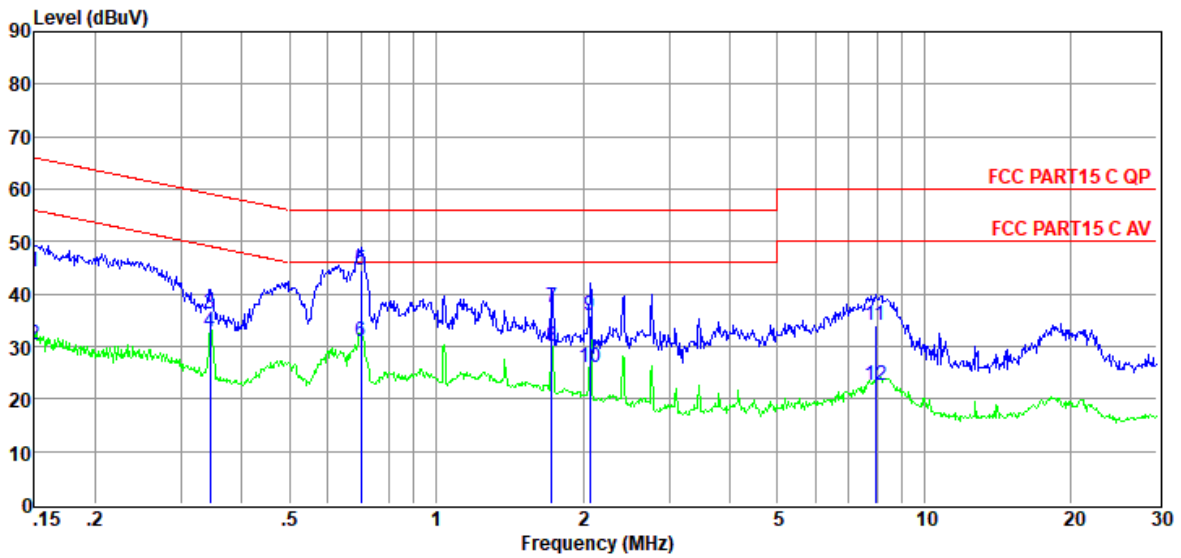

Item	Freq.	Read Level	LISN Factor	Cable Loss	Pulse Limiter Factor	Result Level	Limit Line	Over Limit	Detector	Phase
(Mark)	(MHz)	(dBμV)	(dB)	(dB)	(dB)	(dBμV)	(dBμV)	(dB)		
1	0.15	24.74	9.49	0.04	9.86	44.13	66.00	-21.87	QP	NEUTRAL
2	0.15	11.04	9.49	0.04	9.86	30.43	56.00	-25.57	Average	NEUTRAL
3	0.34	16.88	9.38	0.04	9.84	36.14	59.09	-22.95	QP	NEUTRAL
4	0.34	13.40	9.38	0.04	9.84	32.66	49.09	-16.43	Average	NEUTRAL
5	0.70	25.13	9.32	0.09	9.86	44.40	56.00	-11.60	QP	NEUTRAL
6	0.70	11.68	9.32	0.09	9.86	30.95	46.00	-15.05	Average	NEUTRAL
7	1.73	18.08	9.28	0.13	9.86	37.35	56.00	-18.65	QP	NEUTRAL
8	1.73	10.75	9.28	0.13	9.86	30.02	46.00	-15.98	Average	NEUTRAL
9	2.07	16.51	9.30	0.12	9.87	35.80	56.00	-20.20	QP	NEUTRAL
10	2.07	6.74	9.30	0.12	9.87	26.03	46.00	-19.97	Average	NEUTRAL
11	7.94	14.71	9.36	0.11	9.88	34.06	60.00	-25.94	QP	NEUTRAL
12	7.94	3.17	9.36	0.11	9.88	22.52	50.00	-27.48	Average	NEUTRAL

- Note: 1. Result Level = Read Level + LISN Factor + Pulse Limiter Factor + Cable loss.  
 2. If QP Result complies with AV limit, AV Result is deemed to comply with AV limit.  
 3. Test setup: RBW: 200 Hz (9 kHz—150 kHz), 9 kHz (150 kHz—30 MHz).  
 4. Step size: 80Hz (0.009MHz-0.15MHz), 4 kHz (0.15MHz-30MHz), Scan time: auto.

# TR-4-E-010 Conducted Emission Test Result

**Test Site** : DDT 1# Shield Room D:\2018 CE report data\Q18041203-1E\CE.EM6  
**Test Date** : 2018-04-14 **Tested By** : Jerry  
**EUT** : PORTABLE BLUETOOTH SPEAKER **Model Number** : GO2H  
**Power Supply** : AC 120V/60Hz **Test Mode** : Tx mode  
**Condition** : Temp:24.5°C,Humi:55%,  
**LISN** : 2017 ENV216/LINE  
Press:100.1kPa  
**Memo** : Add power amplifier

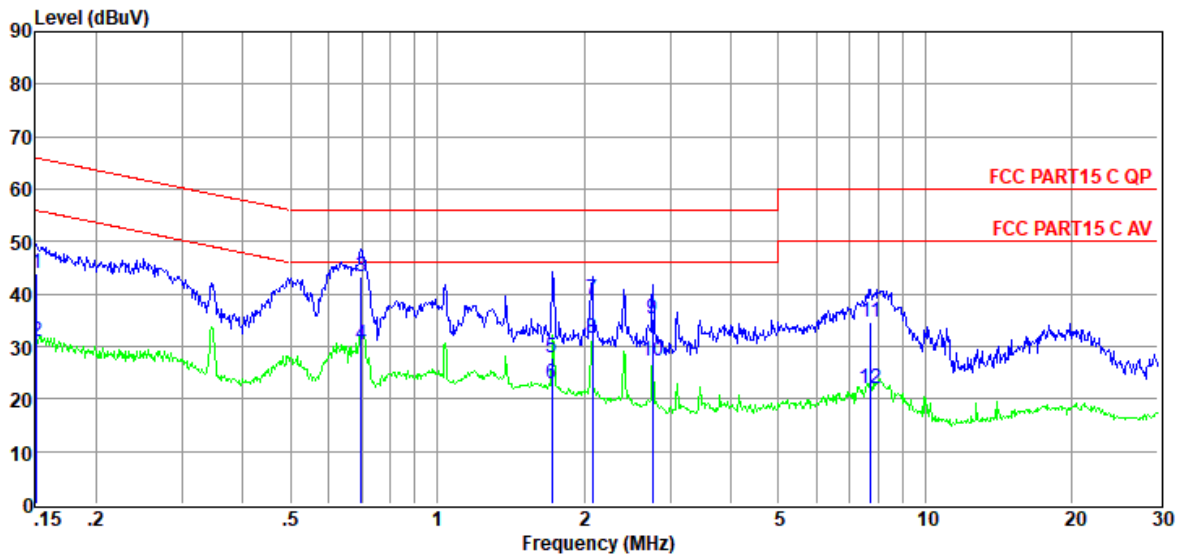

Item	Freq.	Read Level	LISN Factor	Cable Loss	Pulse Limiter Factor	Result Level	Limit Line	Over Limit	Detector	Phase
(Mark)	(MHz)	(dBμV)	(dB)	(dB)	(dB)	(dBμV)	(dBμV)	(dB)		
1	0.15	24.56	9.52	0.04	9.86	43.98	65.96	-21.98	QP	LINE
2	0.15	11.51	9.52	0.04	9.86	30.93	55.96	-25.03	Average	LINE
3	0.70	23.69	9.55	0.09	9.86	43.19	56.00	-12.81	QP	LINE
4	0.70	10.89	9.55	0.09	9.86	30.39	46.00	-15.61	Average	LINE
5	1.72	8.15	9.59	0.13	9.86	27.73	56.00	-28.27	QP	LINE
6	1.72	3.24	9.59	0.13	9.86	22.82	46.00	-23.18	Average	LINE
7	2.08	19.40	9.60	0.12	9.87	38.99	56.00	-17.01	QP	LINE
8	2.08	12.00	9.60	0.12	9.87	31.59	46.00	-14.41	Average	LINE
9	2.77	15.63	9.62	0.11	9.87	35.23	56.00	-20.77	QP	LINE
10	2.77	7.60	9.62	0.11	9.87	27.20	46.00	-18.80	Average	LINE
11	7.73	14.99	9.73	0.11	9.88	34.71	60.00	-25.29	QP	LINE
12	7.73	2.16	9.73	0.11	9.88	21.88	50.00	-28.12	Average	LINE

- Note: 1. Result Level = Read Level + LISN Factor + Pulse Limiter Factor + Cable loss.  
 2. If QP Result complies with AV limit, AV Result is deemed to comply with AV limit.  
 3. Test setup: RBW: 200 Hz (9 kHz—150 kHz), 9 kHz (150 kHz—30 MHz).  
 4. Step size: 80Hz (0.009MHz-0.15MHz), 4 kHz (0.15MHz-30MHz), Scan time: auto.

# TR-4-E-010 Conducted Emission Test Result

**Test Site** : DDT 1# Shield Room D:\2018 CE report data\Q18082902-1E\CE.EM6  
**EUT** : PORTABLE BLUETOOTH SPEAKER **Model Number** : GO2H  
**Power Supply** : AC 120V/60Hz **Test Mode** : TX mode  
**Power Supply** : AC 240V/50Hz **Test Mode** : Charging + BT mode  
**Condition** : Temp:24.5°C, Humi:55.5%,  
**LISN** : 2017 ENV216/NEUTRAL  
Press:100.1kPa  
**Memo** : Battery model: 304055

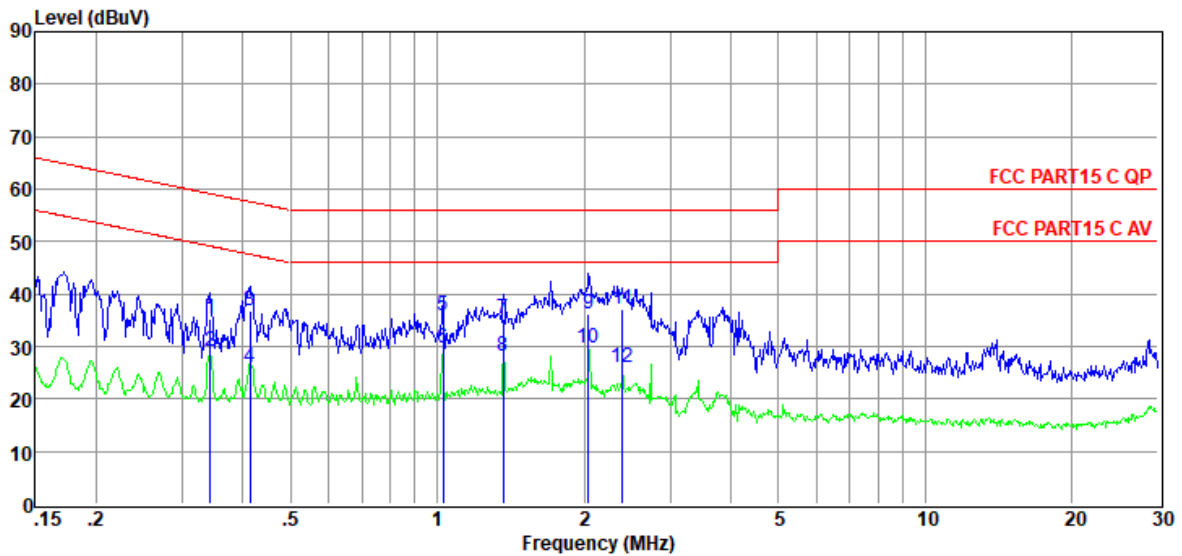

Item	Freq.	Read Level	LISN Factor	Cable Loss	Pulse Limiter Factor	Result Level	Limit Line	Over Limit	Detector	Phase
(Mark)	(MHz)	(dBμV)	(dB)	(dB)	(dB)	(dBμV)	(dBμV)	(dB)		
1	0.34	15.91	9.38	0.04	9.84	35.17	59.13	-23.96	QP	NEUTRAL
2	0.34	9.80	9.38	0.04	9.84	29.06	49.13	-20.07	Average	NEUTRAL
3	0.41	17.43	9.37	0.04	9.82	36.66	57.59	-20.93	QP	NEUTRAL
4	0.41	6.64	9.37	0.04	9.82	25.87	47.59	-21.72	Average	NEUTRAL
5	1.03	16.70	9.30	0.14	9.86	36.00	56.00	-20.00	QP	NEUTRAL
6	1.03	10.27	9.30	0.14	9.86	29.57	46.00	-16.43	Average	NEUTRAL
7	1.37	16.12	9.28	0.13	9.86	35.39	56.00	-20.61	QP	NEUTRAL
8	1.37	8.76	9.28	0.13	9.86	28.03	46.00	-17.97	Average	NEUTRAL
9	2.04	16.82	9.29	0.12	9.87	36.10	56.00	-19.90	QP	NEUTRAL
10	2.04	10.47	9.29	0.12	9.87	29.75	46.00	-16.25	Average	NEUTRAL
11	2.40	17.82	9.39	0.12	9.87	37.20	56.00	-18.80	QP	NEUTRAL
12	2.40	6.55	9.39	0.12	9.87	25.93	46.00	-20.07	Average	NEUTRAL

- Note: 1. Result Level = Read Level + LISN Factor + Pulse Limiter Factor + Cable loss.  
 2. If QP Result complies with AV limit, AV Result is deemed to comply with AV limit.  
 3. Test setup: RBW: 200 Hz (9 kHz—150 kHz), 9 kHz (150 kHz—30 MHz).  
 4. Step size: 80Hz (0.009MHz-0.15MHz), 4 kHz (0.15MHz-30MHz), Scan time: auto.

## TR-4-E-010 Conducted Emission Test Result

**Test Site** : DDT 1# Shield Room D:\2018 CE report data\Q18082902-1E\CE.EM6  
**EUT** : PORTABLE BLUETOOTH SPEAKER **Model Number** : GO2H  
**Power Supply** : AC 120V/60Hz **Test Mode** : TX mode  
**Power Supply** : AC 240V/50Hz **Test Mode** : Charging + BT mode  
**Condition** : Temp:24.5°C, Humi:55.5%,  
 : Press:100.1kPa **LISN** : 2017 ENV216/LINE  
**Memo** : Battery model: 304055

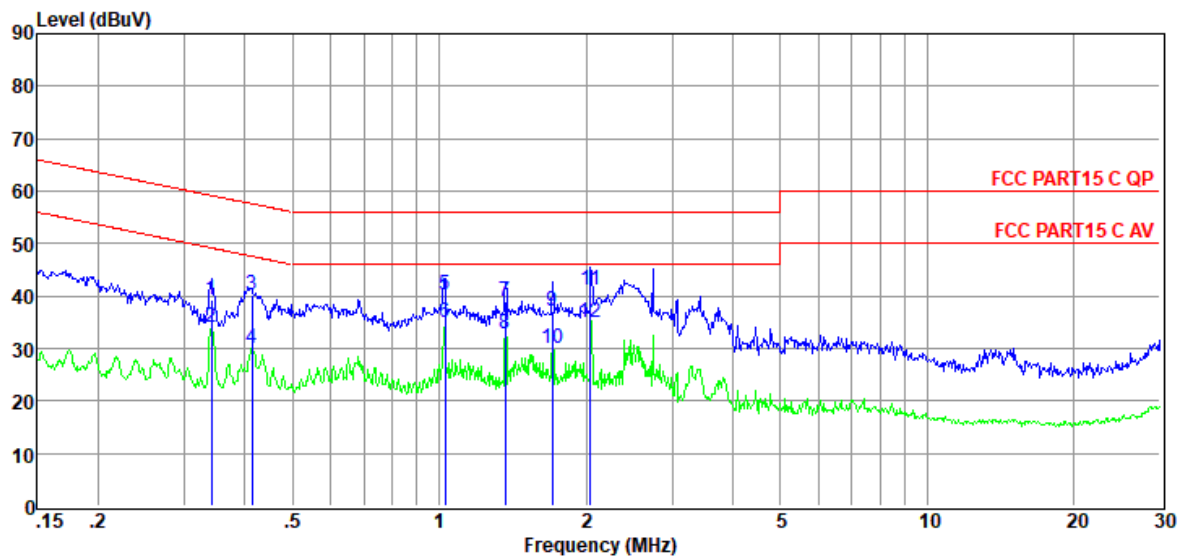

Item	Freq.	Read Level	LISN Factor	Cable Loss	Pulse Limiter Factor	Result Level	Limit Line	Over Limit	Detector	Phase
(Mark)	(MHz)	(dBμV)	(dB)	(dB)	(dB)	(dBμV)	(dBμV)	(dB)		
1	0.34	19.84	9.52	0.04	9.84	39.24	59.18	-19.94	QP	LINE
2	0.34	14.48	9.52	0.04	9.84	33.88	49.18	-15.30	Average	LINE
3	0.41	20.76	9.53	0.04	9.82	40.15	57.59	-17.44	QP	LINE
4	0.41	10.63	9.53	0.04	9.82	30.02	47.59	-17.57	Average	LINE
5	1.03	20.69	9.57	0.14	9.86	40.26	56.00	-15.74	QP	LINE
6	1.03	15.36	9.57	0.14	9.86	34.93	46.00	-11.07	Average	LINE
7	1.37	19.37	9.58	0.13	9.86	38.94	56.00	-17.06	QP	LINE
8	1.37	13.09	9.58	0.13	9.86	32.66	46.00	-13.34	Average	LINE
9	1.71	17.46	9.59	0.13	9.86	37.04	56.00	-18.96	QP	LINE
10	1.71	10.47	9.59	0.13	9.86	30.05	46.00	-15.95	Average	LINE
11	2.04	21.67	9.60	0.12	9.87	41.26	56.00	-14.74	QP	LINE
12	2.04	15.37	9.60	0.12	9.87	34.96	46.00	-11.04	Average	LINE

Note: 1. Result Level = Read Level + LISN Factor + Pulse Limiter Factor + Cable loss.

2. If QP Result complies with AV limit, AV Result is deemed to comply with AV limit.

3. Test setup: RBW: 200 Hz (9 kHz—150 kHz), 9 kHz (150 kHz—30 MHz).

4. Step size: 80Hz (0.009MHz-0.15MHz), 4 kHz (0.15MHz-30MHz), Scan time: auto.

# TR-4-E-010 Conducted Emission Test Result

**Test Site** : DDT 1# Shield Room D:\2020 CE report data\Q20030310-1E\20200305 CE.EM6  
**Test Date** : 2020-03-05 **Tested By** : Huang  
**EUT** : Bluetooth Speaker **Model Number** : JBL GO2  
**Power Supply** : AC 120V/60Hz **Test Mode** : Charging+BT mode  
**Condition** : Temp:24.5°C, Humi:55.5%,  
**LISN** : 2019 ENV216 1#/NEUTRAL  
Press:100.1kPa  
**Memo** : Battery model: GSP383555 01

Data: 22

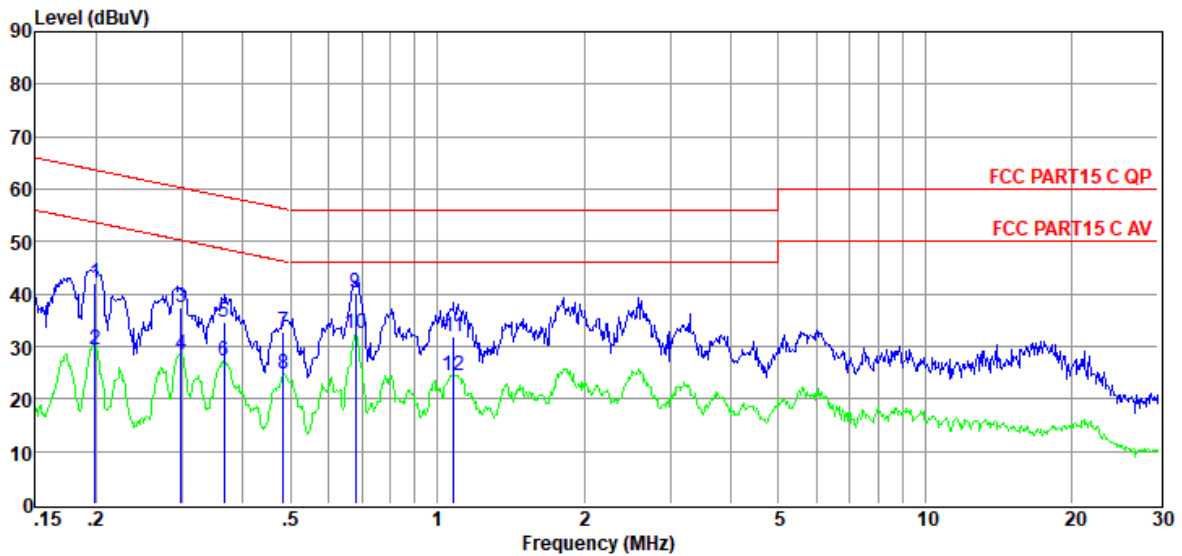

Item	Freq.	Read Level	LISN Factor	Cable Loss	Pulse Limiter Factor	Result Level	Limit Line	Over Limit	Detector	Phase
(Mark)	(MHz)	(dBμV)	(dB)	(dB)	(dB)	(dBμV)	(dBμV)	(dB)		
1	0.20	22.49	9.60	0.02	9.86	41.97	63.67	-21.70	QP	NEUTRAL
2	0.20	10.05	9.60	0.02	9.86	29.53	53.67	-24.14	Average	NEUTRAL
3	0.30	18.08	9.60	0.02	9.86	37.56	60.28	-22.72	QP	NEUTRAL
4	0.30	8.87	9.60	0.02	9.86	28.35	50.28	-21.93	Average	NEUTRAL
5	0.37	15.21	9.60	0.02	9.86	34.69	58.61	-23.92	QP	NEUTRAL
6	0.37	7.69	9.60	0.02	9.86	27.17	48.61	-21.44	Average	NEUTRAL
7	0.48	13.46	9.60	0.02	9.86	32.94	56.27	-23.33	QP	NEUTRAL
8	0.48	5.33	9.60	0.02	9.86	24.81	46.27	-21.46	Average	NEUTRAL
9	0.68	20.83	9.60	0.03	9.86	40.32	56.00	-15.68	QP	NEUTRAL
10	0.68	12.85	9.60	0.03	9.86	32.34	46.00	-13.66	Average	NEUTRAL
11	1.08	12.30	9.60	0.03	9.86	31.79	56.00	-24.21	QP	NEUTRAL
12	1.08	5.08	9.60	0.03	9.86	24.57	46.00	-21.43	Average	NEUTRAL

- Note: 1. Result Level = Read Level + LISN Factor + Pulse Limiter Factor + Cable loss.  
 2. If QP Result complies with AV limit, AV Result is deemed to comply with AV limit.  
 3. Test setup: RBW: 200 Hz (9 kHz—150 kHz), 9 kHz (150 kHz—30 MHz).  
 4. Step size: 80Hz (0.009MHz-0.15MHz), 4 kHz (0.15MHz-30MHz), Scan time: auto.

# TR-4-E-010 Conducted Emission Test Result

<b>Test Site</b>	: DDT 1# Shield Room	D:\2020 CE report data\Q20030310-1E\20200305 CE.EM6
<b>Test Date</b>	: 2020-03-05	<b>Tested By</b> : Huang
<b>EUT</b>	: Bluetooth Speaker	<b>Model Number</b> : JBL GO2
<b>Power Supply</b>	: AC 120V/60Hz	<b>Test Mode</b> : Charging+BT mode
<b>Condition</b>	: Temp:24.5°C, Humi:55.5%, Press:100.1kPa	<b>LISN</b> : 2019 ENV216 1#/LINE
<b>Memo</b>	: Battery model: GSP383555 01	

Data: 24

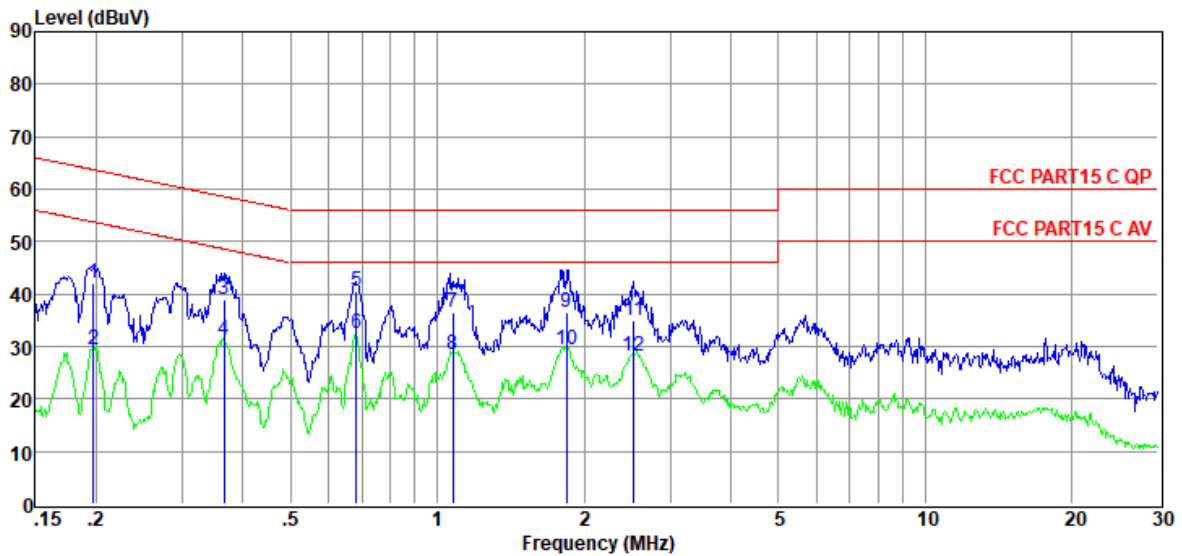

Item	Freq.	Read Level	LISN Factor	Cable Loss	Pulse Limiter Factor	Result Level	Limit Line	Over Limit	Detector	Phase
(Mark)	(MHz)	(dBμV)	(dB)	(dB)	(dB)	(dBμV)	(dBμV)	(dB)		
1	0.20	22.58	9.60	0.02	9.86	42.06	63.71	-21.65	QP	LINE
2	0.20	9.95	9.60	0.02	9.86	29.43	53.71	-24.28	Average	LINE
3	0.37	19.59	9.60	0.02	9.86	39.07	58.61	-19.54	QP	LINE
4	0.37	11.63	9.60	0.02	9.86	31.11	48.61	-17.50	Average	LINE
5	0.68	21.14	9.60	0.03	9.86	40.63	56.00	-15.37	QP	LINE
6	0.68	12.96	9.60	0.03	9.86	32.45	46.00	-13.55	Average	LINE
7	1.08	17.12	9.60	0.03	9.86	36.61	56.00	-19.39	QP	LINE
8	1.08	9.02	9.60	0.03	9.86	28.51	46.00	-17.49	Average	LINE
9	1.84	17.05	9.60	0.05	9.86	36.56	56.00	-19.44	QP	LINE
10	1.84	9.76	9.60	0.05	9.86	29.27	46.00	-16.73	Average	LINE
11	2.53	15.39	9.60	0.06	9.86	34.91	56.00	-21.09	QP	LINE
12	2.53	8.76	9.60	0.06	9.86	28.28	46.00	-17.72	Average	LINE

- Note: 1. Result Level = Read Level + LISN Factor + Pulse Limiter Factor + Cable loss.  
 2. If QP Result complies with AV limit, AV Result is deemed to comply with AV limit.  
 3. Test setup: RBW: 200 Hz (9 kHz—150 kHz), 9 kHz (150 kHz—30 MHz).  
 4. Step size: 80Hz (0.009MHz-0.15MHz), 4 kHz (0.15MHz-30MHz), Scan time: auto.

## 13. Antenna Requirements

### 13.1. Limit

For intentional device, according to FCC 47 CFR Section 15.203, an intentional radiator shall be designed to ensure that no antenna other than that furnished by the responsible party shall be used with the device. And according to FCC 47 CFR Section 15.247 (b), if transmitting antennas of directional gain greater than 6dBi are used, the power shall be reduced by the amount in dB that the directional gain of the antenna exceeds 6dBi.

### 13.2. Result

The antennas used for this product are integrated antenna and that no antenna other than that furnished by the responsible party shall be used with the device, the maximum peak gain of the transmit antenna is only 1.30dBi.

**END OF REPORT**