



FCC AND ISED CERTIFICATION TEST REPORT

Applicant	:	Harman International Industries, Inc.
Address of Applicant	:	8500 Balboa Boulevard, Northridge, CA 91329, UNITED STATES
Manufacturer	:	Harman International Industries, Inc.
Address of Manufacturer	:	8500 Balboa Boulevard, Northridge, CA 91329, UNITED STATES
Equipment under Test	:	BLUETOOTH HEADSET
Model No.	:	ENDURANCE PACE
FCC ID	:	APIJBLENPACE
IC	:	6132A-JBLENPACE
Test Standard(s)	:	FCC Rules and Regulations Part 15 Subpart C, RSS-247 Issue 3 August 2023, ANSI C63.10:2013, RSS-Gen Issue 5, Apr. 2018, Amendment 2 (February 2021)
Report No.	:	DDT-RE25042425-1E02
Issue Date	:	2025/06/18
Issue By	:	Guangdong Dongdian Testing Service Co., Ltd. Unit 2, Building 1, No. 17, Zongbu 2nd Road, Songshan Lake Park, Dongguan, Guangdong, China, 523808

REPORT

Table of Contents

1.	Summary of Test Results	7
2.	General Test Information	8
2.1.	Description of EUT	8
2.2.	Accessories of EUT	9
2.3.	Block diagram of EUT configuration for test.....	9
2.4.	Decision of final test mode	9
2.5.	Deviations of test standard	10
2.6.	Test environment conditions.....	10
2.7.	Test laboratory	10
2.8.	Measurement uncertainty	11
3.	Equipment Used During Conductive Test	12
4.	6 dB Bandwidth.....	13
4.1.	Block diagram of test setup	13
4.2.	Limits.....	13
4.3.	Test procedure.....	13
4.4.	Test result	14
4.5.	Test graphs	15
5.	99% Bandwidth	17
5.1.	Block diagram of test setup	17
5.2.	Limits.....	17
5.3.	Test procedure.....	17
5.4.	Test result	18
5.5.	Test graphs	19
6.	Maximum Peak Output Power.....	21
6.1.	Block diagram of test setup	21
6.2.	Limits.....	21
6.3.	Test procedure.....	21
6.4.	Test result	22
6.5.	Test graphs	23
7.	Power Spectral Density	25
7.1.	Block diagram of test setup	25
7.2.	Limits.....	25
7.3.	Test procedure.....	25
7.4.	Test result	26
7.5.	Test graphs	27
8.	Band Edge Compliance (Conducted Method).....	29

8.1.	Block diagram of test setup	29
8.2.	Limits.....	29
8.3.	Test procedure.....	29
8.4.	Test result	30
8.5.	Test graphs.....	31
9.	RF Conducted Spurious Emissions.....	33
9.1.	Block diagram of test setup	33
9.2.	Limits.....	33
9.3.	Test procedure.....	33
9.4.	Test result	34
9.5.	Test graphs.....	35
10.	Duty Cycle.....	41
10.1.	Block diagram of test setup	41
10.2.	Limit.....	41
10.3.	Test procedure.....	41
10.4.	Test result	42
10.5.	Test graphs.....	43
11.	Antenna Requirements	45
11.1.	Limit.....	45
11.2.	Result.....	45
12.	Radiated Emission.....	46
12.1.	Test equipment.....	46
12.2.	Block diagram of test setup	47
12.3.	Limits.....	48
12.4.	Assistant equipment used for test	50
12.5.	Test procedure.....	50
12.6.	Test result	51
12.7.	Test data	52
13.	Band Edge Compliance	68
13.1.	Test equipment.....	68
13.2.	Block diagram of test setup	69
13.3.	Limits.....	69
13.4.	Assistant equipment used for test	69
13.5.	Test procedure.....	69
13.6.	Test result	69
13.7.	Test data	70
14.	Power Line Conducted Emissions.....	78
14.1.	Test equipment.....	78

14.2.	Block diagram of test setup	78
14.3.	Limits.....	78
14.4.	Assistant equipment used for test	78
14.5.	Test procedure.....	79
14.6.	Test result	79
14.7.	Test data	80
15.	Test Setup Photograph.....	82
16.	Photos of the EUT	84

Test Report Declare

Applicant	:	Harman International Industries, Inc.
Address of Applicant	:	8500 Balboa Boulevard, Northridge, CA 91329, UNITED STATES
Equipment under Test	:	BLUETOOTH HEADSET
Model No.	:	ENDURANCE PACE
Manufacturer	:	Harman International Industries, Inc.
Address of Manufacturer	:	8500 Balboa Boulevard, Northridge, CA 91329, UNITED STATES

Test Standard Used:

FCC Rules and Regulations Part 15 Subpart C,
 RSS-247 Issue 3 August 2023,
 ANSI C63.10:2013,
 RSS-Gen Issue 5, Apr. 2018, Amendment 2 (February 2021)

We Declare:

The equipment described above is tested by Guangdong Dongdian Testing Service Co., Ltd. and in the configuration tested the equipment complied with the standards specified above. The test results are contained in this test report and Guangdong Dongdian Testing Service Co., Ltd. is assumed of full responsibility for the accuracy and completeness of these tests.

Report No.:	DDT-RE25042425-1E02		
Date of Receipt:	2025/05/06	Date of Test:	2025/05/06 - 2025/05/23

Created: Bobo Chen	Reviewed: Ella Gong	Approved: Damon Hu
<i>Bobo Chen</i>	<i>Ella Gong</i>	<i>Damon Hu</i>
2025/05/23	2025/06/18	2025/06/18

Note: This report applies to above tested sample only. This report shall not be reproduced in parts without written approval of Guangdong Dongdian Testing Service Co., Ltd.

Revision History

Version	Revision Content	Issue Date	Approved
---	Initial issue	2025/06/18	

1. Summary of Test Results

No.	Test Parameter	Clause No.	Condition	Result
1	6 dB Bandwidth and 99% Bandwidth	FCC Part 15: 15.247(a)(2), RSS-247 Issue 3 clause 5.2(a), RSS-Gen Issue 5 clause 6.7	/	Pass
2	Peak Output Power	FCC Part 15: 15.247(b)(3), RSS-247 Issue 3 clause 5.4(d)	/	Pass
3	Power Spectral Density	FCC Part 15:15.247(e), RSS-247 Issue 3 clause 5.2(b)	/	Pass
4	RF Conducted Spurious Emissions	FCC Part 15: 15.247(d), RSS-247 Issue 3 clause 5.5	/	Pass
5	Radiated Emission	FCC Part 15: 15.205, FCC Part 15: 15.209, FCC Part 15: 15.247(d), RSS-247 Issue 3 clause 5.5, RSS-Gen Issue 5 clause 8.9, RSS-Gen Issue 5 clause 8.10	/	Pass
6	Band Edge Compliance	FCC Part 15: 15.205, FCC Part 15: 15.209, FCC Part 15: 15.247(d), RSS-247 Issue 3 clause 5.5, RSS-Gen Issue 5 clause 8.9, RSS-Gen Issue 5 clause 8.10	/	Pass
7	Power Line Conducted Emissions	FCC Part 15: 15.207(a), RSS-Gen Issue 5 clause 8.8	/	Pass
8	Antenna Requirement	FCC Part 15: 15.203, RSS-Gen Issue 5 clause 6.8	/	Pass

Note: N/A is an abbreviation for Not Applicable, and means this item is not applicable for this device or no need to test according to standard.

2. General Test Information

2.1. Description of EUT

EUT Name	: BLUETOOTH HEADSET
Model Number	: ENDURANCE PACE
EUT Function Description	: Please reference user manual of this device
Power Supply	: DC 5V from external AC adapter : DC 3.85V Lithium-ion built-in battery
Antenna Type	: FPC
Max Antenna Gain(dBi)	: -6.8

Radio Specification	: Bluetooth LE
Operation Frequency	: 2402 MHz to 2480 MHz
Modulation	: GFSK

Bluetooth LE 1Mbps Channel information					
Channel	Frequency (MHz)	Channel	Frequency (MHz)	Channel	Frequency (MHz)
0	2402	14	2430	28	2458
1	2404	15	2432	29	2460
2	2406	16	2434	30	2462
3	2408	17	2436	31	2464
4	2410	18	2438	32	2466
5	2412	19	2440	33	2468
6	2414	20	2442	34	2470
7	2416	21	2444	35	2472
8	2418	22	2446	36	2474
9	2420	23	2448	37	2476
10	2422	24	2450	38	2478
11	2424	25	2452	39	2480
12	2426	26	2454		
13	2428	27	2456		
Bluetooth LE 2Mbps Channel information					
Channel	Frequency (MHz)	Channel	Frequency (MHz)	Channel	Frequency (MHz)
0	2402	14	2430	28	2458
1	2404	15	2432	29	2460
2	2406	16	2434	30	2462
3	2408	17	2436	31	2464
4	2410	18	2438	32	2466
5	2412	19	2440	33	2468
6	2414	20	2442	34	2470

7	2416	21	2444	35	2472
8	2418	22	2446	36	2474
9	2420	23	2448	37	2476
10	2422	24	2450	38	2478
11	2424	25	2452	39	2480
12	2426	26	2454	/	/
13	2428	27	2456	/	/

The channels denoted with the grey background are excluded, because they are primary advertising channel only for the Bluetooth LE 1Mbps according to the Bluetooth Core Specification.

Note: The above EUT information is declared by manufacturer and for more detailed features description please refer to the manufacturer's specifications or User's Manual. The above Antenna information is declared by manufacturer and for more detailed features description please refer to the manufacturer's specifications, the laboratory shall not be held responsible.

“☒” means to be chosen or applicable; “☐” means don't to be chosen or not applicable; This note applies to entire report.

2.2. Accessories of EUT

Accessories	Manufacturer	Model number	Description
/	/	/	/

2.3. Block diagram of EUT configuration for test



2.4. Decision of final test mode

According pre-test, the worst test modes were reported as below:

Test software: RTLBTAPP.exe

The test software was used to control EUT work in Continuous Tx mode, and select test channel, wireless mode as below table:

The pathloss of external cable: 0.5dB (According to the manufacturer's claims)

Tested mode, Tx Power Setting, Channel, and Frequency			
Mode	Setting Tx Power	Channel	Frequency (MHz)
GFSK 1M	Default	CH0	2402
	Default	CH19	2440
	Default	CH39	2480
GFSK 2M	Default	CH1	2404
	Default	CH19	2440
	Default	CH38	2478

2.5. Deviations of test standard

No deviation.

2.6. Test environment conditions

During the measurement the environmental conditions were within the listed ranges:

Temperature range:	+15°C to +35 °C
Humidity range:	20% to 75%
Pressure range:	86 kPa to106 kPa

Note: The specific temperature and humidity information of each test item refers to the temperature and humidity record in the corresponding test data.

2.7. Test laboratory

Guangdong Dongdian Testing Service Co., Ltd.

Add.: Unit 2, Building 1, No. 17, Zongbu 2nd Road, Songshan Lake Park, Dongguan, Guangdong, China, 523808.

Tel.: +86-0769-38826678, <http://www.dgddt.com>, Email: ddt@dgddt.com.

CNAS Accreditation No. L6451; A2LA Accreditation Number: 3870.01

FCC Designation Number: CN1182, Test Firm Registration Number: 540522

Innovation, Science and Economic Development Canada Site Registration Number: 10288A

Conformity Assessment Body identifier: CN0048

VCCI facility registration number: C-20087, T-20088, R-20123, R-20240, G-20118

2.8. Measurement uncertainty

Test Item	Uncertainty
Bandwidth	1.1%
Peak Output Power (Conducted) (Spectrum analyzer)	0.86 dB (10 MHz ≤ f < 3.6 GHz);
	1.38 dB (3.6 GHz ≤ f < 8 GHz)
Peak Output Power (Conducted) (Power Sensor)	0.74 dB
Power Spectral Density	0.74 dB (10 MHz ≤ f < 3.6 GHz);
	1.38 dB (3.6 GHz ≤ f < 8 GHz)
Frequencies Stability	6.7 x 10 ⁻⁸ (Antenna couple method)
	5.5 x 10 ⁻⁸ (Conducted method)
Conducted spurious emissions	0.86 dB (10 MHz ≤ f < 3.6 GHz);
	1.40 dB (3.6 GHz ≤ f < 8 GHz)
	1.66 dB (8 GHz ≤ f < 26.5 GHz)
Uncertainty for radio frequency (RBW < 20 kHz)	3×10 ⁻⁸
Temperature	0.4 °C
Humidity	2 %
Uncertainty for Radiation Emission test (9 kHz – 30 MHz)	3.44 dB
Uncertainty for Radiation Emission test (30 MHz - 1 GHz)	4.70 dB (Antenna Polarize: V)
	4.84 dB (Antenna Polarize: H)
Uncertainty for Radiation Emission test (1 GHz - 40 GHz)	4.10 dB (1 - 6 GHz)
	4.40 dB (6 GHz - 18 GHz)
	3.54 dB (18 GHz - 26 GHz)
	4.30 dB (26 GHz - 40 GHz)
Uncertainty for Power line conduction emission test	3.34dB (150KHz-30MHz)
	3.72dB (9KHz-150KHz)

Note: This uncertainty represents an expanded uncertainty expressed at approximately the 95% confidence level using a coverage factor of k=2.

3. Equipment Used During Conductive Test

Equipment	Manufacturer	Model No.	Serial Number	Due Date
☑ RF Connected Test (RF Measurement System 1#)				
SIGNAL ANALYZER	R&S	FSQ26	101272	2026/03/28
Wideband Radio Communication Tester	R&S	CMW500	120259	2026/03/28
MXG Vector Signal Generator	KEYSIGHT	N5182B	MY59100192	2026/03/28
MXG Vector Signal Generator	Agilent	N5182A	MY19060405	2026/03/28
RF Control Unit	Tonsend	JS0806-2	158060010	2026/03/28
TEMP&HUMI Programmable Chamber	ZHIXIANG	ZXGDJS-150L	ZX170110-A	2026/03/28
Test Software	Tonscend	JS1120-3	Ver.3.2.22	N/A

4. 6 dB Bandwidth

4.1. Block diagram of test setup

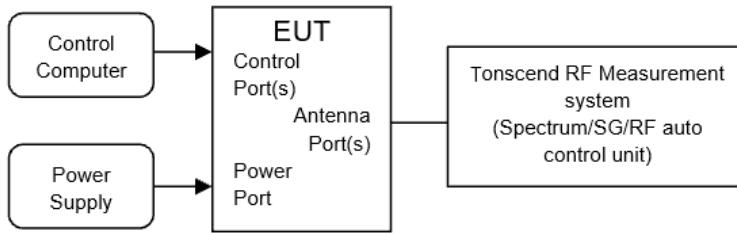

4.2. Limits

For direct sequence systems, the minimum 6 dB bandwidth shall be at least 500 kHz

4.3. Test procedure

- (1) The test according to ANSI C63.10-2013 clause 11.8.
- (2) Connect EUT's antenna output to spectrum analyzer by RF cable, the path loss was compensated to the results
- (3) Set the EUT as maximum power setting and enable the EUT transmit continuously
- (4) Use the following spectrum analyzer settings for 6 dB Bandwidth:

RBW:	100 kHz
VBW:	$\geq [3 \times \text{RBW}]$
Detector Mode:	Peak
Sweep time:	Auto
Trace mode	Max hold
- (5) Allow the trace to stabilize, measure the 6 dB bandwidth of signal, and record the results in the report.

4.4. Test result

Test Engineer:	Zora Zhang	Test Site:	RF Measurement System 1#
Ambient Condition:	24.9°C,52%RH	Test Date:	2025.05.13
Test Power Supply:	Battery	Sample Number:	S25042425-018

Test Mode	Antenna	Frequency [MHz]	DTS BW [MHz]	FL[MHz]	FH[MHz]	Limit [MHz]	Verdict
BLE_1M	Ant1	2402	0.66	2401.66	2402.32	0.5	PASS
		2440	0.66	2439.67	2440.33	0.5	PASS
		2480	0.66	2479.67	2480.33	0.5	PASS
BLE_2M	Ant1	2404	0.95	2403.45	2404.41	0.5	PASS
		2440	1.11	2439.46	2440.57	0.5	PASS
		2478	1.12	2477.45	2478.58	0.5	PASS

4.5. Test graphs

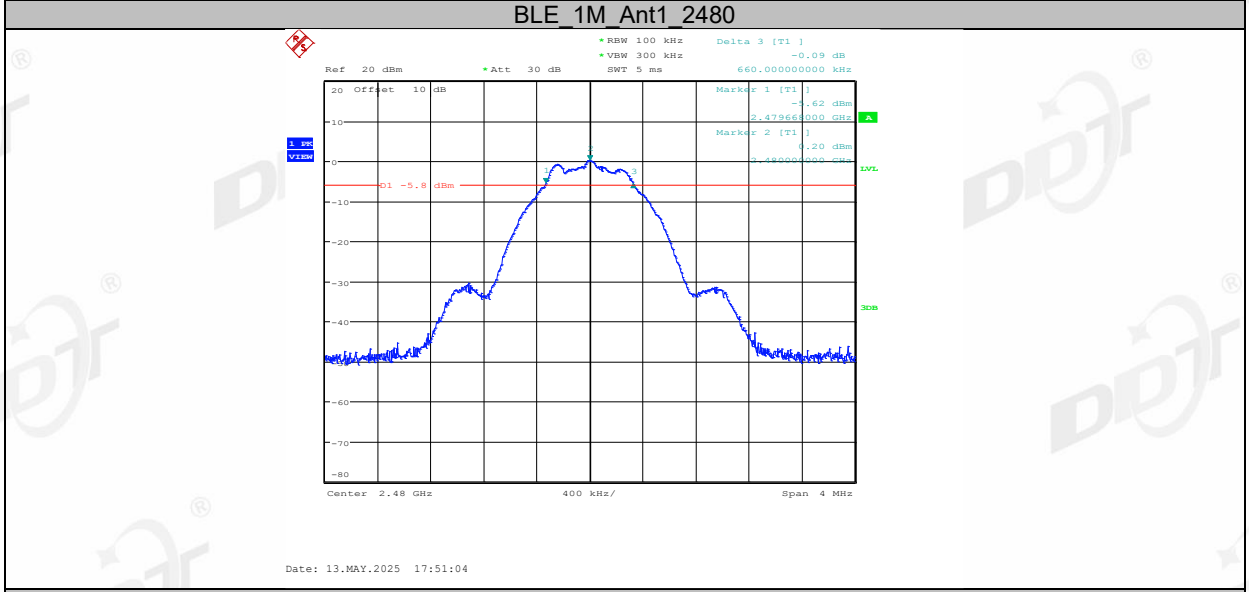
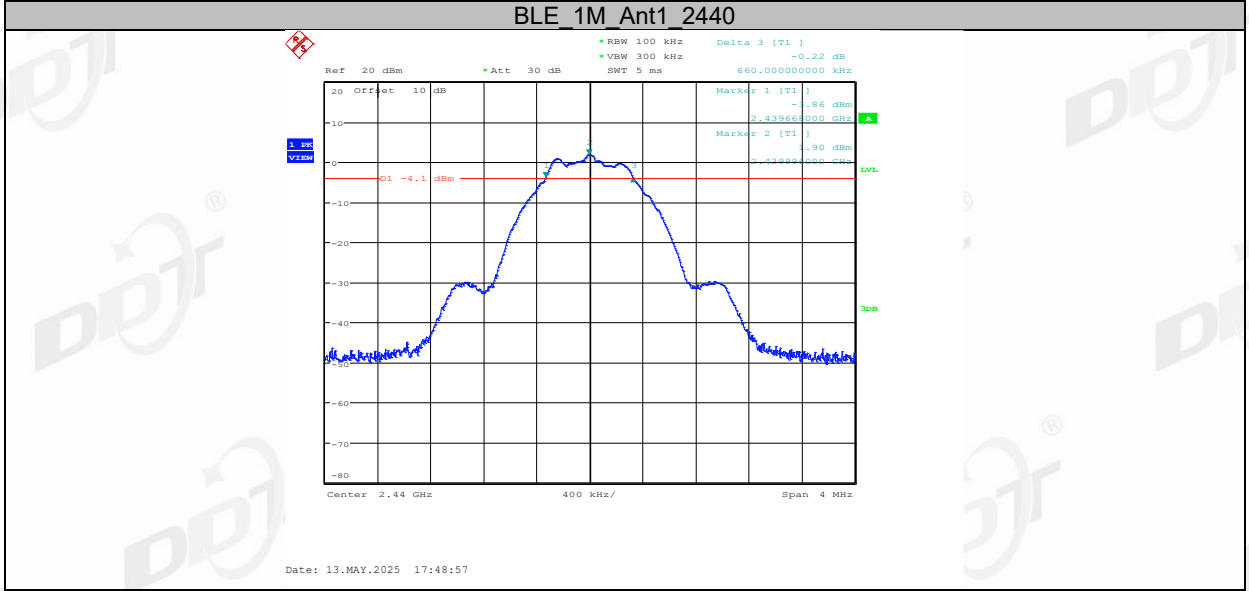
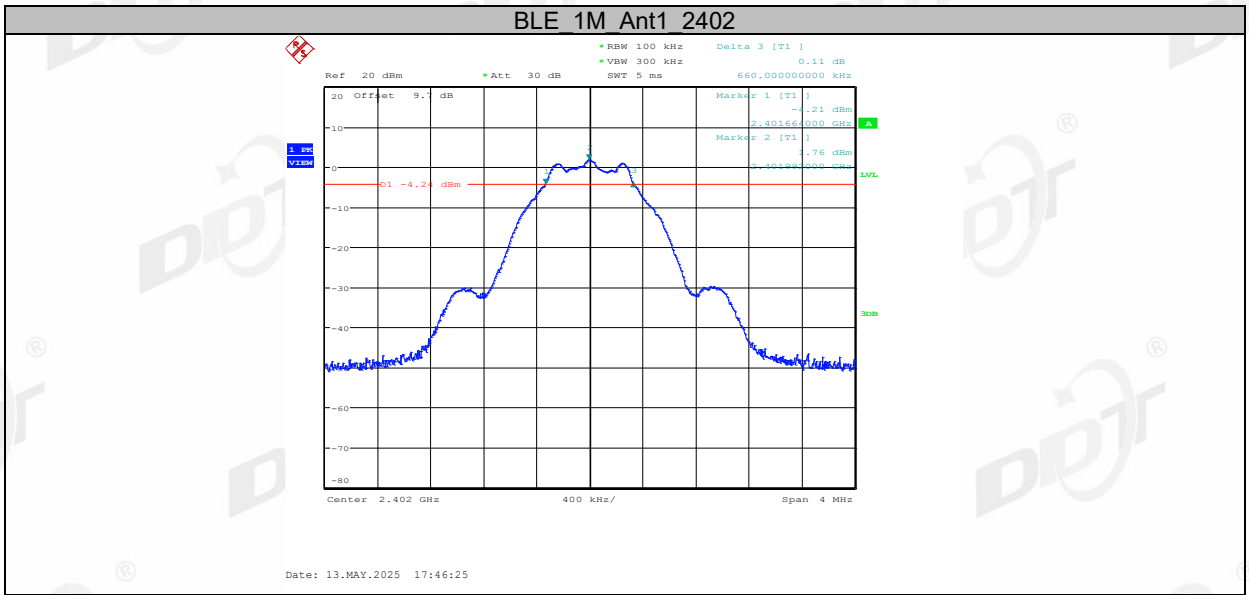

BLE 2M Ant1 2404

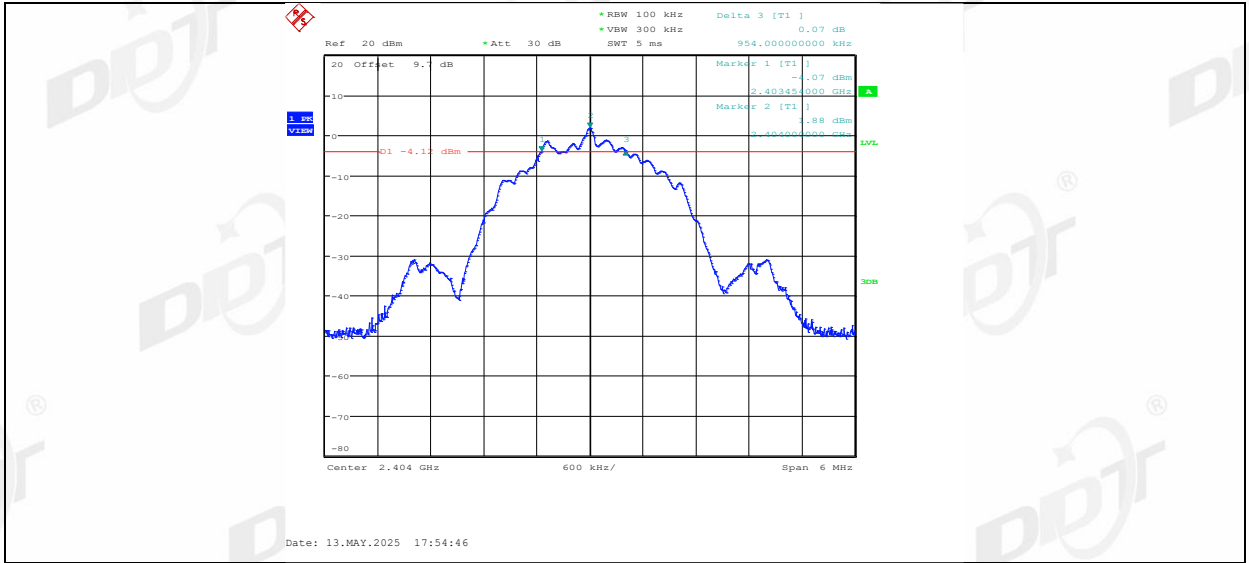

BLE 2M Ant1 2440

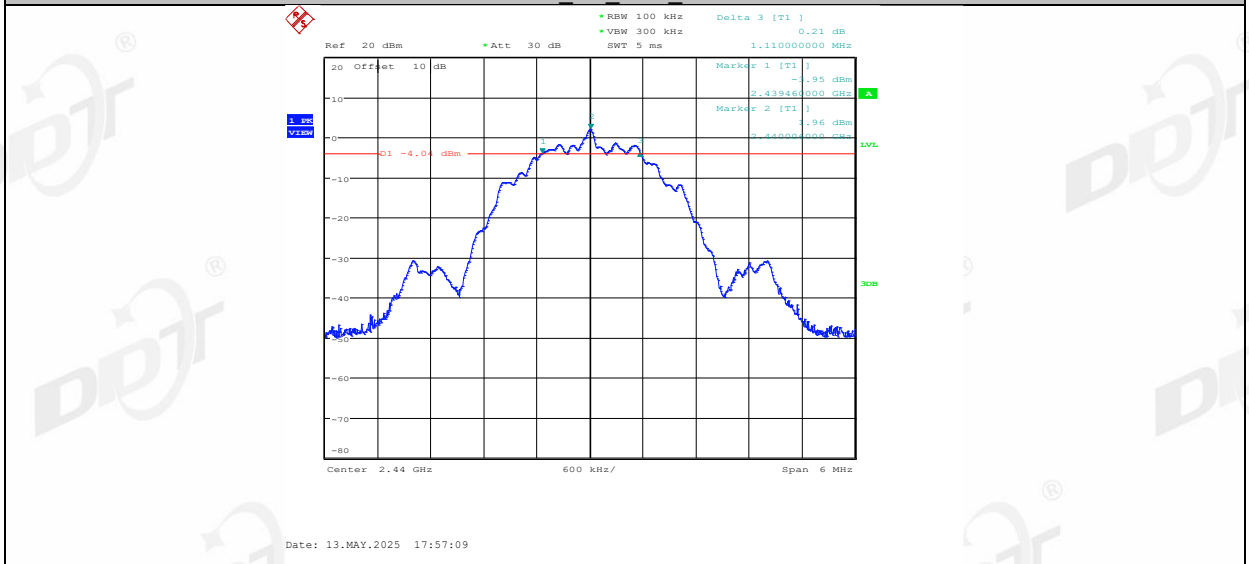

BLE 2M Ant1 2478

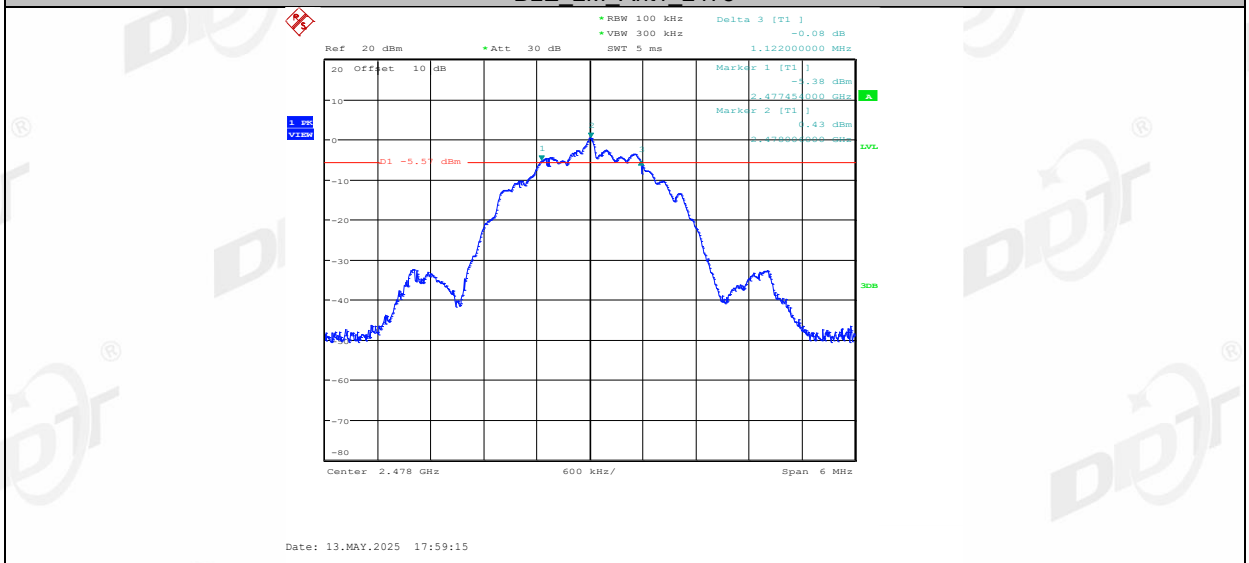

5. 99% Bandwidth

5.1. Block diagram of test setup

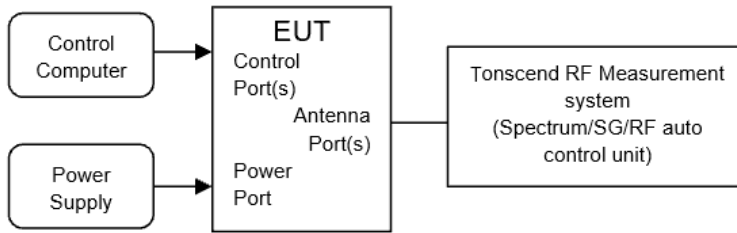

5.2. Limits

Just for Report.

5.3. Test procedure

- (1) The test according to ANSI C63.10-2013 clause 6.9.3.
- (2) Connect EUT's antenna output to spectrum analyzer by RF cable, the path loss was compensated to the results
- (3) Set the EUT as maximum power setting and enable the EUT transmit continuously
- (4) Use the following spectrum analyzer settings for the 99% Bandwidth:

RBW:	1% to 5% of the OBW
VBW:	approximately three times RBW
Span:	between 1.5 times and 5.0 times the OBW
Detector Mode:	Peak
Sweep time:	Auto
Trace mode	Max hold
- (5) Allow the trace to stabilize, measure the 99% bandwidth of signal, and record the results in the report.

5.4. Test result

Test Engineer:	Zora Zhang	Test Site:	RF Measurement System 1#
Ambient Condition:	24.9°C,52%RH	Test Date:	2025.05.13
Test Power Supply:	Battery	Sample Number:	S25042425-018

Test Mode	Antenna	Frequency [MHz]	OCB [MHz]	FL[MHz]	FH[MHz]	Limit [MHz]	Verdict
BLE_1M	Ant1	2402	1.024	2401.4960	2402.5200	---	---
		2440	1.028	2439.4920	2440.5200	---	---
		2480	1.032	2479.4880	2480.5200	---	---
BLE_2M	Ant1	2404	2.07	2402.9920	2405.0620	---	---
		2440	2.052	2438.9980	2441.0500	---	---
		2478	2.07	2476.9920	2479.0620	---	---

5.5. Test graphs

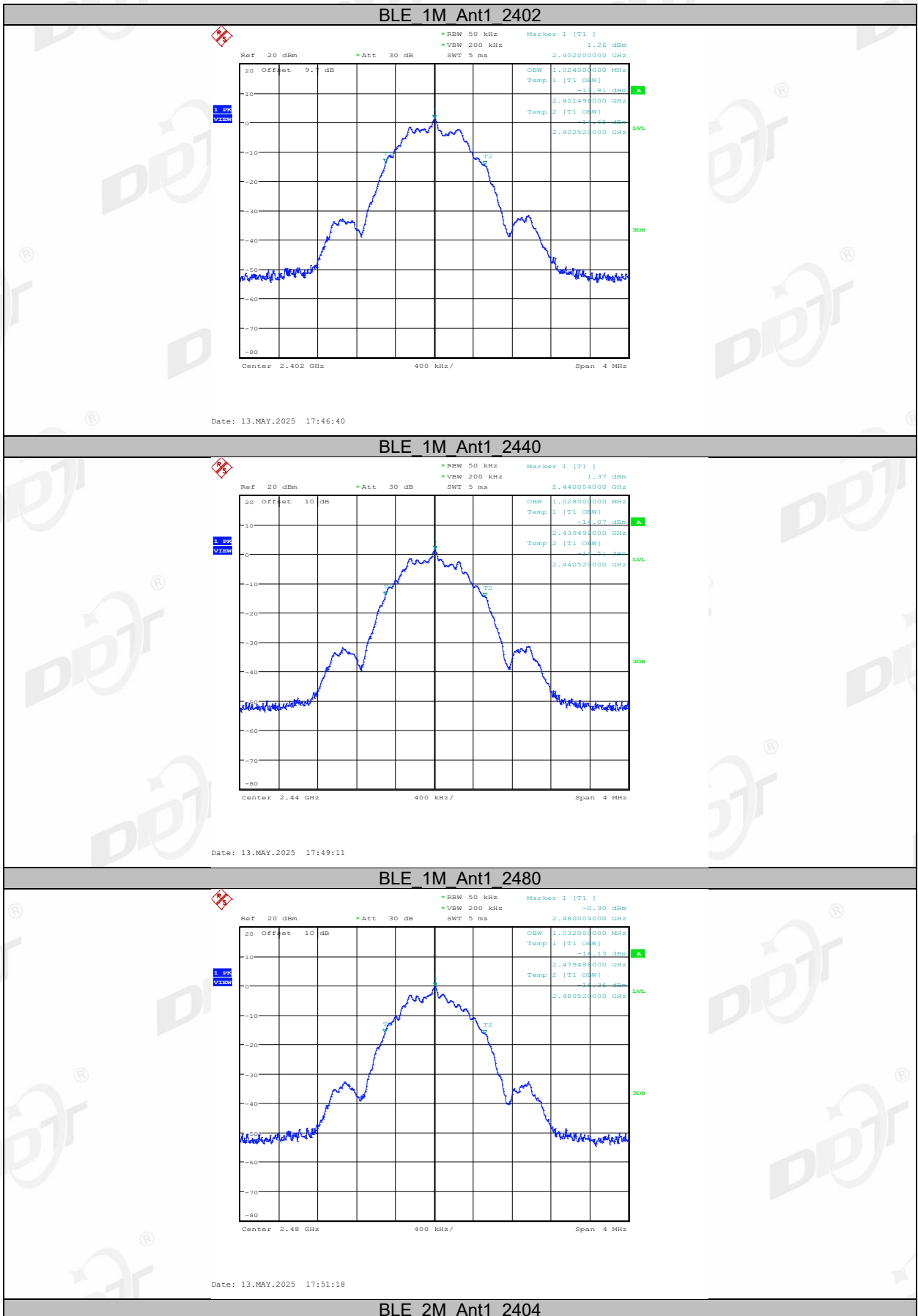

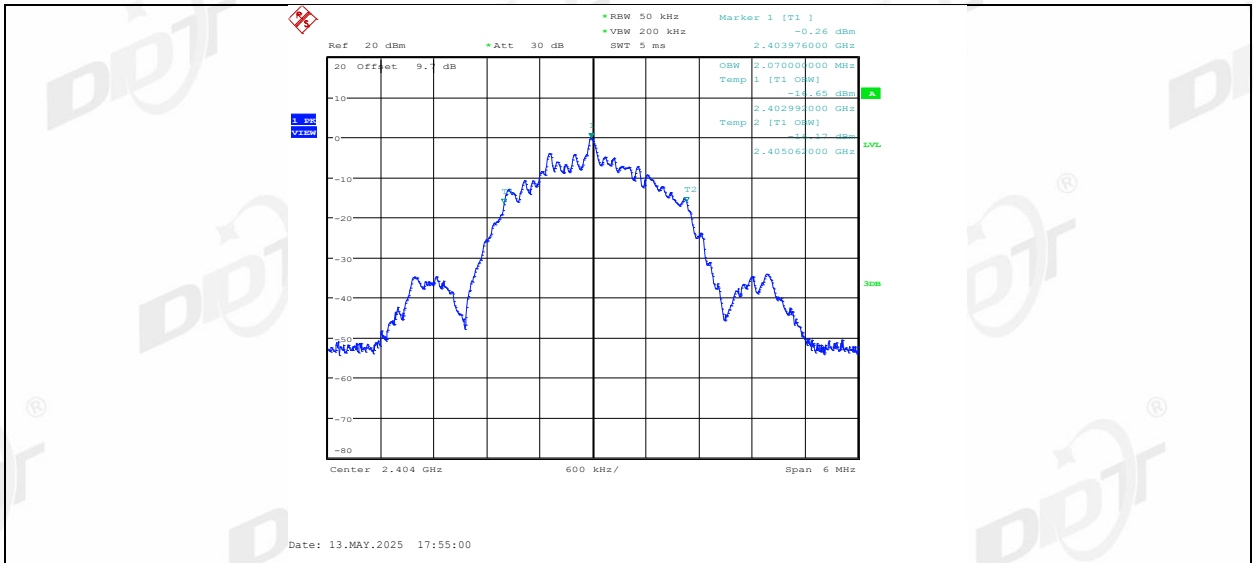

BLE_2M Ant1_2440

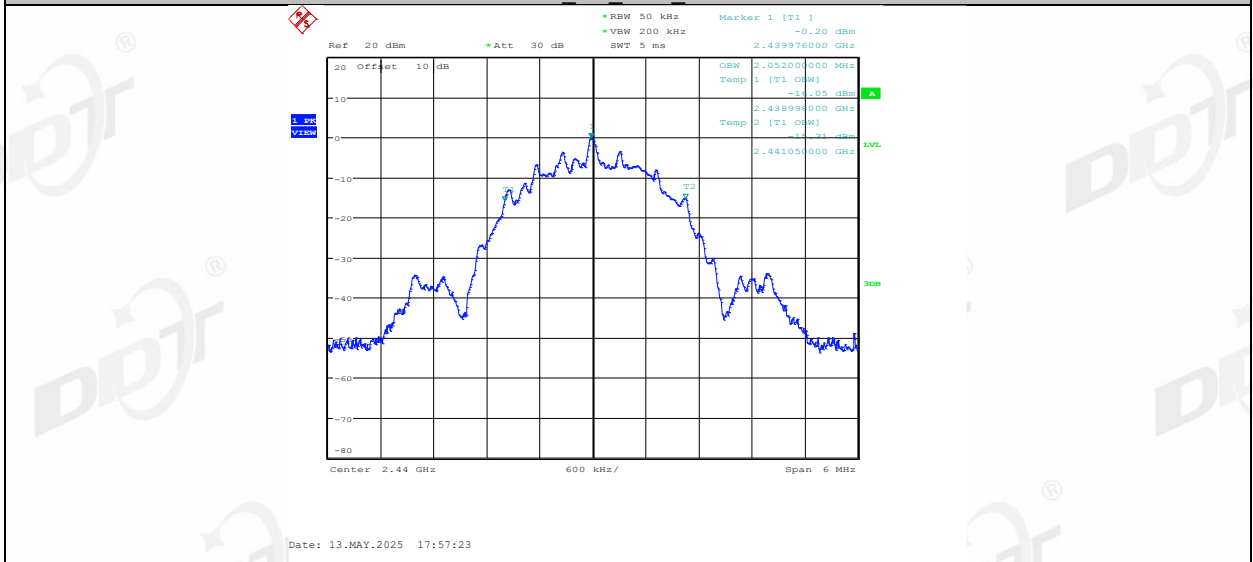

BLE_2M Ant1_2478

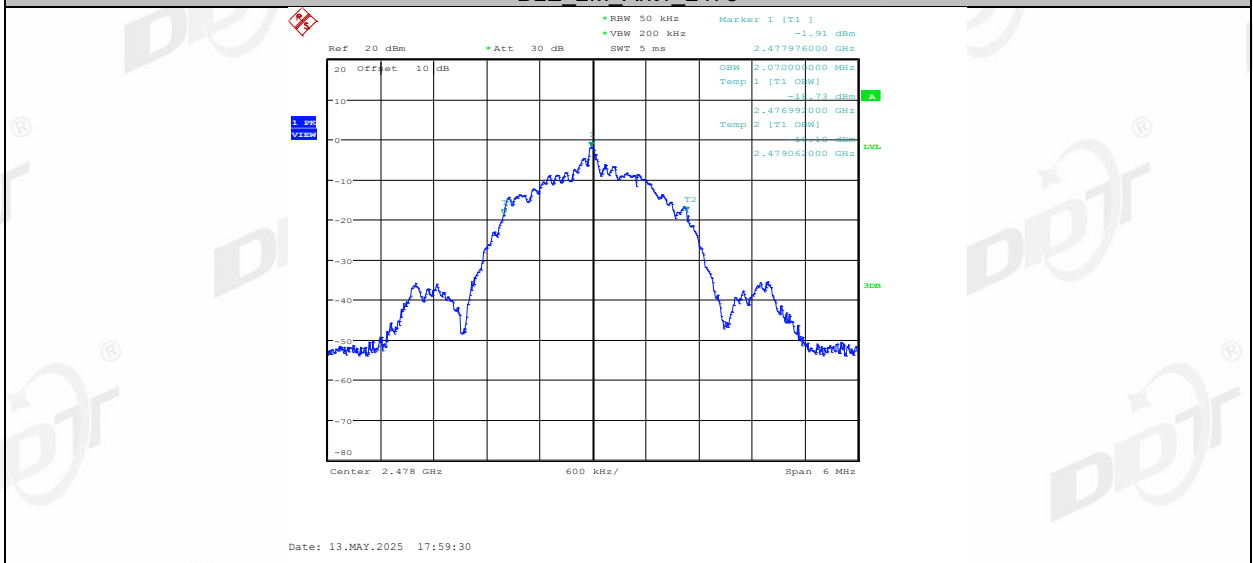

6. Maximum Peak Output Power

6.1. Block diagram of test setup

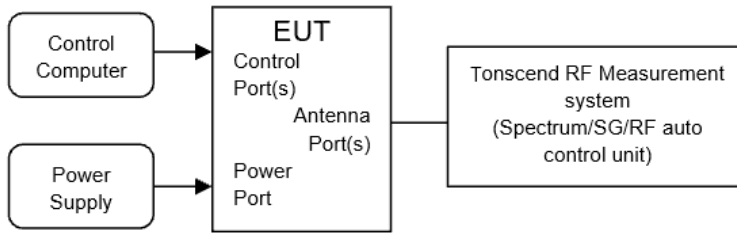

6.2. Limits

For systems using digital modulation in the 902-928 MHz, 2400-2483.5 MHz, and 5725-5850 MHz bands: 1 Watt. If transmitting antennas of directional gain greater than 6dBi are used, the conducted output power from the intentional radiator shall be reduced below the stated values as appropriate, by the amount in dB that the directional gain of the antenna exceeds 6 dBi, the e.i.r.p shall not exceed 4W.

6.3. Test procedure

- (1) The test according to ANSI C63.10-2013 clause 11.9.1.1.
- (2) Connect EUT's antenna output to spectrum analyzer by RF cable, the path loss was compensated to the results.
- (3) Set the EUT as maximum power setting and enable the EUT transmit continuously.
- (4) Use the following spectrum analyzer settings for the maximum peak output power measurement:

RBW:	≥DTS bandwidth
VBW:	≥3 x RBW
Span	≥3 x RBW
Detector Mode:	Peak
Sweep time:	Auto
Trace mode	Max hold
- (5) Allow the trace to stabilize, use peak marker function to determine the peak amplitude level.

6.4. Test result

Test Engineer:	Zora Zhang	Test Site:	RF Measurement System 1#
Ambient Condition:	24.9°C,52%RH	Test Date:	2025.05.13
Test Power Supply:	Battery	Sample Number:	S25042425-018

Test Mode	Antenna	Frequency [MHz]	Conducted Peak Power[dBm]	Conducted Limit[dBm]	EIRP[dBm]	EIRP Limit[dBm]	Verdict
BLE_1M	Ant1	2402	2.57	≤30	-4.23	≤36	PASS
		2440	2.69	≤30	-4.11	≤36	PASS
		2480	1.05	≤30	-5.75	≤36	PASS
BLE_2M	Ant1	2404	2.87	≤30	-3.93	≤36	PASS
		2440	2.89	≤30	-3.91	≤36	PASS
		2478	1.37	≤30	-5.43	≤36	PASS

6.5. Test graphs

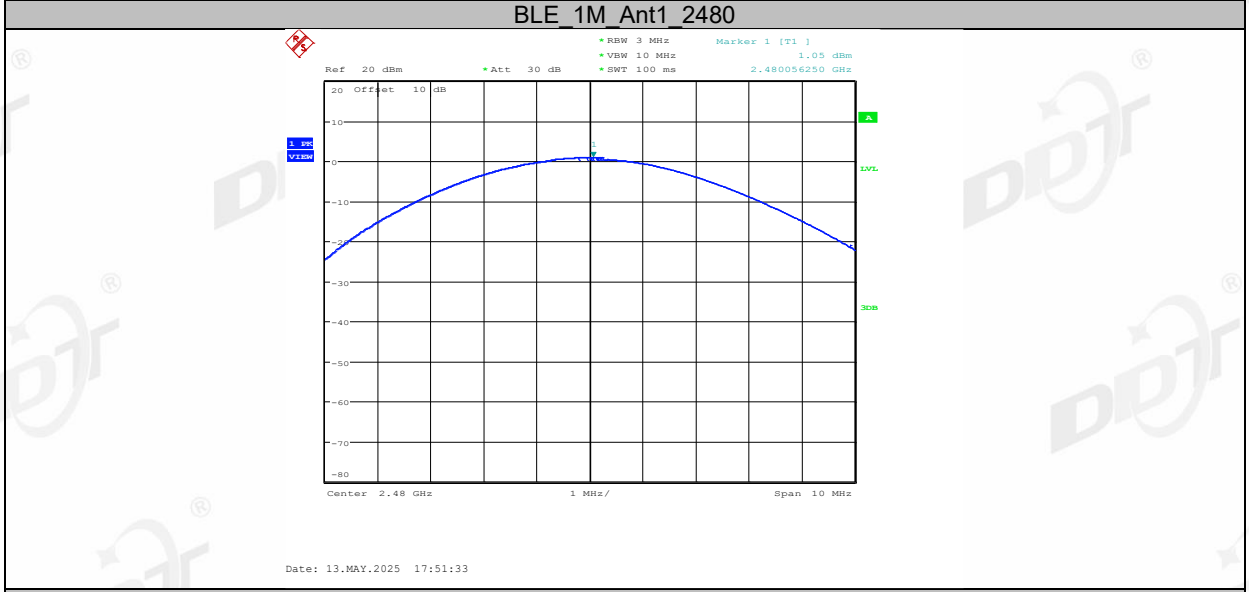
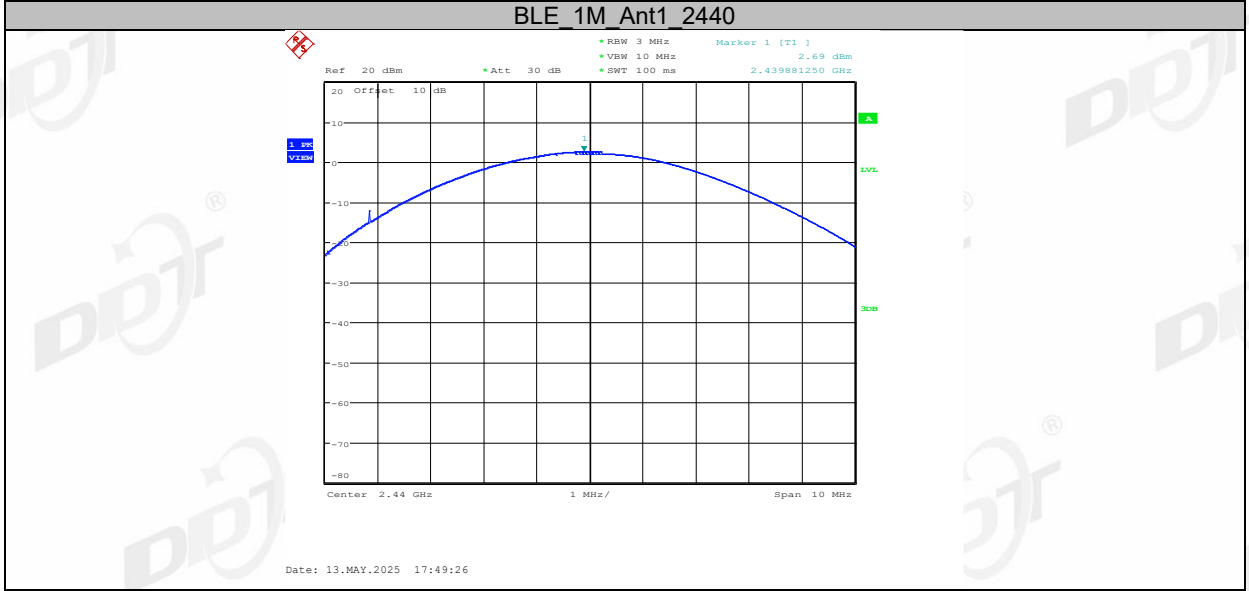
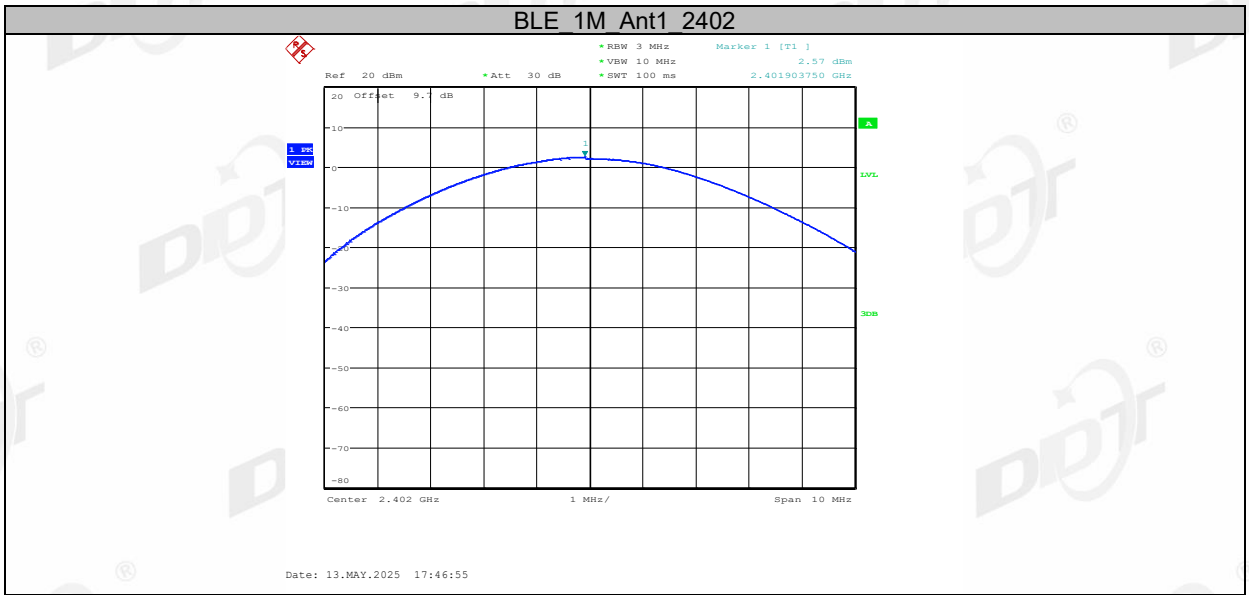

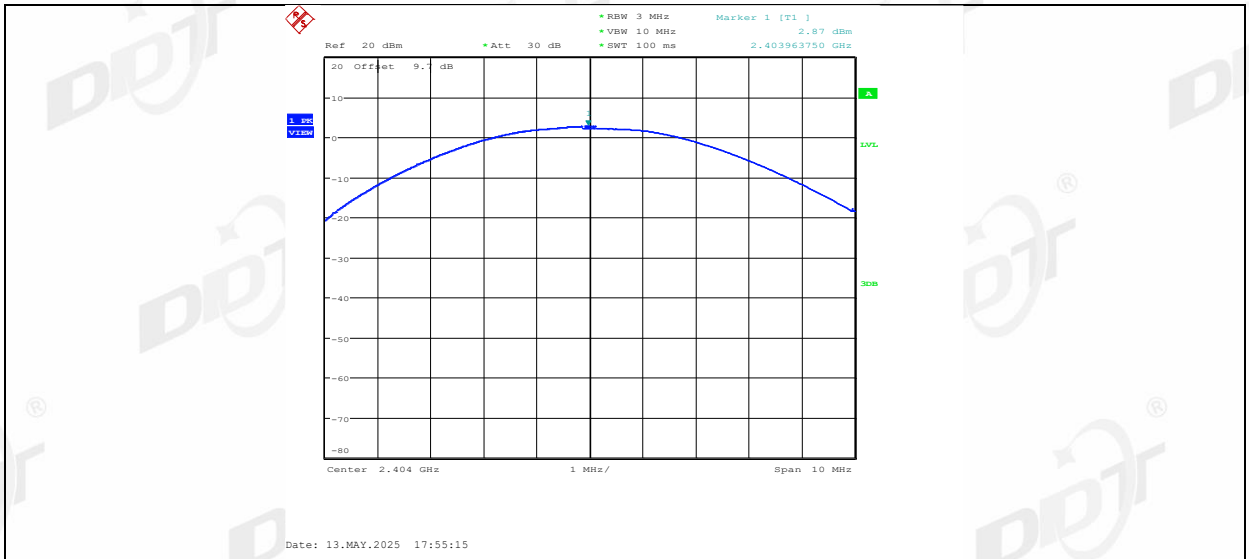

BLE 2M Ant1 2440

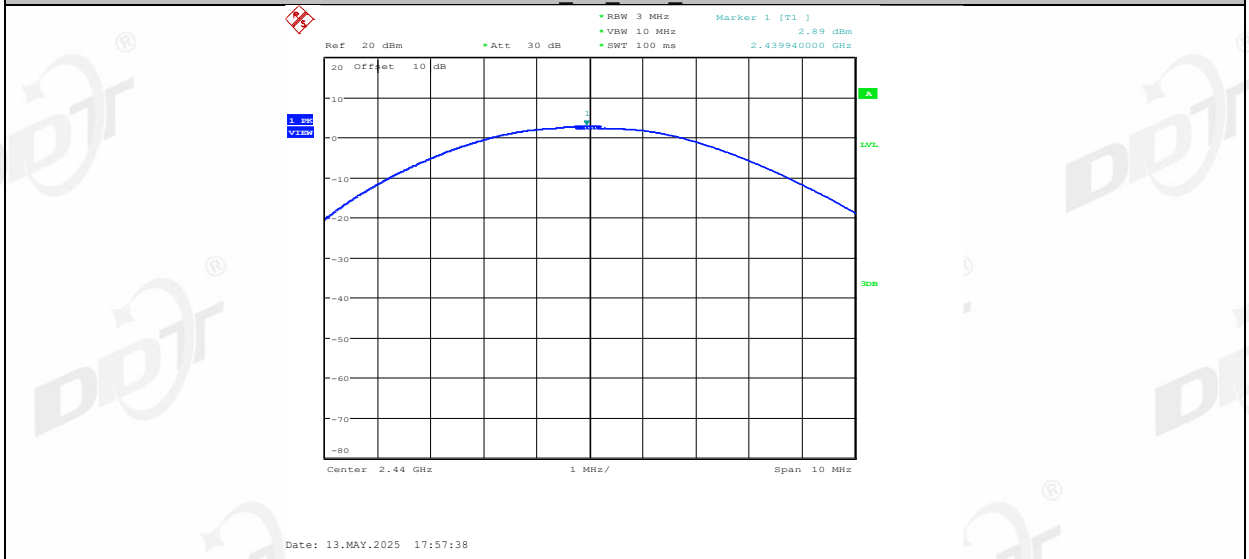

BLE 2M Ant1 2478

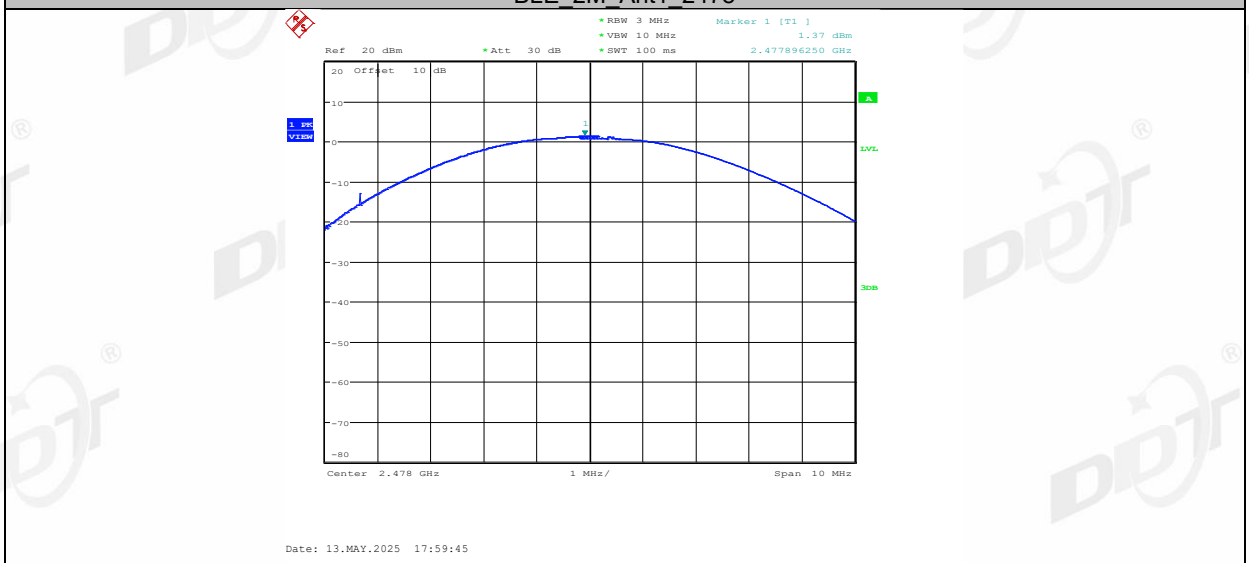

7. Power Spectral Density

7.1. Block diagram of test setup

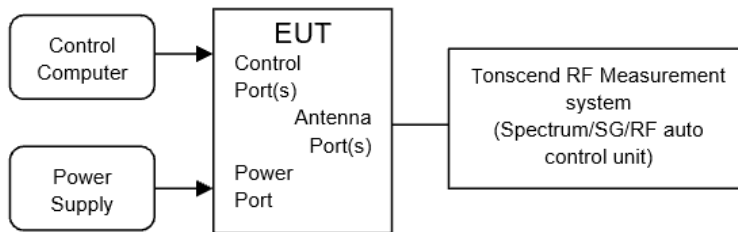

7.2. Limits

For digitally modulated systems, the power spectral density conducted from the intentional radiator to the antenna shall not be greater than 8 dBm in any 3 kHz band during any time interval of continuous transmission.

7.3. Test procedure

- (1) The test according to ANSI C63.10-2013 clause 11.10.2.
 - (2) Connect EUT's antenna output to spectrum analyzer by RF cable, the path loss was compensated to the results.
 - (3) Set the EUT as maximum power setting and enable the EUT transmit continuously.
 - (4) Use the following spectrum analyzer settings for Power Spectral Density measurement:

Center frequency	DTS Channel center frequency
RBW:	$3 \text{ kHz} \leq \text{RBW} \leq 100 \text{ kHz}$
VBW:	$\geq 3\text{RBW}$
Span	1.5 times the DTS bandwidth
Detector Mode:	Peak
Sweep time:	Auto
Trace mode	Max hold
 - (5) Allow the trace to stabilize, use the peak marker function to determine the maximum amplitude level within the RBW.
- If measured value exceeds limit, reduce RBW (no less than 3 kHz) and repeat.

7.4. Test result

Test Engineer:	Zora Zhang	Test Site:	RF Measurement System 1#
Ambient Condition:	24.9°C,52%RH	Test Date:	2025.05.13
Test Power Supply:	Battery	Sample Number:	S25042425-018

Test Mode	Antenna	Frequency [MHz]	Result [dBm/3kHz]	Limit [dBm/3kHz]	Verdict
BLE_1M	Ant1	2402	-13.35	≤8.00	PASS
		2440	-13.53	≤8.00	PASS
		2480	-15.24	≤8.00	PASS
BLE_2M	Ant1	2404	-15.89	≤8.00	PASS
		2440	-15.27	≤8.00	PASS
		2478	-18.19	≤8.00	PASS

7.5. Test graphs

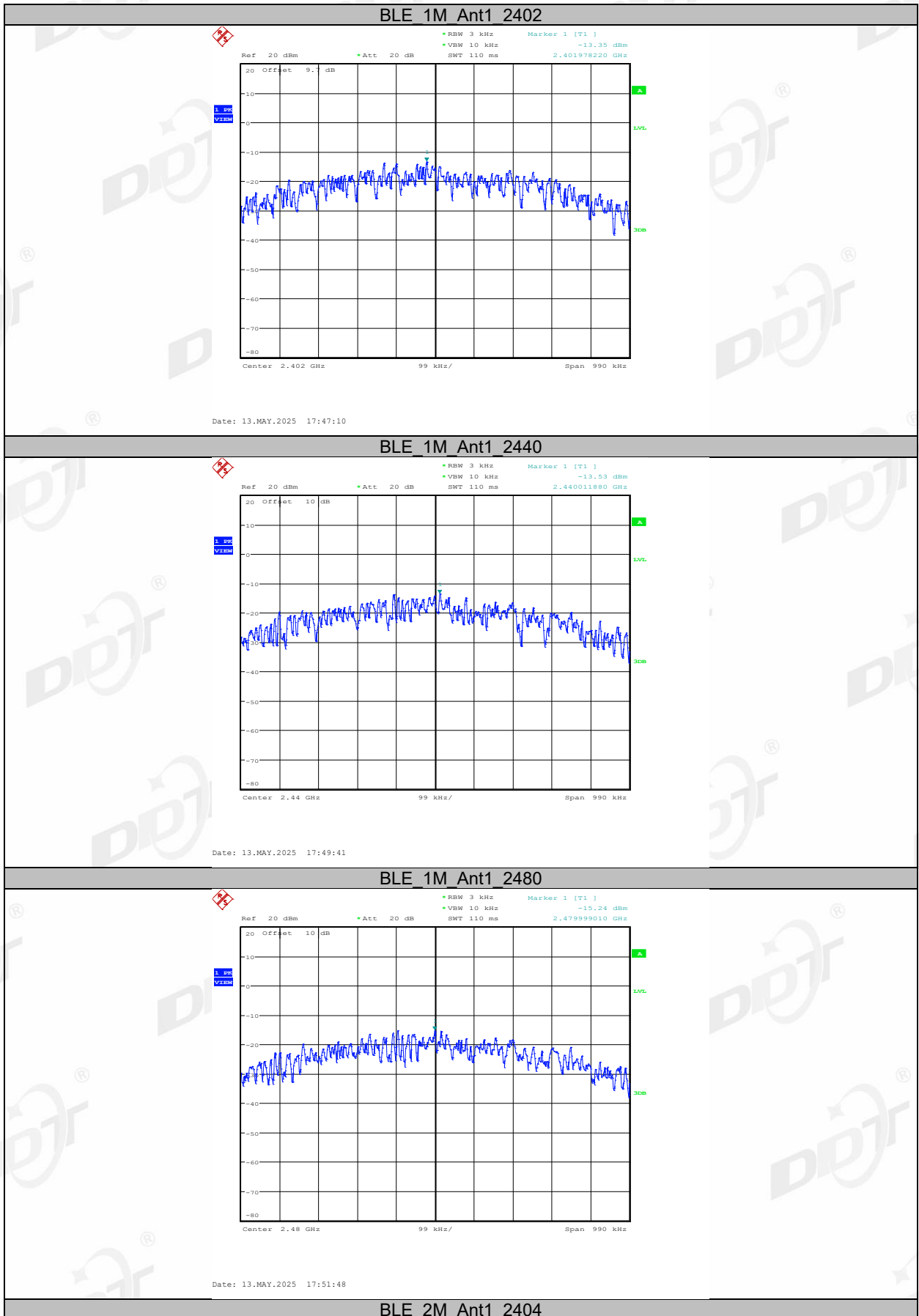

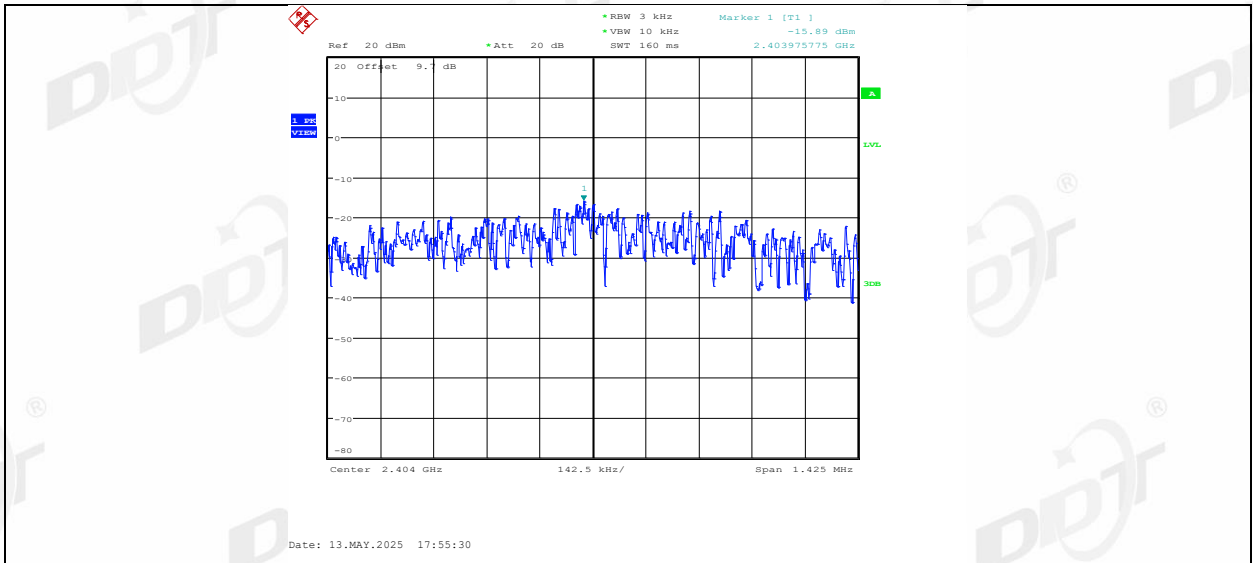

BLE_2M_Ant1_2440

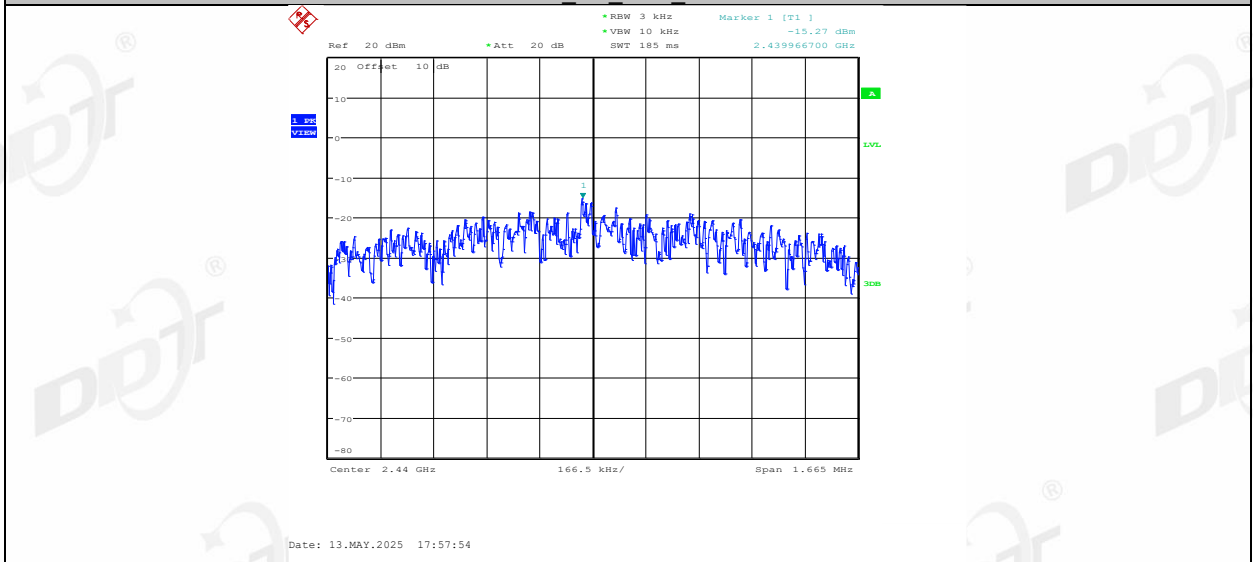

BLE_2M_Ant1_2478

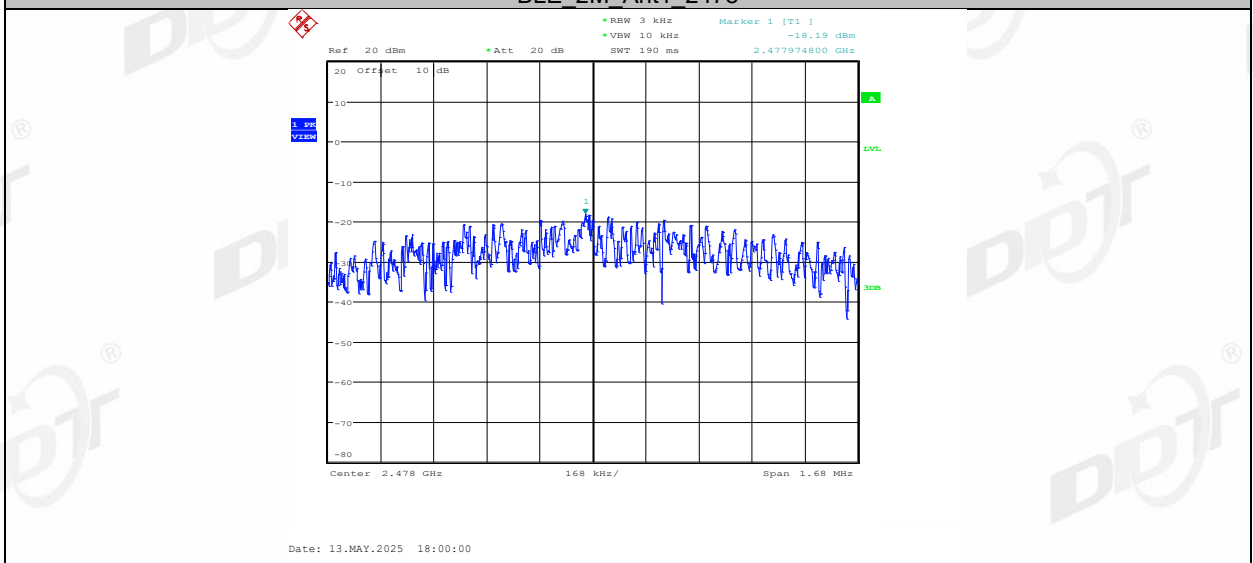

8. Band Edge Compliance (Conducted Method)

8.1. Block diagram of test setup

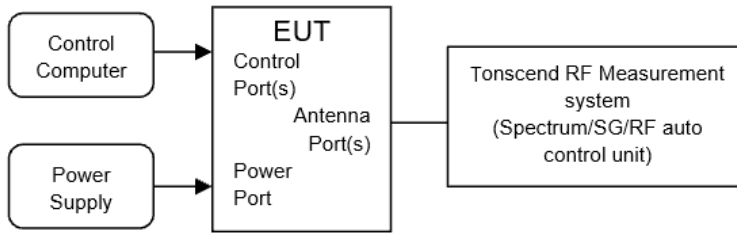

8.2. Limits

In any 100 kHz bandwidth outside the frequency bands in which the spread spectrum intentional radiator is operating, the radio frequency power that is produced by the intentional radiator shall be at least 20 dB below that in the 100 kHz bandwidth within the band that contains the highest level of the desired power.

8.3. Test procedure

- (1) Connect EUT's antenna output to spectrum analyzer by RF cable.
- (2) Establish a reference level by using the following procedure:

RBW:	100 kHz
VBW:	300 kHz
Span	Encompass frequency range to be measured
Detector Mode:	Peak
Sweep time:	Auto
Trace mode	Max hold

- (3) Allow the trace to stabilize, use the peak marker function to determine the maximum peak power level to establish the reference level.
- (4) Then mark the maximum amplitude of all unwanted emissions outside of the authorized frequency band.

8.4. Test result

Test Engineer:	Zora Zhang	Test Site:	RF Measurement System 1#
Ambient Condition:	24.9°C,52%RH	Test Date:	2025.05.13
Test Power Supply:	Battery	Sample Number:	S25042425-018

Mode	Frequency [MHz]	Measured Range	Verdict
GFSK 1M	2402	2.310 GHz - 2.410 GHz	Pass
	2480	2.470 GHz - 2.500 GHz	Pass
GFSK 2M	2404	2.310 GHz - 2.410 GHz	Pass
	2478	2.470 GHz - 2.500 GHz	Pass

8.5. Test graphs

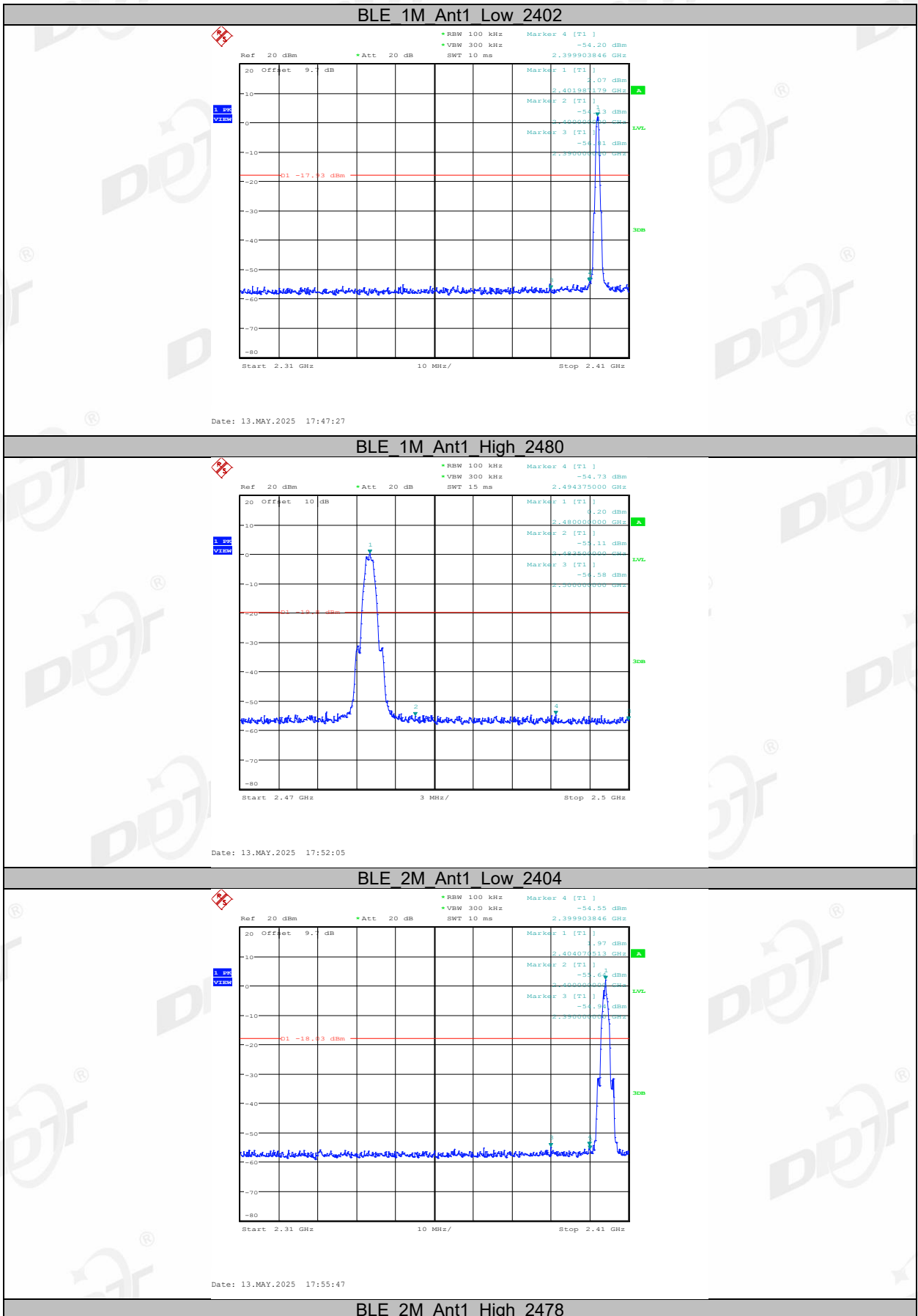

9. RF Conducted Spurious Emissions

9.1. Block diagram of test setup

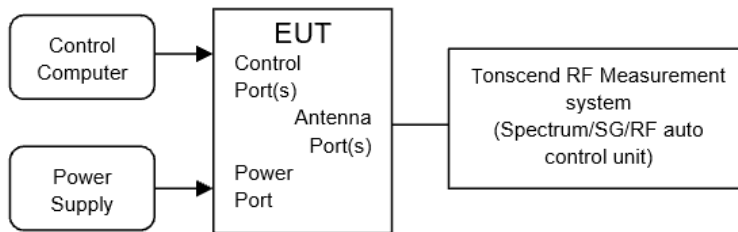

9.2. Limits

In any 100 kHz bandwidth outside the frequency bands in which the spread spectrum intentional radiator is operating, the radio frequency power that is produced by the intentional radiator shall be at least 20 dB below that in the 100 kHz bandwidth within the band that contains the highest level of the desired power.

9.3. Test procedure

- (1) Connect EUT's antenna output to spectrum analyzer by RF cable.
- (2) Establish a reference level by using the following procedure:

Center frequency	Test frequency
RBW:	100 kHz
VBW:	300 kHz
Span	Wide enough to capture the peak level of the in-band emission
Detector Mode:	Peak
Sweep time:	Auto
Trace mode	Max hold

- (3) Allow the trace to stabilize, use the peak marker function to determine the maximum peak power level to establish the reference level.

- (4) Set the spectrum analyzer as follows:

RBW:	100 kHz
VBW:	300 kHz
Span	Encompass frequency range to be measured
Number of measurement points	$\geq \text{Span/RBW}$
Detector Mode:	Peak
Sweep time:	Auto
Trace mode	Max hold

Allow the trace to stabilize, use the peak marker function to determine the maximum amplitude of all unwanted emissions outside of the authorized frequency band

9.4. Test result

Test Engineer:	Zora Zhang	Test Site:	RF Measurement System 1#
Ambient Condition:	24.9°C,52%RH	Test Date:	2025.05.13
Test Power Supply:	Battery	Sample Number:	S25042425-018

Mode	Frequency [MHz]	Verdict
GFSK 1M	2402	Pass
	2440	Pass
	2480	Pass
GFSK 2M	2404	Pass
	2440	Pass
	2478	Pass

9.5. Test graphs

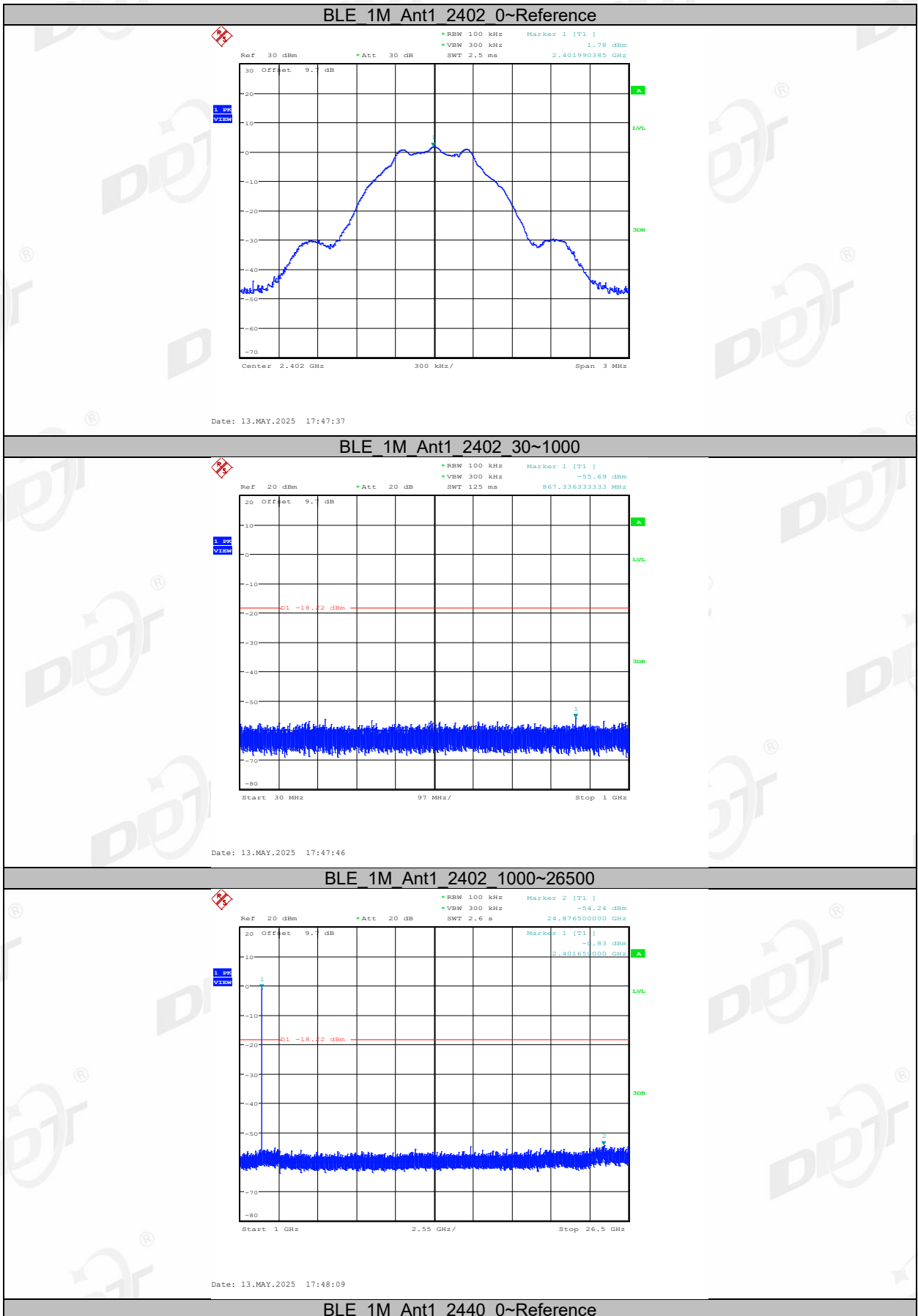

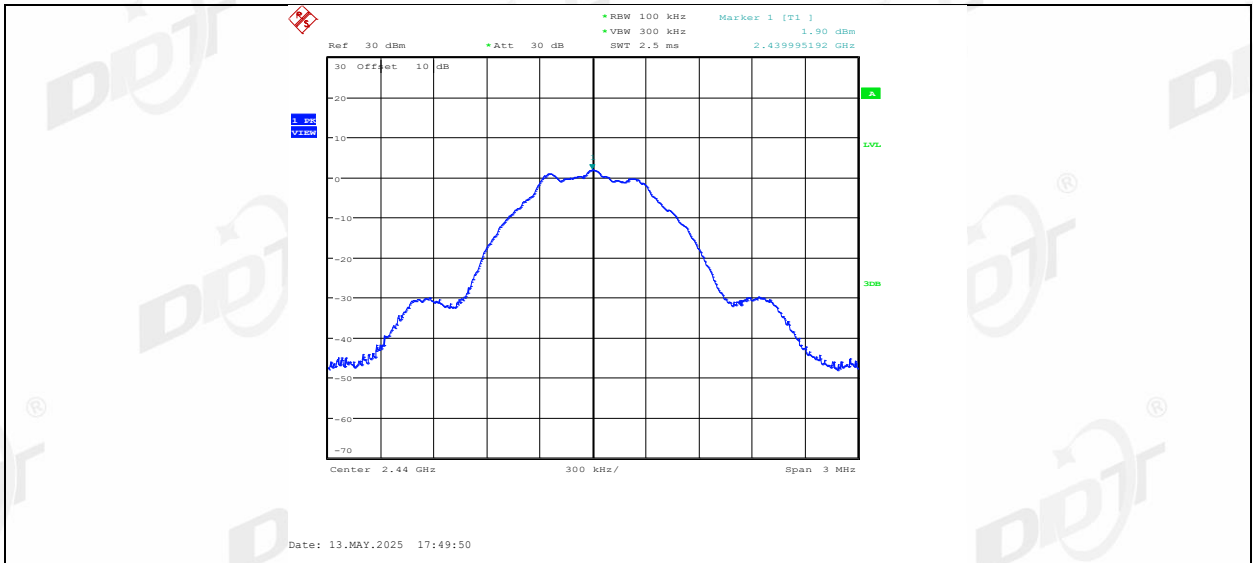

BLE_1M_Ant1_2440_30~1000

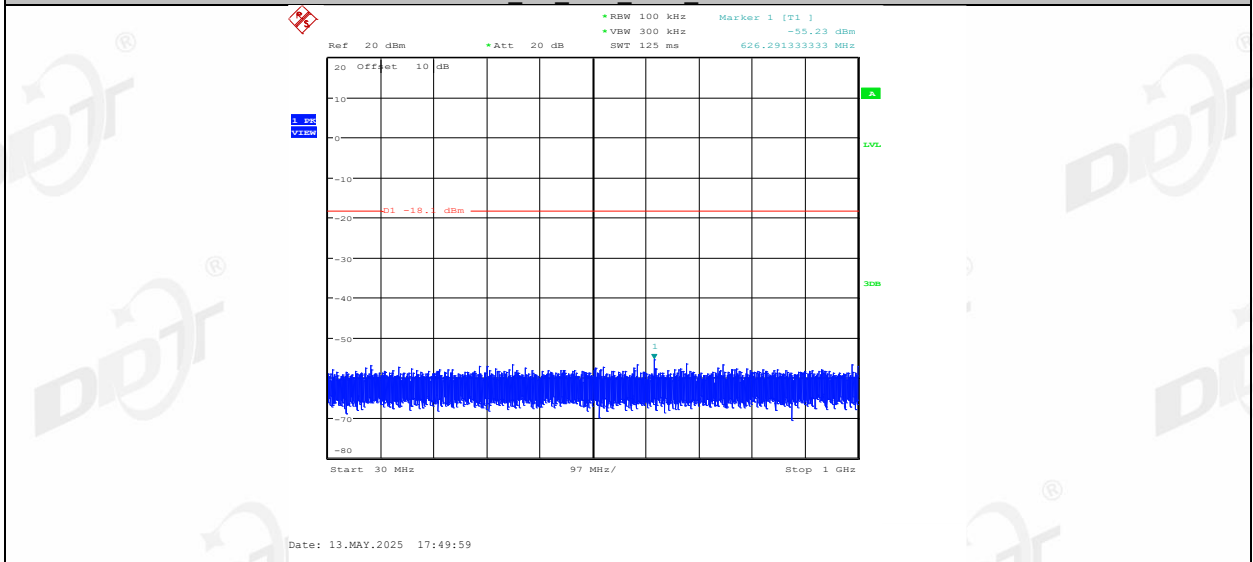

BLE_1M_Ant1_2440_1000~26500

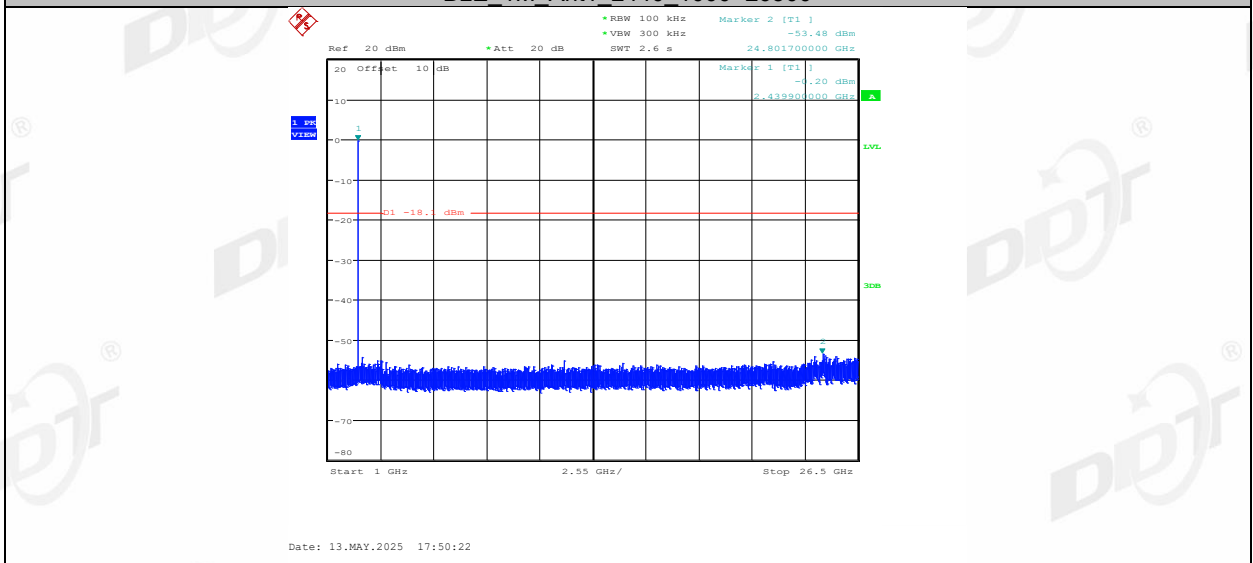

BLE_1M_Ant1_2480_0-Reference

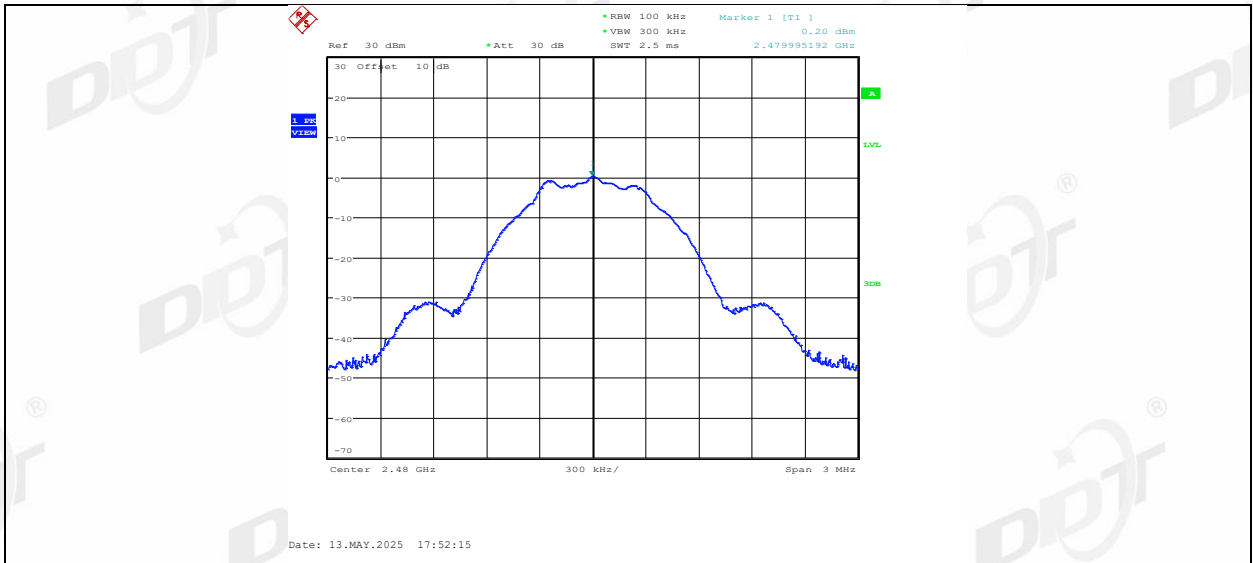

BLE 1M Ant1 2480 30~1000

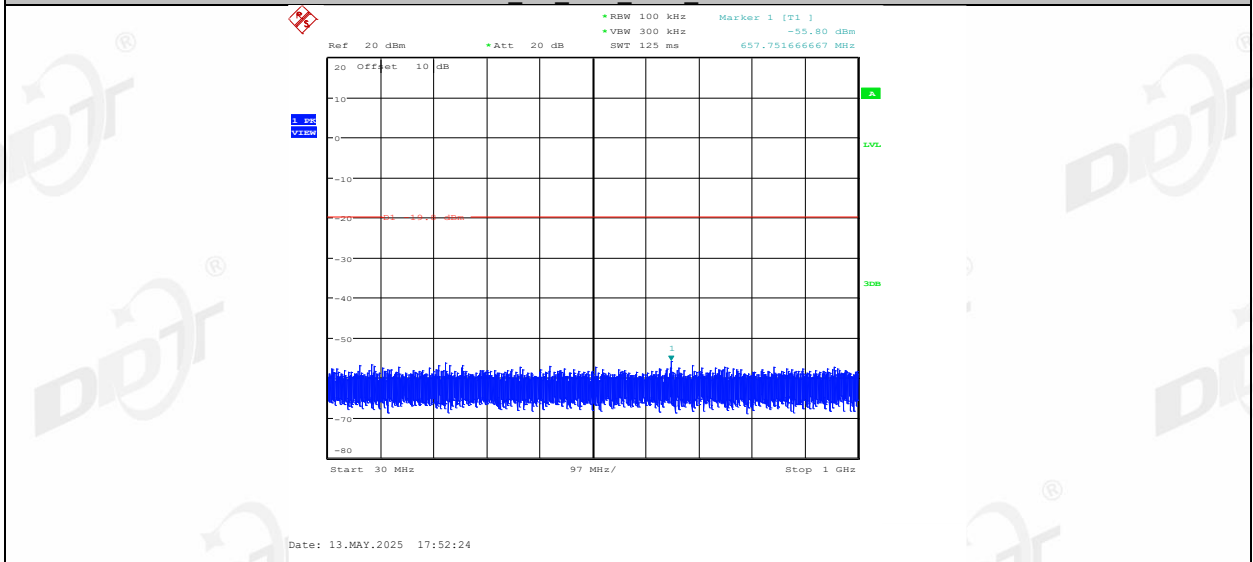

BLE 1M Ant1 2480 1000~26500

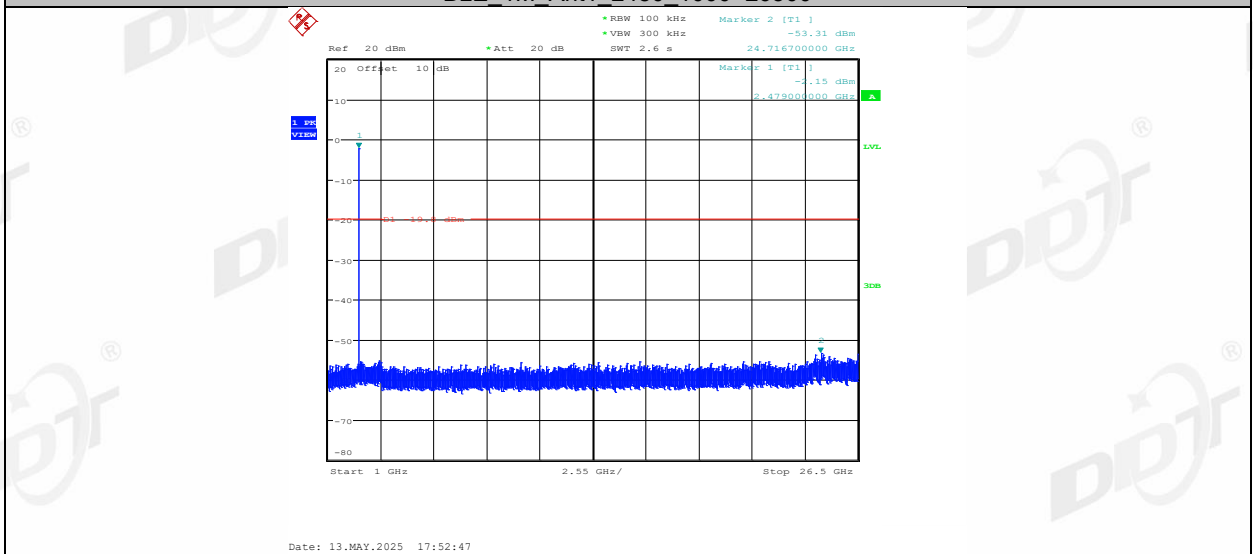

BLE 2M Ant1 2404 0~Reference

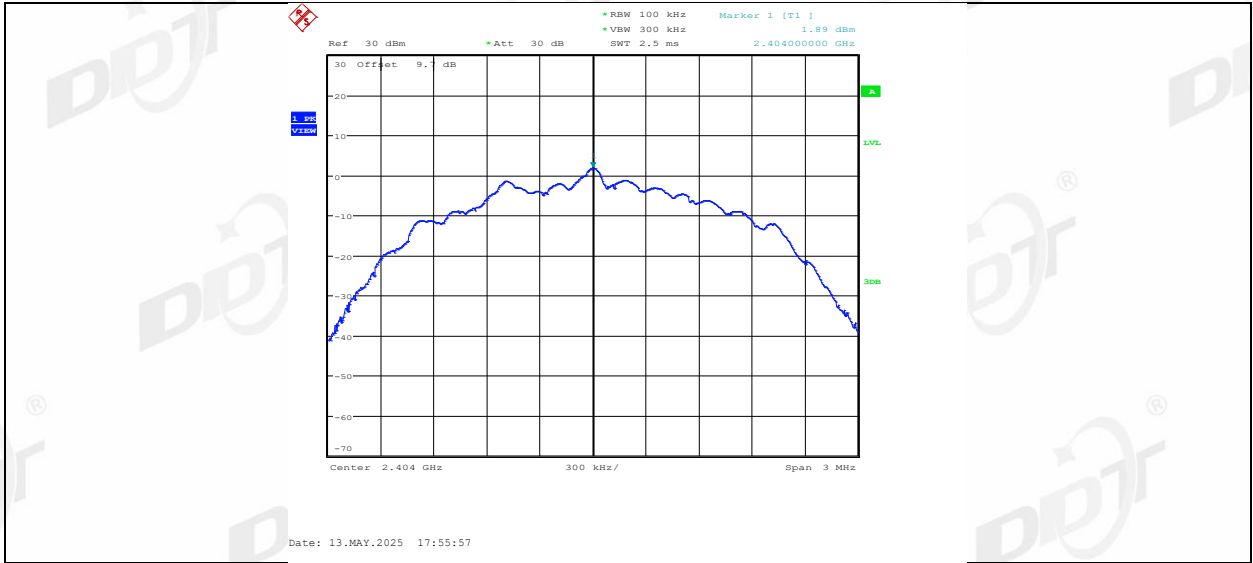

BLE_2M_Ant1_2404_30~1000

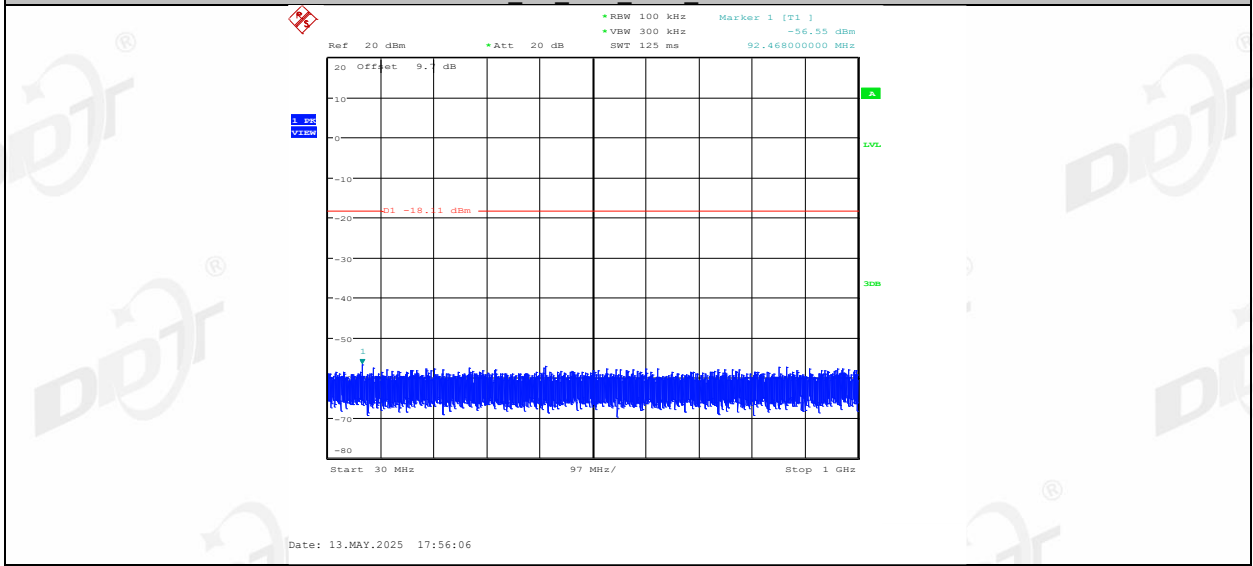

BLE_2M_Ant1_2404_1000~26500

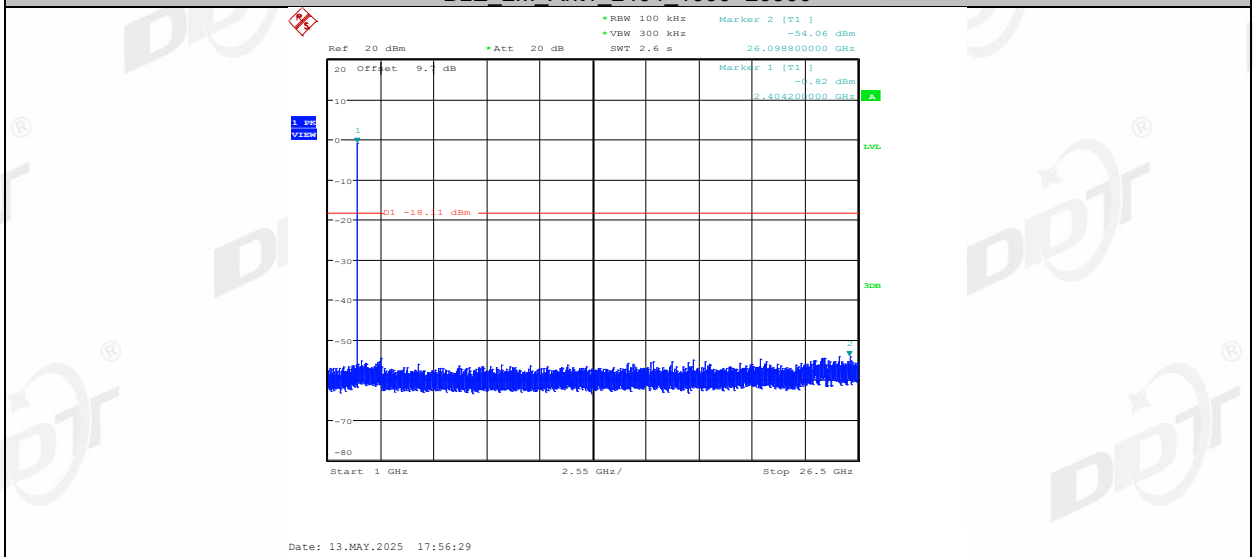

BLE_2M_Ant1_2440_0~Reference

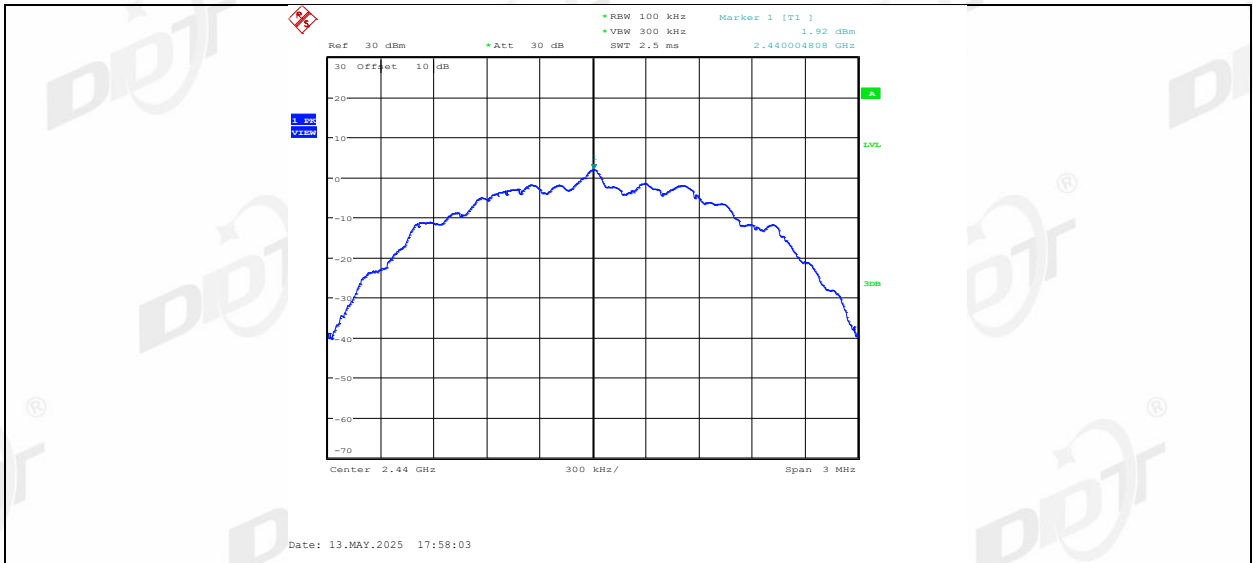

BLE 2M Ant1 2440 30~1000

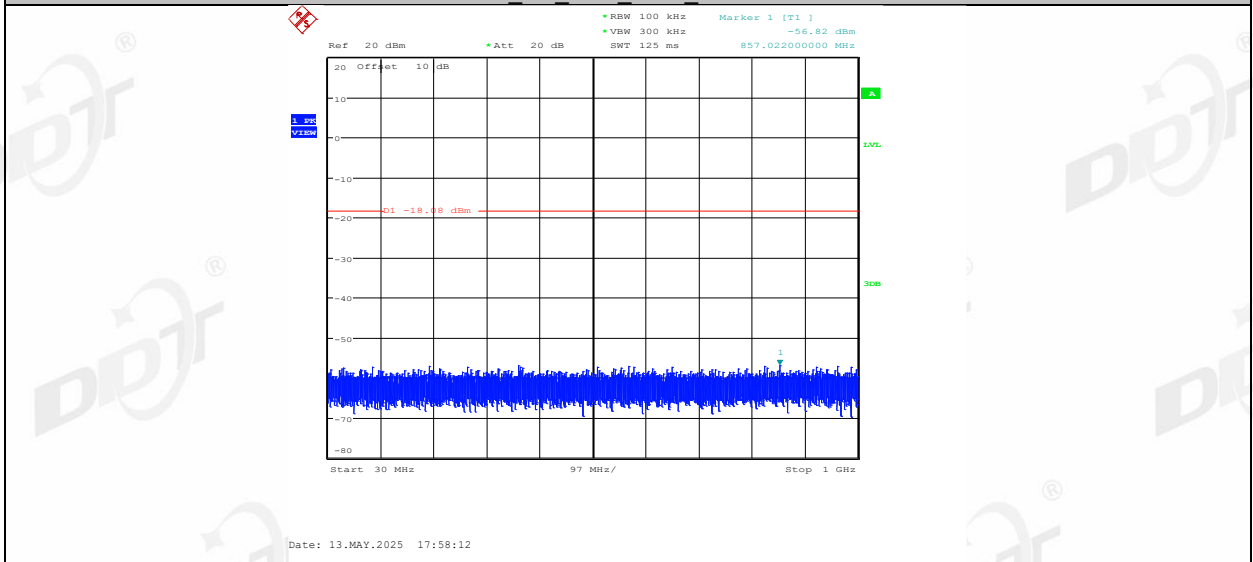

BLE 2M Ant1 2440 1000~26500

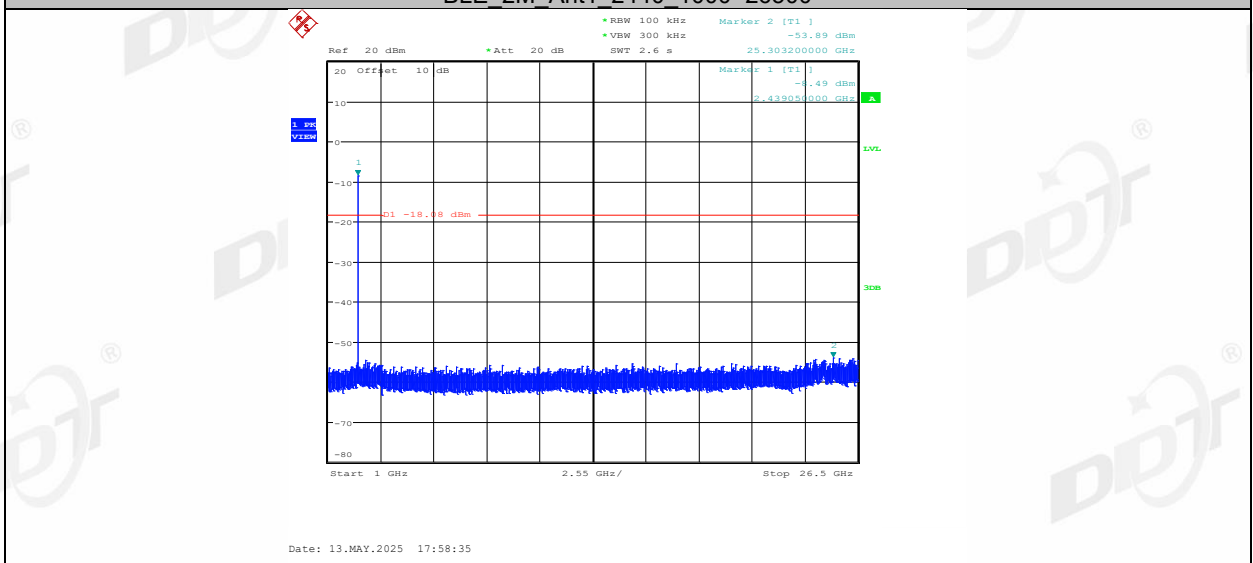

BLE 2M Ant1 2478 0~Reference

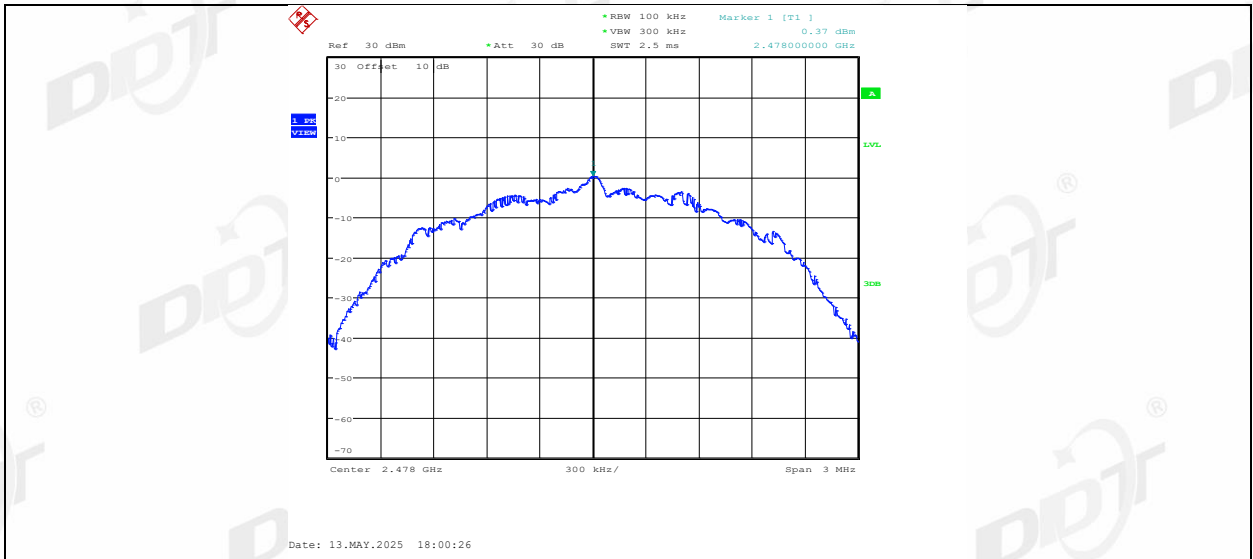

BLE_2M Ant1 2478 30~1000

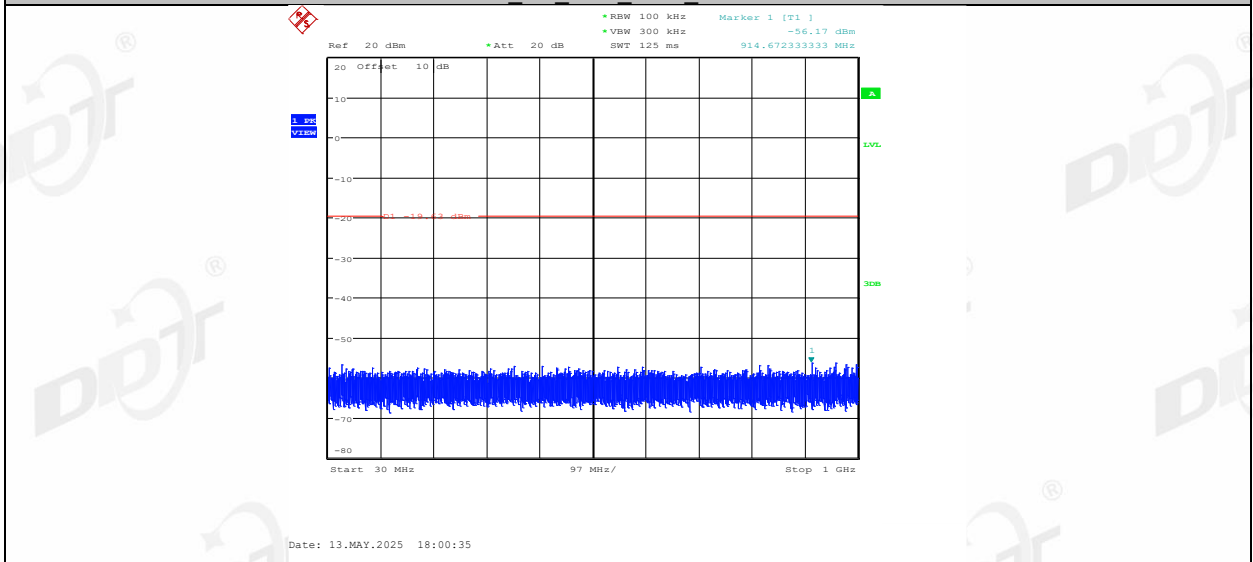

BLE_2M Ant1 2478 1000~26500

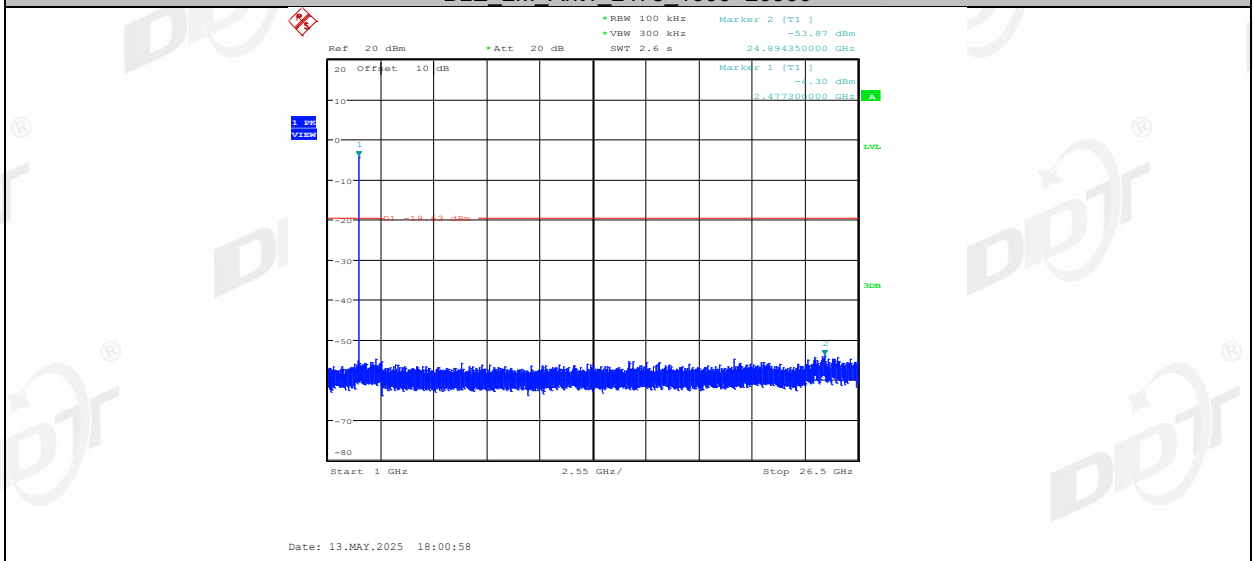

10. Duty Cycle

10.1. Block diagram of test setup

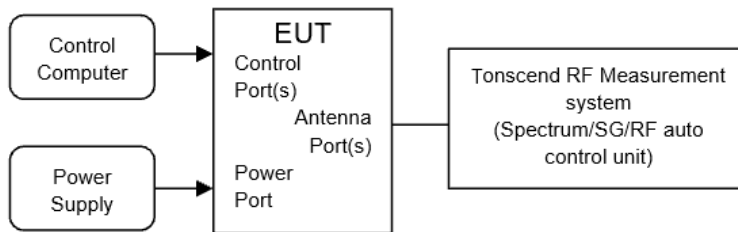

10.2. Limit

Just for Report.

10.3. Test procedure

- (1) Connected the EUT's antenna port to the Spectrum Analyzer by suitable attenuator, The cable loss and attenuator loss have been put into spectrum analyzer as amplitude offset. set the Spectrum Analyzer as below:
 - Centre Frequency: The centre frequency of the middle hopping channel.
 - Resolution BW: 10 MHz.
 - Video BW: 10 MHz.
 - Span: Zero span.
 - Detector: Peak.
 - Trace Mode: Clear Write.
 - Sweep: Video Trigger
- (2) When the trace is complete, measure the sending time of 1 burst and the duty cycle of 1 burst cycle.
- (3) Calculate dwell time follow below formula:
Duty cycle= Pulse's on time / Burst cycle

10.4. Test result

Test Engineer:	Zora Zhang	Test Site:	RF Measurement System 1#
Ambient Condition:	24.9°C,52%RH	Test Date:	2025.05.13
Test Power Supply:	Battery	Sample Number:	S25042425-018

Test Mode	Antenna	Frequency [MHz]	ON Time [ms]	Period [ms]	Duty Cycle [%]	Duty Cycle Factor[dB]
BLE_1M	Ant1	2402	0.40	0.63	63.49	1.97
		2440	0.40	0.63	63.49	1.97
		2480	0.40	0.63	63.49	1.97
BLE_2M	Ant1	2404	0.21	0.63	33.33	4.77
		2440	0.21	0.63	33.33	4.77
		2478	0.21	0.63	33.33	4.77

10.5. Test graphs

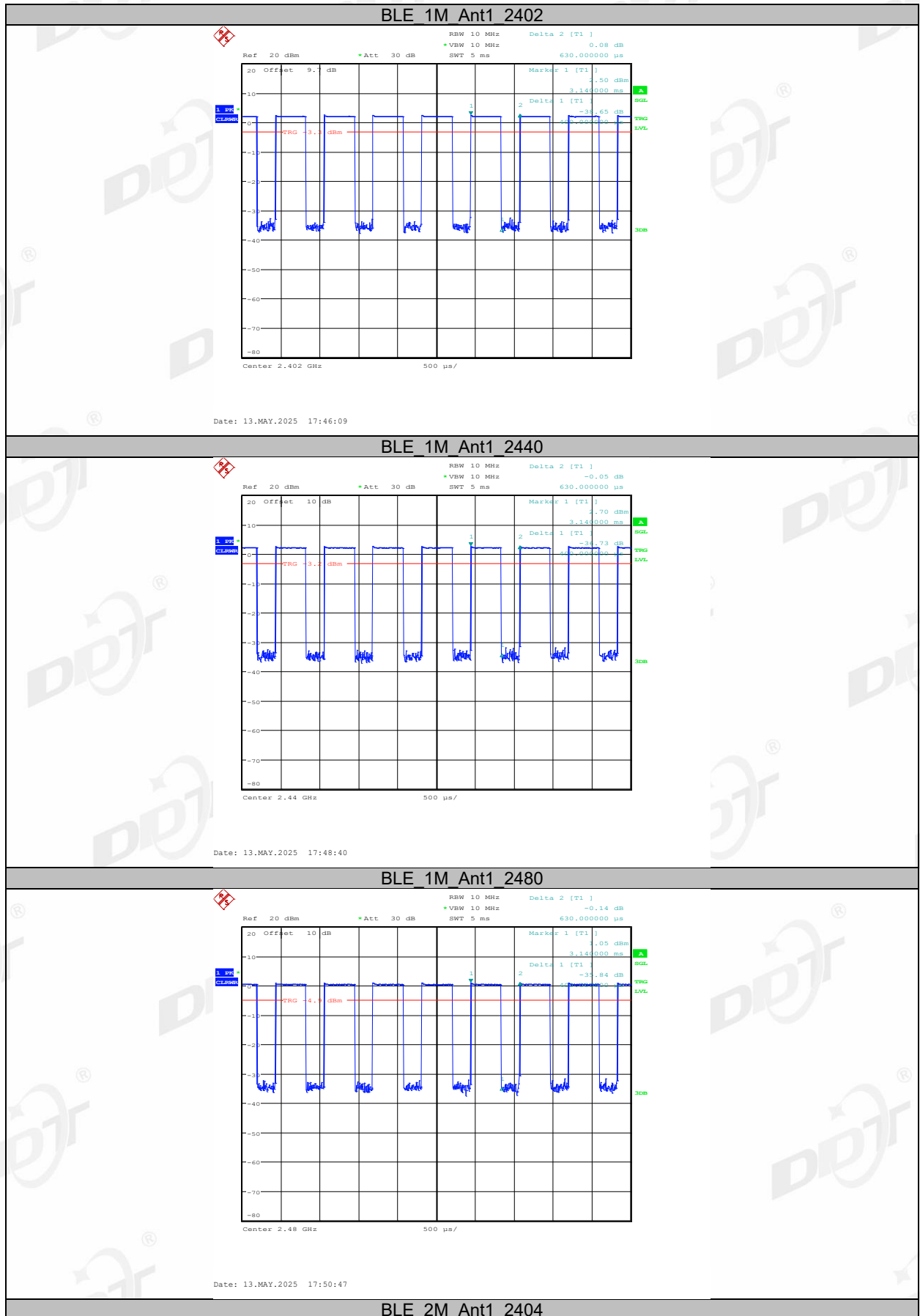

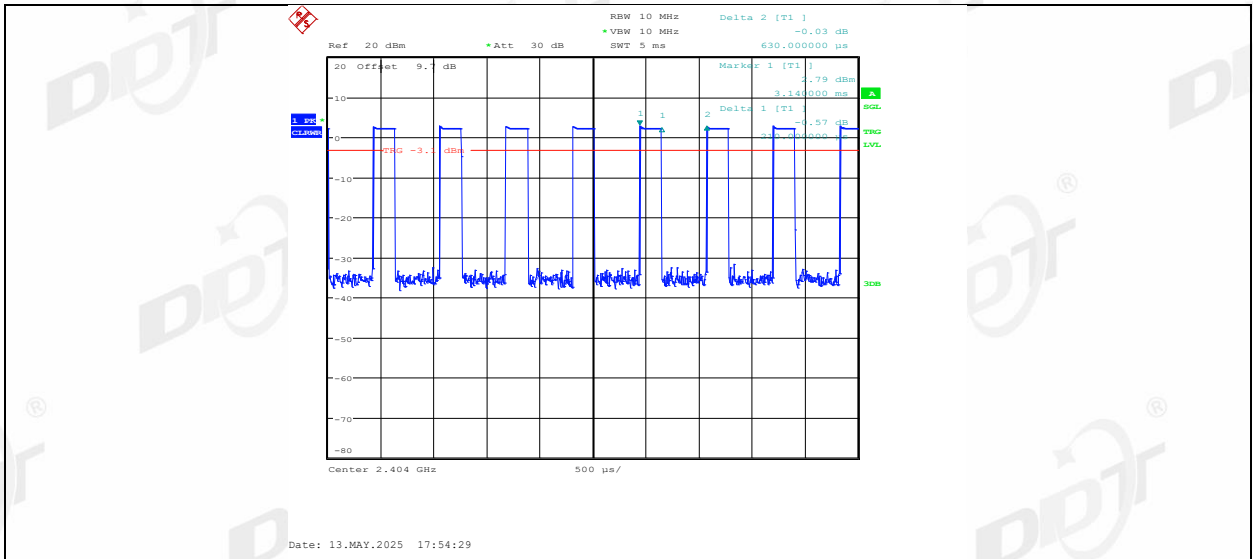

BLE_2M Ant1_2440

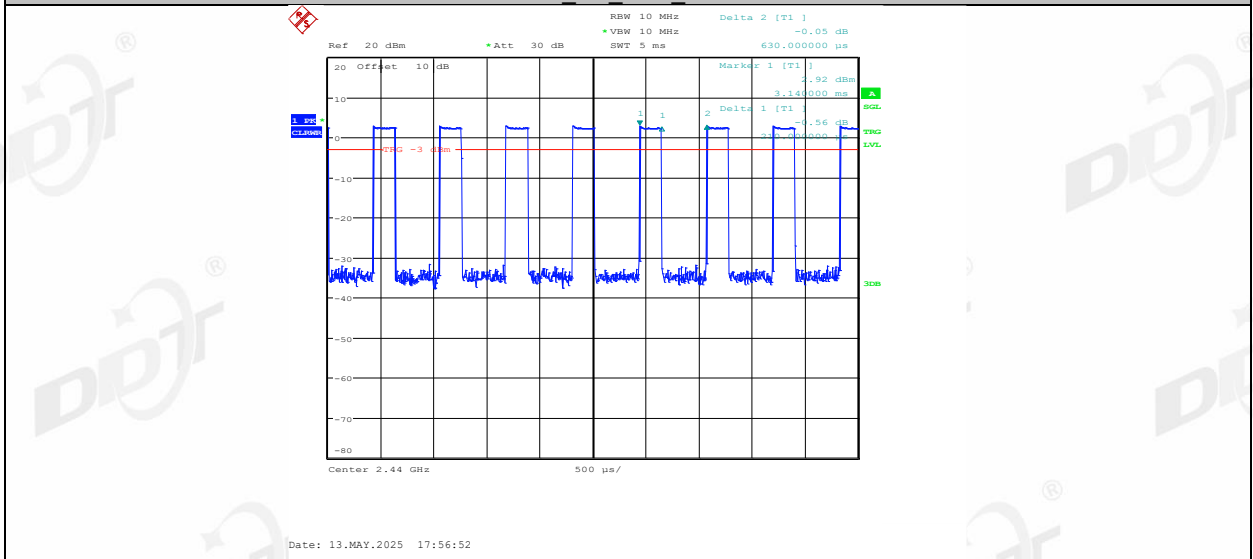

BLE_2M Ant1_2478

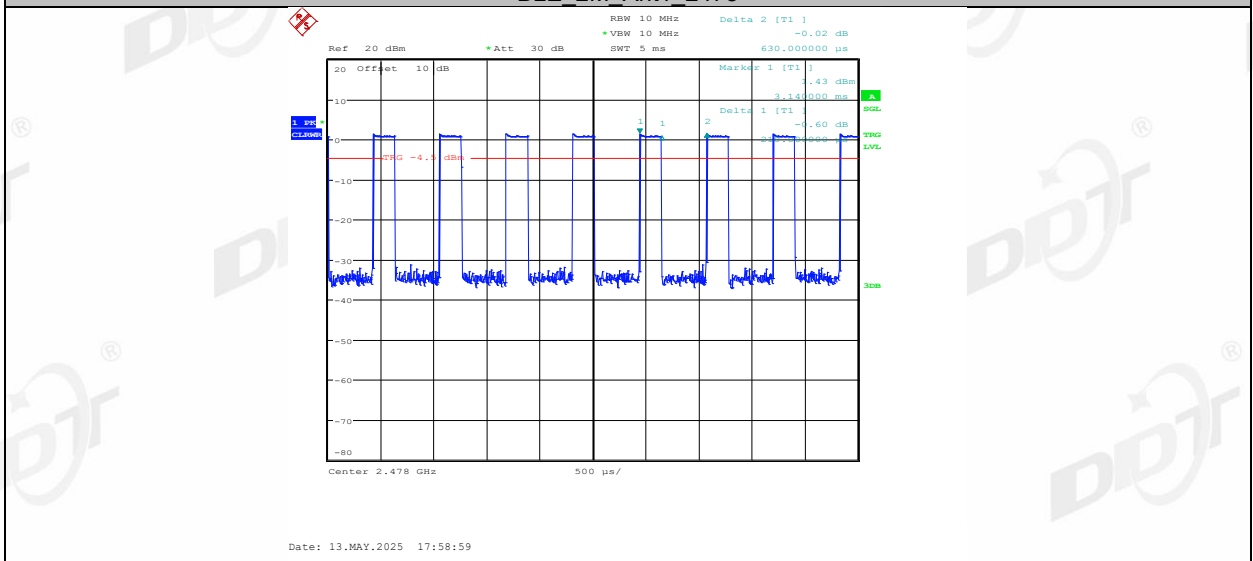

11. Antenna Requirements

11.1. Limit

For intentional device, according to FCC 47 CFR Section 15.203, an intentional radiator shall be designed to ensure that no antenna other than that furnished by the responsible party shall be used with the device. And according to FCC 47 CFR Section 15.247 (b), if transmitting antennas of directional gain greater than 6 dBi are used, the power shall be reduced by the amount in dB that the directional gain of the antenna exceeds 6 dBi.

For intentional device, according to RSS-Gen issue 5 section 6.8.

The applicant for equipment certification shall provide a list of all antenna types that may be used with the transmitter, where applicable (i.e. for transmitters with detachable antenna), indicating the maximum permissible antenna gain (in dBi) and the required impedance for each antenna. The test report shall demonstrate the compliance of the transmitter with the limit for maximum equivalent isotropically radiated power (e.i.r.p.) specified in the applicable RSS, when the transmitter is equipped with any antenna type, selected from this list.

11.2. Result

The antenna used for this product as Antenna information described in section 2.1 of the report, and there is no other antenna than that furnished by the responsible party shall be used with the device.

12. Radiated Emission

12.1. Test equipment

Equipment	Manufacturer	Model No.	Serial No.	Cal Due To
RF cable	Yuhu Technology	JCTB810-NJ-NJ-9M	DDT-ZC02538	2026/03/28
High pass filter	Micro-Tronics	HPM50102	DDT-ZC00561	2026/03/28
Micro-Tronics filters	REBES	BRM50716	DDT-ZC03240	/
PSA Series Spectrum Analyzer	Agilent	E4447A	DDT-ZC00517	2026/03/28
High Pass filter	Xi'an Xingbo	XBLBQ-GTA67	DDT-ZC02179	2026/03/28
EMI TEST RECEIVER	R&S	ESU26	DDT-ZC01909	2026/03/28
RF Cable	N/A	W24.02 HL-562	DDT-ZC04022	2026/03/28
RF Cable	N/A	W13.02 AP1-X2	DDT-ZC04023	2026/03/28
High pass filter	Micro-Tronics	HPM50108	DDT-ZC00560	2026/03/28
Micro-Tronics filters	REBES	BRM50702	DDT-ZC03242	/
Broad-Band Horn Antenna	Schwarzbeck	BBHA 9170	DDT-ZC00506	2027/04/01
RF cable	Yuhu Technology	ZT26S-SMAJ-SMAJ-1M	DDT-ZC02037	2026/03/28
Pre-amplifier	COM-POWER	PAM-840A	DDT-ZC01693	2026/03/28
Pre-amplifier	COM-POWER	PAM-118A	DDT-ZC01293	2025/08/25
Active Loop Antenna	Schwarzbeck	FMZB1519	DDT-ZC00524	2025/09/11
Hochgewinn-Hornantenne	SCHWARZBEC K	BBHA 9120 D	DDT-ZC02129	2025/09/18
RF cable	Zhongke Junchuang	JCT26S-NJ-NJ-1.5M	DDT-ZC02762	2026/03/28
Trilog Broadband Antenna	Schwarzbeck	VULB 9163	DDT-ZC02050	2025/07/11

12.2. Block diagram of test setup

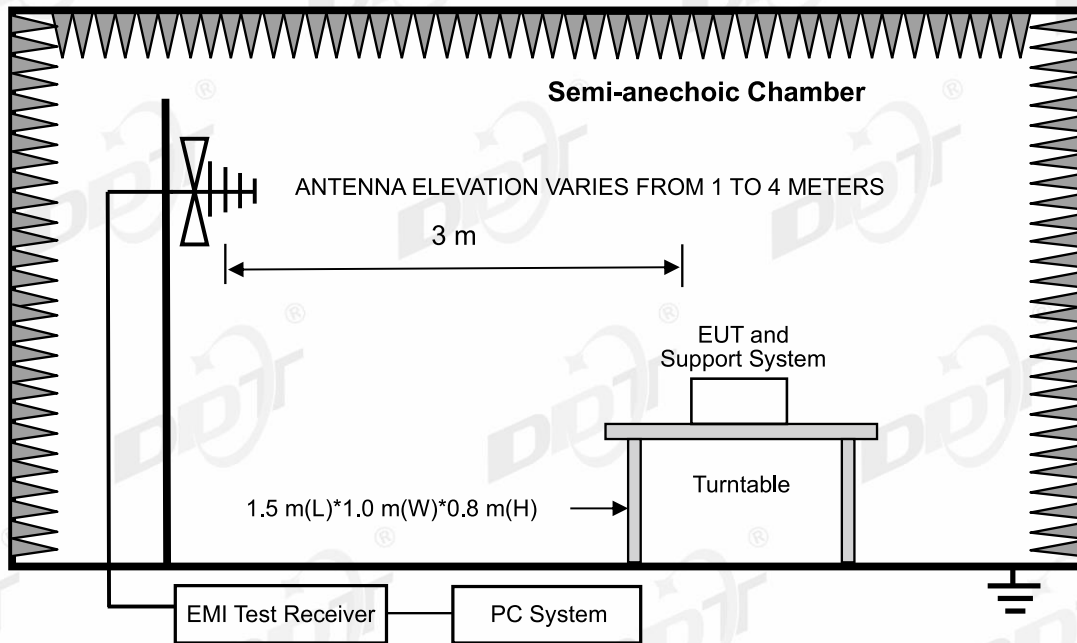
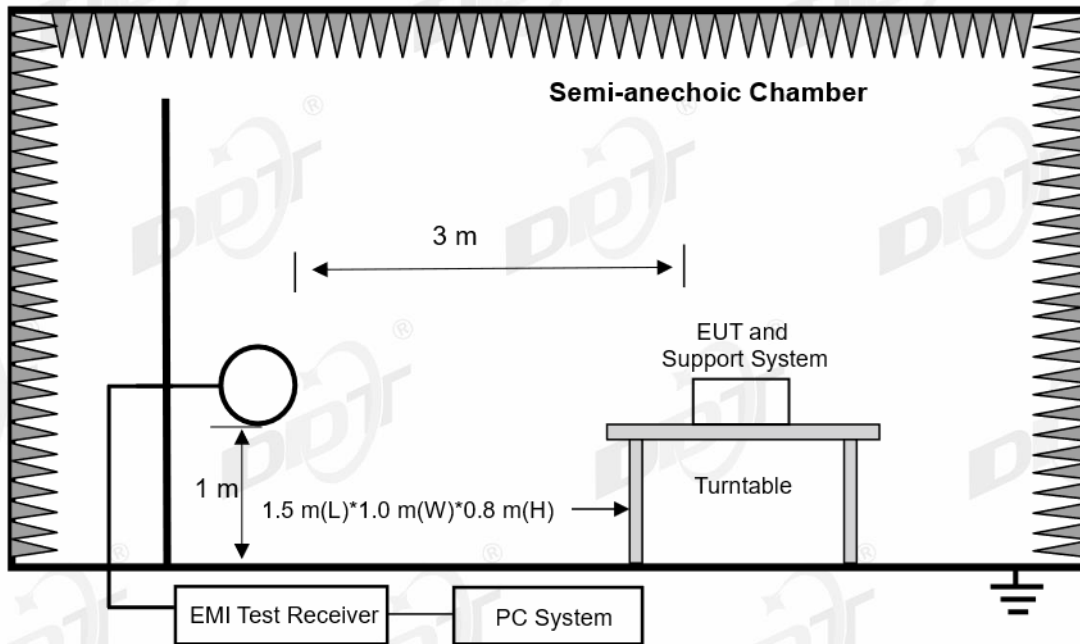

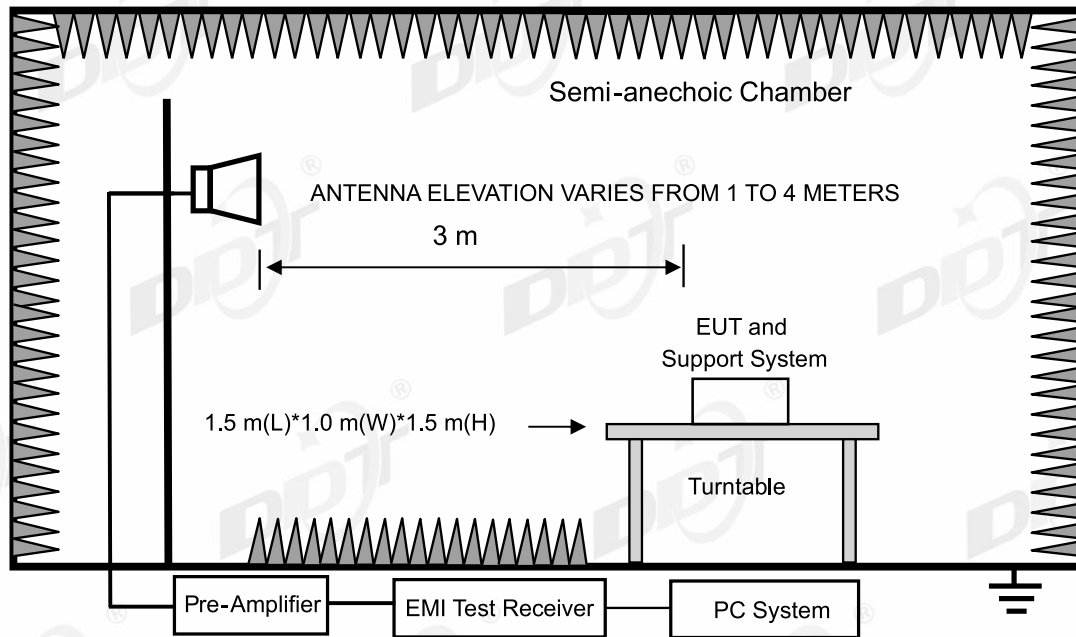

12.3. Limits

(1) FCC 15.205 Restricted frequency band

MHz	MHz	MHz	GHz
0.090-0.110	16.42-16.423	399.9-410	4.5-5.15
10.495-0.505	16.69475-16.69525	608-614	5.35-5.46
2.1735-2.1905	16.80425-16.80475	960-1240	7.25-7.75
4.125-4.128	25.5-25.67	1300-1427	8.025-8.5
4.1772&4.17775	37.5-38.25	1435-1626.5	9.0-9.2
4.2072&4.20775	73-74.6	1645.5-1646.5	9.3-9.5
6.215-6.218	74.8-75.2	1660-1710	10.6-12.7
6.26775-6.26825	108-121.94	1718.8-1722.2	13.25-13.4
6.31175-6.31225	123-138	2200-2300	14.47-14.5
8.291-8.294	149.9-150.05	2310-2390	15.35-16.2
8.362-8.366	156.52475-156.52525	2483.5-2500	17.7-21.4
8.37625-8.38675	156.7-156.9	2690-2900	22.01-23.12
8.41425-8.41475	162.0125-167.17	3260-3267	23.6-24.0
12.29-12.293	167.72-173.2	3332-3339	31.2-31.8
12.51975-12.52025	240-285	3345.8-3358	36.43-36.5
12.57675-12.57725	322-335.4	3600-4400	(²)
13.36-13.41			

¹Until February 1, 1999, this restricted band shall be 0.490-0.510 MHz

²Above 38.6

RSS-Gen section 8.10 Restricted frequency bands*

MHz	MHz	MHz	GHz
0.090-0.110	12.51975-12.52025	240-285	3.5-4.4
0.495-0.505	12.57675-12.57725	322-335.4	4.5-5.15
2.1735-2.1905	13.36-13.41	399.9-410	5.35-5.46
3.020-3.026	16.42-16.423	608-614	7.25-7.75
4.125-4.128	16.69475-16.69525	960-1427	8.025-8.5
4.1772&4.17775	16.80425-16.80475	1435-1626.5	9.0-9.2
4.2072&4.20775	25.5-25.67	1645.5-1646.5	9.3-9.5
5.677-5.683	37.5-38.25	1660-1710	10.6-12.7
6.215-6.218	73-74.6	1718.8-1722.2	13.25-13.4
6.26775-6.26825	74.8-75.2	2200-2300	14.47-14.5
6.31175-6.31225	108-138	2310-2390	15.35-16.2
8.291-8.294	149.9-150.05	2483.5-2500	17.7-21.4
8.362-8.366	156.52475-156.52525	2655-2900	22.01-23.12
8.37625-8.38675	156.7-156.9	3260-3267	23.6-24.0
8.41425-8.41475	162.0125-167.17	3332-3339	31.2-31.8
12.29-12.293	167.72-173.2	3345.8-3358	36.43-36.5
			Above 38.6

* Certain frequency bands listed in table and in bands above 38.6 GHz are designated for licence-exempt applications. These frequency bands and the requirements that apply to related devices are set out in the 200 and 300 series of RSSs.

(2) FCC 15.209 Limit & RSS-Gen section 8.9 Limit

FREQUENCY	DISTANCE	FIELD STRENGTHS LIMIT	
		uV/m	dBuV/m
MHz	Meters		
0.009 ~ 0.490	300	2400/F(kHz)	67.6-20log(F)
0.490 ~ 1.705	30	24000/F(kHz)	87.6-20log(F)
1.705 ~ 30.0	30	30	29.54
30~88	3	100	40.0
88~216	3	150	43.5
216~960	3	200	46.0
960~1000	3	500	54.0
Above 1000	3	74.0 dBuV/m(Peak) 54.0 dBuV/m(Average)	

Note:

(1) The emission limits shown in the above table are based on measurements employing a CISPR QP detector except for the frequency bands 9 - 90 kHz, 110 - 490 kHz and above 1000 MHz, radiated emissions limits in these three bands are based on measurements employing an average detector.

(2) At frequencies below 30 MHz, measurement may be performed at a distance closer than that specified, and the limit at closer measurement distance can be extrapolated by below formula:

$$\text{Limit}_{3m}(\text{dBuV/m}) = \text{Limit}_{30m}(\text{dBuV/m}) + 40\text{Log}(30m/3m)$$

(3) Limit for this EUT

The emissions appearing within 15.205 restricted frequency bands shall not exceed the limits shown in 15.209, and the emissions appearing within RSS-Gen section 8.10 Restricted frequency bands shall not exceed the limits shown in RSS-Gen section 8.9, all the other emissions shall be at least 20 dB below the fundamental emissions or comply with 15.209 limits and RSS-Gen section 8.9 limits.

12.4. Assistant equipment used for test

Assistant equipment	Manufacturer	Model number	Description	other
/	/	/	/	/

12.5. Test procedure

(1) EUT was placed on a non-metallic table, 80 cm above the ground plane inside a semi-anechoic chamber for below 1G and 150 cm above the ground plane inside a fully-anechoic chamber for above 1G.

(2) Test antenna was located 3 m from the EUT on an adjustable mast, and the antenna used as below table.

Test frequency range	Test antenna used	Test antenna distance
9 kHz - 30 MHz	Active Loop antenna	3 m
30 MHz - 1 GHz	Trilog Broadband Antenna	3 m
1 GHz - 18 GHz	Double Ridged Horn Antenna(1 GHz-18 GHz)	3 m
18 GHz - 40 GHz	Horn Antenna(18 GHz-40 GHz)	1 m

According ANSI C63.10:2013 clause 6.4.6 and 6.5.3, for measurements below 30 MHz, Antenna was located 3 m from EUT, the loop antenna was positioned in three antenna orientations (parallel, perpendicular, and round-parallel), for each measurement antenna alignment, the EUT shall be rotated through 0° to 360° on a turntable, and the lowest height of the magnetic antenna shall be 1 m above the ground. For measurement above 30MHz, the trilog Broadband Antenna or Horn Antenna was located 3m from EUT, Measurements were made with the antenna positioned in both the horizontal and vertical planes of Polarization, and the measurement antenna was varied from 1 m to 4 m. in height above the reference ground plane to obtain the maximum signal strength.

(3) Below pre-scan procedure was first performed in order to find prominent frequency spectrum radiated emissions from 9 kHz to 25 GHz:

(a) Scanning the peak frequency spectrum with the antenna specified in step (3), and the EUT was rotated 360 degree, the antenna height was varied from 1 m to 4 m (Except loop antenna, it's fixed 1 m above ground.)

(b) Change work frequency or channel of device if practicable.

- (c) Change modulation type of device if practicable.
- (d) Change power supply range from 85% to 115% of the rated supply voltage
- (e) Rotated EUT though three orthogonal axes to determine the attitude of EUT arrangement produces highest emissions.

Spectrum frequency from 9 kHz to 25 GHz (tenth harmonic of fundamental frequency) was investigated, and no any obvious emission were detected from 18 GHz to 25 GHz, so below final test was performed with frequency range from 9 kHz to 18 GHz.

(4) For final emissions measurements at each frequency of interest, the EUT was rotated and the antenna height was varied between 1 m and 4 m in order to maximize the emission. Measurements in both horizontal and vertical polarities were made and the data was recorded. In order to find the maximum emission, the relative positions of equipment and all of the interface cables were changed according to ANSI C63.10:2013 on Radiated Emission test.

(5) The emissions from 9 kHz to 1 GHz were measured based on CISPR QP detector except for the frequency bands 9 - 90 kHz, 110 - 490 kHz, for emissions from 9 kHz - 90 kHz, 110 kHz - 490 kHz and above 1 GHz were measured based on average detector, for emissions above 1 GHz, peak emissions also be measured and need comply with Peak limit.

(6) The emissions from 9 kHz to 1 GHz, QP or average values were measured with EMI receiver with below RBW.

Frequency band	RBW
9 kHz - 150 kHz	200 Hz
150 kHz - 30 MHz	9 kHz
30 MHz - 1 GHz	120 kHz

(7) For emissions above 1GHz, both Peak and Average level were measured with Spectrum Analyzer, and the RBW is set at 1 MHz, VBW is set at 3 MHz for Peak measure; According ANSI C63.10:2013 clause 4.1.4.2.2 procedure for average measure.

(8) For portable device, X axis, Y axis, Z axis are tested, and worse setup is reported.

(9) According exploratory test, the emission levels are 20 dB below the limit detected from 9 kHz to 30 MHz and 18 GHz to 25 GHz, so the final test was performed with frequency range from 30 MHz to 18 GHz and recorded in below.

(10) For 30 MHz ~ 25 GHz: (Scan with all mode, the worst case is reported)

(11) For emissions below 1 GHz, according exploratory explorer test, when change Tx mode and channel, have no distinct influence on emissions level, so for emissions below 1 GHz, the final test was only performed with EUT working in worst mode.

12.6. Test result

PASS. (See below detailed test result)

12.7. Test data

TR-4-E-009 Radiated Emission Test Result

Test Date: 2025-05-13 **Tested By:** Lin Guoyuan
EUT: BLUETOOTH HEADSET **Model Number:** ENDURANCE PACE
Test Mode: TX BLE 1M 2480MHz Mode **Power Supply:** Battery
Condition: Temp:24.1°C;Humi:49.4% **Test Site:** DDT 3# Chamber
File Path: d:\ts\2025 report date\Q25042425-1E\FCC Below 1G\20250513-110540_H
Memo: Sample Number: S25042425-017

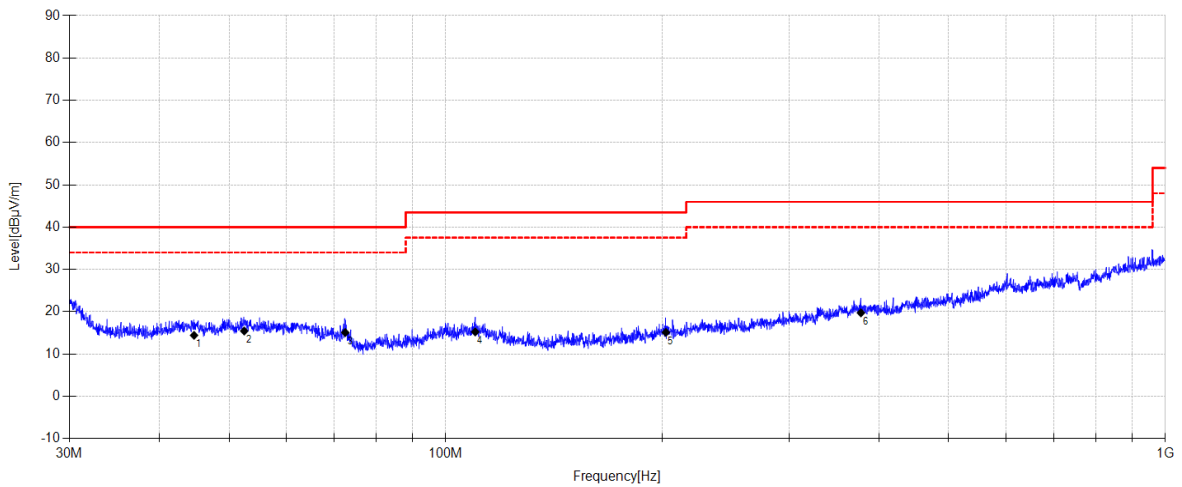

Final Data List

NO.	Freq. [MHz]	Reading [dBμV/m]	Antenna Factor [dB]	Cable Loss [dB]	Result [dBμV/m]	Limit [dBμV/m]	Margin [dB]	Detector	Polarity
1	44.709	28.53	13.14	3.85	14.42	40.00	25.58	QP	Horizontal
2	52.496	29.39	13.25	3.90	15.44	40.00	24.56	QP	Horizontal
3	72.528	32.74	9.39	4.04	15.07	40.00	24.93	QP	Horizontal
4	109.922	29.97	12.10	4.27	15.23	43.50	28.27	QP	Horizontal
5	202.307	30.82	10.71	4.77	15.10	43.50	28.40	QP	Horizontal
6	377.597	30.2	15.45	5.53	19.74	46.00	26.26	QP	Horizontal

Note:

1. Result Level = Reading + Cable loss + Antenna Factor + AMP
2. If Peak Result complies with QP limit, QP Result is deemed to comply with QP limit.
3. Test setup: RBW: 120 kHz, VBW: 300 kHz, Sweep time: auto.

TR-4-E-009 Radiated Emission Test Result

Test Date: 2025-05-13 **Tested By:** Lin Guoyuan
EUT: BLUETOOTH HEADSET **Model Number:** ENDURANCE PACE
Test Mode: TX BLE 1M 2480MHz Mode **Power Supply:** Battery
Condition: Temp:24.1°C;Humi:49.4% **Test Site:** DDT 3# Chamber
File Path: d:\ts\2025 report date\Q25042425-1E\FCC Below 1G\20250513-110632_V
Memo: Sample Number: S25042425-017

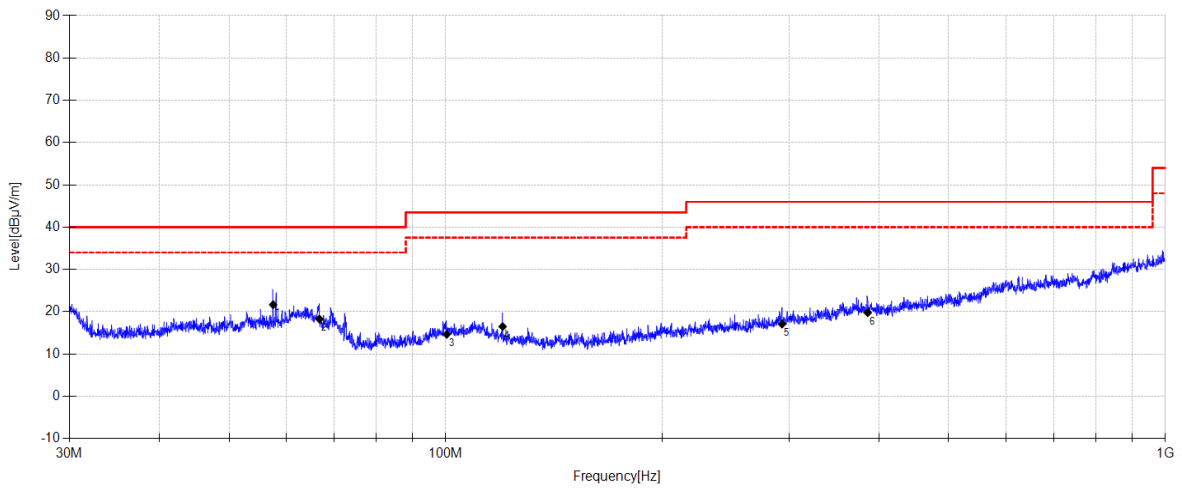

Final Data List

NO.	Freq. [MHz]	Reading [dBµV/m]	Antenna Factor [dB]	Cable Loss [dB]	Result [dBµV/m]	Limit [dBµV/m]	Margin [dB]	Detector	Polarity
1	57.586	36.31	12.51	3.94	21.66	40.00	18.34	QP	Vertical
2	66.769	34.97	10.40	4.00	18.27	40.00	21.73	QP	Vertical
3	100.345	30.35	11.19	4.22	14.66	43.50	28.84	QP	Vertical
4	119.991	33.28	10.00	4.33	16.49	43.50	27.01	QP	Vertical
5	293.362	30.41	12.86	5.19	17.07	46.00	28.93	QP	Vertical
6	385.895	30.28	15.39	5.56	19.79	46.00	26.21	QP	Vertical

Note:

1. Result Level = Reading + Cable loss + Antenna Factor + AMP
2. If Peak Result complies with QP limit, QP Result is deemed to comply with QP limit.
3. Test setup: RBW: 120 kHz, VBW: 300 kHz, Sweep time: auto.

TR-4-E-009 Radiated Emission Test Result

Test Date: 2025-05-13 **Tested By:** Lin Guoyuan
EUT: BLUETOOTH HEADSET **Model Number:** ENDURANCE PACE
Test Mode: TX BLE 2M 2478MHz Mode **Power Supply:** Battery
Condition: Temp:24.1°C;Humi:49.4% **Test Site:** DDT 3# Chamber
File Path: d:\ts\2025 report date\Q25042425-1E\FCC Below 1G\20250513-110820_H
Memo: Sample Number: S25042425-017

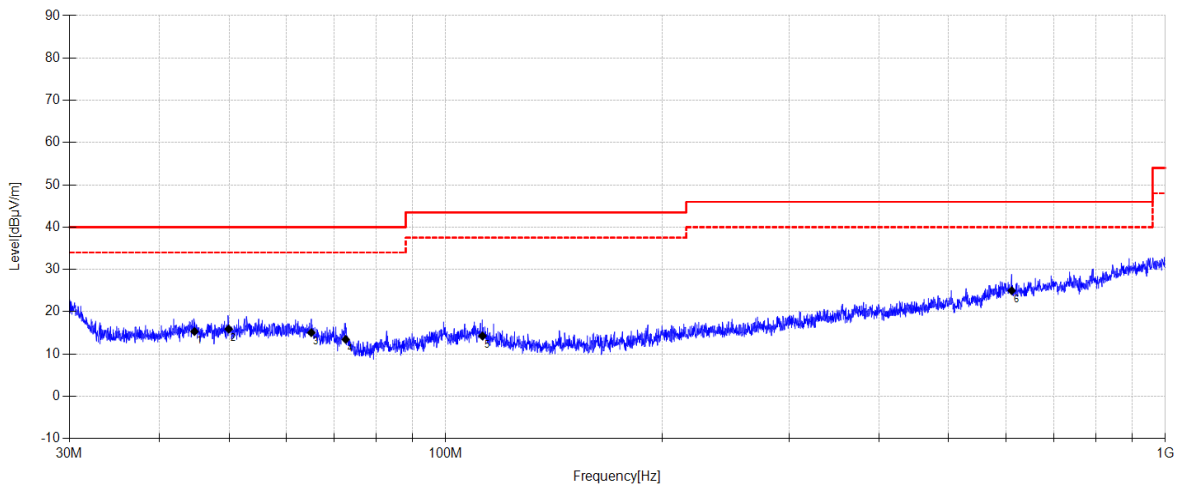

Final Data List

NO.	Freq. [MHz]	Reading [dBµV/m]	Antenna Factor [dB]	Cable Loss [dB]	Result [dBµV/m]	Limit [dBµV/m]	Margin [dB]	Detector	Polarity
1	44.771	29.41	13.15	3.85	15.31	40.00	24.69	QP	Horizontal
2	49.946	30.14	12.98	3.88	15.90	40.00	24.10	QP	Horizontal
3	65.059	30.01	12.15	3.99	15.05	40.00	24.95	QP	Horizontal
4	72.630	31.15	9.35	4.04	13.44	40.00	26.56	QP	Horizontal
5	112.495	29.59	11.50	4.29	14.27	43.50	29.23	QP	Horizontal
6	611.695	30.93	19.13	6.41	24.97	46.00	21.03	QP	Horizontal

Note:

1. Result Level = Reading + Cable loss + Antenna Factor + AMP
2. If Peak Result complies with QP limit, QP Result is deemed to comply with QP limit.
3. Test setup: RBW: 120 kHz, VBW: 300 kHz, Sweep time: auto.

TR-4-E-009 Radiated Emission Test Result

Test Date: 2025-05-13 **Tested By:** Lin Guoyuan
EUT: BLUETOOTH HEADSET **Model Number:** ENDURANCE PACE
Test Mode: TX BLE 2M 2478MHz Mode **Power Supply:** Battery
Condition: Temp:24.1°C;Humi:49.4% **Test Site:** DDT 3# Chamber
File Path: d:\ts\2025 report date\Q25042425-1E\FCC Below 1G\20250513-110843_V
Memo: Sample Number: S25042425-017

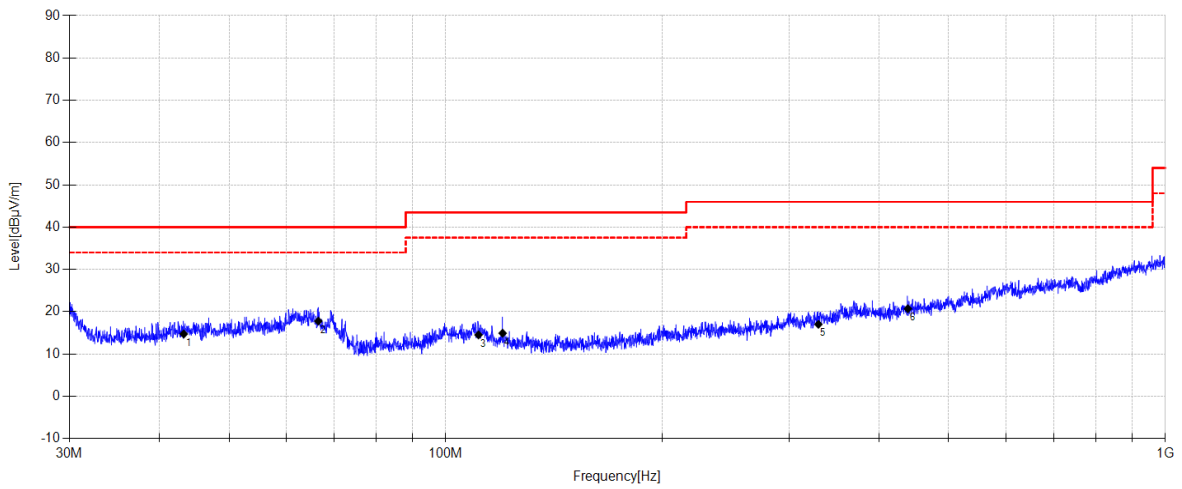

Final Data List

NO.	Freq. [MHz]	Reading [dBμV/m]	Antenna Factor [dB]	Cable Loss [dB]	Result [dBμV/m]	Limit [dBμV/m]	Margin [dB]	Detector	Polarity
1	43.259	29.15	12.85	3.84	14.74	40.00	25.26	QP	Vertical
2	66.535	34.19	10.70	4.00	17.79	40.00	22.21	QP	Vertical
3	111.084	29.48	11.88	4.28	14.53	43.50	28.97	QP	Vertical
4	119.991	31.71	10.00	4.33	14.92	43.50	28.58	QP	Vertical
5	329.574	28.86	14.23	5.34	17.02	46.00	28.98	QP	Vertical
6	438.728	30.34	16.07	5.77	20.71	46.00	25.29	QP	Vertical

Note:

1. Result Level = Reading + Cable loss + Antenna Factor + AMP
2. If Peak Result complies with QP limit, QP Result is deemed to comply with QP limit.
3. Test setup: RBW: 120 kHz, VBW: 300 kHz, Sweep time: auto.

TR-4-E-009 Radiated Emission Test Result

Test Date: 2025-05-13 **Tested By:** Lin Guoyuan
EUT: BLUETOOTH HEADSET **Model Number:** ENDURANCE PACE
Test Mode: TX BLE 1M 2402MHz Mode **Power Supply:** Battery
Condition: Temp:24.1°C;Humi:49.4% **Test Site:** DDT 3# Chamber
File Path: d:\ts\2025 report date\Q25042425-1\FCC Above 1G BLE\19
Memo: Sample Number: S25042425-017

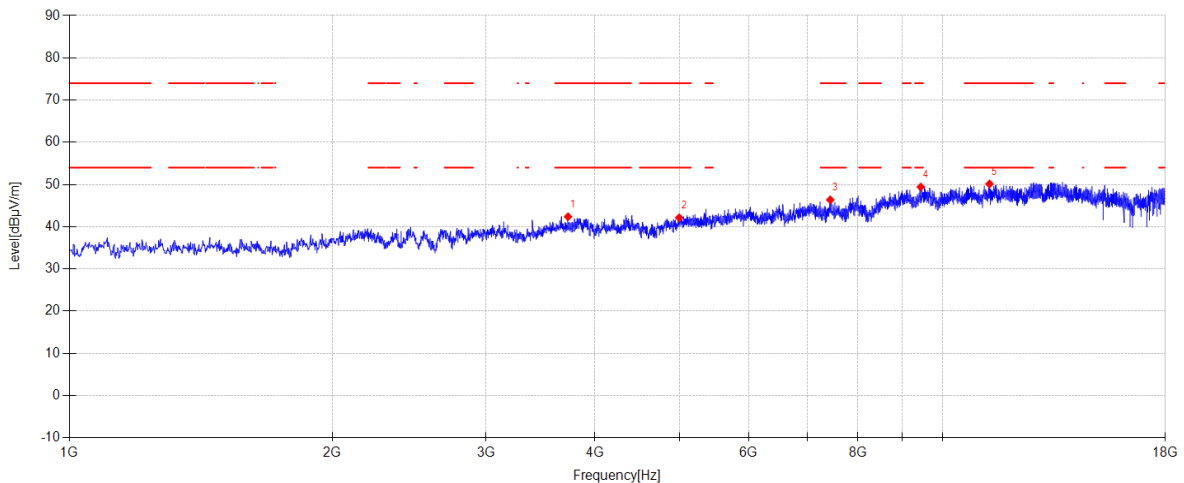

Suspected Data List

NO	Freq. [MHz]	Reading [dBμV/m]	Antenna Factor [dB]	Cable loss [dB]	AMP [dB]	Level [dBμV/m]	Limit [dBμV/m]	Margin [dB]	Detector	Polarity
1	3725.100	46.43	30.45	5.10	-39.61	42.37	74.00	31.63	PK	Horizontal
2	4995.000	42.90	33.19	5.65	-39.60	42.14	74.00	31.86	PK	Horizontal
3	7437.900	43.69	36.62	6.67	-40.61	46.37	74.00	27.63	PK	Horizontal
4	9443.900	42.43	38.70	7.45	-39.16	49.42	74.00	24.58	PK	Horizontal
5	11319.000	41.89	39.22	8.33	-39.32	50.12	74.00	23.88	PK	Horizontal

Note:

1. Level = Reading + Cable loss + Antenna Factor + AMP
2. If Peak Result complies with AV limit, AV Result is deemed to comply with AV limit.
3. Test setup: RBW: 1 MHz, VBW: 3 MHz, Sweep time: auto.

TR-4-E-009 Radiated Emission Test Result

Test Date: 2025-05-13 **Tested By:** Lin Guoyuan
EUT: BLUETOOTH HEADSET **Model Number:** ENDURANCE PACE
Test Mode: TX BLE 1M 2402MHz Mode **Power Supply:** Battery
Condition: Temp:24.1°C;Humi:49.4% **Test Site:** DDT 3# Chamber
File Path: d:\ts\2025 report date\Q25042425-1\FCC Above 1G BLE\20
Memo: Sample Number: S25042425-017

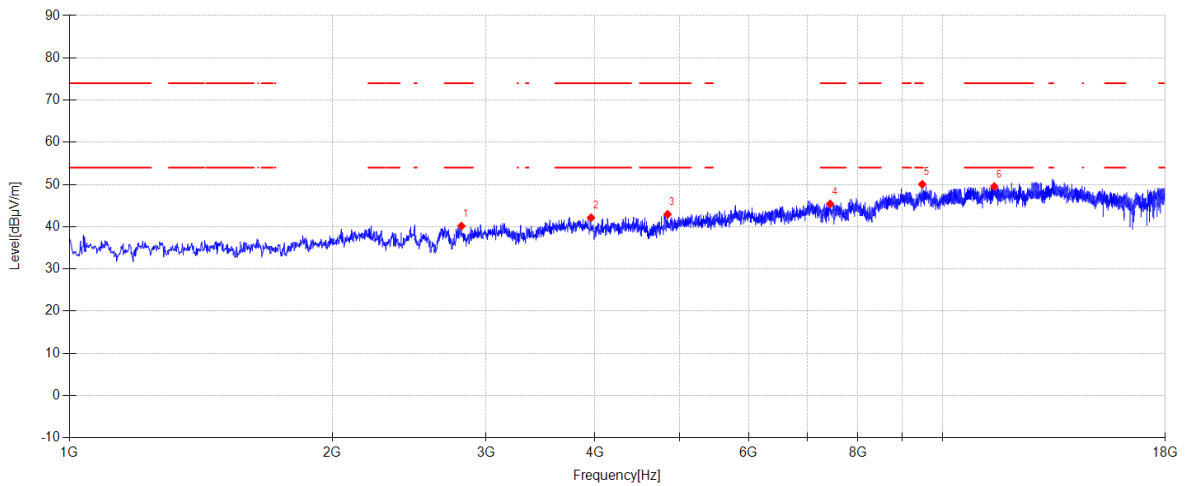

Suspected Data List

NO	Freq. [MHz]	Reading [dBμV/m]	Antenna Factor [dB]	Cable loss [dB]	AMP [dB]	Level [dBμV/m]	Limit [dBμV/m]	Margin [dB]	Detector	Polarity
1	2812.200	46.74	27.50	5.10	-39.20	40.14	74.00	33.86	PK	Vertical
2	3958.000	45.68	31.07	5.06	-39.67	42.14	74.00	31.86	PK	Vertical
3	4843.700	43.36	33.64	5.56	-39.61	42.95	74.00	31.05	PK	Vertical
4	7434.500	42.70	36.63	6.67	-40.61	45.39	74.00	28.61	PK	Vertical
5	9483.000	43.07	38.70	7.46	-39.19	50.04	74.00	23.96	PK	Vertical
6	11465.200	41.34	39.23	8.42	-39.47	49.52	74.00	24.48	PK	Vertical

Note:

1. Level = Reading + Cable loss + Antenna Factor + AMP
2. If Peak Result complies with AV limit, AV Result is deemed to comply with AV limit.
3. Test setup: RBW: 1 MHz, VBW: 3 MHz, Sweep time: auto.

TR-4-E-009 Radiated Emission Test Result

Test Date: 2025-05-13 **Tested By:** Lin Guoyuan
EUT: BLUETOOTH HEADSET **Model Number:** ENDURANCE PACE
Test Mode: TX BLE 1M 2440MHz Mode **Power Supply:** Battery
Condition: Temp:24.1°C;Humi:49.4% **Test Site:** DDT 3# Chamber
File Path: d:\ts\2025 report date\Q25042425-1\FCC Above 1G BLE\17
Memo: Sample Number: S25042425-017

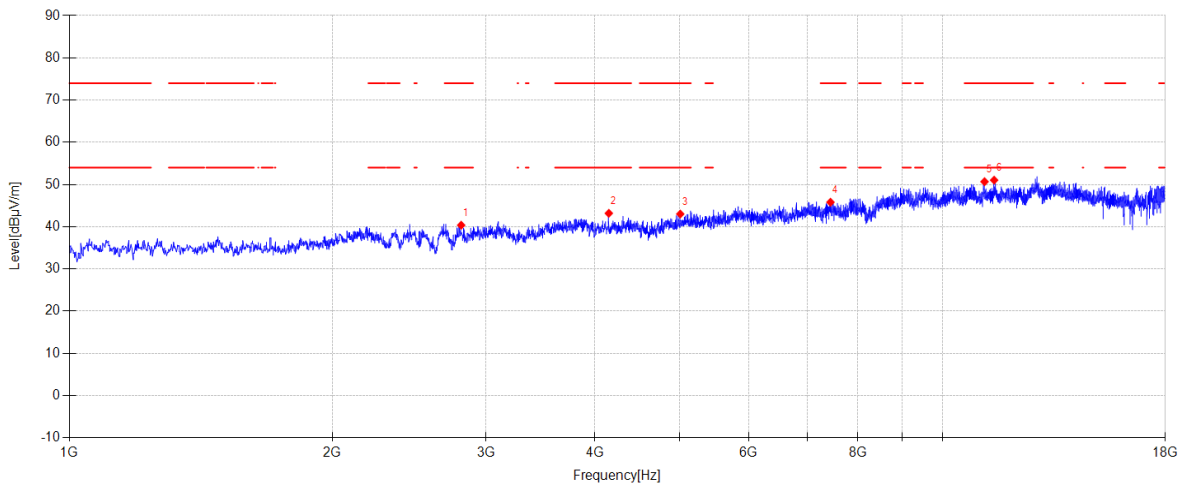

Suspected Data List										
NO	Freq. [MHz]	Reading [dBμV/m]	Antenna Factor [dB]	Cable loss [dB]	AMP [dB]	Level [dBμV/m]	Limit [dBμV/m]	Margin [dB]	Detector	Polarity
1	2810.500	46.98	27.48	5.10	-39.20	40.36	74.00	33.64	PK	Horizontal
2	4148.400	46.51	31.20	5.14	-39.67	43.18	74.00	30.82	PK	Horizontal
3	5008.600	43.74	33.22	5.65	-39.60	43.01	74.00	30.99	PK	Horizontal
4	7443.000	43.12	36.61	6.67	-40.60	45.80	74.00	28.20	PK	Horizontal
5	11172.800	42.37	39.23	8.24	-39.17	50.67	74.00	23.33	PK	Horizontal
6	11460.100	42.84	39.24	8.42	-39.46	51.04	74.00	22.96	PK	Horizontal

Note:

1. Level = Reading + Cable loss + Antenna Factor + AMP
2. If Peak Result complies with AV limit, AV Result is deemed to comply with AV limit.
3. Test setup: RBW: 1 MHz, VBW: 3 MHz, Sweep time: auto.

TR-4-E-009 Radiated Emission Test Result

Test Date: 2025-05-13 **Tested By:** Lin Guoyuan
EUT: BLUETOOTH HEADSET **Model Number:** ENDURANCE PACE
Test Mode: TX BLE 1M 2440MHz Mode **Power Supply:** Battery
Condition: Temp:24.1°C;Humi:49.4% **Test Site:** DDT 3# Chamber
File Path: d:\ts\2025 report date\Q25042425-1\FCC Above 1G BLE\18
Memo: Sample Number: S25042425-017

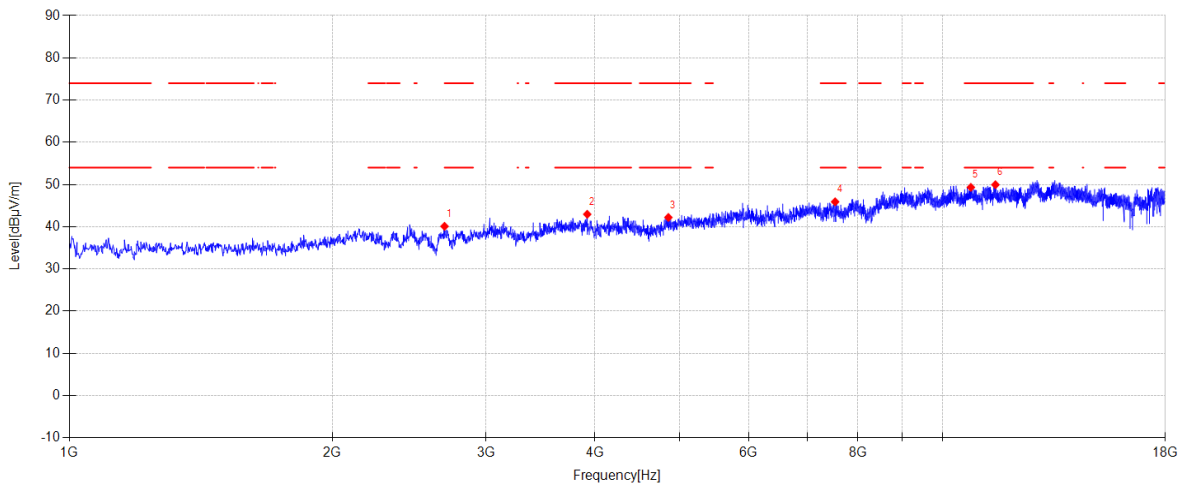

Suspected Data List

NO	Freq. [MHz]	Reading [dBμV/m]	Antenna Factor [dB]	Cable loss [dB]	AMP [dB]	Level [dBμV/m]	Limit [dBμV/m]	Margin [dB]	Detector	Polarity
1	2689.800	46.60	27.52	5.02	-39.05	40.09	-	-	PK	Vertical
2	3918.900	46.39	31.16	5.06	-39.66	42.95	74.00	31.05	PK	Vertical
3	4853.900	42.51	33.74	5.56	-39.61	42.20	74.00	31.80	PK	Vertical
4	7534.800	43.27	36.43	6.72	-40.52	45.90	74.00	28.10	PK	Vertical
5	10778.400	41.04	39.40	8.02	-39.13	49.33	74.00	24.67	PK	Vertical
6	11499.200	41.81	39.20	8.44	-39.50	49.95	74.00	24.05	PK	Vertical

Note:

1. Level = Reading + Cable loss + Antenna Factor + AMP
2. If Peak Result complies with AV limit, AV Result is deemed to comply with AV limit.
3. Test setup: RBW: 1 MHz, VBW: 3 MHz, Sweep time: auto.

TR-4-E-009 Radiated Emission Test Result

Test Date: 2025-05-13 **Tested By:** Lin Guoyuan
EUT: BLUETOOTH HEADSET **Model Number:** ENDURANCE PACE
Test Mode: TX BLE 1M 2480MHz Mode **Power Supply:** Battery
Condition: Temp:24.1°C;Humi:49.4% **Test Site:** DDT 3# Chamber
File Path: d:\ts\2025 report date\Q25042425-1\FCC Above 1G BLE\15
Memo: Sample Number: S25042425-017

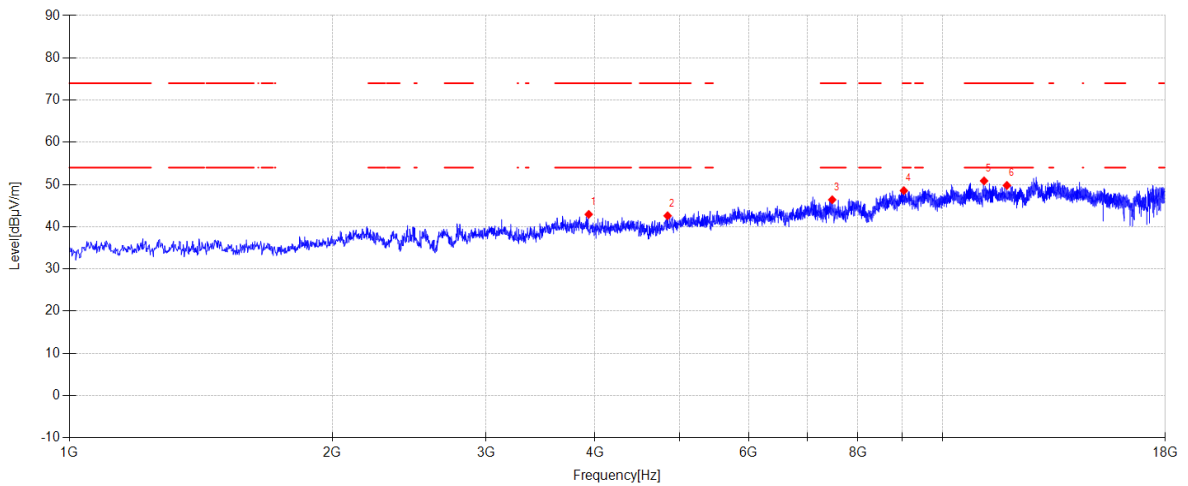

Suspected Data List										
NO	Freq. [MHz]	Reading [dBμV/m]	Antenna Factor [dB]	Cable loss [dB]	AMP [dB]	Level [dBμV/m]	Limit [dBμV/m]	Margin [dB]	Detector	Polarity
1	3934.200	46.40	31.13	5.06	-39.66	42.93	74.00	31.07	PK	Horizontal
2	4843.700	43.00	33.64	5.56	-39.61	42.59	74.00	31.41	PK	Horizontal
3	7477.000	43.72	36.55	6.69	-40.57	46.39	74.00	27.61	PK	Horizontal
4	9032.500	41.70	38.37	7.31	-38.83	48.55	74.00	25.45	PK	Horizontal
5	11159.200	42.55	39.24	8.23	-39.16	50.86	74.00	23.14	PK	Horizontal
6	11852.800	42.06	38.90	8.67	-39.85	49.78	74.00	24.22	PK	Horizontal

Note:

1. Level = Reading + Cable loss + Antenna Factor + AMP
2. If Peak Result complies with AV limit, AV Result is deemed to comply with AV limit.
3. Test setup: RBW: 1 MHz, VBW: 3 MHz, Sweep time: auto.

TR-4-E-009 Radiated Emission Test Result

Test Date: 2025-05-13 **Tested By:** Lin Guoyuan
EUT: BLUETOOTH HEADSET **Model Number:** ENDURANCE PACE
Test Mode: TX BLE 1M 2480MHz Mode **Power Supply:** Battery
Condition: Temp:24.1°C;Humi:49.4% **Test Site:** DDT 3# Chamber
File Path: d:\ts\2025 report date\Q25042425-1\FCC Above 1G BLE\16
Memo: Sample Number: S25042425-017

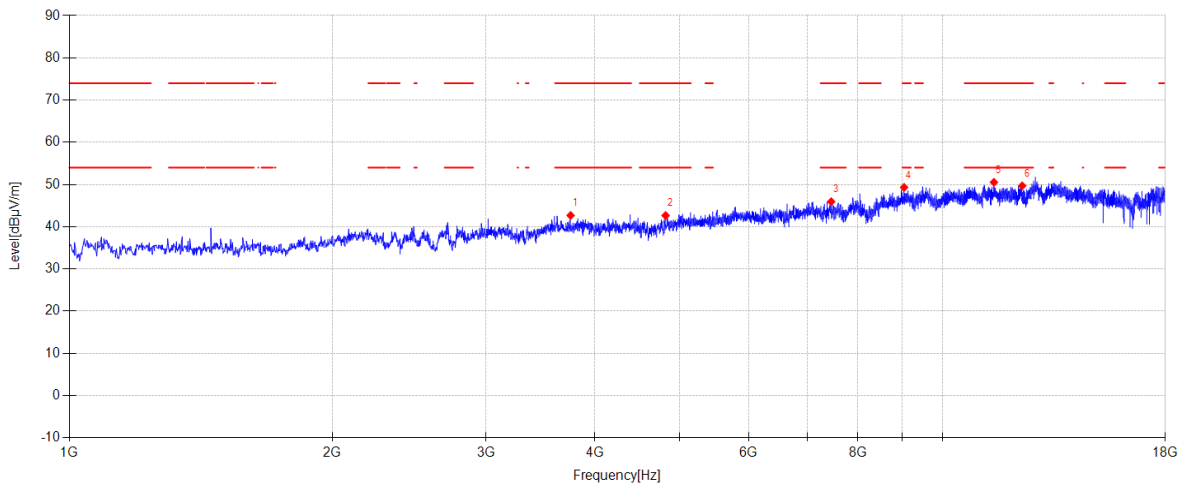

Suspected Data List										
NO	Freq. [MHz]	Reading [dBμV/m]	Antenna Factor [dB]	Cable loss [dB]	AMP [dB]	Level [dBμV/m]	Limit [dBμV/m]	Margin [dB]	Detector	Polarity
1	3750.600	46.70	30.50	5.09	-39.62	42.67	74.00	31.33	PK	Vertical
2	4818.200	43.76	32.97	5.54	-39.61	42.66	74.00	31.34	PK	Vertical
3	7456.600	43.25	36.59	6.68	-40.59	45.93	74.00	28.07	PK	Vertical
4	9037.600	42.46	38.38	7.31	-38.83	49.32	74.00	24.68	PK	Vertical
5	11455.000	42.31	39.25	8.42	-39.46	50.52	74.00	23.48	PK	Vertical
6	12339.000	41.40	39.30	8.93	-39.93	49.70	74.00	24.30	PK	Vertical

Note:

1. Level = Reading + Cable loss + Antenna Factor + AMP
2. If Peak Result complies with AV limit, AV Result is deemed to comply with AV limit.
3. Test setup: RBW: 1 MHz, VBW: 3 MHz, Sweep time: auto.

TR-4-E-009 Radiated Emission Test Result

Test Date: 2025-05-13 **Tested By:** Lin Guoyuan
EUT: BLUETOOTH HEADSET **Model Number:** ENDURANCE PACE
Test Mode: TX BLE 2M 2404MHz Mode **Power Supply:** Battery
Condition: Temp:24.1°C;Humi:49.4% **Test Site:** DDT 3# Chamber
File Path: d:\ts\2025 report date\Q25042425-1\FCC Above 1G BLE\9
Memo: Sample Number: S25042425-017

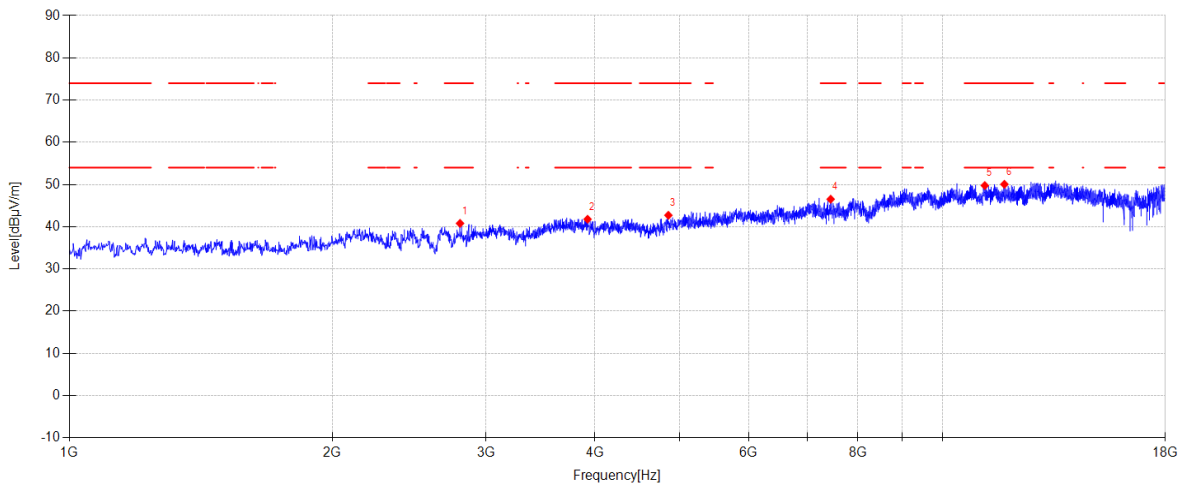

Suspected Data List										
NO	Freq. [MHz]	Reading [dBμV/m]	Antenna Factor [dB]	Cable loss [dB]	AMP [dB]	Level [dBμV/m]	Limit [dBμV/m]	Margin [dB]	Detector	Polarity
1	2802.000	47.46	27.42	5.10	-39.19	40.79	74.00	33.21	PK	Horizontal
2	3922.300	45.22	31.16	5.06	-39.66	41.78	74.00	32.22	PK	Horizontal
3	4853.900	43.02	33.74	5.56	-39.61	42.71	74.00	31.29	PK	Horizontal
4	7446.400	43.83	36.61	6.68	-40.60	46.52	74.00	27.48	PK	Horizontal
5	11181.300	41.48	39.22	8.24	-39.18	49.76	74.00	24.24	PK	Horizontal
6	11774.600	42.27	38.93	8.62	-39.77	50.05	74.00	23.95	PK	Horizontal

Note:

1. Level = Reading + Cable loss + Antenna Factor + AMP
2. If Peak Result complies with AV limit, AV Result is deemed to comply with AV limit.
3. Test setup: RBW: 1 MHz, VBW: 3 MHz, Sweep time: auto.

TR-4-E-009 Radiated Emission Test Result

Test Date: 2025-05-13 **Tested By:** Lin Guoyuan
EUT: BLUETOOTH HEADSET **Model Number:** ENDURANCE PACE
Test Mode: TX BLE 2M 2404MHz Mode **Power Supply:** Battery
Condition: Temp:24.1°C;Humi:49.4% **Test Site:** DDT 3# Chamber
File Path: d:\ts\2025 report date\Q25042425-1\FCC Above 1G BLE\10
Memo: Sample Number: S25042425-017

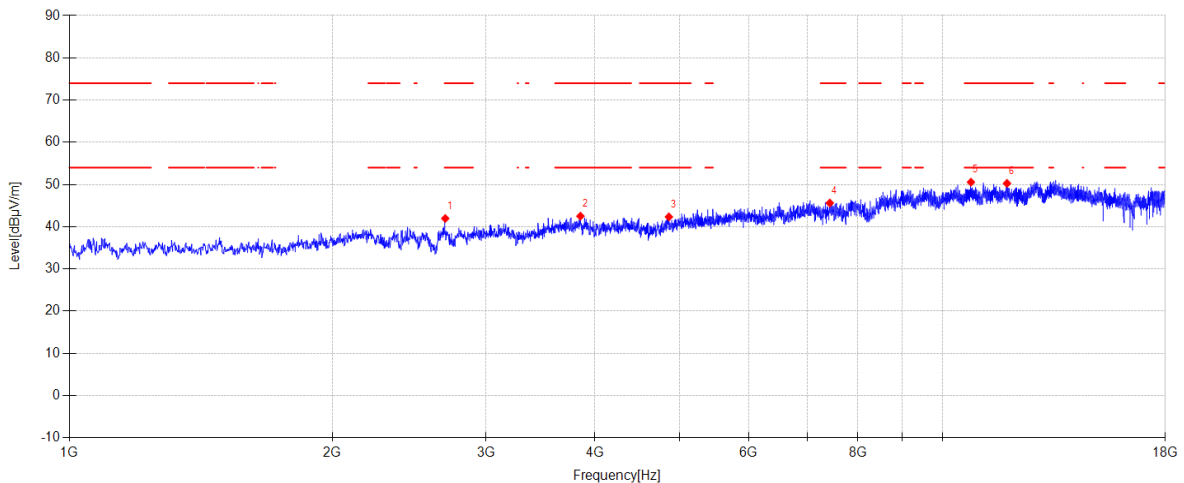

Suspected Data List

NO	Freq. [MHz]	Reading [dBμV/m]	Antenna Factor [dB]	Cable loss [dB]	AMP [dB]	Level [dBμV/m]	Limit [dBμV/m]	Margin [dB]	Detector	Polarity
1	2694.900	48.48	27.51	5.03	-39.06	41.96	74.00	32.04	PK	Vertical
2	3849.200	46.17	30.90	5.08	-39.64	42.51	74.00	31.49	PK	Vertical
3	4860.700	42.74	33.63	5.57	-39.61	42.33	74.00	31.67	PK	Vertical
4	7429.400	42.91	36.64	6.67	-40.61	45.61	74.00	28.39	PK	Vertical
5	10780.100	42.26	39.40	8.02	-39.13	50.55	74.00	23.45	PK	Vertical
6	11856.200	42.55	38.90	8.67	-39.86	50.26	74.00	23.74	PK	Vertical

Note:

1. Level = Reading + Cable loss + Antenna Factor + AMP
2. If Peak Result complies with AV limit, AV Result is deemed to comply with AV limit.
3. Test setup: RBW: 1 MHz, VBW: 3 MHz, Sweep time: auto.

TR-4-E-009 Radiated Emission Test Result

Test Date: 2025-05-13 **Tested By:** Lin Guoyuan
EUT: BLUETOOTH HEADSET **Model Number:** ENDURANCE PACE
Test Mode: TX BLE 2M 2440MHz Mode **Power Supply:** Battery
Condition: Temp:24.1°C;Humi:49.4% **Test Site:** DDT 3# Chamber
File Path: d:\ts\2025 report date\Q25042425-1\FCC Above 1G BLE\11
Memo: Sample Number: S25042425-017

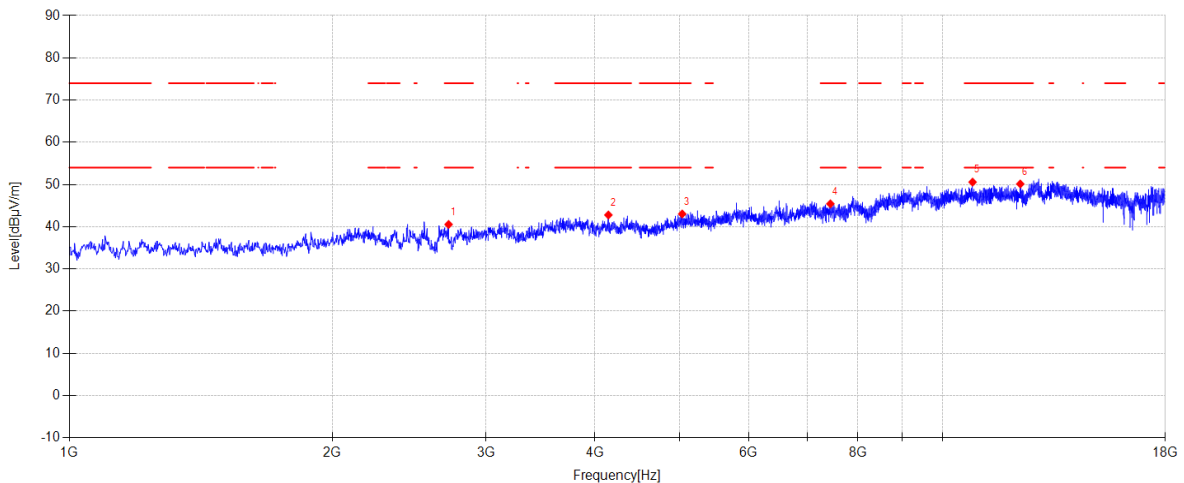

Suspected Data List										
NO	Freq. [MHz]	Reading [dBμV/m]	Antenna Factor [dB]	Cable loss [dB]	AMP [dB]	Level [dBμV/m]	Limit [dBμV/m]	Margin [dB]	Detector	Polarity
1	2718.700	47.05	27.54	5.04	-39.09	40.54	74.00	33.46	PK	Horizontal
2	4143.300	46.12	31.19	5.14	-39.67	42.78	74.00	31.22	PK	Horizontal
3	5034.100	43.69	33.27	5.67	-39.60	43.03	74.00	30.97	PK	Horizontal
4	7441.300	42.73	36.62	6.67	-40.60	45.42	74.00	28.58	PK	Horizontal
5	10827.700	42.26	39.37	8.04	-39.10	50.57	74.00	23.43	PK	Horizontal
6	12277.800	41.87	39.30	8.90	-39.94	50.13	74.00	23.87	PK	Horizontal

Note:

1. Level = Reading + Cable loss + Antenna Factor + AMP
2. If Peak Result complies with AV limit, AV Result is deemed to comply with AV limit.
3. Test setup: RBW: 1 MHz, VBW: 3 MHz, Sweep time: auto.

TR-4-E-009 Radiated Emission Test Result

Test Date: 2025-05-13 **Tested By:** Lin Guoyuan
EUT: BLUETOOTH HEADSET **Model Number:** ENDURANCE PACE
Test Mode: TX BLE 2M 2440MHz Mode **Power Supply:** Battery
Condition: Temp:24.1°C;Humi:49.4% **Test Site:** DDT 3# Chamber
File Path: d:\ts\2025 report date\Q25042425-1\FCC Above 1G BLE\12
Memo: Sample Number: S25042425-017

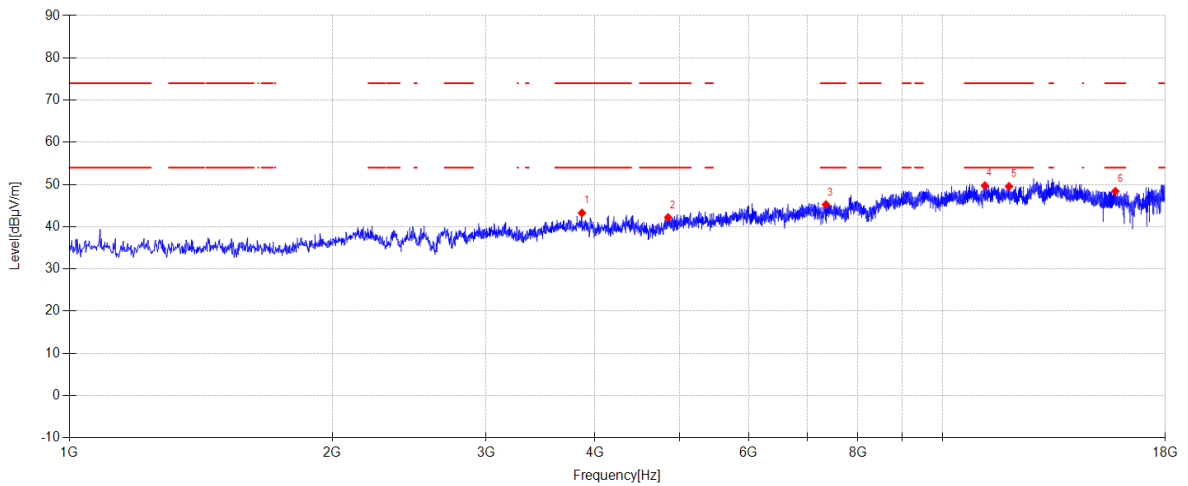

Suspected Data List

NO	Freq. [MHz]	Reading [dBµV/m]	Antenna Factor [dB]	Cable loss [dB]	AMP [dB]	Level [dBµV/m]	Limit [dBµV/m]	Margin [dB]	Detector	Polarity
1	3864.500	46.85	30.99	5.07	-39.65	43.26	74.00	30.74	PK	Vertical
2	4850.500	42.46	33.79	5.56	-39.61	42.20	74.00	31.80	PK	Vertical
3	7352.900	42.52	36.79	6.63	-40.68	45.26	74.00	28.74	PK	Vertical
4	11183.000	41.46	39.22	8.25	-39.18	49.75	74.00	24.25	PK	Vertical
5	11917.400	41.82	38.95	8.71	-39.92	49.56	74.00	24.44	PK	Vertical
6	15774.700	39.44	38.35	10.00	-39.40	48.39	74.00	25.61	PK	Vertical

Note:

1. Level = Reading + Cable loss + Antenna Factor + AMP
2. If Peak Result complies with AV limit, AV Result is deemed to comply with AV limit.
3. Test setup: RBW: 1 MHz, VBW: 3 MHz, Sweep time: auto.

TR-4-E-009 Radiated Emission Test Result

Test Date: 2025-05-13 **Tested By:** Lin Guoyuan
EUT: BLUETOOTH HEADSET **Model Number:** ENDURANCE PACE
Test Mode: TX BLE 2M 2478MHz Mode **Power Supply:** Battery
Condition: Temp:24.1°C;Humi:49.4% **Test Site:** DDT 3# Chamber
File Path: d:\ts\2025 report date\Q25042425-1\FCC Above 1G BLE\13
Memo: Sample Number: S25042425-017

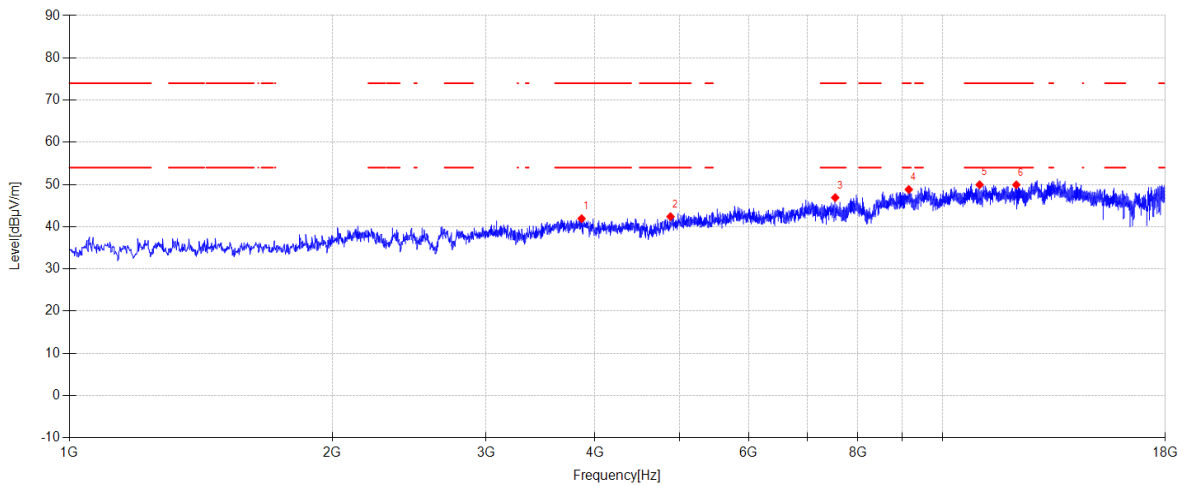

Suspected Data List										
NO	Freq. [MHz]	Reading [dBμV/m]	Antenna Factor [dB]	Cable loss [dB]	AMP [dB]	Level [dBμV/m]	Limit [dBμV/m]	Margin [dB]	Detector	Polarity
1	3861.100	45.53	30.97	5.07	-39.65	41.92	74.00	32.08	PK	Horizontal
2	4881.100	43.12	33.30	5.58	-39.61	42.39	74.00	31.61	PK	Horizontal
3	7536.500	44.26	36.43	6.72	-40.52	46.89	74.00	27.11	PK	Horizontal
4	9151.500	41.89	38.50	7.35	-38.92	48.82	74.00	25.18	PK	Horizontal
5	11030.000	41.52	39.30	8.15	-39.03	49.94	74.00	24.06	PK	Horizontal
6	12150.300	41.76	39.30	8.84	-39.97	49.93	74.00	24.07	PK	Horizontal

Note:

1. Level = Reading + Cable loss + Antenna Factor + AMP
2. If Peak Result complies with AV limit, AV Result is deemed to comply with AV limit.
3. Test setup: RBW: 1 MHz, VBW: 3 MHz, Sweep time: auto.

TR-4-E-009 Radiated Emission Test Result

Test Date: 2025-05-13 **Tested By:** Lin Guoyuan
EUT: BLUETOOTH HEADSET **Model Number:** ENDURANCE PACE
Test Mode: TX BLE 2M 2478MHz Mode **Power Supply:** Battery
Condition: Temp:24.1°C;Humi:49.4% **Test Site:** DDT 3# Chamber
File Path: d:\ts\2025 report date\Q25042425-1\FCC Above 1G BLE\14
Memo: Sample Number: S25042425-017

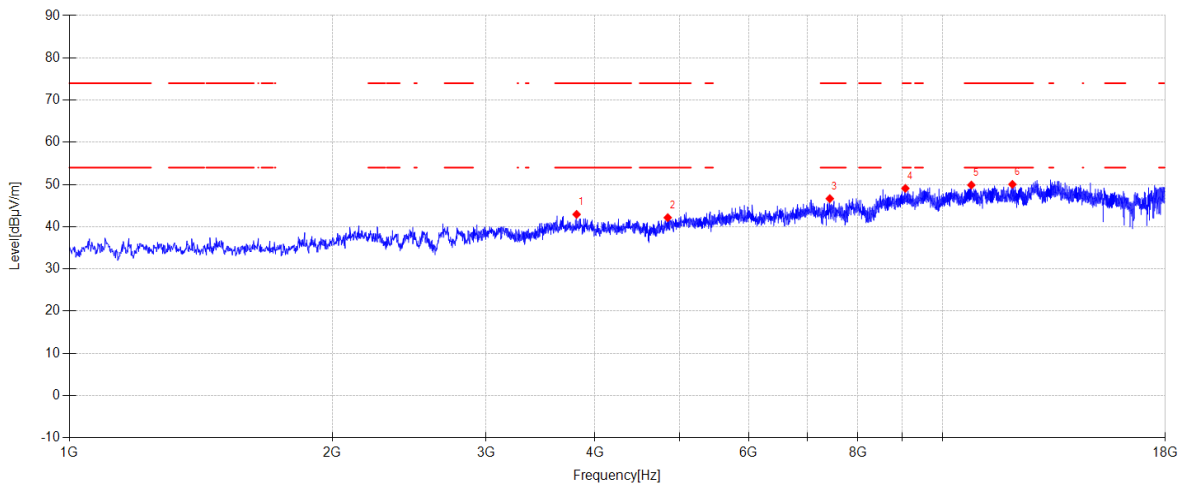

Suspected Data List										
NO	Freq. [MHz]	Reading [dBμV/m]	Antenna Factor [dB]	Cable loss [dB]	AMP [dB]	Level [dBμV/m]	Limit [dBμV/m]	Margin [dB]	Detector	Polarity
1	3810.100	46.73	30.74	5.08	-39.63	42.92	74.00	31.08	PK	Vertical
2	4845.400	42.52	33.68	5.56	-39.61	42.15	74.00	31.85	PK	Vertical
3	7429.400	43.95	36.64	6.67	-40.61	46.65	74.00	27.35	PK	Vertical
4	9068.200	42.17	38.44	7.32	-38.85	49.08	74.00	24.92	PK	Vertical
5	10792.000	41.56	39.40	8.03	-39.12	49.87	74.00	24.13	PK	Vertical
6	12026.200	42.02	39.23	8.77	-39.99	50.03	74.00	23.97	PK	Vertical

Note:

1. Level = Reading + Cable loss + Antenna Factor + AMP
2. If Peak Result complies with AV limit, AV Result is deemed to comply with AV limit.
3. Test setup: RBW: 1 MHz, VBW: 3 MHz, Sweep time: auto.

13. Band Edge Compliance

13.1. Test equipment

Equipment	Manufacturer	Model No.	Serial No.	Cal Due To
Pre-amplifier	COM-POWER	PAM-118A	DDT-ZC01293	2025/08/25
Micro-Tronics filters	REBES	BRM50702	DDT-ZC03242	/
Trilog Broadband Antenna	Schwarzbeck	VULB 9163	DDT-ZC02050	2025/07/11
Active Loop Antenna	Schwarzbeck	FMZB1519	DDT-ZC00524	2025/09/11
High Pass filter	Xi'an Xingbo	XBLBQ-GTA67	DDT-ZC02179	2026/03/28
Micro-Tronics filters	REBES	BRM50716	DDT-ZC03240	/
Pre-amplifier	COM-POWER	PAM-840A	DDT-ZC01693	2026/03/28
PSA Series Spectrum Analyzer	Agilent	E4447A	DDT-ZC00517	2026/03/28
RF Cable	N/A	W24.02 HL-562	DDT-ZC04022	2026/03/28
RF Cable	N/A	W13.02 AP1-X2	DDT-ZC04023	2026/03/28
EMI TEST RECEIVER	R&S	ESU26	DDT-ZC01909	2026/03/28
High pass filter	Micro-Tronics	HPM50102	DDT-ZC00561	2026/03/28
RF cable	Yuhu Technology	ZT26S-SMAJ-SMAJ-1M	DDT-ZC02037	2026/03/28
RF cable	Zhongke Junchuang	JCT26S-NJ-NJ-1.5M	DDT-ZC02762	2026/03/28
RF cable	Yuhu Technology	JCTB810-NJ-NJ-9M	DDT-ZC02538	2026/03/28
Broad-Band Horn Antenna	Schwarzbeck	BBHA 9170	DDT-ZC00506	2027/04/01
Hochgewinn-Hornantenne	SCHWARZBEC K	BBHA 9120 D	DDT-ZC02129	2025/09/18
High pass filter	Micro-Tronics	HPM50108	DDT-ZC00560	2026/03/28

13.2. Block diagram of test setup

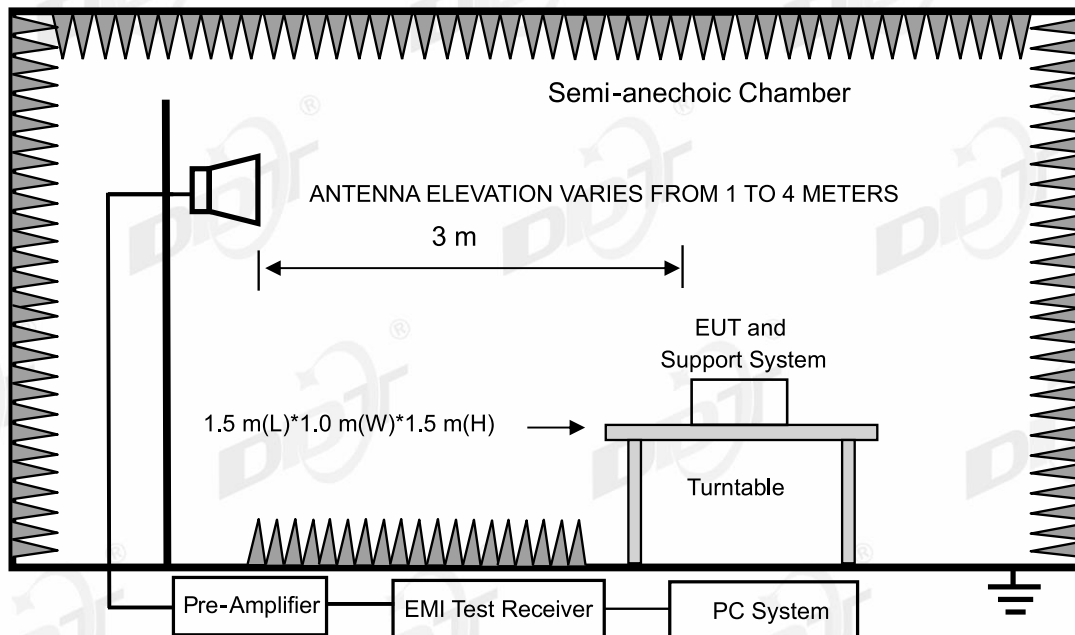

13.3. Limits

All restriction band should comply with 15.209 and RSS-Gen section 8.9 limits, other emission should be at least 20 dB below the fundamental.

13.4. Assistant equipment used for test

Assistant equipment	Manufacturer	Model number	Description	other
/	/	/	/	/

13.5. Test procedure

Same with Radiated Emission except change investigated frequency range.

Remark: All restriction band have been tested, and only the worst case is shown in report.

13.6. Test result

PASS. (See below detailed test result)

13.7. Test data

TR-4-E-009 Radiated Emission Test Result

Test Date: 2025-05-13 **Tested By:** Lin Guoyuan
EUT: BLUETOOTH HEADSET **Model Number:** ENDURANCE PACE
Test Mode: TX BLE 1M 2402MHz Mode **Power Supply:** Battery
Condition: Temp:24.1°C;Humi:49.4% **Test Site:** DDT 3# Chamber
File Path: d:\ts\2025 report date\Q25042425-1E\FCC Above 1G BLE\1
Memo: Sample Number: S25042425-017

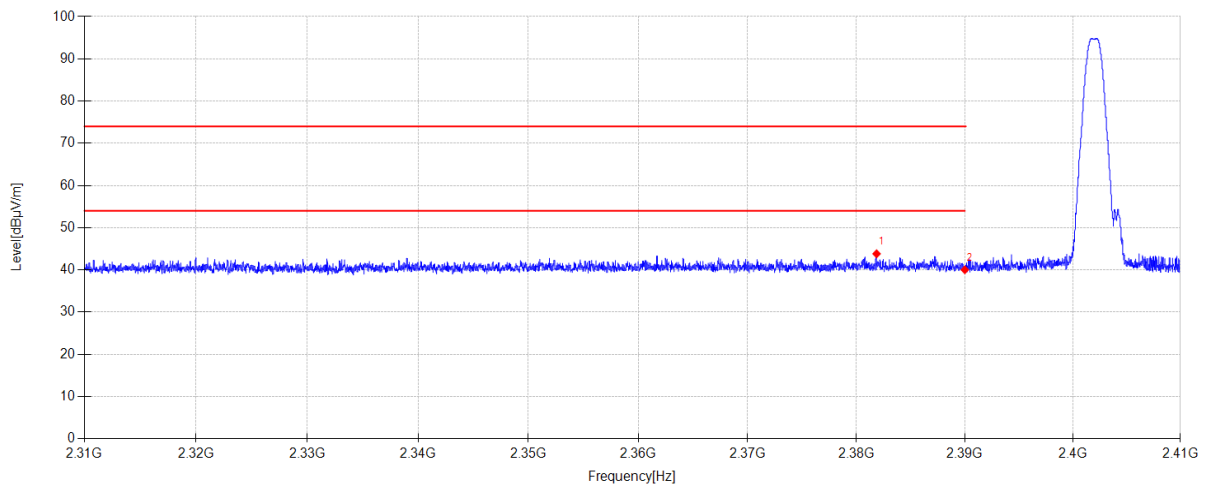

Suspected Data List

NO	Freq. [MHz]	Reading [dBμV/m]	Antenna Factor [dB]	Cable loss [dB]	AMP [dB]	Level [dBμV/m]	Limit [dBμV/m]	Margin [dB]	Detector	Polarity
1	2381.860	13.04	27.23	3.56	0.00	43.83	74.00	30.17	PK	Horizontal
2	2390.000	9.20	27.26	3.57	0.00	40.03	74.00	33.97	PK	Horizontal

Note:

1. Level = Reading + Cable loss + Antenna Factor + AMP
2. If Peak Result complies with AV limit, AV Result is deemed to comply with AV limit.
3. Test setup: RBW: 1 MHz, VBW: 3 MHz, Sweep time: auto.

TR-4-E-009 Radiated Emission Test Result

Test Date: 2025-05-13 **Tested By:** Lin Guoyuan
EUT: BLUETOOTH HEADSET **Model Number:** ENDURANCE PACE
Test Mode: TX BLE 1M 2402MHz Mode **Power Supply:** Battery
Condition: Temp:24.1°C;Humi:49.4% **Test Site:** DDT 3# Chamber
File Path: d:\ts\2025 report date\Q25042425-1E\FCC Above 1G BLE\2
Memo: Sample Number: S25042425-017

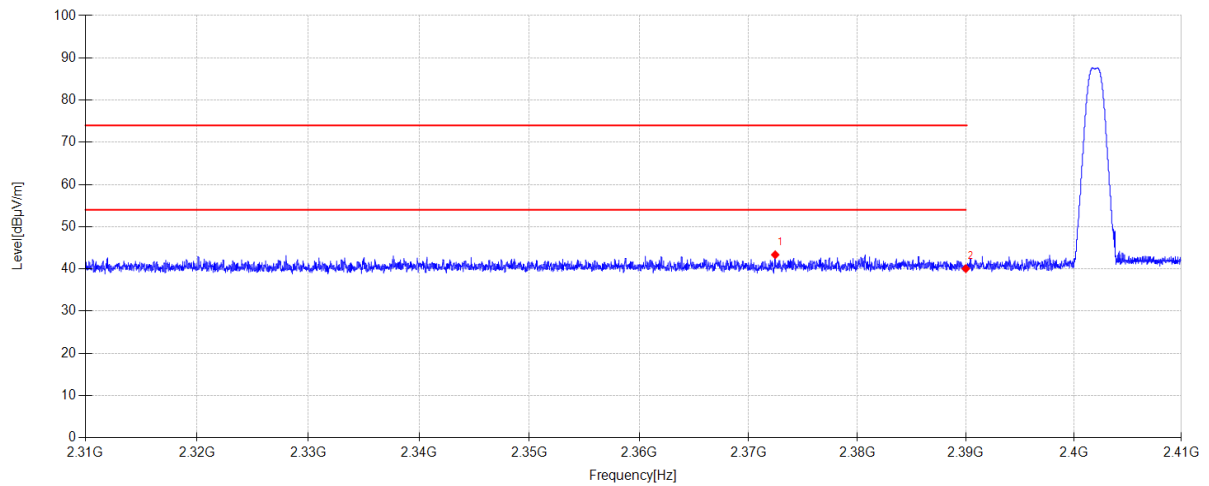

Suspected Data List

NO	Freq. [MHz]	Reading [dBμV/m]	Antenna Factor [dB]	Cable loss [dB]	AMP [dB]	Level [dBμV/m]	Limit [dBμV/m]	Margin [dB]	Detector	Polarity
1	2372.450	12.61	27.19	3.56	0.00	43.36	74.00	30.64	PK	Vertical
2	2390.000	9.24	27.26	3.57	0.00	40.07	74.00	33.93	PK	Vertical

Note:

1. Level = Reading + Cable loss + Antenna Factor + AMP
2. If Peak Result complies with AV limit, AV Result is deemed to comply with AV limit.
3. Test setup: RBW: 1 MHz, VBW: 3 MHz, Sweep time: auto.

TR-4-E-009 Radiated Emission Test Result

Test Date: 2025-05-13 **Tested By:** Lin Guoyuan
EUT: BLUETOOTH HEADSET **Model Number:** ENDURANCE PACE
Test Mode: TX BLE 2M 2404MHz Mode **Power Supply:** Battery
Condition: Temp:24.1°C;Humi:49.4% **Test Site:** DDT 3# Chamber
File Path: d:\ts\2025 report date\Q25042425-1E\FCC Above 1G BLE\3
Memo: Sample Number: S25042425-017

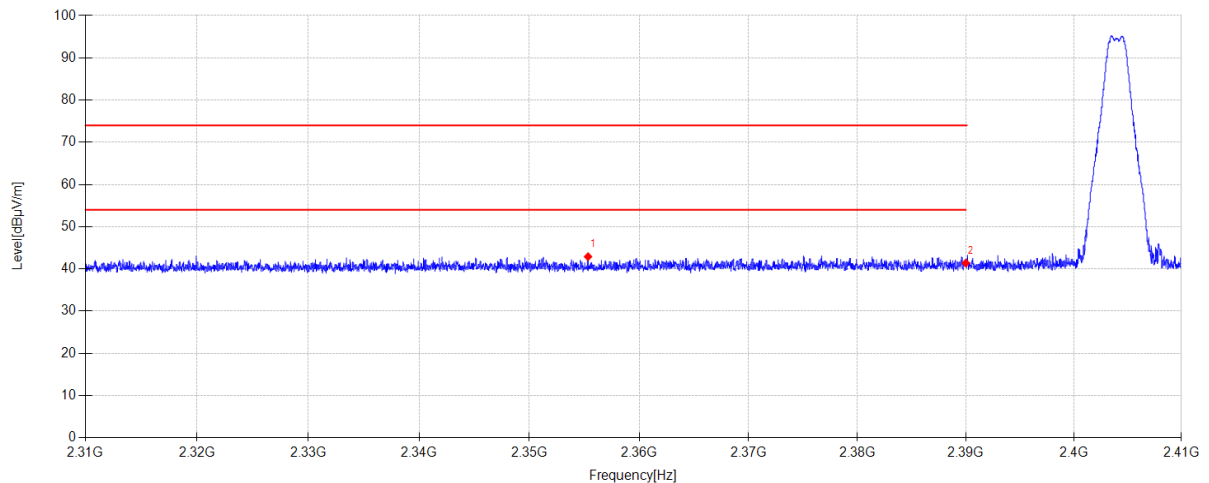

Suspected Data List

NO	Freq. [MHz]	Reading [dBμV/m]	Antenna Factor [dB]	Cable loss [dB]	AMP [dB]	Level [dBμV/m]	Limit [dBμV/m]	Margin [dB]	Detector	Polarity
1	2355.340	12.24	27.12	3.55	0.00	42.91	74.00	31.09	PK	Horizontal
2	2390.000	10.56	27.26	3.57	0.00	41.39	74.00	32.61	PK	Horizontal

Note:

1. Level = Reading + Cable loss + Antenna Factor + AMP
2. If Peak Result complies with AV limit, AV Result is deemed to comply with AV limit.
3. Test setup: RBW: 1 MHz, VBW: 3 MHz, Sweep time: auto.

TR-4-E-009 Radiated Emission Test Result

Test Date: 2025-05-13 **Tested By:** Lin Guoyuan
EUT: BLUETOOTH HEADSET **Model Number:** ENDURANCE PACE
Test Mode: TX BLE 2M 2404MHz Mode **Power Supply:** Battery
Condition: Temp:24.1°C;Humi:49.4% **Test Site:** DDT 3# Chamber
File Path: d:\ts\2025 report date\Q25042425-1E\FCC Above 1G BLE\4
Memo: Sample Number: S25042425-017

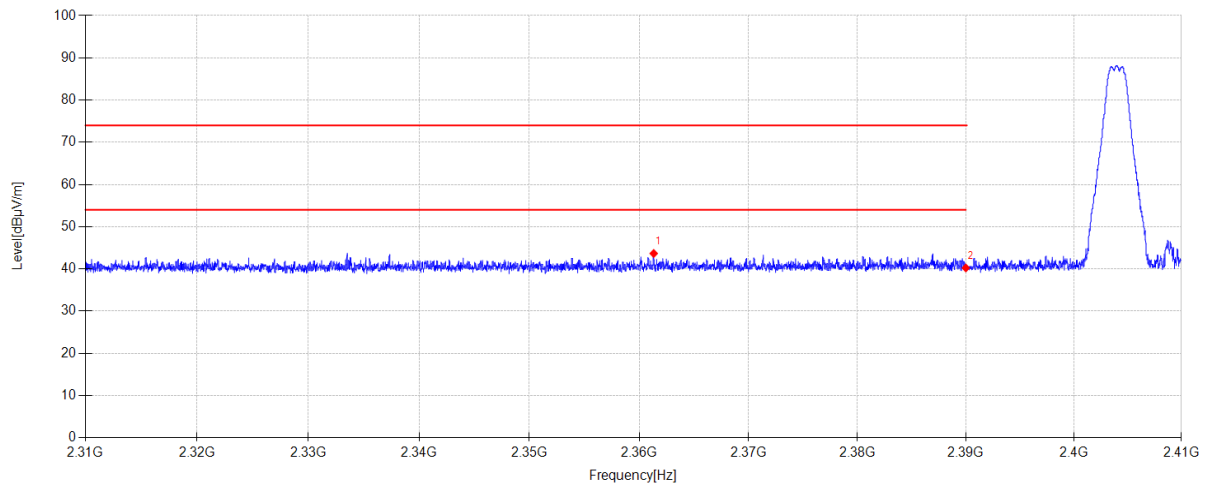

Suspected Data List										
NO	Freq. [MHz]	Reading [dBμV/m]	Antenna Factor [dB]	Cable loss [dB]	AMP [dB]	Level [dBμV/m]	Limit [dBμV/m]	Margin [dB]	Detector	Polarity
1	2361.330	12.96	27.15	3.55	0.00	43.66	74.00	30.34	PK	Vertical
2	2390.000	9.41	27.26	3.57	0.00	40.24	74.00	33.76	PK	Vertical

Note:

1. Level = Reading + Cable loss + Antenna Factor + AMP
2. If Peak Result complies with AV limit, AV Result is deemed to comply with AV limit.
3. Test setup: RBW: 1 MHz, VBW: 3 MHz, Sweep time: auto.

TR-4-E-009 Radiated Emission Test Result

Test Date: 2025-05-13 **Tested By:** Lin Guoyuan
EUT: BLUETOOTH HEADSET **Model Number:** ENDURANCE PACE
Test Mode: TX BLE 1M 2480MHz Mode **Power Supply:** Battery
Condition: Temp:24.1°C;Humi:49.4% **Test Site:** DDT 3# Chamber
File Path: d:\ts\2025 report date\Q25042425-1E\FCC Above 1G BLE\7
Memo: Sample Number: S25042425-017

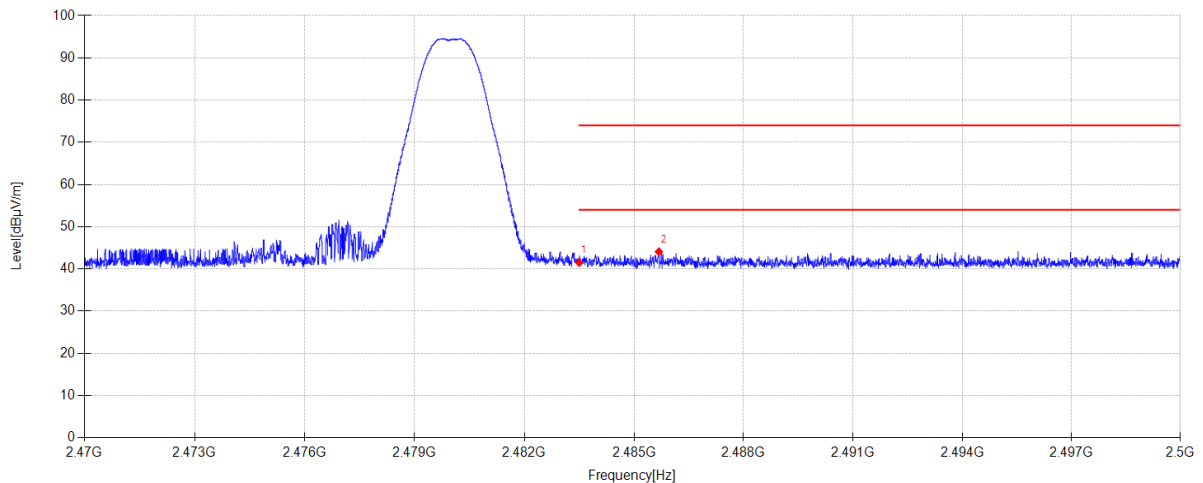

Suspected Data List

NO	Freq. [MHz]	Reading [dBμV/m]	Antenna Factor [dB]	Cable loss [dB]	AMP [dB]	Level [dBμV/m]	Limit [dBμV/m]	Margin [dB]	Detector	Polarity
1	2483.500	10.36	27.53	3.62	0.00	41.51	74.00	32.49	PK	Horizontal
2	2485.681	12.92	27.54	3.62	0.00	44.08	74.00	29.92	PK	Horizontal

Note:

1. Level = Reading + Cable loss + Antenna Factor + AMP
2. If Peak Result complies with AV limit, AV Result is deemed to comply with AV limit.
3. Test setup: RBW: 1 MHz, VBW: 3 MHz, Sweep time: auto.

TR-4-E-009 Radiated Emission Test Result

Test Date: 2025-05-13 **Tested By:** Lin Guoyuan
EUT: BLUETOOTH HEADSET **Model Number:** ENDURANCE PACE
Test Mode: TX BLE 1M 2480MHz Mode **Power Supply:** Battery
Condition: Temp:24.1°C;Humi:49.4% **Test Site:** DDT 3# Chamber
File Path: d:\ts\2025 report date\Q25042425-1E\FCC Above 1G BLE\8
Memo: Sample Number: S25042425-017

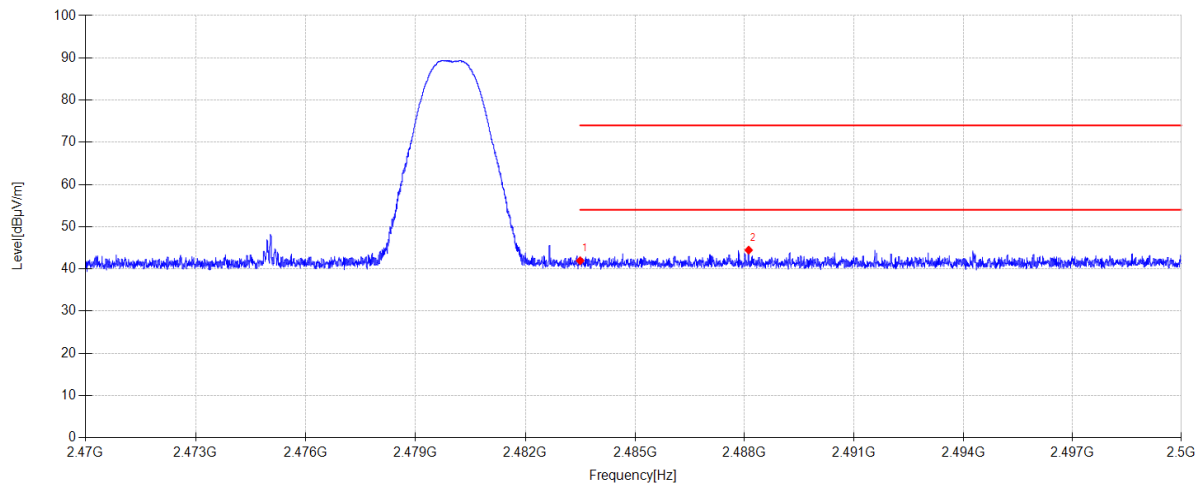

Suspected Data List

NO	Freq. [MHz]	Reading [dBμV/m]	Antenna Factor [dB]	Cable loss [dB]	AMP [dB]	Level [dBμV/m]	Limit [dBμV/m]	Margin [dB]	Detector	Polarity
1	2483.500	10.80	27.53	3.62	0.00	41.95	74.00	32.05	PK	Vertical
2	2488.114	13.29	27.55	3.62	0.00	44.46	74.00	29.54	PK	Vertical

Note:

1. Level = Reading + Cable loss + Antenna Factor + AMP
2. If Peak Result complies with AV limit, AV Result is deemed to comply with AV limit.
3. Test setup: RBW: 1 MHz, VBW: 3 MHz, Sweep time: auto.

TR-4-E-009 Radiated Emission Test Result

Test Date: 2025-05-13 **Tested By:** Lin Guoyuan
EUT: BLUETOOTH HEADSET **Model Number:** ENDURANCE PACE
Test Mode: TX BLE 2M 2478MHz Mode **Power Supply:** Battery
Condition: Temp:24.1°C;Humi:49.4% **Test Site:** DDT 3# Chamber
File Path: d:\ts\2025 report date\Q25042425-1E\FCC Above 1G BLE\5
Memo: Sample Number: S25042425-017

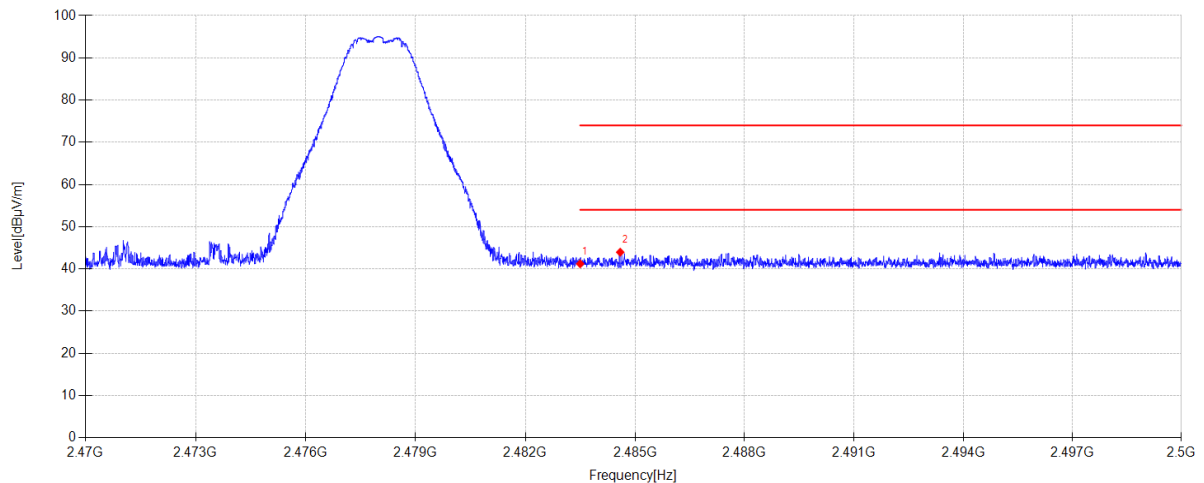

Suspected Data List

NO	Freq. [MHz]	Reading [dBμV/m]	Antenna Factor [dB]	Cable loss [dB]	AMP [dB]	Level [dBμV/m]	Limit [dBμV/m]	Margin [dB]	Detector	Polarity
1	2483.500	10.06	27.53	3.62	0.00	41.21	74.00	32.79	PK	Horizontal
2	2484.595	12.81	27.54	3.62	0.00	43.97	74.00	30.03	PK	Horizontal

Note:

1. Level = Reading + Cable loss + Antenna Factor + AMP
2. If Peak Result complies with AV limit, AV Result is deemed to comply with AV limit.
3. Test setup: RBW: 1 MHz, VBW: 3 MHz, Sweep time: auto.

TR-4-E-009 Radiated Emission Test Result

Test Date: 2025-05-13 **Tested By:** Lin Guoyuan
EUT: BLUETOOTH HEADSET **Model Number:** ENDURANCE PACE
Test Mode: TX BLE 2M 2478MHz Mode **Power Supply:** Battery
Condition: Temp:24.1°C;Humi:49.4% **Test Site:** DDT 3# Chamber
File Path: d:\ts\2025 report date\Q25042425-1E\FCC Above 1G BLE\6
Memo: Sample Number: S25042425-017

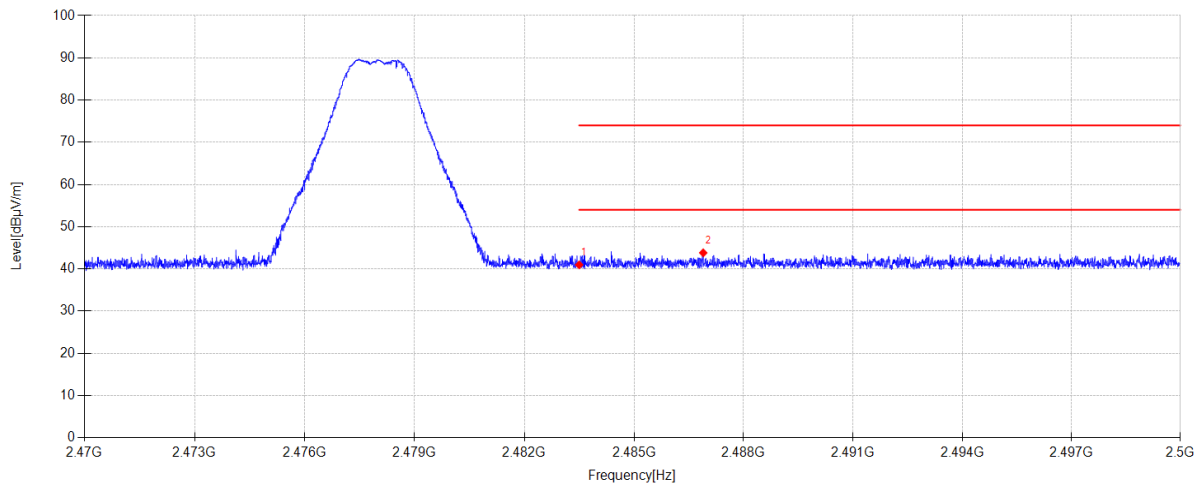

Suspected Data List

NO	Freq. [MHz]	Reading [dBμV/m]	Antenna Factor [dB]	Cable loss [dB]	AMP [dB]	Level [dBμV/m]	Limit [dBμV/m]	Margin [dB]	Detector	Polarity
1	2483.500	9.82	27.53	3.62	0.00	40.97	74.00	33.03	PK	Vertical
2	2486.896	12.65	27.55	3.62	0.00	43.82	74.00	30.18	PK	Vertical

Note:

1. Level = Reading + Cable loss + Antenna Factor + AMP
2. If Peak Result complies with AV limit, AV Result is deemed to comply with AV limit.
3. Test setup: RBW: 1 MHz, VBW: 3 MHz, Sweep time: auto.

14. Power Line Conducted Emissions

14.1. Test equipment

Equipment	Manufacturer	Model No.	Serial No.	Cal Due To
Coaxial signal signal cable	H&S	RG214-5	DDT-ZC01817	2026/03/28
Conducted Radiated Software	Audix	E3	DDT-ZC00562	/
Pulse Limiter	R&S	KH43101	DDT-ZC00747	2026/03/28
EMI Test Receiver	R&S	ESCI	DDT-ZC01972	2026/03/28
Two Line V-Network	R&S	ENV216	DDT-ZC02058	2025/07/08
Two Line V-Network	R&S	ENV216	DDT-ZC00586	2025/07/08

14.2. Block diagram of test setup

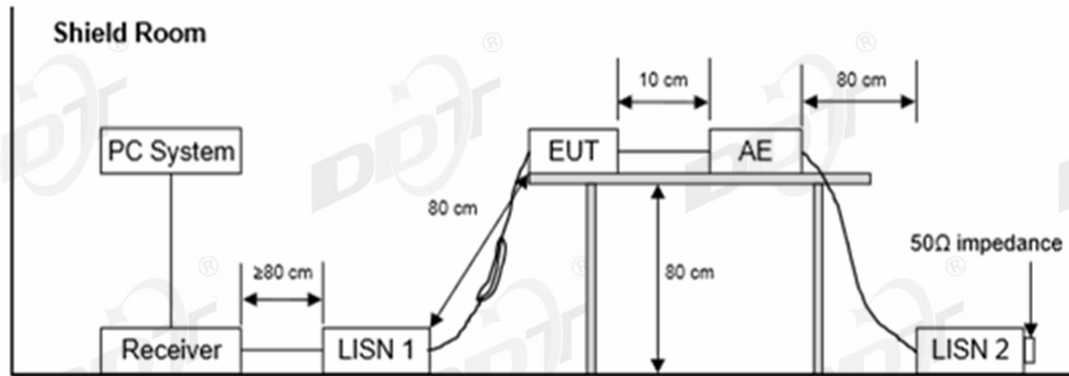

14.3. Limits

Frequency	Quasi-Peak Level	Average Level
	dB(μV)	dB(μV)
150 kHz~500 kHz	66 ~ 56*	56 ~ 46*
500 kHz~5 MHz	56	46
5 MHz~30 MHz	60	50

Note 1: * Decreasing linearly with logarithm of frequency.

Note 2: The lower limit shall apply at the transition frequencies.

14.4. Assistant equipment used for test

Assistant equipment	Manufacturer	Model number	Description	other
Adapter	HUAWEI	HW-100400C01	Huawei fast charging 66W-1#/2# site	Input: 100-240V~50/60Hz, Output: 5V/2A or 9V/2A or 10V/4A MAX

14.5. Test procedure

The EUT and Support equipment, if needed, were put placed on a non-metallic table, 80cm above the ground plane.

All support equipment power received from a second LISN.

Emissions were measured on each current carrying line of the EUT using an EMI Test Receiver connected to the LISN powering the EUT.

The Receiver scanned from 150 kHz to 30 MHz for emissions in each of the test modes.

During the above scans, the emissions were maximized by cable manipulation.

The test mode(s) described in clause 2.4 were scanned during the preliminary test.

After the preliminary scan, we found the test mode producing the highest emission level.

The EUT configuration and worse cable configuration of the above highest emission levels were recorded for reference of the final test.

EUT and support equipment were set up on the test bench as per the configuration with highest emission level in the preliminary test.

A scan was taken on both power lines, Neutral and Line, recording at least the six highest emissions.

Emission frequency and amplitude were recorded into a computer in which correction factors were used to calculate the emission level and compare reading to the applicable limit.

The test data of the worst-case condition(s) was recorded.

The bandwidth of test receiver is set at 9 kHz.

14.6. Test result

PASS. (See below detailed test result)

Note1: All emissions not reported below are too low against the prescribed limits.

Note2: “---” means Peak detection; “---” means Average detection.

Note3: Pre-test AC conducted emission at both voltage AC 120V/60Hz and AC 240V/50Hz, recorded the worst case.

14.7. Test data

TR-4-E-010 Conducted Emission Test Result

Test Site : DDT 5# Shield Room D:\2025 report data\Q25042425-1E\0517 CE.EM6
Test Date : 2025-05-17 **Tested By** : Cut Zhuang
EUT : BLUETOOTH HEADSET **Model Number** : ENDURANCE PACE
Power Supply : AC 120V/60Hz **Test Mode** : Tx mode
Condition : Temp:22.4°C,Humi:56.8% **LISN** : 2023 ENV216 2#/NEUTRAL
Memo : Sample Number: S25042425-017

Data: 6

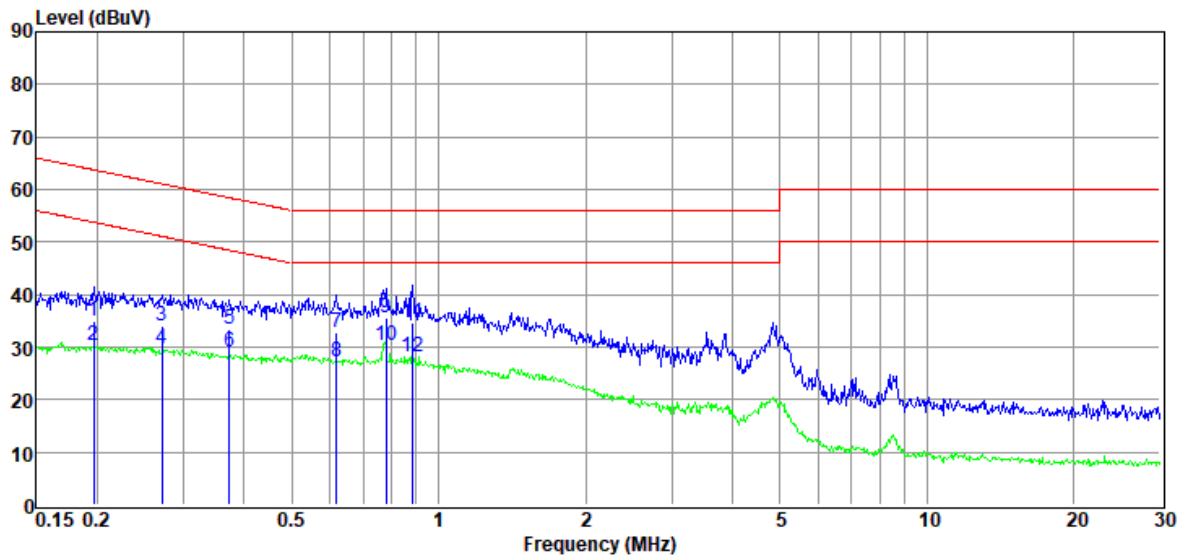

Item (Mark)	Freq. (MHz)	Read Level (dBuV)	LISN Factor (dB)	Cable Loss (dB)	Pulse Limiter Factor (dB)	Result Level (dBuV)	Limit Line (dBuV)	Over Limit (dB)	Detector	Phase
1	0.20	14.86	9.93	0.09	10.06	34.94	63.76	-28.82	QP	NEUTRAL
2	0.20	10.26	9.93	0.09	10.06	30.34	53.76	-23.42	Average	NEUTRAL
3	0.27	13.88	9.97	0.09	10.06	34.00	61.07	-27.07	QP	NEUTRAL
4	0.27	9.69	9.97	0.09	10.06	29.81	51.07	-21.26	Average	NEUTRAL
5	0.37	13.24	10.04	0.09	10.07	33.44	58.43	-24.99	QP	NEUTRAL
6	0.37	8.87	10.04	0.09	10.07	29.07	48.43	-19.36	Average	NEUTRAL
7	0.62	12.54	10.01	0.10	10.06	32.71	56.00	-23.29	QP	NEUTRAL
8	0.62	6.92	10.01	0.10	10.06	27.09	46.00	-18.91	Average	NEUTRAL
9	0.78	15.32	9.97	0.10	10.06	35.45	56.00	-20.55	QP	NEUTRAL
10	0.78	10.05	9.97	0.10	10.06	30.18	46.00	-15.82	Average	NEUTRAL
11	0.88	14.44	9.98	0.11	10.05	34.58	56.00	-21.42	QP	NEUTRAL
12	0.88	8.02	9.98	0.11	10.05	28.16	46.00	-17.84	Average	NEUTRAL

- Note: 1. Result Level = Read Level + LISN Factor + Pulse Limiter Factor + Cable loss.
 2. If QP Result complies with AV limit, AV Result is deemed to comply with AV limit.
 3. Test setup: RBW: 200 Hz (9 kHz—150 kHz), 9 kHz (150 kHz—30 MHz).
 4. Step size: 80Hz (0.009MHz-0.15MHz), 4 kHz (0.15MHz-30MHz), Scan time: auto.

TR-4-E-010 Conducted Emission Test Result

Test Site : DDT 5# Shield Room D:\2025 report data\Q25042425-1E\0517 CE.EM6
Test Date : 2025-05-17 **Tested By** : Cut Zhuang
EUT : BLUETOOTH HEADSET **Model Number** : ENDURANCE PACE
Power Supply : AC 120V/60Hz **Test Mode** : Tx mode
Condition : Temp:22.4°C,Humi:56.8% **LISN** : 2023 ENV216 2#/LINE
Memo : Sample Number: S25042425-017

Data: 8

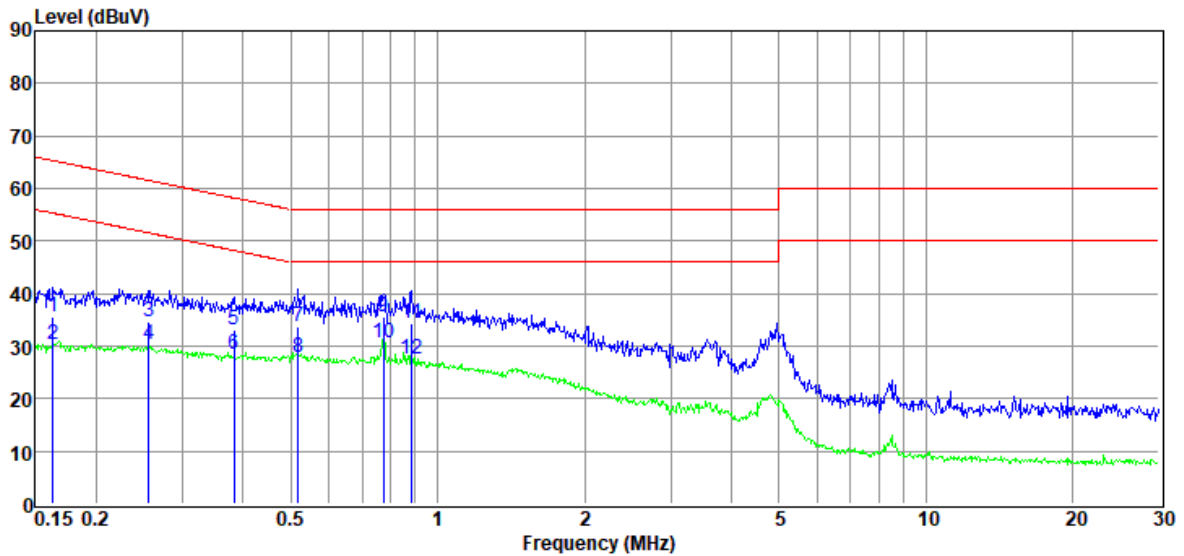

Item (Mark)	Freq. (MHz)	Read Level (dB μ V)	LISN Factor (dB)	Cable Loss (dB)	Pulse Limiter Factor (dB)	Result Level (dB μ V)	Limit Line (dB μ V)	Over Limit (dB)	Detector	Phase
1	0.16	15.50	9.95	0.09	10.06	35.60	65.30	-29.70	QP	LINE
2	0.16	10.26	9.95	0.09	10.06	30.36	55.30	-24.94	Average	LINE
3	0.26	14.51	9.99	0.09	10.06	34.65	61.56	-26.91	QP	LINE
4	0.26	10.12	9.99	0.09	10.06	30.26	51.56	-21.30	Average	LINE
5	0.38	12.89	9.97	0.10	10.07	33.03	58.21	-25.18	QP	LINE
6	0.38	8.42	9.97	0.10	10.07	28.56	48.21	-19.65	Average	LINE
7	0.52	13.60	9.98	0.10	10.07	33.75	56.00	-22.25	QP	LINE
8	0.52	7.65	9.98	0.10	10.07	27.80	46.00	-18.20	Average	LINE
9	0.78	15.50	9.97	0.10	10.06	35.63	56.00	-20.37	QP	LINE
10	0.78	10.48	9.97	0.10	10.06	30.61	46.00	-15.39	Average	LINE
11	0.88	14.28	9.91	0.11	10.05	34.35	56.00	-21.65	QP	LINE
12	0.88	7.45	9.91	0.11	10.05	27.52	46.00	-18.48	Average	LINE

- Note: 1. Result Level = Read Level + LISN Factor + Pulse Limiter Factor + Cable loss.
 2. If QP Result complies with AV limit, AV Result is deemed to comply with AV limit.
 3. Test setup: RBW: 200 Hz (9 kHz—150 kHz), 9 kHz (150 kHz—30 MHz).
 4. Step size: 80Hz (0.009MHz-0.15MHz), 4 kHz (0.15MHz-30MHz), Scan time: auto.

16. Photos of the EUT

Please refer to DDT-Q25042425-2E appendix I

-----End Report-----