

# FCC AND IC CERTIFICATION TEST REPORT

## FOR

<b>Applicant</b>	:	Harman International Industries, Incorporated
<b>Address</b>	:	8500 Balboa Boulevard, Northridge, CA 91329, UNITED STATES
<b>Equipment under Test</b>	:	Bluetooth Headset
<b>Model No.</b>	:	Duet BT
<b>Trade Mark</b>	:	JBL
<b>FCC ID</b>	:	APIJBLDUETBT
<b>IC</b>	:	6132A-JBLDUETBT
<b>Manufacturer</b>	:	Harman International Industries, Incorporated
<b>Address</b>	:	8500 Balboa Boulevard, Northridge, CA 91329, UNITED STATES

**Issued By: Dongguan Dongdian Testing Service Co., Ltd.**

**Add:** No. 17, Zongbu Road 2, Songshan Lake Sci&Tech, Industry Park, Dongguan City,  
Guangdong Province, China, 523808

**Tel:** +86-0769-22891499 [Http://www.dgddt.com](http://www.dgddt.com)

# REPORT

## TABLE OF CONTENTS

	Test report declares.....	4
1.	Summary of test results .....	5
2.	General test information.....	6
2.1.	Description of EUT .....	6
2.2.	Accessories of EUT.....	6
2.3.	Assistant equipment used for test.....	6
2.4.	Block diagram of EUT configuration for test .....	6
2.5.	Deviations of test standard .....	7
2.6.	Test environment conditions .....	7
2.7.	Test laboratory.....	7
2.8.	Measurement uncertainty .....	7
3.	Equipment used during test.....	8
4.	Maximum Peak Output Power .....	9
4.1.	Block diagram of test setup.....	9
4.2.	Limits .....	9
4.3.	Test Procedure.....	9
4.4.	Test Result.....	9
5.	20dB Bandwidth and 99% Bandwidth.....	10
5.1.	Block diagram of test setup.....	10
5.2.	Limits .....	10
5.3.	Test Procedure.....	10
5.4.	Test Result.....	10
5.5.	Original test data .....	11
6.	Carrier Frequency Separation.....	13
6.1.	Block diagram of test setup.....	13
6.2.	Limits .....	13
6.3.	Test Procedure.....	13
6.4.	Test Result.....	13
6.5.	Original test data .....	13
7.	Number Of Hopping Channel .....	14
7.1.	Block diagram of test setup.....	14
7.2.	Limits .....	14
7.3.	Test Procedure.....	14
7.4.	Test Result.....	14
7.5.	Original test data .....	14
8.	Dwell Time.....	16
8.1.	Block diagram of test setup .....	16

8.2.	Limits .....	16
8.3.	Test Procedure.....	16
8.4.	Test Result.....	16
8.5.	Original test data .....	17
9.	Radiated emission .....	19
9.1.	Block diagram of test setup.....	19
9.2.	Limit .....	20
9.3.	Test Procedure.....	21
9.4.	Test result .....	22
10.	Band Edge Compliance (radiated method) .....	26
10.1.	Block diagram of test setup.....	26
10.2.	Limit .....	26
10.3.	Test Procedure.....	26
10.4.	Test result .....	26
11.	Band Edge Compliance (conducted method).....	35
11.1.	Block diagram of test setup.....	35
11.2.	Limit .....	35
11.3.	Test result .....	35
11.4.	Original test data .....	35
12.	Power Line Conducted Emission .....	39
12.1.	Block diagram of test setup.....	39
12.2.	Power Line Conducted Emission Limits(Class B).....	39
12.3.	Test Procedure.....	39
12.4.	Test Result.....	40
13.	Antenna Requirements .....	43
13.1.	Limit .....	43
13.2.	Result.....	43

## TEST REPORT DECLARE

<b>Applicant</b>	:	Harman International Industries, Incorporated
<b>Address</b>	:	8500 Balboa Boulevard, Northridge, CA 91329, UNITED STATES
<b>Equipment under Test</b>	:	Bluetooth Headset
<b>Model No.</b>	:	Duet BT
<b>Trade Mark</b>	:	JBL
<b>Manufacturer</b>	:	Harman International Industries, Incorporated
<b>Address</b>	:	8500 Balboa Boulevard, Northridge, CA 91329, UNITED STATES

**Test Standard Used:**

FCC Rules and Regulations Part 15 Subpart C: 2015, RSS-247 Issue 1 May 2015.

**Test procedure used:**

ANSI C63.10:2013, ANSI C63.4:2014, RSS-Gen Issue 4, Nov. 2014.

**We Declare:**

The equipment described above is tested by Dongguan Dongdian Testing Service Co., Ltd and in the configuration tested the equipment complied with the standards specified above. The test results are contained in this test report and Dongguan Dongdian Testing Service Co., Ltd is assumed of full responsibility for the accuracy and completeness of these tests.

**After test and evaluation, our opinion is that the equipment provided for test compliance with the requirement of the above FCC&IC standards.**

<b>Report No:</b>	DDT-R16Q0720-6E5		
<b>Date of Test:</b>	July 9, 2016-Aug. 9, 2016	<b>Date of Report:</b>	Aug. 9, 2016

*Prepared By:*



*Leo Liu/Engineer*



*Kevin Peng/EMC Manager*

Note: This report applies to above tested sample only. This report shall not be reproduced in parts without written approval of Dongguan Dongdian Testing Service Co., Ltd.

## 1. Summary of test results

Description of Test Item	Standard	Results
Maximum Peak Output Power	FCC Part 15: 15.247(b)(1) ANSI C63.10:2013 ANSI C63.4:2014 RSS-247 Issue 1 clause 5.1	PASS
20dB Bandwidth and 99% Bandwidth	FCC Part 15: 15.215 ANSI C63.10:2013 ANSI C63.4:2014 RSS-247 Issue 1 clause 5.1	PASS
Carrier Frequency Separation	FCC Part 15: 15.247(a)(1) ANSI C63.10:2013 ANSI C63.4:2014 RSS-247 Issue 1 clause 5.1	PASS
Number Of Hopping Channel	FCC Part 15: 15.247(a)(1)(iii) ANSI C63.10:2013 ANSI C63.4:2014 RSS-247 Issue 1 clause 5.1	PASS
Dwell Time	FCC Part 15: 15.247(a)(1)(iii) ANSI C63.10:2013 ANSI C63.4:2014 RSS-247 Issue 1 clause 5.1	PASS
Radiated Emission	FCC Part 15: 15.209 FCC Part 15: 15.247(d) ANSI C63.10:2013 ANSI C63.4:2014 RSS-247 Issue 1 clause 5.1 RSS-Gen Issue 4 clause 7.2.2 RSS-Gen Issue 4 clause 7.2.5	PASS
Band Edge Compliance	FCC Part 15: 15.247(d) ANSI C63.10:2013 ANSI C63.4:2014 RSS-247 Issue 1 clause 5.1 RSS-Gen Issue 4 clause 7.2.2 RSS-Gen Issue 4 clause 7.2.5	PASS
Power Line Conducted Emissions	FCC Part 15: 15.207 ANSI C63.10:2013 ANSI C63.4:2014 RSS-Gen Issue 4 clause 7.2.4	PASS
Antenna requirement	FCC Part 15: 15.203 ANSI C63.4:2014 RSS-Gen Issue 4 clause 7.1.2	PASS

## 2. General test information

### 2.1. Description of EUT

EUT* Name	: Bluetooth Headset
Model Number	: Duet BT
EUT function description	: Please reference user manual of this device
Power supply	: DC 5V from adapter DC 3.7V from built-in battery
Radio Specification	: Bluetooth V4.0 (BDR/EDR)
Operation frequency	: 2402MHz -2480MHz
Modulation	: GFSK, $\pi/4$ QPSK, 8-DPSK
Data rate	: 1Mbps, 2Mbps, 3Mbps
Antenna Type	: Integrated antenna, maximum PK gain: 2.93dBi
Date of Receipt	: July 9, 2016
Sample Type	: Series production

Note: EUT is the ab. of equipment under test.

### 2.2. Accessories of EUT

Description of Accessories	Manufacturer	Model number or Type	Serial No.	Other
/	/	/	/	/

### 2.3. Assistant equipment used for test

Description of Assistant equipment	Manufacturer	Model number or Type	EMC Compliance	Other
Adapter	GPT	F5V-2.3C-1U	/	Output: 5V/2.3A

### 2.4. Block diagram of EUT configuration for test



Test software: BlueSuite2.6.0

The test software was used to control EUT work in Continuous TX mode, and select test channel, wireless mode as blow table.

Tested mode, channel, information		
Mode	Channel	Frequency (MHz)
GFSK hopping on Tx Mode	CH0 to CH78	2402 to 2480
$\pi/4$ QPSK Hopping on TX mode	CH0 to CH78	2402 to 2480
8-DPSK hopping on Tx Mode	CH0 to CH78	2402 to 2480
GFSK hopping off Tx Mode	CH0	2402
	CH39	2441
	CH78	2480
$\pi/4$ QPSK hopping off Tx Mode	CH0	2402
	CH39	2441
	CH78	2480
8-DPSK hopping off Tx Mode	CH0	2402
	CH39	2441
	CH78	2480

Note: For  $\pi/4$  QPSK its same modulation type with 8-DPSK, and based exploratory test, there is no significant difference of that two types test result, so except output power, all other items final test were only performed with the worse case 8-DPSK and GFSK.

## 2.5. Deviations of test standard

No Deviation.

## 2.6. Test environment conditions

During the measurement the environmental conditions were within the listed ranges:

Temperature range:	21-25°C
Humidity range:	40-75%
Pressure range:	86-106kPa

## 2.7. Test laboratory

Dongguan Dongdian Testing Service Co., Ltd

Add: No. 17, Zongbu Road 2, Songshan Lake Sci&Tech, Industry Park, Dongguan City, Guangdong Province, China, 523808 Tel: +86-0769-22891499 <http://www.dgddt.com>

FCC Registration Number: 270092 Industry Canada site registration number: 10288A-1

## 2.8. Measurement uncertainty

Test Item	Uncertainty
Bandwidth	$\pm 1.1\%$
Peak Output Power(Conducted)(Spectrum analyzer)	0.86dB(10 MHz $\leq$ f < 3.6GHz);
	1.38dB(3.6GHz $\leq$ f < 8GHz)
Peak Output Power(Conducted)(Power Sensor)	0.74dB
Dwell Time	$\pm 0.6\%$
Conducted spurious emissions	0.86dB(10 MHz $\leq$ f < 3.6GHz);
	1.40dB(3.6GHz $\leq$ f < 8GHz)
	1.66dB(8GHz $\leq$ f < 22GHz)

Uncertainty for radio frequency (RBW<20KHz)	3×10 <sup>-8</sup>
Temperature	±0.4℃
Humidity	±2%
Uncertainty for Radiation Emission test (30MHz-1GHz)	±3.14 dB (Antenna Polarize: V)
	±3.16 dB (Antenna Polarize: H)
Uncertainty for Radiation Emission test (1GHz-18GHz)	±4.14dB(1-6GHz)
	±4.46dB (6GHz-18Gz)
Uncertainty for Power line conduction emission test	2.44dB (150KHz-30MHz)
Note: This uncertainty represents an expanded uncertainty expressed at approximately the 95% confidence level using a coverage factor of k=2.	

### 3. Equipment used during test

Equipment	Manufacturer	Model No.	Serial No.	Last Cal.	Cal. Interval
<b>RF Connected Test</b>					
Spectrum analyzer	R&S	FSU26	1166.1660.26	2015/10/24	1Year
Vertor Signal Generator	R&S	SMBV100A	1407.6004K02	2015/10/24	1Year
RF Signal Generator	R&S	SMR20	1104.0002.20	2015/10/24	1Year
Power Sensor	Agilent	U2021XA	MY55150010	2016/04/18	1Year
Power Sensor	Agilent	U2021XA	MY55150011	2016/04/19	1Year
DC Power Source	MATRIS	MPS-3005L-3	D813058W	2015/10/24	1Year
Attenuator	Mini-Circuits	BW-S10W2	101109	2015/08/18	1Year
RF Cable	Micable	C10-01-01-1	100309	2015/08/18	1Year
Test Software	JS Tonscend	JS1120-2	Ver.2.5	N/A	N/A
USB Data acquisition	Agilent	U2531A	TW55043503	N/A	N/A
Auto control Unit	JS Tonscend	JS0806-2	158060010	N/A	N/A
<b>Radiated Emission Test</b>					
EMI Test Receiver	R&S	ESU8	100316	2015/10/24	1Year
Spectrum analyzer	R&S	FSU26	1166.1660.26	2015/10/24	1Year
Trilog Broadband Antenna	Schwarzbeck	VULB9163	9163-462	2016/05/30	1 Year
Active Loop antenna	Schwarzbeck	FMZB-1519	1519-038	2015/10/24	1 Year
Double Ridged Horn Antenna	R&S	HF907	100276	2015/10/31	1 Year
Pre-amplifier	A.H.	PAM-0118	360	2015/08/18	1 Year
RF Cable	HUBSER	CP-X2	W11.03	2015/10/24	1Year
RF Cable	HUBSER	CP-X1	W12.02	2015/10/24	1 Year
MI Cable	HUBSER	C10-01-01-1M	1091629	2015/10/24	1 Year
Test software	Audix	E3	V 6.11111b	/	/
<b>Power Line Conducted Emissions Test</b>					
Test Receiver	R&S	ESU8	100316	2015/10/24	1 Year
LISN 1	R&S	ENV216	101109	2015/10/24	1 Year
LISN 2	R&S	ESH2-Z5	100309	2015/10/24	1 Year
Pulse Limiter	R&S	ESH3-Z2	101242	2015/10/24	1 Year
CE Cable 1	HUBSER	ESU8/RF2	W10.01	2015/10/24	1 Year
Test software	Audix	E3	V 6.11111b	/	/

## 4. Maximum Peak Output Power

### 4.1. Block diagram of test setup

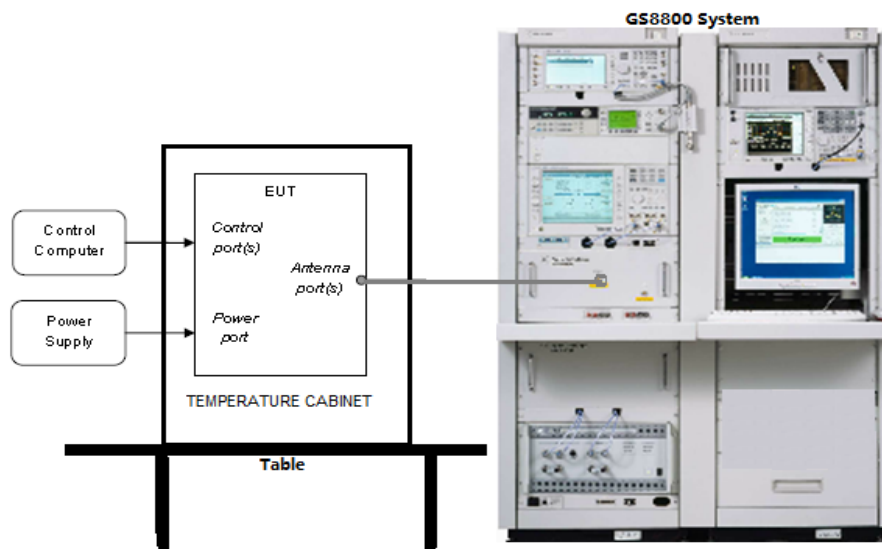

### 4.2. Limits

For frequency hopping systems operating in the 2400-2483.5 MHz band employing at least 75 non-overlapping hopping channels, and all frequency hopping systems in the 5725-5850 MHz band: 1 watt. For all other frequency hopping systems in the 2400-2483.5 MHz band: 0.125 watts, the e.i.r.p shall not exceed 4W.

### 4.3. Test Procedure

- (1) Connect EUT's antenna output to spectrum analyzer by RF cable.
- (2) Measure the maximum output power of EUT by spectrum analyzer with PK detector and RBW=2MHz(above 20dB bandwidth of measured signal), VBW=3MHz

Note: The attenuator loss was inputted into spectrum analyzer as amplitude offset.

### 4.4. Test Result

Mode	Freq (MHz)	Result (dBm)	Limit (dBm)	Conclusion
GFSK	2402	1.830	21	PASS
	2441	2.690	21	PASS
	2480	3.025	21	PASS
$\pi/4$ QPSK	2402	1.404	21	PASS
	2441	2.124	21	PASS
	2480	3.031	21	PASS
8-DPSK	2402	1.670	21	PASS
	2441	2.360	21	PASS
	2480	3.010	21	PASS
Test Date : Aug. 8, 2016		Test Engineer : Toby Ren		

## 5. 20dB Bandwidth and 99% Bandwidth

### 5.1. Block diagram of test setup

Same as section 4.1

### 5.2. Limits

Intentional radiators operating under the alternative provisions to the general emission limits, as contained in § 15.217 through 15.257 and in Subpart E of this part, must be designed to ensure that the 20 dB bandwidth of the emission, or whatever bandwidth may otherwise be specified in the specific rule section under which the equipment operates, is contained within the frequency band designated in the rule section under which the equipment is operated.

### 5.3. Test Procedure

- (1) Connect EUT's antenna output to spectrum analyzer by RF cable.
- (2) The bandwidth of the fundamental frequency was measured by spectrum analyzer with 30 kHz RBW and 100 kHz VBW. The 20dB bandwidth is defined as the total spectrum the power of which is higher than peak power minus 20dB.

### 5.4. Test Result

Mode	Freq (MHz)	20dB bandwidth Result (MHz)	99% bandwidth Result (MHz)	Limit (MHz)	Margin (MHz)	Conclusion
GFSK	2402	1.114	0.954	/	/	PASS
	2441	1.114	0.954	/	/	PASS
	2480	1.114	0.954	/	/	PASS
8-DPSK	2402	1.370	1.208	/	/	PASS
	2441	1.370	1.206	/	/	PASS
	2480	1.372	1.206	/	/	PASS
Test Date : Aug. 8, 2016			Test Engineer: Leo			

5.5. Original test data

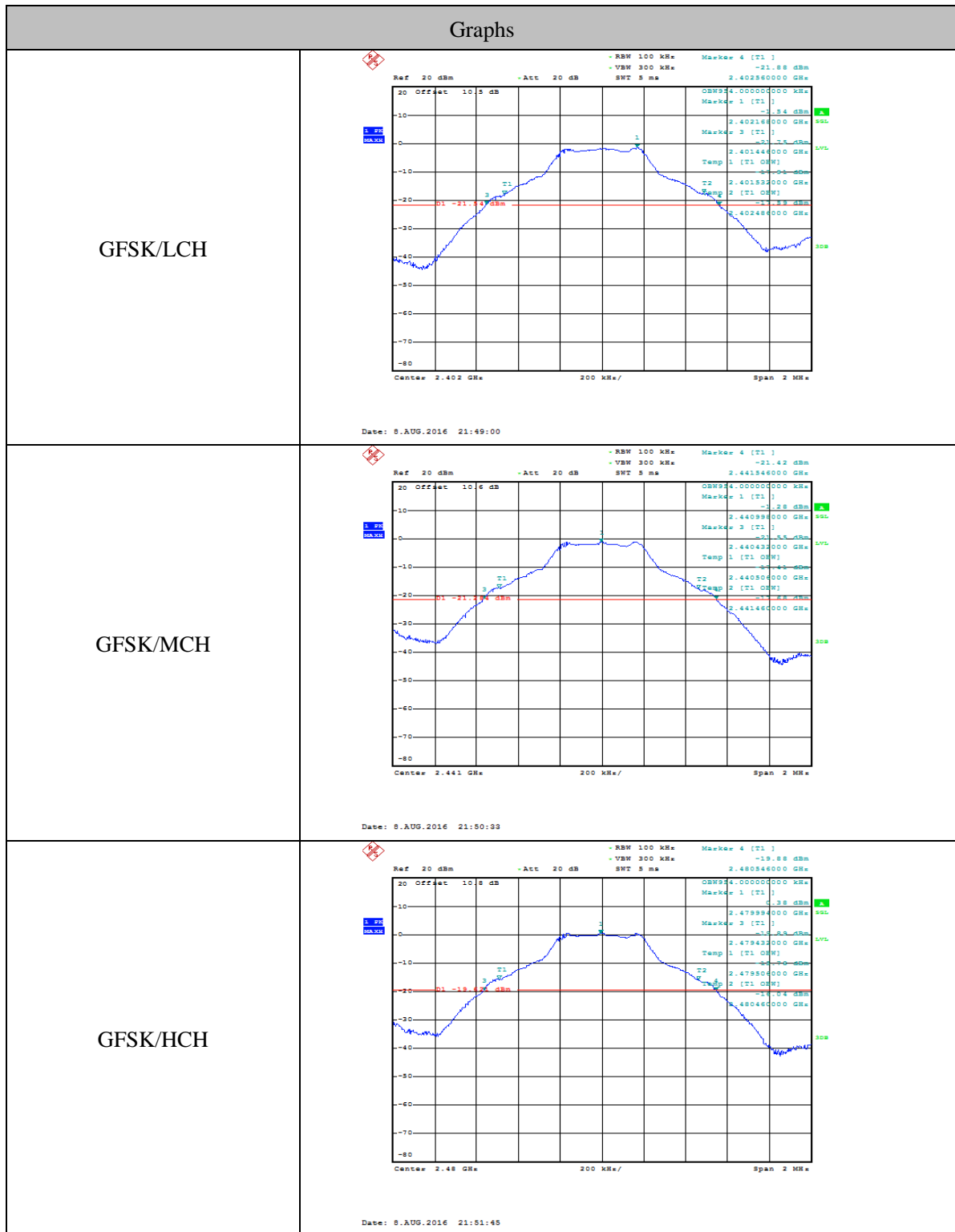

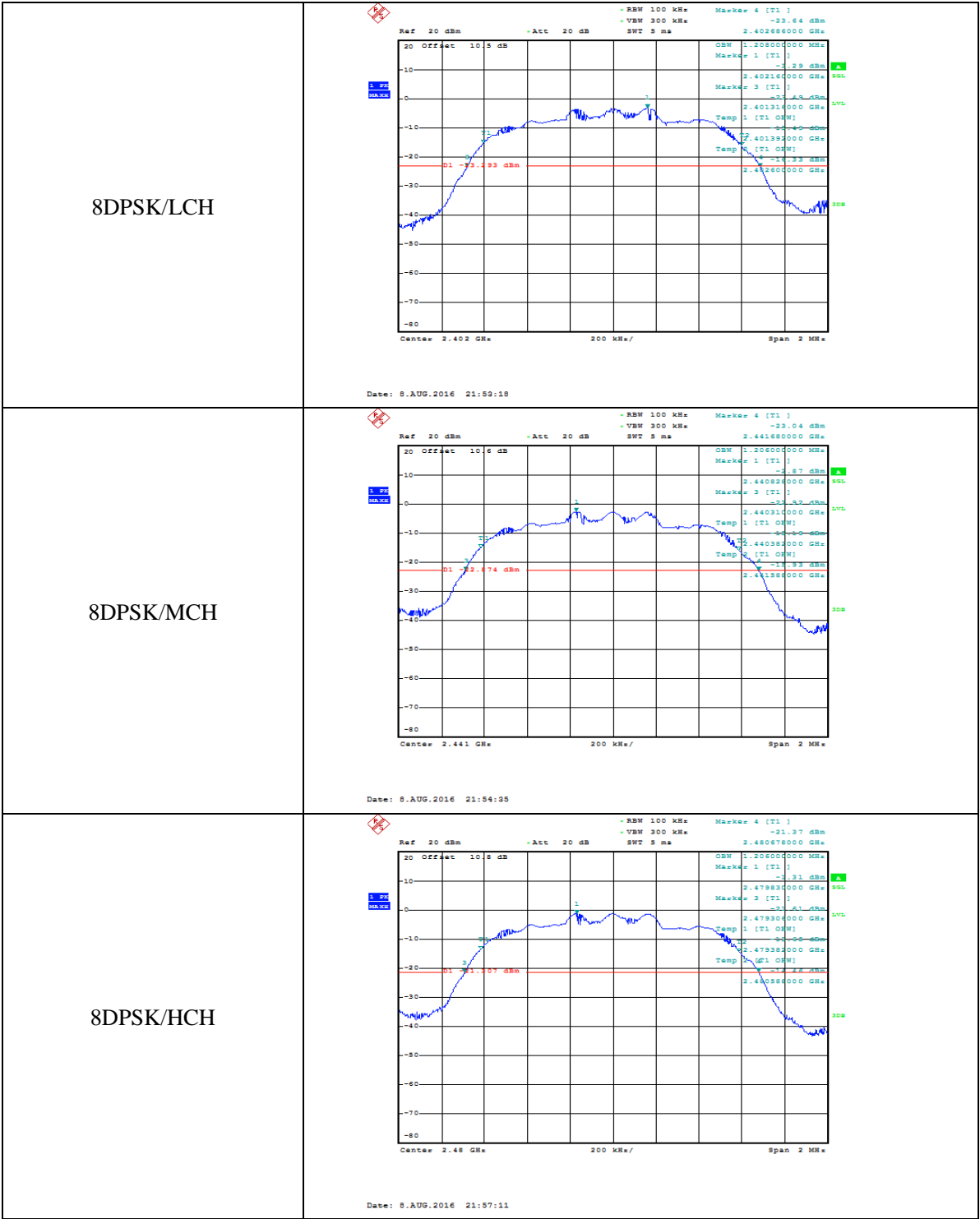

## 6. Carrier Frequency Separation

### 6.1. Block diagram of test setup

Same as section 4.1

### 6.2. Limits

Frequency hopping systems shall have hopping channel carrier frequencies separated by a minimum of 25 kHz or the 20 dB bandwidth of the hopping channel, whichever is greater. Alternatively, frequency hopping systems operating in the 2400-2483.5 MHz band may have hopping channel carrier frequencies that are separated by 25 kHz or two-thirds of the 20 dB bandwidth of the hopping channel, whichever is greater, provided the systems operate with an output power no greater than 125 mW.

### 6.3. Test Procedure

- (1) Connect EUT's antenna output to spectrum analyzer by RF cable.
- (2) The carrier frequency was measured by spectrum analyzer with 100 KHz RBW and 300 KHz VBW.

### 6.4. Test Result

Mode	Channel separation (MHz)	20dB Bandwidth (MHz)	Limit (MHz) 2/3 of 20dB bandwidth	Conclusion
GFSK	1.000	1.114	0.743	PASS
8-DPSK	0.998	1.372	0.915	PASS

Test Date : Aug. 8, 2016 Test Engineer : Toby Ren

### 6.5. Original test data

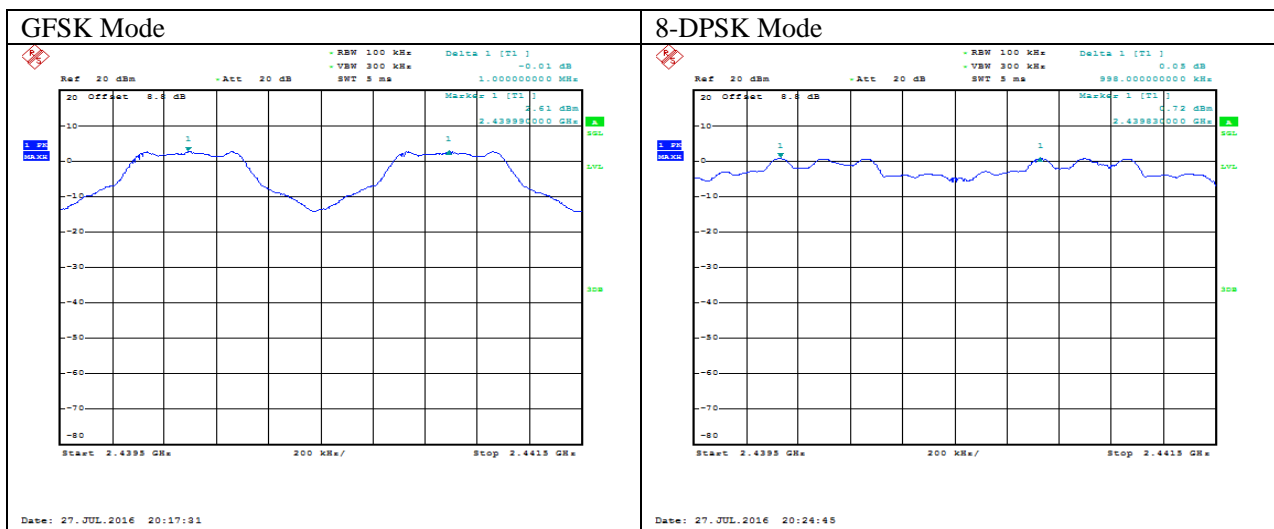

## 7. Number Of Hopping Channel

### 7.1. Block diagram of test setup

Same as section 4.1

### 7.2. Limits

Frequency hopping systems in the 2400-2483.5 MHz band shall use at least 15 channels.

### 7.3. Test Procedure

- (1) Connect EUT's antenna output to spectrum analyzer by RF cable.
- (2) The number of hopping channel was measured by spectrum analyzer with 100 kHz RBW and 300 kHz VBW.

### 7.4. Test Result

Mode	Number of hopping channel	Limit	Conclusion
GFSK	79	>15	PASS
8-DPSK	79	>15	PASS
Test Date : Aug. 8, 2016			Test Engineer : Toby Ren

### 7.5. Original test data

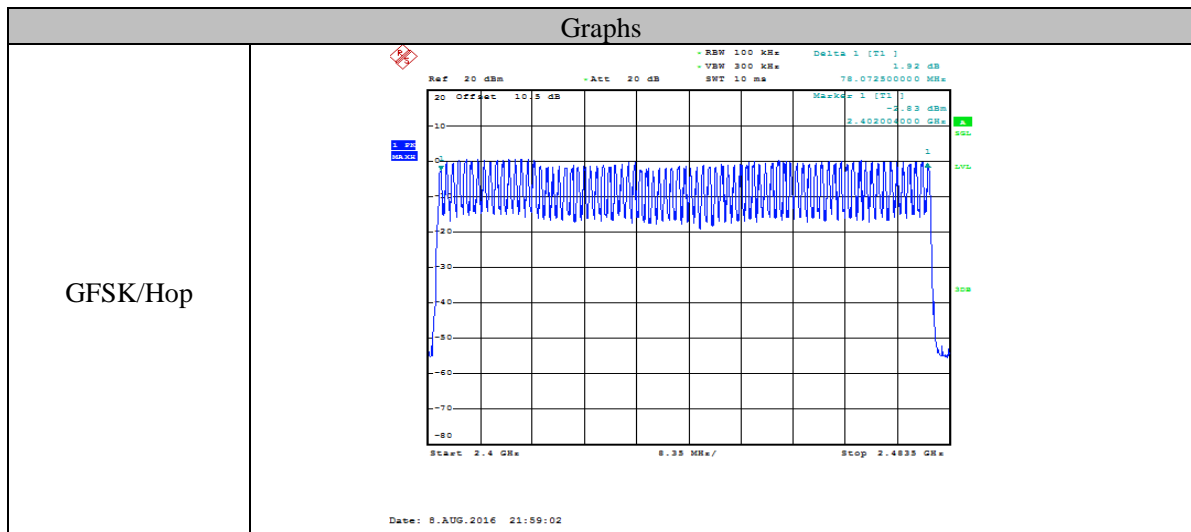

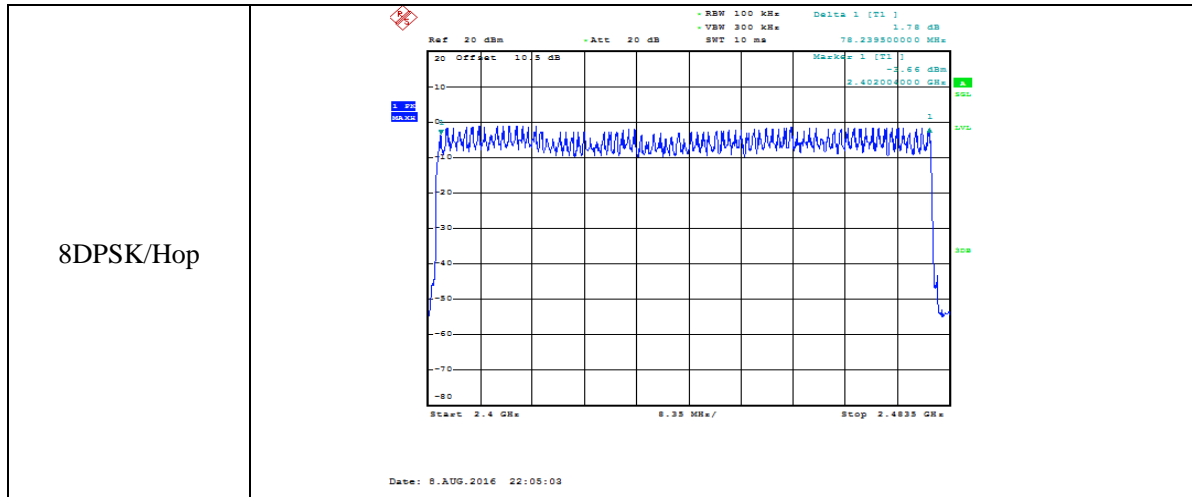

## 8. Dwell Time

### 8.1. Block diagram of test setup

Same as section 4.1

### 8.2. Limits

The average time of occupancy on any channel shall not be greater than 0.4 seconds within a period of 0.4 seconds multiplied by the number of hopping channels employed.

### 8.3. Test Procedure

- (1) Connect EUT's antenna output to spectrum analyzer by RF cable.
- (2) Measure the hopping number and on time of each pulse with spectrum analyzer in zero span set, and calculate dwell time with formula Dwell time = total hops \*pulse's on time.

DH1 Packet permit maximum  $1600 / 79 / 2 = 10.12$  hops per second in each channel (1 time slot RX, 1 time slot TX). So, total hops is  $10.12 \times 31.6 = 320$ .

DH3 Packet permit maximum  $1600 / 79 / 4 = 5.06$  hops per second in each channel (3 time slots RX, 1 time slot TX). So, total hops is  $5.06 \times 31.6 = 160$ .

DH5 Packet permit maximum  $1600 / 79 / 6 = 3.37$  hops per second in each channel (5 time slots RX, 1 time slot TX). So, total hops is  $3.37 \times 31.6 = 106.6$ .

3DH1 Packet permit maximum  $1600 / 79 / 2 = 10.12$  hops per second in each channel (1 time slot RX, 1 time slot TX). So, total hops is  $10.12 \times 31.6 = 320$ .

3DH3 Packet permit maximum  $1600 / 79 / 4 = 5.06$  hops per second in each channel (3 time slots RX, 1 time slot TX). So, total hops is  $5.06 \times 31.6 = 160$ .

3DH5 Packet permit maximum  $1600 / 79 / 6 = 3.37$  hops per second in each channel (5 time slots RX, 1 time slot TX). So, total hops is  $3.37 \times 31.6 = 106.6$ .

### 8.4. Test Result

Mode	Dwell time (s)	Pulse's on time (ms)	Total hops	Limit	Conclusion
DH1	0.125	0.39	320	<400ms	PASS
DH3	0.264	1.65	160	<400ms	PASS
DH5	0.307	2.88	106.6	<400ms	PASS
3-DH1	0.128	0.40	320	<400ms	PASS
3-DH3	0.266	1.66	160	<400ms	PASS
3-DH5	0.309	2.90	106.6	<400ms	PASS
Test Date : Aug. 8, 2016			Test Engineer : Toby Ren		
Note: Dwell time = total hops *pulse's on time.					

8.5. Original test data

Graphs	
DH1/MCH	<p style="text-align: center;">Date: 27.JUL.2016 20:54:07</p>
DH3/MCH	<p style="text-align: center;">Date: 27.JUL.2016 20:55:25</p>
DH5/MCH	<p style="text-align: center;">Date: 8.AUG.2016 21:50:51</p>

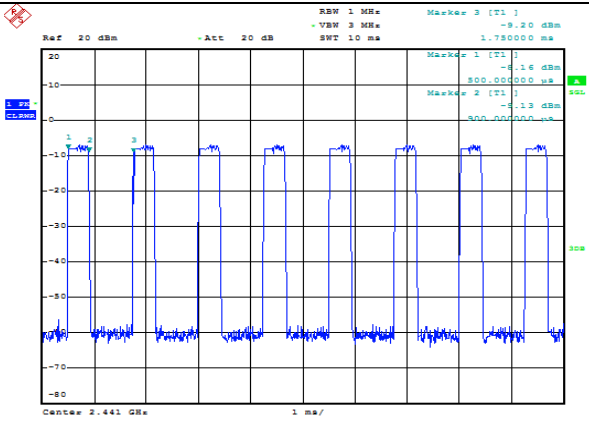
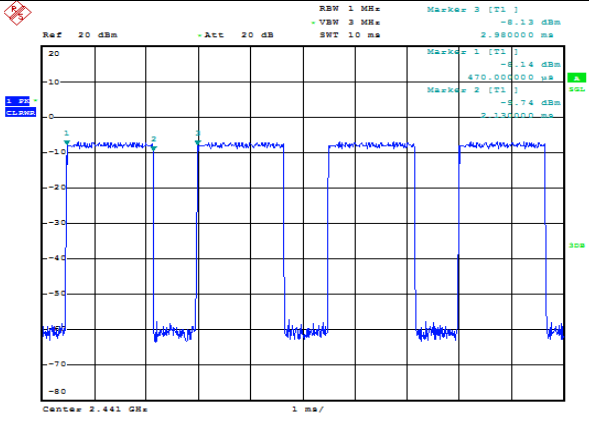
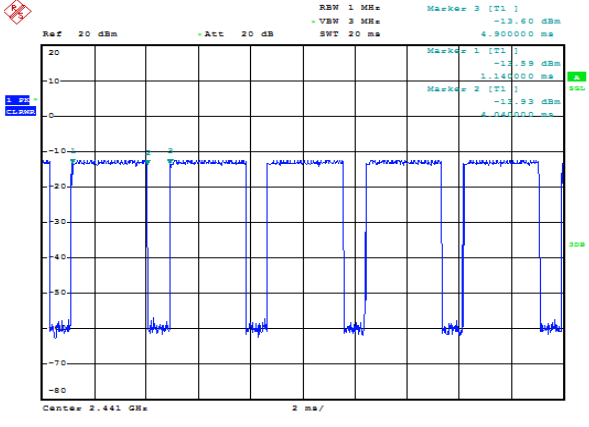
<p>3DH1/MCH</p>	 <p>Ref 20 dBm -Att 20 dB RBW 1 MHz Marker 3 [T1] -9.20 dBm -VBW 3 MHz SWT 10 ms 1.750000 ms</p> <p>Marker 1 [T1] -4.16 dBm 800.000000 us Marker 2 [T1] -9.13 dBm 800.000000 us</p> <p>Center 2.441 GHz 1 ms/</p> <p>Date: 27.JUL.2016 20:56:44</p>
<p>3DH3/MCH</p>	 <p>Ref 20 dBm -Att 20 dB RBW 1 MHz Marker 3 [T1] -8.13 dBm -VBW 3 MHz SWT 10 ms 2.950000 ms</p> <p>Marker 1 [T1] -4.14 dBm 470.000000 us Marker 2 [T1] -7.74 dBm 2.130000 ms</p> <p>Center 2.441 GHz 1 ms/</p> <p>Date: 27.JUL.2016 20:57:25</p>
<p>3DH5/MCH</p>	 <p>Ref 20 dBm -Att 20 dB RBW 1 MHz Marker 3 [T1] -13.60 dBm -VBW 3 MHz SWT 20 ms 4.900000 ms</p> <p>Marker 1 [T1] -11.59 dBm 1.140000 ms Marker 2 [T1] -11.93 dBm 4.040000 ms</p> <p>Center 2.441 GHz 2 ms/</p> <p>Date: 8.AUG.2016 21:54:53</p>

## 9. Radiated emission

### 9.1. Block diagram of test setup

In 3m Anechoic Chamber Test Setup Diagram for 9KHz-30MHz

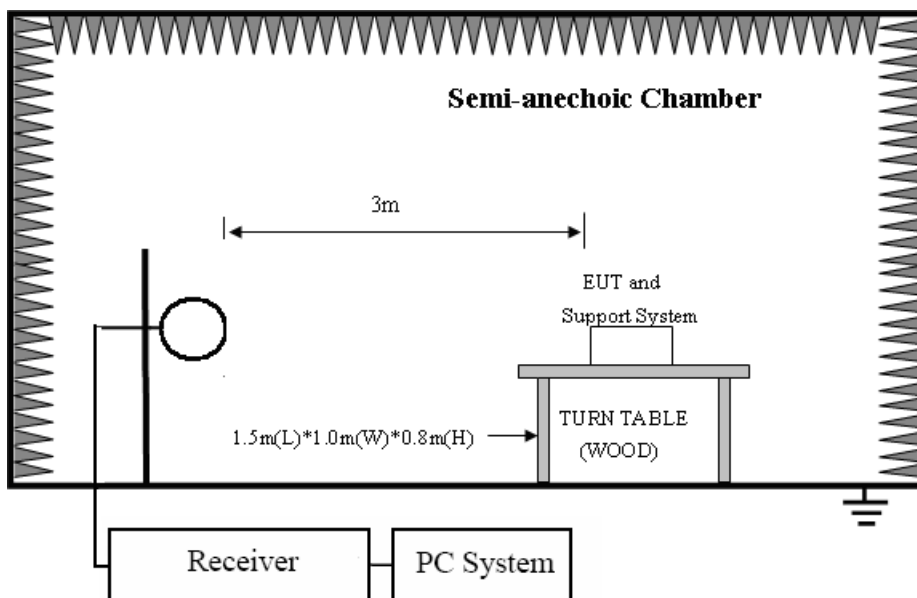

In 3m Anechoic Chamber Test Setup Diagram for below 1GHz

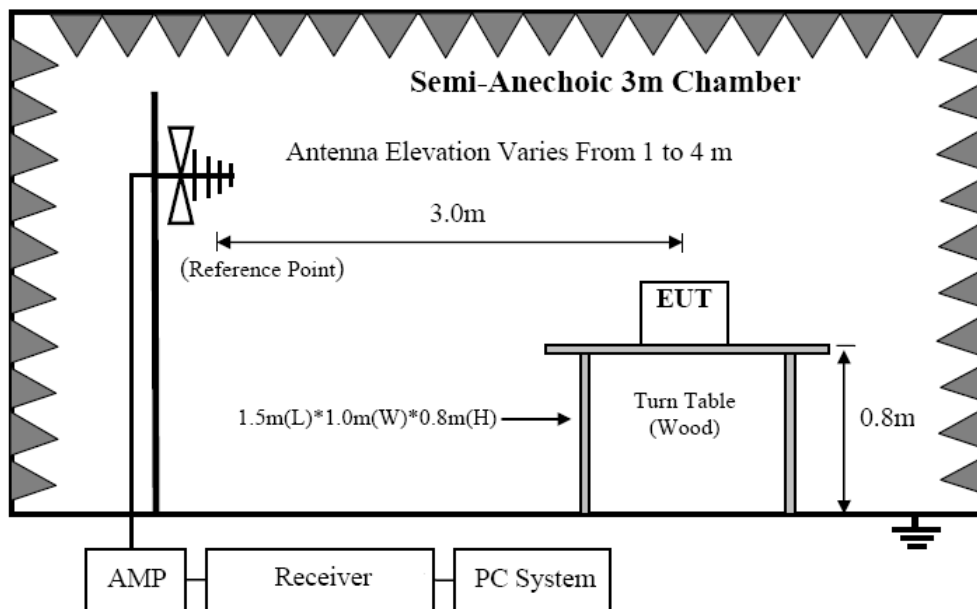

In 3m Anechoic Chamber Test Setup Diagram for frequency above 1GHz

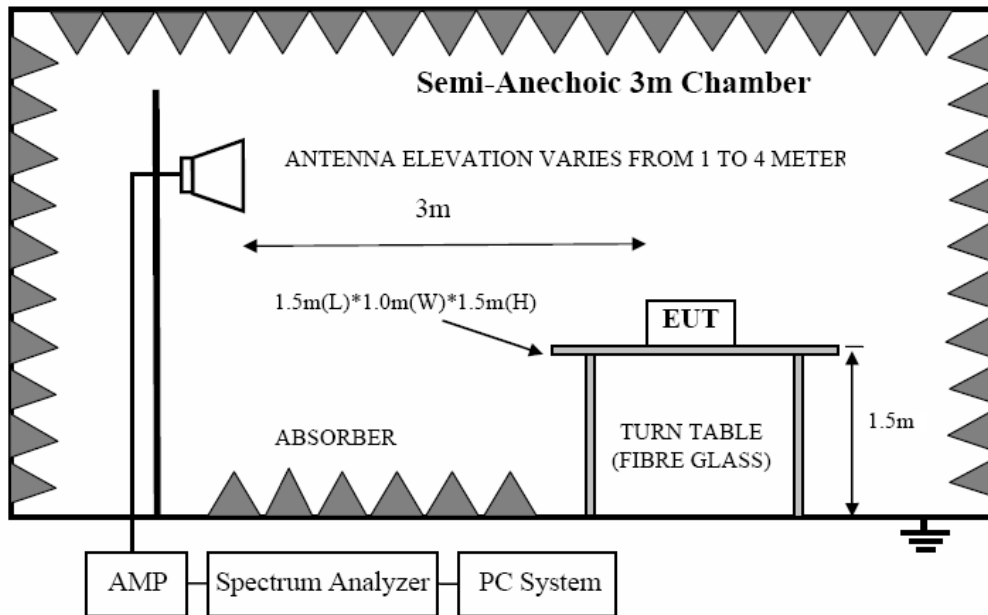

Note: For harmonic emissions test a appropriate high pass filter was inserted in the input port of AMP.

**9.2. Limit**

9.2.1 FCC 15.205 Restricted frequency band

MHz	MHz	MHz	GHz
0.090 - 0.110	16.42 - 16.423	399.9 - 410	4.5 - 5.15
<sup>1</sup> 0.495 - 0.505	16.69475 - 16.69525	608 - 614	5.35 - 5.46
2.1735 - 2.1905	16.80425 - 16.80475	960 - 1240	7.25 - 7.75
4.125 - 4.128	25.5 - 25.67	1300 - 1427	8.025 - 8.5
4.17725 - 4.17775	37.5 - 38.25	1435 - 1626.5	9.0 - 9.2
4.20725 - 4.20775	73 - 74.6	1645.5 - 1646.5	9.3 - 9.5
6.215 - 6.218	74.8 - 75.2	1660 - 1710	10.6 - 12.7
6.26775 - 6.26825	108 - 121.94	1718.8 - 1722.2	13.25 - 13.4
6.31175 - 6.31225	123 - 138	2200 - 2300	14.47 - 14.5
8.291 - 8.294	149.9 - 150.05	2310 - 2390	15.35 - 16.2
8.362 - 8.366	156.52475 - 156.52525	2483.5 - 2500	17.7 - 21.4
8.37625 - 8.38675	156.7 - 156.9	2690 - 2900	22.01 - 23.12
8.41425 - 8.41475	162.0125 - 167.17	3260 - 3267	23.6 - 24.0
12.29 - 12.293	167.72 - 173.2	3332 - 3339	31.2 - 31.8
12.51975 - 12.52025	240 - 285	3345.8 - 3358	36.43 - 36.5
12.57675 - 12.57725	322 - 335.4	3600 - 4400	( <sup>2</sup> )

9.2.2 FCC 15.209 Limit.

FREQUENCY MHz	DISTANCE Meters	FIELD STRENGTHS LIMIT	
		μV/m	dB(μV)/m
0.009 ~ 0.490	300	2400/F(KHz)	67.6-20log(F)
0.490 ~ 1.705	30	24000/F(KHz)	87.6-20log(F)
1.705 ~ 30.0	30	30	29.54
30 ~ 88	3	100	40.0
88 ~ 216	3	150	43.5
216 ~ 960	3	200	46.0
960 ~ 1000	3	500	54.0

Above 1000	3	74.0 dB( $\mu$ V)/m (Peak) 54.0 dB( $\mu$ V)/m (Average)
------------	---	---

Note: (1) The emission limits shown in the above table are based on measurements employing a CISPR QP detector except for the frequency bands 9-90KHz, 110-490KHz and above 1000MHz. Radiated emissions limits in these three bands are based on measurements employing an average detector.

(2) At frequencies below 30MHz, measurement may be performed at a distance closer than that specified, and the limit at closer measurement distance can be extrapolated by below formula:

$$\text{Limit}_{3m}(\text{dBuV/m}) = \text{Limit}_{30m}(\text{dBuV/m}) + 40\text{Log}(30\text{m}/3\text{m})$$

### 9.2.3 Limit for this EUT

All the emissions appearing within 15.205 restricted frequency bands shall not exceed the limits shown in 15.209, all the other emissions shall be at least 20dB below the fundamental emissions, or comply with 15.209 limits.

## 9.3. Test Procedure

- (1) EUT was placed on a non-metallic table, 150 cm above the ground plane inside a semi-anechoic chamber.
- (2) Test antenna was located 3m from the EUT on an adjustable mast, and the antenna used as below table.

Test frequency range	Test antenna used
9KHz-30MHz	Active Loop antenna
30MHz-1GHz	Trilog Broadband Antenna
1GHz-18GHz	Double Ridged Horn Antenna(1GHz-18GHz)
18GHz-40GHz	Horn Antenna(18GHz-40GHz)

According ANSI C63.10:2013 clause 6.4.4.2 and 6.5.3, for measurements below 30 MHz, the loop antenna was positioned with its plane vertical from the EUT and rotated about its vertical axis for maximum response at each azimuth position around the EUT. And the loop antenna also be positioned with its plane horizontal at the specified distance from the EUT. The center of the loop is 1 m above the ground. for measurement above 30MHz, the Trilog Broadband Antenna or Horn Antenna was located 3m from EUT, Measurements were made with the antenna positioned in both the horizontal and vertical planes of Polarization, and the measurement antenna was varied from 1 m to 4 m. in height above the reference ground plane to obtain the maximum signal strength.

(3) Below pre-scan procedure was first performed in order to find prominent frequency spectrum radiated emissions from 9KHz to 25GHz:

- (a) Scanning the peak frequency spectrum with the antenna specified in step (3), and the EUT was rotated 360 degree, the antenna height was varied from 1m to 4m(Except loop antenna, it's fixed 1m above ground.)
- (b) Change work frequency or channel of device if practicable.
- (c) Change modulation type of device if practicable.
- (d) Change power supply range from 85% to 115% of the rated supply voltage
- (e) Rotated EUT though three orthogonal axes to determine the attitude of EUT arrangement produces

highest emissions.

Spectrum frequency from 9KHz to 25GHz (tenth harmonic of fundamental frequency) was investigated, and no any obvious emission were detected from 18GHz to 25GHz, so below final test was performed with frequency range from 9KHz to 18GHz.

- (4) For final emissions measurements at each frequency of interest, the EUT was rotated and the antenna height was varied between 1m and 4m in order to maximize the emission. Measurements in both horizontal and vertical polarities were made and the data was recorded. In order to find the maximum emission, the relative positions of equipments and all of the interface cables were changed according to ANSI C63.10 2013 on Radiated Emission test.
- (5) The emissions from 9KHz to 1GHz were measured based on CISPR QP detector except for the frequency bands 9-90KHz, 110-490KHz, for emissions from 9KHz-90KHz,110KHz-490KHz and above 1GHz were measured based on average detector, for emissions above 1GHz, peak emissions also be measured and need comply with Peak limit.
- (6) The emissions from 9KHz to 1GHz, QP or average values were measured with EMI receiver with below RBW.

Frequency band	RBW
9KHz-150KHz	200Hz
150KHz-30MHz	9KHz
30MHz-1GHz	120KHz

- (7) For emissions above 1GHz, both Peak and Average level were measured with Spectrum Analyzer, and the RBW is set at 1MHz, VBW is set at 3MHz for Peak measure; RMS detector RBW 1MHz VBW 3MHz for Average measure(according ANSI C63.10:2013 clause 4.2.3.2.3 procedure for average measure).
- (8) X axis, Y axis, Z axis are tested, and worse setup X axis is reported.

#### 9.4. Test result

##### **PASS. (See below detailed test result)**

All the emissions except fundamental emission from 9 KHz to 25GHz were comply with 15.209 limits.

Note1: According exploratory test no any obvious emission were detected from 9KHz to 30MHz and 18GHz to 25GHz, so the final test was performed with frequency range from 30MHz to 18GHz and recorded in below.

Note2: For emissions below 1GHz, according exploratory explorer test, when change Tx mode and channel, have no distinct influence on emissions level, so for emissions below 1GHz, the final test was only performed with EUT working in GFSK, Tx 2441MHz mode.

Note3: For emissions above 1GHz. If peak results comply with AV limit, AV Result is deemed to comply with AV limit.

**Radiated Emission test (below 1GHz)**

**TR-4-E-009 Radiated Emission Test Result**

<b>Test Site</b>	: DDT 3m Chamber	D:\2016 Report Data\16Q0720-6\RE.EM6
<b>Test Date</b>	: 2016-07-09	<b>Tested By</b> : Jerry
<b>EUT</b>	: BLUETOOTH HEADSET	<b>Model Number</b> : Duet BT
<b>Power Supply</b>	: DC 3.7V	<b>Test Mode</b> : TX mode
<b>Condition</b>	: Temp:24.5'C,Humi:55%, Press:100.1kPa	<b>Antenna/Distance</b> : 2015 VULB9163/3m/VERTICAL
<b>Memo</b>	: EDR	

Data: 27

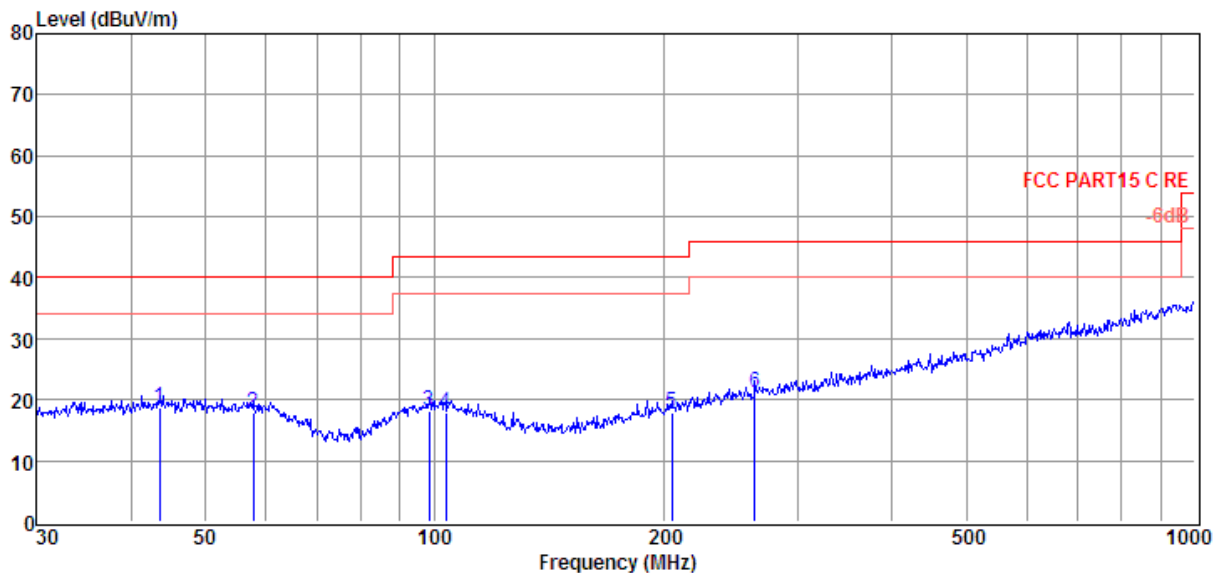

Item (Mark)	Freq (MHz)	Read Level (dBμV)	Antenna Factor (dB/m)	Cable Loss dB	Result Level (dBμV/m)	Limit Line (dBμV/m)	Over Limit (dB)	Detector	Polarization
1	43.51	2.48	12.42	3.82	18.72	40.00	-21.28	QP	VERTICAL
2	57.80	2.25	11.69	3.96	17.90	40.00	-22.10	QP	VERTICAL
3	98.49	1.90	11.88	4.28	18.06	43.50	-25.44	QP	VERTICAL
4	103.44	1.71	11.72	4.32	17.75	43.50	-25.75	QP	VERTICAL
5	204.96	2.28	10.60	4.92	17.80	43.50	-25.70	QP	VERTICAL
6	263.82	3.43	12.55	5.21	21.19	46.00	-24.81	QP	VERTICAL

- Note: 1. Result Level = Read Level + Antenna Factor + Cable loss.  
 2. If Peak Result complies with QP limit, QP Result is deemed to comply with QP limit.  
 3. Test setup: RBW: 120 kHz, VBW: 300 kHz, Sweep time: auto.

## TR-4-E-009 Radiated Emission Test Result

**Test Site** : DDT 3m Chamber D:\2016 Report Data\16Q0720-6\RE.EM6  
**Test Date** : 2016-07-09 **Tested By** : Jerry  
**EUT** : BLUETOOTH HEADSET **Model Number** : Duet BT  
**Power Supply** : DC 3.7V **Test Mode** : TX mode  
**Condition** : Temp:24.5°C,Humi:55%,  
**Antenna/Distance** : 2015 VULB9163/3m/HORIZONTAL  
 Press:100.1kPa  
**Memo** : EDR

Data: 28

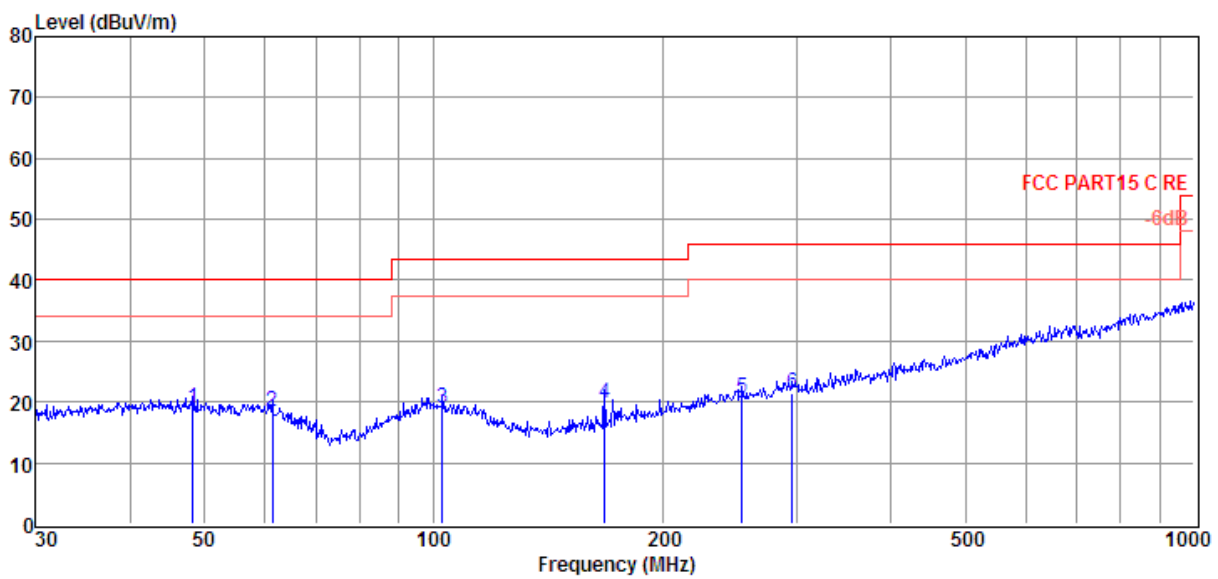

Item (Mark)	Freq (MHz)	Read Level (dBuV)	Antenna Factor (dB/m)	Cable Loss (dB)	Result Level (dBuV/m)	Limit Line (dBuV/m)	Over Limit (dB)	Detector	Polarization
1	48.33	2.74	12.25	3.87	18.86	40.00	-21.14	QP	HORIZONTAL
2	61.35	3.22	11.09	3.99	18.30	40.00	-21.70	QP	HORIZONTAL
3	102.72	2.78	11.78	4.32	18.88	43.50	-24.62	QP	HORIZONTAL
4	167.82	6.90	8.31	4.71	19.92	43.50	-23.58	QP	HORIZONTAL
5	254.73	3.04	12.30	5.16	20.50	46.00	-25.50	QP	HORIZONTAL
6	296.18	2.73	13.40	5.36	21.49	46.00	-24.51	QP	HORIZONTAL

Note: 1. Result Level = Read Level + Antenna Factor + Cable loss.  
 2. If Peak Result complies with QP limit, QP Result is deemed to comply with QP limit.  
 3. Test setup: RBW: 120 kHz, VBW: 300 kHz, Sweep time: auto.

**Radiated Emission test (above 1GHz)**

Freq (MHz)	Read level (dB $\mu$ V)	Antenna Factor (dB/m)	PRM Factor (dB)	Cable Loss (dB)	Result Level (dB $\mu$ V/m)	Limit (dB $\mu$ V/m)	Margin (dB)	Detector type	Polarization
GFSK Tx mode 2402MHz									
2554.00	40.99	30.38	29.85	6.22	47.74	74.00	-26.26	Peak	HORIZONTAL
3002.00	37.43	31.70	30.20	6.77	45.70	74.00	-28.30	Peak	HORIZONTAL
4804.00	37.48	33.74	29.32	8.48	50.38	74.00	-23.62	Peak	HORIZONTAL
7206.00	33.69	36.37	30.49	10.60	50.17	74.00	-23.83	Peak	HORIZONTAL
2554.00	38.99	30.38	29.85	6.22	45.74	74.00	-28.26	Peak	VERTICAL
4804.00	37.93	33.74	29.32	8.48	50.83	74.00	-23.17	Peak	VERTICAL
7206.00	34.71	36.37	30.49	10.60	51.19	74.00	-22.81	Peak	VERTICAL
GFSK Tx mode 2441MHz									
2596.00	37.55	30.51	29.91	6.28	44.43	74.00	-29.57	Peak	HORIZONTAL
4882.00	37.74	33.72	29.33	8.56	50.69	74.00	-23.31	Peak	HORIZONTAL
7323.00	33.86	36.46	30.59	10.71	50.44	74.00	-23.56	Peak	HORIZONTAL
2596.00	36.78	30.51	29.91	6.28	43.66	74.00	-30.34	Peak	VERTICAL
4882.00	38.31	33.72	29.33	8.56	51.26	74.00	-22.74	Peak	VERTICAL
7323.00	34.75	36.46	30.59	10.71	51.33	74.00	-22.67	Peak	VERTICAL
GFSK Tx mode 2480MHz									
2638.00	38.25	30.64	29.97	6.33	45.25	74.00	-28.75	Peak	HORIZONTAL
4960.00	38.94	33.71	29.34	8.63	51.94	74.00	-22.06	Peak	HORIZONTAL
7440.00	34.89	36.55	30.70	10.80	51.54	74.00	-22.46	Peak	HORIZONTAL
2631.00	37.93	30.62	29.96	6.33	44.92	74.00	-29.08	Peak	VERTICAL
4960.00	39.20	33.71	29.34	8.63	52.20	74.00	-21.80	Peak	VERTICAL
7440.00	34.36	36.55	30.70	10.80	51.01	74.00	-22.99	Peak	VERTICAL
Result: Pass									
Test Date : Aug. 8, 2016					Test Engineer : Toby Ren				

Note: 1.30MHz~18GHz: (Scan with GFSK,  $\pi/4$  QPSK, 8-DPSK, the worst case is GFSK Mode)

2. Result Level = Read Level + Antenna Factor + Cable loss - PRM Factor.

## 10. Band Edge Compliance (radiated method)

### 10.1. Block diagram of test setup

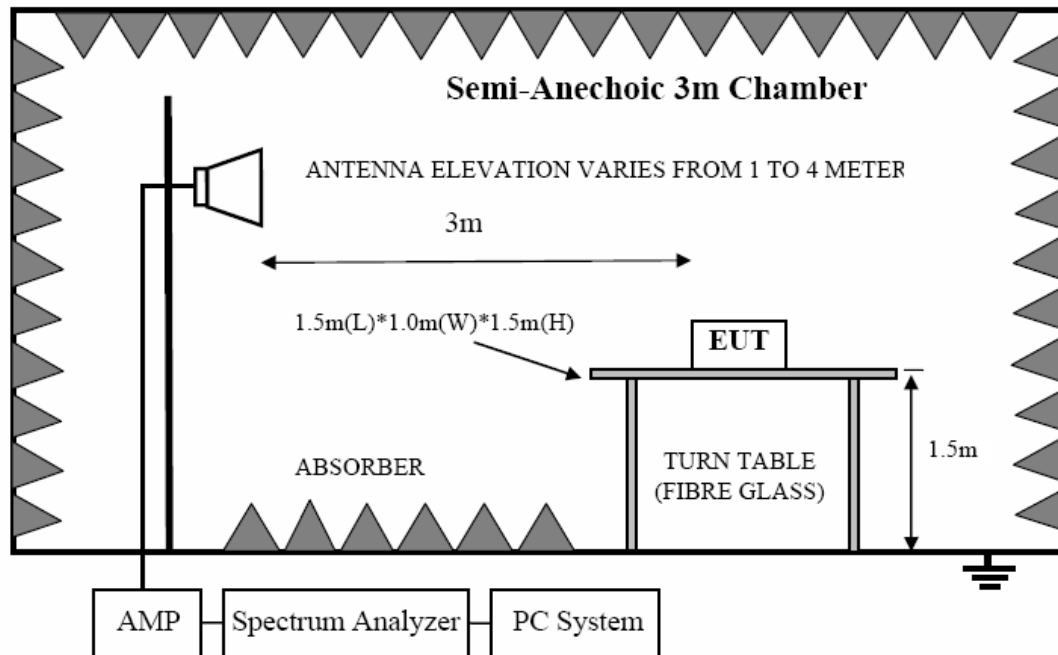

### 10.2. Limit

All restriction band should comply with 15.209, other emission should be at least 20dB below the fundamental.

### 10.3. Test Procedure

Same with clause 9.3 except change investigated frequency range from 2310MHz to 2415MHz and 2475MHz to 2500MHz.

Remark: All restriction band have been tested, and only the worse case is shown in report.

### 10.4. Test result

**PASS.** (See below detailed test result)

**Remark: hopping on and hopping off mode all have been test, hopping off mode is worse and reported only.**

## TR-4-E-009 Radiated Emission Test Result

<b>Test Site</b>	: DDT 3m Chamber		D:\2016 Report Data\16Q0720-6\RF.EM6
<b>Test Date</b>	: 2016-07-29	<b>Tested By</b>	: Toby
<b>EUT</b>	: WIRELESS HEADPHONES	<b>Model Number</b>	: Duet BT
<b>Power Supply</b>	: DC 3.7V	<b>Test Mode</b>	: Tx mode GFSK CH0
<b>Condition</b>	: Temp:24.5'C,Humi:55%, Press:100.1kPa	<b>Antenna/Distance</b>	: 2015 HF907/3m/VERTICAL
<b>Memo</b>	: EDR		

Data: 59

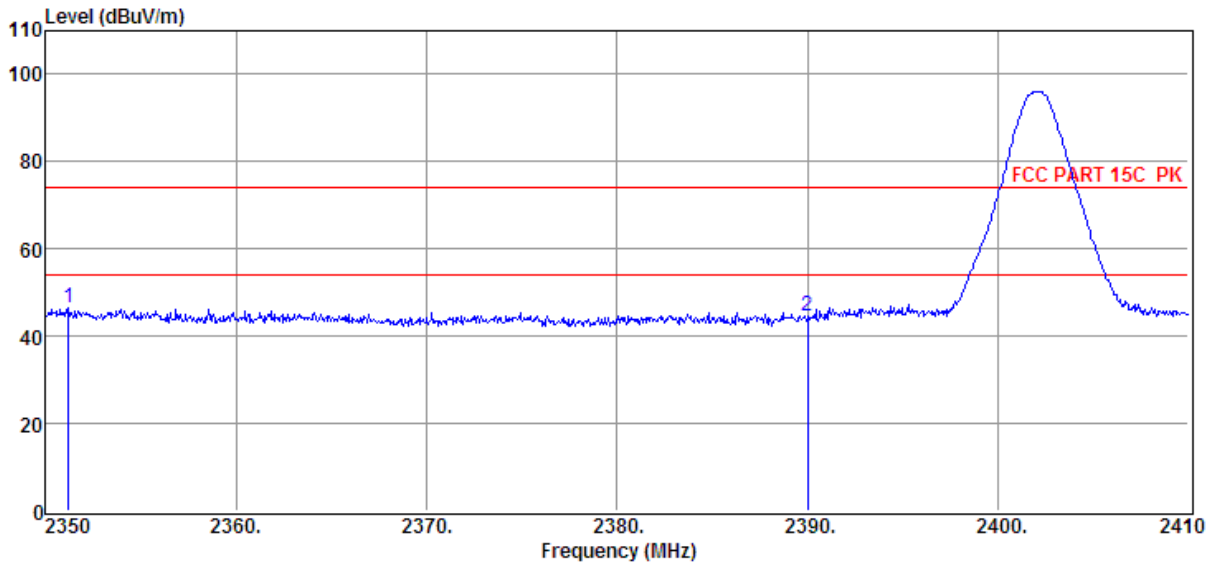

Item (Mark)	Freq (MHz)	Read Level (dBμV)	Antenna Factor (dB/m)	PRM Factor dB	Cable Loss dB	Result Level (dBμV/m)	Limit Line (dBμV/m)	Over Limit (dB)	Detector	Polarization
1	2351.20	40.38	29.62	29.34	5.96	46.62	74.00	-27.38	Peak	VERTICAL
2	2390.00	38.31	29.78	29.41	6.01	44.69	74.00	-29.31	Peak	VERTICAL

- Note: 1. Result Level = Read Level + Antenna Factor + Cable loss - PRM Factor.  
 2. If Peak Result complies with AV limit, AV Result is deemed to comply with AV limit.  
 3. Test setup: RBW: 1 MHz, VBW: 3 MHz, Sweep time: auto.

# TR-4-E-009 Radiated Emission Test Result

**Test Site** : DDT 3m Chamber D:\2016 Report Data\16Q0720-6\RF.EM6  
**Test Date** : 2016-07-29 **Tested By** : Toby  
**EUT** : WIRELESS HEADPHONES **Model Number** : Duet BT  
**Power Supply** : DC 3.7V **Test Mode** : Tx mode GFSK CH0  
**Condition** : Temp:24.5°C,Humi:55%,  
**Antenna/Distance** : 2015 HF907/3m/HORIZONTAL  
Press:100.1kPa  
**Memo** : EDR

Data: 60

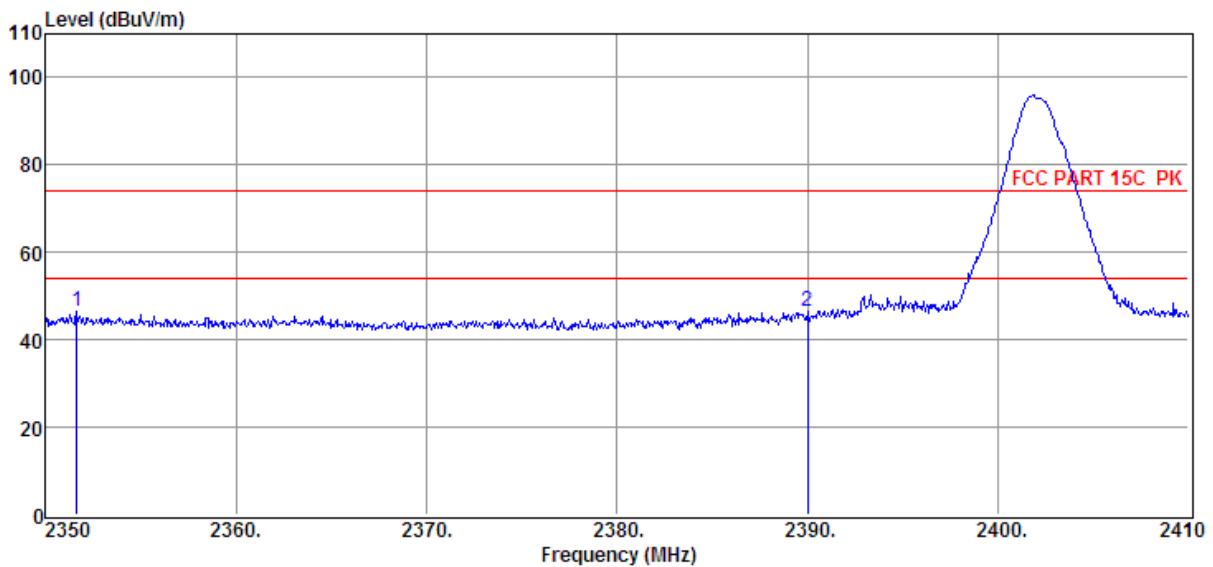

Item (Mark)	Freq (MHz)	Read Level (dBμV)	Antenna Factor (dB/m)	PRM Factor (dB)	Cable Loss (dB)	Result Level (dBμV/m)	Limit Line (dBμV/m)	Over Limit (dB)	Detector	Polarization
1	2351.62	40.14	29.62	29.34	5.96	46.38	74.00	-27.62	Peak	HORIZONTAL
2	2390.00	40.14	29.78	29.41	6.01	46.52	74.00	-27.48	Peak	HORIZONTAL

- Note: 1. Result Level = Read Level + Antenna Factor + Cable loss - PRM Factor.  
 2. If Peak Result complies with AV limit, AV Result is deemed to comply with AV limit.  
 3. Test setup: RBW: 1 MHz, VBW: 3 MHz, Sweep time: auto.

## TR-4-E-009 Radiated Emission Test Result

<b>Test Site</b>	: DDT 3m Chamber	<b>D:\2016 Report Data\16Q0720-6\RF.EM6</b>
<b>Test Date</b>	: 2016-07-29	<b>Tested By</b> : Toby
<b>EUT</b>	: WIRELESS HEADPHONES	<b>Model Number</b> : Duet BT
<b>Power Supply</b>	: DC 3.7V	<b>Test Mode</b> : Tx mode GFSK CH78
<b>Condition</b>	: Temp:24.5°C,Humi:55%, Press:100.1kPa	<b>Antenna/Distance</b> : 2015 HF907/3m/HORIZONTAL
<b>Memo</b>	: EDR	

Data: 65

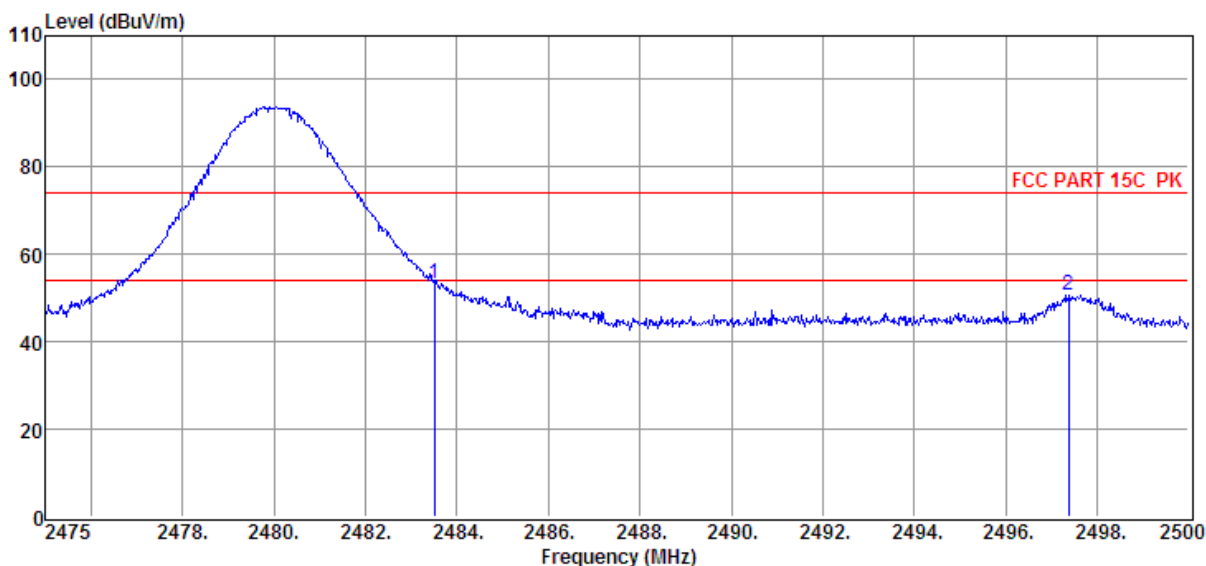

Item (Mark)	Freq (MHz)	Read Level (dBμV)	Antenna Factor (dB/m)	PRM Factor dB	Cable Loss dB	Result Level (dBμV/m)	Limit Line (dBμV/m)	Over Limit (dB)	Detector	Polarization
1	2483.50	46.73	30.14	29.71	6.15	53.31	74.00	-20.69	Peak	HORIZONTAL
2	2497.38	44.19	30.19	29.75	6.15	50.78	74.00	-23.22	Peak	HORIZONTAL

Note: 1. Result Level = Read Level + Antenna Factor + Cable loss - PRM Factor.  
 2. If Peak Result complies with AV limit, AV Result is deemed to comply with AV limit.  
 3. Test setup: RBW: 1 MHz, VBW: 3 MHz, Sweep time: auto.

## TR-4-E-009 Radiated Emission Test Result

<b>Test Site</b>	: DDT 3m Chamber	D:\2016 Report Data\16Q0720-6\RF.EM6
<b>Test Date</b>	: 2016-07-29	<b>Tested By</b> : Toby
<b>EUT</b>	: WIRELESS HEADPHONES	<b>Model Number</b> : Duet BT
<b>Power Supply</b>	: DC 3.7V	<b>Test Mode</b> : Tx mode GFSK CH78
<b>Condition</b>	: Temp:24.5°C,Humi:55%, Press:100.1kPa	<b>Antenna/Distance</b> : 2015 HF907/3m/VERTICAL
<b>Memo</b>	: EDR	

Data: 66

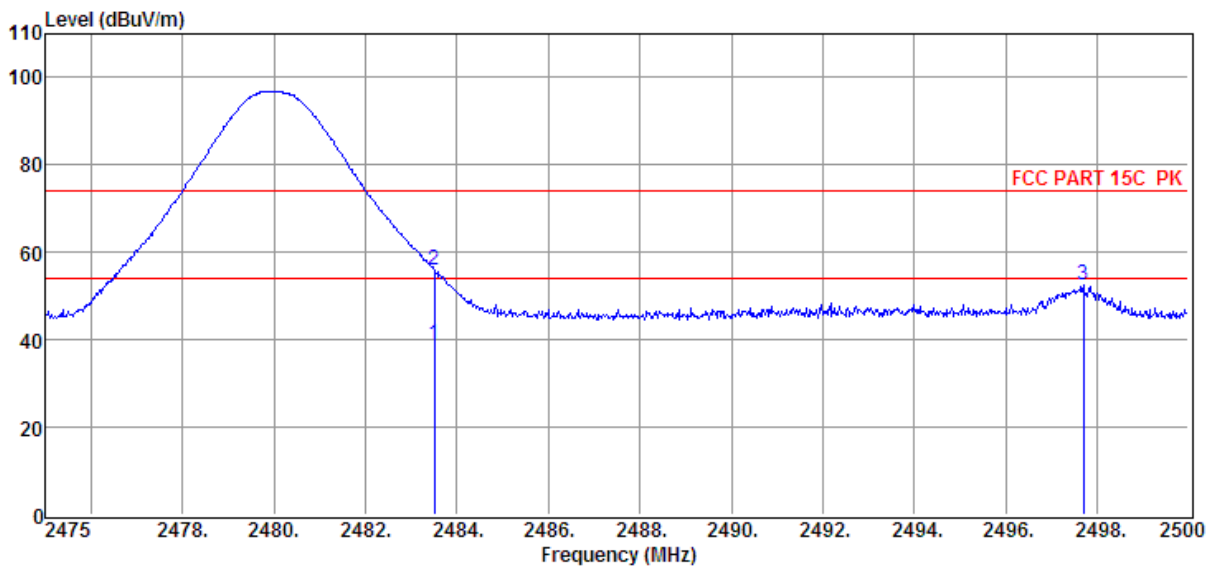

Item (Mark)	Freq (MHz)	Read Level (dBμV)	Antenna Factor (dB/m)	PRM Factor dB	Cable Loss dB	Result Level (dBμV/m)	Limit Line (dBμV/m)	Over Limit (dB)	Detector	Polarization
1	2483.50	32.24	30.14	29.71	6.15	38.82	54.00	-15.18	Average	VERTICAL
2	2483.50	49.52	30.14	29.71	6.15	56.10	74.00	-17.90	Peak	VERTICAL
3	2497.70	45.84	30.19	29.75	6.15	52.43	74.00	-21.57	Peak	VERTICAL

- Note: 1. Result Level = Read Level + Antenna Factor + Cable loss - PRM Factor.  
 2. If Peak Result complies with AV limit, AV Result is deemed to comply with AV limit.  
 3. Test setup: RBW: 1 MHz, VBW: 3 MHz, Sweep time: auto.

# TR-4-E-009 Radiated Emission Test Result

**Test Site** : DDT 3m Chamber D:\2016 Report Data\16Q0720-6\RF.EM6  
**Test Date** : 2016-07-29 **Tested By** : Toby  
**EUT** : WIRELESS HEADPHONES **Model Number** : Duet BT  
**Power Supply** : DC 3.7V **Test Mode** : Tx mode 8-DPSK CH78  
**Condition** : Temp:24.5°C,Humi:55%,  
**Antenna/Distance** : 2015 HF907/3m/HORIZONTAL  
Press:100.1kPa  
**Memo** : EDR

Data: 67

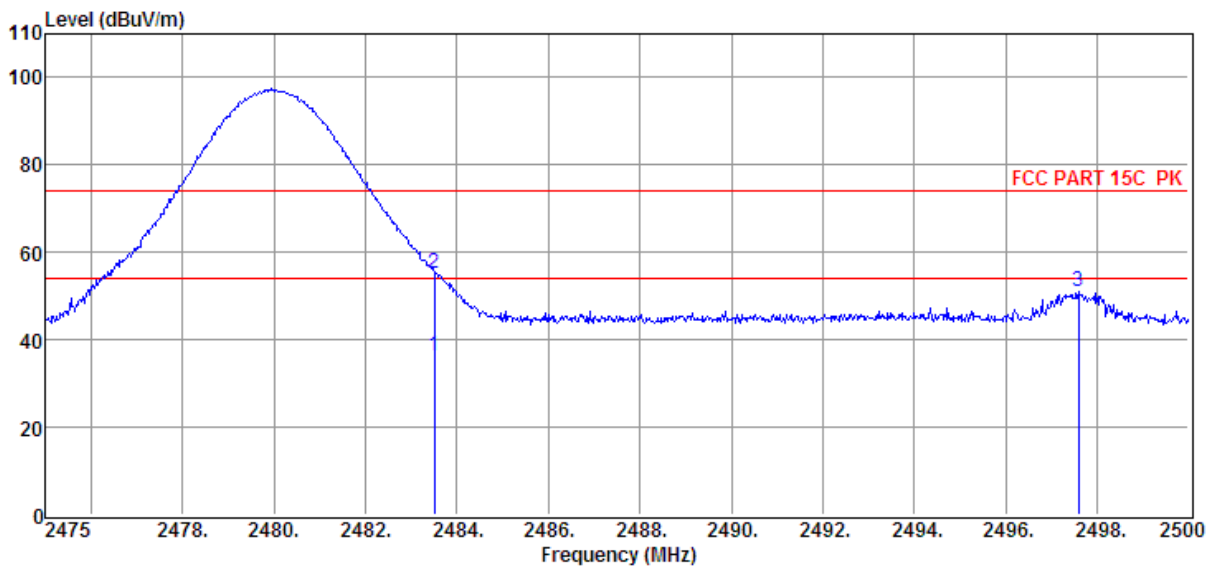

Item (Mark)	Freq (MHz)	Read Level (dBμV)	Antenna Factor (dB/m)	PRM Factor (dB)	Cable Loss (dB)	Result Level (dBμV/m)	Limit Line (dBμV/m)	Over Limit (dB)	Detector	Polarization
1	2483.50	29.64	30.14	29.71	6.15	36.22	54.00	-17.78	Average	HORIZONTAL
2	2483.50	48.60	30.14	29.71	6.15	55.18	74.00	-18.82	Peak	HORIZONTAL
3	2497.60	44.32	30.19	29.75	6.15	50.91	74.00	-23.09	Peak	HORIZONTAL

- Note: 1. Result Level = Read Level + Antenna Factor + Cable loss - PRM Factor.  
 2. If Peak Result complies with AV limit, AV Result is deemed to comply with AV limit.  
 3. Test setup: RBW: 1 MHz, VBW: 3 MHz, Sweep time: auto.

# TR-4-E-009 Radiated Emission Test Result

**Test Site** : DDT 3m Chamber D:\2016 Report Data\16Q0720-6\RF.EM6  
**Test Date** : 2016-07-29 **Tested By** : Toby  
**EUT** : WIRELESS HEADPHONES **Model Number** : Duet BT  
**Power Supply** : DC 3.7V **Test Mode** : Tx mode 8-DPSK CH78  
**Condition** : Temp:24.5°C,Humi:55%,  
 Press:100.1kPa **Antenna/Distance** : 2015 HF907/3m/VERTICAL  
**Memo** : EDR

Data: 68

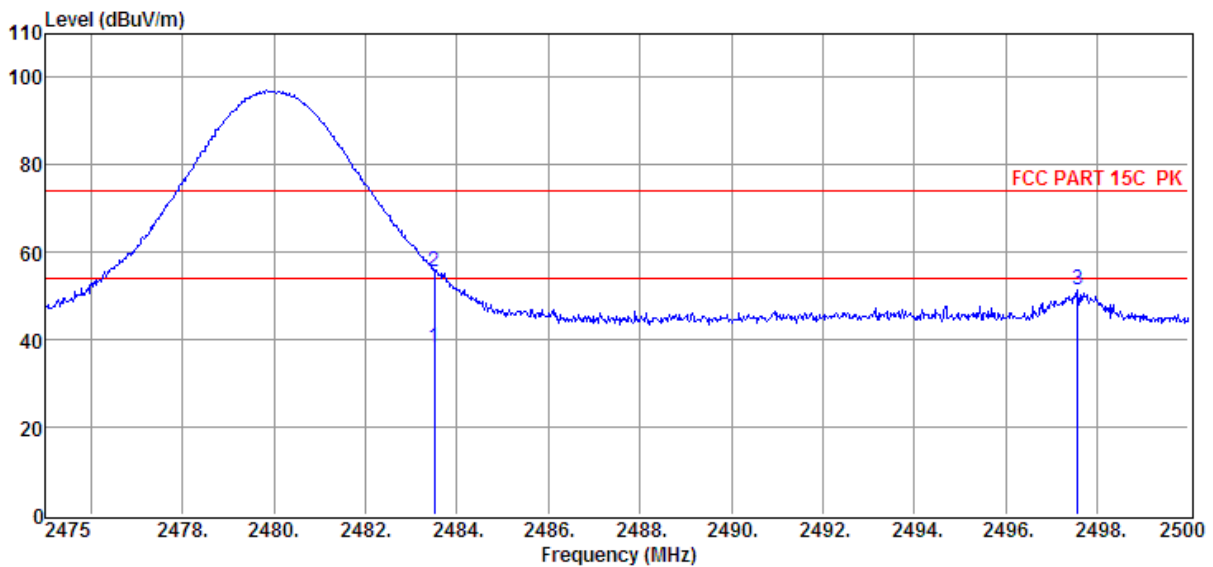

Item (Mark)	Freq (MHz)	Read Level (dBμV)	Antenna Factor (dB/m)	PRM Factor (dB)	Cable Loss (dB)	Result Level (dBμV/m)	Limit Line (dBμV/m)	Over Limit (dB)	Detector	Polarization
1	2483.50	31.57	30.14	29.71	6.15	38.15	54.00	-15.85	Average	VERTICAL
2	2483.50	48.99	30.14	29.71	6.15	55.57	74.00	-18.43	Peak	VERTICAL
3	2497.58	44.69	30.19	29.75	6.15	51.28	74.00	-22.72	Peak	VERTICAL

- Note: 1. Result Level = Read Level + Antenna Factor + Cable loss - PRM Factor.  
 2. If Peak Result complies with AV limit, AV Result is deemed to comply with AV limit.  
 3. Test setup: RBW: 1 MHz, VBW: 3 MHz, Sweep time: auto.

## TR-4-E-009 Radiated Emission Test Result

<b>Test Site</b> : DDT 3m Chamber	D:\2016 Report Data\16Q0720-6\RF.EM6
<b>Test Date</b> : 2016-07-29	<b>Tested By</b> : Toby
<b>EUT</b> : WIRELESS HEADPHONES	<b>Model Number</b> : Duet BT
<b>Power Supply</b> : DC 3.7V	<b>Test Mode</b> : Tx mode 8-DPSK CH0
<b>Condition</b> : Temp:24.5°C,Humi:55%, Press:100.1kPa	<b>Antenna/Distance</b> : 2015 HF907/3m/VERTICAL
<b>Memo</b> : EDR	

Data: 69

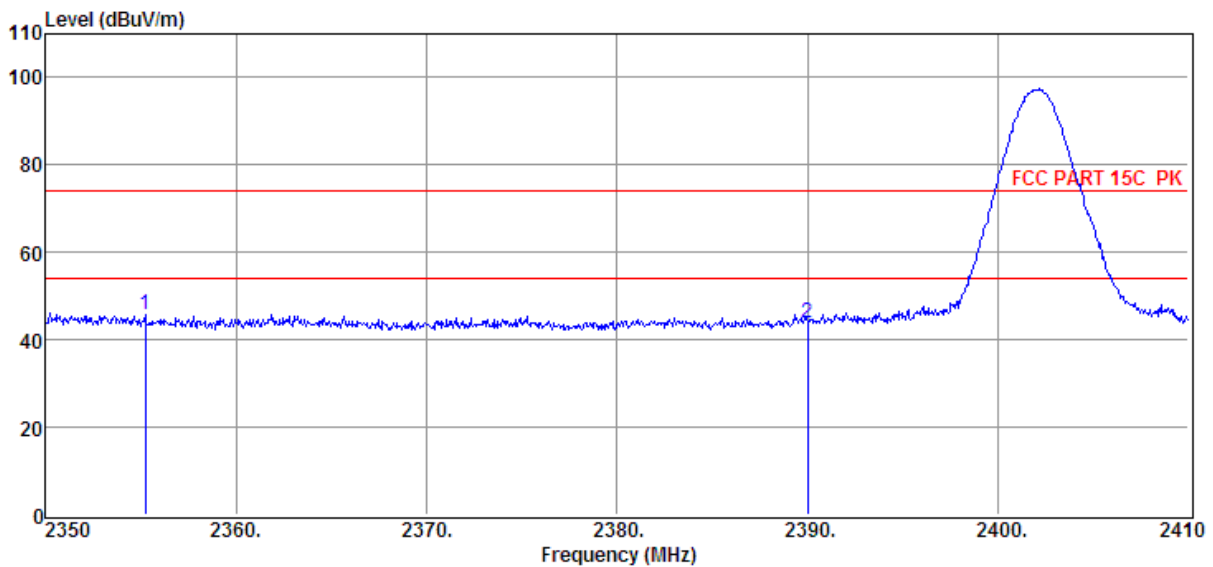

Item (Mark)	Freq (MHz)	Read Level (dBμV)	Antenna Factor (dB/m)	PRM Factor dB	Cable Loss dB	Result Level (dBμV/m)	Limit Line (dBμV/m)	Over Limit (dB)	Detector	Polarization
1	2355.22	39.48	29.64	29.34	5.96	45.74	74.00	-28.26	Peak	VERTICAL
2	2390.00	37.47	29.78	29.41	6.01	43.85	74.00	-30.15	Peak	VERTICAL

- Note: 1. Result Level = Read Level + Antenna Factor + Cable loss - PRM Factor.  
 2. If Peak Result complies with AV limit, AV Result is deemed to comply with AV limit.  
 3. Test setup: RBW: 1 MHz, VBW: 3 MHz, Sweep time: auto.

## TR-4-E-009 Radiated Emission Test Result

<b>Test Site</b>	: DDT 3m Chamber	<b>D:\2016 Report Data\16Q0720-6\RF.EM6</b>
<b>Test Date</b>	: 2016-07-29	<b>Tested By</b> : Toby
<b>EUT</b>	: WIRELESS HEADPHONES	<b>Model Number</b> : Duet BT
<b>Power Supply</b>	: DC 3.7V	<b>Test Mode</b> : Tx mode 8-DPSK CH0
<b>Condition</b>	: Temp:24.5°C,Humi:55%, Press:100.1kPa	<b>Antenna/Distance</b> : 2015 HF907/3m/HORIZONTAL
<b>Memo</b>	: EDR	

Data: 70

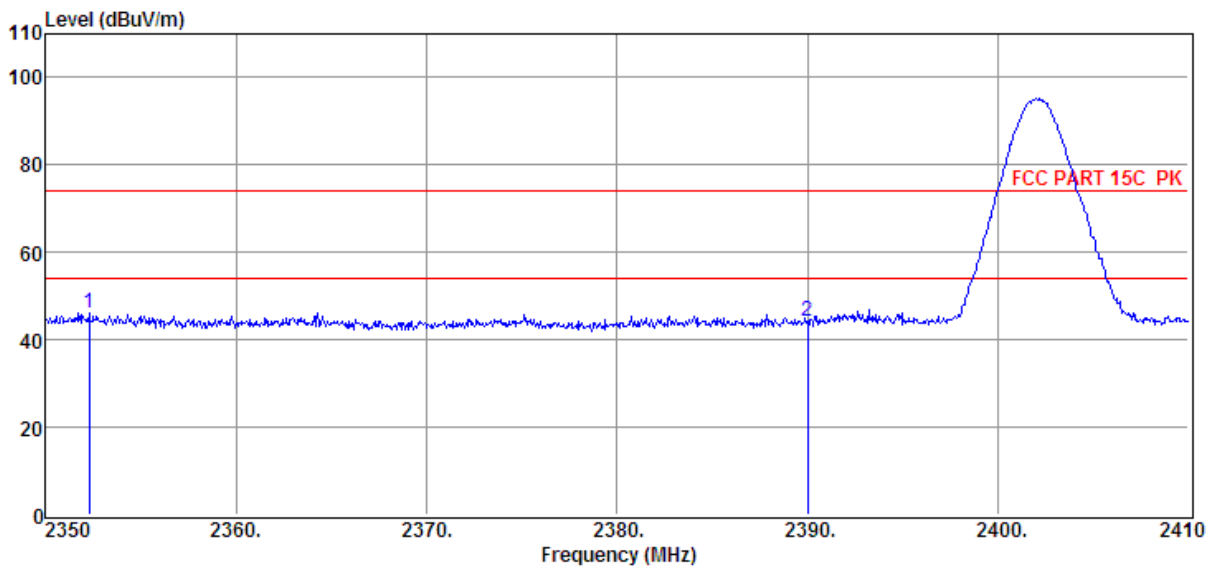

Item (Mark)	Freq (MHz)	Read Level (dBμV)	Antenna Factor (dB/m)	PRM Factor dB	Cable Loss dB	Result Level (dBμV/m)	Limit Line (dBμV/m)	Over Limit (dB)	Detector	Polarization
1	2352.28	39.94	29.63	29.34	5.96	46.19	74.00	-27.81	Peak	HORIZONTAL
2	2390.00	37.86	29.78	29.41	6.01	44.24	74.00	-29.76	Peak	HORIZONTAL

- Note: 1. Result Level = Read Level + Antenna Factor + Cable loss - PRM Factor.  
 2. If Peak Result complies with AV limit, AV Result is deemed to comply with AV limit.  
 3. Test setup: RBW: 1 MHz, VBW: 3 MHz, Sweep time: auto.

## 11. Band Edge Compliance (conducted method)

### 11.1. Block diagram of test setup

Same as section 4.1

### 11.2. Limit

All restriction band should comply with 15.209, other emission should be at least 20dB below the fundamental.

### 11.3. Test result

Mode	Freq (MHz)	Conclusion
GFSK	Hopping off 2402	PASS
	Hopping off 2480	PASS
	Hopping on	PASS
8-DPSK	Hopping off 2402	PASS
	Hopping off 2480	PASS
	Hopping on	PASS
Test Date : Aug. 8, 2016		Test Engineer : Toby Ren

### 11.4. Original test data

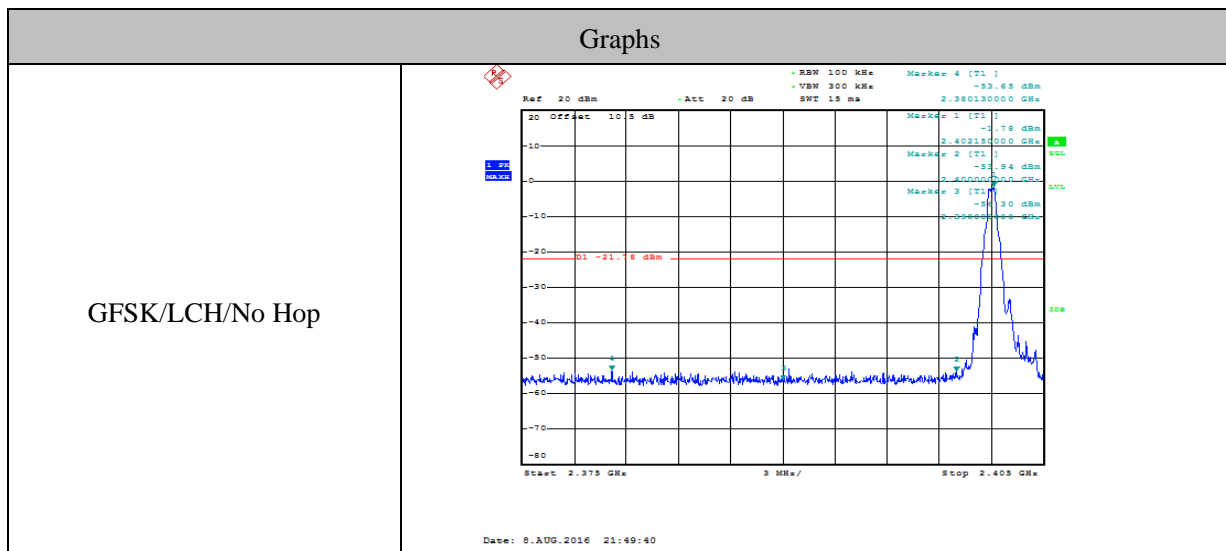

<p>GFSK/LCH/Hop</p>	
<p>GFSK/HCH/No Hop</p>	
<p>GFSK/HCH/Hop</p>	

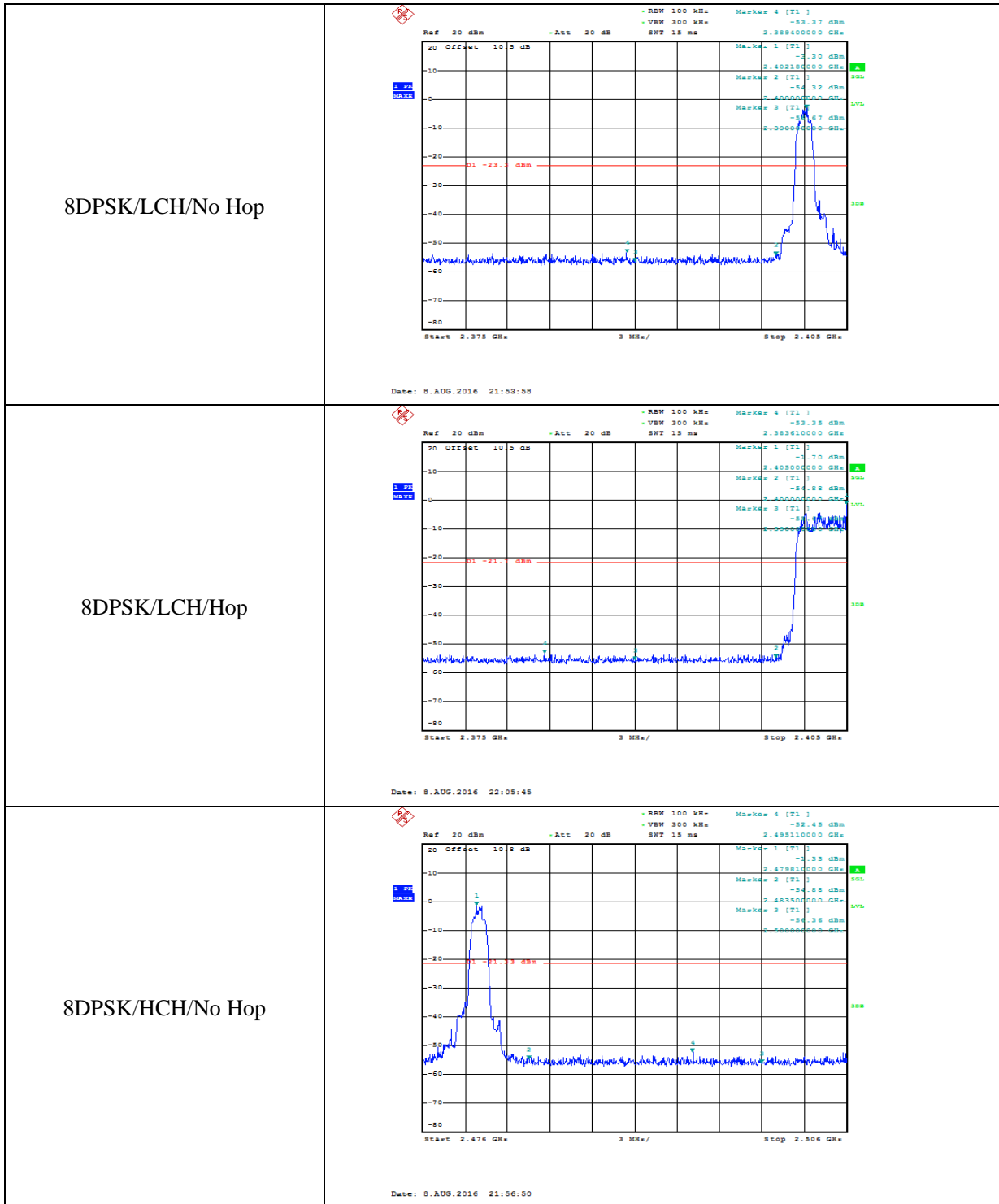

8DPSK/HCH/Hop

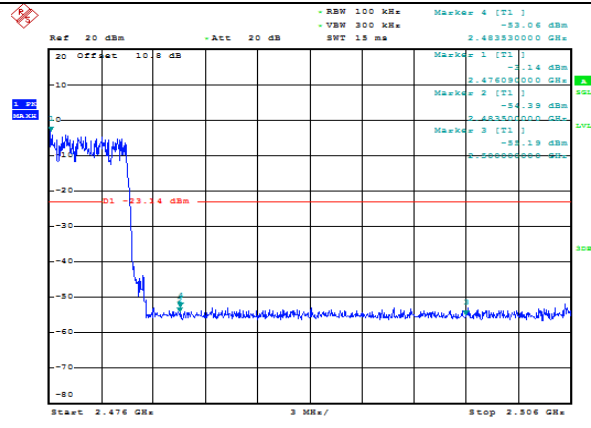

Date: 8.AUG.2016 22:07:39

## 12. Power Line Conducted Emission

### 12.1. Block diagram of test setup

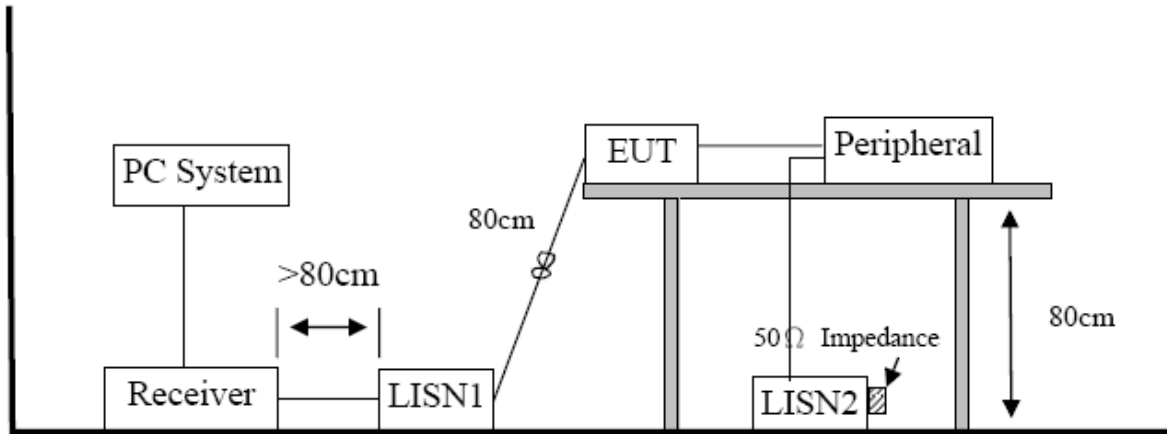

### 12.2. Power Line Conducted Emission Limits(Class B)

Frequency	Quasi-Peak Level dB( $\mu$ V)	Average Level dB( $\mu$ V)
150kHz ~ 500kHz	66 ~ 56*	56 ~ 46*
500kHz ~ 5MHz	56	46
5MHz ~ 30MHz	60	50

Note 1: \* Decreasing linearly with logarithm of frequency.

Note 2: The lower limit shall apply at the transition frequencies.

### 12.3. Test Procedure

The EUT and Support equipment, if needed, were put placed on a non-metallic table, 80cm above the ground plane.

Configuration EUT to simulate typical usage as described in clause 2.4 and test equipment as described in clause 10.2 of this report.

All I/O cables were positioned to simulate typical actual usage as per ANSI C63.4.

All support equipment power received from a second LISN.

Emissions were measured on each current carrying line of the EUT using an EMI Test Receiver connected to the LISN powering the EUT.

The Receiver scanned from 150 kHz to 30MHz for emissions in each of the test modes.

During the above scans, the emissions were maximized by cable manipulation.

The test mode(s) described in clause 2.4 were scanned during the preliminary test.

After the preliminary scan, we found the test mode producing the highest emission level.

The EUT configuration and worse cable configuration of the above highest emission levels were recorded for reference of the final test.

EUT and support equipment were set up on the test bench as per the configuration with highest emission level in the preliminary test.

A scan was taken on both power lines, Neutral and Line, recording at least the six highest emissions.

Emission frequency and amplitude were recorded into a computer in which correction factors were used to calculate the emission level and compare reading to the applicable limit.

The test data of the worst-case condition(s) was recorded.

The bandwidth of test receiver is set at 9 KHz.

#### **12.4. Test Result**

**PASS. (See below detailed test result)**

Note1: All emissions not reported below are too low against the prescribed limits.

Note2: “----” means Peak detection; “-----” mans Average detection

# TR-4-E-010 Conducted Emission Test Result

**Test Site** : DDT 1# Shield Room E:\2016 report data\16Q0720-6\CE.EM6  
**Test Date** : 2016-07-29 **Tested By** : Toby  
**EUT** : BLUETOOTH HEADSET **Model Number** : Duet BT  
**Power Supply** : Power from adapter **Test Mode** : Tx Mode  
**Condition** : Temp:24.5°C,Humi:55%,  
**LISN** : 2015 ENV216/NEUTRAL  
 Press:100.1kPa  
**Memo** : EDR

Data: 32

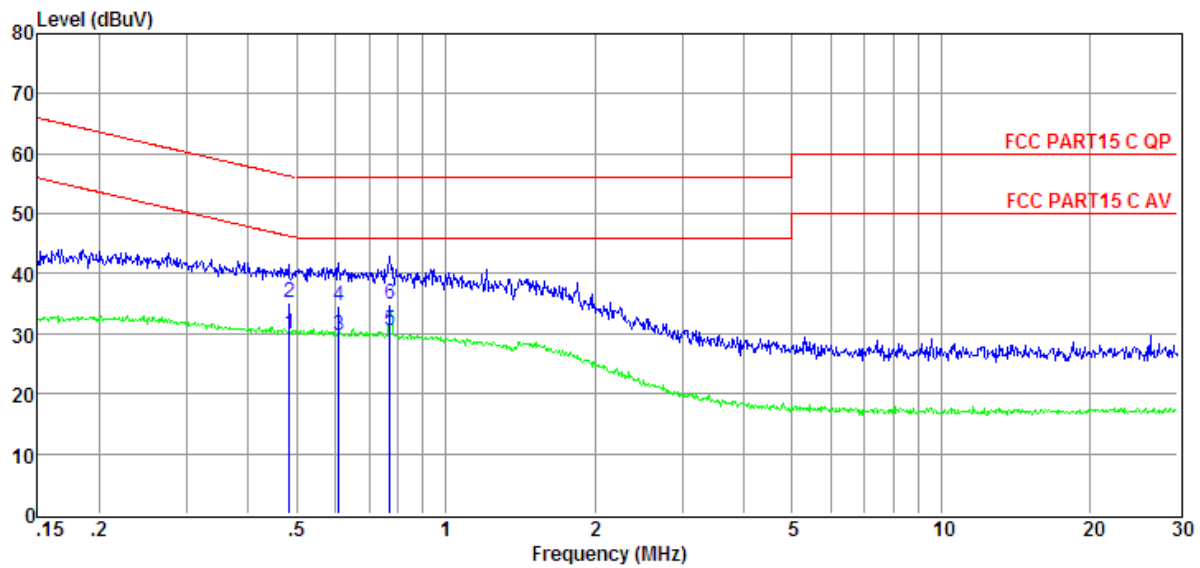

Item	Freq	Read Level	LISN Factor	Cable Loss	Pulse Limiter Factor	Result Level	Limit Line	Over Limit	Detector	Phase
(Mark)	(MHz)	(dBμV)	(dB)	(dB)	(dB)	(dBμV)	(dBμV)	(dB)		
1	0.48	10.46	9.61	0.02	9.86	29.95	46.27	-16.32	Average	NEUTRAL
2	0.48	15.61	9.61	0.02	9.86	35.10	56.27	-21.17	QP	NEUTRAL
3	0.61	10.06	9.61	0.03	9.86	29.56	46.00	-16.44	Average	NEUTRAL
4	0.61	15.19	9.61	0.03	9.86	34.69	56.00	-21.31	QP	NEUTRAL
5	0.77	11.02	9.61	0.03	9.86	30.52	46.00	-15.48	Average	NEUTRAL
6	0.77	15.40	9.61	0.03	9.86	34.90	56.00	-21.10	QP	NEUTRAL

- Note: 1. Result Level = Read Level + LISN Factor + Pulse Limiter Factor + Cable loss.  
 2. If QP Result complies with AV limit, AV Result is deemed to comply with AV limit.  
 3. Test setup: RBW: 200 Hz (9 kHz—150 kHz), 9 kHz (150 kHz—30 MHz).  
 4. Step size: 80Hz (0.009MHz-0.15MHz), 4 kHz (0.15MHz-30MHz), Scan time: auto.

# TR-4-E-010 Conducted Emission Test Result

**Test Site** : DDT 1# Shield Room E:\2016 report data\16Q0720-6\CE.EM6  
**Test Date** : 2016-07-29 **Tested By** : Toby  
**EUT** : BLUETOOTH HEADSET **Model Number** : Duet BT  
**Power Supply** : Power from adapter **Test Mode** : Tx Mode  
**Condition** : Temp:24.5°C,Humi:55%,  
**LISN** : 2015 ENV216/LINE  
 Press:100.1kPa  
**Memo** : EDR

Data: 34

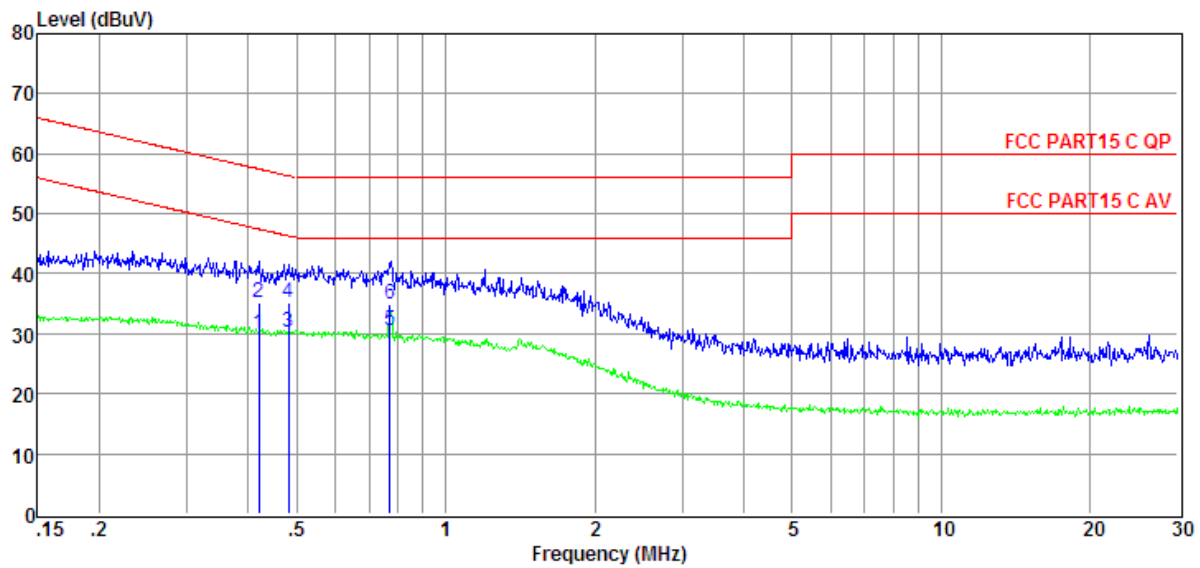

Item	Freq	Read Level	LISN Factor	Cable Loss	Pulse Limiter Factor	Result Level	Limit Line	Over Limit	Detector	Phase
(Mark)	(MHz)	(dBμV)	(dB)	(dB)	(dB)	(dBμV)	(dBμV)	(dB)		
1	0.42	10.41	9.61	0.02	9.86	29.90	47.46	-17.56	Average	LINE
2	0.42	15.77	9.61	0.02	9.86	35.26	57.46	-22.20	QP	LINE
3	0.48	10.72	9.61	0.02	9.86	30.21	46.32	-16.11	Average	LINE
4	0.48	15.74	9.61	0.02	9.86	35.23	56.32	-21.09	QP	LINE
5	0.77	10.94	9.61	0.03	9.86	30.44	46.00	-15.56	Average	LINE
6	0.77	15.46	9.61	0.03	9.86	34.96	56.00	-21.04	QP	LINE

- Note: 1. Result Level = Read Level + LISN Factor + Pulse Limiter Factor + Cable loss.  
 2. If QP Result complies with AV limit, AV Result is deemed to comply with AV limit.  
 3. Test setup: RBW: 200 Hz (9 kHz—150 kHz), 9 kHz (150 kHz—30 MHz).  
 4. Step size: 80Hz (0.009MHz-0.15MHz), 4 kHz (0.15MHz-30MHz), Scan time: auto.

## **13. Antenna Requirements**

### **13.1. Limit**

For intentional device, according to FCC 47 CFR Section 15.203, an intentional radiator shall be designed to ensure that no antenna other than that furnished by the responsible party shall be used with the device. And according to FCC 47 CFR Section 15.247 (b), if transmitting antennas of directional gain greater than 6dBi are used, the power shall be reduced by the amount in dB that the directional gain of the antenna exceeds 6dBi.

### **13.2. Result**

The antennas used for this product are integrated antenna and that no antenna other than that furnished by the responsible party shall be used with the device, the maximum peak gain of the transmit antenna is only 2.93dBi.

**END OF REPORT**