



## FCC AND ISED CERTIFICATION TEST REPORT

<b>Applicant</b>	:	Harman International Industries, Inc.
<b>Address of Applicant</b>	:	8500 Balboa Boulevard, Northridge, CA 91329, UNITED STATES
<b>Manufacturer</b>	:	Harman International Industries, Inc.
<b>Address of Manufacturer</b>	:	8500 Balboa Boulevard, Northridge, CA 91329, UNITED STATES
<b>Equipment under Test</b>	:	Portable Bluetooth Speaker
<b>Model No.</b>	:	CHARGE6G
<b>FCC ID</b>	:	APIJBLCHARGE6G
<b>IC</b>	:	6132A-JBLCHARGE6G
<b>Test Standard(s)</b>	:	FCC Rules and Regulations Part 15 Subpart C, RSS-247 Issue 3 August 2023, ANSI C63.10:2013, RSS-Gen Issue 5, Apr. 2018, Amendment 2 (February 2021)
<b>Report No.</b>	:	DDT-RE25072220-1E02
<b>Issue Date</b>	:	2025/08/21
<b>Issue By</b>	:	Guangdong Dongdian Testing Service Co., Ltd. Unit 2, Building 1, No. 17, Zongbu 2nd Road, Songshan Lake Park, Dongguan, Guangdong, China, 523808

## Table of Contents

1.	Summary of Test Results .....	5
2.	General Test Information.....	6
2.1.	Description of EUT .....	6
2.2.	Accessories of EUT .....	6
2.3.	Block diagram of EUT configuration for test.....	6
2.4.	Decision of final test mode .....	7
2.5.	Deviations of test standard .....	7
2.6.	Test environment conditions .....	7
2.7.	Test laboratory .....	7
2.8.	Measurement uncertainty .....	8
3.	Radiated Emission .....	9
3.1.	Test equipment.....	9
3.2.	Block diagram of test setup .....	10
3.3.	Limits .....	11
3.4.	Assistant equipment used for test .....	13
3.5.	Test procedure .....	13
3.6.	Test result.....	14
3.7.	Test data .....	15
4.	Power Line Conducted Emissions.....	19
4.1.	Test equipment.....	19
4.2.	Block diagram of test setup .....	19
4.3.	Limits .....	19
4.4.	Assistant equipment used for test .....	19
4.5.	Test procedure .....	19
4.6.	Test result.....	20
4.7.	Test data .....	21
5.	Test Setup Photograph .....	23
6.	Photos of the EUT .....	24

## Test Report Declare

Applicant	:	Harman International Industries, Inc.
Address of Applicant	:	8500 Balboa Boulevard, Northridge, CA 91329, UNITED STATES
Equipment under Test	:	Portable Bluetooth Speaker
Model No.	:	CHARGE6G
Manufacturer	:	Harman International Industries, Inc.
Address of Manufacturer	:	8500 Balboa Boulevard, Northridge, CA 91329, UNITED STATES



### Test Standard Used:

FCC Rules and Regulations Part 15 Subpart C,  
 RSS-247 Issue 3 August 2023,  
 ANSI C63.10:2013,  
 RSS-Gen Issue 5, Apr. 2018, Amendment 2 (February 2021)

### We Declare:

The equipment described above is tested by Guangdong Dongdian Testing Service Co., Ltd. and in the configuration tested the equipment complied with the standards specified above. The test results are contained in this test report and Guangdong Dongdian Testing Service Co., Ltd. is assumed of full responsibility for the accuracy and completeness of these tests.

Report No.:	DDT-RE25072220-1E02		
Date of Receipt:	2025/07/24	Date of Test:	2025/07/24 - 2025/08/09

Created: Zoe Peng	Reviewed: Chen Ziqin	Approved: Damon Hu
		
2025/08/09	2025/08/21	2025/08/21

Note: This report applies to above tested sample only. This report shall not be reproduced in parts without written approval of Guangdong Dongdian Testing Service Co., Ltd.

## Revision History

Version	Revision Content	Issue Date	Approved
V0	Initial issue	2025/08/21	Damon Hu

## 1. Summary of Test Results

No.	Test Parameter	Clause No.	Condition	Result
1	Radiated Emission	FCC Part 15: 15.205, FCC Part 15: 15.209, FCC Part 15: 15.247(d), RSS-247 Issue 3 clause 5.5, RSS-Gen Issue 5 clause 8.9, RSS-Gen Issue 5 clause 8.10	/	Pass
2	Power Line Conducted Emissions	FCC Part 15: 15.207(a), RSS-Gen Issue 5 clause 8.8	/	Pass

Note 1: On the basis of the original report: DDT-RE24081413-1E02, this report adds an alternative mainboard which is changed the PCB Layout and IC. Compared with the original mainboard, the PD Protocol IC is changed from MPS MPF52002 to TI TPS65992SBGR, the Charger IC is changed from MPS MP2761 to BQ25798, and the Logic/MCU IC is changed from Linksee LS8A10049T to MSPM0L1105. There is no others change except for the above differences, and the RF part has no impact. Therefore, it is assessed that only the Radiated Emission (below 1 GHz) and Power Line Conducted Emissions have been tested and recorded in this report.

Note 2: Please refer to report DDT-RE24081413-1E02 for the other original data.

## 2. General Test Information

### 2.1. Description of EUT

EUT Name	: Portable Bluetooth Speaker
Model Number	: CHARGE6G
EUT Function Description	: Please reference user manual of this device
Power Supply	: DC 5V/9V/12V/15V/20V 3.0A from external AC Adapter DC 7.2V 4722mAh Polymer Li-ion built-in battery
Antenna Type	: FPC
Max Antenna Gain(dBi)	: 2.11

Note: This EUT support Bluetooth BR/EDR/LE, this report only for Bluetooth LE.

Radio Specification	: Bluetooth LE
Operation Frequency	: 2402 MHz-2480 MHz
Modulation	: GFSK

Note: The above EUT information is declared by manufacturer and for more detailed features description please refer to the manufacturer's specifications or User's Manual. The above Antenna information is declared by manufacturer and for more detailed features description please refer to the manufacturer's specifications, the laboratory shall not be held responsible.

“☑” means to be chosen or applicable; “☐” means don't to be chosen or not applicable; This note applies to entire report.

### 2.2. Accessories of EUT

Accessories	Manufacturer	Model number	Description
/	/	/	/

### 2.3. Block diagram of EUT configuration for test

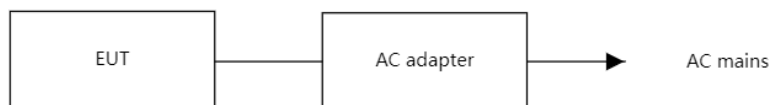

## 2.4. Decision of final test mode

According pre-test, the worst test modes were reported as below:

Test software: FCC.exe

The test software was used to control EUT work in Continuous Tx mode, and select test channel, wireless mode as below table:

The pathloss of external cable: 0.5dB (According to the manufacturer's claims)

Tested mode, channel, information			
Mode	Setting Tx Power	Channel	Frequency (MHz)
GFSK 1M	9	CH0	2402
	9	CH19	2440
	9	CH39	2480
GFSK 2M	9	CH1	2404
	9	CH19	2440
	9	CH38	2478

## 2.5. Deviations of test standard

No deviation.

## 2.6. Test environment conditions

During the measurement the environmental conditions were within the listed ranges:

Temperature range:	+15°C to +35 °C
Humidity range:	20% to 75%
Pressure range:	86 kPa to106 kPa

Note: The specific temperature and humidity information of each test item refers to the temperature and humidity record in the corresponding test data.

## 2.7. Test laboratory

Guangdong Dongdian Testing Service Co., Ltd.

Add.: Unit 2, Building 1, No. 17, Zongbu 2nd Road, Songshan Lake Park, Dongguan, Guangdong, China, 523808.

Tel.: +86-0769-38826678, <http://www.dgddt.com>, Email: [ddt@dgddt.com](mailto:ddt@dgddt.com).

CNAS Accreditation No. L6451; A2LA Accreditation Number: 3870.01

FCC Designation Number: CN1182, Test Firm Registration Number: 540522

Innovation, Science and Economic Development Canada Site Registration Number: 10288A

Conformity Assessment Body identifier: CN0048

VCCI facility registration number: C-20087, T-20088, R-20123, R-20240, G-20118

## 2.8. Measurement uncertainty

Test Item	Uncertainty
Bandwidth	1.1%
Peak Output Power (Conducted) (Spectrum analyzer)	0.86 dB (10 MHz ≤ f < 3.6 GHz);
	1.38 dB (3.6 GHz ≤ f < 8 GHz)
Peak Output Power (Conducted) (Power Sensor)	0.74 dB
Power Spectral Density	0.74 dB (10 MHz ≤ f < 3.6 GHz);
	1.38 dB (3.6 GHz ≤ f < 8 GHz)
Frequencies Stability	6.7 x 10 <sup>-8</sup> (Antenna couple method)
	5.5 x 10 <sup>-8</sup> (Conducted method)
Conducted spurious emissions	0.86 dB (10 MHz ≤ f < 3.6 GHz);
	1.40 dB (3.6 GHz ≤ f < 8 GHz)
	1.66 dB (8 GHz ≤ f < 26.5 GHz)
Uncertainty for radio frequency (RBW < 20 kHz)	3x10 <sup>-8</sup>
Temperature	0.4 °C
Humidity	2 %
Uncertainty for Radiation Emission test (9 kHz – 30 MHz)	3.44 dB
Uncertainty for Radiation Emission test (30 MHz - 1 GHz)	4.70 dB (Antenna Polarize: V)
	4.84 dB (Antenna Polarize: H)
Uncertainty for Radiation Emission test (1 GHz - 40 GHz)	4.10 dB (1 - 6 GHz)
	4.40 dB (6 GHz - 18 GHz)
	3.54 dB (18 GHz - 26 GHz)
	4.30 dB (26 GHz - 40 GHz)
Uncertainty for Power line conduction emission test	3.34dB (150KHz-30MHz)
	3.72dB (9KHz-150KHz)

Note: This uncertainty represents an expanded uncertainty expressed at approximately the 95% confidence level using a coverage factor of k=2.

### 3. Radiated Emission

#### 3.1. Test equipment

Equipment	Manufacturer	Model No.	Serial No.	Cal Due To
Micro-Tronics filters	REBES	BRM50702	DDT-ZC03242	/
RF Cable	N/A	W24.02 HL-562	DDT-ZC04022	2026/03/28
RF cable	Yuhu Technology	JCTB810-NJ-NJ-9M	DDT-ZC02538	2026/03/28
RF cable	Zhongke Junchuang	JCT26S-NJ-NJ-1.5M	DDT-ZC02762	2026/03/28
RF cable	Yuhu Technology	ZT26S-SMAJ-SMAJ-1M	DDT-ZC02037	2026/03/28
RF Cable	N/A	W13.02 AP1-X2	DDT-ZC04023	2026/03/28
Pre-amplifier	COM-POWER	PAM-840A	DDT-ZC01693	2026/03/28
Pre-amplifier	COM-POWER	PAM-118A	DDT-ZC01293	2025/08/25
High pass filter	Micro-Tronics	HPM50102	DDT-ZC00561	2026/03/28
EMI TEST RECEIVER	R&S	ESU26	DDT-ZC01909	2026/03/28
High pass filter	Micro-Tronics	HPM50108	DDT-ZC00560	2026/03/28
High Pass filter	Xi'an Xingbo	XBLBQ-GTA67	DDT-ZC02179	2026/03/28
Micro-Tronics filters	REBES	BRM50716	DDT-ZC03240	/
Broad-Band Horn Antenna	Schwarzbeck	BBHA 9170	DDT-ZC00506	2026/04/01
Trilog Broadband Antenna	Schwarzbeck	VULB 9163	DDT-ZC02050	2026/07/25
Hochgewinn-Hornantenne	SCHWARZBECK	BBHA 9120 D	DDT-ZC02129	2025/09/18
Active Loop Antenna	Schwarzbeck	FMZB1519	DDT-ZC00524	2025/09/11
PSA Series Spectrum Analyzer	Agilent	E4447A	DDT-ZC00517	2026/03/28

### 3.2. Block diagram of test setup

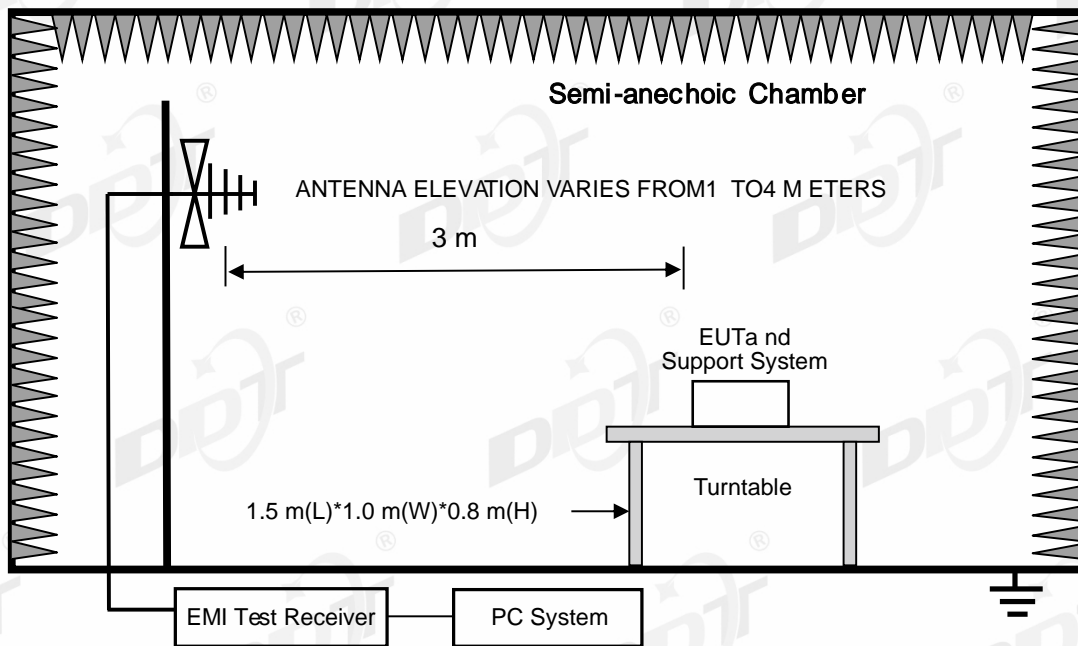
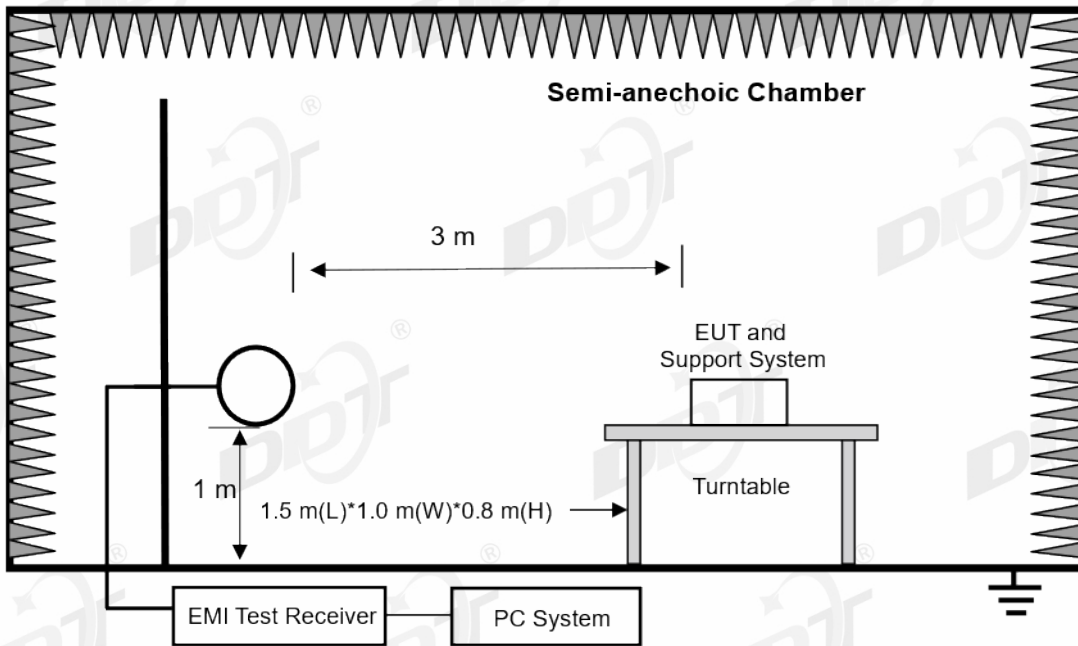

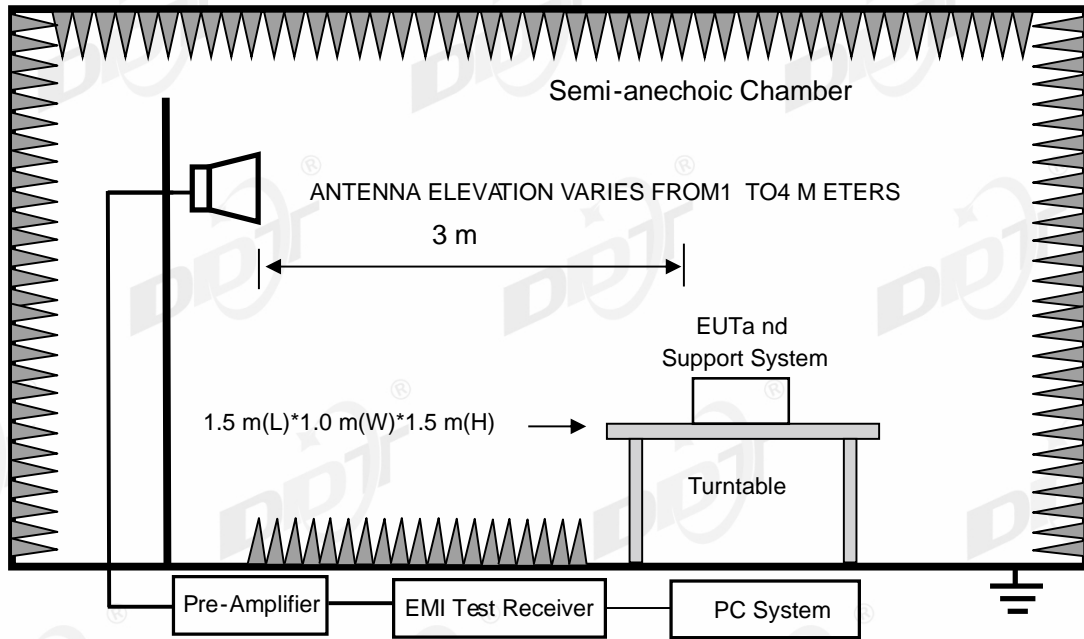

### 3.3. Limits

(1) FCC 15.205 Restricted frequency band

MHz	MHz	MHz	GHz
0.090-0.110	16.42-16.423	399.9-410	4.5-5.15
10.495-0.505	16.69475-16.69525	608-614	5.35-5.46
2.1735-2.1905	16.80425-16.80475	960-1240	7.25-7.75
4.125-4.128	25.5-25.67	1300-1427	8.025-8.5
4.1772&4.17775	37.5-38.25	1435-1626.5	9.0-9.2
4.2072&4.20775	73-74.6	1645.5-1646.5	9.3-9.5
6.215-6.218	74.8-75.2	1660-1710	10.6-12.7
6.26775-6.26825	108-121.94	1718.8-1722.2	13.25-13.4
6.31175-6.31225	123-138	2200-2300	14.47-14.5
8.291-8.294	149.9-150.05	2310-2390	15.35-16.2
8.362-8.366	156.52475-156.52525	2483.5-2500	17.7-21.4
8.37625-8.38675	156.7-156.9	2690-2900	22.01-23.12
8.41425-8.41475	162.0125-167.17	3260-3267	23.6-24.0
12.29-12.293	167.72-173.2	3332-3339	31.2-31.8
12.51975-12.52025	240-285	3345.8-3358	36.43-36.5
12.57675-12.57725	322-335.4	3600-4400	(2)
13.36-13.41			

1Until February 1, 1999, this restricted band shall be 0.490-0.510 MHz

2Above 38.6

RSS-Gen section 8.10 Restricted frequency bands\*

MHz	MHz	MHz	GHz
0.090-0.110	12.51975-12.52025	240-285	3.5-4.4
0.495-0.505	12.57675-12.57725	322-335.4	4.5-5.15
2.1735-2.1905	13.36-13.41	399.9-410	5.35-5.46
3.020-3.026	16.42-16.423	608-614	7.25-7.75
4.125-4.128	16.69475-16.69525	960-1427	8.025-8.5
4.1772&4.17775	16.80425-16.80475	1435-1626.5	9.0-9.2
4.2072&4.20775	25.5-25.67	1645.5-1646.5	9.3-9.5
5.677-5.683	37.5-38.25	1660-1710	10.6-12.7
6.215-6.218	73-74.6	1718.8-1722.2	13.25-13.4
6.26775-6.26825	74.8-75.2	2200-2300	14.47-14.5
6.31175-6.31225	108-138	2310-2390	15.35-16.2
8.291-8.294	149.9-150.05	2483.5-2500	17.7-21.4
8.362-8.366	156.52475-156.52525	2655-2900	22.01-23.12
8.37625-8.38675	156.7-156.9	3260-3267	23.6-24.0
8.41425-8.41475	162.0125-167.17	3332-3339	31.2-31.8
12.29-12.293	167.72-173.2	3345.8-3358	36.43-36.5
			Above 38.6

\* Certain frequency bands listed in table and in bands above 38.6 GHz are designated for licence-exempt applications. These frequency bands and the requirements that apply to related devices are set out in the 200 and 300 series of RSSs.

(2) FCC 15.209 Limit & RSS-Gen section 8.9 Limit

FREQUENCY MHz	DISTANCE Meters	FIELD STRENGTHS LIMIT	
		mV/m	dB(mV)/m
0.009 ~ 0.490	300	2400/F(kHz)	67.6-20log(F)
0.490 ~ 1.705	30	24000/F(kHz)	87.6-20log(F)
1.705 ~ 30.0	30	30	29.54
30~88	3	100	40.0
88~216	3	150	43.5
216~960	3	200	46.0
960~1000	3	500	54.0
Above 1000	3	74.0 dB(mV)/m (Peak) 54.0 dB(mV)/m (Average)	

Note:

(1) The emission limits shown in the above table are based on measurements employing a CISPR QP detector except for the frequency bands 9 - 90 kHz, 110 - 490 kHz and above 1000 MHz, radiated emissions limits in these three bands are based on measurements employing an average detector.

(2) At frequencies below 30 MHz, measurement may be performed at a distance closer than that specified, and the limit at closer measurement distance can be extrapolated by below formula:

$$\text{Limit}_{3\text{m}}(\text{dBuV/m}) = \text{Limit}_{30\text{m}}(\text{dBuV/m}) + 40\text{Log}(30\text{m}/3\text{m})$$

(3) Limit for this EUT

The emissions appearing within 15.205 restricted frequency bands shall not exceed the limits shown in 15.209, and the emissions appearing within RSS-Gen section 8.10 Restricted frequency bands shall not exceed the limits shown in RSS-Gen section 8.9, all the other emissions shall be at least 20 dB below the fundamental emissions or comply with 15.209 limits and RSS-Gen section 8.9 limits.

### 3.4. Assistant equipment used for test

Assistant equipment	Manufacturer	Model number	Description	other
/	/	/	/	/

### 3.5. Test procedure

(1) EUT was placed on a non-metallic table, 80 cm above the ground plane inside a semi-anechoic chamber for below 1G and 150 cm above the ground plane inside a fully-anechoic chamber for above 1G.

(2) Test antenna was located 3 m from the EUT on an adjustable mast, and the antenna used as below table.

Test frequency range	Test antenna used	Test antenna distance
9 kHz - 30 MHz	Active Loop antenna	3 m
30 MHz - 1 GHz	Trilog Broadband Antenna	3 m
1 GHz - 18 GHz	Double Ridged Horn Antenna(1 GHz-18 GHz)	3 m
18 GHz - 40 GHz	Horn Antenna(18 GHz-40 GHz)	1 m

According ANSI C63.10:2013 clause 6.4.6 and 6.5.3, for measurements below 30 MHz, Antenna was located 3 m from EUT, the loop antenna was positioned in three antenna orientations (parallel, perpendicular, and round-parallel), for each measurement antenna alignment, the EUT shall be rotated through 0° to 360° on a turntable, and the lowest height of the magnetic antenna shall be 1 m above the ground. For measurement above 30MHz, the trilog Broadband Antenna or Horn Antenna was located 3m from EUT, Measurements were made with the antenna positioned in both the horizontal and vertical planes of Polarization, and the measurement antenna was varied from 1 m to 4 m. in height above the reference ground plane to obtain the maximum signal strength.

(3) Below pre-scan procedure was first performed in order to find prominent frequency spectrum radiated emissions from 9 kHz to 25 GHz:

(a) Scanning the peak frequency spectrum with the antenna specified in step (3), and the EUT was rotated 360 degree, the antenna height was varied from 1 m to 4 m (Except loop antenna, it's fixed 1 m above ground.)

(b) Change work frequency or channel of device if practicable.

(c) Change modulation type of device if practicable.

(d) Change power supply range from 85% to 115% of the rated supply voltage

(e) Rotated EUT through three orthogonal axes to determine the attitude of EUT arrangement produces highest emissions.

Spectrum frequency from 9 kHz to 25 GHz (tenth harmonic of fundamental frequency) was investigated, and no any obvious emission were detected from 18 GHz to 25 GHz, so below final test was performed with frequency range from 9 kHz to 18 GHz.

(4) For final emissions measurements at each frequency of interest, the EUT was rotated and the antenna height was varied between 1 m and 4 m in order to maximize the emission. Measurements in both horizontal and vertical polarities were made and the data was recorded. In order to find the maximum emission, the relative positions of equipment and all of the interface cables were changed according to ANSI C63.10:2013 on Radiated Emission test.

(5) The emissions from 9 kHz to 1 GHz were measured based on CISPR QP detector except for the frequency bands 9 - 90 kHz, 110 - 490 kHz, for emissions from 9 kHz - 90 kHz, 110 kHz - 490 kHz and above 1 GHz were measured based on average detector, for emissions above 1 GHz, peak emissions also be measured and need comply with Peak limit.

(6) The emissions from 9 kHz to 1 GHz, QP or average values were measured with EMI receiver with below RBW.

Frequency band	RBW
9 kHz - 150 kHz	200 Hz
150 kHz - 30 MHz	9 kHz
30 MHz - 1 GHz	120 kHz

(7) For emissions above 1GHz, both Peak and Average level were measured with Spectrum Analyzer, and the RBW is set at 1 MHz, VBW is set at 3 MHz for Peak measure; According ANSI C63.10:2013 clause 4.1.4.2.2 procedure for average measure.

(8) For portable device, X axis, Y axis, Z axis are tested, and worse setup is reported.

(9) According exploratory test, the emission levels are 20 dB below the limit detected from 9 kHz to 30 MHz and 18 GHz to 25 GHz, so the final test was performed with frequency range from 30 MHz to 18 GHz and recorded in below.

(10) For 30 MHz ~ 25 GHz: (Scan with all mode, the worst case is reported)

(11) For emissions below 1 GHz, according exploratory explorer test, when change Tx mode and channel, have no distinct influence on emissions level, so for emissions below 1 GHz, the final test was only performed with EUT working in worst mode.

### 3.6. Test result

**PASS. (See below detailed test result)**

## 3.7. Test data

## TR-4-E-009 Radiated Emission Test Result

**Test Date:** 2025-08-08 **Tested By:** Nan Zhong  
**EUT:** Portable Bluetooth Speaker **Model Number:** CHARGE6G  
**Test Mode:** TX BLE1M mode **Power Supply:** Battery  
**Condition:** Temp:20.5°C;Humi:43.9% **Test Site:** DDT 3# Chamber  
**File Path:** d:\ts\2025 report date\Q25072220\FCC BELOW1G\20250808-040552\_H  
**Memo:** Sample Number:S25072220

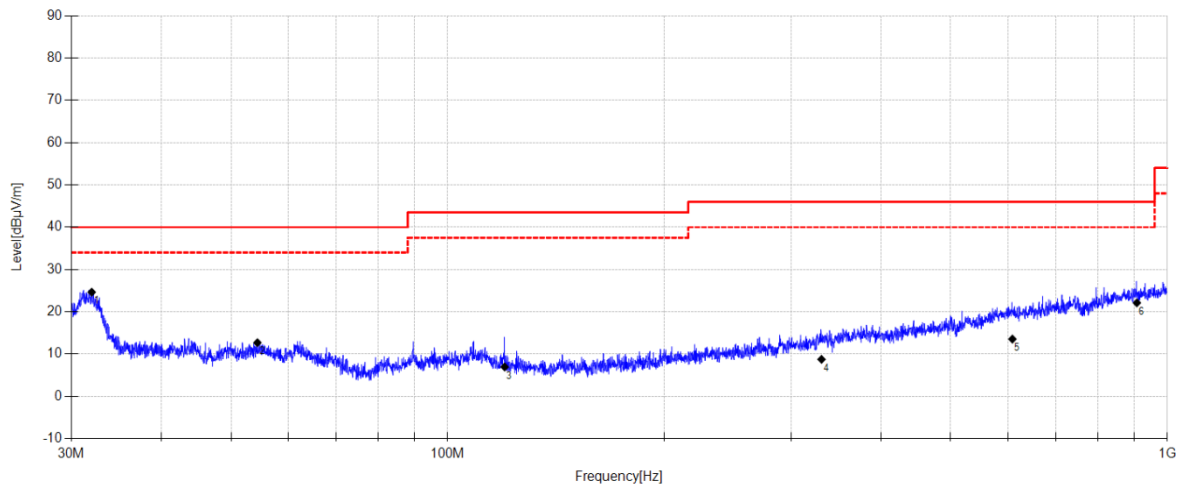

Final Data List									
NO.	Freq. [MHz]	Reading [dBμV/m]	Antenna Factor [dB]	Cable Loss [dB]	Result [dBμV/m]	Limit [dBμV/m]	Margin [dB]	Detector	Polarity
1	32.021	41.84	10.12	3.77	24.63	40.00	15.37	QP	Horizontal
2	54.407	27.4	12.46	3.92	12.68	40.00	27.32	QP	Horizontal
3	119.991	23.73	10.00	4.33	6.94	43.50	36.56	QP	Horizontal
4	330.732	20.48	14.34	5.34	8.74	46.00	37.26	QP	Horizontal
5	609.127	19.3	19.33	6.40	13.53	46.00	32.47	QP	Horizontal
6	907.136	23.72	21.69	7.22	22.10	46.00	23.90	QP	Horizontal

## Note:

1. Result Level = Reading + Cable loss + Antenna Factor + AMP
2. If Peak Result complies with QP limit, QP Result is deemed to comply with QP limit.
3. Test setup: RBW: 120 kHz, VBW: 300 kHz, Sweep time: auto.

## TR-4-E-009 Radiated Emission Test Result

**Test Date:** 2025-08-08 **Tested By:** Nan Zhong  
**EUT:** Portable Bluetooth Speaker **Model Number:** CHARGE6G  
**Test Mode:** TX BLE1M mode **Power Supply:** Battery  
**Condition:** Temp:20.5°C;Humi:43.9% **Test Site:** DDT 3# Chamber  
**File Path:** d:\ts\2025 report date\Q25072220\FCC BELOW1G\20250808-040615\_V  
**Memo:** Sample Number:S25072220-001

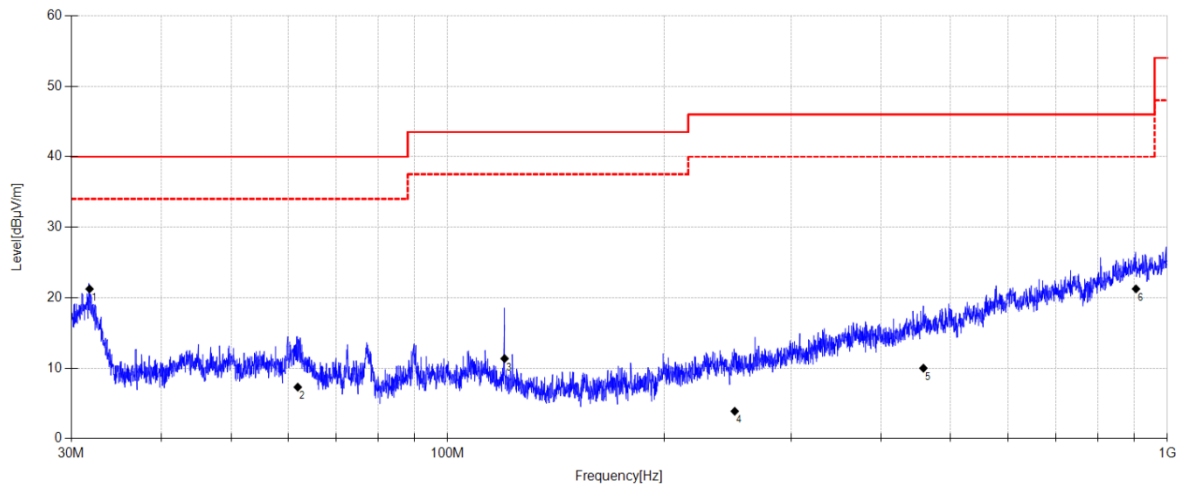

### Final Data List

NO.	Freq. [MHz]	Reading [dBμV/m]	Antenna Factor [dB]	Cable Loss [dB]	Result [dBμV/m]	Limit [dBμV/m]	Margin [dB]	Detector	Polarity
1	31.798	38.4	10.16	3.77	21.23	40.00	18.77	QP	Vertical
2	61.899	21.67	12.76	3.97	7.30	40.00	32.70	QP	Vertical
3	119.991	28.14	10.00	4.33	11.35	43.50	32.15	QP	Vertical
4	250.546	18.48	11.71	4.99	3.88	46.00	42.12	QP	Vertical
5	458.221	19.69	15.94	5.84	9.99	46.00	36.01	QP	Vertical
6	904.595	22.68	21.90	7.21	21.24	46.00	24.76	QP	Vertical

### Note:

1. Result Level = Reading + Cable loss + Antenna Factor + AMP
2. If Peak Result complies with QP limit, QP Result is deemed to comply with QP limit.
3. Test setup: RBW: 120 kHz, VBW: 300 kHz, Sweep time: auto.

## TR-4-E-009 Radiated Emission Test Result

**Test Date:** 2025-08-08 **Tested By:** Nan Zhong  
**EUT:** Portable Bluetooth Speaker **Model Number:** CHARGE6G  
**Test Mode:** TX BLE2M mode **Power Supply:** Battery  
**Condition:** Temp:20.5°C;Humi:43.9% **Test Site:** DDT 3# Chamber  
**File Path:** d:\ts\2025 report date\Q25072220\FCC BELOW1G\20250808-040820\_H  
**Memo:** Sample Number:S25072220-001

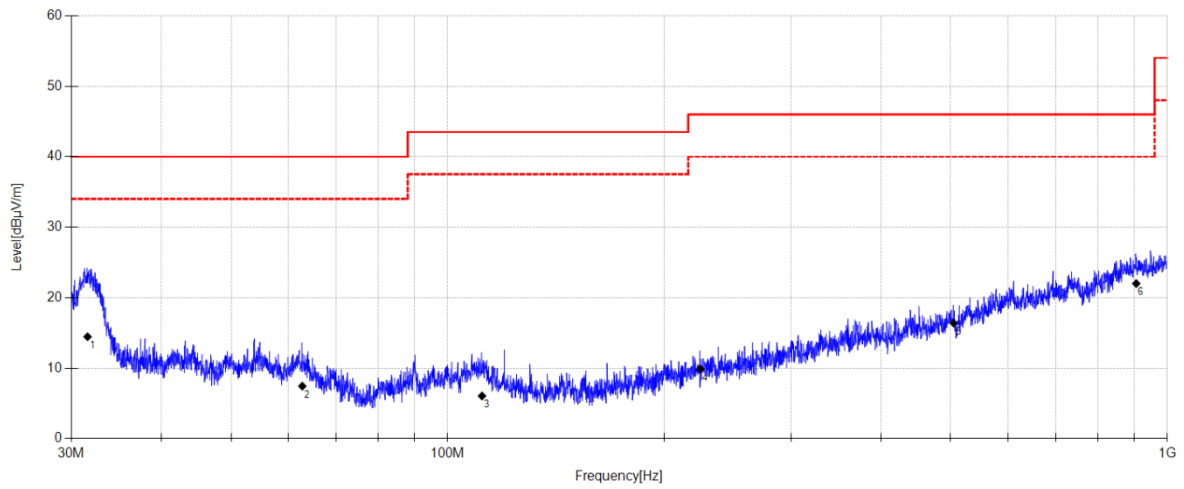

### Final Data List

NO.	Freq. [MHz]	Reading [dBμV/m]	Antenna Factor [dB]	Cable Loss [dB]	Result [dBμV/m]	Limit [dBμV/m]	Margin [dB]	Detector	Polarity
1	31.598	31.56	10.22	3.77	14.45	40.00	25.55	QP	Horizontal
2	62.817	22.09	12.47	3.98	7.44	40.00	32.56	QP	Horizontal
3	111.630	21.11	11.77	4.28	6.05	43.50	37.45	QP	Horizontal
4	224.429	25.01	11.27	4.87	9.90	46.00	36.10	QP	Horizontal
5	504.775	25.14	16.72	6.02	16.38	46.00	29.62	QP	Horizontal
6	905.230	23.45	21.88	7.21	22.00	46.00	24.00	QP	Horizontal

### Note:

1. Result Level = Reading + Cable loss + Antenna Factor + AMP
2. If Peak Result complies with QP limit, QP Result is deemed to comply with QP limit.
3. Test setup: RBW: 120 kHz, VBW: 300 kHz, Sweep time: auto.

## TR-4-E-009 Radiated Emission Test Result

**Test Date:** 2025-08-08 **Tested By:** Nan Zhong  
**EUT:** Portable Bluetooth Speaker **Model Number:** CHARGE6G  
**Test Mode:** TX BLE2M mode **Power Supply:** Battery  
**Condition:** Temp:20.5°C;Humi:43.9% **Test Site:** DDT 3# Chamber  
**File Path:** d:\ts\2025 report date\Q25072220\FCC BELOW1G\20250808-040843\_V  
**Memo:** Sample Number:S25072220-001

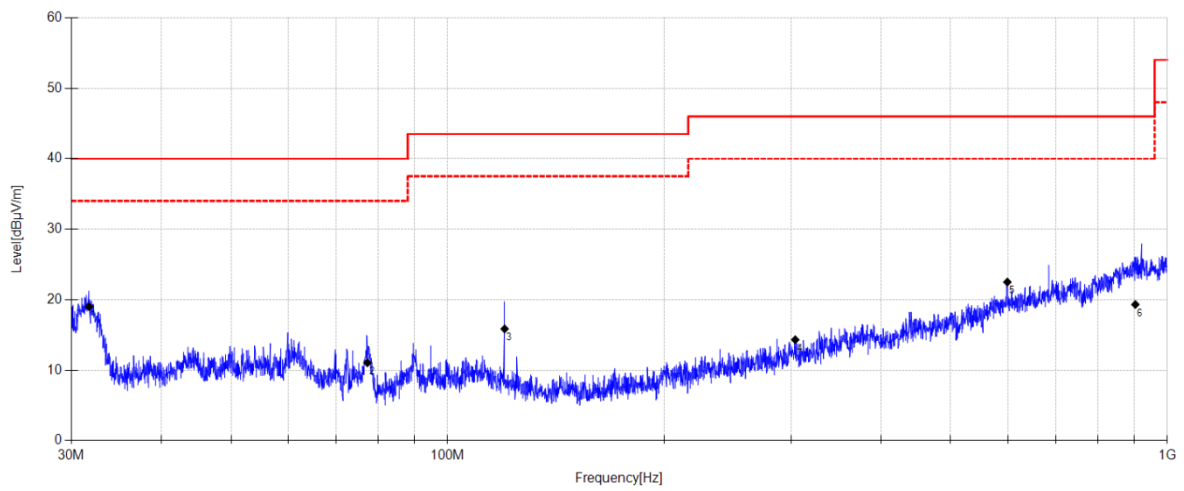

### Final Data List

NO.	Freq. [MHz]	Reading [dBμV/m]	Antenna Factor [dB]	Cable Loss [dB]	Result [dBμV/m]	Limit [dBμV/m]	Margin [dB]	Detector	Polarity
1	31.753	36.17	10.17	3.77	19.01	40.00	20.99	QP	Vertical
2	77.361	30.1	7.97	4.07	11.04	40.00	28.96	QP	Vertical
3	119.991	32.64	10.00	4.33	15.85	43.50	27.65	QP	Vertical
4	304.042	26.77	13.70	5.24	14.31	46.00	31.69	QP	Vertical
5	599.383	28.47	19.15	6.37	22.49	46.00	23.51	QP	Vertical
6	902.695	20.75	21.90	7.21	19.31	46.00	26.69	QP	Vertical

### Note:

1. Result Level = Reading + Cable loss + Antenna Factor + AMP
2. If Peak Result complies with QP limit, QP Result is deemed to comply with QP limit.
3. Test setup: RBW: 120 kHz, VBW: 300 kHz, Sweep time: auto.

## 4. Power Line Conducted Emissions

### 4.1. Test equipment

Equipment	Manufacturer	Model No.	Serial No.	Cal Due To
EMI Test Receiver	R&S	ESCI	DDT-ZC00235	2026/07/06
Two Line V-Network	R&S	ENV216	DDT-ZC00535	2026/07/06
Artificial mains	R&S	ESH2-Z5	DDT-ZC00538	2026/07/06
Pulse Limiter	SCHWARZBEC K	ESH3-Z2	DDT-ZC00539	2026/07/06
CE Cable 1	R&S	ESU8/RF2	DDT-ZC00566	2026/07/06
EMI Test Software	Audix/TW	e3	DDT-ZC01252	/

### 4.2. Block diagram of test setup

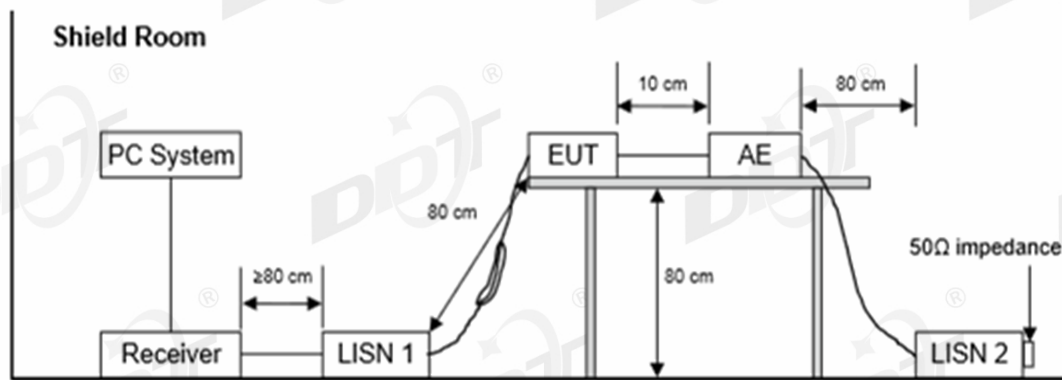

### 4.3. Limits

Frequency	Quasi-Peak Level dB(mV)	Average Level dB(mV)
150 kHz~500 kHz	66 ~ 56*	56 ~ 46*
500 kHz~5 MHz	56	46
5 MHz~30 MHz	60	50

Note 1: \* Decreasing linearly with logarithm of frequency.

Note 2: The lower limit shall apply at the transition frequencies.

### 4.4. Assistant equipment used for test

Assistant equipment	Manufacturer	Model number	Description	other
Adapter	HUAWEI	HW-100400C01	Huawei Fast Charge 2 #	Input: 100-240V~50/60Hz, Output: 5V/2A or 9V/2A or 10V/4A MAX

### 4.5. Test procedure

The EUT and Support equipment, if needed, were put placed on a non-metallic table, 80cm above the ground plane.

All support equipment power received from a second LISN.

Emissions were measured on each current carrying line of the EUT using an EMI Test Receiver connected to the LISN powering the EUT.

The Receiver scanned from 150 kHz to 30 MHz for emissions in each of the test modes.

During the above scans, the emissions were maximized by cable manipulation.

The test mode(s) described in clause 2.4 were scanned during the preliminary test.

After the preliminary scan, we found the test mode producing the highest emission level.

The EUT configuration and worse cable configuration of the above highest emission levels were recorded for reference of the final test.

EUT and support equipment were set up on the test bench as per the configuration with highest emission level in the preliminary test.

A scan was taken on both power lines, Neutral and Line, recording at least the six highest emissions.

Emission frequency and amplitude were recorded into a computer in which correction factors were used to calculate the emission level and compare reading to the applicable limit.

The test data of the worst-case condition(s) was recorded.

The bandwidth of test receiver is set at 9 kHz.

#### 4.6. Test result

##### **PASS. (See below detailed test result)**

Note1: All emissions not reported below are too low against the prescribed limits.

Note2: "----" means Peak detection; "----" means Average detection.

Note3: Pre-test AC conducted emission at both voltage AC 120V/60Hz and AC 240V/50Hz, recorded the worst case.

4.7. Test data

## TR-4-E-010 Conducted Emission Test Result

Test Site	: DDT 1# Shield Room	D:\2025 CE report data\Q25072220-1E\CE.EM6
Test Date	: 2025-08-07	Tested By : Rose Li
EUT	: Portable Bluetooth Speaker	Model Number : CHARGE6G
Power Supply	: AC 120V/60Hz	Test Mode : TX mode
Condition	: TEMP:22.3°C, RH:65.1%	LISN : 2024 1# ENV216/NEUTRAL
Memo	:	

Data: 6

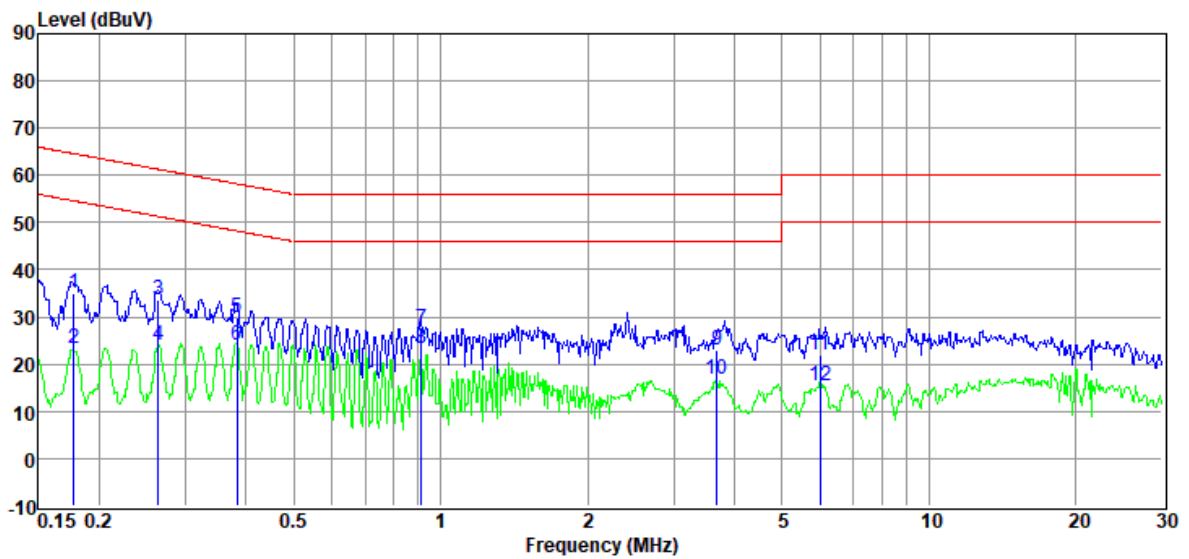

Item (Mark)	Freq. (MHz)	Read Level (dBμV)	LISN Factor (dB)	Cable Loss (dB)	Pulse Limiter Factor (dB)	Result Level (dBμV)	Limit Line (dBμV)	Over Limit (dB)	Detector	Phase
1	0.18	15.32	9.67	0.12	9.86	34.97	64.59	-29.62	QP	NEUTRAL
2	0.18	3.83	9.67	0.12	9.86	23.48	54.59	-31.11	Average	NEUTRAL
3	0.26	13.81	9.72	0.14	9.86	33.53	61.29	-27.76	QP	NEUTRAL
4	0.26	4.32	9.72	0.14	9.86	24.04	51.29	-27.25	Average	NEUTRAL
5	0.38	10.02	9.75	0.11	9.86	29.74	58.21	-28.47	QP	NEUTRAL
6	0.38	4.19	9.75	0.11	9.86	23.91	48.21	-24.30	Average	NEUTRAL
7	0.91	7.72	9.71	0.06	9.88	27.37	56.00	-28.63	QP	NEUTRAL
8	0.91	3.72	9.71	0.06	9.88	23.37	46.00	-22.63	Average	NEUTRAL
9	3.68	3.39	9.65	0.05	9.86	22.95	56.00	-33.05	QP	NEUTRAL
10	3.68	-2.75	9.65	0.05	9.86	16.81	46.00	-29.19	Average	NEUTRAL
11	5.99	2.33	9.69	0.07	9.88	21.97	60.00	-38.03	QP	NEUTRAL
12	5.99	-4.05	9.69	0.07	9.88	15.59	50.00	-34.41	Average	NEUTRAL

Note:

1. Result Level = Read Level + LISN Factor + Pulse Limiter Factor + Cable loss.
2. If QP Result complies with AV limit, AV Result is deemed to comply with AV limit.
3. Test setup: RBW: 200 Hz (9 kHz—150 kHz), 9 kHz (150 kHz—30 MHz).
4. Step size: 80Hz (0.009MHz-0.15MHz), 4 kHz (0.15MHz-30MHz), Scan time: auto.

# TR-4-E-010 Conducted Emission Test Result

**Test Site** : DDT 1# Shield Room D:\2025 CE report data\Q25072220-1E\CE.EM6  
**Test Date** : 2025-08-07 **Tested By** : Rose Li  
**EUT** : Portable Bluetooth Speaker **Model Number** : CHARGE6G  
**Power Supply** : AC 120V/60Hz **Test Mode** : TX mode  
**Condition** : TEMP:22.3°C, RH:65.1% **LISN** : 2024 1# ENV216/LINE  
**Memo** :

Data: 8

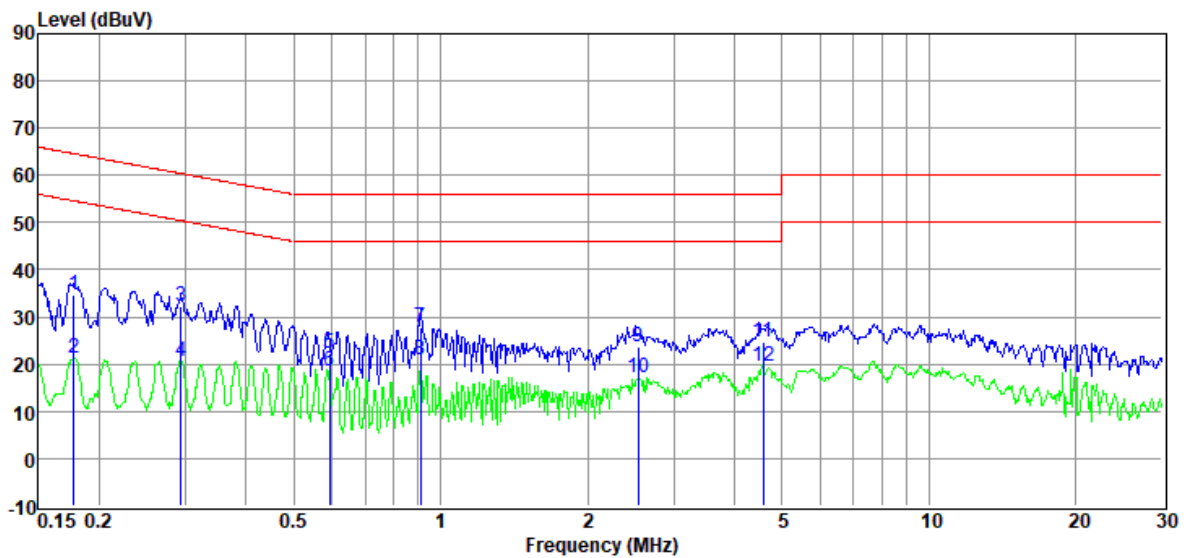

Item	Freq.	Read Level	LISN Factor	Cable Loss	Pulse Limiter Factor	Result Level	Limit Line	Over Limit	Detector	Phase
(Mark)	(MHz)	(dBμV)	(dB)	(dB)	(dB)	(dBμV)	(dBμV)	(dB)		
1	0.18	14.94	9.81	0.12	9.86	34.73	64.59	-29.86	QP	LINE
2	0.18	1.54	9.81	0.12	9.86	21.33	54.59	-33.26	Average	LINE
3	0.29	12.57	9.75	0.15	9.86	32.33	60.41	-28.08	QP	LINE
4	0.29	0.92	9.75	0.15	9.86	20.68	50.41	-29.73	Average	LINE
5	0.59	2.60	9.86	0.07	9.86	22.39	56.00	-33.61	QP	LINE
6	0.59	-1.22	9.86	0.07	9.86	18.57	46.00	-27.43	Average	LINE
7	0.91	7.89	9.80	0.06	9.88	27.63	56.00	-28.37	QP	LINE
8	0.91	1.08	9.80	0.06	9.88	20.82	46.00	-25.18	Average	LINE
9	2.54	4.11	9.75	0.05	9.86	23.77	56.00	-32.23	QP	LINE
10	2.54	-2.47	9.75	0.05	9.86	17.19	46.00	-28.81	Average	LINE
11	4.57	4.91	9.75	0.05	9.85	24.56	56.00	-31.44	QP	LINE
12	4.57	0.07	9.75	0.05	9.85	19.72	46.00	-26.28	Average	LINE

Note:

1. Result Level = Read Level + LISN Factor + Pulse Limiter Factor + Cable loss.
2. If QP Result complies with AV limit, AV Result is deemed to comply with AV limit.
3. Test setup: RBW: 200 Hz (9 kHz—150 kHz), 9 kHz (150 kHz—30 MHz).
4. Step size: 80Hz (0.009MHz-0.15MHz), 4 kHz (0.15MHz-30MHz), Scan time: auto.

## 6. Photos of the EUT

Please refer to DDT-Q25072220-2E appendix I

-----End Report-----