

11AX40MIMO\_Ant1\_2452

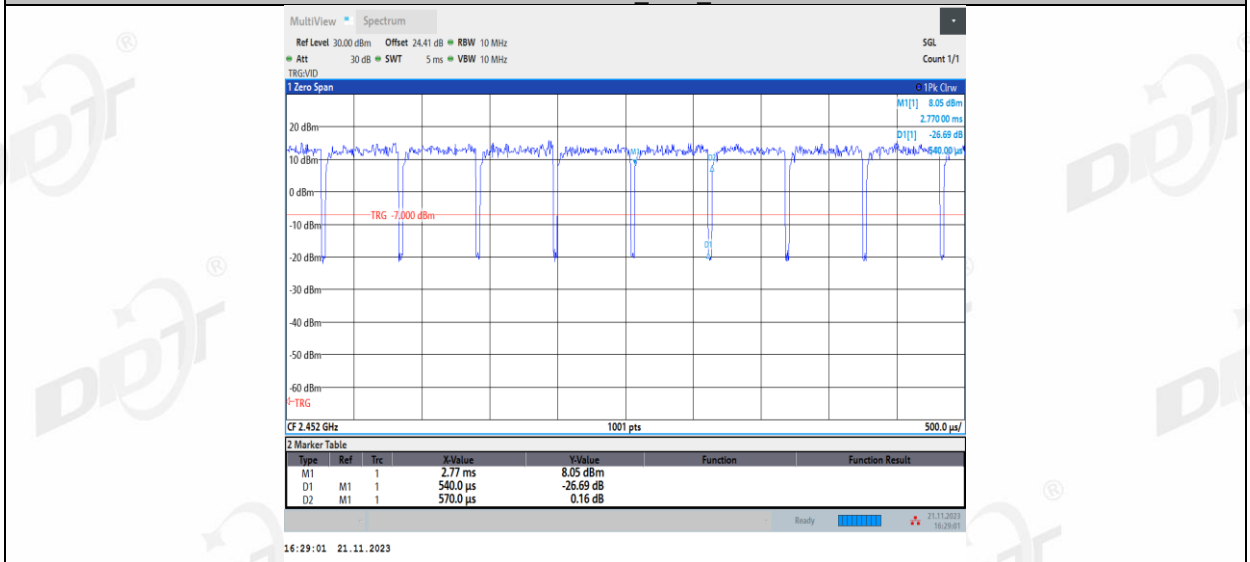

11AX40MIMO\_Ant2\_2452

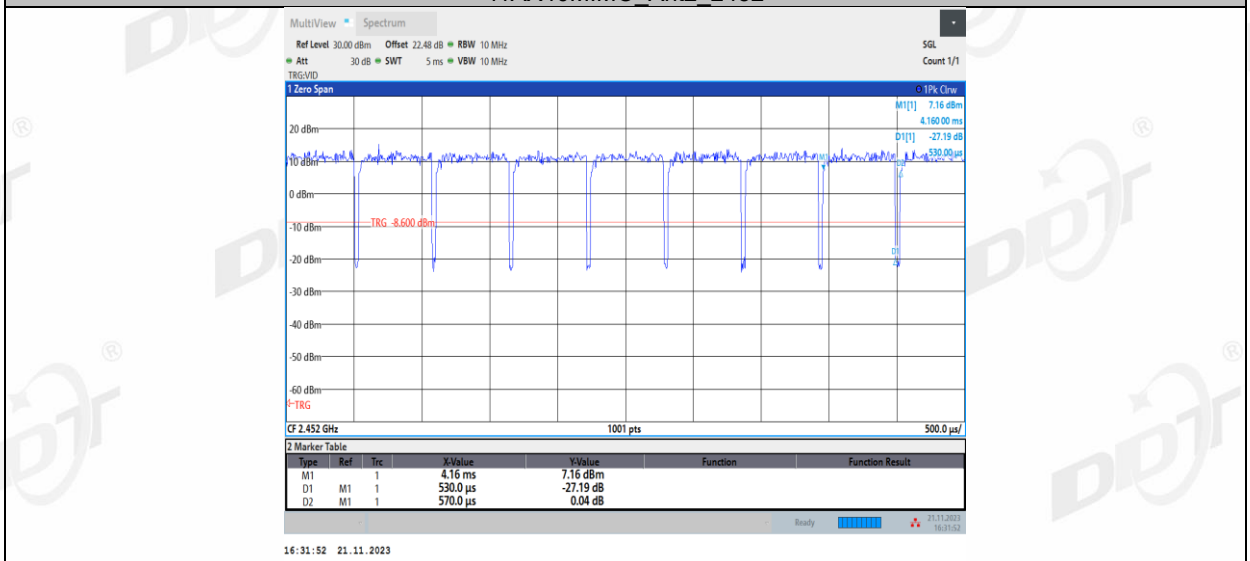

## 11. Antenna Requirements

### 11.1. Limit

For intentional device, according to FCC 47 CFR Section 15.203, an intentional radiator shall be designed to ensure that no antenna other than that furnished by the responsible party shall be used with the device. And according to FCC 47 CFR Section 15.247 (b), if transmitting antennas of directional gain greater than 6 dBi are used, the power shall be reduced by the amount in dB that the directional gain of the antenna exceeds 6 dBi.

For intentional device, according to RSS-Gen issue 5 section 6.8.

The applicant for equipment certification shall provide a list of all antenna types that may be used with the transmitter, where applicable (i.e. for transmitters with detachable antenna), indicating the maximum permissible antenna gain (in dBi) and the required impedance for each antenna. The test report shall demonstrate the compliance of the transmitter with the limit for maximum equivalent isotropically radiated power (e.i.r.p.) specified in the applicable RSS, when the transmitter is equipped with any antenna type, selected from this list.

### 11.2. Result

The antenna used for this product as Antenna information described in section 2.1 of the report, and there is no other antenna than that furnished by the responsible party shall be used with the device.

## 12.Radiated Emission

### 12.1. Test equipment

Equipment	Manufacturer	Model No.	Serial No.	Cal Due To
High pass filter	Micro-Tronics	HPM50102	DDT-ZC00561	2024/05/14
Hochgewinn-Hornantenne	Schwarzbeck Mess-Elektronik	BBHA 9120 D	DDT-ZC02129	2024/09/17
RF Cable	N/A	W24.02 HL-562	DDT-ZC04022	2024/04/21
Micro-Tronics filters	REBES	BRM50716	DDT-ZC03240	/
RF cable	Yuhu Technology	JCTB810-NJ-NJ-9M	DDT-ZC02538	2024/04/23
Pre-amplifier	COM-POWER	PAM-118A	DDT-ZC01293	2024/07/14
Active Loop Antenna	Schwarzbeck	FMZB1519	DDT-ZC00524	2024/09/10
PSA Series Spectrum Analyzer	Agilent	E4447A	DDT-ZC00517	2024/04/23
High Pass filter	西安星博	XBLBQ-GTA67	DDT-ZC02179	2024/05/14
High pass filter	Micro-Tronics	HPM50108	DDT-ZC00560	2024/05/14
Trilog Broadband Antenna	Schwarzbeck	VULB 9163	DDT-ZC02050	2024/07/11
EMI TEST RECEIVER	R&S	ESU26	DDT-ZC01909	2024/04/23
Broad-Band Horn Antenna	Schwarzbeck	BBHA 9170	DDT-ZC00506	2024/04/26
Micro-Tronics filters	REBES	BRM50702	DDT-ZC03242	/
Pre-amplifier	COM-POWER	PAM-840A	DDT-ZC01693	2024/04/27
RF cable	Zhongke Junchuang	JCT26S-NJ-NJ-1.5M	DDT-ZC02762	2024/04/20
RF cable	Yuhu Technology	ZT26S-SMAJ-SMAJ-1M	DDT-ZC02037	2024/04/23
RF Cable	N/A	W13.02 AP1-X2	DDT-ZC04023	2024/04/21

### 12.2. Block diagram of test setup

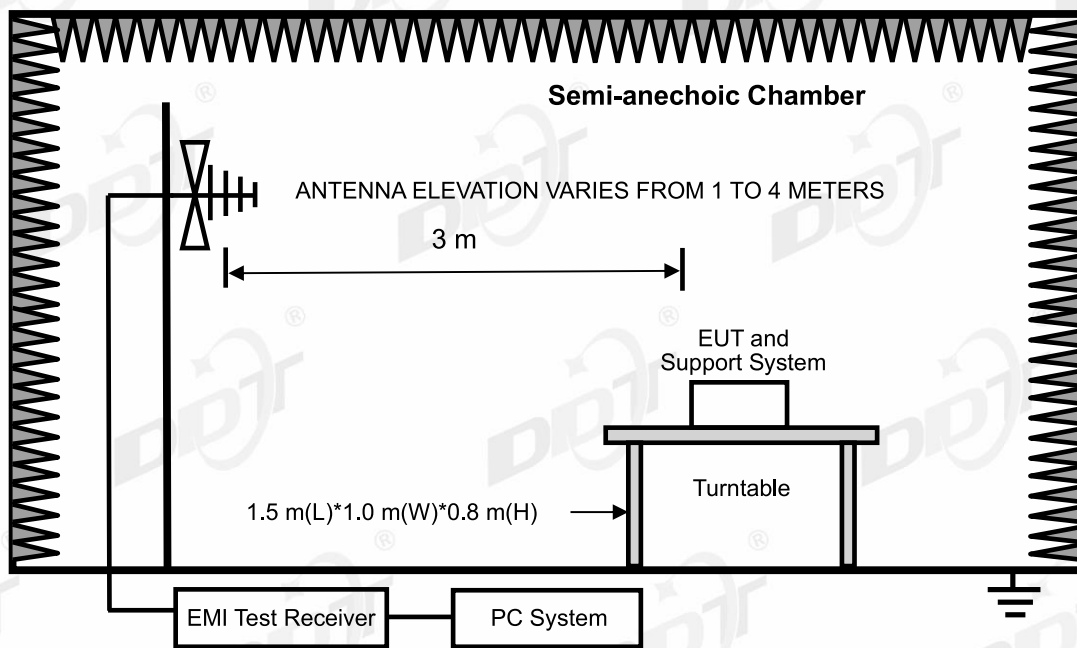
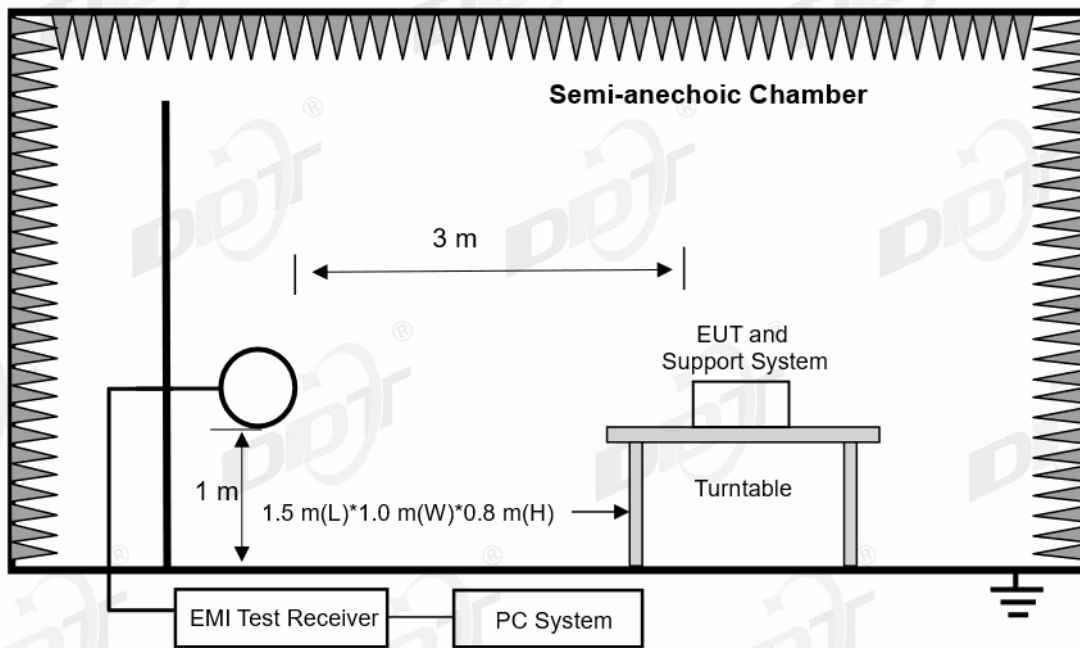

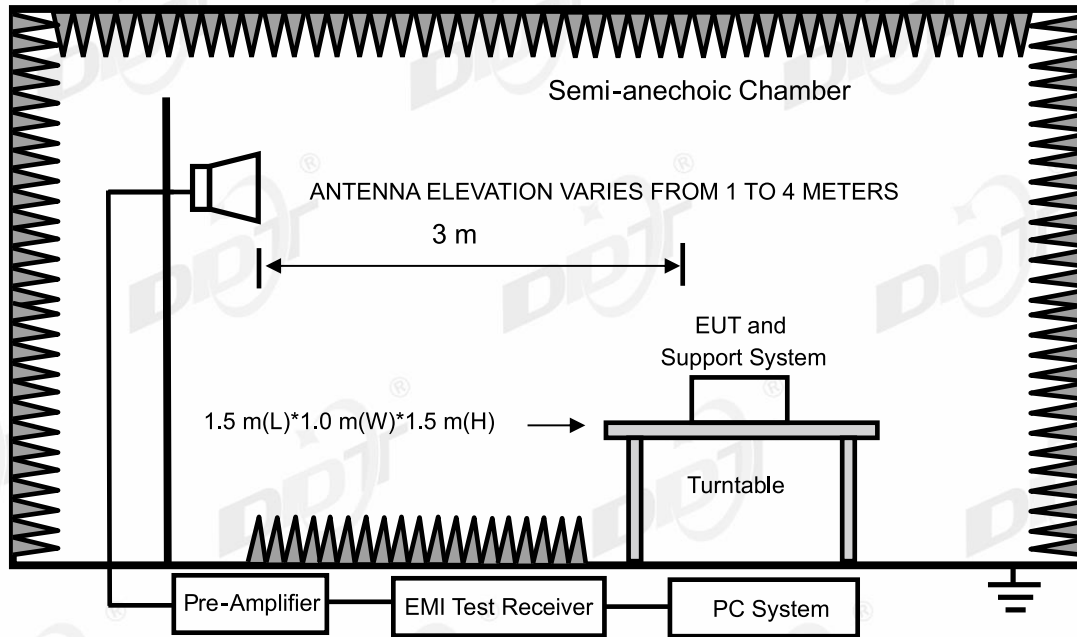

**12.3. Limits**

(1) FCC 15.205 Restricted frequency band

MHz	MHz	MHz	GHz
0.090-0.110	16.42-16.423	399.9-410	4.5-5.15
0.495-0.505	16.69475-16.69525	608-614	5.35-5.46
2.1735-2.1905	16.80425-16.80475	960-1240	7.25-7.75
4.125-4.128	25.5-25.67	1300-1427	8.025-8.5
4.1772&4.17775	37.5-38.25	1435-1626.5	9.0-9.2
4.2072&4.20775	73-74.6	1645.5-1646.5	9.3-9.5
6.215-6.218	74.8-75.2	1660-1710	10.6-12.7
6.26775-6.26825	108-121.94	1718.8-1722.2	13.25-13.4
6.31175-6.31225	123-138	2200-2300	14.47-14.5
8.291-8.294	149.9-150.05	2310-2390	15.35-16.2
8.362-8.366	156.52475-156.52525	2483.5-2500	17.7-21.4
8.37625-8.38675	156.7-156.9	2690-2900	22.01-23.12
8.41425-8.41475	162.0125-167.17	3260-3267	23.6-24.0
12.29-12.293	167.72-173.2	3332-3339	31.2-31.8
12.51975-12.52025	240-285	3345.8-3358	36.43-36.5
12.57675-12.57725	322-335.4	3600-4400	(2)
13.36-13.41			

1Until February 1, 1999, this restricted band shall be 0.490-0.510 MHz

2Above 38.6

## RSS-Gen section 8.10 Restricted frequency bands\*

MHz	MHz	MHz	GHz
0.090-0.110	12.51975-12.52025	240-285	3.5-4.4
0.495-0.505	12.57675-12.57725	322-335.4	4.5-5.15
2.1735-2.1905	13.36-13.41	399.9-410	5.35-5.46
3.020-3.026	16.42-16.423	608-614	7.25-7.75
4.125-4.128	16.69475-16.69525	960-1427	8.025-8.5
4.1772&4.17775	16.80425-16.80475	1435-1626.5	9.0-9.2
4.2072&4.20775	25.5-25.67	1645.5-1646.5	9.3-9.5
5.677-5.683	37.5-38.25	1660-1710	10.6-12.7
6.215-6.218	73-74.6	1718.8-1722.2	13.25-13.4
6.26775-6.26825	74.8-75.2	2200-2300	14.47-14.5
6.31175-6.31225	108-138	2310-2390	15.35-16.2
8.291-8.294	149.9-150.05	2483.5-2500	17.7-21.4
8.362-8.366	156.52475-156.52525	2655-2900	22.01-23.12
8.37625-8.38675	156.7-156.9	3260-3267	23.6-24.0
8.41425-8.41475	162.0125-167.17	3332-3339	31.2-31.8
12.29-12.293	167.72-173.2	3345.8-3358	36.43-36.5
			Above 38.6

\* Certain frequency bands listed in table and in bands above 38.6 GHz are designated for licence-exempt applications. These frequency bands and the requirements that apply to related devices are set out in the 200 and 300 series of RSSs.

## (2) FCC 15.209 Limit &amp; RSS-Gen section 8.9 Limit

FREQUENCY MHz	DISTANCE Meters	FIELD STRENGTHS LIMIT	
		mV/m	dB(mV)/m
0.009 ~ 0.490	300	2400/F(kHz)	67.6-20log(F)
0.490 ~ 1.705	30	24000/F(kHz)	87.6-20log(F)
1.705 ~ 30.0	30	30	29.54
30 ~ 88	3	100	40.0
88 ~ 216	3	150	43.5
216 ~ 960	3	200	46.0
960 ~ 1000	3	500	54.0
Above	1000	74.0 dB(mV)/m (Peak) 54.0 dB(mV)/m (Average)	

## Note:

(1) The emission limits shown in the above table are based on measurements employing a CISPR QP detector except for the frequency bands 9 - 90 kHz, 110 - 490 kHz and above 1000 MHz, radiated emissions limits in these three bands are based on measurements employing an average detector.

(2) At frequencies below 30 MHz, measurement may be performed at a distance closer than that specified, and the limit at closer measurement distance can be extrapolated by below formula:

$$\text{Limit}_{3\text{m}}(\text{dBuV/m}) = \text{Limit}_{30\text{m}}(\text{dBuV/m}) + 40\text{Log}(30\text{m}/3\text{m})$$

(3) Limit for this EUT

The emissions appearing within 15.205 restricted frequency bands shall not exceed the limits shown in 15.209, and the emissions appearing within RSS-Gen section 8.10 Restricted frequency bands shall not exceed the limits shown in RSS-Gen section 8.9, all the other emissions shall be at least 20 dB below the fundamental emissions or comply with 15.209 limits and RSS-Gen section 8.9 limits.

#### 12.4. Assistant equipment used for test

Assistant equipment	Manufacturer	Model number	Description	other
/	/	/	/	/

#### 12.5. Test procedure

(1) EUT was placed on a non-metallic table, 80 cm above the ground plane inside a semi-anechoic chamber for below 1G and 150 cm above the ground plane inside a fully-anechoic chamber for above 1G.

(2) Test antenna was located 3 m from the EUT on an adjustable mast, and the antenna used as below table.

Test frequency range	Test antenna used	Test antenna distance
9 kHz - 30 MHz	Active Loop antenna	3 m
30 MHz - 1 GHz	Trilog Broadband Antenna	3 m
1 GHz - 18 GHz	Double Ridged Horn Antenna(1 GHz-18 GHz)	3 m
18 GHz - 40 GHz	Horn Antenna(18 GHz-40 GHz)	1 m

According ANSI C63.10:2013 clause 6.4.6 and 6.5.3, for measurements below 30 MHz, Antenna was located 3 m from EUT, the loop antenna was positioned in three antenna orientations (parallel, perpendicular, and round-parallel), for each measurement antenna alignment, the EUT shall be rotated through 0° to 360° on a turntable, and the lowest height of the magnetic antenna shall be 1 m above the ground. For measurement above 30MHz, the trilog Broadband Antenna or Horn Antenna was located 3m from EUT, Measurements were made with the antenna positioned in both the horizontal and vertical planes of Polarization, and the measurement antenna was varied from 1 m to 4 m. in height above the reference ground plane to obtain the maximum signal strength.

(3) Below pre-scan procedure was first performed in order to find prominent frequency spectrum radiated emissions from 9 kHz to 25 GHz:

(a) Scanning the peak frequency spectrum with the antenna specified in step (3), and the EUT was rotated 360 degree, the antenna height was varied from 1 m to 4 m (Except loop antenna, it's fixed 1 m above ground.)

(b) Change work frequency or channel of device if practicable.

(c) Change modulation type of device if practicable.

(d) Change power supply range from 85% to 115% of the rated supply voltage

(e) Rotated EUT through three orthogonal axes to determine the attitude of EUT arrangement produces highest emissions.

Spectrum frequency from 9 kHz to 25 GHz (tenth harmonic of fundamental frequency) was investigated, and no any obvious emission were detected from 18 GHz to 25 GHz, so below final test was performed with frequency range from 9 kHz to 18 GHz.

(4) For final emissions measurements at each frequency of interest, the EUT was rotated and the antenna height was varied between 1 m and 4 m in order to maximize the emission. Measurements in both horizontal and vertical polarities were made and the data was recorded. In order to find the maximum emission, the relative positions of equipment and all of the interface cables were changed according to ANSI C63.10:2013 on Radiated Emission test.

(5) The emissions from 9 kHz to 1 GHz were measured based on CISPR QP detector except for the frequency bands 9 - 90 kHz, 110 - 490 kHz, for emissions from 9 kHz - 90 kHz, 110 kHz - 490 kHz and above 1 GHz were measured based on average detector, for emissions above 1 GHz, peak emissions also be measured and need comply with Peak limit.

(6) The emissions from 9 kHz to 1 GHz, QP or average values were measured with EMI receiver with below RBW.

Frequency band	RBW
9 kHz - 150 kHz	200 Hz
150 kHz - 30 MHz	9 kHz
30 MHz - 1 GHz	120 kHz

(7) For emissions above 1GHz, both Peak and Average level were measured with Spectrum Analyzer, and the RBW is set at 1 MHz, VBW is set at 3 MHz for Peak measure; According ANSI C63.10:2013 clause 4.1.4.2.2 procedure for average measure.

(8) For portable device, X axis, Y axis, Z axis are tested, and worse setup is reported.

(9) According exploratory test, the emission levels are 20 dB below the limit detected from 9 kHz to 30 MHz and 18 GHz to 25 GHz, so the final test was performed with frequency range from 30 MHz to 18 GHz and recorded in below.

(10) 30 MHz ~ 25 GHz: (Scan with all mode, the worst case is record and report)

(11) For emissions below 1 GHz, according exploratory explorer test, when change Tx mode and channel, have no distinct influence on emissions level, so for emissions below 1 GHz, the final test was only performed with the worst mode.

(12) The worst simultaneous case and was recorded.

## 12.6. Test result

**PASS. (See below detailed test result)**

12.7. Test data

## TR-4-E-009 Radiated Emission Test Result

**Test Date:** 2024-01-27 **Tested By:** Bairong  
**EUT:** Wireless Speaker **Model Number:** BOOMBOX 3 Wi-Fi  
**Test Mode:** 2.4G WIFI TX **Power Supply:** AC 120V/60Hz  
**Condition:** Temp:21.5°C;Humi:39.7% **Test Site:** DDT 3# Chamber  
**File Path:** d:\ts\2024 report data\Q23111312-2E BOOMBOX 3 Wi-Fi\FCC BELOW 1G\20240127-013919\_H  
**Memo:** Sample Number:S23111312-02 Power Setting:NA

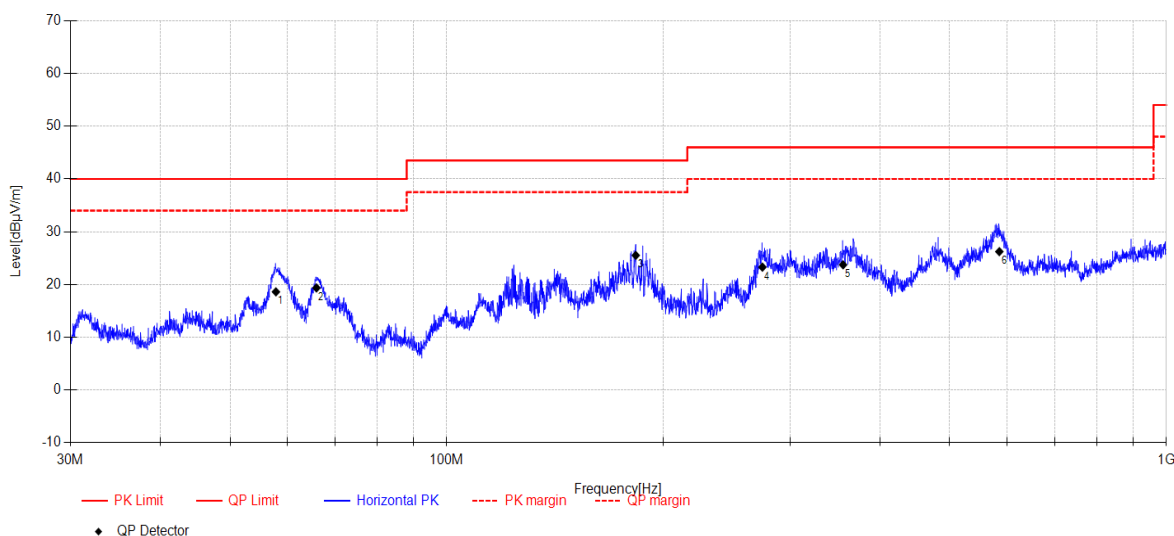

Data List										
NO.	Freq. [MHz]	Reading [dBµV/m]	Antenna Factor [dB]	Cable Loss [dB]	AMP [dB]	Result [dBµV/m]	Limit [dBµV/m]	Margin [dB]	Detector	Polarity
1	57.91	31.77	12.74	4.75	-30.65	18.61	40.00	21.39	QP	Horizontal
2	65.93	33.71	11.45	4.78	-30.59	19.35	40.00	20.65	QP	Horizontal
3	183.13	40.81	9.77	5.59	-30.65	25.52	43.50	17.98	QP	Horizontal
4	274.65	35.13	12.50	6.04	-30.38	23.29	46.00	22.71	QP	Horizontal
5	355.50	32.02	15.44	6.46	-30.19	23.73	46.00	22.27	QP	Horizontal
6	586.08	30.52	18.34	7.27	-29.90	26.23	46.00	19.77	QP	Horizontal

Note:

1. Result Level = Reading + Cable loss + Antenna Factor + AMP
2. If Peak Result complies with QP limit, QP Result is deemed to comply with QP limit.
3. Test setup: RBW: 120 kHz, VBW: 300 kHz, Sweep time: auto.

# TR-4-E-009 Radiated Emission Test Result

**Test Date:** 2024-01-27 **Tested By:** Bairong  
**EUT:** Wireless Speaker **Model Number:** BOOMBOX 3 Wi-Fi  
**Test Mode:** 2.4G WIFI TX **Power Supply:** AC 120V/60Hz  
**Condition:** Temp:21.5°C;Humi:39.7% **Test Site:** DDT 3# Chamber  
**File Path:** d:\ts\2024 report data\Q23111312-2E BOOMBOX 3 Wi-Fi\FCC BELOW 1G\20240127-014000\_V  
**Memo:** Sample Number:S23111312-02 Power Setting:NA

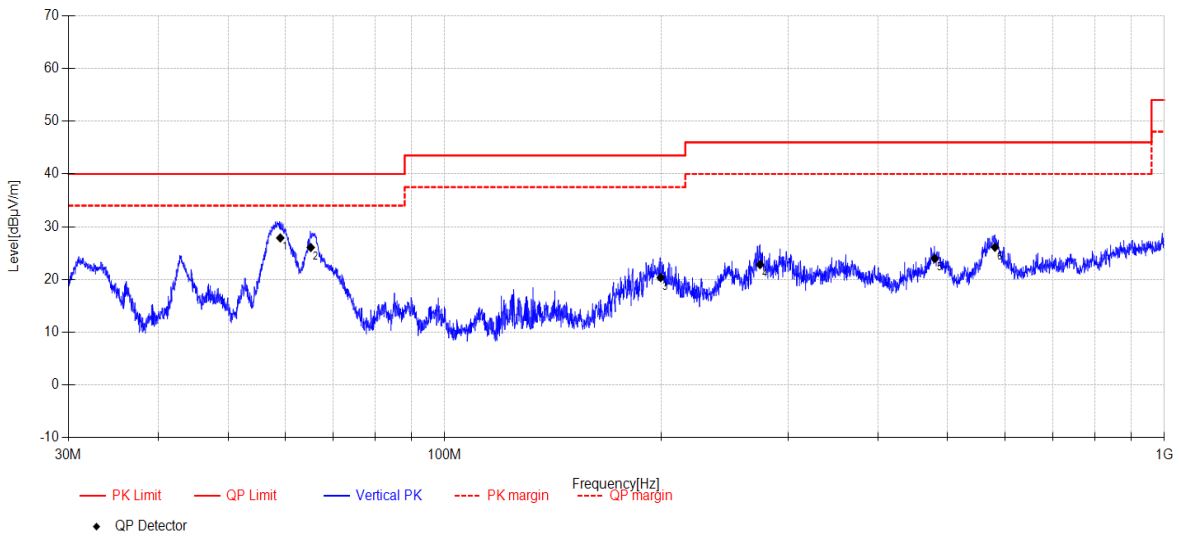

Data List										
NO.	Freq. [MHz]	Reading [dBµV/m]	Antenna Factor [dB]	Cable Loss [dB]	AMP [dB]	Result [dBµV/m]	Limit [dBµV/m]	Margin [dB]	Detector	Polarity
1	59.10	41.4	12.35	4.76	-30.64	27.87	40.00	12.13	QP	Vertical
2	65.15	39.81	12.08	4.78	-30.60	26.07	40.00	13.93	QP	Vertical
3	199.63	34.62	10.61	5.73	-30.60	20.36	43.50	23.14	QP	Vertical
4	274.26	34.67	12.50	6.04	-30.38	22.83	46.00	23.17	QP	Vertical
5	479.59	30.56	16.48	6.88	-29.94	23.98	46.00	22.02	QP	Vertical
6	581.58	29.97	18.78	7.26	-29.90	26.11	46.00	19.89	QP	Vertical

**Note:**

1. Result Level = Reading + Cable loss + Antenna Factor + AMP
2. If Peak Result complies with QP limit, QP Result is deemed to comply with QP limit.
3. Test setup: RBW: 120 kHz, VBW: 300 kHz, Sweep time: auto.

# TR-4-E-009 Radiated Emission Test Result

**Test Date:** 2024-02-01      **Tested By:** Bairong  
**EUT:** Wireless Speaker      **Model Number:** BOOMBOX 3 Wi-Fi  
**Test Mode:** 11AX20MIMO 2412MHz TX      **Power Supply:** AC 120V/60Hz  
**Condition:** Temp:21.5°C;Humi:39.7%      **Test Site:** DDT 3# Chamber  
**File Path:** d:\ts\2024 report data\Q23111312-2E BOOMBOX 3 Wi-Fi\FCC ABOVE 1G 2.4GWIFI\1  
**Memo:** Sample Number:S23111312-02 Power Setting:NA

## Test Graph

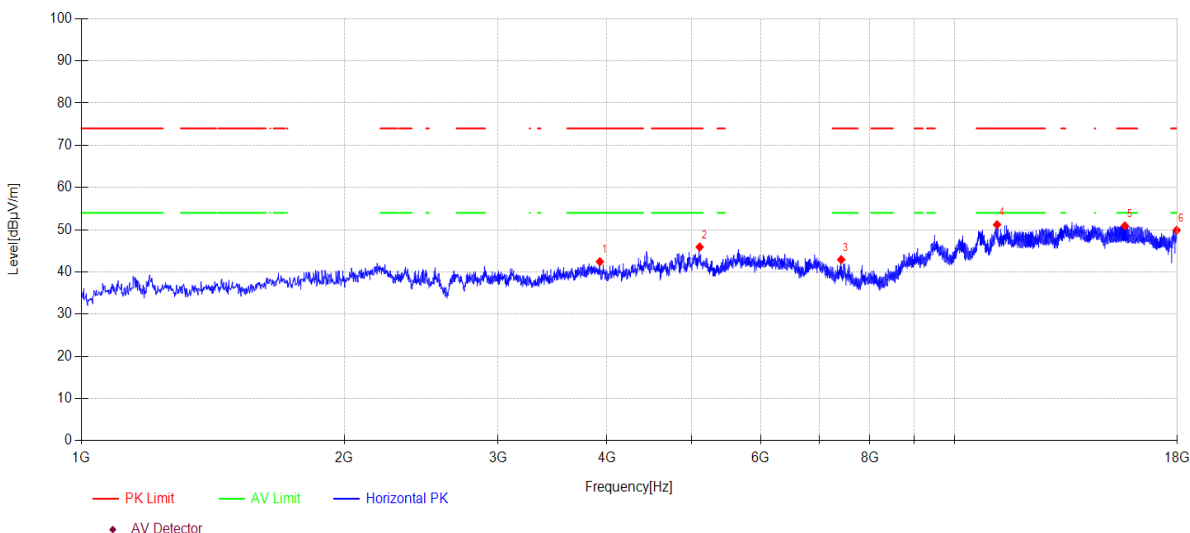

Data List										
N O.	Freq. [MHz]	Reading [dBµV/m]	Antenna Factor [dB]	Cable loss [dB]	AMP [dB]	Level [dBµV/m]	Limit [dBµV/m]	Margin [dB]	Detector	Polarity
1	3925.70	45.85	31.15	5.83	-40.40	42.43	74.00	31.57	PK	Horizontal
2	5107.20	44.55	33.40	8.02	-40.07	45.90	74.00	28.10	PK	Horizontal
3	7417.50	40.34	36.67	7.64	-41.74	42.91	74.00	31.09	PK	Horizontal
4	11188.10	41.35	39.21	9.82	-39.18	51.20	74.00	22.80	PK	Horizontal
5	15672.70	37.13	38.53	14.40	-39.16	50.90	74.00	23.10	PK	Horizontal
6	17969.40	36.87	42.25	13.09	-42.33	49.88	74.00	24.12	PK	Horizontal

**Note:**

1. Level = Reading + Cable loss + Antenna Factor + AMP
2. If Peak Result complies with AV limit, AV Result is deemed to comply with AV limit.
3. Test setup: RBW: 1 MHz, VBW: 3 MHz, Sweep time: auto.

# TR-4-E-009 Radiated Emission Test Result

**Test Date:** 2024-02-01      **Tested By:** Bairong  
**EUT:** Wireless Speaker      **Model Number:** BOOMBOX 3 Wi-Fi  
**Test Mode:** 11AX20MIMO 2412MHz TX      **Power Supply:** AC 120V/60Hz  
**Condition:** Temp:21.5°C;Humi:39.7%      **Test Site:** DDT 3# Chamber  
**File Path:** d:\ts\2024 report data\Q23111312-2E BOOMBOX 3 Wi-Fi\FCC ABOVE 1G 2.4GWIFI\2  
**Memo:** Sample Number:S23111312-02 Power Setting:NA

## Test Graph

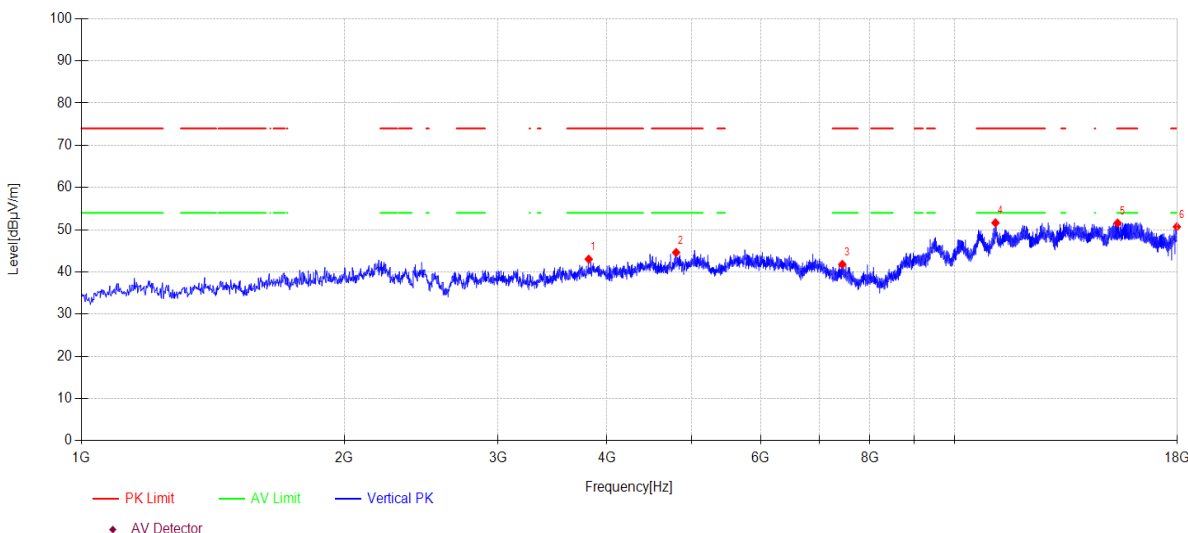

Data List										
N O.	Freq. [MHz]	Reading [dBµV/m]	Antenna Factor [dB]	Cable loss [dB]	AMP [dB]	Level [dBµV/m]	Limit [dBµV/m]	Margin [dB]	Detector	Polarity
1	3811.80	46.81	30.75	5.81	-40.34	43.03	74.00	30.97	PK	Vertical
2	4799.50	44.79	32.50	7.46	-40.15	44.60	74.00	29.40	PK	Vertical
3	7439.60	39.33	36.62	7.64	-41.80	41.79	74.00	32.21	PK	Vertical
4	11142.20	41.75	39.26	9.78	-39.16	51.63	74.00	22.37	PK	Vertical
5	15375.20	38.32	39.20	13.05	-38.99	51.58	74.00	22.42	PK	Vertical
6	17976.20	37.66	42.28	13.10	-42.35	50.69	74.00	23.31	PK	Vertical

**Note:**

1. Level = Reading + Cable loss + Antenna Factor + AMP
2. If Peak Result complies with AV limit, AV Result is deemed to comply with AV limit.
3. Test setup: RBW: 1 MHz, VBW: 3 MHz, Sweep time: auto.

## TR-4-E-009 Radiated Emission Test Result

**Test Date:** 2024-02-01 **Tested By:** Bairong  
**EUT:** Wireless Speaker **Model Number:** BOOMBOX 3 Wi-Fi  
**Test Mode:** 11AX20MIMO 2437MHz TX **Power Supply:** AC 120V/60Hz  
**Condition:** Temp:21.5°C;Humi:39.7% **Test Site:** DDT 3# Chamber  
**File Path:** d:\ts\2024 report data\Q23111312-2E BOOMBOX 3 Wi-Fi\FCC ABOVE 1G 2.4GWIFI\3  
**Memo:** Sample Number:S23111312-02 Power Setting:NA

### Test Graph

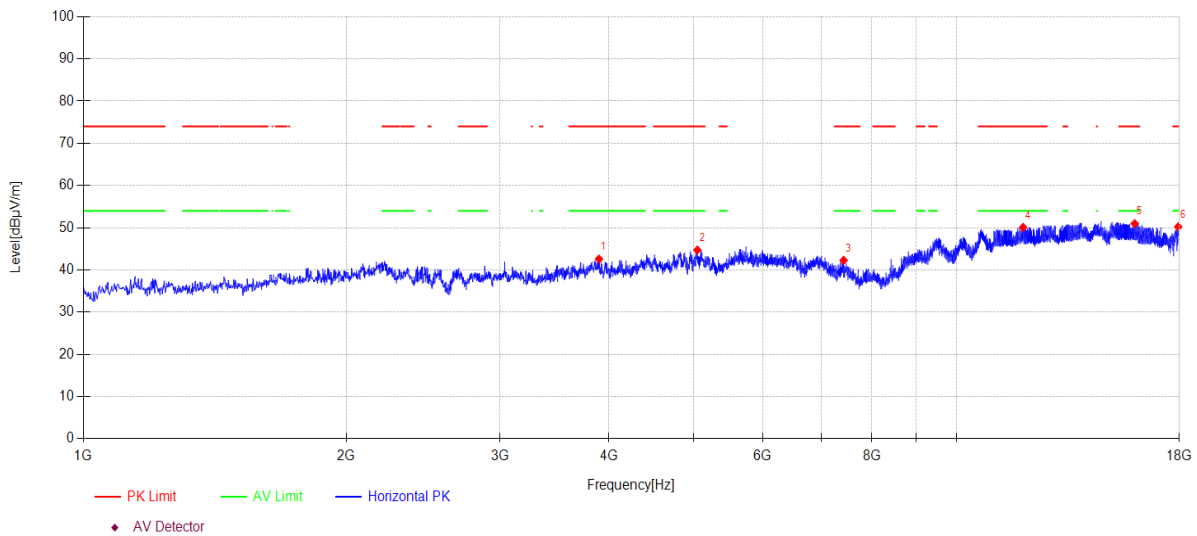

Data List										
N O.	Freq. [MHz]	Reading [dBµV/m]	Antenna Factor [dB]	Cable loss [dB]	AMP [dB]	Level [dBµV/m]	Limit [dBµV/m]	Margin [dB]	Detector	Polarity
1	3895.10	45.96	31.17	5.83	-40.39	42.57	74.00	31.43	PK	Horizontal
2	5049.40	43.54	33.30	7.94	-40.07	44.71	74.00	29.29	PK	Horizontal
3	7426.00	39.75	36.65	7.64	-41.77	42.27	74.00	31.73	PK	Horizontal
4	11920.80	40.18	38.96	10.47	-39.52	50.09	74.00	23.91	PK	Horizontal
5	15999.10	36.47	38.00	15.88	-39.36	50.99	74.00	23.01	PK	Horizontal
6	17945.60	37.32	42.13	13.06	-42.28	50.23	74.00	23.77	PK	Horizontal

#### Note:

- Level = Reading + Cable loss + Antenna Factor + AMP
- If Peak Result complies with AV limit, AV Result is deemed to comply with AV limit.
- Test setup: RBW: 1 MHz, VBW: 3 MHz, Sweep time: auto.

# TR-4-E-009 Radiated Emission Test Result

**Test Date:** 2024-02-01      **Tested By:** Bairong  
**EUT:** Wireless Speaker      **Model Number:** BOOMBOX 3 Wi-Fi  
**Test Mode:** 11AX20MIMO 2437MHz TX      **Power Supply:** AC 120V/60Hz  
**Condition:** Temp:21.5°C;Humi:39.7%      **Test Site:** DDT 3# Chamber  
**File Path:** d:\ts\2024 report data\Q23111312-2E BOOMBOX 3 Wi-Fi\FCC ABOVE 1G 2.4GWIFI4  
**Memo:** Sample Number:S23111312-02 Power Setting:NA

## Test Graph

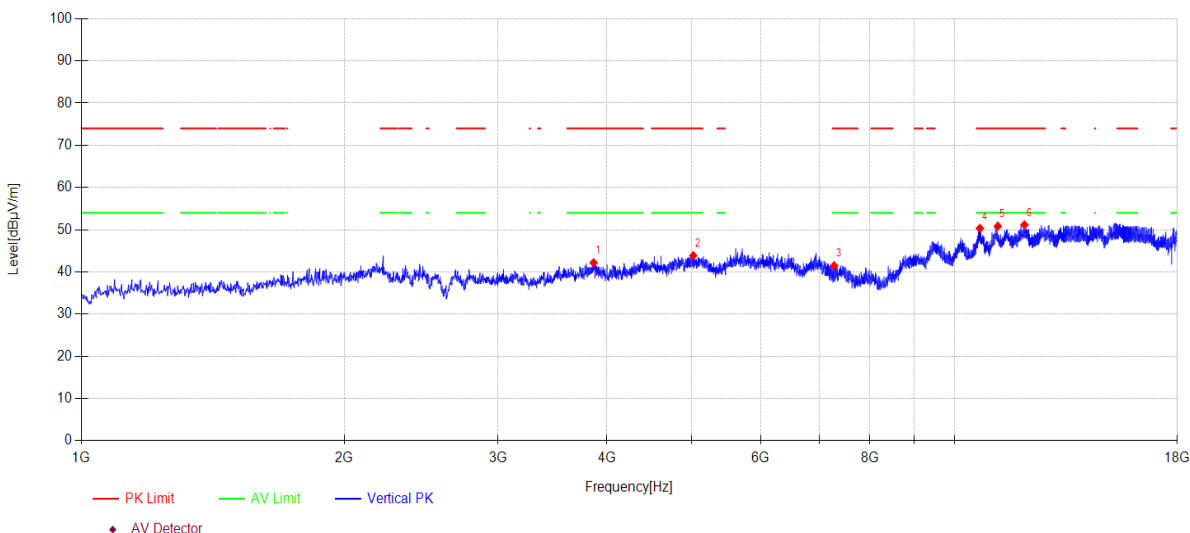

Data List										
N O.	Freq. [MHz]	Reading [dBµV/m]	Antenna Factor [dB]	Cable loss [dB]	AMP [dB]	Level [dBµV/m]	Limit [dBµV/m]	Margin [dB]	Detector	Polarity
1	3861.10	45.77	30.97	5.82	-40.37	42.19	74.00	31.81	PK	Vertical
2	5022.20	42.82	33.24	7.90	-40.08	43.88	74.00	30.12	PK	Vertical
3	7281.50	38.39	36.86	7.63	-41.40	41.48	74.00	32.52	PK	Vertical
4	10693.40	40.47	39.39	9.43	-38.98	50.31	74.00	23.69	PK	Vertical
5	11211.90	40.99	39.20	9.84	-39.19	50.84	74.00	23.16	PK	Vertical
6	12027.90	40.97	39.23	10.54	-39.57	51.17	74.00	22.83	PK	Vertical

**Note:**

1. Level = Reading + Cable loss + Antenna Factor + AMP
2. If Peak Result complies with AV limit, AV Result is deemed to comply with AV limit.
3. Test setup: RBW: 1 MHz, VBW: 3 MHz, Sweep time: auto.

# TR-4-E-009 Radiated Emission Test Result

**Test Date:** 2024-02-01      **Tested By:** Bairong  
**EUT:** Wireless Speaker      **Model Number:** BOOMBOX 3 Wi-Fi  
**Test Mode:** 11AX20MIMO 2462MHz TX      **Power Supply:** AC 120V/60Hz  
**Condition:** Temp:21.5°C;Humi:39.7%      **Test Site:** DDT 3# Chamber  
**File Path:** d:\ts\2024 report data\Q23111312-2E BOOMBOX 3 Wi-Fi\FCC ABOVE 1G 2.4GWIFI\5  
**Memo:** Sample Number:S23111312-02 Power Setting:NA

## Test Graph

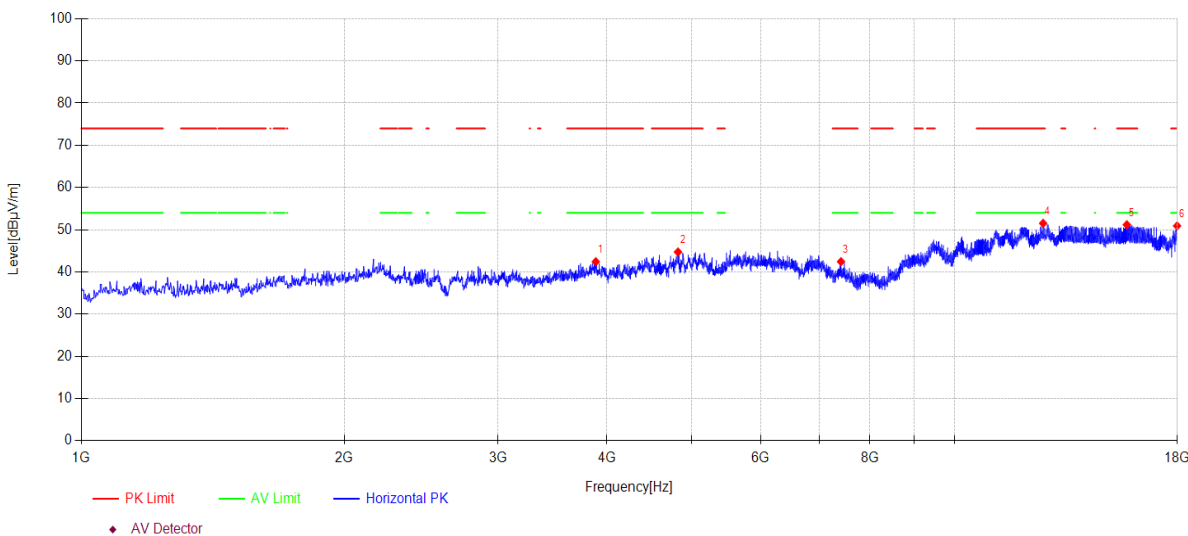

Data List										
N O.	Freq. [MHz]	Reading [dBµV/m]	Antenna Factor [dB]	Cable loss [dB]	AMP [dB]	Level [dBµV/m]	Limit [dBµV/m]	Margin [dB]	Detector	Polarity
1	3883.20	45.88	31.10	5.82	-40.38	42.42	74.00	31.58	PK	Horizontal
2	4823.30	44.25	33.11	7.51	-40.15	44.72	74.00	29.28	PK	Horizontal
3	7414.10	39.87	36.67	7.64	-41.74	42.44	74.00	31.56	PK	Horizontal
4	12634.80	41.32	39.47	10.54	-39.81	51.52	74.00	22.48	PK	Horizontal
5	15756.00	37.23	38.39	14.77	-39.21	51.18	74.00	22.82	PK	Horizontal
6	17988.10	37.82	42.34	13.12	-42.37	50.91	74.00	23.09	PK	Horizontal

**Note:**

1. Level = Reading + Cable loss + Antenna Factor + AMP
2. If Peak Result complies with AV limit, AV Result is deemed to comply with AV limit.
3. Test setup: RBW: 1 MHz, VBW: 3 MHz, Sweep time: auto.

# TR-4-E-009 Radiated Emission Test Result

**Test Date:** 2024-02-01      **Tested By:** Bairong  
**EUT:** Wireless Speaker      **Model Number:** BOOMBOX 3 Wi-Fi  
**Test Mode:** 11AX20MIMO 2462MHz TX      **Power Supply:** AC 120V/60Hz  
**Condition:** Temp:21.5°C;Humi:39.7%      **Test Site:** DDT 3# Chamber  
**File Path:** d:\ts\2024 report data\Q23111312-2E BOOMBOX 3 Wi-Fi\FCC ABOVE 1G 2.4GWIFI\6  
**Memo:** Sample Number:S23111312-02 Power Setting:NA

## Test Graph

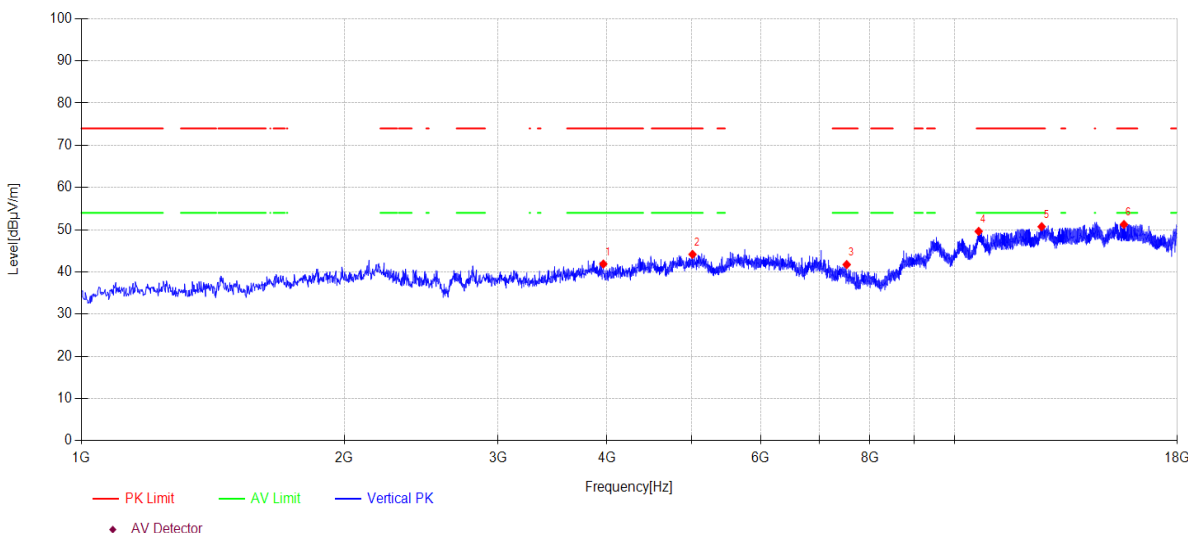

Data List										
N O.	Freq. [MHz]	Reading [dBµV/m]	Antenna Factor [dB]	Cable loss [dB]	AMP [dB]	Level [dBµV/m]	Limit [dBµV/m]	Margin [dB]	Detector	Polarity
1	3961.40	45.42	31.05	5.84	-40.43	41.88	74.00	32.12	PK	Vertical
2	5012.00	43.13	33.22	7.89	-40.08	44.16	74.00	29.84	PK	Vertical
3	7526.30	39.66	36.45	7.65	-42.02	41.74	74.00	32.26	PK	Vertical
4	10659.40	39.84	39.32	9.41	-38.96	49.61	74.00	24.39	PK	Vertical
5	12585.50	40.57	39.40	10.54	-39.79	50.72	74.00	23.28	PK	Vertical
6	15637.00	37.58	38.56	14.24	-39.14	51.24	74.00	22.76	PK	Vertical

**Note:**

1. Level = Reading + Cable loss + Antenna Factor + AMP
2. If Peak Result complies with AV limit, AV Result is deemed to comply with AV limit.
3. Test setup: RBW: 1 MHz, VBW: 3 MHz, Sweep time: auto.

## 13. Band Edge Compliance

### 13.1. Test equipment

Equipment	Manufacturer	Model No.	Serial No.	Cal Due To
Micro-Tronics filters	REBES	BRM50702	DDT-ZC03242	/
PSA Series Spectrum Analyzer	Agilent	E4447A	DDT-ZC00517	2024/04/23
High Pass filter	西安星博	XBLBQ-GTA67	DDT-ZC02179	2024/05/14
Broad-Band Horn Antenna	Schwarzbeck	BBHA 9170	DDT-ZC00506	2024/04/26
Pre-amplifier	COM-POWER	PAM-118A	DDT-ZC01293	2024/07/14
RF cable	Yuhu Technology	ZT26S-SMAJ-SMAJ-1M	DDT-ZC02037	2024/04/23
Active Loop Antenna	Schwarzbeck	FMZB1519	DDT-ZC00524	2024/09/10
RF cable	Yuhu Technology	JCTB810-NJ-NJ-9M	DDT-ZC02538	2024/04/23
High pass filter	Micro-Tronics	HPM50102	DDT-ZC00561	2024/05/14
RF cable	Zhongke Junchuang	JCT26S-NJ-NJ-1.5M	DDT-ZC02762	2024/04/20
RF Cable	N/A	W13.02 AP1-X2	DDT-ZC04023	2024/04/21
EMI TEST RECEIVER	R&S	ESU26	DDT-ZC01909	2024/04/23
Pre-amplifier	COM-POWER	PAM-840A	DDT-ZC01693	2024/04/27
Trilog Broadband Antenna	Schwarzbeck	VULB 9163	DDT-ZC02050	2024/07/11
Micro-Tronics filters	REBES	BRM50716	DDT-ZC03240	/
RF Cable	N/A	W24.02 HL-562	DDT-ZC04022	2024/04/21
High pass filter	Micro-Tronics	HPM50108	DDT-ZC00560	2024/05/14
Hochgewinn-Hornantenne	Schwarzbeck Mess-Elektronik	BBHA 9120 D	DDT-ZC02129	2024/09/17

**13.2. Block diagram of test setup**

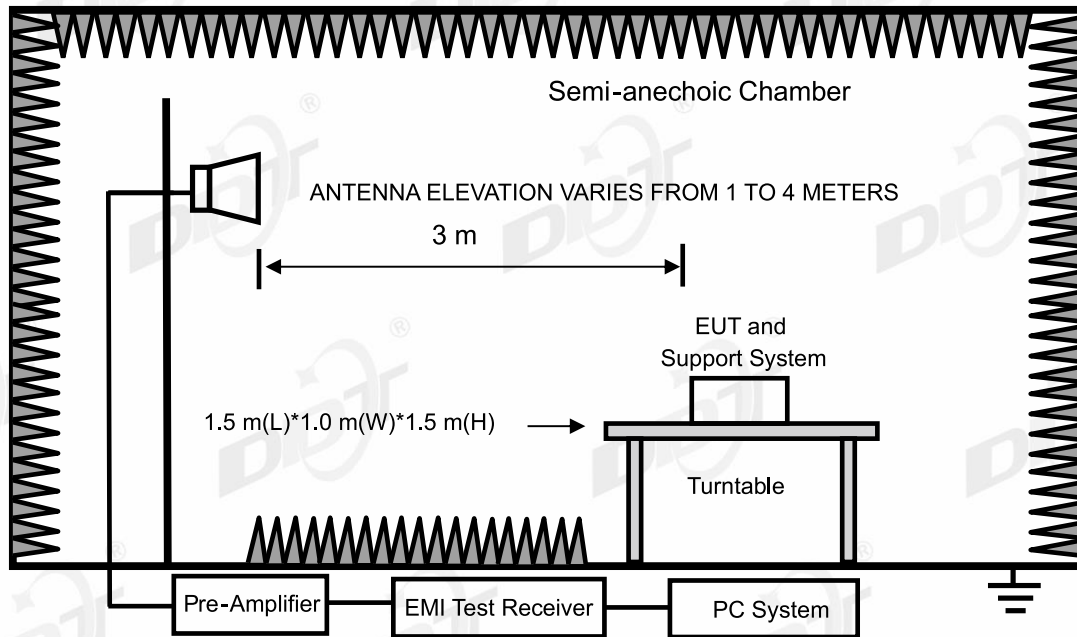

**13.3. Limits**

All restriction band should comply with 15.209 and RSS-Gen section 8.9 limits, other emission should be at least 20 dB below the fundamental.

**13.4. Assistant equipment used for test**

Assistant equipment	Manufacturer	Model number	Description	other
/	/	/	/	/

**13.5. Test procedure**

Same with Radiated Emission except change investigated frequency range.

Remark: All restriction band have been tested, and only the worst case is shown in report.

**13.6. Test result**

**PASS. (See below detailed test result)**



# TR-4-E-009 Radiated Emission Test Result

**Test Date:** 2024-02-01      **Tested By:** Bairong  
**EUT:** Wireless Speaker      **Model Number:** BOOMBOX 3 Wi-Fi  
**Test Mode:** 11B ANT1 2412MHz TX      **Power Supply:** AC 120V/60Hz  
**Condition:** Temp:21.5°C;Humi:39.7%      **Test Site:** DDT 3# Chamber  
**File Path:** d:\ts\2024 report data\Q23111312-2E BOOMBOX 3 Wi-Fi\FCC ABOVE 1G 2.4GWIFI\8  
**Memo:** Sample Number:S23111312-02 Power Setting:14

## Test Graph

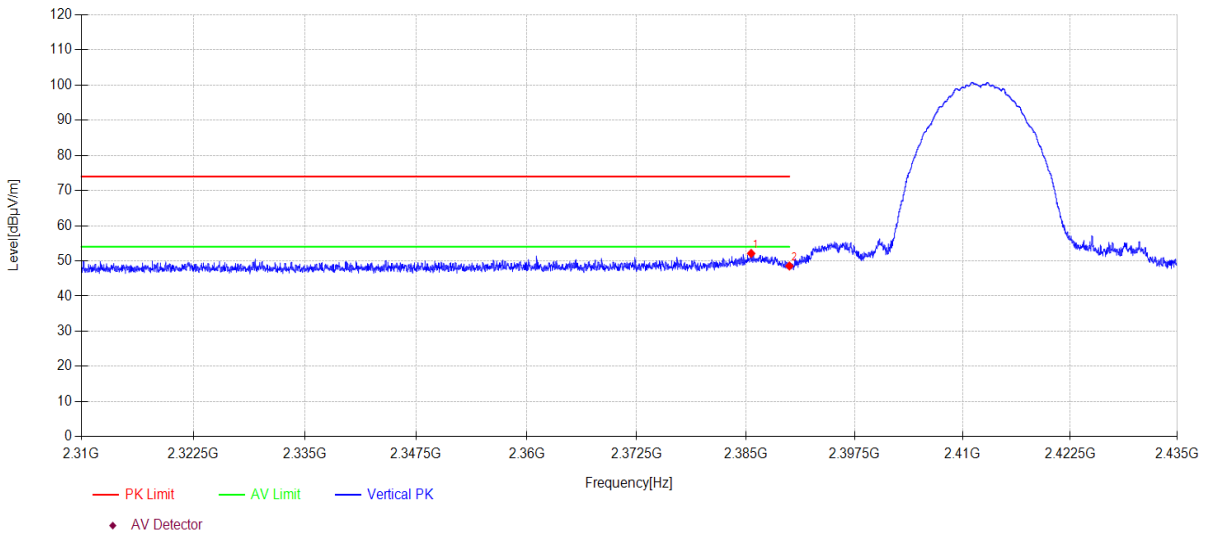

Data List										
N O.	Freq. [MHz]	Reading [dBµV/m]	Antenna Factor [dB]	Cable loss [dB]	AMP [dB]	Level [dBµV/m]	Limit [dBµV/m]	Margin [dB]	Detector	Polarity
1	2385.61	21.03	27.24	3.86	0.00	52.13	74.00	21.87	PK	Vertical
2	2390.00	17.42	27.26	3.87	0.00	48.55	74.00	25.45	PK	Vertical

**Note:**

1. Level = Reading + Cable loss + Antenna Factor + AMP
2. If Peak Result complies with AV limit, AV Result is deemed to comply with AV limit.
3. Test setup: RBW: 1 MHz, VBW: 3 MHz, Sweep time: auto.

# TR-4-E-009 Radiated Emission Test Result

**Test Date:** 2024-02-01      **Tested By:** Bairong  
**EUT:** Wireless Speaker      **Model Number:** BOOMBOX 3 Wi-Fi  
**Test Mode:** 11B ANT2 2412MHz TX      **Power Supply:** AC 120V/60Hz  
**Condition:** Temp:21.5°C;Humi:39.7%      **Test Site:** DDT 3# Chamber  
**File Path:** d:\ts\2024 report data\Q23111312-2E BOOMBOX 3 Wi-Fi\FCC ABOVE 1G 2.4GWIFI\9  
**Memo:** Sample Number:S23111312-02 Power Setting:14

## Test Graph

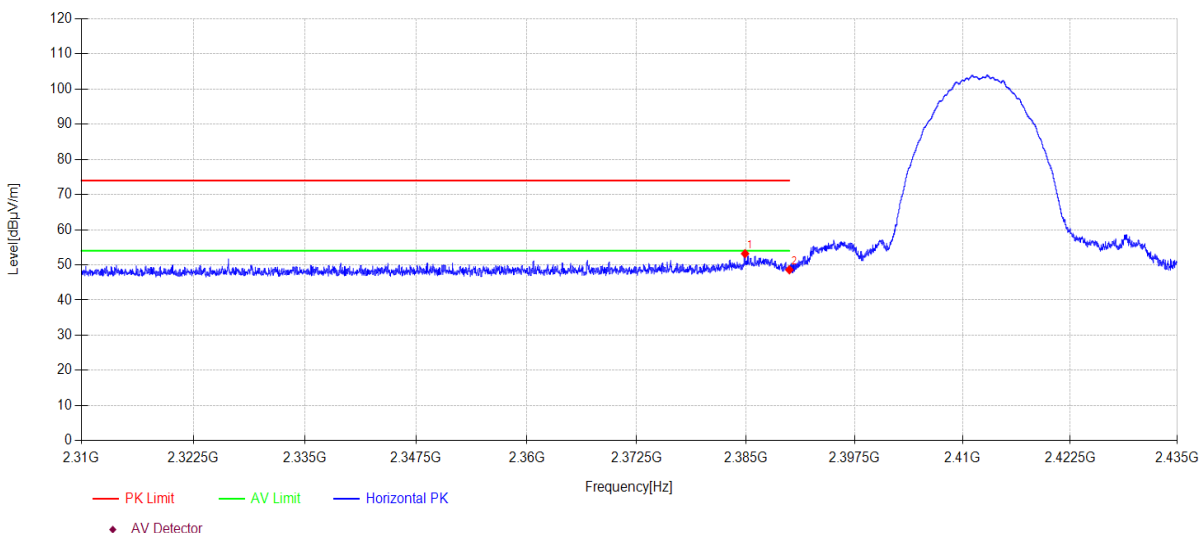

Data List										
N O.	Freq. [MHz]	Reading [dBµV/m]	Antenna Factor [dB]	Cable loss [dB]	AMP [dB]	Level [dBµV/m]	Limit [dBµV/m]	Margin [dB]	Detector	Polarity
1	2384.91	22.10	27.24	3.86	0.00	53.20	74.00	20.80	PK	Horizontal
2	2390.00	17.47	27.26	3.87	0.00	48.60	74.00	25.40	PK	Horizontal

**Note:**

1. Level = Reading + Cable loss + Antenna Factor + AMP
2. If Peak Result complies with AV limit, AV Result is deemed to comply with AV limit.
3. Test setup: RBW: 1 MHz, VBW: 3 MHz, Sweep time: auto.

# TR-4-E-009 Radiated Emission Test Result

**Test Date:** 2024-02-01      **Tested By:** Bairong  
**EUT:** Wireless Speaker      **Model Number:** BOOMBOX 3 Wi-Fi  
**Test Mode:** 11B ANT2 2412MHz TX      **Power Supply:** AC 120V/60Hz  
**Condition:** Temp:21.5°C;Humi:39.7%      **Test Site:** DDT 3# Chamber  
**File Path:** d:\ts\2024 report data\Q23111312-2E BOOMBOX 3 Wi-Fi\FCC ABOVE 1G 2.4GWIFI\10  
**Memo:** Sample Number:S23111312-02 Power Setting:14

## Test Graph

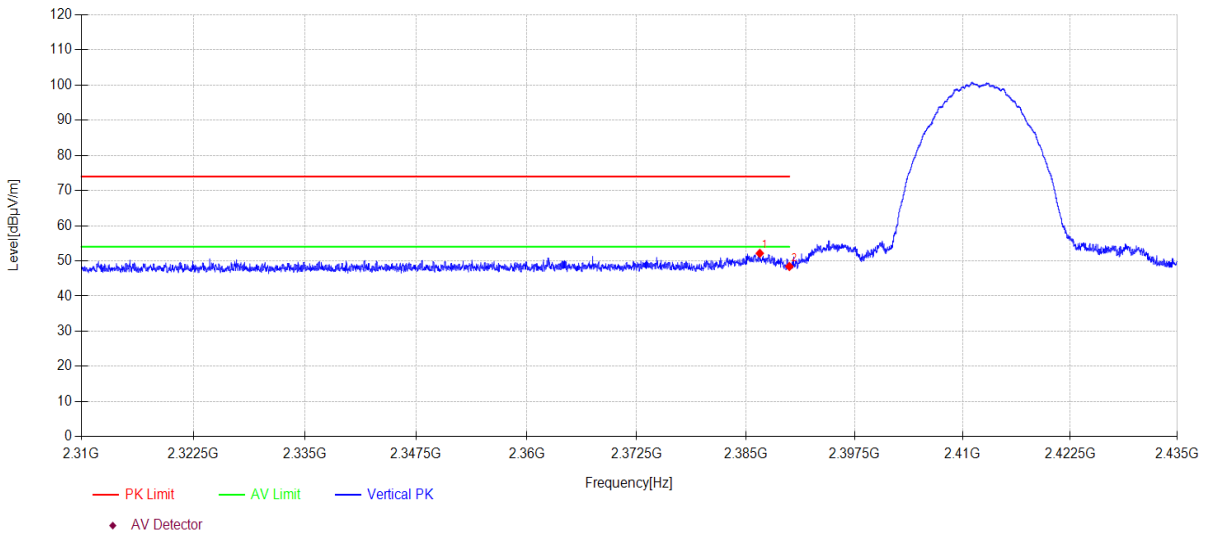

Data List										
N O.	Freq. [MHz]	Reading [dBµV/m]	Antenna Factor [dB]	Cable loss [dB]	AMP [dB]	Level [dBµV/m]	Limit [dBµV/m]	Margin [dB]	Detector	Polarity
1	2386.60	21.05	27.25	3.86	0.00	52.16	74.00	21.84	PK	Vertical
2	2390.00	17.29	27.26	3.87	0.00	48.42	74.00	25.58	PK	Vertical

**Note:**

1. Level = Reading + Cable loss + Antenna Factor + AMP
2. If Peak Result complies with AV limit, AV Result is deemed to comply with AV limit.
3. Test setup: RBW: 1 MHz, VBW: 3 MHz, Sweep time: auto.

# TR-4-E-009 Radiated Emission Test Result

**Test Date:** 2024-02-01      **Tested By:** Bairong  
**EUT:** Wireless Speaker      **Model Number:** BOOMBOX 3 Wi-Fi  
**Test Mode:** 11B ANT1 2462MHz TX      **Power Supply:** AC 120V/60Hz  
**Condition:** Temp:21.5°C;Humi:39.7%      **Test Site:** DDT 3# Chamber  
**File Path:** d:\ts\2024 report data\Q23111312-2E BOOMBOX 3 Wi-Fi\FCC ABOVE 1G 2.4GWIFI\11  
**Memo:** Sample Number:S23111312-02 Power Setting:14

## Test Graph

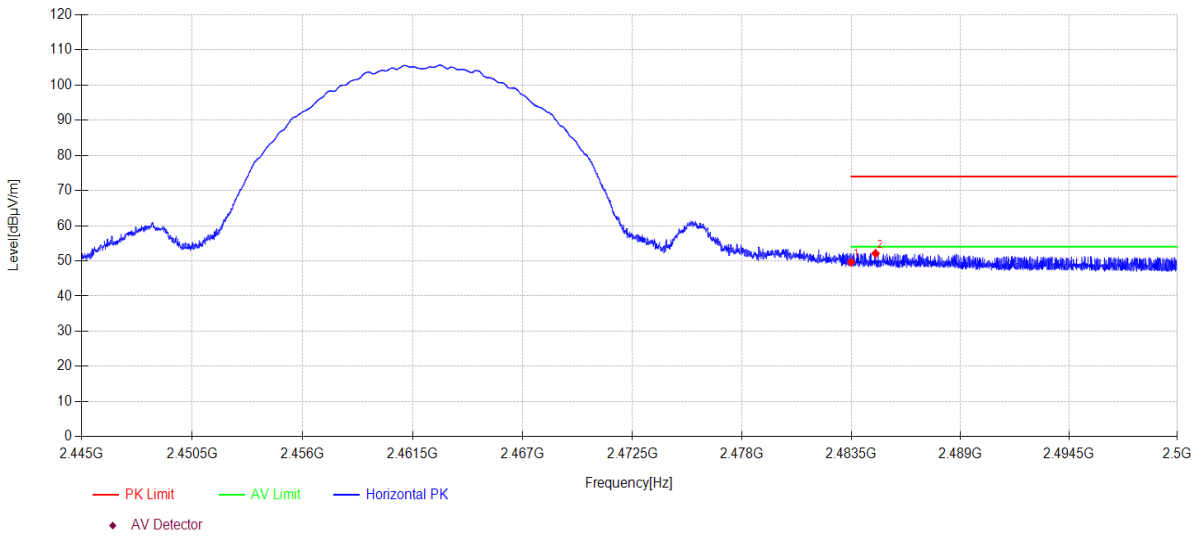

Data List										
N O.	Freq. [MHz]	Reading [dBµV/m]	Antenna Factor [dB]	Cable loss [dB]	AMP [dB]	Level [dBµV/m]	Limit [dBµV/m]	Margin [dB]	Detector	Polarity
1	2483.50	18.16	27.53	3.94	0.00	49.63	74.00	24.37	PK	Horizontal
2	2484.73	20.63	27.54	3.94	0.00	52.11	74.00	21.89	PK	Horizontal

**Note:**

1. Level = Reading + Cable loss + Antenna Factor + AMP
2. If Peak Result complies with AV limit, AV Result is deemed to comply with AV limit.
3. Test setup: RBW: 1 MHz, VBW: 3 MHz, Sweep time: auto.

# TR-4-E-009 Radiated Emission Test Result

**Test Date:** 2024-02-01      **Tested By:** Bairong  
**EUT:** Wireless Speaker      **Model Number:** BOOMBOX 3 Wi-Fi  
**Test Mode:** 11B ANT1 2462MHz TX      **Power Supply:** AC 120V/60Hz  
**Condition:** Temp:21.5°C;Humi:39.7%      **Test Site:** DDT 3# Chamber  
**File Path:** d:\ts\2024 report data\Q23111312-2E BOOMBOX 3 Wi-Fi\FCC ABOVE 1G 2.4GWIFI\12  
**Memo:** Sample Number:S23111312-02 Power Setting:14

## Test Graph

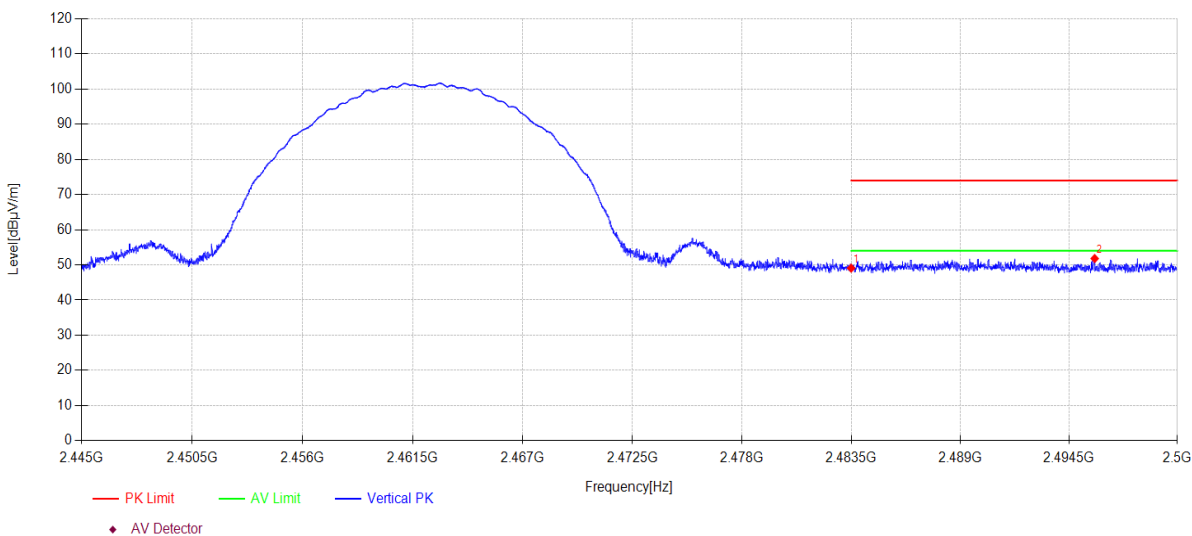

Data List										
N O.	Freq. [MHz]	Reading [dBµV/m]	Antenna Factor [dB]	Cable loss [dB]	AMP [dB]	Level [dBµV/m]	Limit [dBµV/m]	Margin [dB]	Detector	Polarity
1	2483.50	17.61	27.53	3.94	0.00	49.08	74.00	24.92	PK	Vertical
2	2495.81	20.28	27.58	3.95	0.00	51.81	74.00	22.19	PK	Vertical

**Note:**

1. Level = Reading + Cable loss + Antenna Factor + AMP
2. If Peak Result complies with AV limit, AV Result is deemed to comply with AV limit.
3. Test setup: RBW: 1 MHz, VBW: 3 MHz, Sweep time: auto.

# TR-4-E-009 Radiated Emission Test Result

**Test Date:** 2024-02-01      **Tested By:** Bairong  
**EUT:** Wireless Speaker      **Model Number:** BOOMBOX 3 Wi-Fi  
**Test Mode:** 11B ANT2 2462MHz TX      **Power Supply:** AC 120V/60Hz  
**Condition:** Temp:21.5°C;Humi:39.7%      **Test Site:** DDT 3# Chamber  
**File Path:** d:\ts\2024 report data\Q23111312-2E BOOMBOX 3 Wi-Fi\FCC ABOVE 1G 2.4GWIFI\13  
**Memo:** Sample Number:S23111312-02 Power Setting:14

## Test Graph

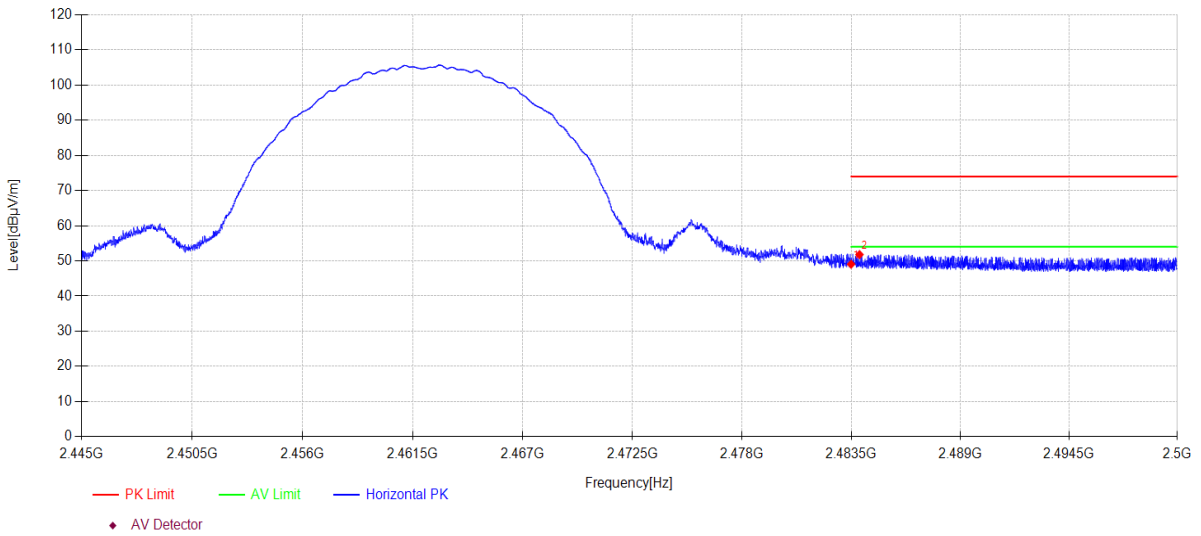

Data List										
N O.	Freq. [MHz]	Reading [dBµV/m]	Antenna Factor [dB]	Cable loss [dB]	AMP [dB]	Level [dBµV/m]	Limit [dBµV/m]	Margin [dB]	Detector	Polarity
1	2483.50	17.59	27.53	3.94	0.00	49.06	74.00	24.94	PK	Horizontal
2	2483.92	20.31	27.54	3.94	0.00	51.79	74.00	22.21	PK	Horizontal

**Note:**

1. Level = Reading + Cable loss + Antenna Factor + AMP
2. If Peak Result complies with AV limit, AV Result is deemed to comply with AV limit.
3. Test setup: RBW: 1 MHz, VBW: 3 MHz, Sweep time: auto.

# TR-4-E-009 Radiated Emission Test Result

**Test Date:** 2024-02-01      **Tested By:** Bairong  
**EUT:** Wireless Speaker      **Model Number:** BOOMBOX 3 Wi-Fi  
**Test Mode:** 11B ANT2 2462MHz TX      **Power Supply:** AC 120V/60Hz  
**Condition:** Temp:21.5°C;Humi:39.7%      **Test Site:** DDT 3# Chamber  
**File Path:** d:\ts\2024 report data\Q23111312-2E BOOMBOX 3 Wi-Fi\FCC ABOVE 1G 2.4GWIFI\14  
**Memo:** Sample Number:S23111312-02 Power Setting:14

## Test Graph

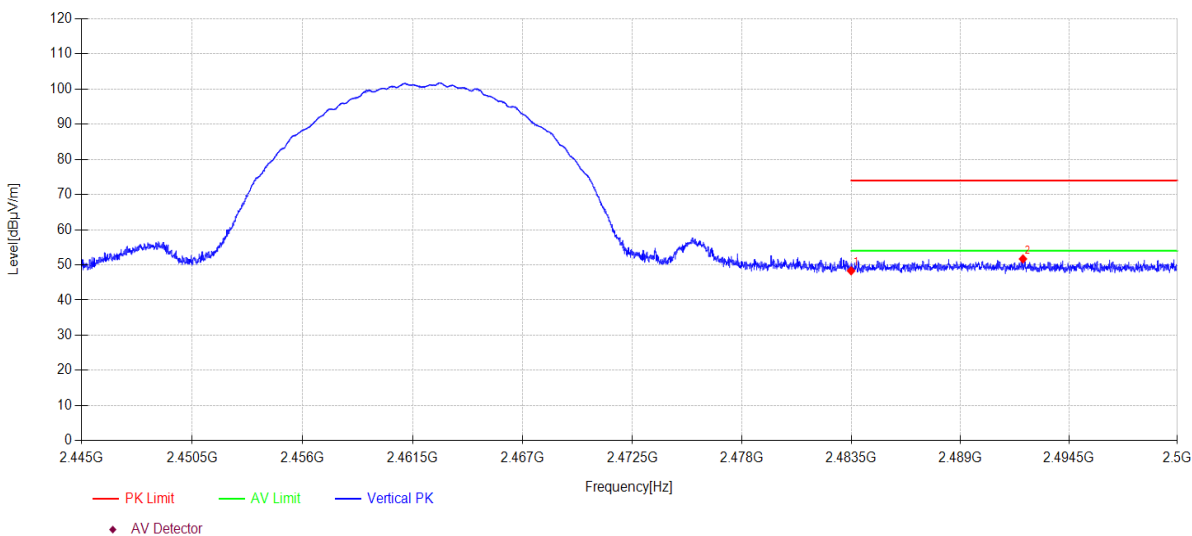

Data List										
N O.	Freq. [MHz]	Reading [dBµV/m]	Antenna Factor [dB]	Cable loss [dB]	AMP [dB]	Level [dBµV/m]	Limit [dBµV/m]	Margin [dB]	Detector	Polarity
1	2483.50	16.85	27.53	3.94	0.00	48.32	74.00	25.68	PK	Vertical
2	2492.18	20.19	27.57	3.94	0.00	51.70	74.00	22.30	PK	Vertical

**Note:**

1. Level = Reading + Cable loss + Antenna Factor + AMP
2. If Peak Result complies with AV limit, AV Result is deemed to comply with AV limit.
3. Test setup: RBW: 1 MHz, VBW: 3 MHz, Sweep time: auto.

# TR-4-E-009 Radiated Emission Test Result

**Test Date:** 2024-02-01      **Tested By:** Bairong  
**EUT:** Wireless Speaker      **Model Number:** BOOMBOX 3 Wi-Fi  
**Test Mode:** 11G ANT1 2412MHz TX      **Power Supply:** AC 120V/60Hz  
**Condition:** Temp:21.5°C;Humi:39.7%      **Test Site:** DDT 3# Chamber  
**File Path:** d:\ts\2024 report data\Q23111312-2E BOOMBOX 3 Wi-Fi\FCC ABOVE 1G 2.4GWIFI\15  
**Memo:** Sample Number:S23111312-02 Power Setting:13

## Test Graph

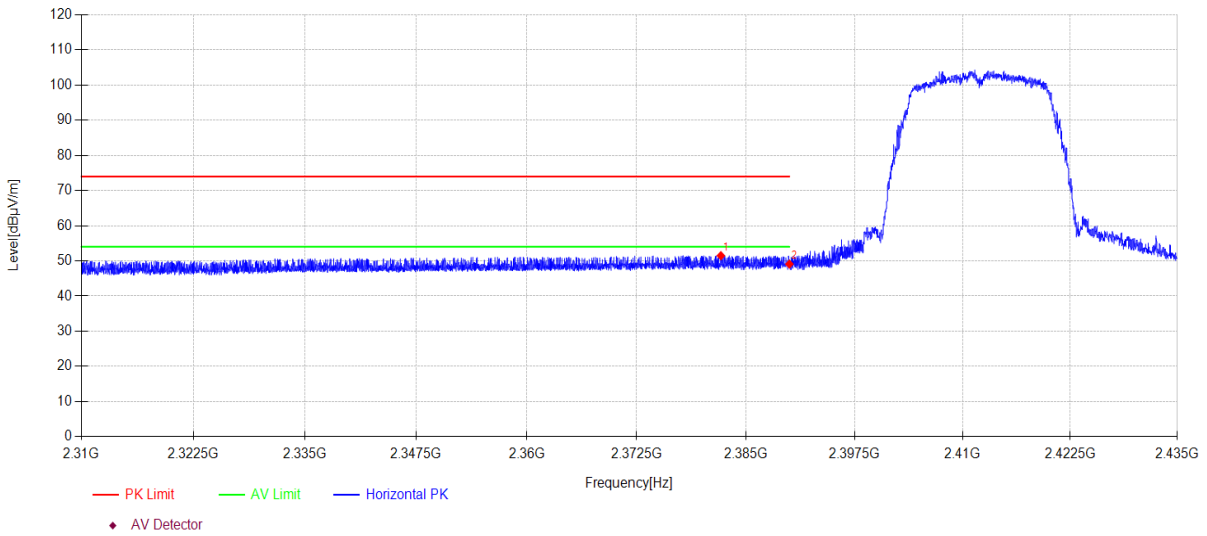

Data List										
N O.	Freq. [MHz]	Reading [dBµV/m]	Antenna Factor [dB]	Cable loss [dB]	AMP [dB]	Level [dBµV/m]	Limit [dBµV/m]	Margin [dB]	Detector	Polarity
1	2382.14	20.40	27.23	3.86	0.00	51.49	74.00	22.51	PK	Horizontal
2	2390.00	17.96	27.26	3.87	0.00	49.09	74.00	24.91	PK	Horizontal

**Note:**

1. Level = Reading + Cable loss + Antenna Factor + AMP
2. If Peak Result complies with AV limit, AV Result is deemed to comply with AV limit.
3. Test setup: RBW: 1 MHz, VBW: 3 MHz, Sweep time: auto.

# TR-4-E-009 Radiated Emission Test Result

**Test Date:** 2024-02-01      **Tested By:** Bairong  
**EUT:** Wireless Speaker      **Model Number:** BOOMBOX 3 Wi-Fi  
**Test Mode:** 11G ANT1 2412MHz TX      **Power Supply:** AC 120V/60Hz  
**Condition:** Temp:21.5°C;Humi:39.7%      **Test Site:** DDT 3# Chamber  
**File Path:** d:\ts\2024 report data\Q23111312-2E BOOMBOX 3 Wi-Fi\FCC ABOVE 1G 2.4GWIFI\16  
**Memo:** Sample Number:S23111312-02 Power Setting:13

## Test Graph

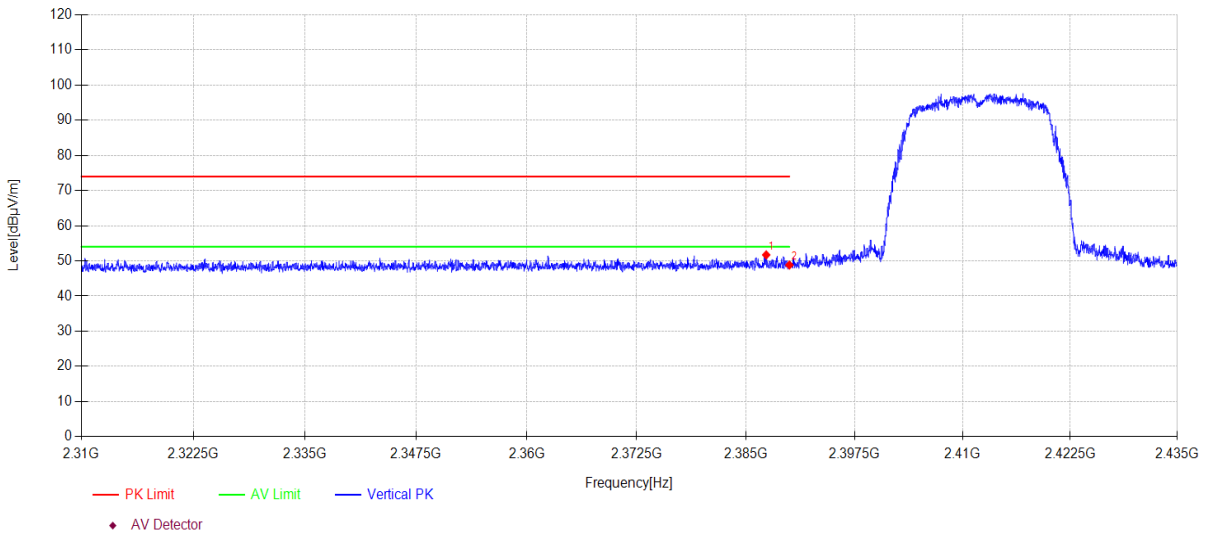

Data List										
N O.	Freq. [MHz]	Reading [dBµV/m]	Antenna Factor [dB]	Cable loss [dB]	AMP [dB]	Level [dBµV/m]	Limit [dBµV/m]	Margin [dB]	Detector	Polarity
1	2387.34	20.59	27.25	3.86	0.00	51.70	74.00	22.30	PK	Vertical
2	2390.00	17.70	27.26	3.87	0.00	48.83	74.00	25.17	PK	Vertical

**Note:**

1. Level = Reading + Cable loss + Antenna Factor + AMP
2. If Peak Result complies with AV limit, AV Result is deemed to comply with AV limit.
3. Test setup: RBW: 1 MHz, VBW: 3 MHz, Sweep time: auto.

# TR-4-E-009 Radiated Emission Test Result

**Test Date:** 2024-02-01      **Tested By:** Bairong  
**EUT:** Wireless Speaker      **Model Number:** BOOMBOX 3 Wi-Fi  
**Test Mode:** 11G ANT2 2412MHz TX      **Power Supply:** AC 120V/60Hz  
**Condition:** Temp:21.5°C;Humi:39.7%      **Test Site:** DDT 3# Chamber  
**File Path:** d:\ts\2024 report data\Q23111312-2E BOOMBOX 3 Wi-Fi\FCC ABOVE 1G 2.4GWIFI\17  
**Memo:** Sample Number:S23111312-02 Power Setting:13

## Test Graph

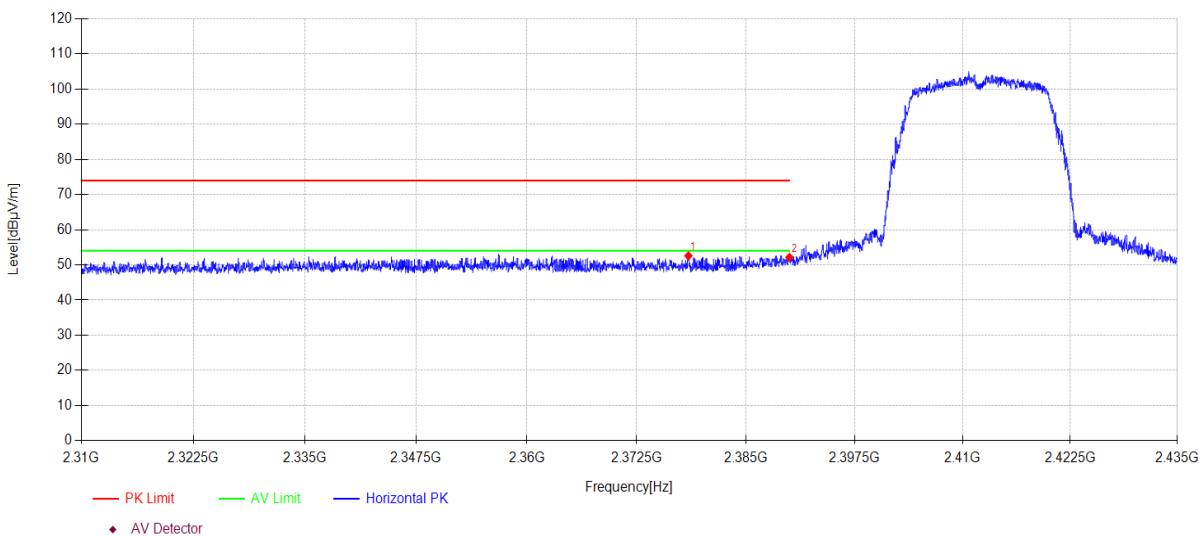

Data List										
N O.	Freq. [MHz]	Reading [dBµV/m]	Antenna Factor [dB]	Cable loss [dB]	AMP [dB]	Level [dBµV/m]	Limit [dBµV/m]	Margin [dB]	Detector	Polarity
1	2378.43	21.52	27.21	3.86	0.00	52.59	74.00	21.41	PK	Horizontal
2	2390.00	21.04	27.26	3.87	0.00	52.17	74.00	21.83	PK	Horizontal

**Note:**

1. Level = Reading + Cable loss + Antenna Factor + AMP
2. If Peak Result complies with AV limit, AV Result is deemed to comply with AV limit.
3. Test setup: RBW: 1 MHz, VBW: 3 MHz, Sweep time: auto.

# TR-4-E-009 Radiated Emission Test Result

**Test Date:** 2024-02-01      **Tested By:** Bairong  
**EUT:** Wireless Speaker      **Model Number:** BOOMBOX 3 Wi-Fi  
**Test Mode:** 11G ANT2 2412MHz TX      **Power Supply:** AC 120V/60Hz  
**Condition:** Temp:21.5°C;Humi:39.7%      **Test Site:** DDT 3# Chamber  
**File Path:** d:\ts\2024 report data\Q23111312-2E BOOMBOX 3 Wi-Fi\FCC ABOVE 1G 2.4GWIFI\18  
**Memo:** Sample Number:S23111312-02 Power Setting:13

## Test Graph

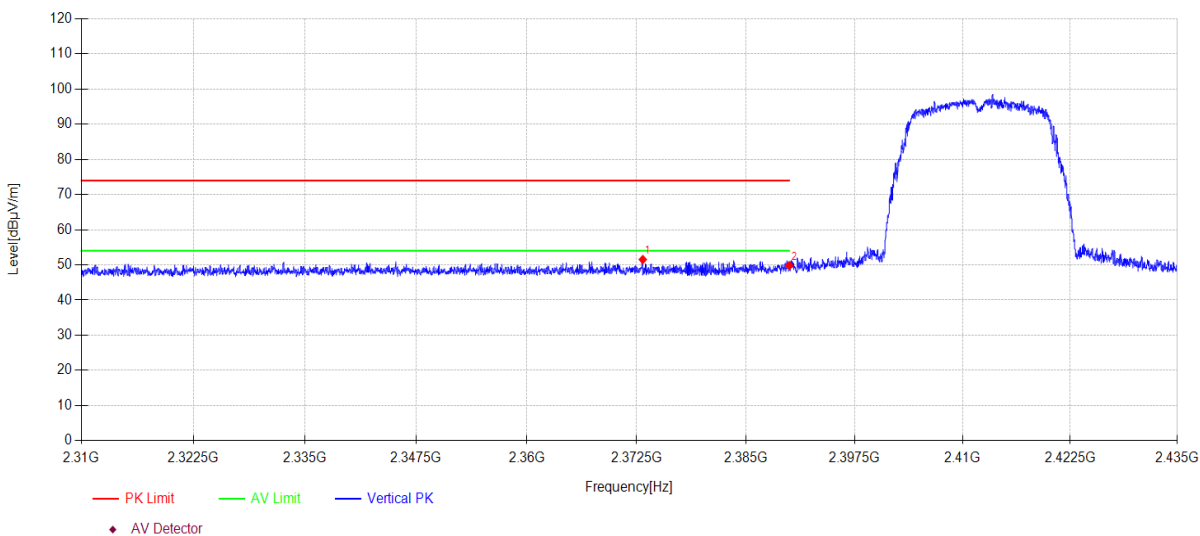

Data List										
N O.	Freq. [MHz]	Reading [dBµV/m]	Antenna Factor [dB]	Cable loss [dB]	AMP [dB]	Level [dBµV/m]	Limit [dBµV/m]	Margin [dB]	Detector	Polarity
1	2373.21	20.49	27.19	3.85	0.00	51.53	74.00	22.47	PK	Vertical
2	2390.00	18.70	27.26	3.87	0.00	49.83	74.00	24.17	PK	Vertical

**Note:**

1. Level = Reading + Cable loss + Antenna Factor + AMP
2. If Peak Result complies with AV limit, AV Result is deemed to comply with AV limit.
3. Test setup: RBW: 1 MHz, VBW: 3 MHz, Sweep time: auto.

# TR-4-E-009 Radiated Emission Test Result

**Test Date:** 2024-02-01 **Tested By:** Bairong  
**EUT:** Wireless Speaker **Model Number:** BOOMBOX 3 Wi-Fi  
**Test Mode:** 11G ANT1 2462MHz TX **Power Supply:** AC 120V/60Hz  
**Condition:** Temp:21.5°C;Humi:39.7% **Test Site:** DDT 3# Chamber  
**File Path:** d:\ts\2024 report data\Q23111312-2E BOOMBOX 3 Wi-Fi\FCC ABOVE 1G 2.4GWIFI\19  
**Memo:** Sample Number:S23111312-02 Power Setting:13

## Test Graph

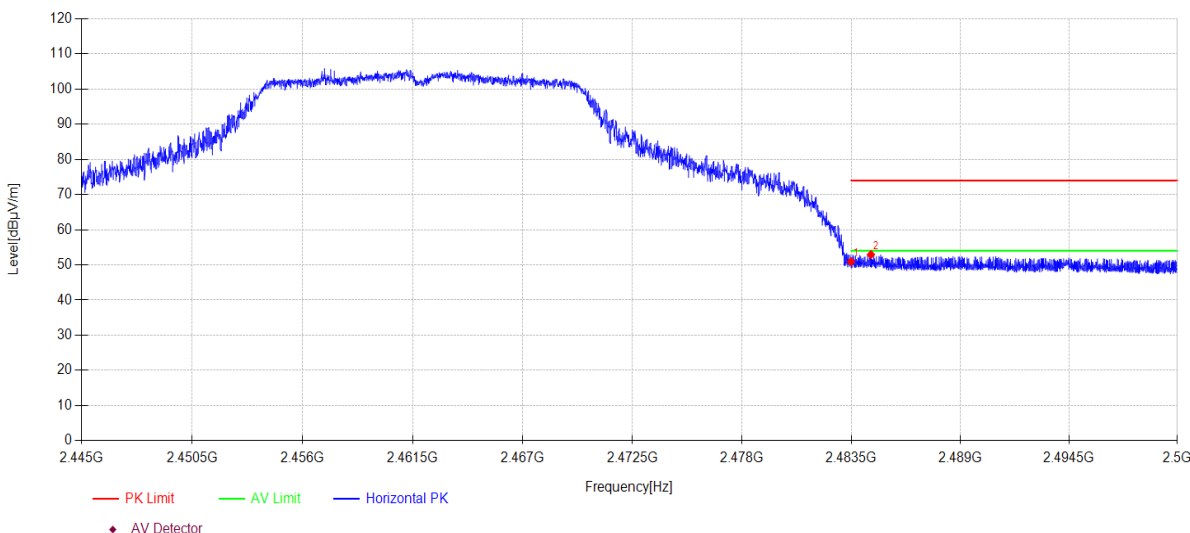

Data List										
N O.	Freq. [MHz]	Reading [dBµV/m]	Antenna Factor [dB]	Cable loss [dB]	AMP [dB]	Level [dBµV/m]	Limit [dBµV/m]	Margin [dB]	Detector	Polarity
1	2483.50	19.47	27.53	3.94	0.00	50.94	74.00	23.06	PK	Horizontal
2	2484.50	21.46	27.54	3.94	0.00	52.94	74.00	21.06	PK	Horizontal

**Note:**

1. Level = Reading + Cable loss + Antenna Factor + AMP
2. If Peak Result complies with AV limit, AV Result is deemed to comply with AV limit.
3. Test setup: RBW: 1 MHz, VBW: 3 MHz, Sweep time: auto.

# TR-4-E-009 Radiated Emission Test Result

**Test Date:** 2024-02-01      **Tested By:** Bairong  
**EUT:** Wireless Speaker      **Model Number:** BOOMBOX 3 Wi-Fi  
**Test Mode:** 11G ANT1 2462MHz TX      **Power Supply:** AC 120V/60Hz  
**Condition:** Temp:21.5°C;Humi:39.7%      **Test Site:** DDT 3# Chamber  
**File Path:** d:\ts\2024 report data\Q23111312-2E BOOMBOX 3 Wi-Fi\FCC ABOVE 1G 2.4GWIFI\20  
**Memo:** Sample Number:S23111312-02 Power Setting:13

## Test Graph

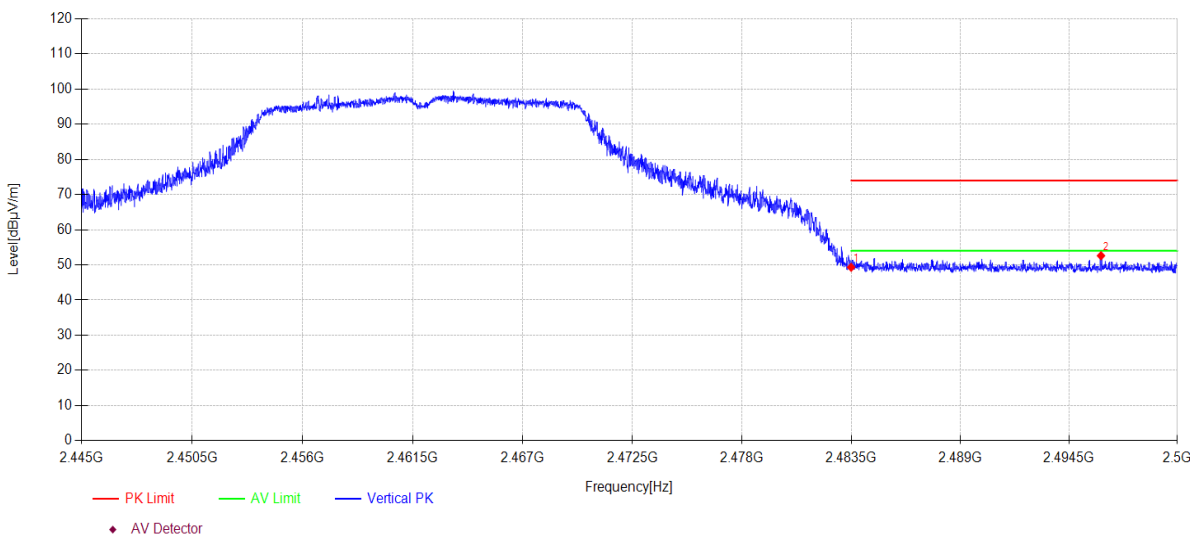

Data List										
N O.	Freq. [MHz]	Reading [dBµV/m]	Antenna Factor [dB]	Cable loss [dB]	AMP [dB]	Level [dBµV/m]	Limit [dBµV/m]	Margin [dB]	Detector	Polarity
1	2483.50	17.86	27.53	3.94	0.00	49.33	74.00	24.67	PK	Vertical
2	2496.13	21.08	27.58	3.95	0.00	52.61	74.00	21.39	PK	Vertical

**Note:**

1. Level = Reading + Cable loss + Antenna Factor + AMP
2. If Peak Result complies with AV limit, AV Result is deemed to comply with AV limit.
3. Test setup: RBW: 1 MHz, VBW: 3 MHz, Sweep time: auto.

# TR-4-E-009 Radiated Emission Test Result

**Test Date:** 2024-02-01 **Tested By:** Bairong  
**EUT:** Wireless Speaker **Model Number:** BOOMBOX 3 Wi-Fi  
**Test Mode:** 11G ANT2 2462MHz TX **Power Supply:** AC 120V/60Hz  
**Condition:** Temp:21.5°C;Humi:39.7% **Test Site:** DDT 3# Chamber  
**File Path:** d:\ts\2024 report data\Q23111312-2E BOOMBOX 3 Wi-Fi\FCC ABOVE 1G 2.4GWIFI\21  
**Memo:** Sample Number:S23111312-02 Power Setting:13

## Test Graph

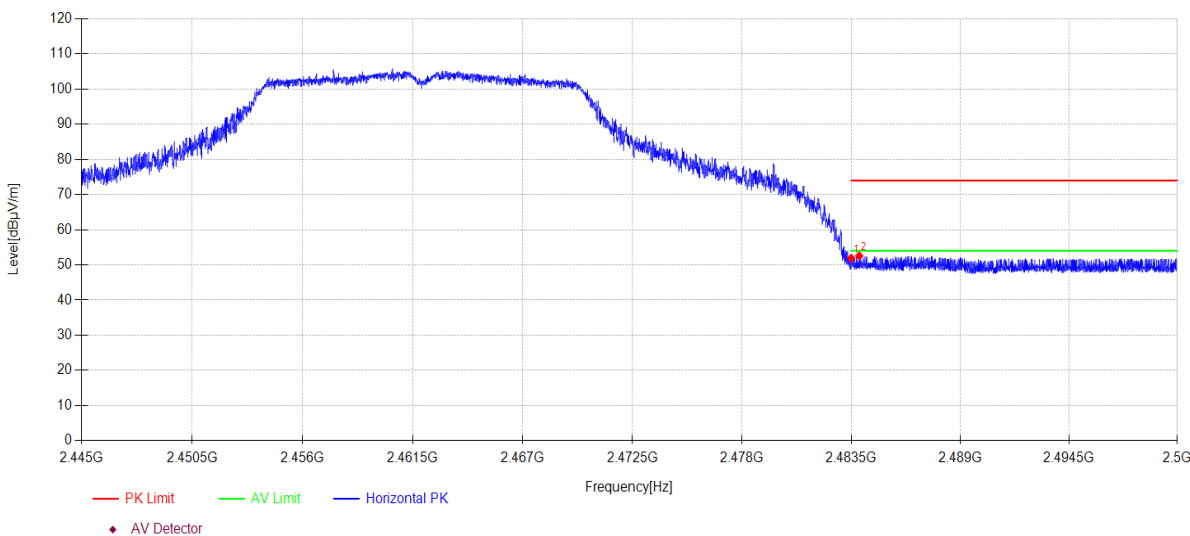

Data List										
N O.	Freq. [MHz]	Reading [dBµV/m]	Antenna Factor [dB]	Cable loss [dB]	AMP [dB]	Level [dBµV/m]	Limit [dBµV/m]	Margin [dB]	Detector	Polarity
1	2483.50	20.44	27.53	3.94	0.00	51.91	74.00	22.09	PK	Horizontal
2	2483.91	21.08	27.54	3.94	0.00	52.56	74.00	21.44	PK	Horizontal

**Note:**

1. Level = Reading + Cable loss + Antenna Factor + AMP
2. If Peak Result complies with AV limit, AV Result is deemed to comply with AV limit.
3. Test setup: RBW: 1 MHz, VBW: 3 MHz, Sweep time: auto.

# TR-4-E-009 Radiated Emission Test Result

**Test Date:** 2024-02-01 **Tested By:** Bairong  
**EUT:** Wireless Speaker **Model Number:** BOOMBOX 3 Wi-Fi  
**Test Mode:** 11G ANT2 2462MHz TX **Power Supply:** AC 120V/60Hz  
**Condition:** Temp:21.5°C;Humi:39.7% **Test Site:** DDT 3# Chamber  
**File Path:** d:\ts\2024 report data\Q23111312-2E BOOMBOX 3 Wi-Fi\FCC ABOVE 1G 2.4GWIFI\22  
**Memo:** Sample Number:S23111312-02 Power Setting:13

## Test Graph

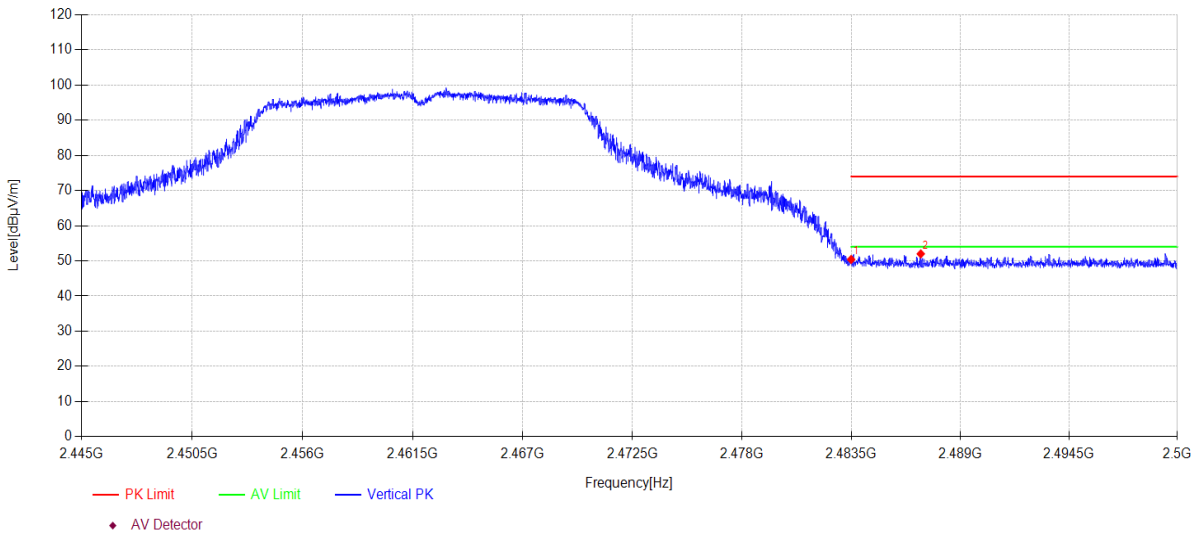

Data List										
N O.	Freq. [MHz]	Reading [dBµV/m]	Antenna Factor [dB]	Cable loss [dB]	AMP [dB]	Level [dBµV/m]	Limit [dBµV/m]	Margin [dB]	Detector	Polarity
1	2483.50	18.94	27.53	3.94	0.00	50.41	74.00	23.59	PK	Vertical
2	2487.01	20.51	27.55	3.94	0.00	52.00	74.00	22.00	PK	Vertical

**Note:**

1. Level = Reading + Cable loss + Antenna Factor + AMP
2. If Peak Result complies with AV limit, AV Result is deemed to comply with AV limit.
3. Test setup: RBW: 1 MHz, VBW: 3 MHz, Sweep time: auto.

# TR-4-E-009 Radiated Emission Test Result

**Test Date:** 2024-02-01      **Tested By:** Bairong  
**EUT:** Wireless Speaker      **Model Number:** BOOMBOX 3 Wi-Fi  
**Test Mode:** 11N20MIMO 2412MHz TX      **Power Supply:** AC 120V/60Hz  
**Condition:** Temp:21.5°C;Humi:39.7%      **Test Site:** DDT 3# Chamber  
**File Path:** d:\ts\2024 report data\Q23111312-2E BOOMBOX 3 Wi-Fi\FCC ABOVE 1G 2.4GWIFI\23  
**Memo:** Sample Number:S23111312-02 Power Setting:12

## Test Graph

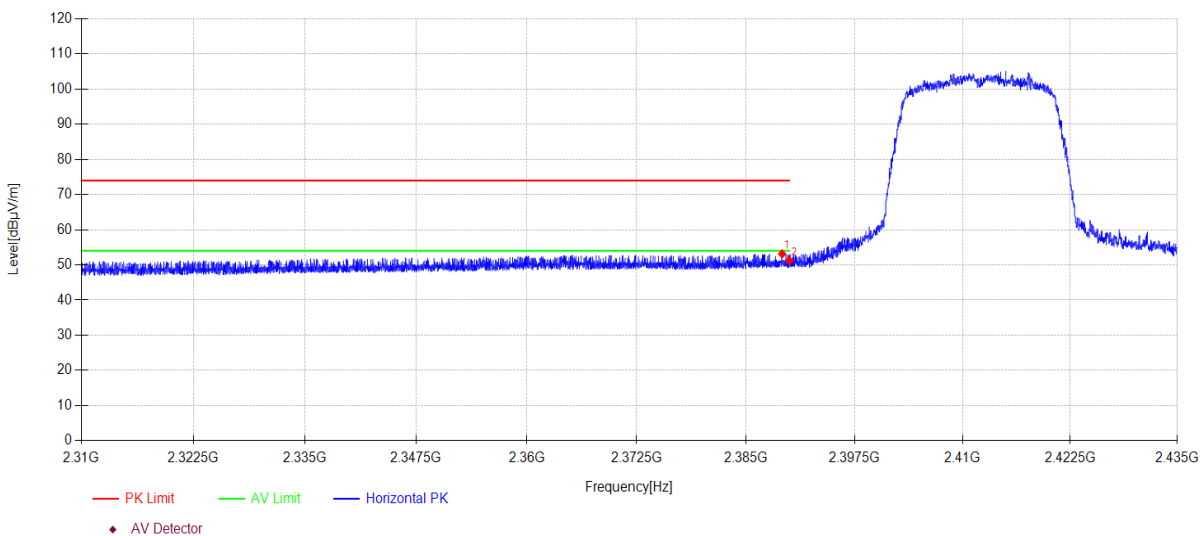

Data List										
N O.	Freq. [MHz]	Reading [dBµV/m]	Antenna Factor [dB]	Cable loss [dB]	AMP [dB]	Level [dBµV/m]	Limit [dBµV/m]	Margin [dB]	Detector	Polarity
1	2389.16	22.01	27.26	3.87	0.00	53.14	74.00	20.86	PK	Horizontal
2	2390.00	20.11	27.26	3.87	0.00	51.24	74.00	22.76	PK	Horizontal

**Note:**

1. Level = Reading + Cable loss + Antenna Factor + AMP
2. If Peak Result complies with AV limit, AV Result is deemed to comply with AV limit.
3. Test setup: RBW: 1 MHz, VBW: 3 MHz, Sweep time: auto.

# TR-4-E-009 Radiated Emission Test Result

**Test Date:** 2024-02-01      **Tested By:** Bairong  
**EUT:** Wireless Speaker      **Model Number:** BOOMBOX 3 Wi-Fi  
**Test Mode:** 11N20MIMO 2412MHz TX      **Power Supply:** AC 120V/60Hz  
**Condition:** Temp:21.5°C;Humi:39.7%      **Test Site:** DDT 3# Chamber  
**File Path:** d:\ts\2024 report data\Q23111312-2E BOOMBOX 3 Wi-Fi\FCC ABOVE 1G 2.4GWIFI\24  
**Memo:** Sample Number:S23111312-02 Power Setting:12

## Test Graph

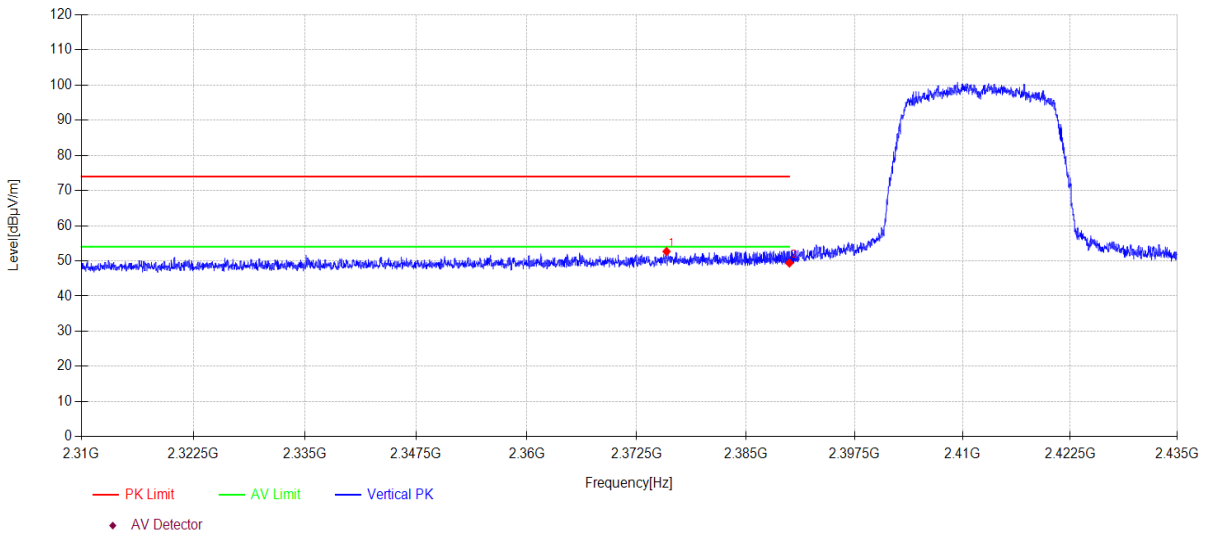

Data List										
N O.	Freq. [MHz]	Reading [dBµV/m]	Antenna Factor [dB]	Cable loss [dB]	AMP [dB]	Level [dBµV/m]	Limit [dBµV/m]	Margin [dB]	Detector	Polarity
1	2375.93	21.61	27.20	3.86	0.00	52.67	74.00	21.33	PK	Vertical
2	2390.00	18.26	27.26	3.87	0.00	49.39	74.00	24.61	PK	Vertical

**Note:**

1. Level = Reading + Cable loss + Antenna Factor + AMP
2. If Peak Result complies with AV limit, AV Result is deemed to comply with AV limit.
3. Test setup: RBW: 1 MHz, VBW: 3 MHz, Sweep time: auto.

# TR-4-E-009 Radiated Emission Test Result

**Test Date:** 2024-02-01 **Tested By:** Bairong  
**EUT:** Wireless Speaker **Model Number:** BOOMBOX 3 Wi-Fi  
**Test Mode:** 11N20MIMO 2462MHz TX **Power Supply:** AC 120V/60Hz  
**Condition:** Temp:21.5°C;Humi:39.7% **Test Site:** DDT 3# Chamber  
**File Path:** d:\ts\2024 report data\Q23111312-2E BOOMBOX 3 Wi-Fi\FCC ABOVE 1G 2.4GWIFI\25  
**Memo:** Sample Number:S23111312-02 Power Setting:12

## Test Graph

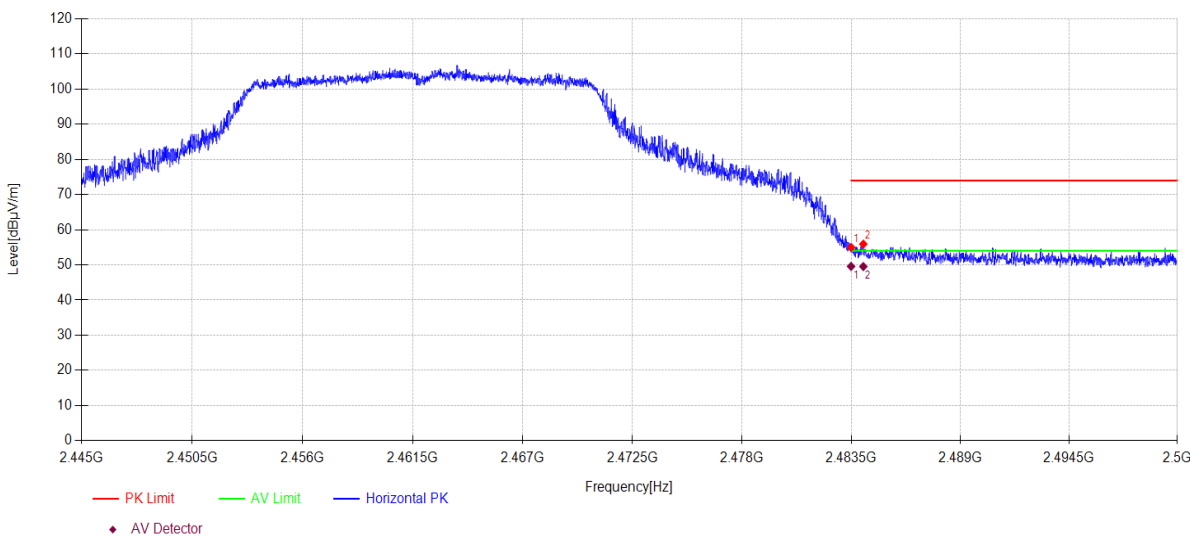

Data List										
N O.	Freq. [MHz]	Reading [dBµV/m]	Antenna Factor [dB]	Cable loss [dB]	AMP [dB]	Level [dBµV/m]	Limit [dBµV/m]	Margin [dB]	Detector	Polarity
1	2483.50	23.51	27.53	3.94	0.00	54.98	74.00	19.02	PK	Horizontal
2	2484.12	24.43	27.54	3.94	0.00	55.91	74.00	18.09	PK	Horizontal

Data List										
N O.	Freq. [MHz]	Reading [dBµV/m]	Antenna Factor [dB]	Cable loss [dB]	AMP [dB]	Level [dBµV/m]	Limit [dBµV/m]	Margin [dB]	Detector	Polarity
1	2483.50	18.10	27.53	3.94	0.00	49.57	-	4.43	AV	Horizontal
2	2484.12	18.05	27.54	3.94	0.00	49.53	-	4.47	AV	Horizontal

**Note:**

1. Level = Reading + Cable loss + Antenna Factor + AMP
2. If Peak Result complies with AV limit, AV Result is deemed to comply with AV limit.
3. Test setup: RBW: 1 MHz, VBW: 3 MHz, Sweep time: auto.



# TR-4-E-009 Radiated Emission Test Result

**Test Date:** 2024-02-01      **Tested By:** Bairong  
**EUT:** Wireless Speaker      **Model Number:** BOOMBOX 3 Wi-Fi  
**Test Mode:** 11AX20MIMO 2412MHz TX      **Power Supply:** AC 120V/60Hz  
**Condition:** Temp:21.5°C;Humi:39.7%      **Test Site:** DDT 3# Chamber  
**File Path:** d:\ts\2024 report data\Q23111312-2E BOOMBOX 3 Wi-Fi\FCC ABOVE 1G 2.4GWIFI\27  
**Memo:** Sample Number:S23111312-02 Power Setting:12

## Test Graph

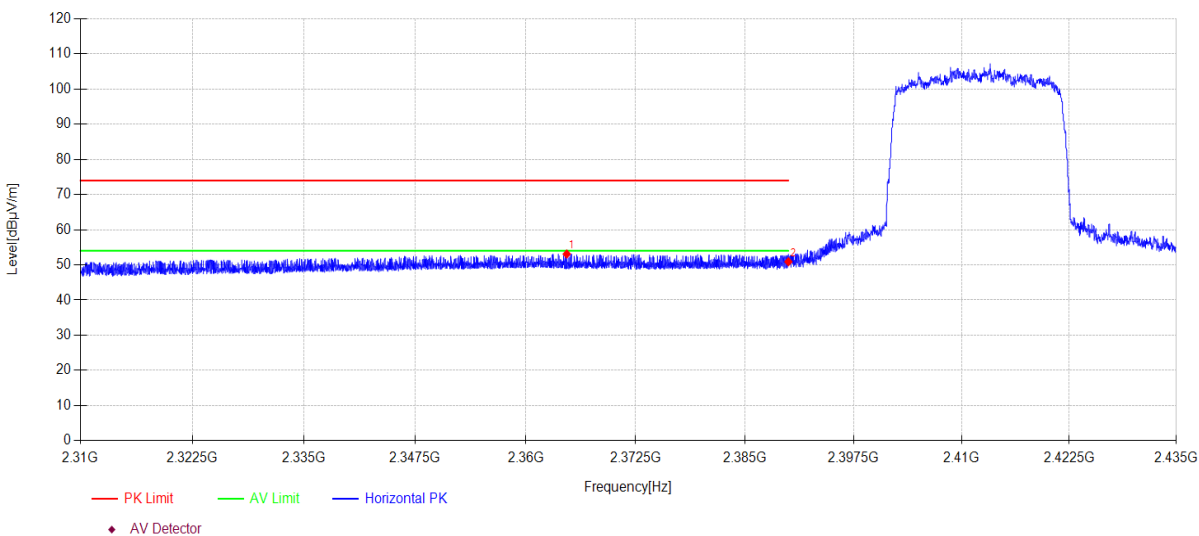

Data List										
N O.	Freq. [MHz]	Reading [dBµV/m]	Antenna Factor [dB]	Cable loss [dB]	AMP [dB]	Level [dBµV/m]	Limit [dBµV/m]	Margin [dB]	Detector	Polarity
1	2364.66	22.08	27.16	3.85	0.00	53.09	74.00	20.91	PK	Horizontal
2	2390.00	19.77	27.26	3.87	0.00	50.90	74.00	23.10	PK	Horizontal

**Note:**

1. Level = Reading + Cable loss + Antenna Factor + AMP
2. If Peak Result complies with AV limit, AV Result is deemed to comply with AV limit.
3. Test setup: RBW: 1 MHz, VBW: 3 MHz, Sweep time: auto.

# TR-4-E-009 Radiated Emission Test Result

**Test Date:** 2024-02-01      **Tested By:** Bairong  
**EUT:** Wireless Speaker      **Model Number:** BOOMBOX 3 Wi-Fi  
**Test Mode:** 11AX20MIMO 2412MHz TX      **Power Supply:** AC 120V/60Hz  
**Condition:** Temp:21.5°C;Humi:39.7%      **Test Site:** DDT 3# Chamber  
**File Path:** d:\ts\2024 report data\Q23111312-2E BOOMBOX 3 Wi-Fi\FCC ABOVE 1G 2.4GWIFI\28  
**Memo:** Sample Number:S23111312-02 Power Setting:12

## Test Graph

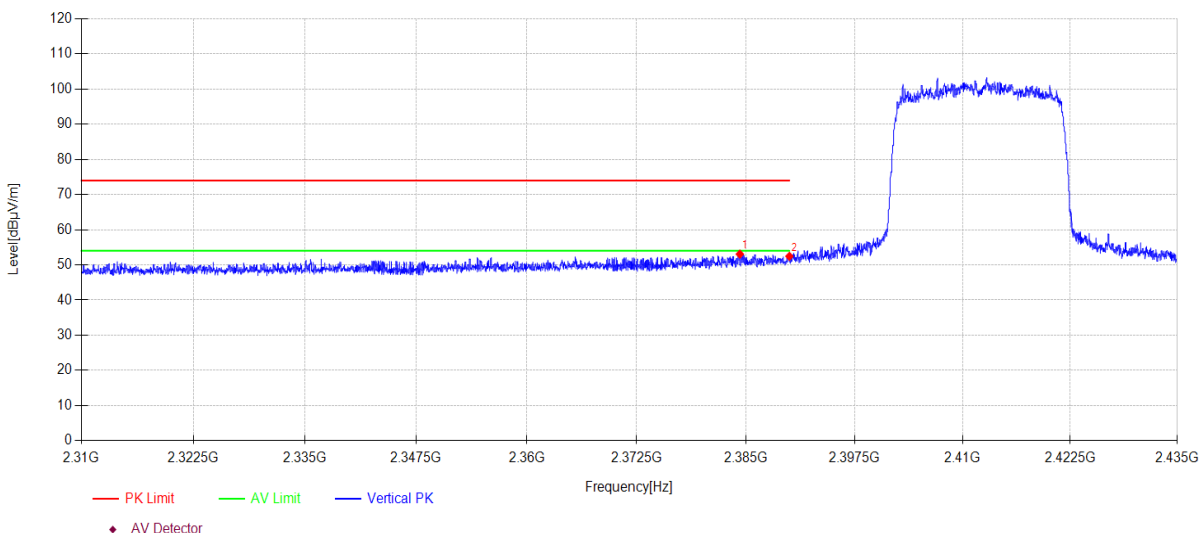

Data List										
N O.	Freq. [MHz]	Reading [dBµV/m]	Antenna Factor [dB]	Cable loss [dB]	AMP [dB]	Level [dBµV/m]	Limit [dBµV/m]	Margin [dB]	Detector	Polarity
1	2384.31	21.97	27.24	3.86	0.00	53.07	74.00	20.93	PK	Vertical
2	2390.00	21.33	27.26	3.87	0.00	52.46	74.00	21.54	PK	Vertical

**Note:**

1. Level = Reading + Cable loss + Antenna Factor + AMP
2. If Peak Result complies with AV limit, AV Result is deemed to comply with AV limit.
3. Test setup: RBW: 1 MHz, VBW: 3 MHz, Sweep time: auto.

# TR-4-E-009 Radiated Emission Test Result

**Test Date:** 2024-02-01      **Tested By:** Bairong  
**EUT:** Wireless Speaker      **Model Number:** BOOMBOX 3 Wi-Fi  
**Test Mode:** 11AX20MIMO RU0 2412MHz TX      **Power Supply:** AC 120V/60Hz  
**Condition:** Temp:21.5°C;Humi:39.7%      **Test Site:** DDT 3# Chamber  
**File Path:** d:\ts\2024 report data\Q23111312-2E BOOMBOX 3 Wi-Fi\FCC ABOVE 1G 2.4GWIFI\29  
**Memo:** Sample Number:S23111312-02 Power Setting:12

## Test Graph

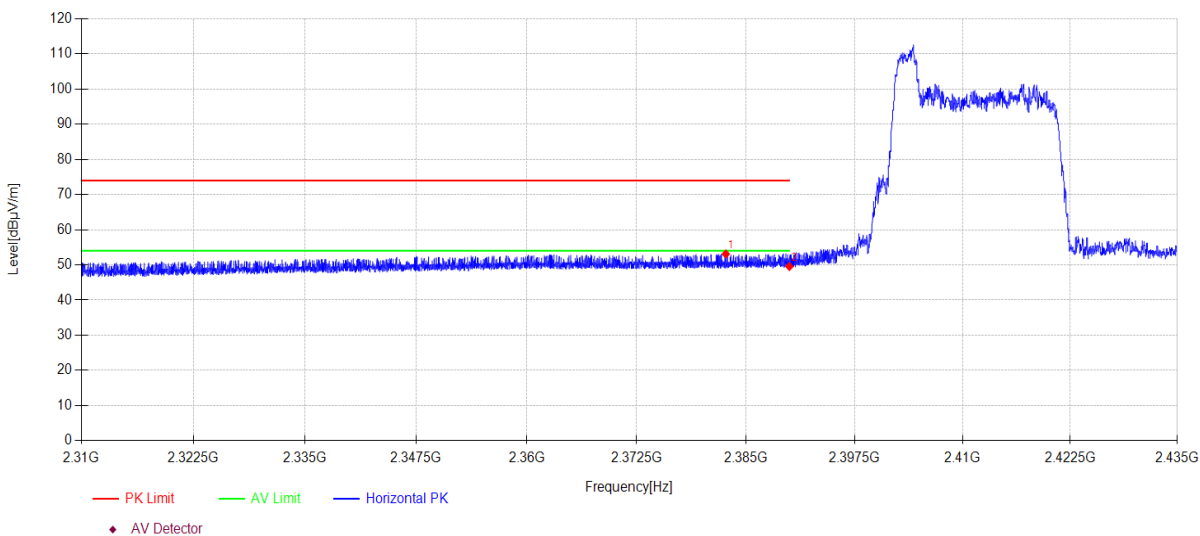

Data List										
N O.	Freq. [MHz]	Reading [dBµV/m]	Antenna Factor [dB]	Cable loss [dB]	AMP [dB]	Level [dBµV/m]	Limit [dBµV/m]	Margin [dB]	Detector	Polarity
1	2382.70	22.00	27.23	3.86	0.00	53.09	74.00	20.91	PK	Horizontal
2	2390.00	18.42	27.26	3.87	0.00	49.55	74.00	24.45	PK	Horizontal

**Note:**

1. Level = Reading + Cable loss + Antenna Factor + AMP
2. If Peak Result complies with AV limit, AV Result is deemed to comply with AV limit.
3. Test setup: RBW: 1 MHz, VBW: 3 MHz, Sweep time: auto.

# TR-4-E-009 Radiated Emission Test Result

**Test Date:** 2024-02-01      **Tested By:** Bairong  
**EUT:** Wireless Speaker      **Model Number:** BOOMBOX 3 Wi-Fi  
**Test Mode:** 11AX20MIMO RU0 2412MHz TX      **Power Supply:** AC 120V/60Hz  
**Condition:** Temp:21.5°C;Humi:39.7%      **Test Site:** DDT 3# Chamber  
**File Path:** d:\ts\2024 report data\Q23111312-2E BOOMBOX 3 Wi-Fi\FCC ABOVE 1G 2.4GWIFI\30  
**Memo:** Sample Number:S23111312-02 Power Setting:12

## Test Graph

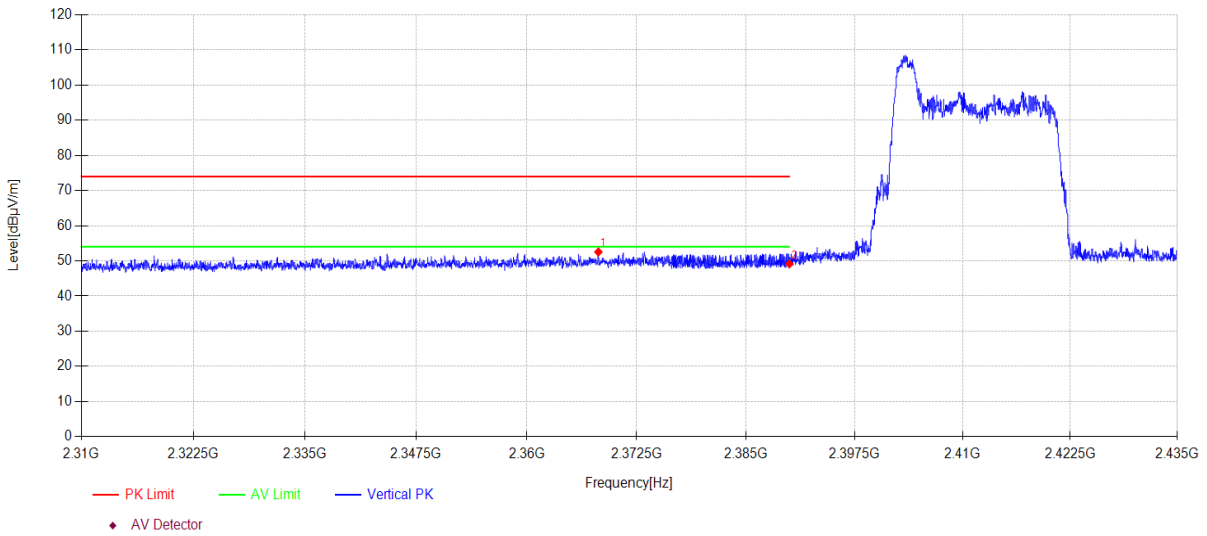

Data List										
N O.	Freq. [MHz]	Reading [dBµV/m]	Antenna Factor [dB]	Cable loss [dB]	AMP [dB]	Level [dBµV/m]	Limit [dBµV/m]	Margin [dB]	Detector	Polarity
1	2368.15	21.53	27.17	3.85	0.00	52.55	74.00	21.45	PK	Vertical
2	2390.00	18.01	27.26	3.87	0.00	49.14	74.00	24.86	PK	Vertical

**Note:**

1. Level = Reading + Cable loss + Antenna Factor + AMP
2. If Peak Result complies with AV limit, AV Result is deemed to comply with AV limit.
3. Test setup: RBW: 1 MHz, VBW: 3 MHz, Sweep time: auto.

# TR-4-E-009 Radiated Emission Test Result

**Test Date:** 2024-02-01 **Tested By:** Bairong  
**EUT:** Wireless Speaker **Model Number:** BOOMBOX 3 Wi-Fi  
**Test Mode:** 11AX20MIMO 2462MHz TX **Power Supply:** AC 120V/60Hz  
**Condition:** Temp:21.5°C;Humi:39.7% **Test Site:** DDT 3# Chamber  
**File Path:** d:\ts\2024 report data\Q23111312-2E BOOMBOX 3 Wi-Fi\FCC ABOVE 1G 2.4GWIFI\31  
**Memo:** Sample Number:S23111312-02 Power Setting:12

## Test Graph

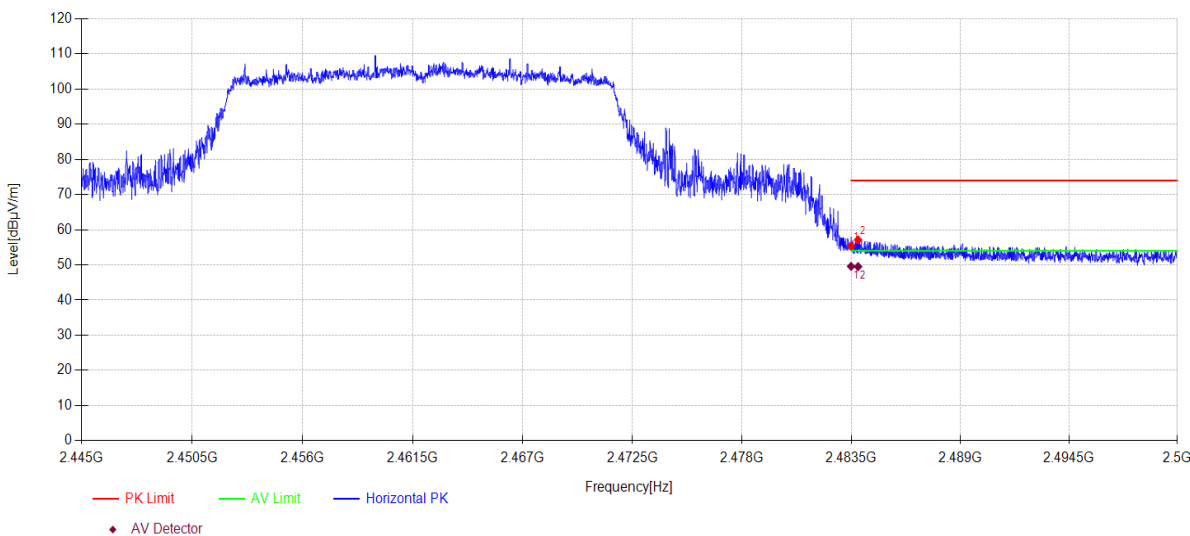

Data List										
N O.	Freq. [MHz]	Reading [dBµV/m]	Antenna Factor [dB]	Cable loss [dB]	AMP [dB]	Level [dBµV/m]	Limit [dBµV/m]	Margin [dB]	Detector	Polarity
1	2483.50	23.95	27.53	3.94	0.00	55.42	74.00	18.58	PK	Horizontal
2	2483.85	25.65	27.54	3.94	0.00	57.13	74.00	16.87	PK	Horizontal

Data List										
N O.	Freq. [MHz]	Reading [dBµV/m]	Antenna Factor [dB]	Cable loss [dB]	AMP [dB]	Level [dBµV/m]	Limit [dBµV/m]	Margin [dB]	Detector	Polarity
1	2483.50	18.11	27.53	3.94	0.00	49.58	-	4.42	AV	Horizontal
2	2483.85	18.03	27.54	3.94	0.00	49.51	-	4.49	AV	Horizontal

**Note:**

1. Level = Reading + Cable loss + Antenna Factor + AMP
2. If Peak Result complies with AV limit, AV Result is deemed to comply with AV limit.
3. Test setup: RBW: 1 MHz, VBW: 3 MHz, Sweep time: auto.

# TR-4-E-009 Radiated Emission Test Result

**Test Date:** 2024-02-01      **Tested By:** Bairong  
**EUT:** Wireless Speaker      **Model Number:** BOOMBOX 3 Wi-Fi  
**Test Mode:** 11AX20MIMO 2462MHz TX      **Power Supply:** AC 120V/60Hz  
**Condition:** Temp:21.5°C;Humi:39.7%      **Test Site:** DDT 3# Chamber  
**File Path:** d:\ts\2024 report data\Q23111312-2E BOOMBOX 3 Wi-Fi\FCC ABOVE 1G 2.4GWIFI\32  
**Memo:** Sample Number:S23111312-02 Power Setting:12

## Test Graph

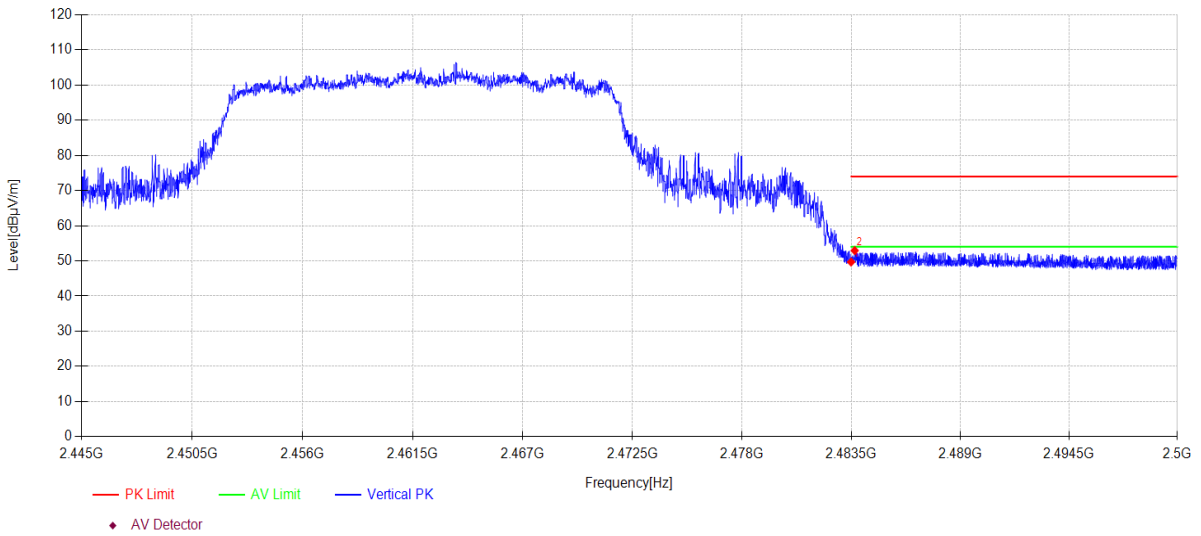

Data List										
N O.	Freq. [MHz]	Reading [dBµV/m]	Antenna Factor [dB]	Cable loss [dB]	AMP [dB]	Level [dBµV/m]	Limit [dBµV/m]	Margin [dB]	Detector	Polarity
1	2483.50	18.22	27.53	3.94	0.00	49.69	74.00	24.31	PK	Vertical
2	2483.68	21.48	27.53	3.94	0.00	52.95	74.00	21.05	PK	Vertical

**Note:**

1. Level = Reading + Cable loss + Antenna Factor + AMP
2. If Peak Result complies with AV limit, AV Result is deemed to comply with AV limit.
3. Test setup: RBW: 1 MHz, VBW: 3 MHz, Sweep time: auto.

# TR-4-E-009 Radiated Emission Test Result

**Test Date:** 2024-02-01 **Tested By:** Bairong  
**EUT:** Wireless Speaker **Model Number:** BOOMBOX 3 Wi-Fi  
**Test Mode:** 11AX20MIMO RU8 2462MHz TX **Power Supply:** AC 120V/60Hz  
**Condition:** Temp:21.5°C;Humi:39.7% **Test Site:** DDT 3# Chamber  
**File Path:** d:\ts\2024 report data\Q23111312-2E BOOMBOX 3 Wi-Fi\FCC ABOVE 1G 2.4GWIFI\33  
**Memo:** Sample Number:S23111312-02 Power Setting:12

## Test Graph

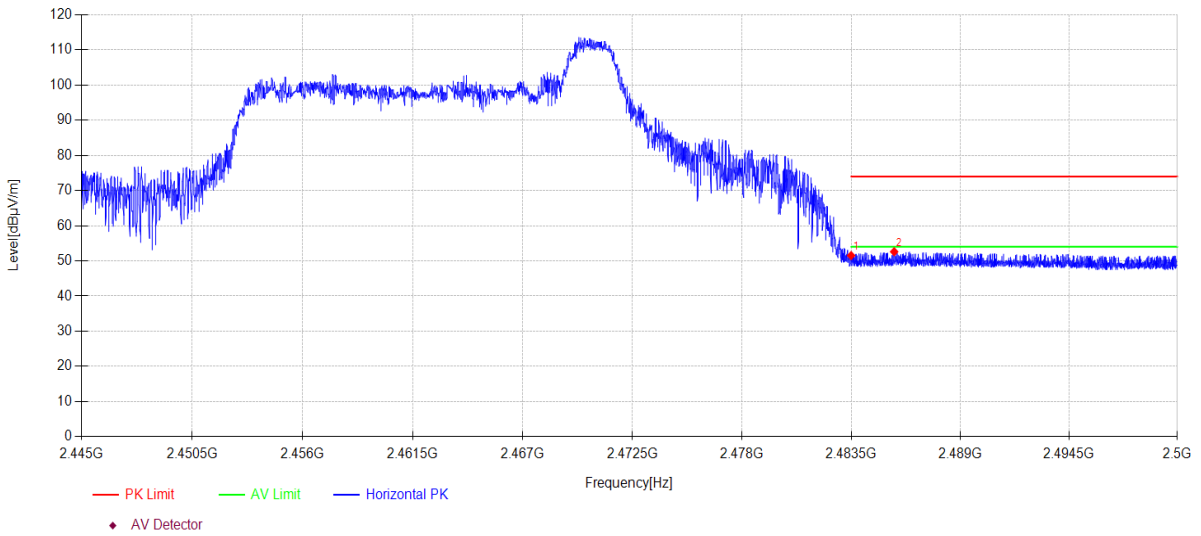

Data List										
N O.	Freq. [MHz]	Reading [dBµV/m]	Antenna Factor [dB]	Cable loss [dB]	AMP [dB]	Level [dBµV/m]	Limit [dBµV/m]	Margin [dB]	Detector	Polarity
1	2483.50	20.06	27.53	3.94	0.00	51.53	74.00	22.47	PK	Horizontal
2	2485.67	21.13	27.54	3.94	0.00	52.61	74.00	21.39	PK	Horizontal

**Note:**

1. Level = Reading + Cable loss + Antenna Factor + AMP
2. If Peak Result complies with AV limit, AV Result is deemed to comply with AV limit.
3. Test setup: RBW: 1 MHz, VBW: 3 MHz, Sweep time: auto.

# TR-4-E-009 Radiated Emission Test Result

**Test Date:** 2024-02-01 **Tested By:** Bairong  
**EUT:** Wireless Speaker **Model Number:** BOOMBOX 3 Wi-Fi  
**Test Mode:** 11AX20MIMO RU8 2462MHz TX **Power Supply:** AC 120V/60Hz  
**Condition:** Temp:21.5°C;Humi:39.7% **Test Site:** DDT 3# Chamber  
**File Path:** d:\ts\2024 report data\Q23111312-2E BOOMBOX 3 Wi-Fi\FCC ABOVE 1G 2.4GWIFI\34  
**Memo:** Sample Number:S23111312-02 Power Setting:12

## Test Graph

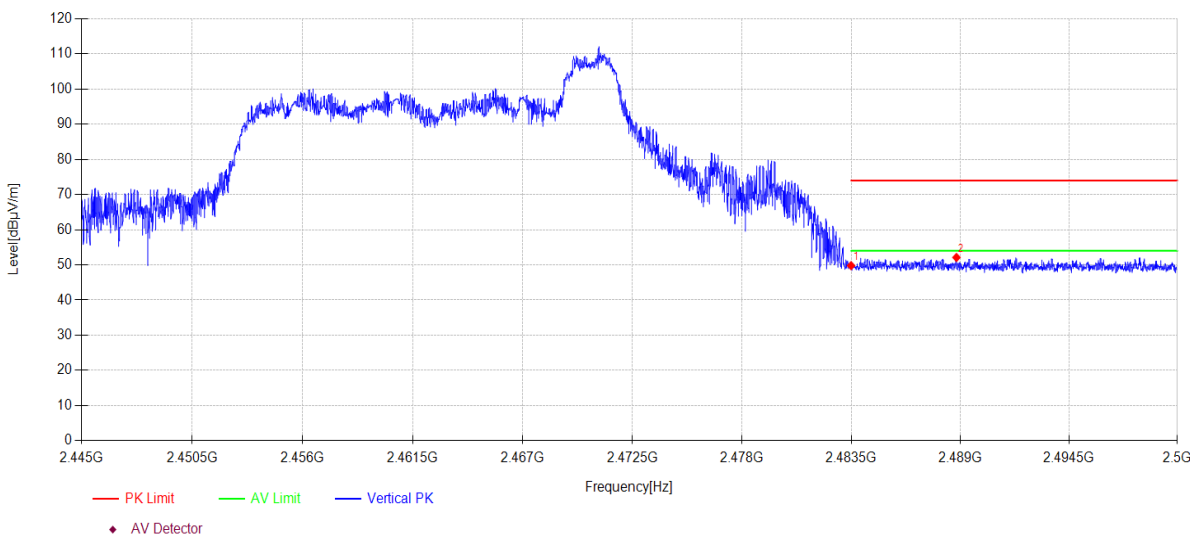

Data List										
N O.	Freq. [MHz]	Reading [dBµV/m]	Antenna Factor [dB]	Cable loss [dB]	AMP [dB]	Level [dBµV/m]	Limit [dBµV/m]	Margin [dB]	Detector	Polarity
1	2483.50	18.32	27.53	3.94	0.00	49.79	74.00	24.21	PK	Vertical
2	2488.82	20.62	27.56	3.94	0.00	52.12	74.00	21.88	PK	Vertical

**Note:**

1. Level = Reading + Cable loss + Antenna Factor + AMP
2. If Peak Result complies with AV limit, AV Result is deemed to comply with AV limit.
3. Test setup: RBW: 1 MHz, VBW: 3 MHz, Sweep time: auto.

# TR-4-E-009 Radiated Emission Test Result

**Test Date:** 2024-02-01      **Tested By:** Bairong  
**EUT:** Wireless Speaker      **Model Number:** BOOMBOX 3 Wi-Fi  
**Test Mode:** 11N40MIMO 2422MHz TX      **Power Supply:** AC 120V/60Hz  
**Condition:** Temp:21.5°C;Humi:39.7%      **Test Site:** DDT 3# Chamber  
**File Path:** d:\ts\2024 report data\Q23111312-2E BOOMBOX 3 Wi-Fi\FCC ABOVE 1G 2.4GWIFI\35  
**Memo:** Sample Number:S23111312-02 Power Setting:12

## Test Graph

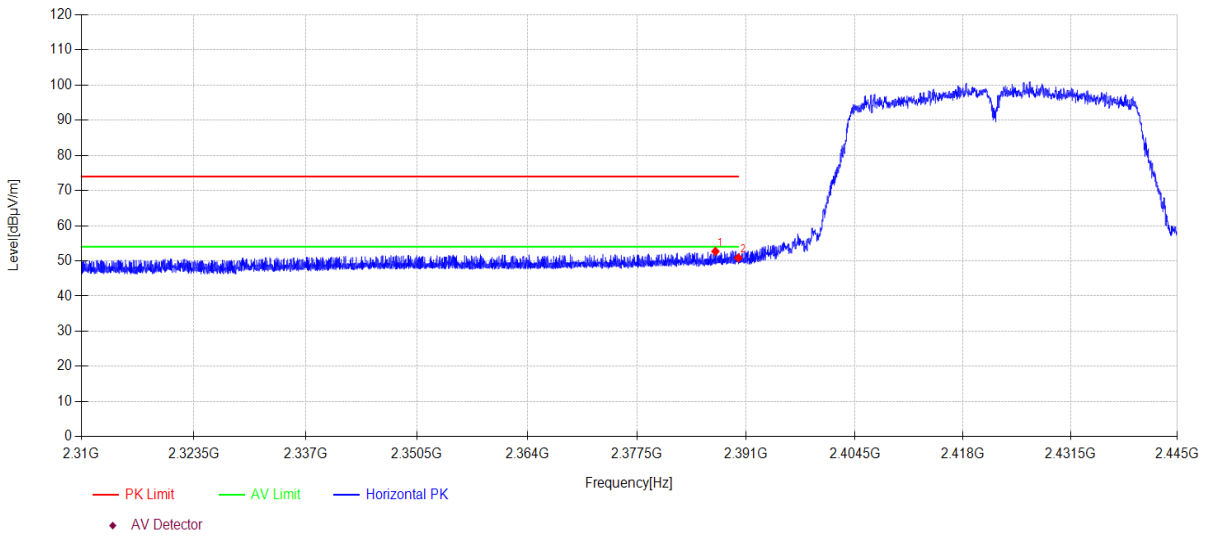

Data List										
N O.	Freq. [MHz]	Reading [dBµV/m]	Antenna Factor [dB]	Cable loss [dB]	AMP [dB]	Level [dBµV/m]	Limit [dBµV/m]	Margin [dB]	Detector	Polarity
1	2387.17	21.59	27.25	3.86	0.00	52.70	74.00	21.30	PK	Horizontal
2	2390.00	19.74	27.26	3.87	0.00	50.87	74.00	23.13	PK	Horizontal

**Note:**

1. Level = Reading + Cable loss + Antenna Factor + AMP
2. If Peak Result complies with AV limit, AV Result is deemed to comply with AV limit.
3. Test setup: RBW: 1 MHz, VBW: 3 MHz, Sweep time: auto.

# TR-4-E-009 Radiated Emission Test Result

**Test Date:** 2024-02-01      **Tested By:** Bairong  
**EUT:** Wireless Speaker      **Model Number:** BOOMBOX 3 Wi-Fi  
**Test Mode:** 11N40MIMO 2422MHz TX      **Power Supply:** AC 120V/60Hz  
**Condition:** Temp:21.5°C;Humi:39.7%      **Test Site:** DDT 3# Chamber  
**File Path:** d:\ts\2024 report data\Q23111312-2E BOOMBOX 3 Wi-Fi\FCC ABOVE 1G 2.4GWIFI\36  
**Memo:** Sample Number:S23111312-02 Power Setting:12

## Test Graph

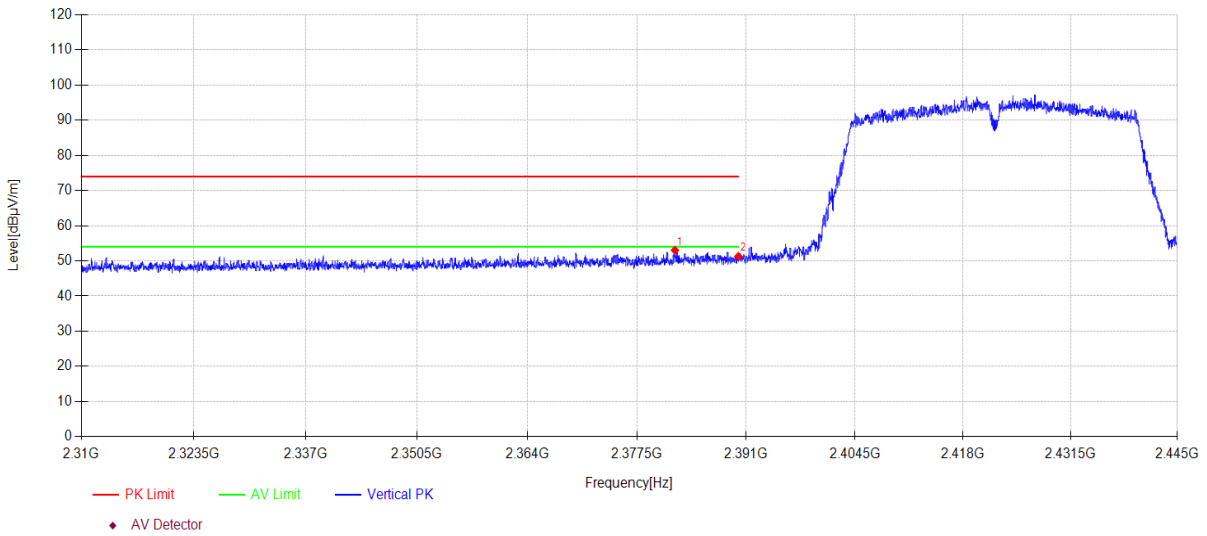

Data List										
N O.	Freq. [MHz]	Reading [dBµV/m]	Antenna Factor [dB]	Cable loss [dB]	AMP [dB]	Level [dBµV/m]	Limit [dBµV/m]	Margin [dB]	Detector	Polarity
1	2382.16	21.94	27.23	3.86	0.00	53.03	74.00	20.97	PK	Vertical
2	2390.00	20.15	27.26	3.87	0.00	51.28	74.00	22.72	PK	Vertical

**Note:**

1. Level = Reading + Cable loss + Antenna Factor + AMP
2. If Peak Result complies with AV limit, AV Result is deemed to comply with AV limit.
3. Test setup: RBW: 1 MHz, VBW: 3 MHz, Sweep time: auto.

# TR-4-E-009 Radiated Emission Test Result

**Test Date:** 2024-02-01      **Tested By:** Bairong  
**EUT:** Wireless Speaker      **Model Number:** BOOMBOX 3 Wi-Fi  
**Test Mode:** 11N40MIMO 2452MHz TX      **Power Supply:** AC 120V/60Hz  
**Condition:** Temp:21.5°C;Humi:39.7%      **Test Site:** DDT 3# Chamber  
**File Path:** d:\ts\2024 report data\Q23111312-2E BOOMBOX 3 Wi-Fi\FCC ABOVE 1G 2.4GWIFI\37  
**Memo:** Sample Number:S23111312-02 Power Setting:12

## Test Graph

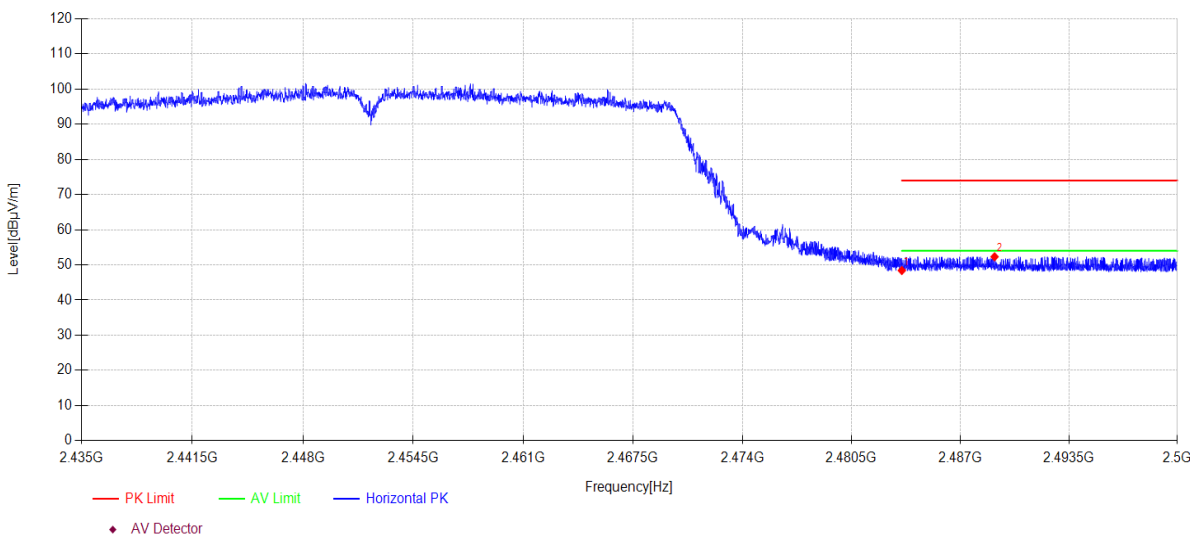

Data List										
N O.	Freq. [MHz]	Reading [dBµV/m]	Antenna Factor [dB]	Cable loss [dB]	AMP [dB]	Level [dBµV/m]	Limit [dBµV/m]	Margin [dB]	Detector	Polarity
1	2483.50	16.95	27.53	3.94	0.00	48.42	74.00	25.58	PK	Horizontal
2	2489.04	20.82	27.56	3.94	0.00	52.32	74.00	21.68	PK	Horizontal

**Note:**

1. Level = Reading + Cable loss + Antenna Factor + AMP
2. If Peak Result complies with AV limit, AV Result is deemed to comply with AV limit.
3. Test setup: RBW: 1 MHz, VBW: 3 MHz, Sweep time: auto.

# TR-4-E-009 Radiated Emission Test Result

**Test Date:** 2024-02-01      **Tested By:** Bairong  
**EUT:** Wireless Speaker      **Model Number:** BOOMBOX 3 Wi-Fi  
**Test Mode:** 11N40MIMO 2452MHz TX      **Power Supply:** AC 120V/60Hz  
**Condition:** Temp:21.5°C;Humi:39.7%      **Test Site:** DDT 3# Chamber  
**File Path:** d:\ts\2024 report data\Q23111312-2E BOOMBOX 3 Wi-Fi\FCC ABOVE 1G 2.4GWIFI\38  
**Memo:** Sample Number:S23111312-02 Power Setting:12

## Test Graph

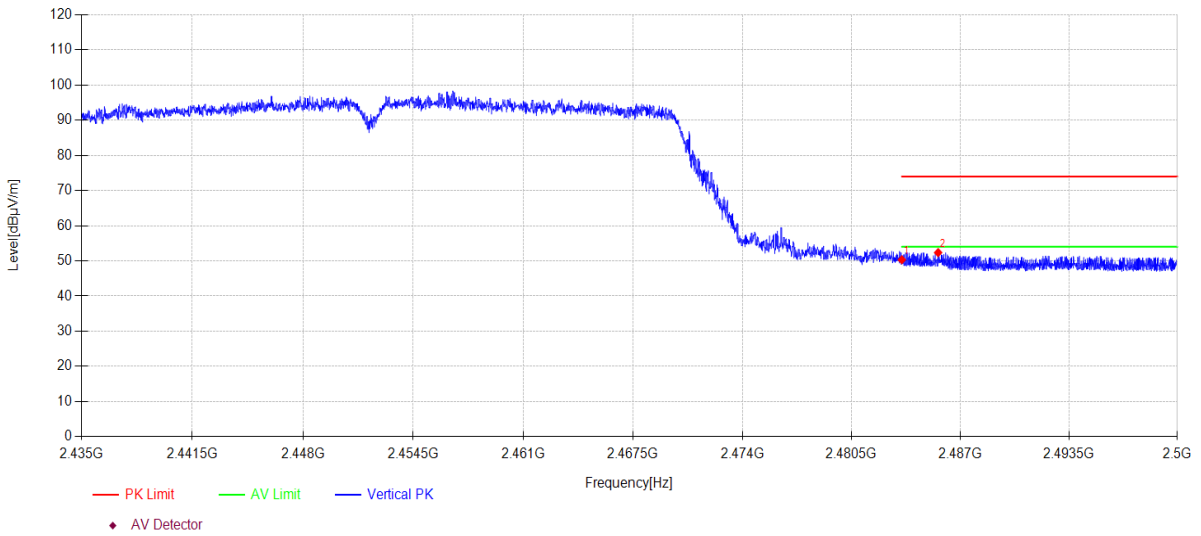

Data List										
N O.	Freq. [MHz]	Reading [dBµV/m]	Antenna Factor [dB]	Cable loss [dB]	AMP [dB]	Level [dBµV/m]	Limit [dBµV/m]	Margin [dB]	Detector	Polarity
1	2483.50	18.86	27.53	3.94	0.00	50.33	74.00	23.67	PK	Vertical
2	2485.67	20.89	27.54	3.94	0.00	52.37	74.00	21.63	PK	Vertical

**Note:**

1. Level = Reading + Cable loss + Antenna Factor + AMP
2. If Peak Result complies with AV limit, AV Result is deemed to comply with AV limit.
3. Test setup: RBW: 1 MHz, VBW: 3 MHz, Sweep time: auto.