

FCC AND IC CERTIFICATION TEST REPORT

FOR

Applicant	:	Harman International Industries, Incorporated
Address	:	8500 Balboa Boulevard, Northridge, CA 91329, UNITED STATES
Equipment under Test	:	2.1 Soundbar with Wireless Subwoofer
FCC Model No.	:	Bar 2.1
IC Model No.	:	Bar 2.1 Soundbar
Trade Mark	:	JBL
FCC ID	:	APIJBLBAR21C
IC	:	6132A-JBLBAR21C
Manufacturer	:	Harman International Industries, Incorporated
Address	:	8500 Balboa Boulevard, Northridge, CA 91329, UNITED STATES

Issued By: Dongguan Dongdian Testing Service Co., Ltd.

Add: No. 17, Zongbu Road 2, Songshan Lake Sci&Tech, Industry Park, Dongguan City,
Guangdong Province, China, 523808

Tel: +86-0769-22891499 [Http://www.dgddt.com](http://www.dgddt.com)

REPORT

TABLE OF CONTENTS

	Test report declares.....	4
1.	Summary of test results	4
2.	General test information.....	5
2.1.	Description of EUT	5
2.2.	Accessories of EUT.....	5
2.3.	Assistant equipment used for test.....	6
2.4.	Block diagram of EUT configuration for test	6
2.5.	Test environment conditions	6
2.6.	Test laboratory.....	6
2.7.	Measurement uncertainty	7
3.	Equipment used during test.....	8
4.	20dB Bandwidth and 99% Bandwidth.....	9
4.1.	Block diagram of test setup.....	9
4.2.	Limits	9
4.3.	Test Procedure.....	9
4.4.	Test Result.....	9
4.5.	Original test data	9
5.	Radiated emission	11
5.1.	Block diagram of test setup.....	11
5.2.	Limit.....	12
5.3.	Test Procedure.....	13
5.4.	Test result	14
6.	Band Edge Compliance (radiated method)	18
6.1.	Block diagram of test setup.....	18
6.2.	Limit.....	18
6.3.	Test Procedure.....	18
6.4.	Test result	18
7.	Power Line Conducted Emission	23
7.1.	Block diagram of test setup.....	23
7.2.	Power Line Conducted Emission Limits(Class B).....	23
7.3.	Test Procedure.....	23
7.4.	Test Result.....	24
8.	Antenna Requirements	27
8.1.	Limit.....	27
8.2.	Result.....	27
9.	Test setup photograph	28
10.	Photos of the EUT	30

TEST REPORT DECLARE

Applicant	:	Harman International Industries, Incorporated
Address	:	8500 Balboa Boulevard, Northridge, CA 91329, UNITED STATES
Equipment under Test	:	2.1 Soundbar with Wireless Subwoofer
FCC Model No.	:	Bar 2.1
IC Model No.	:	Bar 2.1 Soundbar
Trade Mark	:	JBL
Manufacturer	:	Harman International Industries, Incorporated
Address	:	8500 Balboa Boulevard, Northridge, CA 91329, UNITED STATES

Test Standard Used:

FCC Rules and Regulations Part 15 Subpart C, RSS-210 Issue 9 August 2016.

Test procedure used:

ANSI C63.10:2013, ANSI C63.4:2014, RSS-Gen Issue 4, Nov. 2014.

We Declare:

The equipment described above is tested by Dongguan Dongdian Testing Service Co., Ltd and in the configuration tested the equipment complied with the standards specified above. The test results are contained in this test report and Dongguan Dongdian Testing Service Co., Ltd is assumed of full responsibility for the accuracy and completeness of these tests.

After test and evaluation, our opinion is that the equipment provided for test compliance with the requirement of the above FCC&IC standards.

Report No:	DDT-R17Q0419-11E4		
Date of Receipt:	Apr. 19, 2017	Date of Test:	Apr. 20, 2017 ~ May 18, 2017

Prepared By:



Leo Liu/Engineer

Approved By:



Kevin Feng/EMC Manager

Note: This report applies to above tested sample only. This report shall not be reproduced in parts without written approval of Dongguan Dongdian Testing Service Co., Ltd.

1. Summary of test results

Description of Test Item	Standard	Results
20dB Bandwidth and 99% Bandwidth	FCC Part 15: 15.215 RSS-GEN ISSUE 4 6.6 ANSI C63.10:2013 ANSI C63.4:2014	PASS
Radiated Emission	FCC Part 15: 15.209 FCC Part 15: 15.249(d) RSS-210 Issue 9 B.10.a ANSI C63.10:2013 ANSI C63.4:2014	PASS
Band Edge Compliance	FCC Part 15: 15.249(d) RSS-210 Issue 9 B.10.b RSS-Gen Issue 4 8.9 8.10 ANSI C63.10:2013 ANSI C63.4:2014	PASS
Power Line Conducted Emissions	FCC Part 15: 15.207 RSS-Gen Issue 4 8.8 ANSI C63.10:2013 ANSI C63.4:2014	PASS

2. General test information

2.1. Description of EUT

EUT* Name	:	2.1 Soundbar with Wireless Subwoofer
FCC Model No.	:	Bar 2.1
IC Model No.	:	Bar 2.1 Soundbar
EUT function description	:	Please reference user manual of this device
Power supply	:	Soundbar: AC 120V/60Hz
Operation frequency	:	5743MHz -5840MHz
Channel	:	35
Modulation	:	GFSK
Data rate	:	2MHz
Antenna Type	:	Integrated antenna, maximum PK gain: 2.85dBi
Sample Type	:	Series production

Note: EUT is the ab. of equipment under test.

Note 2: This report only for Soundbar 5.8GHz ISM band mode of EUT, for Bluetooth BDR/ EDR and BLE mode was reported in another test report.

EUT channels and frequencies list:

Channel	Frequency (MHz)	Channel	Frequency (MHz)	Channel	Frequency (MHz)
0	5743	12	5778	24	5812
1	5747	1	5779	25	5815
2	5751	14	5783	26	5818
3	5752	15	5787	27	5819
4	5755	16	5791	28	5823
5	5758	17	5792	29	5827
6	5759	18	5795	30	5831
7	5763	19	5798	31	5832
8	5767	20	5799	32	5835
9	5771	21	5803	33	5837
10	5772	22	5807	34	5840
11	5775	23	5811	/	/

2.2. Accessories of EUT

Description of Accessories	Manufacturer	Model number or Type	Serial No.	Other
AC cable	JBL	N/A	N/A	Length: 1.5m without core

2.3. Assistant equipment used for test

Description of Assistant equipment	Manufacturer	Model number or Type	EMC Compliance	SN
/	/	/	/	/

2.4. Block diagram of EUT configuration for test

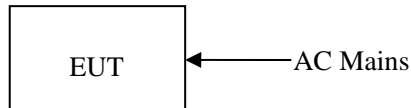

Test software: IA9Q_EMI_TOOL

The test software was used to control EUT work in Continuous TX mode, and select test channel, wireless mode as blow table:

Tested mode, information	
Mode	Frequency (MHz)
Tx Mode	5743
	5791
	5840

2.5. Test environment conditions

During the measurement the environmental conditions were within the listed ranges:

Temperature range:	21-25°C
Humidity range:	40-75%
Pressure range:	86-106kPa

2.6. Test laboratory

Dongguan Dongdian Testing Service Co., Ltd

Add: No. 17, Zongbu Road 2, Songshan Lake Sci&Tech, Industry Park, Dongguan City, Guangdong Province, China, 523808 Tel: +86-0769-22891499 <http://www.dgddt.com>

FCC Registration Number: 270092

2.7. Measurement uncertainty

Test Item	Uncertainty
Uncertainty for Conduction emission test	3.32dB (150KHz-30MHz)
	3.72dB (9KHz-150KHz)
Uncertainty for Radiation Emission test(include Fundamental emission) (30MHz-1GHz)	4.70 dB (Antenna Polarize: V)
	4.84 dB (Antenna Polarize: H)
Uncertainty for Radiation Emission test (1GHz to 18GHz)(include Fundamental emission)	4.10dB(1-6GHz)
	4.40dB (6GHz-18Gz)
Bandwidth	1.1%
Stop Transmitting Time Test	0.6%
Uncertainty for frequency error	6.7 x 10-8 (Antenna couple method)
	5.5 x 10-8 (Conducted method)
Note: This uncertainty represents an expanded uncertainty expressed at approximately the 95% confidence level using a coverage factor of k=2.	

3. Equipment used during test

Equipment	Manufacturer	Model No.	Serial No.	Last Cal.	Cal. Interval
RF Connected Test					
Spectrum analyzer	R&S	FSU26	1166.1660.26	Oct. 16, 2016	1Year
Vector Signal Generator	Agilent	E8267D	MY52098743	Oct. 20, 2016	1Year
Vector Signal Generator	Agilent	N5182A	MY48180737	Jul. 05, 2016	1Year
Power Sensor	Agilent	U2021XA	MY55150010	Apr. 18, 2016 Apr. 18, 2017	1Year
Power Sensor	Agilent	U2021XA	MY55150011	Apr. 19, 2016/Apr. 19, 2017	1Year
DC Power Source	MATRIS	MPS-3005L-3	D813058W	Oct. 24, 2016	1Year
Attenuator	Mini-Circuits	BW-S10W2	101109	Aug. 18, 2016	1Year
RF Cable	Micable	C10-01-01-1	100309	Aug. 18, 2016	1Year
Test Software	JS Tonscend	JS1120-2	Ver.2.5	N/A	N/A
USB Data acquisition	Agilent	U2531A	TW55043503	N/A	N/A
Auto control Unit	JS Tonscend	JS0806-2	158060010	N/A	N/A
Radiated Emission Test					
EMI Test Receiver	R&S	ESU8	100316	Oct. 16, 2016	1Year
Spectrum analyzer	R&S	FSU26	1166.1660.26	Oct. 16, 2016	1Year
Trilog Broadband Antenna	Schwarzbeck	VULB9163	9163-462	Oct. 27, 2016	1 Year
Active Loop antenna	Schwarzbeck	FMZB-1519	1519-038	Oct. 16, 2016	1 Year
Double Ridged Horn Antenna	R&S	HF907	100276	Oct. 12, 2016	1 Year
Pre-amplifier	A.H.	PAM-0118	360	Oct. 16, 2016	1 Year
RF Cable	HUBSER	CP-X2	W11.03	Oct. 16, 2016	1Year
RF Cable	HUBSER	CP-X1	W12.02	Oct. 16, 2016	1 Year
MI Cable	HUBSER	C10-01-01-1M	1091629	Oct. 16, 2016	1 Year
Test software	Audix	E3	V 6.11111b	/	/
Power Line Conducted Emissions Test					
Test Receiver	R&S	ESU8	100316	Oct. 16, 2016	1 Year
LISN 1	R&S	ENV216	101109	Oct. 16, 2016	1 Year
LISN 2	R&S	ESH2-Z5	100309	Oct. 16, 2016	1 Year
Pulse Limiter	R&S	ESH3-Z2	101242	Oct. 16, 2016	1 Year
CE Cable 1	HUBSER	ESU8/RF2	W10.01	Oct. 16, 2016	1 Year
Test software	Audix	E3	V 6.11111b	/	/

4. 20dB Bandwidth and 99% Bandwidth

4.1. Block diagram of test setup

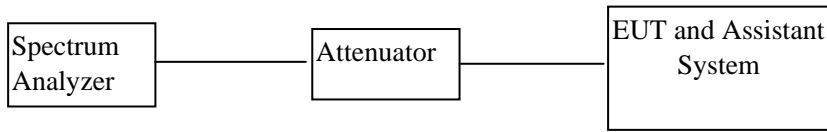

4.2. Limits

Intentional radiators operating under the alternative provisions to the general emission limits, as contained in § 15.217 through 15.257 and in Subpart E of this part, must be designed to ensure that the 20 dB bandwidth of the emission, or whatever bandwidth may otherwise be specified in the specific rule section under which the equipment operates, is contained within the frequency band designated in the rule section under which the equipment is operated.

4.3. Test Procedure

- (1) Connect EUT’s antenna output to spectrum analyzer by RF cable.
- (2) The bandwidth of the fundamental frequency was measured by spectrum analyzer with 100 kHz RBW and 300 kHz VBW. The 20dB bandwidth is defined as the total spectrum the power of which is higher than peak power minus 20dB.

4.4. Test Result

Mode	Freq (MHz)	20dB bandwidth Result (MHz)	99% bandwidth Result (MHz)	Conclusion
Tx mode	LCH: 5743MHz	3.45	3.14	PASS
	MCH: 5791 MHz	3.49	3.24	PASS
	HCH: 5840 MHz	3.53	3.27	PASS
Test Date : May 15, 2016		Test Engineer: Toby		

4.5. Original test data

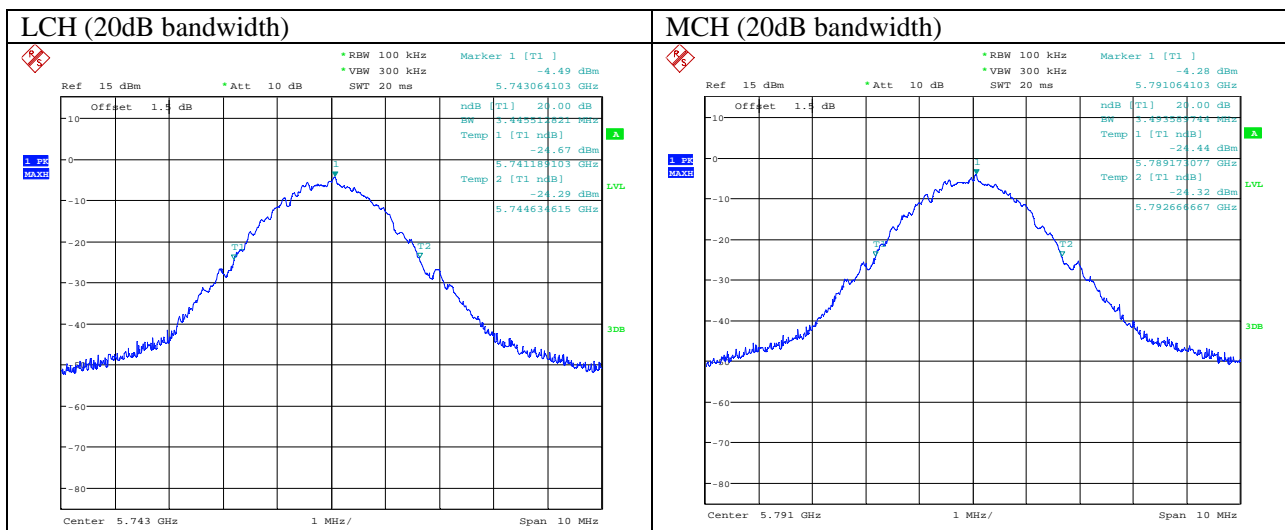

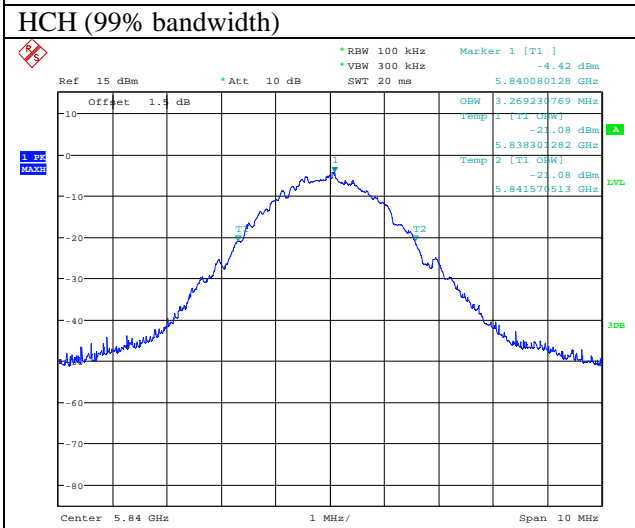
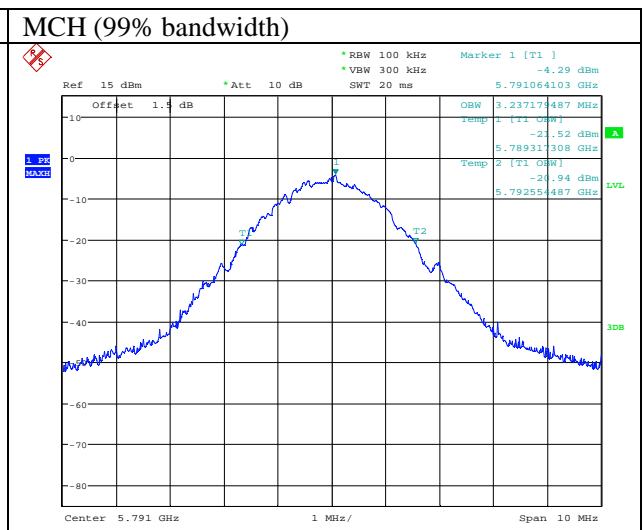
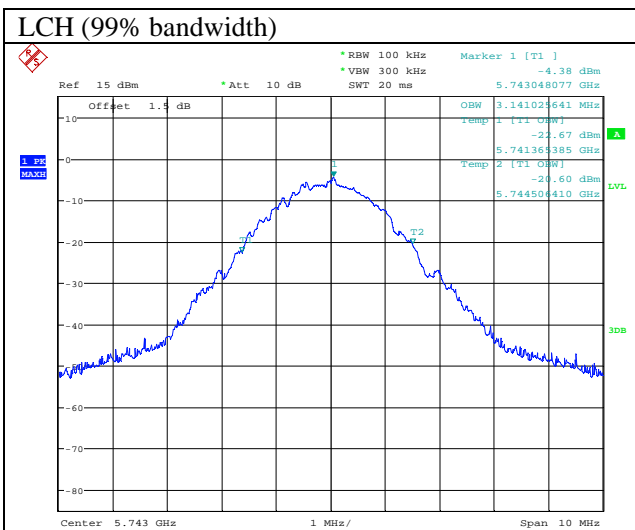
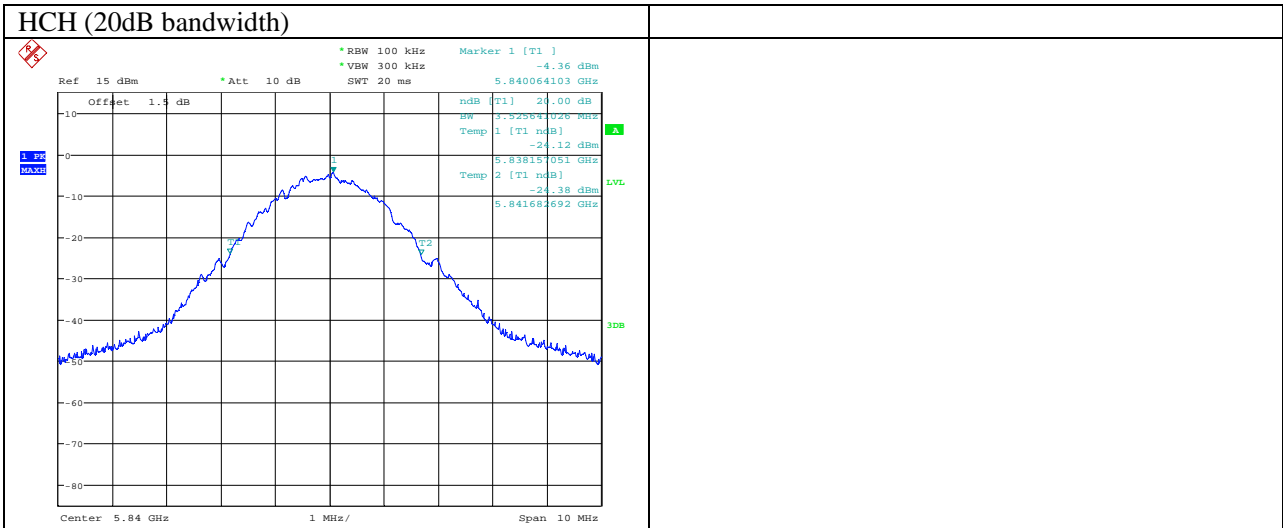

5. Radiated emission

5.1. Block diagram of test setup

In 3m Anechoic Chamber Test Setup Diagram for 9KHz-30MHz

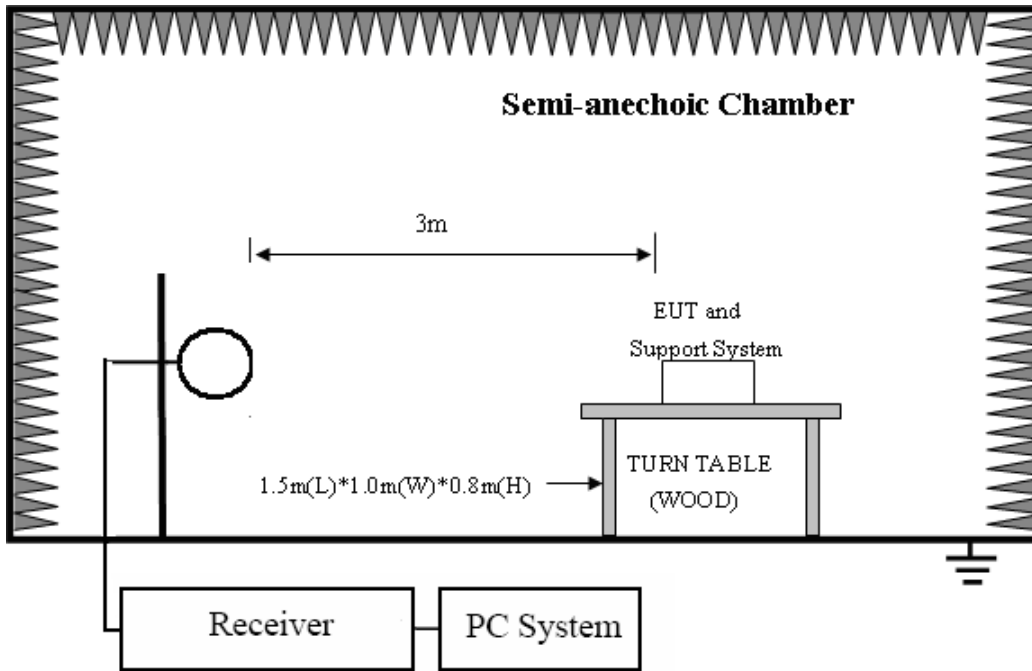

In 3m Anechoic Chamber Test Setup Diagram for below 1GHz

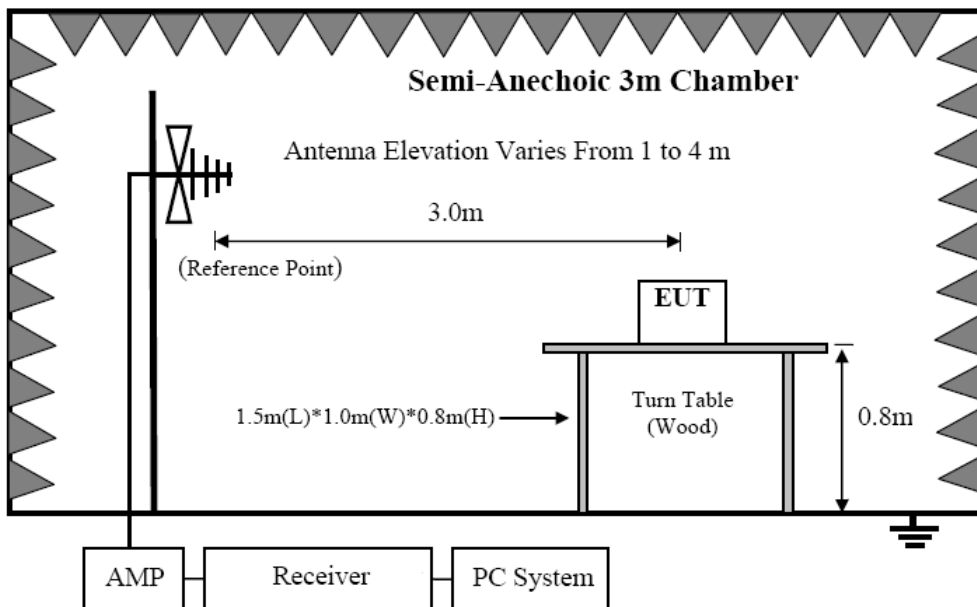

In 3m Anechoic Chamber Test Setup Diagram for frequency above 1GHz

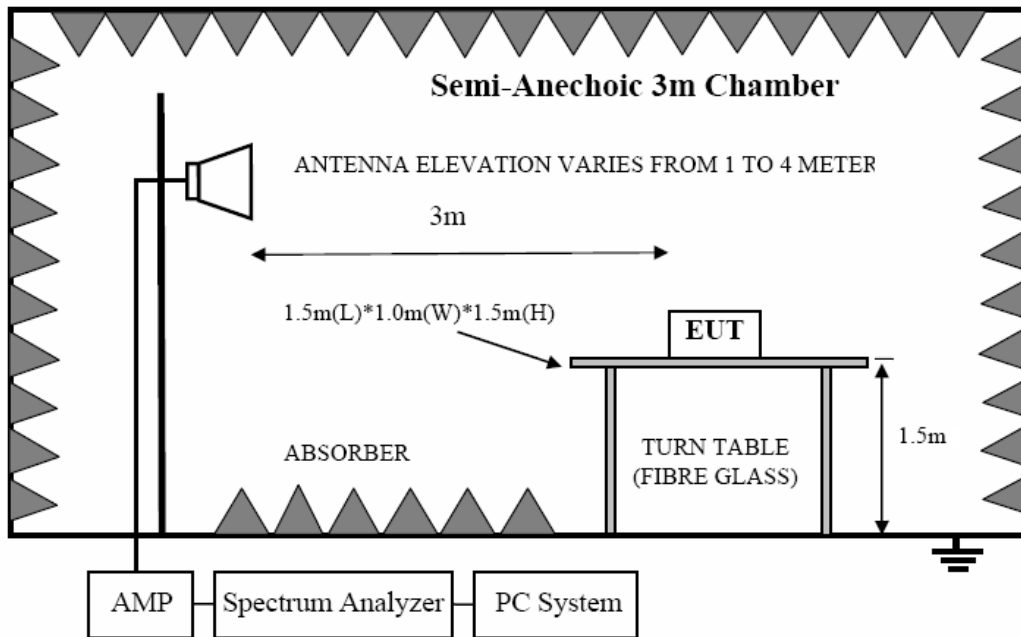

Note: For harmonic emissions test a appropriate high pass filter was inserted in the input port of AMP.

5.2. Limit

5.2.1 FCC 15.205 Restricted frequency band

MHz	MHz	MHz	GHz
0.090 - 0.110	16.42 - 16.423	399.9 - 410	4.5 - 5.15
¹ 0.495 - 0.505	16.69475 - 16.69525	608 - 614	5.35 - 5.46
2.1735 - 2.1905	16.80425 - 16.80475	960 - 1240	7.25 - 7.75
4.125 - 4.128	25.5 - 25.67	1300 - 1427	8.025 - 8.5
4.17725 - 4.17775	37.5 - 38.25	1435 - 1626.5	9.0 - 9.2
4.20725 - 4.20775	73 - 74.6	1645.5 - 1646.5	9.3 - 9.5
6.215 - 6.218	74.8 - 75.2	1660 - 1710	10.6 - 12.7
6.26775 - 6.26825	108 - 121.94	1718.8 - 1722.2	13.25 - 13.4
6.31175 - 6.31225	123 - 138	2200 - 2300	14.47 - 14.5
8.291 - 8.294	149.9 - 150.05	2310 - 2390	15.35 - 16.2
8.362 - 8.366	156.52475 - 156.52525	2483.5 - 2500	17.7 - 21.4
8.37625 - 8.38675	156.7 - 156.9	2690 - 2900	22.01 - 23.12
8.41425 - 8.41475	162.0125 - 167.17	3260 - 3267	23.6 - 24.0
12.29 - 12.293	167.72 - 173.2	3332 - 3339	31.2 - 31.8
12.51975 - 12.52025	240 - 285	3345.8 - 3358	36.43 - 36.5
12.57675 - 12.57725	322 - 335.4	3600 - 4400	(²)

5.2.2 FCC 15.209 Limit.

FREQUENCY MHz	DISTANCE Meters	FIELD STRENGTHS LIMIT	
		μV/m	dB(μV)/m
0.009 ~ 0.490	300	2400/F(KHz)	67.6-20log(F)
0.490 ~ 1.705	30	24000/F(KHz)	87.6-20log(F)
1.705 ~ 30.0	30	30	29.54
30 ~ 88	3	100	40.0
88 ~ 216	3	150	43.5
216 ~ 960	3	200	46.0

960 ~ 1000	3	500	54.0
Above 1000	3	74.0 dB(μ V)/m (Peak) 54.0 dB(μ V)/m (Average)	

Note: (1) The emission limits shown in the above table are based on measurements employing a CISPR QP detector except for the frequency bands 9-90KHz, 110-490KHz and above 1000MHz. Radiated emissions limits in these three bands are based on measurements employing an average detector.

(2) At frequencies below 30MHz, measurement may be performed at a distance closer than that specified, and the limit at closer measurement distance can be extrapolated by below formula:

$$\text{Limit}_{3m}(\text{dB}\mu\text{V}/\text{m}) = \text{Limit}_{30m}(\text{dB}\mu\text{V}/\text{m}) + 40\text{Log}(30\text{m}/3\text{m})$$

5.2.3 Limit for this EUT

All the emissions appearing within 15.205 restricted frequency bands shall not exceed the limits shown in 15.209, all the other emissions shall be at least 20dB below the fundamental emissions, or comply with 15.209 limits.

5.3. Test Procedure

(1) EUT height should be 0.8m for below 1GHz at a semi - anechoic chamber while EUT height should be 1.5m for above 1GHz at full chamber or semi - anechoic chamber ground with absorbers.

(2) Test antenna was located 3m from the EUT on an adjustable mast, and the antenna used as below table.

Test frequency range	Test antenna used
9KHz-30MHz	Active Loop antenna
30MHz-1GHz	Trilog Broadband Antenna
1GHz-18GHz	Double Ridged Horn Antenna(1GHz-18GHz)
18GHz-40GHz	Horn Antenna(18GHz-40GHz)

According ANSI C63.10:2013 clause 6.4.4.2 and 6.5.3, for measurements below 30 MHz, the loop antenna was positioned with its plane vertical from the EUT and rotated about its vertical axis for maximum response at each azimuth position around the EUT. And the loop antenna also be positioned with its plane horizontal at the specified distance from the EUT. The center of the loop is 1 m above the ground. for measurement above 30MHz, the Trilog Broadband Antenna or Horn Antenna was located 3m from EUT, Measurements were made with the antenna positioned in both the horizontal and vertical planes of Polarization, and the measurement antenna was varied from 1 m to 4 m. in height above the reference ground plane to obtain the maximum signal strength.

(3) Below pre-scan procedure was first performed in order to find prominent frequency spectrum radiated emissions from 9KHz to 25GHz:

(a) Scanning the peak frequency spectrum with the antenna specified in step (3), and the EUT was rotated 360 degree, the antenna height was varied from 1m to 4m(Except loop antenna, it's fixed 1m above ground.)

(b) Change work frequency or channel of device if practicable.

(c) Change modulation type of device if practicable.

(d) Change power supply range from 85% to 115% of the rated supply voltage

(e) Rotated EUT though three orthogonal axes to determine the attitude of EUT arrangement produces

highest emissions.

Spectrum frequency from 9KHz to 25GHz (tenth harmonic of fundamental frequency) was investigated, and no any obvious emission were detected from 18GHz to 25GHz, so below final test was performed with frequency range from 9KHz to 18GHz.

- (4) For final emissions measurements at each frequency of interest, the EUT was rotated and the antenna height was varied between 1m and 4m in order to maximize the emission. Measurements in both horizontal and vertical polarities were made and the data was recorded. In order to find the maximum emission, the relative positions of equipments and all of the interface cables were changed according to ANSI C63.10 on Radiated Emission test.
- (5) The emissions from 9KHz to 1GHz were measured based on CISPR QP detector except for the frequency bands 9-90KHz, 110-490KHz, for emissions from 9KHz-90KHz,110KHz-490KHz and above 1GHz were measured based on average detector, for emissions above 1GHz, peak emissions also be measured and need comply with Peak limit.
- (6) The emissions from 9KHz to 1GHz, QP or average values were measured with EMI receiver with below RBW

Frequency band	RBW
9KHz-150KHz	200Hz
150KHz-30MHz	9KHz
30MHz-1GHz	120KHz

- (7) For other emissions above 1GHz, the RBW is set at 1MHz, VBW is set at 3MHz for Peak measure; RMS detector RBW 1MHz VBW 3MHz for Average measure.
- (8) For fundamental frequency test, according to section 4.5 test result of this report, the EUT's BW (max) =3.53MHz, so set spectrum analyzer's RBW=4MHz, VBW=10MHz. peak detector for PK, RMS detector for AV, Read the Level in spectrum analyzer and record.

5.4. Test result

PASS. (See below detailed test result)

All the emissions except fundamental emission from 9 KHz to 25GHz were comply with FCC PART 15.209 limits.

Note1: According exploratory test no any obvious emission were detected from 9KHz to 30MHz and 18GHz to 25GHz, so the final test was performed with frequency range from 30MHz to 18GHz and recorded in below.

Note2: For emissions below 1GHz, according exploratory explorer test, when change Tx mode and channel, have no distinct influence on emissions level, so for emissions below 1GHz, the final test was only performed with EUT working in MCH channel mode.

Note3: For emissions above 1GHz. If peak results comply with AV limit, AV Result is deemed to comply with AV limit.

Radiated Emission test (below 1GHz)

TR-4-E-009 Radiated Emission Test Result

Test Site : DDT 3m Chamber 1# D:\2017 RE1# Report Data\17Q0419-11\RE.EM6
Test Date : 2017-05-11 **Tested By** : Toby
EUT : 2.1 Soundbar with Wireless Subwoofer **Model Number** : Bar 2.1 Soundbar
Power Supply : AC 120V/60Hz **Test Mode** : Tx mode
Condition : Temp:24.5°C,Humi:55%,
 : Press:100.1kPa **Antenna/Distance** : 2016 VULB9163 1#/3m/HORIZONTAL
Memo : Soundbar

Data: 5

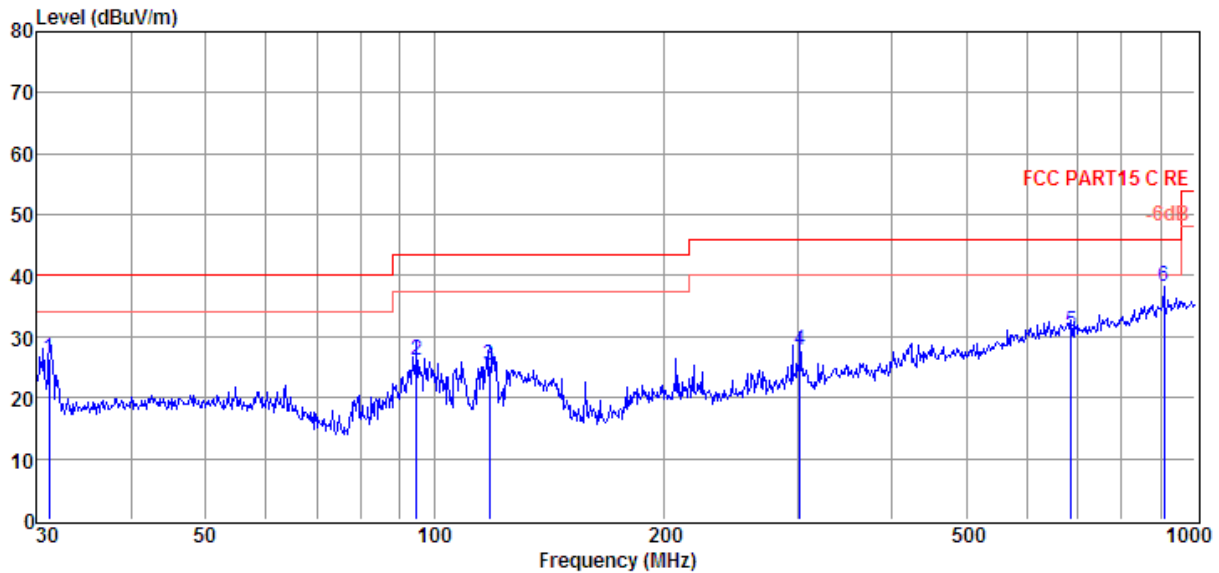

Item (Mark)	Freq. (MHz)	Read Level (dBμV)	Antenna Factor (dB/m)	Cable Loss (dB)	Result Level (dBμV/m)	Limit Line (dBμV/m)	Over Limit (dB)	Detector	Polarization
1	31.18	11.38	11.28	3.68	26.34	40.00	-13.66	QP	HORIZONTAL
2	94.76	10.18	11.56	4.26	26.00	43.50	-17.50	QP	HORIZONTAL
3	118.19	11.18	9.69	4.41	25.28	43.50	-18.22	QP	HORIZONTAL
4	302.48	8.93	13.45	5.39	27.77	46.00	-18.23	QP	HORIZONTAL
5	687.15	4.08	19.83	6.79	30.70	46.00	-15.30	QP	HORIZONTAL
6	909.67	8.36	22.49	7.45	38.30	46.00	-7.70	QP	HORIZONTAL

- Note: 1. Result Level = Read Level + Antenna Factor + Cable loss.
 2. If Peak Result complies with QP limit, QP Result is deemed to comply with QP limit.
 3. Test setup: RBW: 120 kHz, VBW: 300 kHz, Sweep time: auto.

TR-4-E-009 Radiated Emission Test Result

Test Site : DDT 3m Chamber 1# D:\2017 RE1# Report Data\17Q0419-11\RE.EM6
Test Date : 2017-05-11 **Tested By** : Toby
EUT : 2.1 Soundbar with Wireless Subwoofer **Model Number** : Bar 2.1 Soundbar
Power Supply : AC 120V/60Hz **Test Mode** : Tx mode
Condition : Temp:24.5°C,Humi:55%,
 : Press:100.1kPa **Antenna/Distance** : 2016 VULB9163 1#/3m/VERTICAL
Memo : Soundbar

Data: 6

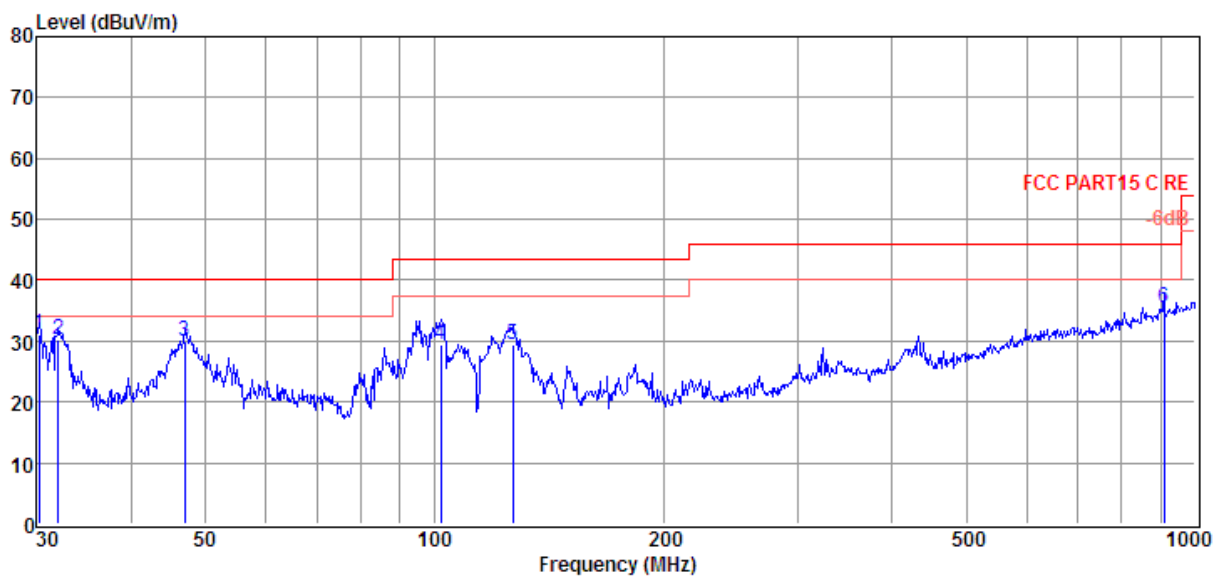

Item (Mark)	Freq. (MHz)	Read Level (dBuV)	Antenna Factor (dB/m)	Cable Loss (dB)	Result Level (dBuV/m)	Limit Line (dBuV/m)	Over Limit (dB)	Detector	Polarization
1	30.21	16.17	11.13	3.67	30.97	40.00	-9.03	QP	VERTICAL
2	32.07	15.02	11.41	3.69	30.12	40.00	-9.88	QP	VERTICAL
3	47.00	13.76	12.25	3.86	29.87	40.00	-10.13	QP	VERTICAL
4	102.00	13.27	11.84	4.31	29.42	43.50	-14.08	QP	VERTICAL
5	126.77	16.87	8.09	4.46	29.42	43.50	-14.08	QP	VERTICAL
6	909.67	5.62	22.49	7.45	35.56	46.00	-10.44	QP	VERTICAL

- Note: 1. Result Level = Read Level + Antenna Factor + Cable loss.
 2. If Peak Result complies with QP limit, QP Result is deemed to comply with QP limit.
 3. Test setup: RBW: 120 kHz, VBW: 300 kHz, Sweep time: auto.

Radiated Emission test (above 1GHz)

Freq (MHz)	Read level (dB μ V)	Antenna Factor (dB/m)	PRM Factor (dB)	Cable Loss (dB)	Result Level (dB μ V/m)	Limit (dB μ V/m)	Margi n (dB)	Detector type	Polarization
Tx mode 5743 MHz									
4791.00	35.31	33.74	29.31	8.46	48.20	74.00	-25.80	Peak	HORIZONTAL
5743.00	73.60	34.84	29.22	9.41	88.63	94.00	-5.37	Average	HORIZONTAL
5743.00	76.28	34.84	29.22	9.41	91.31	114.00	-22.69	Peak	HORIZONTAL
6474.00	34.36	35.76	29.78	9.93	50.27	74.00	-23.73	Peak	HORIZONTAL
9041.00	34.52	37.41	32.34	11.85	51.44	74.00	-22.56	Peak	HORIZONTAL
13036.00	34.72	38.84	35.69	14.68	52.55	74.00	-21.45	Peak	HORIZONTAL
1544.00	46.20	25.85	29.11	4.96	47.90	74.00	-26.10	Peak	VERTICAL
5743.00	75.01	34.84	29.22	9.41	90.04	94.00	-3.96	Average	VERTICAL
5743.00	77.70	34.84	29.22	9.41	92.73	114.00	-21.27	Peak	VERTICAL
8004.00	35.19	36.69	31.15	11.14	51.87	74.00	-22.13	Peak	VERTICAL
8990.00	35.43	37.46	32.32	11.81	52.38	74.00	-21.62	Peak	VERTICAL
13206.00	35.05	39.01	35.54	14.72	53.24	74.00	-20.76	Peak	VERTICAL
Tx mode 5791 MHz									
4026.00	35.42	33.42	29.04	7.63	47.43	74.00	-26.57	Peak	HORIZONTAL
5791.00	71.99	34.88	29.21	9.48	87.14	94.00	-6.86	Average	HORIZONTAL
5791.00	75.39	34.88	29.21	9.48	90.54	114.00	-23.46	Peak	HORIZONTAL
7800.00	34.64	36.66	31.04	11.02	51.28	74.00	-22.72	Peak	HORIZONTAL
8871.00	34.43	36.94	32.22	11.77	50.92	74.00	-23.08	Peak	HORIZONTAL
13036.00	34.76	38.84	35.69	14.68	52.59	74.00	-21.41	Peak	HORIZONTAL
3890.00	36.02	33.09	29.10	7.54	47.55	74.00	-26.45	Peak	VERTICAL
5791.00	72.15	34.88	29.21	9.48	87.30	94.00	-6.70	Average	VERTICAL
5791.00	75.46	34.88	29.21	9.48	90.61	114.00	-23.39	Peak	VERTICAL
7936.00	35.39	36.69	31.11	11.10	52.07	74.00	-21.93	Peak	VERTICAL
10639.00	34.14	36.80	33.40	12.91	50.45	74.00	-23.55	Peak	VERTICAL
13342.00	34.27	39.14	35.42	14.76	52.75	74.00	-21.25	Peak	VERTICAL
Tx mode 5840 MHz									
4689.00	34.93	33.76	29.29	8.35	47.75	74.00	-26.25	Peak	HORIZONTAL
5840.00	73.19	34.91	29.20	9.54	88.44	94.00	-5.56	Average	HORIZONTAL
5840.00	76.44	34.91	29.20	9.54	91.69	114.00	-22.31	Peak	HORIZONTAL
6899.00	36.01	36.12	30.31	10.33	52.15	74.00	-21.85	Peak	HORIZONTAL
8004.00	34.50	36.69	31.15	11.14	51.18	74.00	-22.82	Peak	HORIZONTAL
13359.00	34.86	39.16	35.38	14.76	53.40	74.00	-20.60	Peak	HORIZONTAL
1544.00	46.53	25.85	29.11	4.96	48.23	74.00	-25.77	Peak	VERTICAL
5840.00	73.57	34.91	29.20	9.54	88.82	94.00	-5.18	Average	VERTICAL
5840.00	77.59	34.91	29.20	9.54	92.84	114.00	-21.16	Peak	VERTICAL
8004.00	30.40	36.69	31.15	11.14	47.08	74.00	-26.92	Peak	VERTICAL
11455.00	30.23	36.80	34.49	13.57	46.11	74.00	-27.89	Peak	VERTICAL
14124.00	31.00	40.05	34.84	15.18	51.39	74.00	-22.61	Peak	VERTICAL
Result: Pass									

Note: Result Level = Read Level + Antenna Factor + Cable loss - PRM Factor.

6. Band Edge Compliance (radiated method)

6.1. Block diagram of test setup

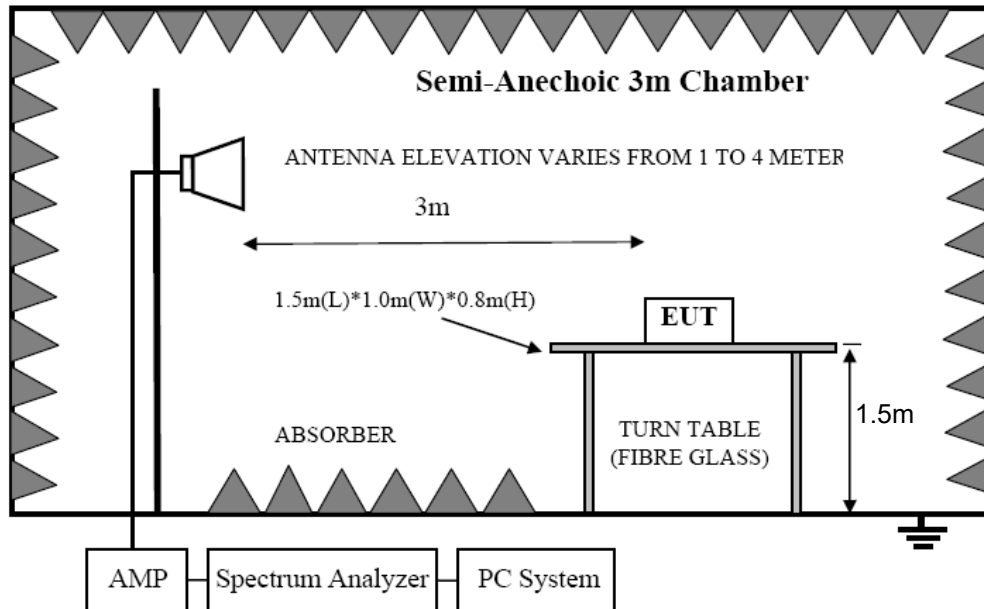

6.2. Limit

All restriction band should comply with 15.209, other emission should be at least 20dB below the fundamental.

6.3. Test Procedure

Same with clause 5.3 except change investigated frequency range from 5700MHz to 5760MHz and 5830MHz to 5900MHz.

Remark: All restriction band have been tested, and only the worse case is shown in report.

6.4. Test result

PASS. (See below detailed test result)

TR-4-E-009 Radiated Emission Test Result

Test Site	: DDT 3m Chamber 1#		D:\2017 RE1# Report Data\17Q0419-11\RE.EM6
Test Date	: 2017-05-18	Tested By	: Toby
EUT	: 2.1 Soundbar with Wireless Subwoofer	Model Number	: Bar 2.1 Soundbar
Power Supply	: AC 120V/60Hz	Test Mode	: Tx mode 5840 MHz
Condition	: Temp:24.5°C,Humi:55%, Press:100.1kPa	Antenna/Distance	: 2016 HF907/3m/HORIZONTAL
Memo	: Soundbar		

Data: 119

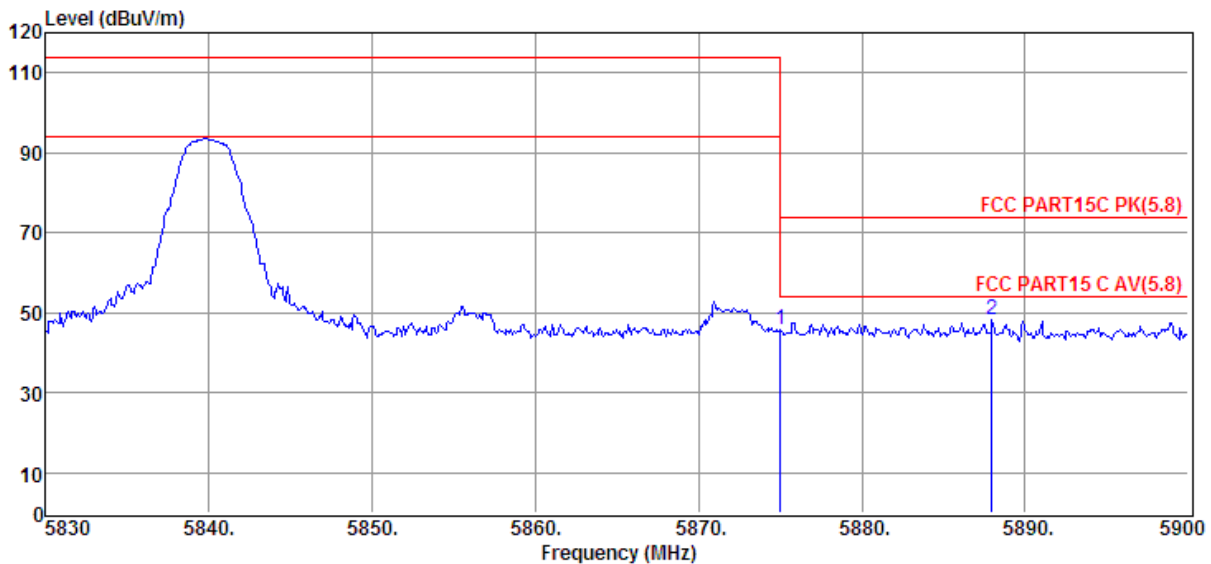

Item (Mark)	Freq. (MHz)	Read Level (dBμV)	Antenna Factor (dB/m)	PRM Factor dB	Cable Loss dB	Result Level (dBμV/m)	Limit Line (dBμV/m)	Over Limit (dB)	Detector	Polarization
1	5875.00	30.62	34.93	29.20	9.56	45.91	74.00	-28.09	Peak	HORIZONTAL
2	5887.96	32.73	34.94	29.20	9.59	48.06	74.00	-25.94	Peak	HORIZONTAL

- Note: 1. Result Level = Read Level + Antenna Factor + Cable loss - PRM Factor.
 2. If Peak Result complies with AV limit, AV Result is deemed to comply with AV limit.
 3. Test setup: RBW: 1 MHz, VBW: 3 MHz, Sweep time: auto.

TR-4-E-009 Radiated Emission Test Result

Test Site : DDT 3m Chamber 1# D:\2017 RE1# Report Data\17Q0419-11\RE.EM6
Test Date : 2017-05-18 **Tested By** : Toby
EUT : 2.1 Soundbar with Wireless Subwoofer **Model Number** : Bar 2.1 Soundbar
Power Supply : AC 120V/60Hz **Test Mode** : Tx mode 5840 MHz
Condition : Temp:24.5°C,Humi:55%,
 Press:100.1kPa **Antenna/Distance** : 2016 HF907/3m/VERTICAL
Memo : Soundbar

Data: 120

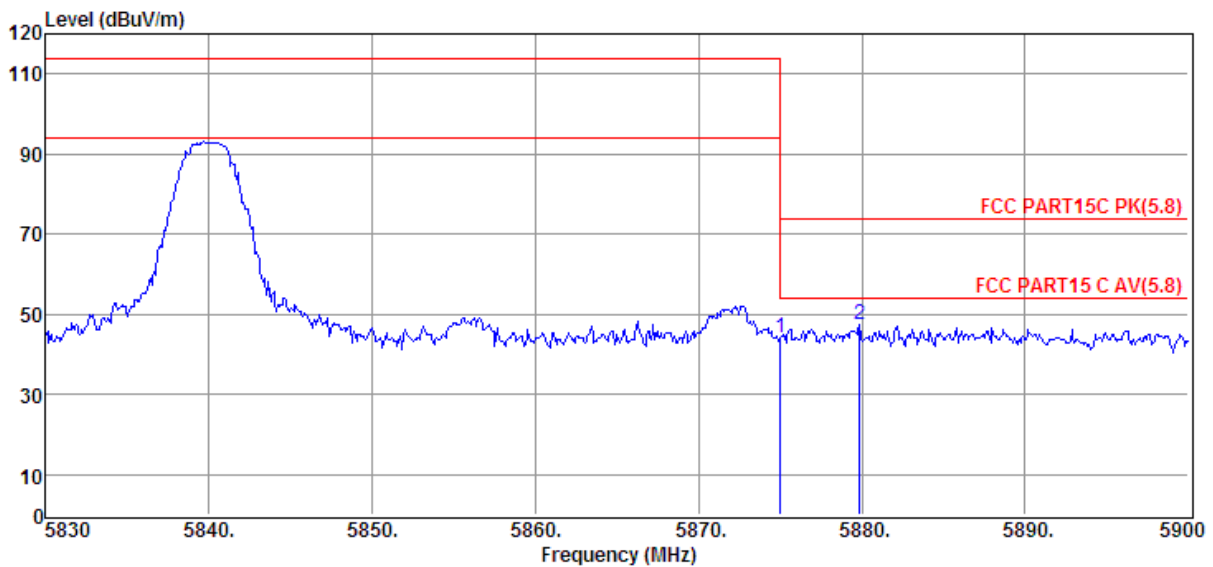

Item (Mark)	Freq. (MHz)	Read Level (dBμV)	Antenna Factor (dB/m)	PRM Factor dB	Cable Loss dB	Result Level (dBμV/m)	Limit Line (dBμV/m)	Over Limit (dB)	Detector	Polarization
1	5875.00	29.03	34.93	29.20	9.56	44.32	74.00	-29.68	Peak	VERTICAL
2	5879.84	32.12	34.93	29.20	9.56	47.41	74.00	-26.59	Peak	VERTICAL

Note: 1. Result Level = Read Level + Antenna Factor + Cable loss - PRM Factor.
 2. If Peak Result complies with AV limit, AV Result is deemed to comply with AV limit.
 3. Test setup: RBW: 1 MHz, VBW: 3 MHz, Sweep time: auto.

TR-4-E-009 Radiated Emission Test Result

Test Site	: DDT 3m Chamber 1#	Tested By	: Toby
Test Date	: 2017-05-18	Model Number	: Bar 2.1 Soundbar
EUT	: 2.1 Soundbar with Wireless Subwoofer	Test Mode	: Tx mode 5743 MHz
Power Supply	: AC 120V/60Hz	Antenna/Distance	: 2016 HF907/3m/VERTICAL
Condition	: Temp:24.5°C,Humi:55%, Press:100.1kPa		
Memo	: Soundbar		

Data: 121

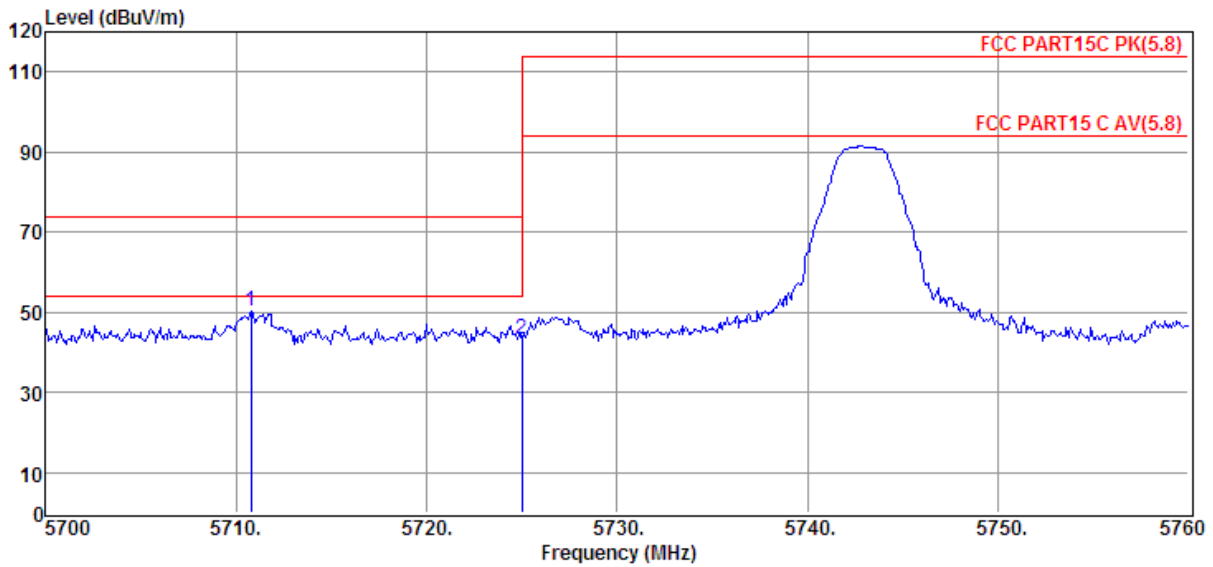

Item (Mark)	Freq. (MHz)	Read Level (dBμV)	Antenna Factor (dB/m)	PRM Factor dB	Cable Loss dB	Result Level (dBμV/m)	Limit Line (dBμV/m)	Over Limit (dB)	Detector	Polarization
1	5710.80	35.09	34.83	29.22	9.41	50.11	74.00	-23.89	Peak	VERTICAL
2	5725.00	28.46	34.84	29.22	9.41	43.49	74.00	-30.51	Peak	VERTICAL

- Note: 1. Result Level = Read Level + Antenna Factor + Cable loss - PRM Factor.
 2. If Peak Result complies with AV limit, AV Result is deemed to comply with AV limit.
 3. Test setup: RBW: 1 MHz, VBW: 3 MHz, Sweep time: auto.

TR-4-E-009 Radiated Emission Test Result

Test Site : DDT 3m Chamber 1#	D:\2017 RE1# Report Data\17Q0419-11\RE.EM6
Test Date : 2017-05-18	Tested By : Toby
EUT : 2.1 Soundbar with Wireless Subwoofer	Model Number : Bar 2.1 Soundbar
Power Supply : AC 120V/60Hz	Test Mode : Tx mode 5743 MHz
Condition : Temp:24.5°C,Humi:55%, Press:100.1kPa	Antenna/Distance : 2016 HF907/3m/HORIZONTAL
Memo : Soundbar	

Data: 122

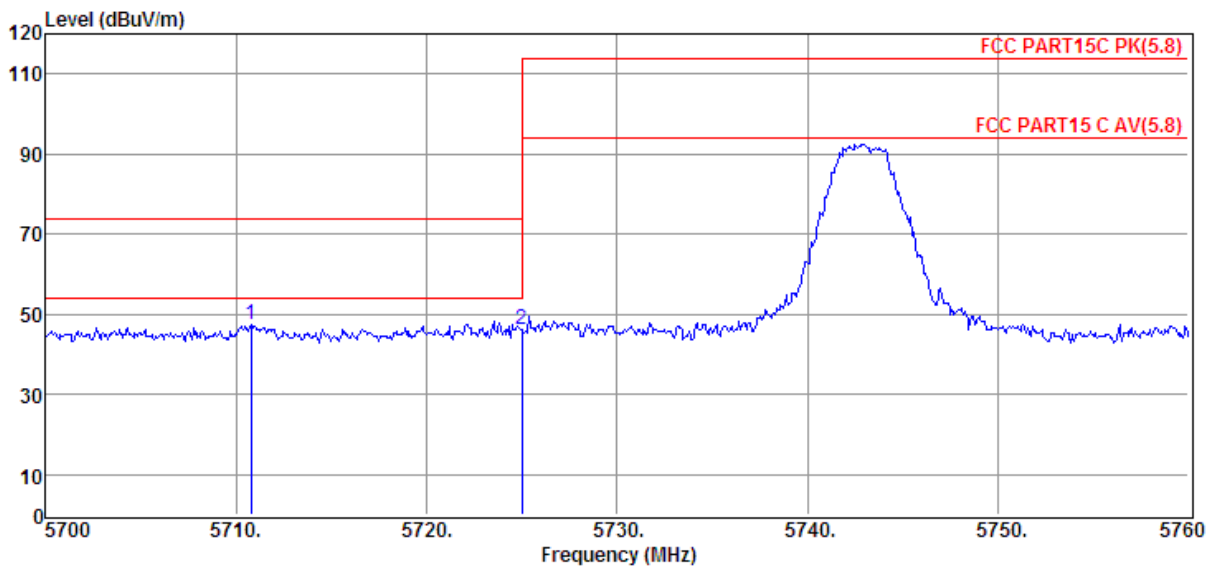

Item (Mark)	Freq. (MHz)	Read Level (dBμV)	Antenna Factor (dB/m)	PRM Factor dB	Cable Loss dB	Result Level (dBμV/m)	Limit Line (dBμV/m)	Over Limit (dB)	Detector	Polarization
1	5710.80	32.59	34.83	29.22	9.41	47.61	74.00	-26.39	Peak	HORIZONTAL
2	5725.00	31.21	34.84	29.22	9.41	46.24	74.00	-27.76	Peak	HORIZONTAL

Note: 1. Result Level = Read Level + Antenna Factor + Cable loss - PRM Factor.
 2. If Peak Result complies with AV limit, AV Result is deemed to comply with AV limit.
 3. Test setup: RBW: 1 MHz, VBW: 3 MHz, Sweep time: auto.

7. Power Line Conducted Emission

7.1. Block diagram of test setup

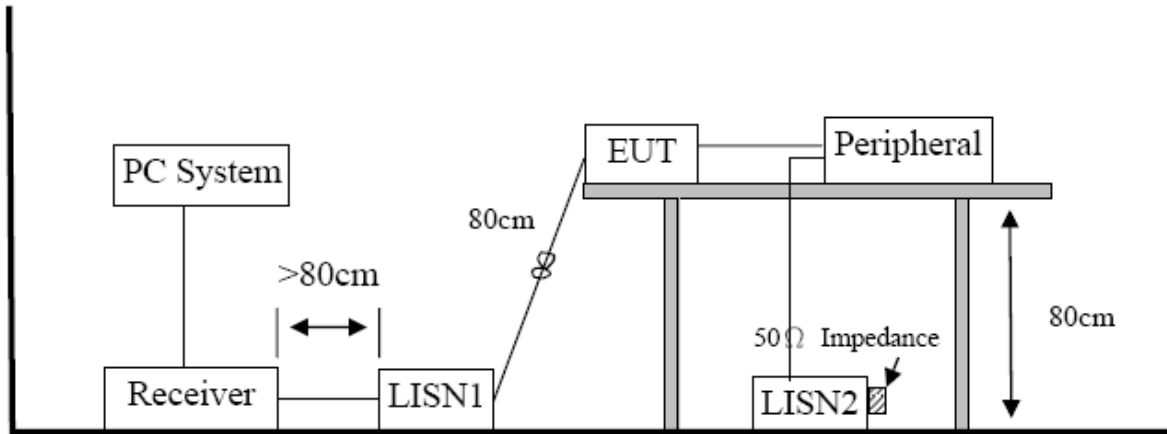

7.2. Power Line Conducted Emission Limits(Class B)

Frequency	Quasi-Peak Level dB(μ V)	Average Level dB(μ V)
150kHz ~ 500kHz	66 ~ 56*	56 ~ 46*
500kHz ~ 5MHz	56	46
5MHz ~ 30MHz	60	50

Note 1: * Decreasing linearly with logarithm of frequency.

Note 2: The lower limit shall apply at the transition frequencies.

7.3. Test Procedure

The EUT and Support equipment, if needed, were put placed on a non-metallic table, 80cm above the ground plane.

All I/O cables were positioned to simulate typical actual usage as per ANSI C63.4.

All support equipment power received from a second LISN.

Emissions were measured on each current carrying line of the EUT using an EMI Test Receiver connected to the LISN powering the EUT.

The Receiver scanned from 150 kHz to 30MHz for emissions in each of the test modes.

During the above scans, the emissions were maximized by cable manipulation.

The test mode(s) described in clause 2.4 were scanned during the preliminary test.

After the preliminary scan, we found the test mode producing the highest emission level.

The EUT configuration and worse cable configuration of the above highest emission levels were recorded for reference of the final test.

EUT and support equipment were set up on the test bench as per the configuration with highest emission level in the preliminary test.

A scan was taken on both power lines, Neutral and Line, recording at least the six highest emissions.

Emission frequency and amplitude were recorded into a computer in which correction factors were used to calculate the emission level and compare reading to the applicable limit.

The test data of the worst-case condition(s) was recorded.

The bandwidth of test receiver is set at 9 KHz.

7.4. Test Result

PASS. (See below detailed test result)

TR-4-E-010 Conducted Emission Test Result

Test Site	: DDT 1# Shield Room	E:\2017 CE Test Data\H\Harman\20170420CE Bar 2.1
Test Date	: 2017-05-13	Tested By : Sunny
EUT	: 2.1 Soundbar with Wireless Subwoofer	Model Number : Bar 2.1 Soundbar
Power Supply	: AC 120V/60Hz	Test Mode : Tx mode
Condition	: Temp:24.5°C,Humi:55%, Press:100.1kPa	LISN : 2016 ENV216/LINE
Memo	: Soudbar AC Port	

Data: 106

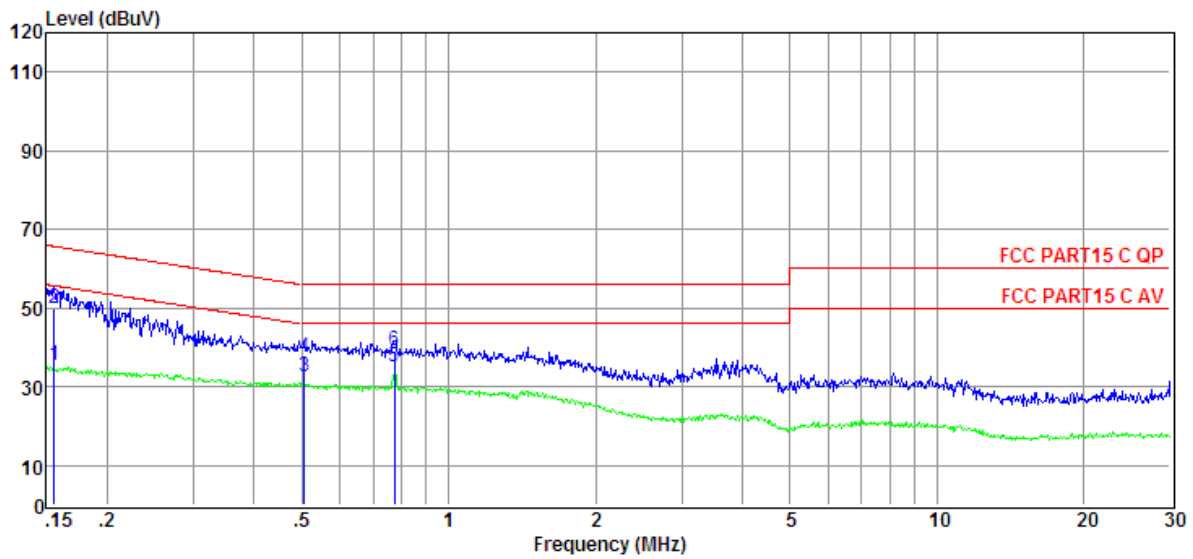

Item (Mark)	Freq. (MHz)	Read Level (dBμV)	LISN Factor (dB)	Cable Loss (dB)	Pulse Limiter Factor (dB)	Result Level (dBμV)	Limit Line (dBμV)	Over Limit (dB)	Detector	Phase
1	0.16	15.99	9.61	0.02	9.86	35.48	55.69	-20.21	Average	LINE
2	0.16	30.37	9.61	0.02	9.86	49.86	65.69	-15.83	QP	LINE
3	0.51	13.15	9.61	0.02	9.86	32.64	46.00	-13.36	Average	LINE
4	0.51	18.00	9.61	0.02	9.86	37.49	56.00	-18.51	QP	LINE
5	0.78	15.43	9.61	0.03	9.86	34.93	46.00	-11.07	Average	LINE
6	0.78	19.74	9.61	0.03	9.86	39.24	56.00	-16.76	QP	LINE

- Note: 1. Result Level = Read Level + LISN Factor + Pulse Limiter Factor + Cable loss.
 2. If QP Result complies with AV limit, AV Result is deemed to comply with AV limit.
 3. Test setup: RBW: 200 Hz (9 kHz—150 kHz), 9 kHz (150 kHz—30 MHz).
 4. Step size: 80Hz (0.009MHz-0.15MHz), 4 kHz (0.15MHz-30MHz), Scan time: auto.

TR-4-E-010 Conducted Emission Test Result

Test Site : DDT 1# Shield Room E:\2017 CE Test Data\H\Harman\20170420CE Bar 2.1
Test Date : 2017-05-13 **Tested By** : Sunny
EUT : 2.1 Soundbar with Wireless Subwoofer **Model Number** : Bar 2.1 Soundbar
Power Supply : AC 120V/60Hz **Test Mode** : Tx mode
Condition : Temp:24.5'C,Humi:55%,
LISN : 2016 ENV216/NEUTRAL
 Press:100.1kPa
Memo : Soudbar AC Port

Data: 108

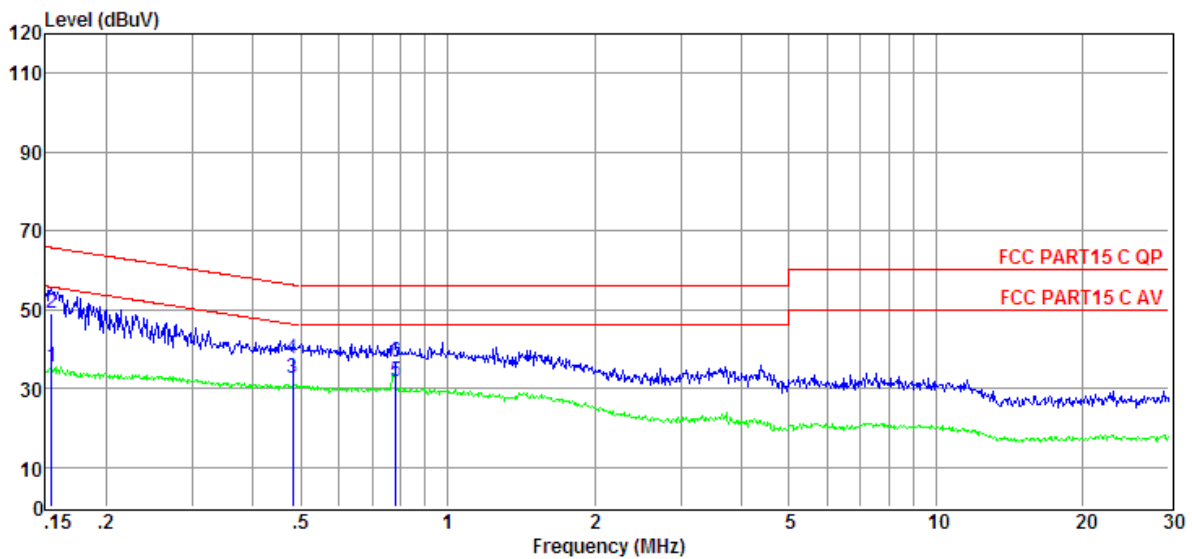

Item (Mark)	Freq. (MHz)	Read Level (dBμV)	LISN Factor (dB)	Cable Loss (dB)	Pulse Limiter Factor (dB)	Result Level (dBμV)	Limit Line (dBμV)	Over Limit (dB)	Detector	Phase
1	0.15	16.04	9.61	0.02	9.86	35.53	55.74	-20.21	Average	NEUTRAL
2	0.15	29.50	9.61	0.02	9.86	48.99	65.74	-16.75	QP	NEUTRAL
3	0.48	13.04	9.61	0.02	9.86	32.53	46.32	-13.79	Average	NEUTRAL
4	0.48	18.03	9.61	0.02	9.86	37.52	56.32	-18.80	QP	NEUTRAL
5	0.78	12.41	9.61	0.03	9.86	31.91	46.00	-14.09	Average	NEUTRAL
6	0.78	17.08	9.61	0.03	9.86	36.58	56.00	-19.42	QP	NEUTRAL

- Note: 1. Result Level = Read Level + LISN Factor + Pulse Limiter Factor + Cable loss.
 2. If QP Result complies with AV limit, AV Result is deemed to comply with AV limit.
 3. Test setup: RBW: 200 Hz (9 kHz—150 kHz), 9 kHz (150 kHz—30 MHz).
 4. Step size: 80Hz (0.009MHz-0.15MHz), 4 kHz (0.15MHz-30MHz), Scan time: auto.

8. Antenna Requirements

8.1. Limit

For intentional device, according to FCC 47 CFR Section 15.203, an intentional radiator shall be designed to ensure that no antenna other than that furnished by the responsible party shall be used with the device.

8.2. Result

The antennas used for this product are Integrated PCB antenna and that no antenna other than that furnished by the responsible party shall be used with the device, the maximum peak gain of the transmit antenna is only 2.85dBi.