



**SGS-CSTC Standards Technical Services Co., Ltd.
Shenzhen Branch**

No. 1 Workshop, M-10, Middle section, Science & Technology Park,
Shenzhen, Guangdong, China 518057

Telephone: +86 (0) 755 2601 2053
Fax: +86 (0) 755 2671 0594
Email: ee.shenzhen@sgs.com

Report No.: SZEM180500405704
Page: 1 of 639

TEST REPORT

Application No.: SZEM1805004057CR
Applicant: Harman International Industries, Inc.
Address of Applicant: 8500 Balboa Boulevard, Northridge, California, 91329, United States
Manufacturer: Harman International Industries, Inc.
Address of Manufacturer: 8500 Balboa Boulevard, Northridge, California, 91329, United States
Factory:
1. Shenzhen 3Nod Digital Technology Co., Ltd.
2. Guangxi 3Nod Digital Technology Co., Ltd.
Address of Factory:
1. 4/F., and Section A, 1/F., Workshop 15, Zhongfu Road, Tangxiayong Community, Songgang Neighbourhood, Bao'an, Shenzhen, Guangdong, China
2. The B02 Plant Building of 3nod Smart Industrial Park in Beihai Industrial Park, East of Jilin Road, North of Longtoujiang Reservoir, Guangxi, P.R China
Equipment Under Test (EUT):
EUT Name: Wireless Speaker
Model No.: CITATION 300
Trade mark: harman/kardon
FCC ID: APIHKCT300
Standard(s) : 47 CFR Part 15, Subpart E 15.407
Date of Receipt: 2018-05-21
Date of Test: 2018-05-25 to 2018-07-19
Date of Issue: 2018-07-23

Test Result:	Pass*
---------------------	--------------

* In the configuration tested, the EUT complied with the standards specified above.





Keny Xu
EMC Laboratory Manager

The manufacturer should ensure that all products in series production are in conformity with the product sample detailed in this report. If the product in this report is used in any configuration other than that detailed in the report, the manufacturer must ensure the new system complies with all relevant standards. Any mention of SGS International Electrical Approvals or testing done by SGS International Electrical Approvals in connection with, distribution or use of the product described in this report must be approved by SGS International Electrical Approvals in writing.

This document is issued by the Company subject to its General Conditions of Service printed overleaf, available on request or accessible at <http://www.sgs.com/en/Terms-and-Conditions.aspx> and, for electronic format documents, subject to Terms and Conditions for Electronic Documents at <http://www.sgs.com/en/Terms-and-Conditions/Terms-e-Documents.aspx>. Attention is drawn to the limitation of liability, indemnification and jurisdiction issues defined therein. Any holder of this document is advised that information contained hereon reflects the Company's findings at the time of its intervention only and within the limits of Client's instructions, if any. The Company's sole responsibility is to its Client and this document does not exonerate parties to a transaction from exercising all their rights and obligations under the transaction documents. This document cannot be reproduced except in full, without prior written approval of the Company. Any unauthorized alteration, forgery or falsification of the content or appearance of this document is unlawful and offenders may be prosecuted to the fullest extent of the law. Unless otherwise stated the results shown in this test report refer only to the sample(s) tested and such sample(s) are retained for 30 days only.



<i>Revision Record</i>				
<i>Version</i>	<i>Chapter</i>	<i>Date</i>	<i>Modifier</i>	<i>Remark</i>
01		2018-07-23		Original

Authorized for issue by:				
				
		<hr/>		
		Benson Wang /Project Engineer		
				
		<hr/>		
		Eric Fu /Reviewer		



2 Test Summary

Radio Spectrum Technical Requirement				
Item	Standard	Method	Requirement	Result
Antenna Requirement	47 CFR Part 15, Subpart E 15.407	N/A	47 CFR Part 15, Subpart C 15.203	Pass
Transmission in the Absence of Data	47 CFR Part 15, Subpart E 15.407	N/A	47 CFR Part 15, Subpart C 15.407 (c)	Pass

N/A: Not applicable

Radio Spectrum Matter Part				
Item	Standard	Method	Requirement	Result
Conducted Emissions at AC Power Line (150kHz-30MHz)	47 CFR Part 15, Subpart E 15.407	ANSI C63.10 (2013) Section 6.2	47 CFR Part 15, Subpart C 15.207 & 15.407 b(6)	Pass
Duty Cycle	47 CFR Part 15, Subpart E 15.407	KDB 789033 II B 1	KDB 789033 D02 II B 1	Pass
99% Bandwidth	47 CFR Part 15, Subpart E 15.407	KDB 789033 II D	N/A	Pass
26dB Emission bandwidth	47 CFR Part 15, Subpart E 15.407	KDB 789033 D02 II C 1	47 CFR Part 15, Subpart C 15.407 (a)	Pass
Minimum 6 dB bandwidth (5.725-5.85 GHz band)	47 CFR Part 15, Subpart E 15.407	KDB 789033 D02 II C 2	47 CFR Part 15, Subpart C 15.407 (e)	Pass
Maximum Conducted output power	47 CFR Part 15, Subpart E 15.407	KDB 789033 D02 II E	47 CFR Part 15, Subpart C 15.407 (a)	Pass
Peak Power spectrum density	47 CFR Part 15, Subpart E 15.407	KDB 789033 D02 II F	47 CFR Part 15, Subpart C 15.407 (a)	Pass
DFS: Non-occupancy period	47 CFR Part 15, Subpart E 15.407	KDB 905462 D02 Section 7.8.3	KDB 905462 D02 Section 5.1	Pass
DFS: Channel Move Time	47 CFR Part 15, Subpart E 15.407	KDB 905462 D02 Section 7.8.3	KDB 905462 D02 Section 5.1	Pass
DFS: Channel Closing Transmission Time	47 CFR Part 15, Subpart E 15.407	KDB 905462 D02 Section 7.8.3	KDB 905462 D02 Section 5.1	Pass
Radiated Emissions	47 CFR Part 15, Subpart E 15.407	KDB 789033 D02 II G	47 CFR Part 15, Subpart C 15.209 & 15.407(b)	Pass
Radiated Emissions which fall in the restricted bands	47 CFR Part 15, Subpart E 15.407	KDB 789033 D02 II G	47 CFR Part 15, Subpart C 15.209 & 15.407(b)	Pass
Frequency Stability	47 CFR Part 15, Subpart E 15.407	ANSI C63.10 (2013) Section 6.8	47 CFR Part 15, Subpart C 15.407 (g)	Pass

N/A: Not applicable



3 Contents

	Page
1 COVER PAGE	1
2 TEST SUMMARY	3
3 CONTENTS	4
4 GENERAL INFORMATION	6
4.1 DETAILS OF E.U.T.	6
4.2 DESCRIPTION OF SUPPORT UNITS	8
4.3 MEASUREMENT UNCERTAINTY	8
4.4 TEST LOCATION.....	9
4.5 TEST FACILITY.....	9
4.6 DEVIATION FROM STANDARDS.....	9
4.7 ABNORMALITIES FROM STANDARD CONDITIONS	9
5 EQUIPMENT LIST	10
6 RADIO SPECTRUM TECHNICAL REQUIREMENT	14
6.1 ANTENNA REQUIREMENT	14
6.1.1 <i>Test Requirement:</i>	14
6.1.2 <i>Conclusion</i>	14
6.2 TRANSMISSION IN THE ABSENCE OF DATA.....	15
6.2.1 <i>Test Requirement:</i>	15
6.2.2 <i>Conclusion</i>	15
7 RADIO SPECTRUM MATTER TEST RESULTS	16
7.1 CONDUCTED EMISSIONS AT AC POWER LINE (150KHZ-30MHZ).....	16
7.1.1 <i>E.U.T. Operation</i>	17
7.1.2 <i>Test Setup Diagram</i>	18
7.1.3 <i>Measurement Procedure and Data</i>	18
7.2 DUTY CYCLE	21
7.2.1 <i>E.U.T. Operation</i>	21
7.2.2 <i>Test Setup Diagram</i>	21
7.2.3 <i>Measurement Procedure and Data</i>	21
7.3 99% BANDWIDTH	22
7.3.1 <i>E.U.T. Operation</i>	22
7.3.2 <i>Test Setup Diagram</i>	23
7.3.3 <i>Measurement Procedure and Data</i>	23
7.4 26dB EMISSION BANDWIDTH	24
7.4.1 <i>E.U.T. Operation</i>	24
7.4.2 <i>Test Setup Diagram</i>	25
7.4.3 <i>Measurement Procedure and Data</i>	25
7.5 MINIMUM 6 DB BANDWIDTH (5.725-5.85 GHZ BAND)	26
7.5.1 <i>E.U.T. Operation</i>	26
7.5.2 <i>Test Setup Diagram</i>	26
7.5.3 <i>Measurement Procedure and Data</i>	26
7.6 MAXIMUM CONDUCTED OUTPUT POWER.....	27
7.6.1 <i>E.U.T. Operation</i>	28
7.6.2 <i>Test Setup Diagram</i>	29
7.6.3 <i>Measurement Procedure and Data</i>	29



7.7	PEAK POWER SPECTRUM DENSITY.....	30
7.7.1	<i>E.U.T. Operation</i>	31
7.7.2	<i>Test Setup Diagram</i>	32
7.7.3	<i>Measurement Procedure and Data</i>	32
7.8	DFS: NON-OCCUPANCY PERIOD.....	33
7.8.1	<i>E.U.T. Operation</i>	33
7.8.2	<i>Test Setup Diagram</i>	34
7.8.3	<i>Measurement Procedure and Data</i>	35
7.9	DFS: CHANNEL MOVE TIME.....	36
7.9.1	<i>E.U.T. Operation</i>	36
7.9.2	<i>Test Setup Diagram</i>	37
7.9.3	<i>Measurement Procedure and Data</i>	38
7.10	DFS: CHANNEL CLOSING TRANSMISSION TIME.....	39
7.10.1	<i>E.U.T. Operation</i>	39
7.10.2	<i>Test Setup Diagram</i>	40
7.10.3	<i>Measurement Procedure and Data</i>	41
7.11	RADIATED EMISSIONS.....	42
7.11.1	<i>E.U.T. Operation</i>	43
7.11.2	<i>Test Setup Diagram</i>	44
7.11.3	<i>Measurement Procedure and Data</i>	45
7.12	RADIATED EMISSIONS WHICH FALL IN THE RESTRICTED BANDS.....	166
7.12.1	<i>E.U.T. Operation</i>	167
7.12.2	<i>Test Setup Diagram</i>	168
7.12.3	<i>Measurement Procedure and Data</i>	169
7.13	FREQUENCY STABILITY.....	316
7.13.1	<i>E.U.T. Operation</i>	316
7.13.2	<i>Test Setup Diagram</i>	317
7.13.3	<i>Measurement Procedure and Data</i>	317
8	APPENDIX.....	318
8.1	APPENDIX 15.407.....	318-639

4 General Information

4.1 Details of E.U.T.

Power supply:	Powered by AC120V			
Cable:	AC cable: 192cm unshielded			
Operation Frequency:	Band	Mode	Frequency Range(MHz)	Number of channels
	UNII Band I	IEEE 802.11a	5180-5240	4
		IEEE 802.11n/ac 20MHz	5180-5240	4
		IEEE 802.11n/ac 40MHz	5190-5230	2
		IEEE 802.11ac 80MHz	5210	1
	UNII Band II-A	IEEE 802.11a	5260-5320	4
		IEEE 802.11n/ac 20MHz	5260-5320	4
		IEEE 802.11n/ac 40MHz	5270-5310	2
		IEEE 802.11ac 80MHz	5290	1
	UNII Band II-C	IEEE 802.11a	5500-5700	11
		IEEE 802.11n/ac 20MHz	5500-5700	11
		IEEE 802.11n/ac 40MHz	5510-5670	5
		IEEE 802.11ac 80MHz	5530-5610	2
	UNII Band III	IEEE 802.11a	5745-5825	5
		IEEE 802.11n/ac 20MHz	5745-5825	5
		IEEE 802.11n/ac 40MHz	5755-5795	2
IEEE 802.11ac 80MHz		5775	1	
Type of Modulation:	IEEE 802.11a: OFDM(BPSK/QPSK/16QAM/64QAM) IEEE 802.11n: OFDM(BPSK/QPSK/16QAM/64QAM) IEEE 802.11ac: OFDM (BPSK/QPSK/16QAM/64QAM/256QAM)			
DFS Function	Slave without Radar detection			
TPC Function	Support			
Antenna Gain	Antenna 1: 3.14dBi; Antenna 2: 2.85dBi Two antennas can simultaneous transmission.			



Channel list for 802.11a/n(HT20)/ac(HT20)							
Channel	Frequency	Channel	Frequency	Channel	Frequency	Channel	Frequency
36	5180MHz	40	5200MHz	44	5220MHz	48	5240MHz
52	5260MHz	56	5280MHz	60	5330MHz	64	5320MHz
100	5500MHz	104	5520MHz	108	5540 MHz	112	5560MHz
116	5580MHz	120	5600MHz	124	5620 MHz	128	5640MHz
132	5660MHz	136	5680MHz	140	5700 MHz	149	5745MHz
153	5765MHz	157	5785MHz	161	5805MHz	165	5825MHz

Channel list for 802.11n(HT40)/ac(HT40)							
Channel	Frequency	Channel	Frequency	Channel	Frequency	Channel	Frequency
38	5190MHz	46	5230MHz	54	5270MHz	62	5310MHz
102	5510MHz	110	5550MHz	118	5590MHz	126	5630MHz
134	5670MHz	155	5755MHz	159	5795MHz		

Channel list for 802.11ac(HT80)							
Channel	Frequency	Channel	Frequency	Channel	Frequency	Channel	Frequency
42	5210MHz	58	5290MHz	106	5530 MHz	122	5610MHz
155	5775MHz						

Selected Test Channel for 802.11a/n(HT20)/ac(HT20)		
Band	Channel	Frequency
U-NII Band I	The lowest channel (CH36)	5180MHz
	The middle channel (CH40)	5200MHz
	The highest channel (CH48)	5240MHz
U-NII Band 2A	The lowest channel (CH52)	5260MHz
	The middle channel (CH60)	5785MHz
	The highest channel (CH64)	5320MHz
U-NII Band 2C	The lowest channel (CH100)	5500MHz
	The middle channel (CH116)	5580MHz
	The highest channel (CH140)	5700MHz
U-NII Band III	The lowest channel (CH149)	5745MHz
	The middle channel (CH157)	5785MHz
	The highest channel (CH165)	5825MHz

Selected Test Channel for 802.11n(HT40)/ac(HT40)		
Band	Channel	Frequency
U-NII Band I	The lowest channel (CH38)	5190MHz
	The highest channel (CH46)	5230MHz
U-NII Band 2A	The lowest channel (CH54)	5270MHz
	The highest channel (CH62)	5310MHz
U-NII Band 2C	The lowest channel (CH102)	5510MHz
	The middle channel (CH118)	5590MHz
	The highest channel (CH134)	5670MHz
U-NII Band III	The lowest channel (CH151)	5755MHz
	The highest channel (CH159)	5795MHz

Selected Test Channel for 802.11ac(HT80)		
Band	Channel	Frequency
U-NII Band I	One channel (CH42)	5210MHz
U-NII Band 2A	One channel(CH58)	5290MHz
U-NII Band 2C	The lowest channel (CH106)	5530MHz
	The highest channel (CH138)	5610MHz
U-NII Band III	One channel (CH155)	5775MHz

4.2 Description of Support Units

The EUT has been tested as an independent unit.

4.3 Measurement Uncertainty

No.	Item	Measurement Uncertainty
1	Radio Frequency	$\pm 7.25 \times 10^{-8}$
2	Duty cycle	$\pm 0.37\%$
3	Occupied Bandwidth	$\pm 3\%$
4	RF conducted power	$\pm 0.75\text{dB}$
5	RF power density	$\pm 2.84\text{dB}$
6	Conducted Spurious emissions	$\pm 0.75\text{dB}$
7	RF Radiated power	$\pm 4.5\text{dB}$ (below 1GHz)
		$\pm 4.8\text{dB}$ (above 1GHz)
8	Radiated Spurious emission test	$\pm 4.5\text{dB}$ (Below 1GHz)
		$\pm 4.8\text{dB}$ (Above 1GHz)
9	Temperature test	$\pm 1^\circ\text{C}$
10	Humidity test	$\pm 3\%$
11	Supply voltages	$\pm 1.5\%$
12	Time	$\pm 3\%$



4.4 Test Location

All tests were performed at:

SGS-CSTC Standards Technical Services Co., Ltd., Shenzhen Branch

No. 1 Workshop, M-10, Middle Section, Science & Technology Park, Shenzhen, Guangdong, China.
518057.

Tel: +86 755 2601 2053 Fax: +86 755 2671 0594

No tests were sub-contracted.

4.5 Test Facility

The test facility is recognized, certified, or accredited by the following organizations:

- **CNAS (No. CNAS L2929)**

CNAS has accredited SGS-CSTC Standards Technical Services Co., Ltd. Shenzhen Branch EMC Lab to ISO/IEC 17025:2005 General Requirements for the Competence of Testing and Calibration Laboratories (CNAS-CL01 Accreditation Criteria for the Competence of Testing and Calibration Laboratories) for the competence in the field of testing.

- **A2LA (Certificate No. 3816.01)**

SGS-CSTC Standards Technical Services Co., Ltd., Shenzhen EMC Laboratory is accredited by the American Association for Laboratory Accreditation(A2LA). Certificate No. 3816.01.

- **VCCI**

The 3m Fully-anechoic chamber for above 1GHz, 10m Semi-anechoic chamber for below 1GHz, Shielded Room for Mains Port Conducted Interference Measurement and Telecommunication Port Conducted Interference Measurement of SGS-CSTC Standards Technical Services Co., Ltd. have been registered in accordance with the Regulations for Voluntary Control Measures with Registration No.: G-20026, R-14188, C-12383 and T-11153 respectively.

- **FCC –Designation Number: CN1178**

SGS-CSTC Standards Technical Services Co., Ltd., Shenzhen EMC Laboratory has been recognized as an accredited testing laboratory.

Designation Number: CN1178. Test Firm Registration Number: 406779.

- **Industry Canada (IC)**

Two 3m Semi-anechoic chambers and the 10m Semi-anechoic chamber of SGS-CSTC Standards Technical Services Co., Ltd. Shenzhen Branch EMC Lab have been registered by Certification and Engineering Bureau of Industry Canada for radio equipment testing with Registration No.: 4620C-1, 4620C-2, 4620C-3.

4.6 Deviation from Standards

None

4.7 Abnormalities from Standard Conditions

None



5 Equipment List

Conducted Emissions at AC Power Line (150kHz-30MHz)					
Equipment	Manufacturer	Model No	Inventory No	Cal Date	Cal Due Date
Shielding Room	ZhongYu Electron	GB-88	SEM001-06	2017-05-10	2020-05-09
Measurement Software	AUDIX	e3 V5.4.1221d	N/A	N/A	N/A
Coaxial Cable	SGS	N/A	SEM024-01	2018-07-12	2019-07-11
LISN	Rohde & Schwarz	ENV216	SEM007-01	2017-09-27	2018-09-26
LISN	ETS-LINDGREN	3816/2	SEM007-02	2018-04-02	2019-04-01
EMI Test Receiver	Rohde & Schwarz	ESCI	SEM004-02	2018-04-02	2019-04-01

Duty Cycle					
Equipment	Manufacturer	Model No	Inventory No	Cal Date	Cal Due Date
DC Power Supply	ZhaoXin	RXN-305D	SEM011-02	2017-09-27	2018-09-26
Spectrum Analyzer	Rohde & Schwarz	FSU43	SEM004-08	2018-04-02	2019-04-01
Measurement Software	JS Tonscend	JS1120-2 BT/WIFI V2.	N/A	N/A	N/A
Coaxial Cable	SGS	N/A	SEM031-01	2018-07-12	2019-07-11
Attenuator	Weinschel Associates	WA41	SEM021-09	N/A	N/A
Signal Generator	KEYSIGHT	N5173B	SEM006-05	2017-09-27	2018-09-26
Power Meter	Rohde & Schwarz	NRVS	SEM014-02	2017-09-27	2018-09-26

99% Bandwidth					
Equipment	Manufacturer	Model No	Inventory No	Cal Date	Cal Due Date
DC Power Supply	ZhaoXin	RXN-305D	SEM011-02	2017-09-27	2018-09-26
Spectrum Analyzer	Rohde & Schwarz	FSU43	SEM004-08	2018-04-02	2019-04-01
Measurement Software	JS Tonscend	JS1120-2 BT/WIFI V2.	N/A	N/A	N/A
Coaxial Cable	SGS	N/A	SEM031-01	2018-07-12	2019-07-11
Attenuator	Weinschel Associates	WA41	SEM021-09	N/A	N/A
Signal Generator	KEYSIGHT	N5173B	SEM006-05	2017-09-27	2018-09-26
Power Meter	Rohde & Schwarz	NRVS	SEM014-02	2017-09-27	2018-09-26

26dB Emission bandwidth					
Equipment	Manufacturer	Model No	Inventory No	Cal Date	Cal Due Date
DC Power Supply	ZhaoXin	RXN-305D	SEM011-02	2017-09-27	2018-09-26
Spectrum Analyzer	Rohde & Schwarz	FSU43	SEM004-08	2018-04-02	2019-04-01
Measurement Software	JS Tonscend	JS1120-2 BT/WIFI V2.	N/A	N/A	N/A
Coaxial Cable	SGS	N/A	SEM031-01	2018-07-12	2019-07-11
Attenuator	Weinschel Associates	WA41	SEM021-09	N/A	N/A
Signal Generator	KEYSIGHT	N5173B	SEM006-05	2017-09-27	2018-09-26
Power Meter	Rohde & Schwarz	NRVS	SEM014-02	2017-09-27	2018-09-26



Minimum 6 dB bandwidth (5.725-5.85 GHz band)					
Equipment	Manufacturer	Model No	Inventory No	Cal Date	Cal Due Date
DC Power Supply	ZhaoXin	RXN-305D	SEM011-02	2017-09-27	2018-09-26
Spectrum Analyzer	Rohde & Schwarz	FSU43	SEM004-08	2018-04-02	2019-04-01
Measurement Software	JS Tonscend	JS1120-2 BT/WIFI V2.	N/A	N/A	N/A
Coaxial Cable	SGS	N/A	SEM031-01	2018-07-12	2019-07-11
Attenuator	Weinschel Associates	WA41	SEM021-09	N/A	N/A
Signal Generator	KEYSIGHT	N5173B	SEM006-05	2017-09-27	2018-09-26
Power Meter	Rohde & Schwarz	NRVS	SEM014-02	2017-09-27	2018-09-26

Maximum Conducted output power					
Equipment	Manufacturer	Model No	Inventory No	Cal Date	Cal Due Date
DC Power Supply	ZhaoXin	RXN-305D	SEM011-02	2017-09-27	2018-09-26
Spectrum Analyzer	Rohde & Schwarz	FSU43	SEM004-08	2018-04-02	2019-04-01
Measurement Software	JS Tonscend	JS1120-2 BT/WIFI V2.	N/A	N/A	N/A
Coaxial Cable	SGS	N/A	SEM031-01	2018-07-12	2019-07-11
Attenuator	Weinschel Associates	WA41	SEM021-09	N/A	N/A
Signal Generator	KEYSIGHT	N5173B	SEM006-05	2017-09-27	2018-09-26
Power Meter	Rohde & Schwarz	NRVS	SEM014-02	2017-09-27	2018-09-26

Peak Power spectrum density					
Equipment	Manufacturer	Model No	Inventory No	Cal Date	Cal Due Date
DC Power Supply	ZhaoXin	RXN-305D	SEM011-02	2017-09-27	2018-09-26
Spectrum Analyzer	Rohde & Schwarz	FSU43	SEM004-08	2018-04-02	2019-04-01
Measurement Software	JS Tonscend	JS1120-2 BT/WIFI V2.	N/A	N/A	N/A
Coaxial Cable	SGS	N/A	SEM031-01	2018-07-12	2019-07-11
Attenuator	Weinschel Associates	WA41	SEM021-09	N/A	N/A
Signal Generator	KEYSIGHT	N5173B	SEM006-05	2017-09-27	2018-09-26
Power Meter	Rohde & Schwarz	NRVS	SEM014-02	2017-09-27	2018-09-26

Radiated Emissions which fall in the restricted bands					
Equipment	Manufacturer	Model No	Inventory No	Cal Date	Cal Due Date
3m Semi-Anechoic Chamber	AUDIX	N/A	SEM001-02	2018-03-13	2021-03-12
Measurement Software	AUDIX	e3 V8.2014-6-27	N/A	N/A	N/A
Coaxial Cable	SGS	N/A	SEM026-01	2018-07-12	2019-07-11
Spectrum Analyzer	Rohde & Schwarz	FSU43	SEM004-08	2018-04-02	2019-04-01
BiConiLog Antenna (26-3000MHz)	ETS-Lindgren	3142C	SEM003-01	2017-06-27	2020-06-26
Horn Antenna (1-18GHz)	Rohde & Schwarz	HF907	SEM003-07	2018-04-13	2021-04-12



**SGS-CSTC Standards Technical Services Co., Ltd.
Shenzhen Branch**

Report No.: SZEM180500405704
Page: 12 of 639

Horn Antenna(15GHz-40GHz)	Schwarzbeck	BBHA 9170	SEM003-15	2017-10-17	2020-10-16
Pre-amplifier (0.1-1300MHz)	HP	8447D	SEM005-02	2017-09-27	2018-09-26
Low Noise Amplifier(100MHz-18GHz)	Black Diamond Series	BDLNA-0118-352810	SEM005-05	2017-09-27	2018-09-27
Pre-amplifier(18-26GHz)	Rohde & Schwarz	CH14-H052	SEM005-17	2018-04-02	2019-04-01
Pre-amplifier(26GHz-40GHz)	Compliance Directions Systems Inc.	PAP-2640-50	SEM005-08	2018-04-02	2019-04-01
DC Power Supply	Zhao Xin	RXN-305D	SEM011-02	2017-09-27	2018-09-26
Active Loop Antenna	ETS-Lindgren	6502	SEM003-08	2017-08-22	2020-08-21
Band filter	N/A	N/A	SEM023-01	N/A	N/A

RE in Chamber					
Equipment	Manufacturer	Model No	Inventory No	Cal Date	Cal Due Date
3m Semi-Anechoic Chamber	ETS-LINDGREN	N/A	SEM001-01	2017-08-05	2020-08-04
MXE EMI Receiver (20Hz-8.4GHz)	Agilent Technologies	N9038A	SEM004-05	2017-09-27	2018-09-26
BiConiLog Antenna (26-3000MHz)	ETS-LINDGREN	3142C	SEM003-01	2017-06-27	2020-06-26
Pre-amplifier (0.1-1300MHz)	Agilent Technologies	8447D	SEM005-01	2018-04-02	2019-04-01
Measurement Software	AUDIX	e3 V8.2014-6-27	N/A	N/A	N/A
Coaxial Cable	SGS	N/A	SEM025-01	2018-07-12	2019-07-11

Radiated Spurious Emissions					
Equipment	Manufacturer	Model No	Inventory No	Cal Date	Cal Due Date
3m Semi-Anechoic Chamber	AUDIX	N/A	SEM001-02	2018-03-13	2021-03-12
Measurement Software	AUDIX	e3 V8.2014-6-27	N/A	N/A	N/A
Coaxial Cable	SGS	N/A	SEM026-01	2018-07-12	2019-07-11
Spectrum Analyzer	Rohde & Schwarz	FSU43	SEM004-08	2018-04-02	2019-04-01
BiConiLog Antenna (26-3000MHz)	ETS-Lindgren	3142C	SEM003-01	2017-06-27	2020-06-26
Horn Antenna (1-18GHz)	Rohde & Schwarz	HF907	SEM003-07	2018-04-13	2021-04-12
Horn Antenna(15GHz-40GHz)	Schwarzbeck	BBHA 9170	SEM003-15	2017-10-17	2020-10-16
Pre-amplifier (0.1-1300MHz)	HP	8447D	SEM005-02	2017-09-27	2018-09-26



SGS-CSTC Standards Technical Services Co., Ltd.
Shenzhen Branch

Report No.: SZEM180500405704

Page: 13 of 639

Low Noise Amplifier(100MHz-18GHz)	Black Diamond Series	BDLNA-0118-352810	SEM005-05	2017-09-27	2018-09-27
Pre-amplifier(18-26GHz)	Rohde & Schwarz	CH14-H052	SEM005-17	2018-04-02	2019-04-01
Pre-amplifier(26GHz-40GHz)	Compliance Directions Systems Inc.	PAP-2640-50	SEM005-08	2018-04-02	2019-04-01
DC Power Supply	Zhao Xin	RXN-305D	SEM011-02	2017-09-27	2018-09-26
Active Loop Antenna	ETS-Lindgren	6502	SEM003-08	2017-08-22	2020-08-21
Band filter	N/A	N/A	SEM023-01	N/A	N/A

Transmission in the Absence of Data

Equipment	Manufacturer	Model No	Inventory No	Cal Date	Cal Due Date
DC Power Supply	ZhaoXin	RXN-305D	SEM011-02	2017-09-27	2018-09-26
Spectrum Analyzer	Rohde & Schwarz	FSU43	SEM004-08	2018-04-02	2019-04-01
Measurement Software	JS Tonscend	JS1120-2 BT/WIFI V2.	N/A	N/A	N/A
Coaxial Cable	SGS	N/A	SEM031-01	2018-07-12	2019-07-11
Attenuator	Weinschel Associates	WA41	SEM021-09	N/A	N/A
Signal Generator	KEYSIGHT	N5173B	SEM006-05	2017-09-27	2018-09-26
Power Meter	Rohde & Schwarz	NRVS	SEM014-02	2017-09-27	2018-09-26

General used equipment

Equipment	Manufacturer	Model No	Inventory No	Cal Date	Cal Due Date
Humidity/ Temperature Indicator	Shanghai Meteorological Industry Factory	ZJ1-2B	SEM002-03	2017-09-29	2018-09-28
Humidity/ Temperature Indicator	Shanghai Meteorological Industry Factory	ZJ1-2B	SEM002-04	2017-09-29	2018-09-28
Humidity/ Temperature Indicator	Mingle	N/A	SEM002-08	2017-09-29	2018-09-28
Barometer	Changchun Meteorological Industry Factory	DYM3	SEM002-01	2018-04-08	2019-04-07



6 Radio Spectrum Technical Requirement

6.1 Antenna Requirement

6.1.1 Test Requirement:

47 CFR Part 15, Subpart C 15.203

6.1.2 Conclusion

Standard Requirement:

An intentional radiator shall be designed to ensure that no antenna other than that furnished by the responsible party shall be used with the device. The use of an antenna that uses a unique coupling to the intentional radiator, the manufacturer may design the unit permanently attached antenna or of an so that a broken antenna can be replaced by the user, but the use of a standard antenna jack or electrical connector is prohibited.

EUT Antenna:

The antenna is integrated on the main PCB and no consideration of replacement. The best case gain of the antennas are Antenna 1: 3.14dBi; Antenna 2: 2.85dBi. the directional gain is: 6.15dBi.



6.2 Transmission in the Absence of Data

6.2.1 Test Requirement:

47 CFR Part 15, Subpart C 15.407 (c)

6.2.2 Conclusion

Standard Requirement:

The device shall automatically discontinue transmission in case of either absence of information to transmit or operational failure. These provisions are not intended to preclude the transmission of control or signalling information or the use of repetitive codes used by certain digital technologies to complete frame or burst intervals.

Applicants shall include in their application for equipment authorization a description of how this requirement is met.

EUT Details:

WIFI chip (AP72598) support automatically discontinue transmission in case of either absence of information to transmit or operational failure, if the chip detect absence of information to transmit or operational failure, it will be automatically shut off.



7 Radio Spectrum Matter Test Results

7.1 Conducted Emissions at AC Power Line (150kHz-30MHz)

Test Requirement 47 CFR Part 15, Subpart C 15.207 & 15.407 b(6)
Test Method: ANSI C63.10 (2013) Section 6.2
Limit:

Frequency of emission(MHz)	Conducted limit(dB μ V)	
	Quasi-peak	Average
0.15-0.5	66 to 56*	56 to 46*
0.5-5	56	46
5-30	60	50

*Decreases with the logarithm of the frequency.



7.1.1 E.U.T. Operation

Operating Environment:

Temperature: 21.5 °C Humidity: 45.3 % RH Atmospheric Pressure: 1015 mbar

Pretest these modes to find the worst case:

e:TX mode (Band 1)_Keep the EUT in continuously transmitting mode with all modulation types. All data rates for each modulation type have been tested and found the data rate @ 6Mbps is the worst case of IEEE 802.11a; data rate @ MCS0 is the worst case of IEEE 802.11n(HT20); data rate @ MCS0 is the worst case of IEEE 802.11n(HT40); data rate @ MCS0 is the worst case of IEEE 802.11ac(VHT20); data rate @ MCS0 is the worst case of IEEE 802.11ac(VHT40); data rate @ MCS0 is the worst case of IEEE 802.11ac(VHT80). Only the data of worst case is recorded in the report.

f:TX mode (Band 2A)_Keep the EUT in continuously transmitting mode with all modulation types. All data rates for each modulation type have been tested and found the data rate @ 6Mbps is the worst case of IEEE 802.11a; data rate @ MCS0 is the worst case of IEEE 802.11n(HT20); data rate @ MCS0 is the worst case of IEEE 802.11n(HT40); data rate @ MCS0 is the worst case of IEEE 802.11ac(VHT20); data rate @ MCS0 is the worst case of IEEE 802.11ac(VHT40); data rate @ MCS0 is the worst case of IEEE 802.11ac(VHT80). Only the data of worst case is recorded in the report.

g:TX mode (Band 2C)_Keep the EUT in continuously transmitting mode with all modulation types. All data rates for each modulation type have been tested and found the data rate @ 6Mbps is the worst case of IEEE 802.11a; data rate @ MCS0 is the worst case of IEEE 802.11n(HT20); data rate @ MCS0 is the worst case of IEEE 802.11n(HT40); data rate @ MCS0 is the worst case of IEEE 802.11ac(VHT20); data rate @ MCS0 is the worst case of IEEE 802.11ac(VHT40); data rate @ MCS0 is the worst case of IEEE 802.11ac(VHT80). Only the data of worst case is recorded in the report.

h:TX mode (Band 3)_Keep the EUT in continuously transmitting mode with all modulation types. All data rates for each modulation type have been tested and found the data rate @ 6Mbps is the worst case of IEEE 802.11a; data rate @ MCS0 is the worst case of IEEE 802.11n(HT20); data rate @ MCS0 is the worst case of IEEE 802.11n(HT40); data rate @ MCS0 is the worst case of IEEE 802.11ac(VHT20); data rate @ MCS0 is the worst case of IEEE 802.11ac(VHT40); data rate @ MCS0 is the worst case of IEEE 802.11ac(VHT80). Only the data of worst case is recorded in the report.

The worst case for final test:

e:TX mode (Band 1)_Keep the EUT in continuously transmitting mode with all modulation types. All data rates for each modulation type have been tested and found the data rate @ 6Mbps is the worst case of IEEE 802.11a; data rate @ MCS0 is the worst case of IEEE 802.11n(HT20); data rate @ MCS0 is the worst case of IEEE 802.11n(HT40); data rate @ MCS0 is the worst case of IEEE 802.11ac(VHT20); data rate @ MCS0 is the worst case of IEEE 802.11ac(VHT40); data rate @ MCS0 is the worst case of IEEE 802.11ac(VHT80). Only the data of worst case is recorded in the report.

7.1.2 Test Setup Diagram

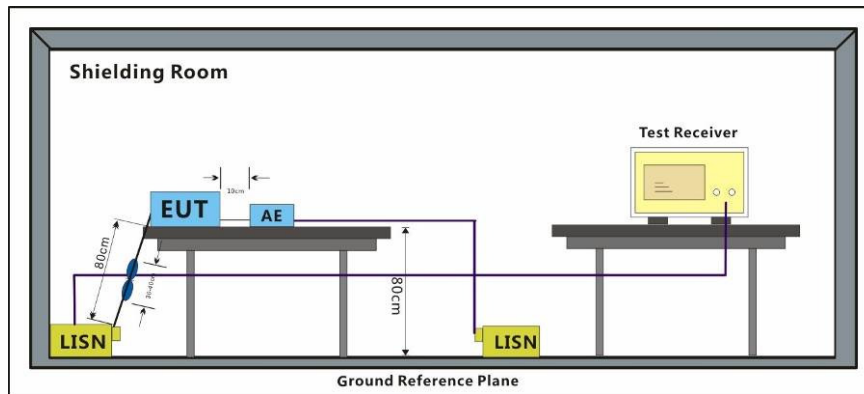

7.1.3 Measurement Procedure and Data

- 1) The mains terminal disturbance voltage test was conducted in a shielded room.
- 2) The EUT was connected to AC power source through a LISN 1 (Line Impedance Stabilization Network) which provides a 50ohm/50μH + 5ohm linear impedance. The power cables of all other units of the EUT were connected to a second LISN 2, which was bonded to the ground reference plane in the same way as the LISN 1 for the unit being measured. A multiple socket outlet strip was used to connect multiple power cables to a single LISN provided the rating of the LISN was not exceeded.
- 3) The tabletop EUT was placed upon a non-metallic table 0.8m above the ground reference plane. And for floor-standing arrangement, the EUT was placed on the horizontal ground reference plane,
- 4) The test was performed with a vertical ground reference plane. The rear of the EUT shall be 0.4 m from the vertical ground reference plane. The vertical ground reference plane was bonded to the horizontal ground reference plane. The LISN 1 was placed 0.8 m from the boundary of the unit under test and bonded to a ground reference plane for LISNs mounted on top of the ground reference plane. This distance was between the closest points of the LISN 1 and the EUT. All other units of the EUT and associated equipment was at least 0.8 m from the LISN 2.
- 5) In order to find the maximum emission, the relative positions of equipment and all of the interface cables must be changed according to ANSI C63.10 on conducted measurement.

Remark: LISN=Read Level+ Cable Loss+ LISN Factor

Mode:e; Line:Live Line

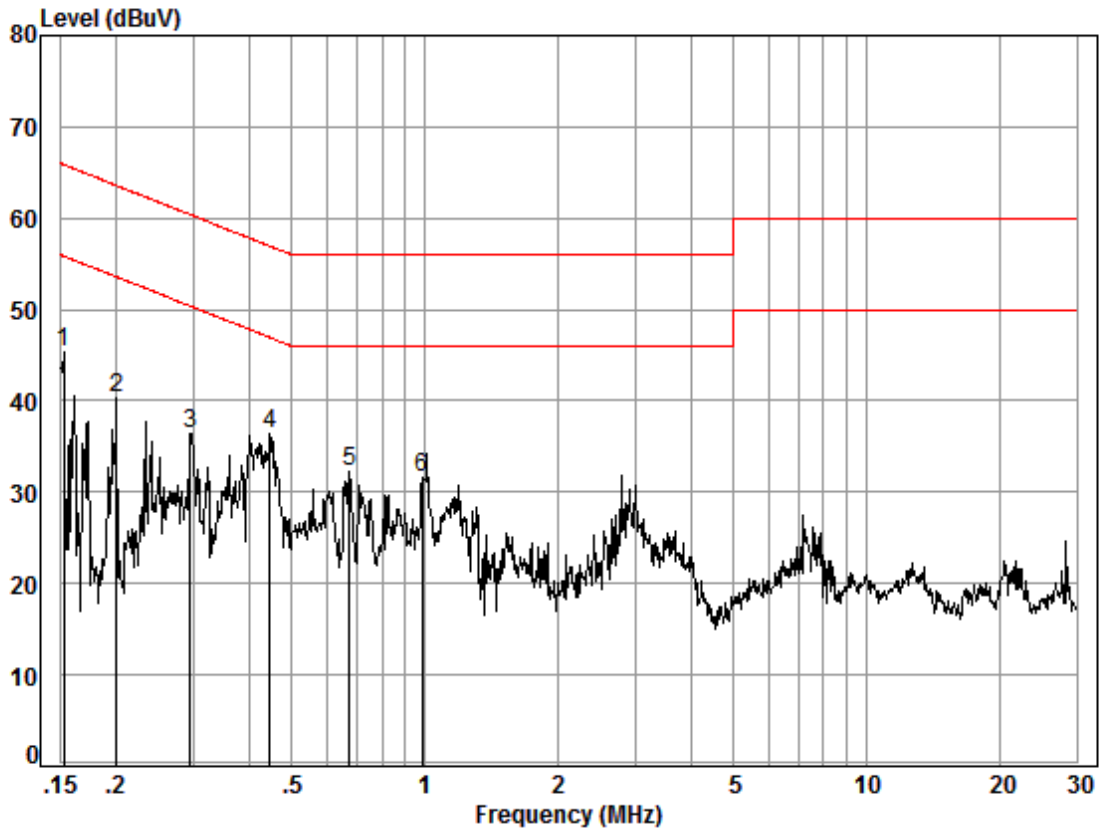

Site : Shielding Room
 Condition: Line
 Job No. : 04057CR
 Test mode: e

	Freq	Cable Loss	LISM Factor	Read Level	Level	Limit Line	Over Limit	Remark
	MHz	dB	dB	dBuV	dBuV	dBuV	dB	
1	0.15	0.02	9.51	35.89	45.42	55.87	-10.45	Peak
2	0.20	0.03	9.50	30.83	40.36	53.58	-13.22	Peak
3	0.29	0.03	9.51	26.86	36.40	50.41	-14.01	Peak
4	0.45	0.04	9.49	26.85	36.38	46.93	-10.55	Peak
5	0.68	0.07	9.50	22.66	32.23	46.00	-13.77	Peak
6	0.99	0.10	9.50	22.10	31.70	46.00	-14.30	Peak

Mode:e; Line:Neutral Line

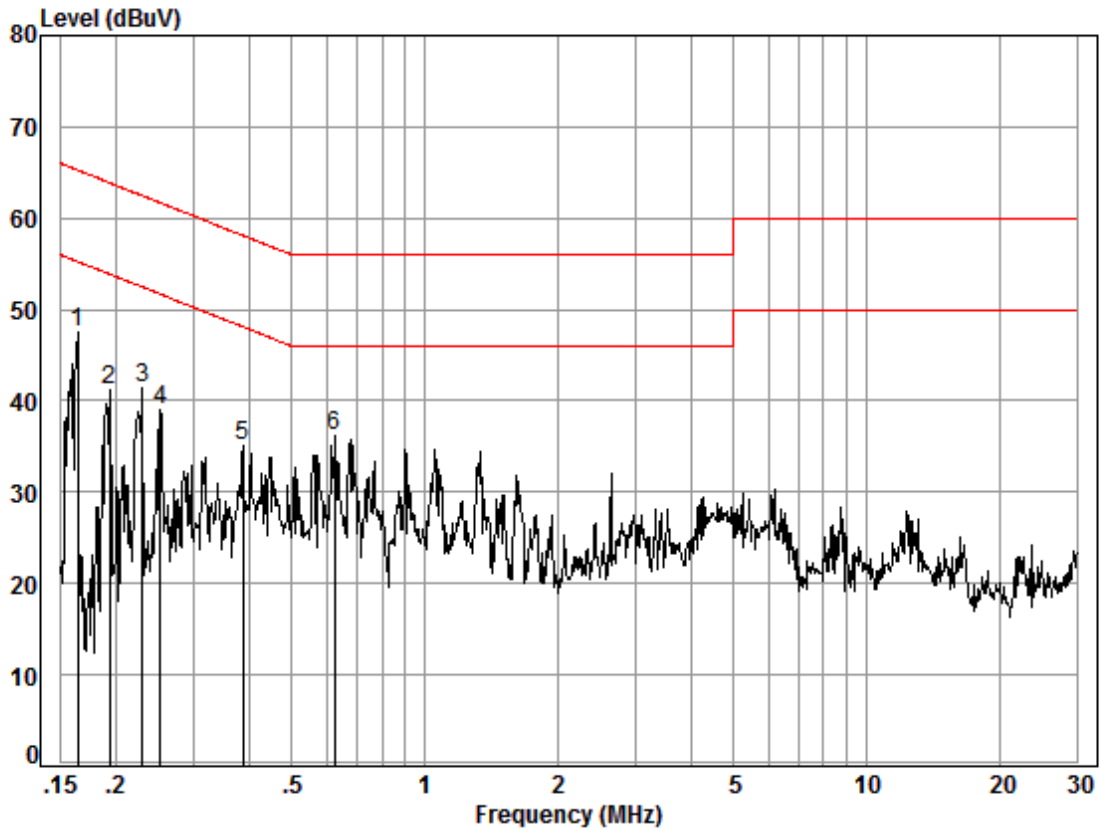

Site : Shielding Room
 Condition: Neutral
 Job No. : 04057CR
 Test mode: e

	Freq	Cable Loss	LISN Factor	Read Level	Level	Limit Line	Over Limit	Remark
	MHz	dB	dB	dBuV	dBuV	dBuV	dB	
1	0.16	0.02	9.59	38.02	47.63	55.25	-7.62	Peak
2	0.19	0.03	9.57	31.62	41.22	53.89	-12.67	Peak
3	0.23	0.03	9.58	31.77	41.38	52.48	-11.10	Peak
4	0.25	0.03	9.58	29.51	39.12	51.69	-12.57	Peak
5	0.39	0.03	9.59	25.56	35.18	48.12	-12.94	Peak
6	0.62	0.06	9.62	26.48	36.16	46.00	-9.84	Peak

7.2 Duty Cycle

Test Requirement KDB 789033 D02 II B 1
 Test Method: KDB 789033 II B 1

7.2.1 E.U.T. Operation

Operating Environment:

Temperature: 26.1 °C Humidity: 66.8 % RH Atmospheric Pressure: 1010 mbar

Test mode g:TX mode (Band 2C)_ Keep the EUT in continuously transmitting mode with all modulation types. All data rates for each modulation type have been tested and found the data rate @ 6Mbps is the worst case of IEEE 802.11a; data rate @ MCS0 is the worst case of IEEE 802.11n(HT20); data rate @ MCS0 is the worst case of IEEE 802.11n(HT40); data rate @ MCS0 is the worst case of IEEE 802.11ac(VHT20); data rate @ MCS0 is the worst case of IEEE 802.11ac(VHT40); data rate @ MCS0 is the worst case of IEEE 802.11ac(VHT80). Only the data of worst case is recorded in the report.

7.2.2 Test Setup Diagram

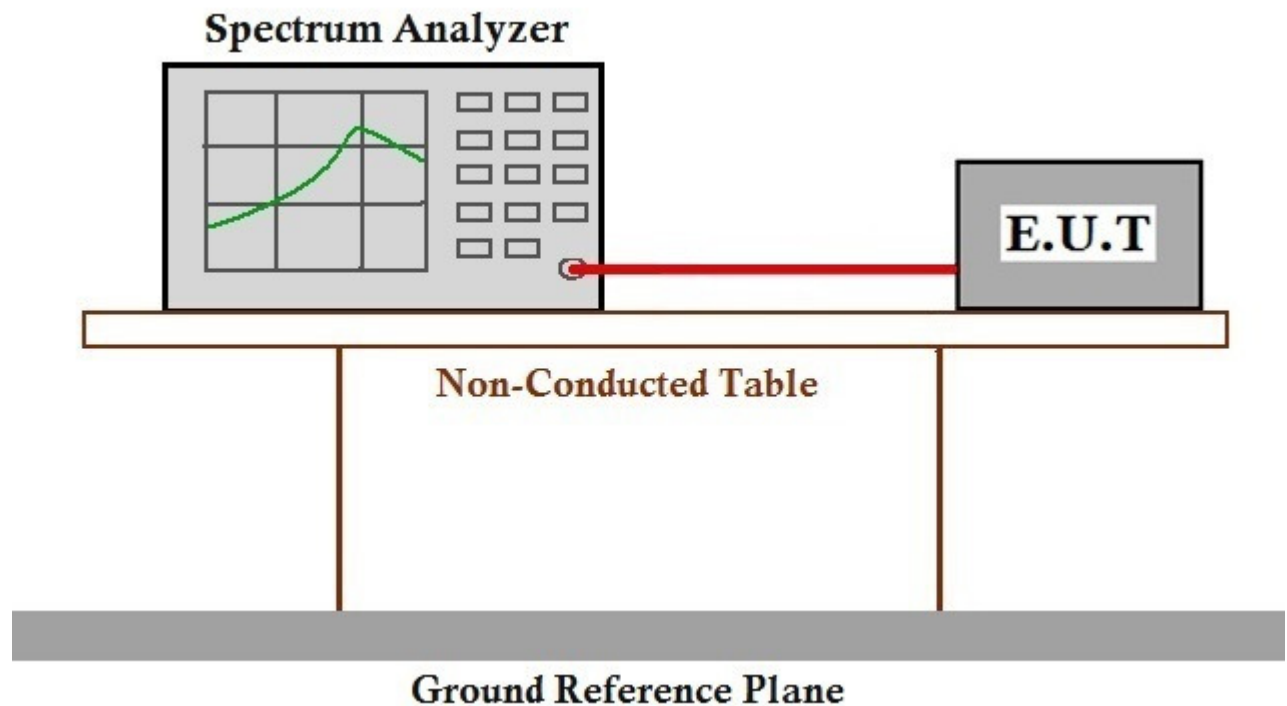

7.2.3 Measurement Procedure and Data

The detailed test data see: Appendix 15.407

7.3 99% Bandwidth

Test Requirement N/A
Test Method: KDB 789033 II D

7.3.1 E.U.T. Operation

Operating Environment:

Temperature: 26.1 °C Humidity: 66.6 % RH Atmospheric Pressure: 1010 mbar

Pretest these modes to find the worst case:

e:TX mode (Band 1)_Keep the EUT in continuously transmitting mode with all modulation types. All data rates for each modulation type have been tested and found the data rate @ 6Mbps is the worst case of IEEE 802.11a; data rate @ MCS0 is the worst case of IEEE 802.11n(HT20); data rate @ MCS0 is the worst case of IEEE 802.11n(HT40); data rate @ MCS0 is the worst case of IEEE 802.11ac(VHT20); data rate @ MCS0 is the worst case of IEEE 802.11ac(VHT40); data rate @ MCS0 is the worst case of IEEE 802.11ac(VHT80). Only the data of worst case is recorded in the report.

f:TX mode (Band 2A)_Keep the EUT in continuously transmitting mode with all modulation types. All data rates for each modulation type have been tested and found the data rate @ 6Mbps is the worst case of IEEE 802.11a; data rate @ MCS0 is the worst case of IEEE 802.11n(HT20); data rate @ MCS0 is the worst case of IEEE 802.11n(HT40); data rate @ MCS0 is the worst case of IEEE 802.11ac(VHT20); data rate @ MCS0 is the worst case of IEEE 802.11ac(VHT40); data rate @ MCS0 is the worst case of IEEE 802.11ac(VHT80). Only the data of worst case is recorded in the report.

g:TX mode (Band 2C)_Keep the EUT in continuously transmitting mode with all modulation types. All data rates for each modulation type have been tested and found the data rate @ 6Mbps is the worst case of IEEE 802.11a; data rate @ MCS0 is the worst case of IEEE 802.11n(HT20); data rate @ MCS0 is the worst case of IEEE 802.11n(HT40); data rate @ MCS0 is the worst case of IEEE 802.11ac(VHT20); data rate @ MCS0 is the worst case of IEEE 802.11ac(VHT40); data rate @ MCS0 is the worst case of IEEE 802.11ac(VHT80). Only the data of worst case is recorded in the report.

h:TX mode (Band 3)_Keep the EUT in continuously transmitting mode with all modulation types. All data rates for each modulation type have been tested and found the data rate @ 6Mbps is the worst case of IEEE 802.11a; data rate @ MCS0 is the worst case of IEEE 802.11n(HT20); data rate @ MCS0 is the worst case of IEEE 802.11n(HT40); data rate @ MCS0 is the worst case of IEEE 802.11ac(VHT20); data rate @ MCS0 is the worst case of IEEE 802.11ac(VHT40); data rate @ MCS0 is the worst case of IEEE 802.11ac(VHT80). Only the data of worst case is recorded in the report.

The worst case for final test:

e:TX mode (Band 1)_Keep the EUT in continuously transmitting mode with all modulation types. All data rates for each modulation type have been tested and found the data rate @ 6Mbps is the worst case of IEEE 802.11a; data rate @ MCS0 is the worst case of IEEE 802.11n(HT20); data rate @ MCS0 is the worst case of IEEE 802.11n(HT40); data rate @ MCS0 is the worst case of IEEE 802.11ac(VHT20); data rate @ MCS0 is the worst case of IEEE 802.11ac(VHT40); data rate @ MCS0 is the worst case of IEEE 802.11ac(VHT80). Only the data of worst case is recorded in the report.

f:TX mode (Band 2A)_Keep the EUT in continuously transmitting mode with all modulation types. All data rates for each modulation type have been tested and found the data rate @ 6Mbps is the worst case of IEEE 802.11a; data rate @ MCS0 is the worst case of IEEE 802.11n(HT20); data rate @ MCS0 is the worst case of IEEE 802.11n(HT40); data rate @ MCS0 is the worst case of IEEE 802.11ac(VHT20); data rate @ MCS0 is the worst case of IEEE 802.11ac(VHT40); data rate @ MCS0 is the worst case of IEEE 802.11ac(VHT80). Only the data of worst case is recorded in the report.

802.11ac(VHT80). Only the data of worst case is recorded in the report.

g:TX mode (Band 2C)_Keep the EUT in continuously transmitting mode with all modulation types. All data rates for each modulation type have been tested and found the data rate @ 6Mbps is the worst case of IEEE 802.11a; data rate @ MCS0 is the worst case of IEEE 802.11n(HT20); data rate @ MCS0 is the worst case of IEEE 802.11n(HT40); data rate @ MCS0 is the worst case of IEEE 802.11ac(VHT20); data rate @ MCS0 is the worst case of IEEE 802.11ac(VHT40); data rate @ MCS0 is the worst case of IEEE 802.11ac(VHT80). Only the data of worst case is recorded in the report.

h:TX mode (Band 3)_Keep the EUT in continuously transmitting mode with all modulation types. All data rates for each modulation type have been tested and found the data rate @ 6Mbps is the worst case of IEEE 802.11a; data rate @ MCS0 is the worst case of IEEE 802.11n(HT20); data rate @ MCS0 is the worst case of IEEE 802.11n(HT40); data rate @ MCS0 is the worst case of IEEE 802.11ac(VHT20); data rate @ MCS0 is the worst case of IEEE 802.11ac(VHT40); data rate @ MCS0 is the worst case of IEEE 802.11ac(VHT80). Only the data of worst case is recorded in the report.

7.3.2 Test Setup Diagram

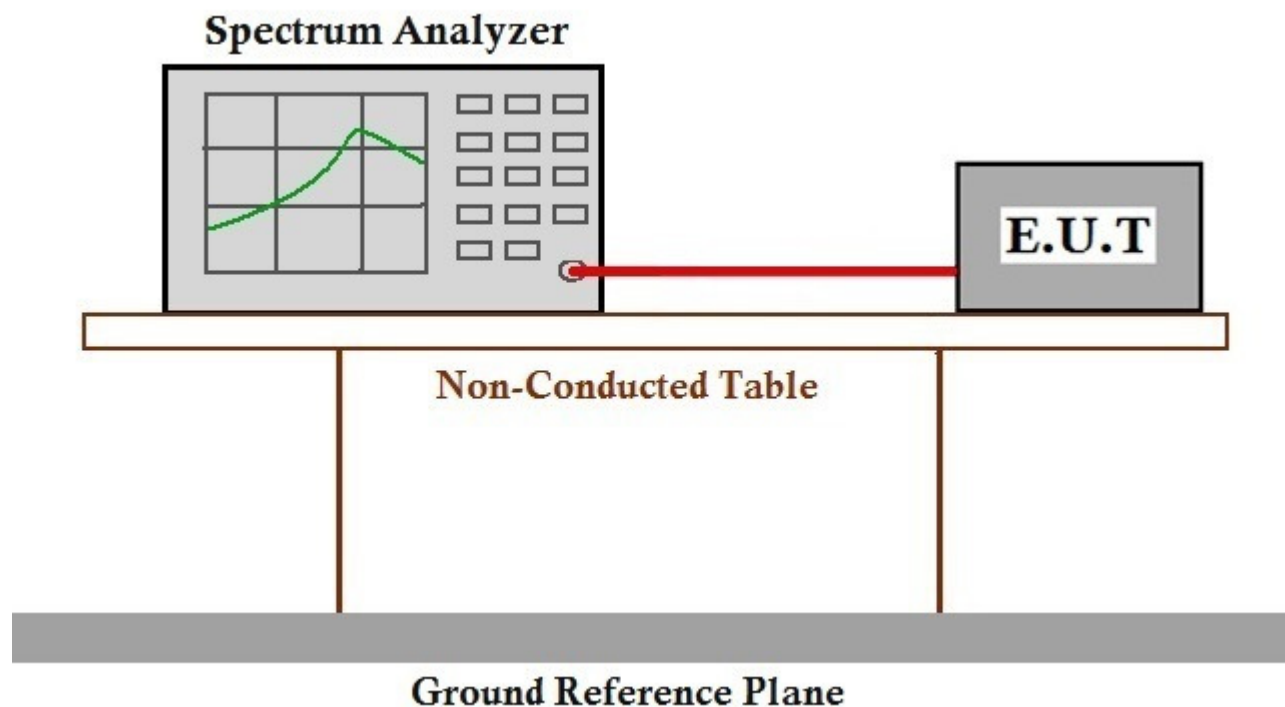

7.3.3 Measurement Procedure and Data

The detailed test data see: Appendix 15.407

7.4 26dB Emission bandwidth

Test Requirement 47 CFR Part 15, Subpart C 15.407 (a)

Test Method: KDB 789033 D02 II C 1

7.4.1 E.U.T. Operation

Operating Environment:

Temperature: 26.1 °C Humidity: 67.1 % RH Atmospheric Pressure: 1010 mbar

Pretest these modes to find the worst case:

f:TX mode (Band 2A)_Keep the EUT in continuously transmitting mode with all modulation types. All data rates for each modulation type have been tested and found the data rate @ 6Mbps is the worst case of IEEE 802.11a; data rate @ MCS0 is the worst case of IEEE 802.11n(HT20); data rate @ MCS0 is the worst case of IEEE 802.11n(HT40); data rate @ MCS0 is the worst case of IEEE 802.11ac(VHT20); data rate @ MCS0 is the worst case of IEEE 802.11ac(VHT40); data rate @ MCS0 is the worst case of IEEE 802.11ac(VHT80). Only the data of worst case is recorded in the report.

g:TX mode (Band 2C)_Keep the EUT in continuously transmitting mode with all modulation types. All data rates for each modulation type have been tested and found the data rate @ 6Mbps is the worst case of IEEE 802.11a; data rate @ MCS0 is the worst case of IEEE 802.11n(HT20); data rate @ MCS0 is the worst case of IEEE 802.11n(HT40); data rate @ MCS0 is the worst case of IEEE 802.11ac(VHT20); data rate @ MCS0 is the worst case of IEEE 802.11ac(VHT40); data rate @ MCS0 is the worst case of IEEE 802.11ac(VHT80). Only the data of worst case is recorded in the report.

h:TX mode (Band 3)_Keep the EUT in continuously transmitting mode with all modulation types. All data rates for each modulation type have been tested and found the data rate @ 6Mbps is the worst case of IEEE 802.11a; data rate @ MCS0 is the worst case of IEEE 802.11n(HT20); data rate @ MCS0 is the worst case of IEEE 802.11n(HT40); data rate @ MCS0 is the worst case of IEEE 802.11ac(VHT20); data rate @ MCS0 is the worst case of IEEE 802.11ac(VHT40); data rate @ MCS0 is the worst case of IEEE 802.11ac(VHT80). Only the data of worst case is recorded in the report.

The worst case for final test:

f:TX mode (Band 2A)_Keep the EUT in continuously transmitting mode with all modulation types. All data rates for each modulation type have been tested and found the data rate @ 6Mbps is the worst case of IEEE 802.11a; data rate @ MCS0 is the worst case of IEEE 802.11n(HT20); data rate @ MCS0 is the worst case of IEEE 802.11n(HT40); data rate @ MCS0 is the worst case of IEEE 802.11ac(VHT20); data rate @ MCS0 is the worst case of IEEE 802.11ac(VHT40); data rate @ MCS0 is the worst case of IEEE 802.11ac(VHT80). Only the data of worst case is recorded in the report.

g:TX mode (Band 2C)_Keep the EUT in continuously transmitting mode with all modulation types. All data rates for each modulation type have been tested and found the data rate @ 6Mbps is the worst case of IEEE 802.11a; data rate @ MCS0 is the worst case of IEEE 802.11n(HT20); data rate @ MCS0 is the worst case of IEEE 802.11n(HT40); data rate @ MCS0 is the worst case of IEEE 802.11ac(VHT20); data rate @ MCS0 is the worst case of IEEE 802.11ac(VHT40); data rate @ MCS0 is the worst case of IEEE 802.11ac(VHT80). Only the data of worst case is recorded in the report.

h:TX mode (Band 3)_Keep the EUT in continuously transmitting mode with all modulation types. All data rates for each modulation type have been tested and found the data rate @ 6Mbps is the worst case of IEEE 802.11a; data rate @ MCS0 is the worst case of IEEE 802.11n(HT20); data rate @ MCS0 is the worst case of IEEE 802.11n(HT40); data rate @ MCS0 is the worst case of IEEE 802.11ac(VHT20); data rate @ MCS0 is the worst case of IEEE 802.11ac(VHT40); data rate @ MCS0 is the worst case of IEEE 802.11ac(VHT80). Only the data of worst case is recorded in the report.

802.11ac(VHT80). Only the data of worst case is recorded in the report.

7.4.2 Test Setup Diagram

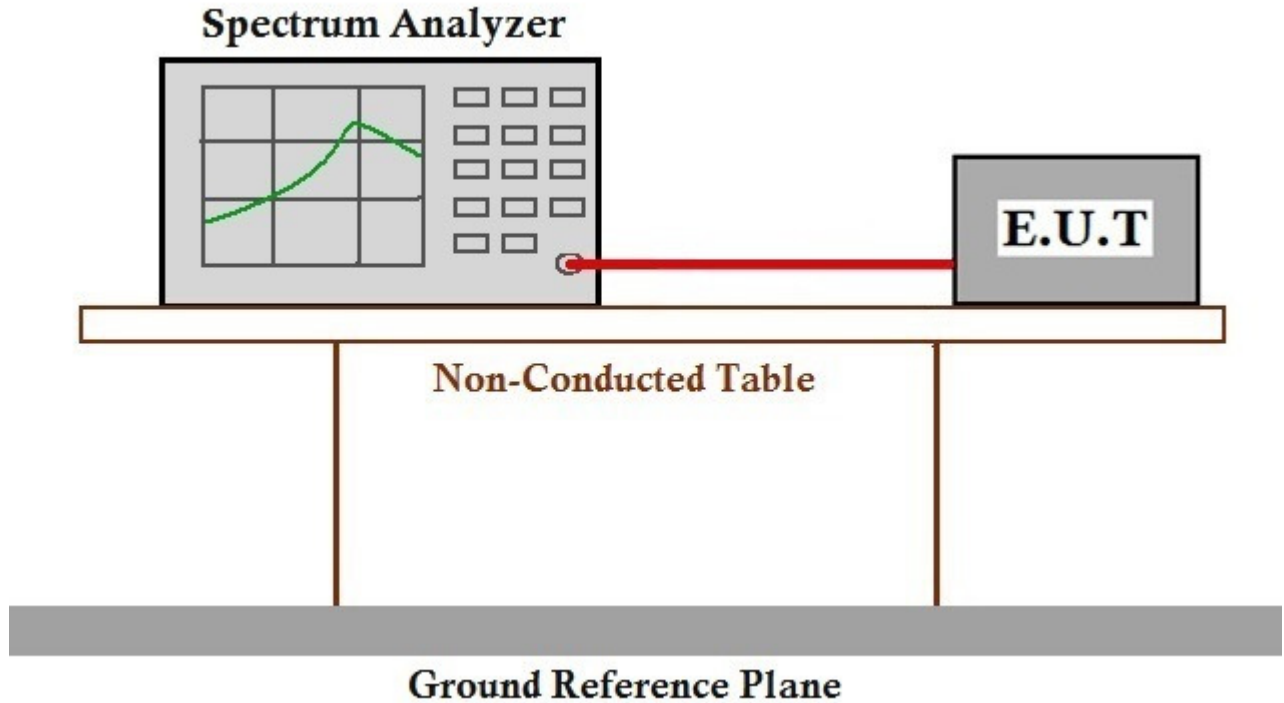

7.4.3 Measurement Procedure and Data

The detailed test data see: Appendix 15.407

7.5 Minimum 6 dB bandwidth (5.725-5.85 GHz band)

Test Requirement 47 CFR Part 15, Subpart C 15.407 (e)
 Test Method: KDB 789033 D02 II C 2
 Limit: ≥ 500 kHz

7.5.1 E.U.T. Operation

Operating Environment:

Temperature: 26.1 °C Humidity: 67.1 % RH Atmospheric Pressure: 1010 mbar

Test mode h:TX mode (Band 3) Keep the EUT in continuously transmitting mode with all modulation types. All data rates for each modulation type have been tested and found the data rate @ 6Mbps is the worst case of IEEE 802.11a; data rate @ MCS0 is the worst case of IEEE 802.11n(HT20); data rate @ MCS0 is the worst case of IEEE 802.11n(HT40); data rate @ MCS0 is the worst case of IEEE 802.11ac(VHT20); data rate @ MCS0 is the worst case of IEEE 802.11ac(VHT40); data rate @ MCS0 is the worst case of IEEE 802.11ac(VHT80). Only the data of worst case is recorded in the report.

7.5.2 Test Setup Diagram

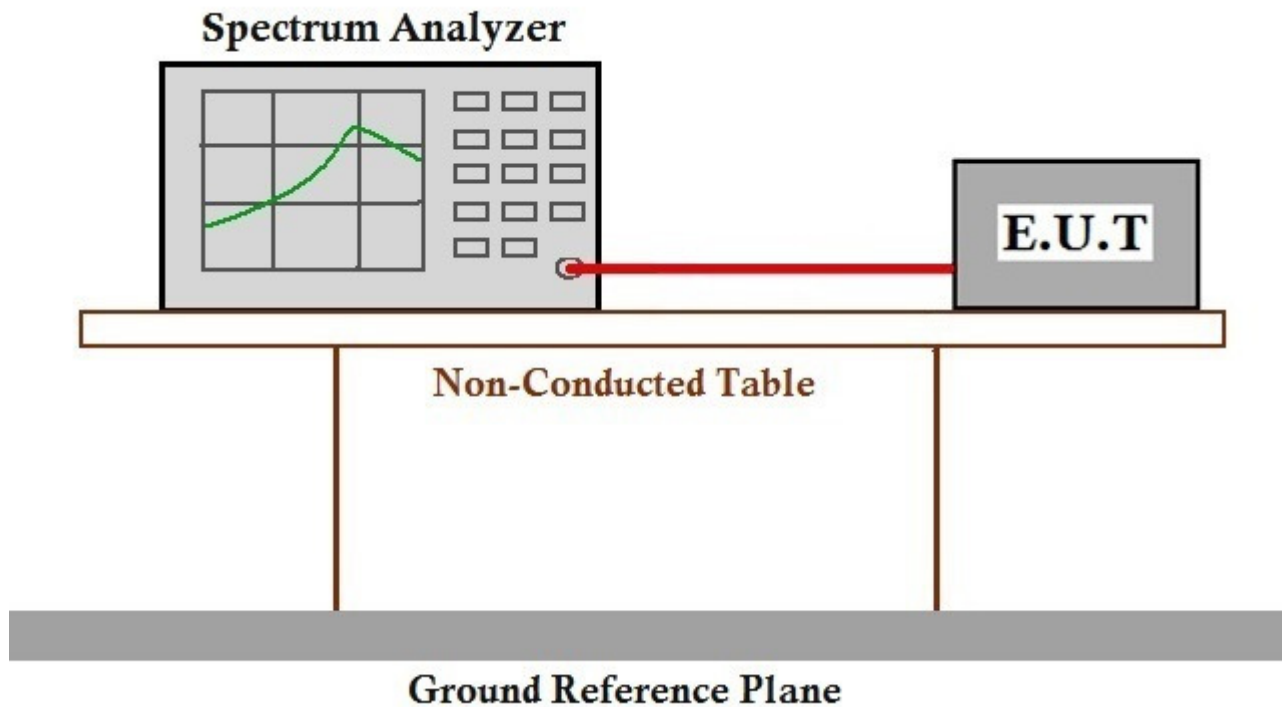

7.5.3 Measurement Procedure and Data

The detailed test data see: Appendix 15.407



7.6 Maximum Conducted output power

Test Requirement 47 CFR Part 15, Subpart C 15.407 (a)
Test Method: KDB 789033 D02 II E
Limit:

Frequency band(MHz)	Limit
5150-5250	≤1W(30dBm) for master device
	≤250mW(24dBm) for client device
5250-5350	≤250mW(24dBm) for client device or 11dBm+10logB*
5470-5725	≤250mW(24dBm) for client device or 11dBm+10logB*
5725-5850	≤1W(30dBm)
Remark:	* Where B is the 26dB emission bandwidth in MHz. The maximum conducted output power must be measured over any interval of continuous transmission using instrumentation calibrated in terms of an rms-equivalent voltage.

7.6.1 E.U.T. Operation

Operating Environment:

Temperature: 26.1 °C Humidity: 67.1 % RH Atmospheric Pressure: 1010 mbar

Pretest these modes to find the worst case:

e:TX mode (Band 1)_Keep the EUT in continuously transmitting mode with all modulation types. All data rates for each modulation type have been tested and found the data rate @ 6Mbps is the worst case of IEEE 802.11a; data rate @ MCS0 is the worst case of IEEE 802.11n(HT20); data rate @ MCS0 is the worst case of IEEE 802.11n(HT40); data rate @ MCS0 is the worst case of IEEE 802.11ac(VHT20); data rate @ MCS0 is the worst case of IEEE 802.11ac(VHT40); data rate @ MCS0 is the worst case of IEEE 802.11ac(VHT80). Only the data of worst case is recorded in the report.

f:TX mode (Band 2A)_Keep the EUT in continuously transmitting mode with all modulation types. All data rates for each modulation type have been tested and found the data rate @ 6Mbps is the worst case of IEEE 802.11a; data rate @ MCS0 is the worst case of IEEE 802.11n(HT20); data rate @ MCS0 is the worst case of IEEE 802.11n(HT40); data rate @ MCS0 is the worst case of IEEE 802.11ac(VHT20); data rate @ MCS0 is the worst case of IEEE 802.11ac(VHT40); data rate @ MCS0 is the worst case of IEEE 802.11ac(VHT80). Only the data of worst case is recorded in the report.

g:TX mode (Band 2C)_Keep the EUT in continuously transmitting mode with all modulation types. All data rates for each modulation type have been tested and found the data rate @ 6Mbps is the worst case of IEEE 802.11a; data rate @ MCS0 is the worst case of IEEE 802.11n(HT20); data rate @ MCS0 is the worst case of IEEE 802.11n(HT40); data rate @ MCS0 is the worst case of IEEE 802.11ac(VHT20); data rate @ MCS0 is the worst case of IEEE 802.11ac(VHT40); data rate @ MCS0 is the worst case of IEEE 802.11ac(VHT80). Only the data of worst case is recorded in the report.

h:TX mode (Band 3)_Keep the EUT in continuously transmitting mode with all modulation types. All data rates for each modulation type have been tested and found the data rate @ 6Mbps is the worst case of IEEE 802.11a; data rate @ MCS0 is the worst case of IEEE 802.11n(HT20); data rate @ MCS0 is the worst case of IEEE 802.11n(HT40); data rate @ MCS0 is the worst case of IEEE 802.11ac(VHT20); data rate @ MCS0 is the worst case of IEEE 802.11ac(VHT40); data rate @ MCS0 is the worst case of IEEE 802.11ac(VHT80). Only the data of worst case is recorded in the report.

The worst case for final test:

e:TX mode (Band 1)_Keep the EUT in continuously transmitting mode with all modulation types. All data rates for each modulation type have been tested and found the data rate @ 6Mbps is the worst case of IEEE 802.11a; data rate @ MCS0 is the worst case of IEEE 802.11n(HT20); data rate @ MCS0 is the worst case of IEEE 802.11n(HT40); data rate @ MCS0 is the worst case of IEEE 802.11ac(VHT20); data rate @ MCS0 is the worst case of IEEE 802.11ac(VHT40); data rate @ MCS0 is the worst case of IEEE 802.11ac(VHT80). Only the data of worst case is recorded in the report.

f:TX mode (Band 2A)_Keep the EUT in continuously transmitting mode with all modulation types. All data rates for each modulation type have been tested and found the data rate @ 6Mbps is the worst case of IEEE 802.11a; data rate @ MCS0 is the worst case of IEEE 802.11n(HT20); data rate @ MCS0 is the worst case of IEEE 802.11n(HT40); data rate @ MCS0 is the worst case of IEEE 802.11ac(VHT20); data rate @ MCS0 is the worst case of IEEE 802.11ac(VHT40); data rate @ MCS0 is the worst case of IEEE 802.11ac(VHT80). Only the data of worst case is recorded in the report.

g:TX mode (Band 2C)_Keep the EUT in continuously transmitting mode with all

modulation types. All data rates for each modulation type have been tested and found the data rate @ 6Mbps is the worst case of IEEE 802.11a; data rate @ MCS0 is the worst case of IEEE 802.11n(HT20); data rate @ MCS0 is the worst case of IEEE 802.11n(HT40); data rate @ MCS0 is the worst case of IEEE 802.11ac(VHT20); data rate @ MCS0 is the worst case of IEEE 802.11ac(VHT40); data rate @ MCS0 is the worst case of IEEE 802.11ac(VHT80). Only the data of worst case is recorded in the report.

h:TX mode (Band 3)_Keep the EUT in continuously transmitting mode with all modulation types. All data rates for each modulation type have been tested and found the data rate @ 6Mbps is the worst case of IEEE 802.11a; data rate @ MCS0 is the worst case of IEEE 802.11n(HT20); data rate @ MCS0 is the worst case of IEEE 802.11n(HT40); data rate @ MCS0 is the worst case of IEEE 802.11ac(VHT20); data rate @ MCS0 is the worst case of IEEE 802.11ac(VHT40); data rate @ MCS0 is the worst case of IEEE 802.11ac(VHT80). Only the data of worst case is recorded in the report.

7.6.2 Test Setup Diagram

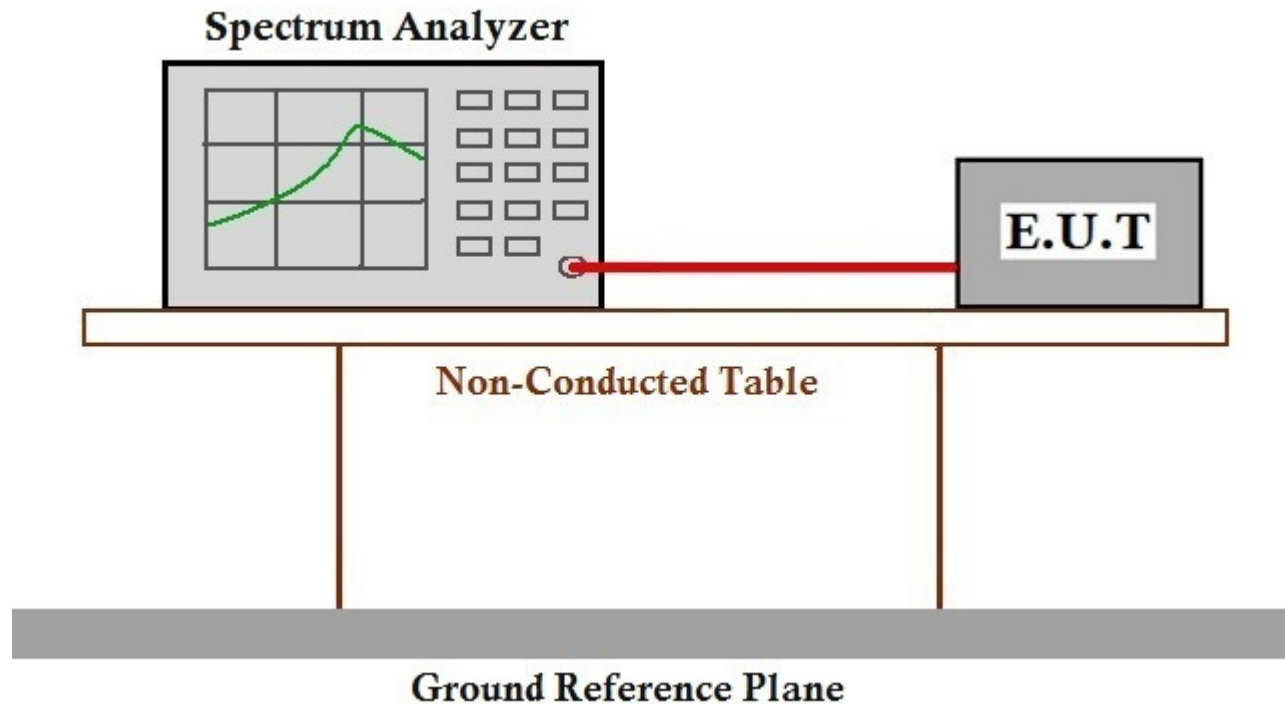

7.6.3 Measurement Procedure and Data

The detailed test data see: Appendix 15.407



7.7 Peak Power spectrum density

Test Requirement 47 CFR Part 15, Subpart C 15.407 (a)

Test Method: KDB 789033 D02 II F

Limit:

Frequency band(MHz)	Limit
5150-5250	≤17dBm in 1MHz for master device
	≤11dBm in 1MHz for client device
5250-5350	≤11dBm in 1MHz for client device
5470-5725	≤11dBm in 1MHz for client device
5725-5850	≤30dBm in 500 kHz
Remark:	The maximum power spectral density is measured as a conducted emission by direct connection of a calibrated test instrument to the equipment under test.



7.7.1 E.U.T. Operation

Operating Environment:

Temperature: 23.4 °C Humidity: 63.8 % RH Atmospheric Pressure: 1010 mbar

Pretest these modes to find the worst case:

e:TX mode (Band 1)_Keep the EUT in continuously transmitting mode with all modulation types. All data rates for each modulation type have been tested and found the data rate @ 6Mbps is the worst case of IEEE 802.11a; data rate @ MCS0 is the worst case of IEEE 802.11n(HT20); data rate @ MCS0 is the worst case of IEEE 802.11n(HT40); data rate @ MCS0 is the worst case of IEEE 802.11ac(VHT20); data rate @ MCS0 is the worst case of IEEE 802.11ac(VHT40); data rate @ MCS0 is the worst case of IEEE 802.11ac(VHT80). Only the data of worst case is recorded in the report.

f:TX mode (Band 2A)_Keep the EUT in continuously transmitting mode with all modulation types. All data rates for each modulation type have been tested and found the data rate @ 6Mbps is the worst case of IEEE 802.11a; data rate @ MCS0 is the worst case of IEEE 802.11n(HT20); data rate @ MCS0 is the worst case of IEEE 802.11n(HT40); data rate @ MCS0 is the worst case of IEEE 802.11ac(VHT20); data rate @ MCS0 is the worst case of IEEE 802.11ac(VHT40); data rate @ MCS0 is the worst case of IEEE 802.11ac(VHT80). Only the data of worst case is recorded in the report.

g:TX mode (Band 2C)_Keep the EUT in continuously transmitting mode with all modulation types. All data rates for each modulation type have been tested and found the data rate @ 6Mbps is the worst case of IEEE 802.11a; data rate @ MCS0 is the worst case of IEEE 802.11n(HT20); data rate @ MCS0 is the worst case of IEEE 802.11n(HT40); data rate @ MCS0 is the worst case of IEEE 802.11ac(VHT20); data rate @ MCS0 is the worst case of IEEE 802.11ac(VHT40); data rate @ MCS0 is the worst case of IEEE 802.11ac(VHT80). Only the data of worst case is recorded in the report.

h:TX mode (Band 3)_Keep the EUT in continuously transmitting mode with all modulation types. All data rates for each modulation type have been tested and found the data rate @ 6Mbps is the worst case of IEEE 802.11a; data rate @ MCS0 is the worst case of IEEE 802.11n(HT20); data rate @ MCS0 is the worst case of IEEE 802.11n(HT40); data rate @ MCS0 is the worst case of IEEE 802.11ac(VHT20); data rate @ MCS0 is the worst case of IEEE 802.11ac(VHT40); data rate @ MCS0 is the worst case of IEEE 802.11ac(VHT80). Only the data of worst case is recorded in the report.

The worst case for final test:

e:TX mode (Band 1)_Keep the EUT in continuously transmitting mode with all modulation types. All data rates for each modulation type have been tested and found the data rate @ 6Mbps is the worst case of IEEE 802.11a; data rate @ MCS0 is the worst case of IEEE 802.11n(HT20); data rate @ MCS0 is the worst case of IEEE 802.11n(HT40); data rate @ MCS0 is the worst case of IEEE 802.11ac(VHT20); data rate @ MCS0 is the worst case of IEEE 802.11ac(VHT40); data rate @ MCS0 is the worst case of IEEE 802.11ac(VHT80). Only the data of worst case is recorded in the report.

f:TX mode (Band 2A)_Keep the EUT in continuously transmitting mode with all modulation types. All data rates for each modulation type have been tested and found the data rate @ 6Mbps is the worst case of IEEE 802.11a; data rate @ MCS0 is the worst case of IEEE 802.11n(HT20); data rate @ MCS0 is the worst case of IEEE 802.11n(HT40); data rate @ MCS0 is the worst case of IEEE 802.11ac(VHT20); data rate @ MCS0 is the worst case of IEEE 802.11ac(VHT40); data rate @ MCS0 is the worst case of IEEE 802.11ac(VHT80). Only the data of worst case is recorded in the report.

g:TX mode (Band 2C)_Keep the EUT in continuously transmitting mode with all modulation types. All data rates for each modulation type have been tested and found the data rate @ 6Mbps is the worst case of IEEE 802.11a; data rate @

MCS0 is the worst case of IEEE 802.11n(HT20); data rate @ MCS0 is the worst case of IEEE 802.11n(HT40); data rate @ MCS0 is the worst case of IEEE 802.11ac(VHT20); data rate @ MCS0 is the worst case of IEEE 802.11ac(VHT40); data rate @ MCS0 is the worst case of IEEE 802.11ac(VHT80). Only the data of worst case is recorded in the report.

h:TX mode (Band 3)_Keep the EUT in continuously transmitting mode with all modulation types. All data rates for each modulation type have been tested and found the data rate @ 6Mbps is the worst case of IEEE 802.11a; data rate @ MCS0 is the worst case of IEEE 802.11n(HT20); data rate @ MCS0 is the worst case of IEEE 802.11n(HT40); data rate @ MCS0 is the worst case of IEEE 802.11ac(VHT20); data rate @ MCS0 is the worst case of IEEE 802.11ac(VHT40); data rate @ MCS0 is the worst case of IEEE 802.11ac(VHT80). Only the data of worst case is recorded in the report.

7.7.2 Test Setup Diagram

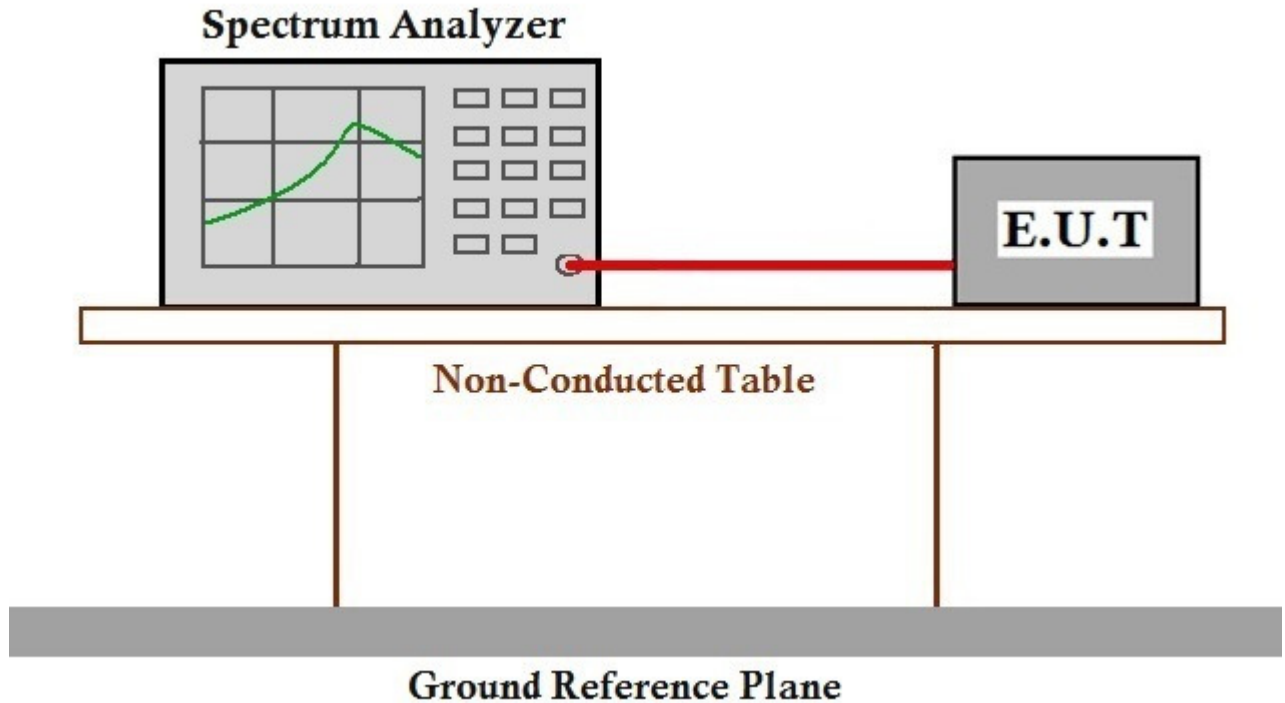

7.7.3 Measurement Procedure and Data

The detailed test data see: Appendix 15.407



7.8 DFS: Non-occupancy period

Test Requirement KDB 905462 D02 Section 5.1
Test Method: KDB 905462 D02 Section 7.8.3
Limit: Minimum 30 minutes

7.8.1 E.U.T. Operation

Operating Environment:

Temperature: 20 °C Humidity: 55.3 % RH Atmospheric Pressure: 1005 mbar

Test mode g:TX mode (Band 2C)_Keep the EUT in continuously transmitting mode with all modulation types. All data rates for each modulation type have been tested and found the data rate @ 6Mbps is the worst case of IEEE 802.11a; data rate @ MCS0 is the worst case of IEEE 802.11n(HT20); data rate @ MCS0 is the worst case of IEEE 802.11n(HT40); data rate @ MCS0 is the worst case of IEEE 802.11ac(VHT20); data rate @ MCS0 is the worst case of IEEE 802.11ac(VHT40); data rate @ MCS0 is the worst case of IEEE 802.11ac(VHT80). Only the data of worst case is recorded in the report.

7.8.2 Test Setup Diagram

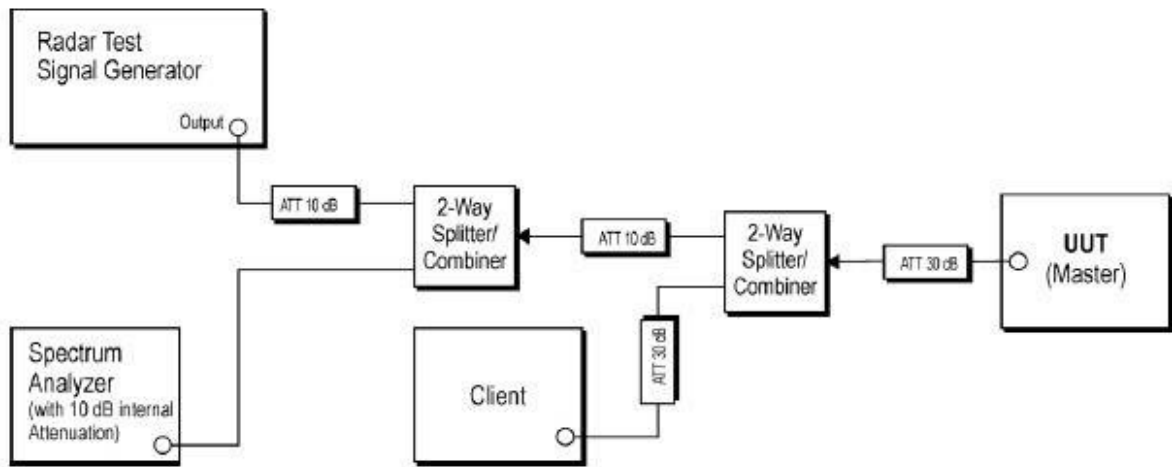

DFS master

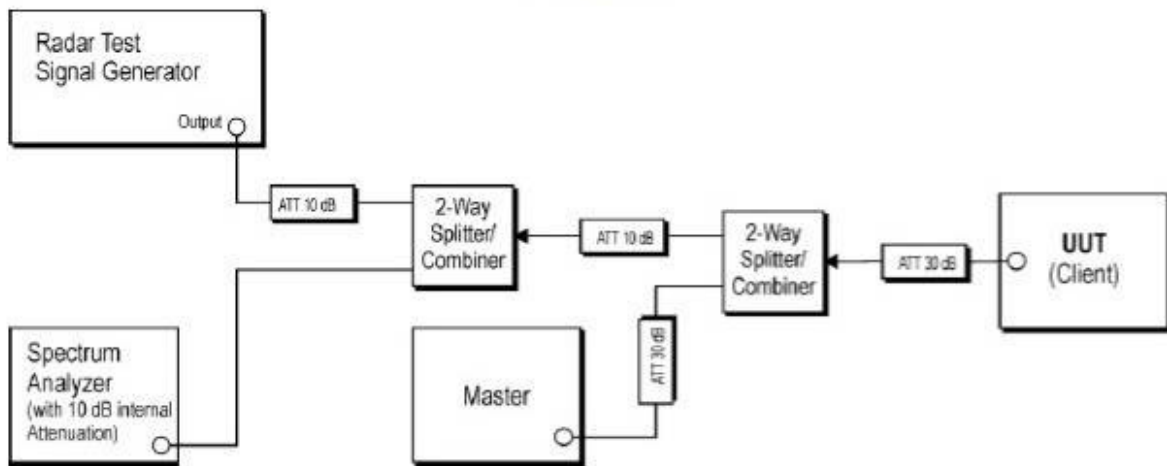

DFS slave with radar detection

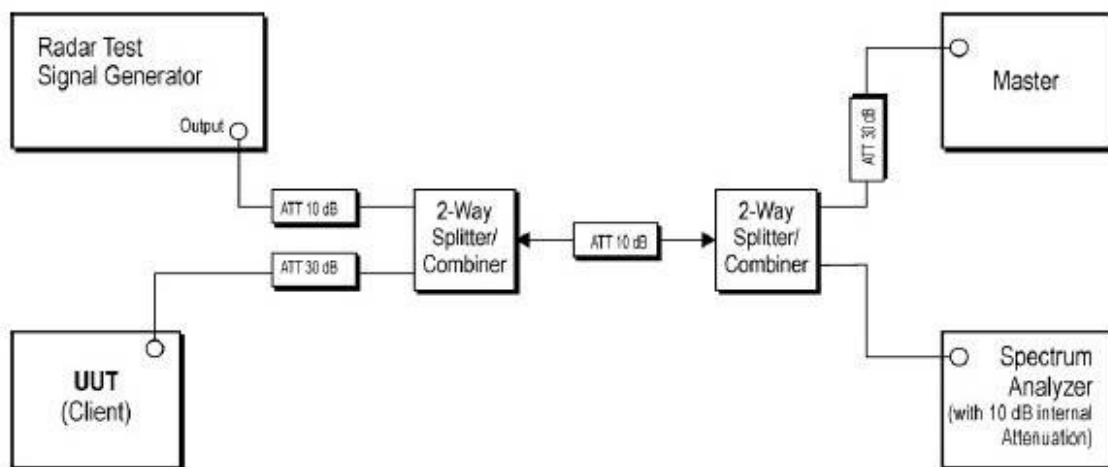

DFS slave without radar detection



7.8.3 Measurement Procedure and Data

- 1) The radar pulse generator is setup to provide a pulse at frequency that the master and client are operating. A type 0 radar pulse with a 1us pulse width and a 1428us PRI is used for the testing.
- 2) The vector signal generator is adjusted to provide the radar burst (18 pulses) at the level of approximately -61dBm at the antenna port of the master device.
- 3) A trigger is provided from the pulse generator to the DFS monitoring system in order to capture the traffic and the occurrence of the radar pulse.
- 4) EUT will associate with the master at channel. The file "iperf.exe" specified by the FCC is streamed from the PC 2 through the master and the client device to the PC 1 and played in full motion video using Media Player Classic Ver. 6.4.8.6 in order to properly load the network for the entire period of the test.
- 5) When radar burst with a level equal to the DFS Detection Threshold +1dB is generated on the operating channel of the U-NII device. At time T0 the radar waveform generator sends a burst of pulse of the radar waveform at Detection Threshold +1dB.
- 6) Observe the transmissions of the EUT at the end of the radar Burst on the Operating Channel. Measure and record the transmissions from the UUT during the observation time (Channel Move Time). One 15 seconds plot is reported for the Short Pulse Radar Type 0. The plot for the Short Pulse Radar Types start at the end of the radar burst. The Channel Move Time will be calculated based on the zoom in 600ms plot of the Short Pulse Radar Type.
- 7) Measurement of the aggregate duration of the Channel Closed Transmission Time method. With the spectrum analyzer set to zero span tuned to the center frequency of the EUT operating channel at the radar simulated frequency, peak detection, and max hold, the dwell time per bin is given by: $Dwell (0.3ms) = S (12000ms) / B (4000)$; where Dwell is the dwell time per spectrum analyzer sampling bin, S is sweep time and B is the number of spectrum analyzer sampling bins. An upper bound of the aggregate duration of the intermittent control signals of Channel Closing Transmission Time is calculated by: $C (ms) = N \times Dwell (0.3ms)$; where C is the Closing Time, N is the number of spectrum analyzer sampling bins (intermittent control signals) showing a U-NII transmission and Dwell is the dwell time per bin.
- 8) Measurement the EUT for more than 30 minutes following the channel move time to verify that no transmission or beacons occur on this channel.

The detailed test data see: Appendix 15.407



7.9 DFS: Channel Move Time

Test Requirement	KDB 905462 D02 Section 5.1
Test Method:	KDB 905462 D02 Section 7.8.3
Limit:	10 seconds(should be performed with Radar Type 0. The measurement timing begins at the end of the Radar Type 0 burst)

7.9.1 E.U.T. Operation

Operating Environment:

Temperature: 20 °C Humidity: 55.3 % RH Atmospheric Pressure: 1005 mbar

Pretest these modes to find the worst case: f:TX mode (Band 2A)_ Keep the EUT in continuously transmitting mode with all modulation types. All data rates for each modulation type have been tested and found the data rate @ 6Mbps is the worst case of IEEE 802.11a; data rate @ MCS0 is the worst case of IEEE 802.11n(HT20); data rate @ MCS0 is the worst case of IEEE 802.11n(HT40); data rate @ MCS0 is the worst case of IEEE 802.11ac(VHT20); data rate @ MCS0 is the worst case of IEEE 802.11ac(VHT40); data rate @ MCS0 is the worst case of IEEE 802.11ac(VHT80). Only the data of worst case is recorded in the report.

g:TX mode (Band 2C)_ Keep the EUT in continuously transmitting mode with all modulation types. All data rates for each modulation type have been tested and found the data rate @ 6Mbps is the worst case of IEEE 802.11a; data rate @ MCS0 is the worst case of IEEE 802.11n(HT20); data rate @ MCS0 is the worst case of IEEE 802.11n(HT40); data rate @ MCS0 is the worst case of IEEE 802.11ac(VHT20); data rate @ MCS0 is the worst case of IEEE 802.11ac(VHT40); data rate @ MCS0 is the worst case of IEEE 802.11ac(VHT80). Only the data of worst case is recorded in the report.

The worst case for final test:

f:TX mode (Band 2A)_ Keep the EUT in continuously transmitting mode with all modulation types. All data rates for each modulation type have been tested and found the data rate @ 6Mbps is the worst case of IEEE 802.11a; data rate @ MCS0 is the worst case of IEEE 802.11n(HT20); data rate @ MCS0 is the worst case of IEEE 802.11n(HT40); data rate @ MCS0 is the worst case of IEEE 802.11ac(VHT20); data rate @ MCS0 is the worst case of IEEE 802.11ac(VHT40); data rate @ MCS0 is the worst case of IEEE 802.11ac(VHT80). Only the data of worst case is recorded in the report.

g:TX mode (Band 2C)_ Keep the EUT in continuously transmitting mode with all modulation types. All data rates for each modulation type have been tested and found the data rate @ 6Mbps is the worst case of IEEE 802.11a; data rate @ MCS0 is the worst case of IEEE 802.11n(HT20); data rate @ MCS0 is the worst case of IEEE 802.11n(HT40); data rate @ MCS0 is the worst case of IEEE 802.11ac(VHT20); data rate @ MCS0 is the worst case of IEEE 802.11ac(VHT40); data rate @ MCS0 is the worst case of IEEE 802.11ac(VHT80). Only the data of worst case is recorded in the report.

7.9.2 Test Setup Diagram

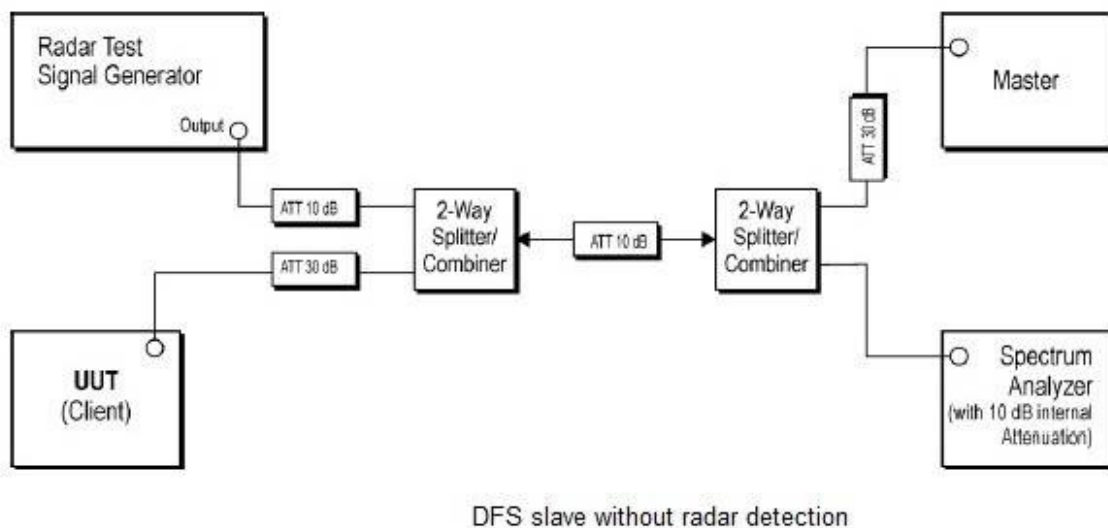
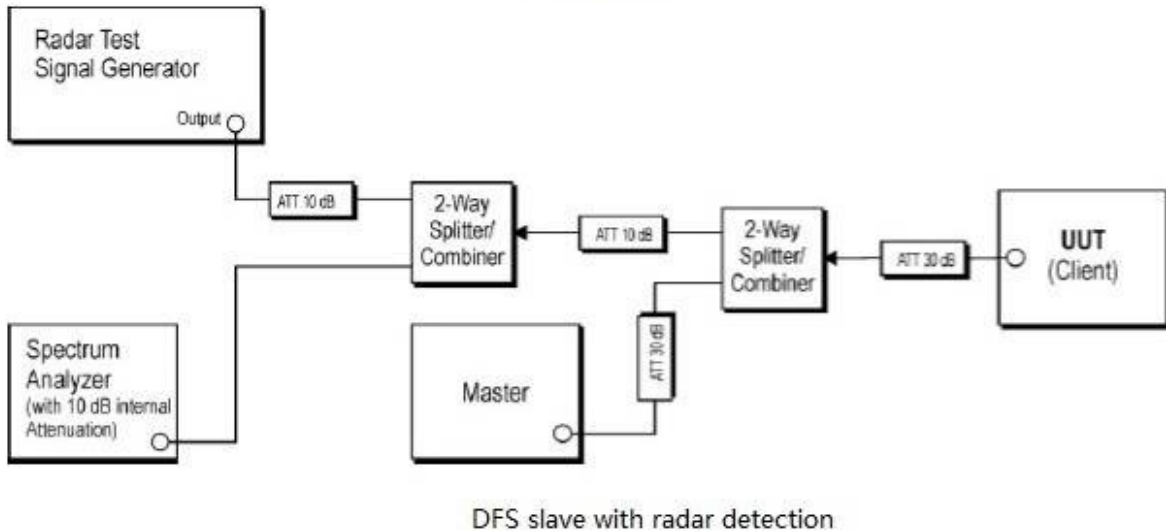
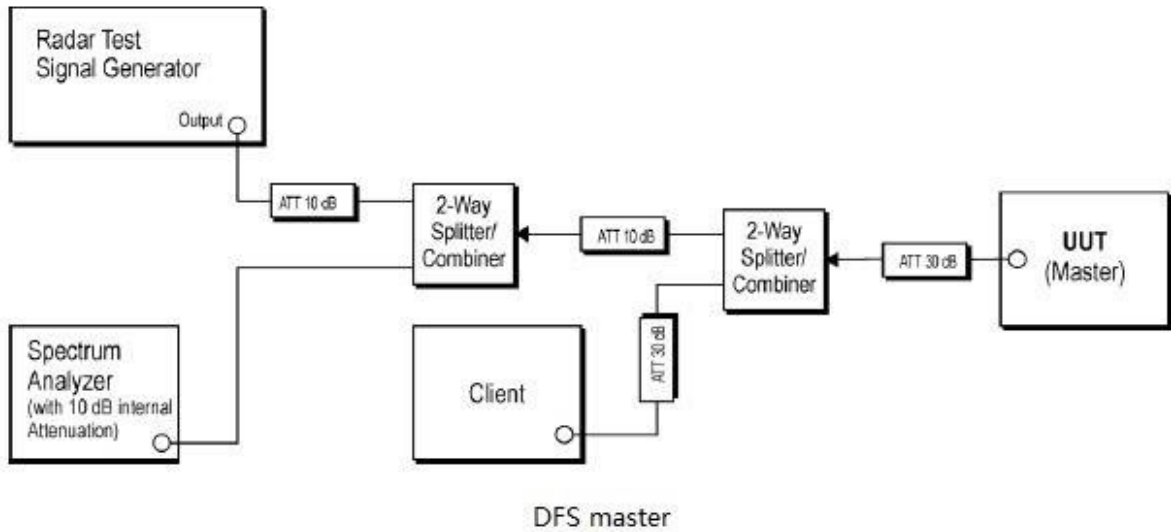



7.9.3 Measurement Procedure and Data

- 1) The radar pulse generator is setup to provide a pulse at frequency that the master and client are operating. A type 0 radar pulse with a 1us pulse width and a 1428us PRI is used for the testing.
- 2) The vector signal generator is adjusted to provide the radar burst (18 pulses) at the level of approximately -61dBm at the antenna port of the master device.
- 3) A trigger is provided from the pulse generator to the DFS monitoring system in order to capture the traffic and the occurrence of the radar pulse.
- 4) EUT will associate with the master at channel. The file "iperf.exe" specified by the FCC is streamed from the PC 2 through the master and the client device to the PC 1 and played in full motion video using Media Player Classic Ver. 6.4.8.6 in order to properly load the network for the entire period of the test.
- 5) When radar burst with a level equal to the DFS Detection Threshold +1dB is generated on the operating channel of the U-NII device. At time T0 the radar waveform generator sends a burst of pulse of the radar waveform at Detection Threshold +1dB.
- 6) Observe the transmissions of the EUT at the end of the radar Burst on the Operating Channel. Measure and record the transmissions from the UUT during the observation time (Channel Move Time). One 15 seconds plot is reported for the Short Pulse Radar Type 0. The plot for the Short Pulse Radar Types start at the end of the radar burst. The Channel Move Time will be calculated based on the zoom in 600ms plot of the Short Pulse Radar Type.
- 7) Measurement of the aggregate duration of the Channel Closed Transmission Time method. With the spectrum analyzer set to zero span tuned to the center frequency of the EUT operating channel at the radar simulated frequency, peak detection, and max hold, the dwell time per bin is given by: $Dwell (0.3ms) = S (12000ms) / B (4000)$; where Dwell is the dwell time per spectrum analyzer sampling bin, S is sweep time and B is the number of spectrum analyzer sampling bins. An upper bound of the aggregate duration of the intermittent control signals of Channel Closing Transmission Time is calculated by: $C (ms) = N \times Dwell (0.3ms)$; where C is the Closing Time, N is the number of spectrum analyzer sampling bins (intermittent control signals) showing a U-NII transmission and Dwell is the dwell time per bin.
- 8) Measurement the EUT for more than 30 minutes following the channel move time to verify that no transmission or beacons occur on this channel.

The detailed test data see: Appendix 15.407

7.10 DFS: Channel Closing Transmission Time

Test Requirement	KDB 905462 D02 Section 5.1
Test Method:	KDB 905462 D02 Section 7.8.3
Limit:	200 milliseconds + an aggregate of 60 milliseconds over remaining 10 second period(should be performed with Radar Type 0. The measurement timing begins at the end of the Radar Type 0 burst. It is comprised of 200 milliseconds starting at the beginning of the Channel Move Time plus any additional intermittent control signals required facilitating a Channel move (an aggregate of 60 milliseconds) during the remainder of the 10 second period. The aggregate duration of control signals will not count quiet periods in between transmissions)

7.10.1 E.U.T. Operation

Operating Environment:

Temperature: 20 °C Humidity: 55.3 % RH Atmospheric Pressure: 1005 mbar

Pretest these modes to find the worst case: f:TX mode (Band 2A)_Keep the EUT in continuously transmitting mode with all modulation types. All data rates for each modulation type have been tested and found the data rate @ 6Mbps is the worst case of IEEE 802.11a; data rate @ MCS0 is the worst case of IEEE 802.11n(HT20); data rate @ MCS0 is the worst case of IEEE 802.11n(HT40); data rate @ MCS0 is the worst case of IEEE 802.11ac(VHT20); data rate @ MCS0 is the worst case of IEEE 802.11ac(VHT40); data rate @ MCS0 is the worst case of IEEE 802.11ac(VHT80). Only the data of worst case is recorded in the report.

g:TX mode (Band 2C)_Keep the EUT in continuously transmitting mode with all modulation types. All data rates for each modulation type have been tested and found the data rate @ 6Mbps is the worst case of IEEE 802.11a; data rate @ MCS0 is the worst case of IEEE 802.11n(HT20); data rate @ MCS0 is the worst case of IEEE 802.11n(HT40); data rate @ MCS0 is the worst case of IEEE 802.11ac(VHT20); data rate @ MCS0 is the worst case of IEEE 802.11ac(VHT40); data rate @ MCS0 is the worst case of IEEE 802.11ac(VHT80). Only the data of worst case is recorded in the report.

The worst case for final test: f:TX mode (Band 2A)_Keep the EUT in continuously transmitting mode with all modulation types. All data rates for each modulation type have been tested and found the data rate @ 6Mbps is the worst case of IEEE 802.11a; data rate @ MCS0 is the worst case of IEEE 802.11n(HT20); data rate @ MCS0 is the worst case of IEEE 802.11n(HT40); data rate @ MCS0 is the worst case of IEEE 802.11ac(VHT20); data rate @ MCS0 is the worst case of IEEE 802.11ac(VHT40); data rate @ MCS0 is the worst case of IEEE 802.11ac(VHT80). Only the data of worst case is recorded in the report.

g:TX mode (Band 2C)_Keep the EUT in continuously transmitting mode with all modulation types. All data rates for each modulation type have been tested and found the data rate @ 6Mbps is the worst case of IEEE 802.11a; data rate @ MCS0 is the worst case of IEEE 802.11n(HT20); data rate @ MCS0 is the worst case of IEEE 802.11n(HT40); data rate @ MCS0 is the worst case of IEEE 802.11ac(VHT20); data rate @ MCS0 is the worst case of IEEE 802.11ac(VHT40); data rate @ MCS0 is the worst case of IEEE 802.11ac(VHT80). Only the data of worst case is recorded in the report.

7.10.2 Test Setup Diagram

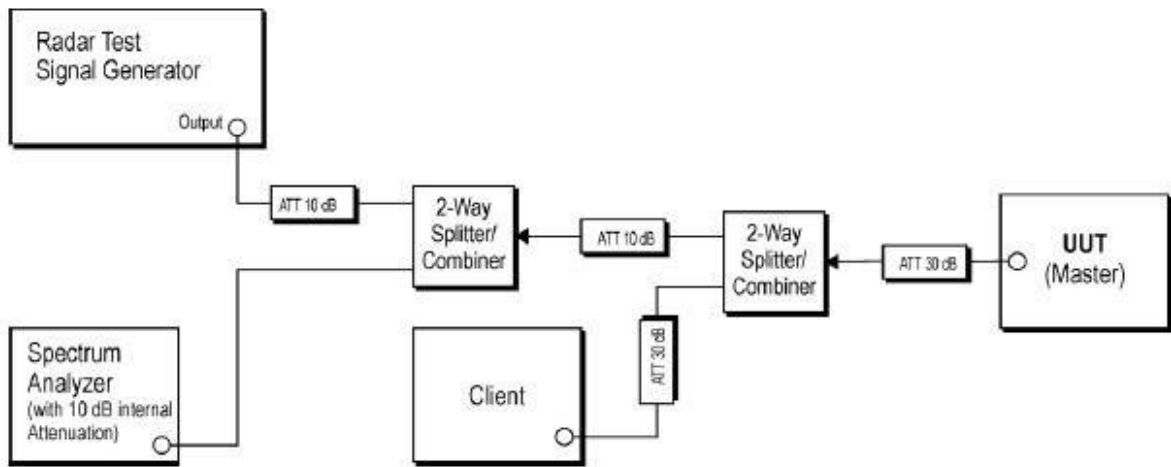

DFS master

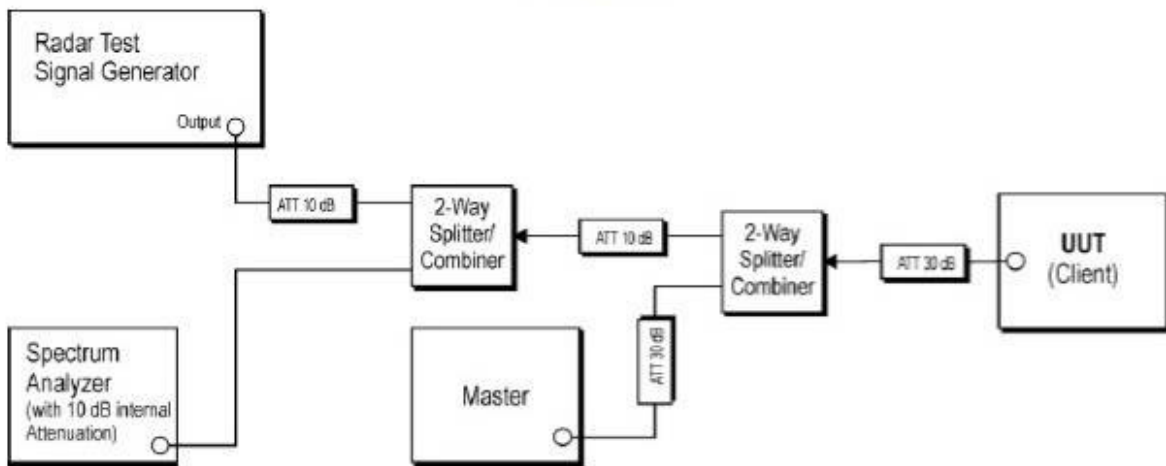

DFS slave with radar detection

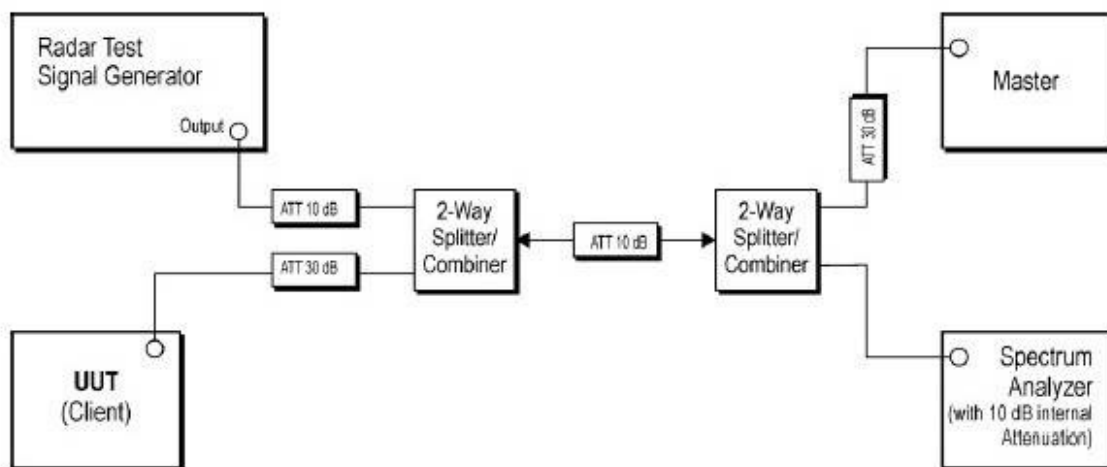

DFS slave without radar detection

7.10.3 Measurement Procedure and Data

- 1) The radar pulse generator is setup to provide a pulse at frequency that the master and client are operating. A type 0 radar pulse with a 1us pulse width and a 1428us PRI is used for the testing.
- 2) The vector signal generator is adjusted to provide the radar burst (18 pulses) at the level of approximately -61dBm at the antenna port of the master device.
- 3) A trigger is provided from the pulse generator to the DFS monitoring system in order to capture the traffic and the occurrence of the radar pulse.
- 4) EUT will associate with the master at channel. The file "iperf.exe" specified by the FCC is streamed from the PC 2 through the master and the client device to the PC 1 and played in full motion video using Media Player Classic Ver. 6.4.8.6 in order to properly load the network for the entire period of the test.
- 5) When radar burst with a level equal to the DFS Detection Threshold +1dB is generated on the operating channel of the U-NII device. At time T0 the radar waveform generator sends a burst of pulse of the radar waveform at Detection Threshold +1dB.
- 6) Observe the transmissions of the EUT at the end of the radar Burst on the Operating Channel. Measure and record the transmissions from the UUT during the observation time (Channel Move Time). One 15 seconds plot is reported for the Short Pulse Radar Type 0. The plot for the Short Pulse Radar Types start at the end of the radar burst. The Channel Move Time will be calculated based on the zoom in 600ms plot of the Short Pulse Radar Type.
- 7) Measurement of the aggregate duration of the Channel Closed Transmission Time method. With the spectrum analyzer set to zero span tuned to the center frequency of the EUT operating channel at the radar simulated frequency, peak detection, and max hold, the dwell time per bin is given by: $Dwell (0.3ms) = S (12000ms) / B (4000)$; where Dwell is the dwell time per spectrum analyzer sampling bin, S is sweep time and B is the number of spectrum analyzer sampling bins. An upper bound of the aggregate duration of the intermittent control signals of Channel Closing Transmission Time is calculated by: $C (ms) = N \times Dwell (0.3ms)$; where C is the Closing Time, N is the number of spectrum analyzer sampling bins (intermittent control signals) showing a U-NII transmission and Dwell is the dwell time per bin.
- 8) Measurement the EUT for more than 30 minutes following the channel move time to verify that no transmission or beacons occur on this channel.

The detailed test data see: Appendix 15.407

7.11 Radiated Emissions

Test Requirement 47 CFR Part 15, Subpart C 15.209 & 15.407(b)
Test Method: KDB 789033 D02 II G
Measurement Distance: 3m

Frequency(MHz)	Field strength(microvolts/meter)	Measurement distance(meters)
0.009-0.490	2400/F(kHz)	300
0.490-1.705	24000/F(kHz)	30
1.705-30.0	30	30
30-88	100	3
88-216	150	3
216-960	200	3
Above 960	500	3

*(1) For transmitters operating in the 5.15-5.25 GHz band: All emissions outside of the 5.15-5.35 GHz band shall not exceed an e.i.r.p. of -27 dBm/MHz.

(2) For transmitters operating in the 5.25-5.35 GHz band: All emissions outside of the 5.15-5.35 GHz band shall not exceed an e.i.r.p. of -27 dBm/MHz.

(3) For transmitters operating in the 5.47-5.725 GHz band: All emissions outside of the 5.47-5.725 GHz band shall not exceed an e.i.r.p. of -27 dBm/MHz.

(4) For transmitters operating in the 5.725-5.85 GHz band:

(i) All emissions shall be limited to a level of -27 dBm/MHz at 75 MHz or more above or below the band edge increasing linearly to 10 dBm/MHz at 25 MHz above or below the band edge, and from 25 MHz above or below the band edge increasing linearly to a level of 15.6 dBm/MHz at 5 MHz above or below the band edge, and from 5 MHz above or below the band edge increasing linearly to a level of 27 dBm/MHz at the band edge.

Remark: The emission limits shown in the above table are based on measurements employing a CISPR quasi-peak detector except for the frequency bands 9-90kHz, 110-490kHz and above 1000 MHz. Radiated emission limits in these three bands are based on measurements employing an average detector, the peak field strength of any emission shall not exceed the maximum permitted average limits specified above by more than 20 dB under any condition of modulation.



7.11.1 E.U.T. Operation

Operating Environment:

Temperature: 25 °C Humidity: 51 % RH Atmospheric Pressure: 1015 mbar

Pretest these modes to find the worst case:

e:TX mode (Band 1)_Keep the EUT in continuously transmitting mode with all modulation types. All data rates for each modulation type have been tested and found the data rate @ 6Mbps is the worst case of IEEE 802.11a; data rate @ MCS0 is the worst case of IEEE 802.11n(HT20); data rate @ MCS0 is the worst case of IEEE 802.11n(HT40); data rate @ MCS0 is the worst case of IEEE 802.11ac(VHT20); data rate @ MCS0 is the worst case of IEEE 802.11ac(VHT40); data rate @ MCS0 is the worst case of IEEE 802.11ac(VHT80). Only the data of worst case is recorded in the report.

f:TX mode (Band 2A)_Keep the EUT in continuously transmitting mode with all modulation types. All data rates for each modulation type have been tested and found the data rate @ 6Mbps is the worst case of IEEE 802.11a; data rate @ MCS0 is the worst case of IEEE 802.11n(HT20); data rate @ MCS0 is the worst case of IEEE 802.11n(HT40); data rate @ MCS0 is the worst case of IEEE 802.11ac(VHT20); data rate @ MCS0 is the worst case of IEEE 802.11ac(VHT40); data rate @ MCS0 is the worst case of IEEE 802.11ac(VHT80). Only the data of worst case is recorded in the report.

g:TX mode (Band 2C)_Keep the EUT in continuously transmitting mode with all modulation types. All data rates for each modulation type have been tested and found the data rate @ 6Mbps is the worst case of IEEE 802.11a; data rate @ MCS0 is the worst case of IEEE 802.11n(HT20); data rate @ MCS0 is the worst case of IEEE 802.11n(HT40); data rate @ MCS0 is the worst case of IEEE 802.11ac(VHT20); data rate @ MCS0 is the worst case of IEEE 802.11ac(VHT40); data rate @ MCS0 is the worst case of IEEE 802.11ac(VHT80). Only the data of worst case is recorded in the report.

h:TX mode (Band 3)_Keep the EUT in continuously transmitting mode with all modulation types. All data rates for each modulation type have been tested and found the data rate @ 6Mbps is the worst case of IEEE 802.11a; data rate @ MCS0 is the worst case of IEEE 802.11n(HT20); data rate @ MCS0 is the worst case of IEEE 802.11n(HT40); data rate @ MCS0 is the worst case of IEEE 802.11ac(VHT20); data rate @ MCS0 is the worst case of IEEE 802.11ac(VHT40); data rate @ MCS0 is the worst case of IEEE 802.11ac(VHT80). Only the data of worst case is recorded in the report.

The worst case for final test:

e:TX mode (Band 1)_Keep the EUT in continuously transmitting mode with all modulation types. All data rates for each modulation type have been tested and found the data rate @ 6Mbps is the worst case of IEEE 802.11a; data rate @ MCS0 is the worst case of IEEE 802.11n(HT20); data rate @ MCS0 is the worst case of IEEE 802.11n(HT40); data rate @ MCS0 is the worst case of IEEE 802.11ac(VHT20); data rate @ MCS0 is the worst case of IEEE 802.11ac(VHT40); data rate @ MCS0 is the worst case of IEEE 802.11ac(VHT80). Only the data of worst case is recorded in the report.

f:TX mode (Band 2A)_Keep the EUT in continuously transmitting mode with all modulation types. All data rates for each modulation type have been tested and found the data rate @ 6Mbps is the worst case of IEEE 802.11a; data rate @ MCS0 is the worst case of IEEE 802.11n(HT20); data rate @ MCS0 is the worst case of IEEE 802.11n(HT40); data rate @ MCS0 is the worst case of IEEE 802.11ac(VHT20); data rate @ MCS0 is the worst case of IEEE 802.11ac(VHT40); data rate @ MCS0 is the worst case of IEEE 802.11ac(VHT80). Only the data of worst case is recorded in the report.

g:TX mode (Band 2C)_Keep the EUT in continuously transmitting mode with all modulation types. All data rates for each modulation type have been tested and

found the data rate @ 6Mbps is the worst case of IEEE 802.11a; data rate @ MCS0 is the worst case of IEEE 802.11n(HT20); data rate @ MCS0 is the worst case of IEEE 802.11n(HT40); data rate @ MCS0 is the worst case of IEEE 802.11ac(VHT20); data rate @ MCS0 is the worst case of IEEE 802.11ac(VHT40); data rate @ MCS0 is the worst case of IEEE 802.11ac(VHT80). Only the data of worst case is recorded in the report.

h:TX mode (Band 3)_Keep the EUT in continuously transmitting mode with all modulation types. All data rates for each modulation type have been tested and found the data rate @ 6Mbps is the worst case of IEEE 802.11a; data rate @ MCS0 is the worst case of IEEE 802.11n(HT20); data rate @ MCS0 is the worst case of IEEE 802.11n(HT40); data rate @ MCS0 is the worst case of IEEE 802.11ac(VHT20); data rate @ MCS0 is the worst case of IEEE 802.11ac(VHT40); data rate @ MCS0 is the worst case of IEEE 802.11ac(VHT80). Only the data of worst case is recorded in the report.

7.11.2 Test Setup Diagram

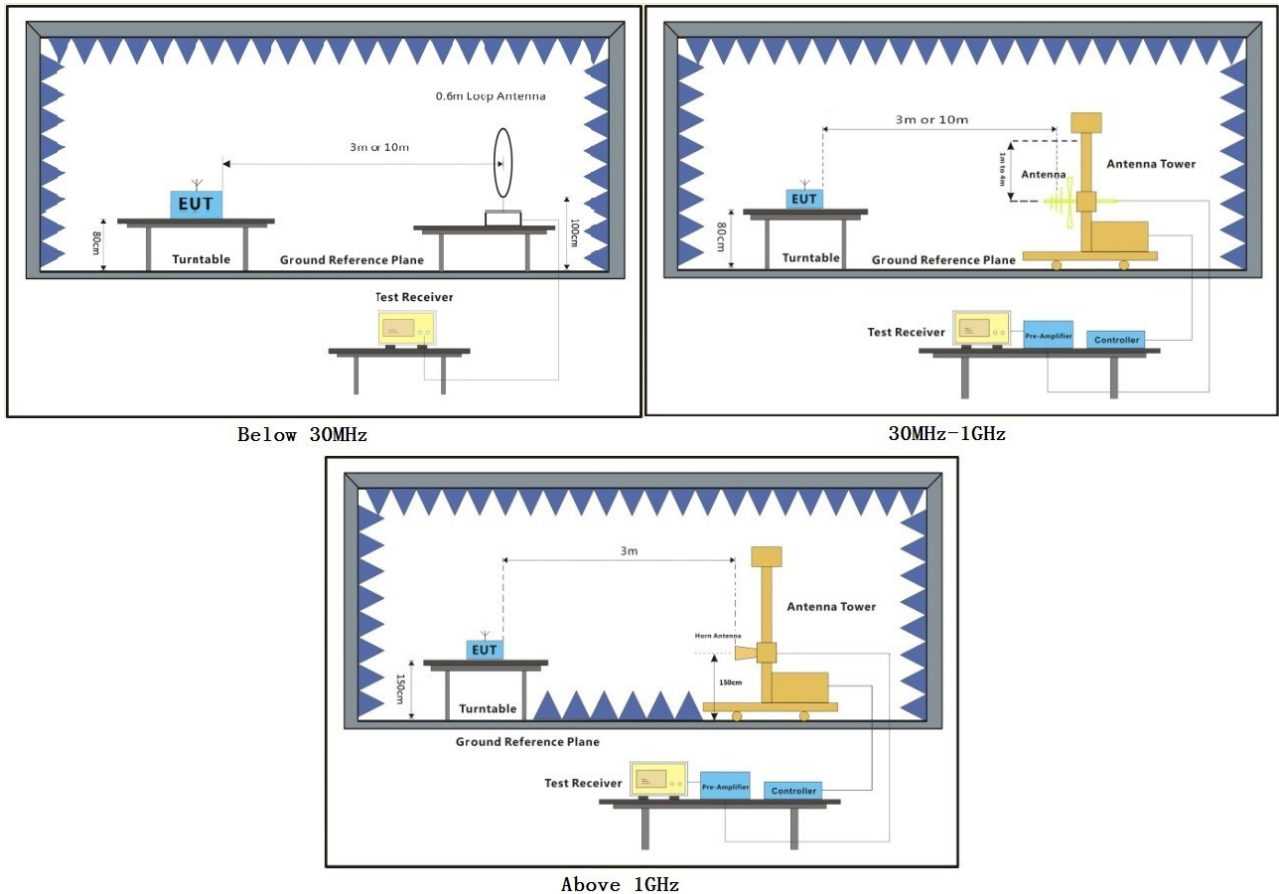

7.11.3 Measurement Procedure and Data

- a. For below 1GHz, the EUT was placed on the top of a rotating table 0.8 meters above the ground at a 3 or 10 meter semi-anechoic chamber. The table was rotated 360 degrees to determine the position of the highest radiation.
- b. For above 1GHz, the EUT was placed on the top of a rotating table 1.5 meters above the ground at a 3 meter fully-anechoic chamber. The table was rotated 360 degrees to determine the position of the highest radiation.
- c. The EUT was set 3 or 10 meters away from the interference-receiving antenna, which was mounted on the top of a variable-height antenna tower.
- d. The antenna height is varied from one meter to four meters above the ground to determine the maximum value of the field strength. Both horizontal and vertical polarizations of the antenna are set to make the measurement.
- e. For each suspected emission, the EUT was arranged to its worst case and then the antenna was tuned to heights from 1 meter to 4 meters (for the test frequency of below 30MHz, the antenna was tuned to heights 1 meter) and the rotatable table was turned from 0 degrees to 360 degrees to find the maximum reading.
- f. The test-receiver system was set to Peak Detect Function and Specified Bandwidth with Maximum Hold Mode.
- g. If the emission level of the EUT in peak mode was 10dB lower than the limit specified, then testing could be stopped and the peak values of the EUT would be reported. Otherwise the emissions that did not have 10dB margin would be re-tested one by one using peak, quasi-peak or average method as specified and then reported in a data sheet.
- h. Test the EUT in the lowest channel, the middle channel, the Highest channel.
- i. The radiation measurements are performed in X, Y, Z axis positioning for Transmitting mode, and found the X axis positioning which it is the worst case.
- j. Repeat above procedures until all frequencies measured was complete.

Remark:

1. Level= Read Level+ Cable Loss+ Antenna Factor- Preamp Factor
2. For emission below 1GHz, through the pre-scan found the worst case is the lowest channel of 802.11a. Only the worst case is recorded in the report.
3. Scan from 9kHz to 40GHz, the disturbance above 18GHz and below 30MHz was very low. The points marked on above plots are the highest emissions could be found when testing, so only above points had been displayed. The amplitude of spurious emissions from the radiator which are attenuated more than 20dB below the limit need not be reported.
4. As shown in this section, for frequencies above 1GHz, the field strength limits are based on average limits. However, the peak field strength of any emission shall not exceed the maximum permitted average limits specified above by more than 20 dB under any condition of modulation. For the emissions whose peak level is lower than the average limit, only the peak measurement is shown in the report.

Pretest the EUT at antenna 1 and antenna 2 and found the antenna 2 which is worst case for 802.11a mode, Pretest the EUT at antenna 1, antenna 2 and MIMO mode and found the MIMO mode which is worst case for 802.11n/ac mode; So, Only the worst test data is recorded in the report.

Radiated emission below 1GHz

Mode:e; Polarization:Horizontal

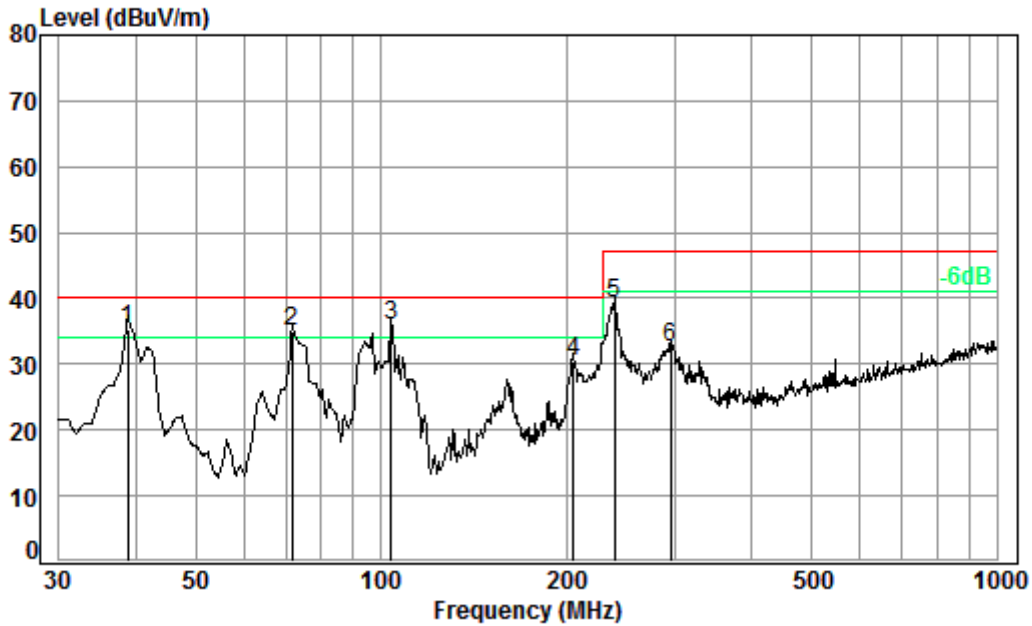

Condition: 3m HORIZONTAL

Job No. : 04057CR

Test mode: e

	Freq	Cable Loss	Ant Factor	Preamp Factor	Read Level	Level	Limit Line	Over Limit
	MHz	dB	dB/m	dB	dBuV	dBuV/m	dBuV/m	dB
1	38.74	0.60	18.06	27.43	44.05	35.28	40.00	-4.72
2	71.73	0.86	12.65	27.38	48.70	34.83	40.00	-5.17
3 pp	103.84	1.21	13.81	27.33	48.13	35.82	40.00	-4.18
4	205.68	1.43	16.71	26.88	39.27	30.53	40.00	-9.47
5	239.15	1.62	18.73	26.79	45.71	39.27	47.00	-7.73
6	295.14	1.88	19.41	26.65	37.87	32.51	47.00	-14.49

Mode:e; Polarization:Vertical

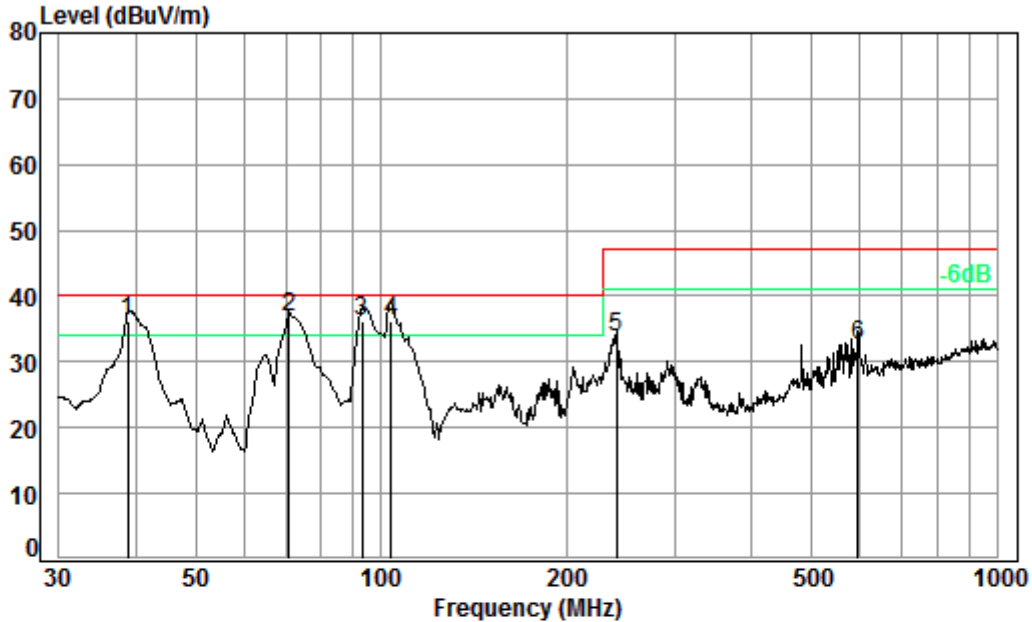

Condition: 3m VERTICAL
 Job No. : 04057CR
 Test mode: e

	Freq	Cable Loss	Ant Factor	Preamp Factor	Read Level	Level	Limit Line	Over Limit
	MHz	dB	dB/m	dB	dBuV	dBuV/m	dBuV/m	dB
1	38.74	0.60	18.06	27.43	44.93	36.16	40.00	-3.84
2 pp	70.82	0.82	12.73	27.38	50.61	36.78	40.00	-3.22
3	93.21	1.13	13.40	27.36	49.03	36.20	40.00	-3.80
4	103.82	1.21	13.82	27.33	48.50	36.20	40.00	-3.80
5	240.82	1.63	18.81	26.78	39.99	33.65	47.00	-13.35
6	595.13	2.70	26.51	27.93	31.34	32.62	47.00	-14.38



Mode:e; Polarization:Horizontal; Modulation:802.11a; bandwidth:20MHz; Channel:Low

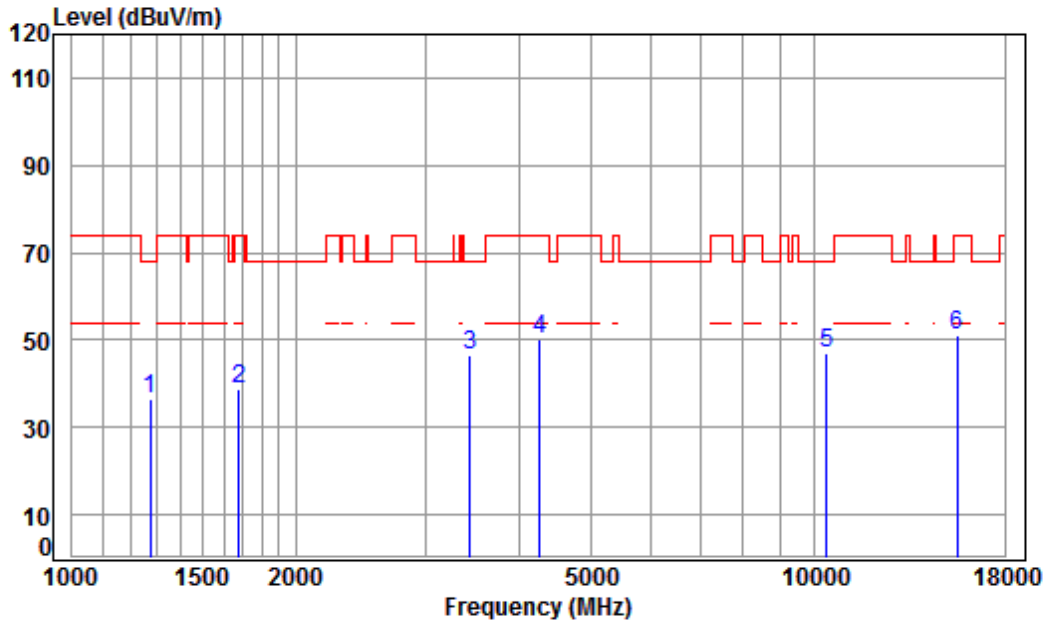

Condition: 3m HORIZONTAL
Job No : 04056CR/04057CR
Mode : 5180 TX RSE
Note : 5G WIFI 11A

	Freq	Cable Loss	Ant Factor	Preamp Factor	Read Level	Level	Limit	Over	Remark
	MHz	dB	dB/m	dB	dBuV	dBuV/m	dBuV/m	dB	
1	1274.802	4.71	24.84	38.06	44.83	36.32	68.20	-31.88	peak
2	1677.621	5.25	26.58	38.03	44.97	38.77	74.00	-35.23	peak
3	3435.590	6.40	32.09	37.95	46.00	46.54	68.20	-21.66	peak
4	4267.237	7.30	33.60	38.14	47.62	50.38	74.00	-23.62	peak
5	pp10360.000	11.19	37.24	35.09	33.80	47.14	68.20	-21.06	peak
6	15540.000	14.30	41.38	38.30	33.86	51.24	74.00	-22.76	peak



Mode:e; Polarization:Vertical; Modulation:802.11a; bandwidth:20MHz; Channel:Low

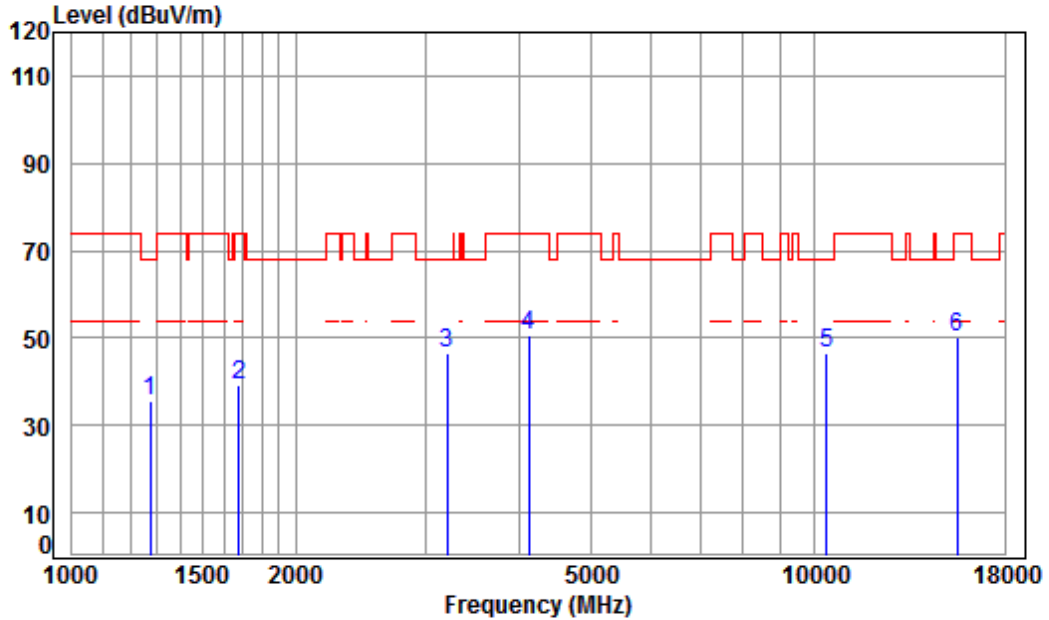

Condition: 3m VERTICAL
Job No : 04056CR/04057CR
Mode : 5180 TX RSE
Note : 5G WIFI 11A

	Freq	Cable Loss	Ant Factor	Preamp Factor	Read Level	Limit Level	Limit Line	Over Limit	Remark
	MHz	dB	dB/m	dB	dBuV	dBuV/m	dBuV/m	dB	
1	1274.802	4.71	24.84	38.06	44.05	35.54	68.20	-32.66	peak
2	1677.621	5.25	26.58	38.03	45.24	39.04	74.00	-34.96	peak
3	pp 3196.094	6.18	31.67	37.92	46.70	46.63	68.20	-21.57	peak
4	4121.768	7.13	33.60	38.07	48.16	50.82	74.00	-23.18	peak
5	10360.000	11.19	37.24	35.09	33.13	46.47	68.20	-21.73	peak
6	15540.000	14.30	41.38	38.30	32.93	50.31	74.00	-23.69	peak



Mode:e; Polarization:Horizontal; Modulation:802.11a; bandwidth:20MHz; Channel:middle

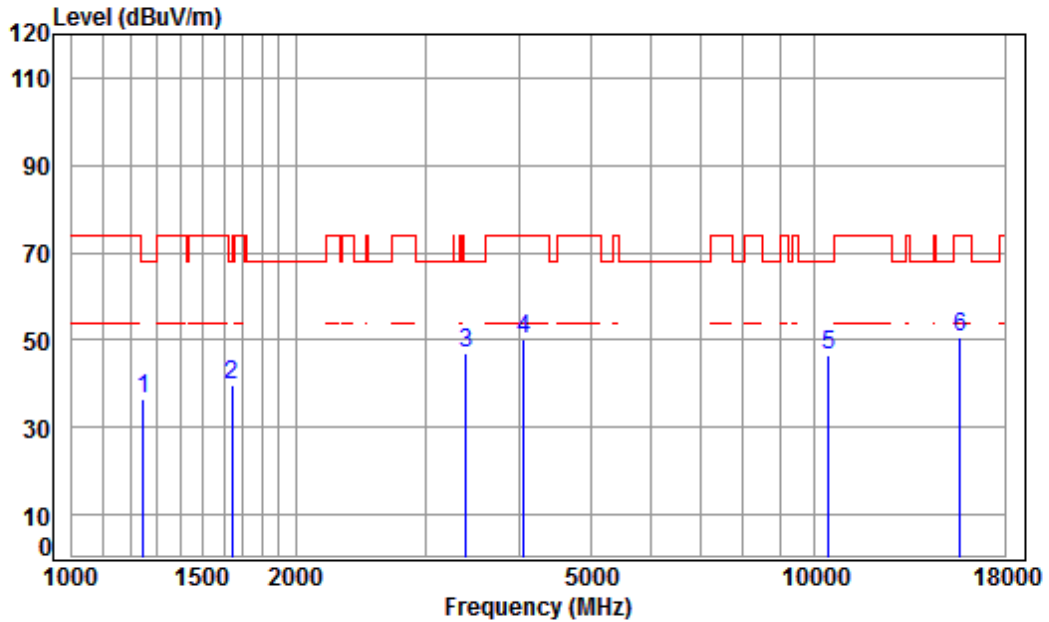

Condition: 3m HORIZONTAL
Job No : 04056CR/04057CR
Mode : 5220 TX RSE
Note : 5G WIFI 11A

	Freq	Cable Loss	Ant Factor	Preamp Factor	Read Level	Level	Limit	Over	Remark
	MHz	dB	dB/m	dB	dBuV	dBuV/m	dBuV/m	dB	
1	1249.269	4.61	24.72	38.07	45.31	36.57	68.20	-31.63	peak
2	1644.019	5.30	26.44	38.03	46.20	39.91	68.20	-28.29	peak
3 pp	3396.098	6.37	32.02	37.94	46.34	46.79	68.20	-21.41	peak
4	4050.904	7.04	33.60	38.03	47.44	50.05	74.00	-23.95	peak
5	10440.000	11.25	37.16	35.13	33.18	46.46	68.20	-21.74	peak
6	15660.000	14.48	41.34	38.17	33.22	50.87	74.00	-23.13	peak



Mode:e; Polarization:Vertical; Modulation:802.11a; bandwidth:20MHz; Channel:middle

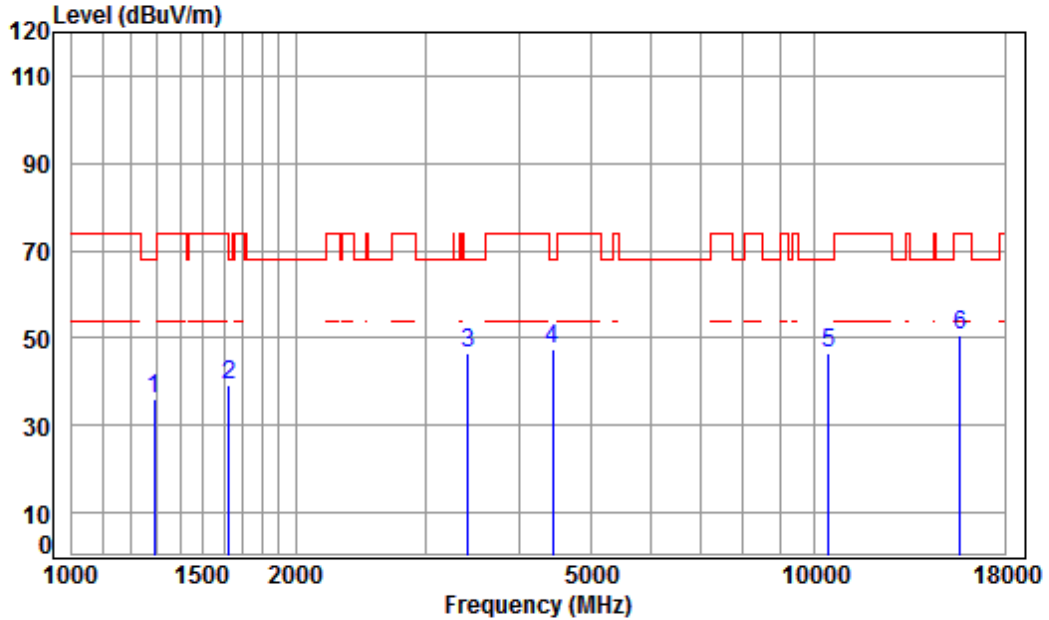

Condition: 3m VERTICAL
Job No : 04056CR/04057CR
Mode : 5220 TX RSE
Note : 5G WIFI 11A

	Freq	Cable Loss	Ant Factor	Preamp Factor	Read Level	Limit Level	Limit Line	Over Limit	Remark
	MHz	dB	dB/m	dB	dBuV	dBuV/m	dBuV/m	dB	
1	1289.627	4.76	24.91	38.06	44.31	35.92	68.20	-32.28	peak
2	1625.121	5.32	26.36	38.03	45.49	39.14	74.00	-34.86	peak
3	3415.787	6.38	32.06	37.95	45.85	46.34	68.20	-21.86	peak
4 pp	4443.453	7.50	33.60	38.24	44.57	47.43	68.20	-20.77	peak
5	10440.000	11.25	37.16	35.13	33.11	46.39	68.20	-21.81	peak
6	15660.000	14.48	41.34	38.17	33.15	50.80	74.00	-23.20	peak



Mode:e; Polarization:Horizontal; Modulation:802.11a; bandwidth:20MHz; Channel:High

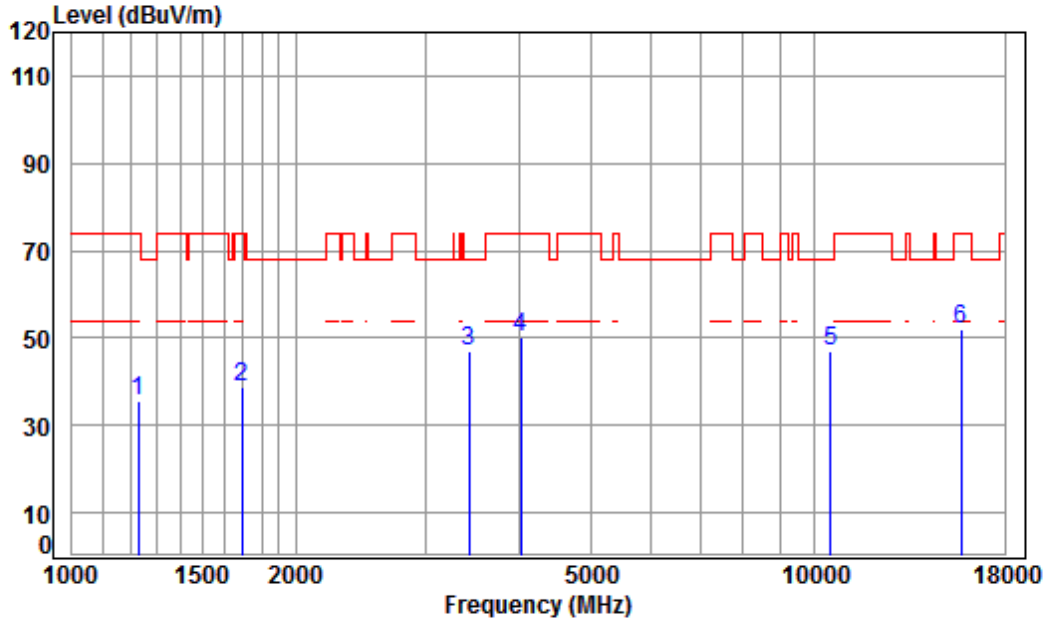

Condition: 3m HORIZONTAL
Job No : 04056CR/04057CR
Mode : 5240 TX RSE
Note : 5G WIFI 11A

	Freq	Cable Loss	Ant Factor	Preamp Factor	Read Level	Limit Level	Limit Line	Over Limit	Remark
	MHz	dB	dB/m	dB	dBuV	dBuV/m	dBuV/m	dB	
1	1227.791	4.53	24.61	38.07	44.33	35.40	74.00	-38.60	peak
2	1692.231	5.24	26.64	38.02	45.13	38.99	74.00	-35.01	peak
3 pp	3425.675	6.39	32.07	37.95	46.69	47.20	68.20	-21.00	peak
4	4015.929	7.00	33.60	38.01	47.59	50.18	74.00	-23.82	peak
5	10480.000	11.28	37.12	35.15	33.61	46.86	68.20	-21.34	peak
6	15720.000	14.57	41.31	38.10	34.40	52.18	74.00	-21.82	peak



Mode:e; Polarization:Vertical; Modulation:802.11a; bandwidth:20MHz; Channel:High

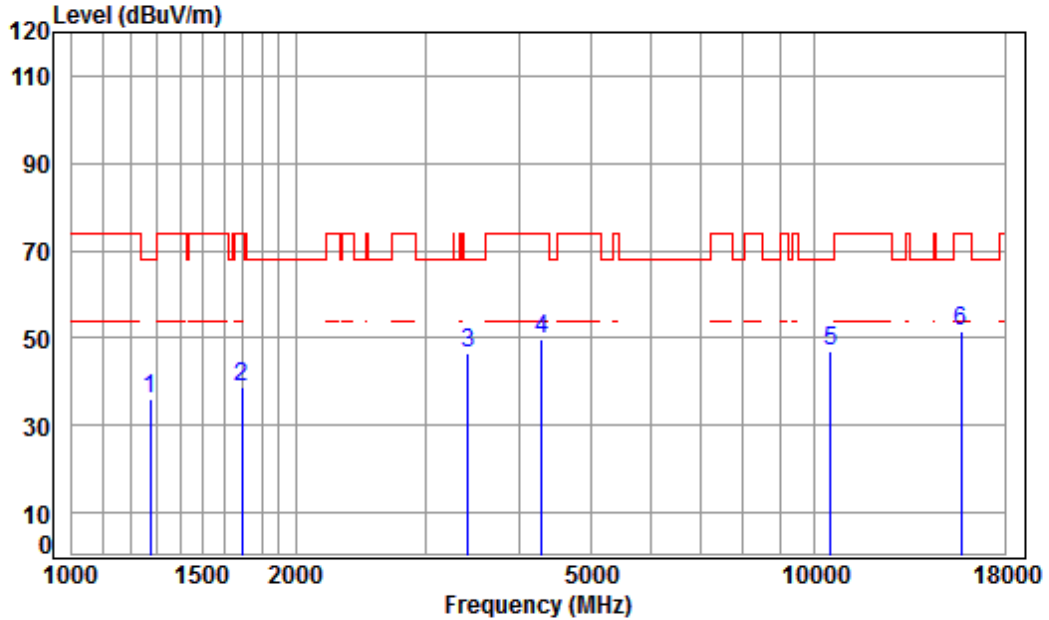

Condition: 3m VERTICAL
Job No : 04056CR/04057CR
Mode : 5240 TX RSE
Note : 5G WIFI 11A

	Freq	Cable Loss	Ant Factor	Preamp Factor	Read Level	Level	Limit	Over	Remark
	MHz	dB	dB/m	dB	dBuV	dBuV/m	dBuV/m	dB	
1	1274.802	4.71	24.84	38.06	44.67	36.16	68.20	-32.04	peak
2	1692.231	5.24	26.64	38.02	44.76	38.62	74.00	-35.38	peak
3	3415.787	6.38	32.06	37.95	46.13	46.62	68.20	-21.58	peak
4	4291.977	7.33	33.60	38.16	46.95	49.72	74.00	-24.28	peak
5	pp10480.000	11.28	37.12	35.15	33.64	46.89	68.20	-21.31	peak
6	15720.000	14.57	41.31	38.10	33.72	51.50	74.00	-22.50	peak



Mode:e; Polarization:Horizontal; Modulation:802.11n; bandwidth:20MHz; Channel:Low

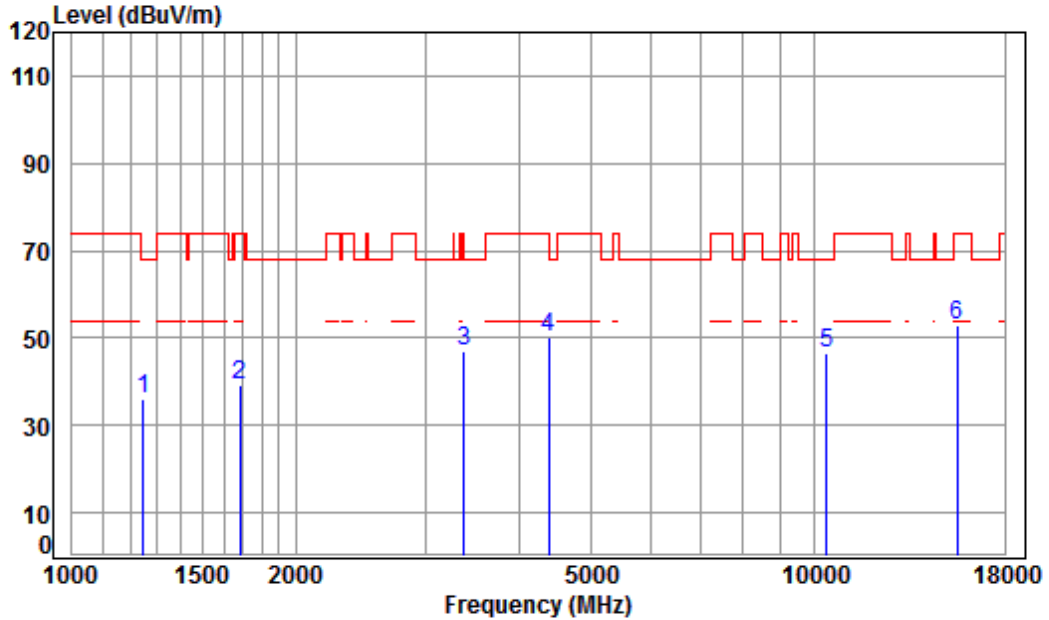

Condition: 3m HORIZONTAL
Job No : 04056CR/04057CR
Mode : 5180 TX RSE
Note : 5G WIFI 11N20

	Freq	Cable Loss	Ant Factor	Preamp Factor	Read Level	Level	Limit Line	Over Limit	Remark
	MHz	dB	dB/m	dB	dBuV	dBuV/m	dBuV/m	dB	
1	1249.269	4.61	24.72	38.07	44.81	36.07	68.20	-32.13	peak
2	1682.477	5.25	26.60	38.02	45.21	39.04	74.00	-34.96	peak
3 pp	3366.778	6.34	31.97	37.94	46.73	47.10	68.20	-21.10	peak
4	4379.699	7.43	33.60	38.20	47.52	50.35	74.00	-23.65	peak
5	10360.000	11.19	37.24	35.09	33.42	46.76	68.20	-21.44	peak
6	15540.000	14.30	41.38	38.30	35.34	52.72	74.00	-21.28	peak



Mode:e; Polarization:Vertical; Modulation:802.11n; bandwidth:20MHz; Channel:Low

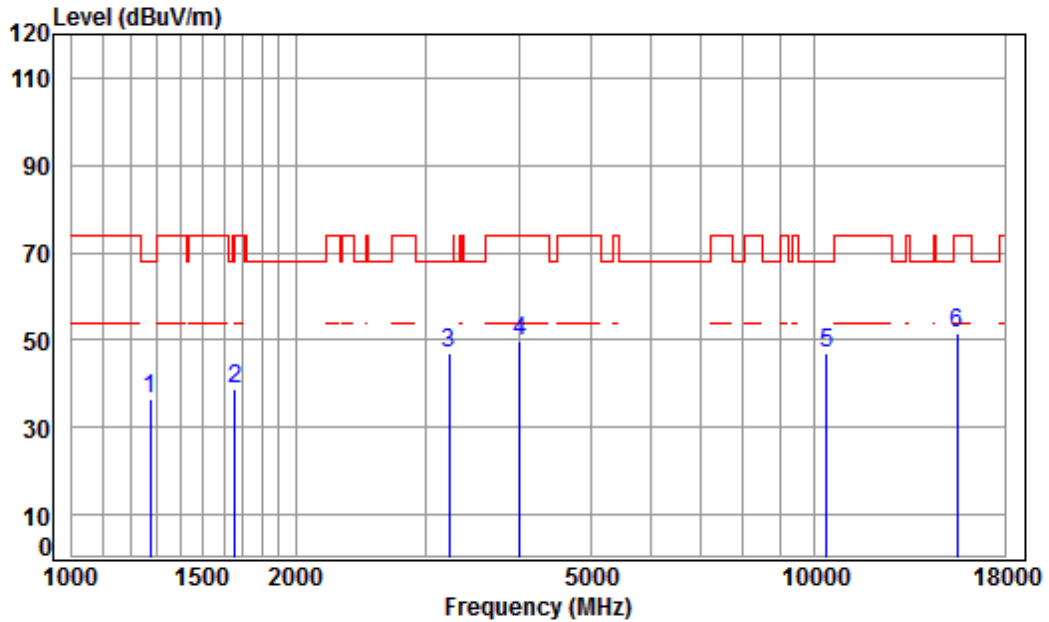

Condition: 3m VERTICAL
Job No : 04056CR/04057CR
Mode : 5180 TX RSE
Note : 5G WIFI 11N20

	Freq	Cable Loss	Ant Factor	Preamp Factor	Read Level	Level	Limit	Over	Remark
	MHz	dB	dB/m	dB	dBuV	dBuV/m	dBuV/m	dB	
1	1274.802	4.71	24.84	38.06	44.85	36.34	68.20	-31.86	peak
2	1658.337	5.28	26.50	38.03	44.87	38.62	68.20	-29.58	peak
3	3214.623	6.20	31.70	37.92	47.15	47.13	68.20	-21.07	peak
4	4004.339	6.99	33.60	38.00	46.98	49.57	74.00	-24.43	peak
5	pp10360.000	11.19	37.24	35.09	33.86	47.20	68.20	-21.00	peak
6	15540.000	14.30	41.38	38.30	34.35	51.73	74.00	-22.27	peak



Mode:e; Polarization:Horizontal; Modulation:802.11n; bandwidth:20MHz; Channel:middle

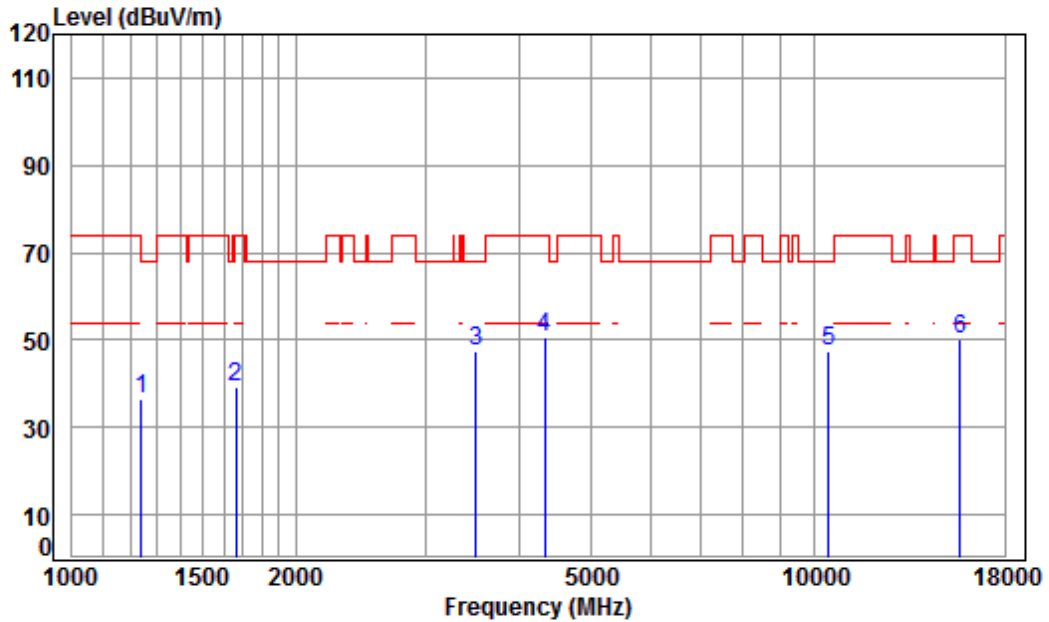

Condition: 3m HORIZONTAL
Job No : 04056CR/04057CR
Mode : 5220 TX RSE
Note : 5G WIFI 11N20

	Freq	Cable Loss	Ant Factor	Preamp Factor	Read Level	Level	Limit	Over	Remark
	MHz	dB	dB/m	dB	dBuV	dBuV/m	dBuV/m	dB	
1	1238.483	4.57	24.67	38.07	45.51	36.68	74.00	-37.32	peak
2	1663.137	5.27	26.52	38.03	45.57	39.33	74.00	-34.67	peak
3	3495.691	6.46	32.19	37.95	46.62	47.32	68.20	-20.88	peak
4	4329.354	7.37	33.60	38.18	47.81	50.60	74.00	-23.40	peak
5	pp10440.000	11.25	37.16	35.13	34.09	47.37	68.20	-20.83	peak
6	15660.000	14.48	41.34	38.17	32.53	50.18	74.00	-23.82	peak



Mode:e; Polarization:Vertical; Modulation:802.11n; bandwidth:20MHz; Channel:middle

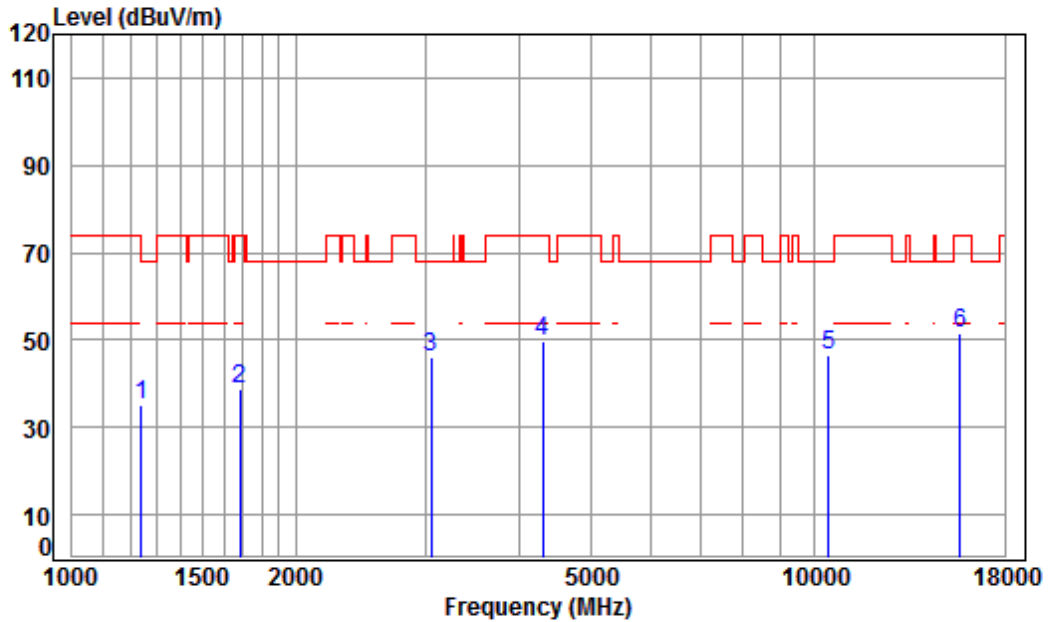

Condition: 3m VERTICAL
 Job No : 04056CR/04057CR
 Mode : 5220 TX RSE
 Note : 5G WIFI 11N20

	Cable	Ant	Preamp	Read	Limit	Over		
Freq	Loss	Factor	Factor	Level	Level	Line	Limit	Remark
MHz	dB	dB/m	dB	dBuV	dBuV/m	dBuV/m	dB	
1	1238.483	4.57	24.67	38.07	44.02	35.19	74.00	-38.81 peak
2	1682.477	5.25	26.60	38.02	45.14	38.97	74.00	-35.03 peak
3	3042.846	6.02	31.38	37.90	46.74	46.24	68.20	-21.96 peak
4	4304.400	7.34	33.60	38.16	47.14	49.92	74.00	-24.08 peak
5	pp10440.000	11.25	37.16	35.13	33.35	46.63	68.20	-21.57 peak
6	15660.000	14.48	41.34	38.17	33.91	51.56	74.00	-22.44 peak



Mode:e; Polarization:Horizontal; Modulation:802.11n; bandwidth:20MHz; Channel:High

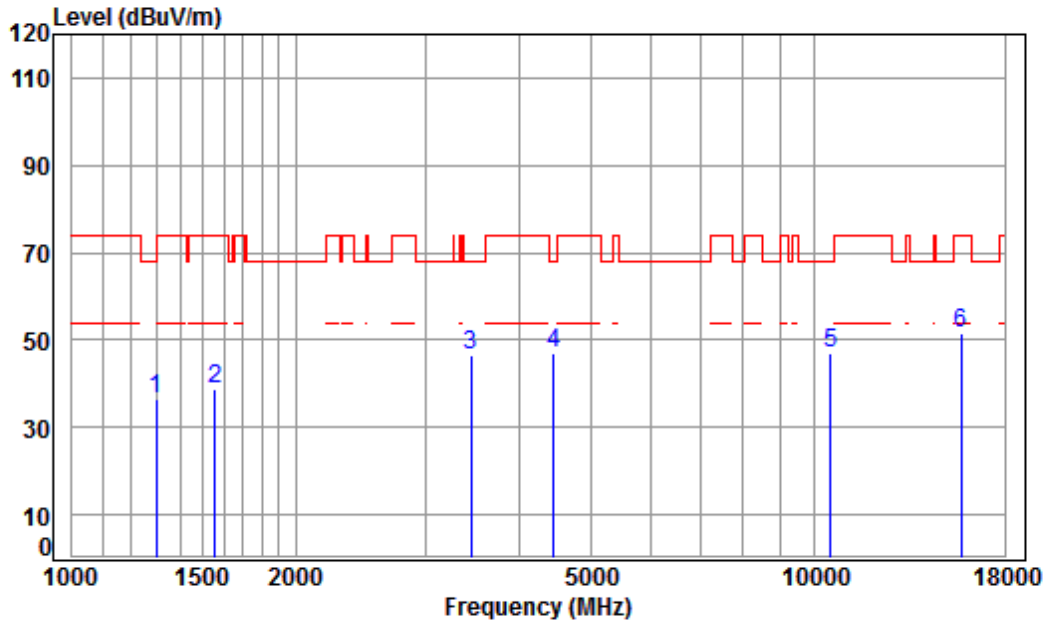

Condition: 3m HORIZONTAL
Job No : 04056CR/04057CR
Mode : 5240 TX RSE
Note : 5G WIFI 11N20

	Cable	Ant	Preamp	Read	Limit	Over		
Freq	Loss	Factor	Factor	Level	Level	Line	Limit	Remark
MHz	dB	dB/m	dB	dBuV	dBuV/m	dBuV/m	dB	
1	1297.103	4.79	24.94	38.06	44.96	36.63	68.20	-31.57 peak
2	1560.673	5.40	26.08	38.04	45.56	39.00	74.00	-35.00 peak
3	3445.535	6.41	32.11	37.95	45.85	46.42	68.20	-21.78 peak
4	4456.315	7.51	33.60	38.24	43.93	46.80	68.20	-21.40 peak
5	pp10480.000	11.28	37.12	35.15	33.66	46.91	68.20	-21.29 peak
6	15720.000	14.57	41.31	38.10	33.96	51.74	74.00	-22.26 peak



Mode:e; Polarization:Vertical; Modulation:802.11n; bandwidth:20MHz; Channel:High

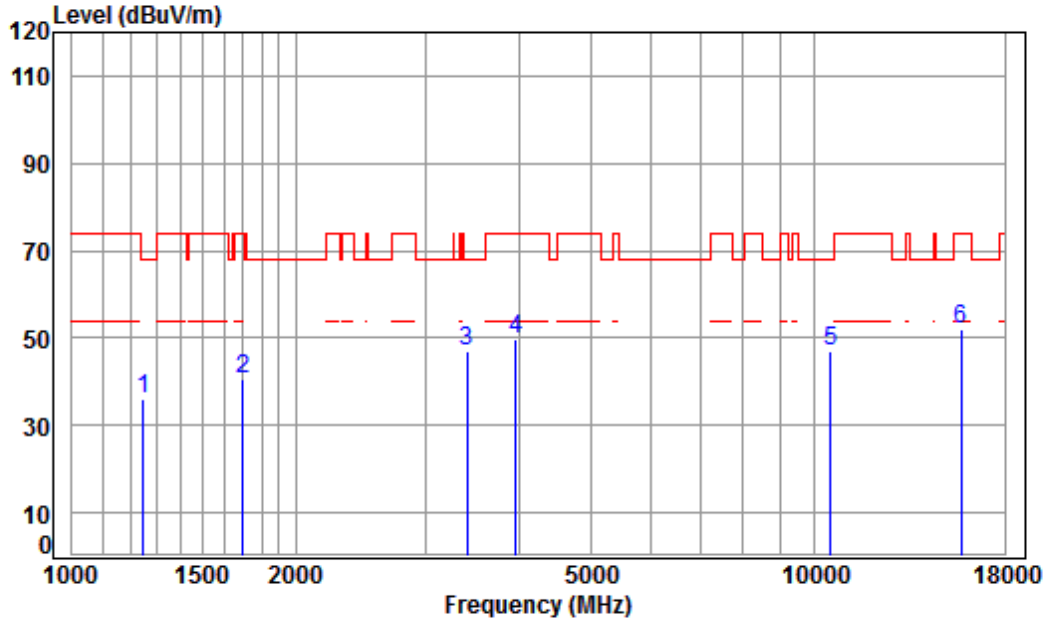

Condition: 3m VERTICAL
Job No : 04056CR/04057CR
Mode : 5240 TX RSE
Note : 5G WIFI 11N20

	Freq	Cable Loss	Ant Factor	Preamp Factor	Read Level	Level	Limit	Over	Remark
	MHz	dB	dB/m	dB	dBuV	dBuV/m	dBuV/m	dB	
1	1249.269	4.61	24.72	38.07	44.63	35.89	68.20	-32.31	peak
2	1697.129	5.23	26.66	38.02	46.76	40.63	74.00	-33.37	peak
3	3405.929	6.38	32.04	37.94	46.57	47.05	68.20	-21.15	peak
4	3958.309	6.94	33.49	38.00	47.13	49.56	74.00	-24.44	peak
5	pp10480.000	11.28	37.12	35.15	33.90	47.15	68.20	-21.05	peak
6	15720.000	14.57	41.31	38.10	34.41	52.19	74.00	-21.81	peak



Mode:e; Polarization:Horizontal; Modulation:802.11n; bandwidth:40MHz; Channel:Low

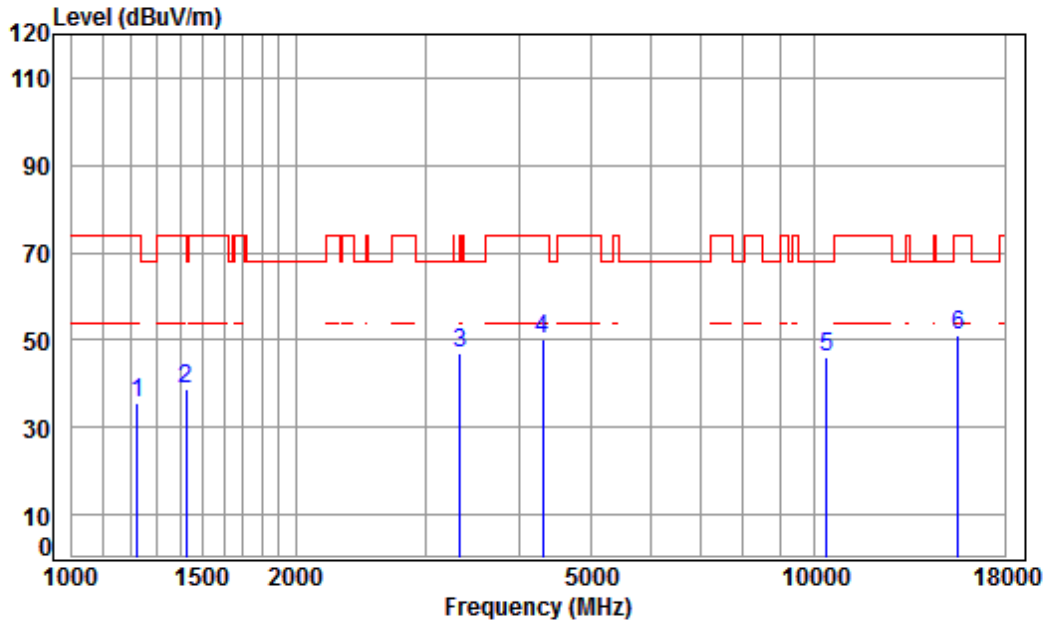

Condition: 3m HORIZONTAL
Job No : 04056CR/04057CR
Mode : 5190 TX RSE
Note : 5G WIFI 11N40

	Freq	Cable Loss	Ant Factor	Preamp Factor	Read Level	Limit Level	Limit Line	Over Limit	Remark
	MHz	dB	dB/m	dB	dBuV	dBuV/m	dBuV/m	dB	
1	1224.247	4.51	24.60	38.07	44.66	35.70	74.00	-38.30	peak
2	1426.916	5.24	25.50	38.05	46.04	38.73	74.00	-35.27	peak
3 pp	3328.077	6.30	31.91	37.94	46.69	46.96	68.20	-21.24	peak
4	4304.400	7.34	33.60	38.16	47.22	50.00	74.00	-24.00	peak
5	10380.000	11.21	37.22	35.10	32.97	46.30	68.20	-21.90	peak
6	15570.000	14.35	41.37	38.26	33.68	51.14	74.00	-22.86	peak



Mode:e; Polarization:Vertical; Modulation:802.11n; bandwidth:40MHz; Channel:Low

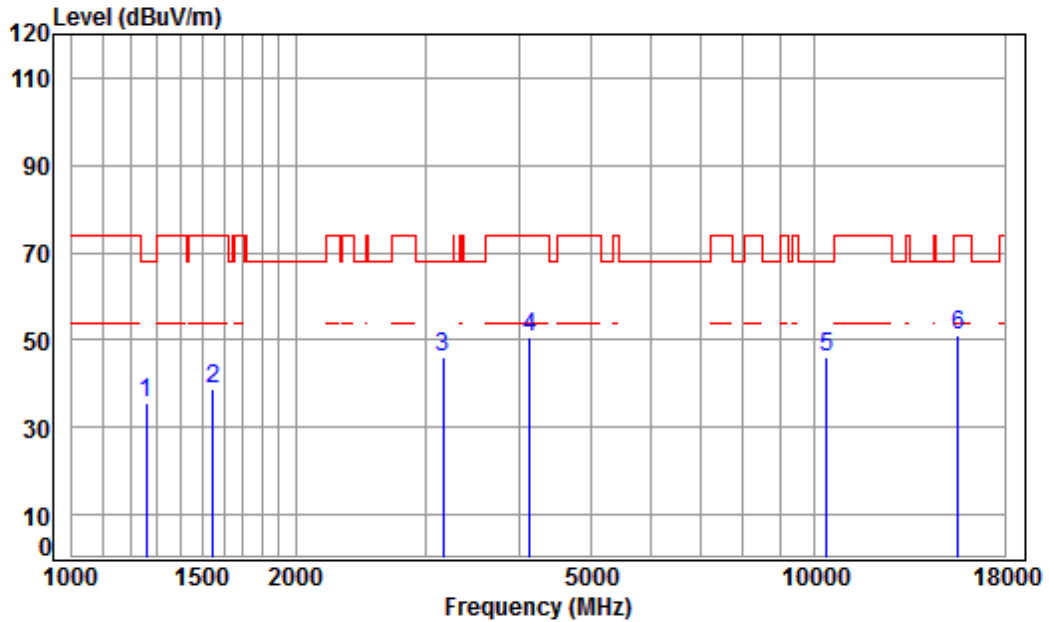

Condition: 3m VERTICAL
Job No : 04056CR/04057CR
Mode : 5190 TX RSE
Note : 5G WIFI 11N40

	Freq	Cable Loss	Ant Factor	Preamp Factor	Read Level	Level	Limit	Over	Remark
	MHz	dB	dB/m	dB	dBuV	dBuV/m	dBuV/m	dB	
1	1260.149	4.65	24.77	38.07	44.44	35.79	68.20	-32.41	peak
2	1547.199	5.42	26.02	38.04	45.58	38.98	74.00	-35.02	peak
3	3159.355	6.14	31.60	37.92	46.49	46.31	68.20	-21.89	peak
4	4133.699	7.14	33.60	38.07	47.82	50.49	74.00	-23.51	peak
5	pp10380.000	11.21	37.22	35.10	32.98	46.31	68.20	-21.89	peak
6	15570.000	14.35	41.37	38.26	33.62	51.08	74.00	-22.92	peak



Mode:e; Polarization:Horizontal; Modulation:802.11n; bandwidth:40MHz; Channel:High

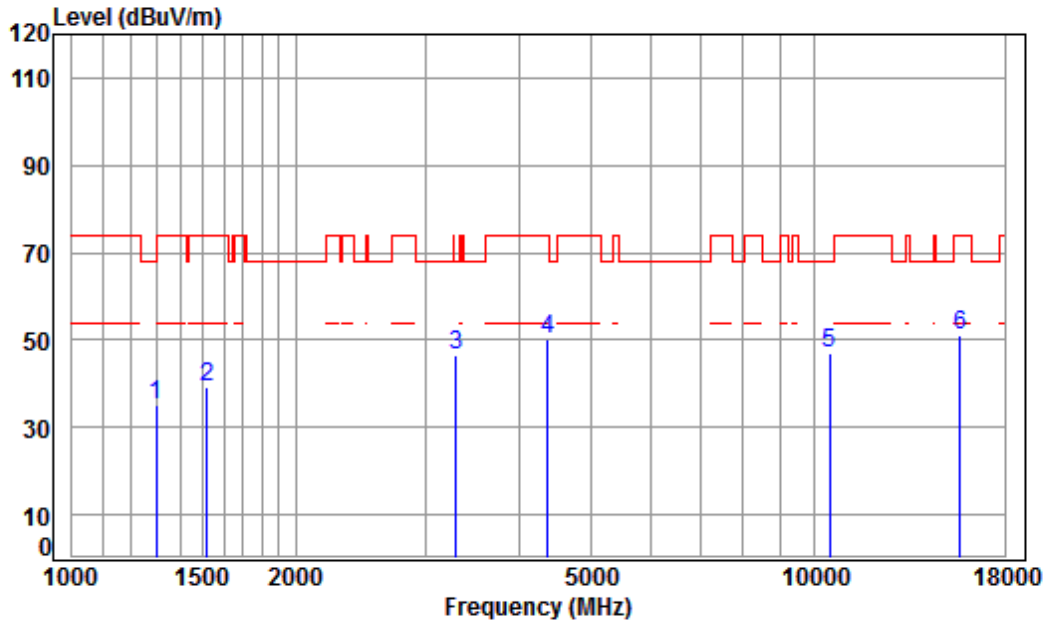

Condition: 3m HORIZONTAL
Job No : 04056CR/04057CR
Mode : 5230 TX RSE
Note : 5G WIFI 11N40

	Cable	Ant	Preamp	Read	Limit	Over		
Freq	Loss	Factor	Factor	Level	Level	Line	Limit	Remark
MHz	dB	dB/m	dB	dBuV	dBuV/m	dBuV/m	dB	
1	1297.103	4.79	24.94	38.06	43.62	35.29	68.20	-32.91 peak
2	1520.598	5.45	25.89	38.04	45.96	39.26	74.00	-34.74 peak
3	3289.821	6.27	31.84	37.93	46.45	46.63	68.20	-21.57 peak
4	4367.058	7.41	33.60	38.20	47.29	50.10	74.00	-23.90 peak
5	pp10460.000	11.26	37.14	35.14	33.66	46.92	68.20	-21.28 peak
6	15690.000	14.53	41.32	38.13	33.16	50.88	74.00	-23.12 peak



Mode:e; Polarization:Vertical; Modulation:802.11n; bandwidth:40MHz; Channel:High

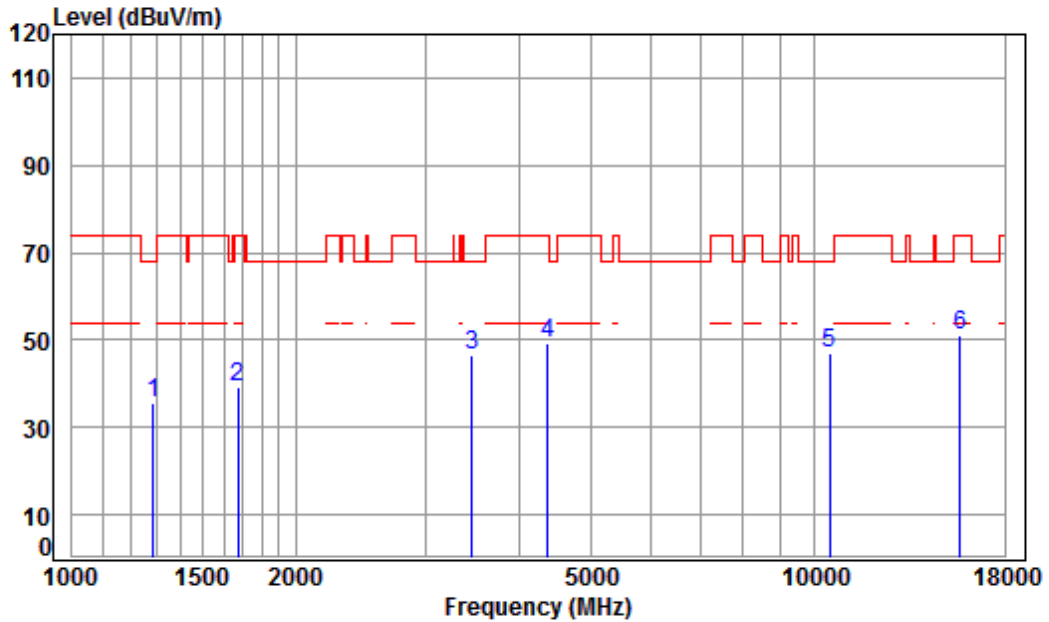

Condition: 3m VERTICAL
Job No : 04056CR/04057CR
Mode : 5230 TX RSE
Note : 5G WIFI 11N40

	Freq	Cable Loss	Ant Factor	Preamp Factor	Read Level	Level	Limit	Over	Remark
	MHz	dB	dB/m	dB	dBuV	dBuV/m	dBuV/m	dB	
1	1285.904	4.75	24.89	38.06	44.02	35.60	68.20	-32.60	peak
2	1672.779	5.26	26.56	38.03	45.35	39.14	74.00	-34.86	peak
3	3455.508	6.42	32.13	37.95	46.01	46.61	68.20	-21.59	peak
4	4367.058	7.41	33.60	38.20	46.34	49.15	74.00	-24.85	peak
5	pp10460.000	11.26	37.14	35.14	33.62	46.88	68.20	-21.32	peak
6	15690.000	14.53	41.32	38.13	33.57	51.29	74.00	-22.71	peak



Mode:e; Polarization:Horizontal; Modulation:802.11ac; bandwidth:20MHz; Channel:Low

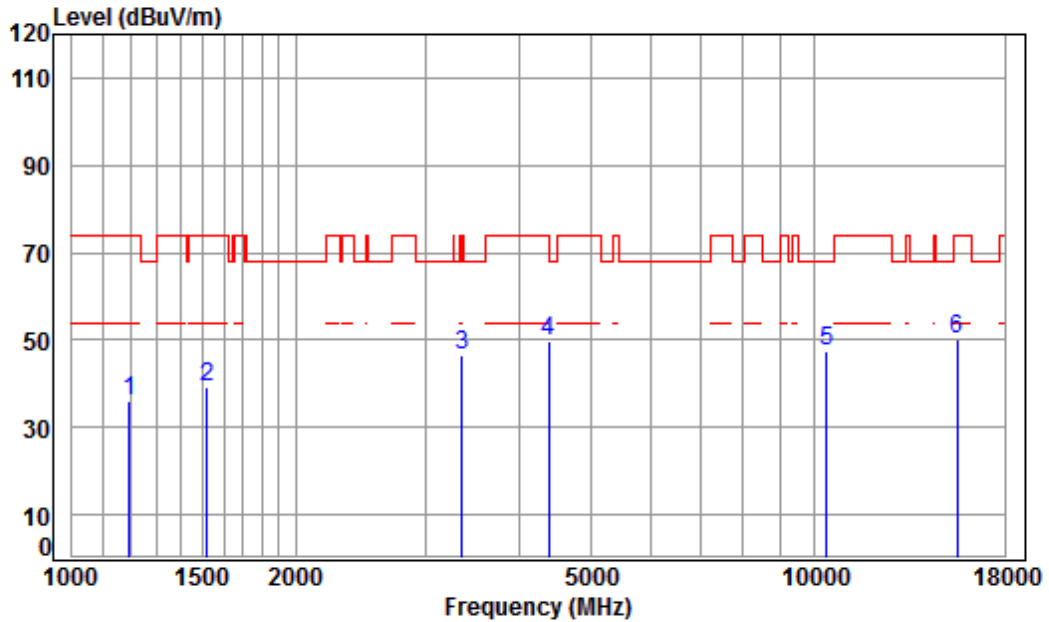

Condition: 3m HORIZONTAL
 Job No : 04056CR/04057CR
 Mode : 5180 TX RSE
 Note : 5G WIFI 11AC20

	Freq	Cable Loss	Ant Factor	Preamp Factor	Read Level	Level	Limit	Over	Remark
	MHz	dB	dB/m	dB	dBuV	dBuV/m	dBuV/m	dB	
1	1196.264	4.40	24.46	38.07	45.23	36.02	74.00	-37.98	peak
2	1520.598	5.45	25.89	38.04	45.89	39.19	74.00	-34.81	peak
3	3347.371	6.32	31.94	37.94	46.17	46.49	74.00	-27.51	peak
4	4379.699	7.43	33.60	38.20	46.98	49.81	74.00	-24.19	peak
5	pp10360.000	11.19	37.24	35.09	34.11	47.45	68.20	-20.75	peak
6	15540.000	14.30	41.38	38.30	32.60	49.98	74.00	-24.02	peak



Mode:e; Polarization:Vertical; Modulation:802.11ac; bandwidth:20MHz; Channel:Low

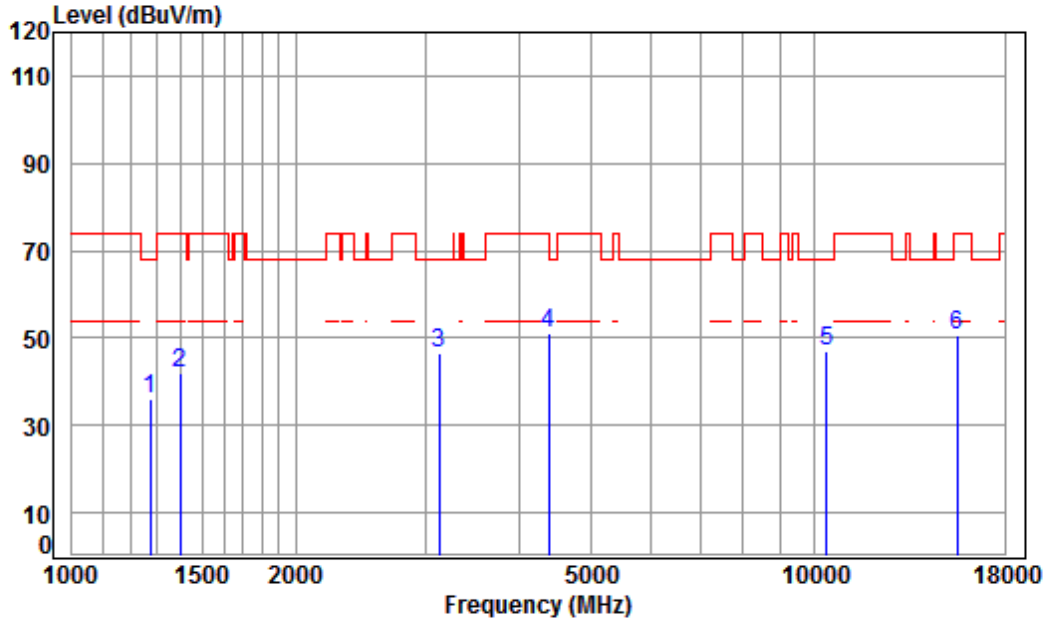

Condition: 3m VERTICAL
Job No : 04056CR/04057CR
Mode : 5180 TX RSE
Note : 5G WIFI 11AC20

	Freq	Cable Loss	Ant Factor	Preamp Factor	Read Level	Level	Limit	Over	Remark
	MHz	dB	dB/m	dB	dBuV	dBuV/m	dBuV/m	dB	
1	1274.802	4.71	24.84	38.06	44.64	36.13	68.20	-32.07	peak
2	1398.336	5.15	25.38	38.05	49.64	42.12	74.00	-31.88	peak
3	3123.039	6.11	31.53	37.91	46.60	46.33	68.20	-21.87	peak
4	4379.699	7.43	33.60	38.20	48.10	50.93	74.00	-23.07	peak
5	pp10360.000	11.19	37.24	35.09	33.51	46.85	68.20	-21.35	peak
6	15540.000	14.30	41.38	38.30	33.43	50.81	74.00	-23.19	peak



Mode:e; Polarization:Horizontal; Modulation:802.11ac; bandwidth:20MHz; Channel:middle

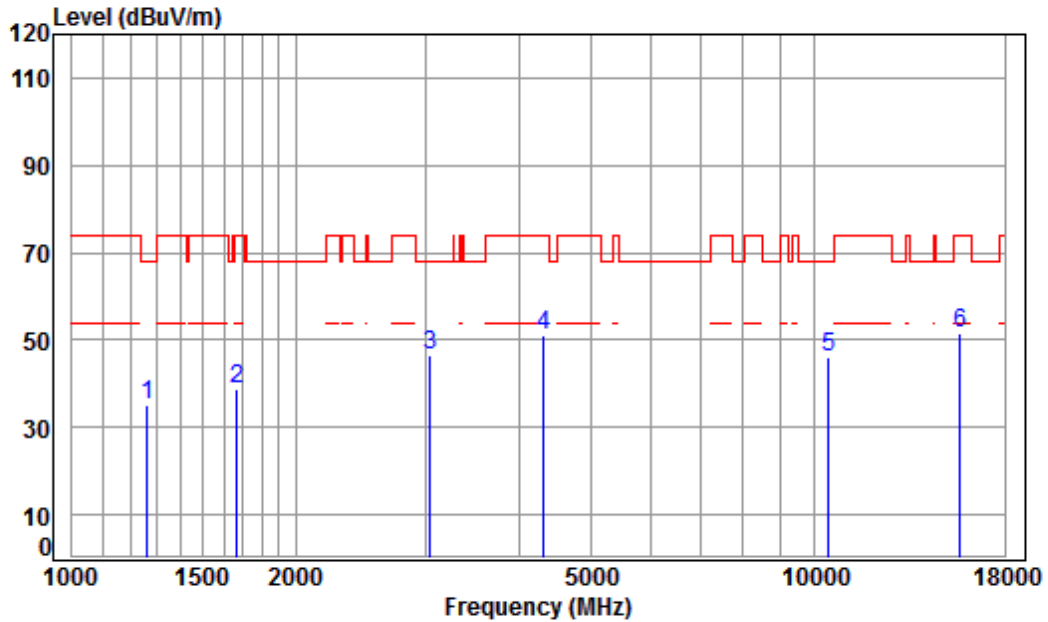

Condition: 3m HORIZONTAL
Job No : 04056CR/04057CR
Mode : 5220 TX RSE
Note : 5G WIFI 11AC20

	Freq	Cable Loss	Ant Factor	Preamp Factor	Read Level	Level	Limit	Over	Remark
	MHz	dB	dB/m	dB	dBuV	dBuV/m	dBuV/m	dB	
1	1263.796	4.66	24.79	38.07	43.93	35.31	68.20	-32.89	peak
2	1667.951	5.27	26.54	38.03	45.18	38.96	74.00	-35.04	peak
3	pp 3034.063	6.02	31.37	37.90	46.90	46.39	68.20	-21.81	peak
4	4316.859	7.36	33.60	38.17	48.24	51.03	74.00	-22.97	peak
5	10440.000	11.25	37.16	35.13	33.00	46.28	68.20	-21.92	peak
6	15660.000	14.48	41.34	38.17	34.13	51.78	74.00	-22.22	peak



Mode:e; Polarization:Vertical; Modulation:802.11ac; bandwidth:20MHz; Channel:middle

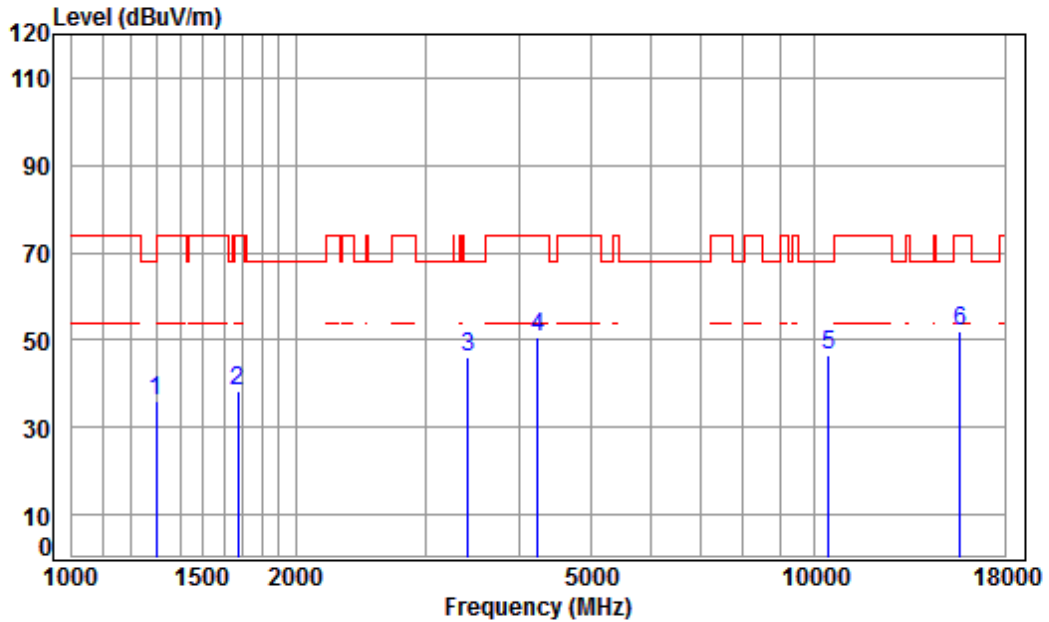

Condition: 3m VERTICAL
Job No : 04056CR/04057CR
Mode : 5220 TX RSE
Note : 5G WIFI 11AC20

	Freq	Cable Loss	Ant Factor	Preamp Factor	Read Level	Level	Limit	Over	Remark
	MHz	dB	dB/m	dB	dBuV	dBuV/m	dBuV/m	dB	
1	1297.103	4.79	24.94	38.06	44.47	36.14	68.20	-32.06	peak
2	1672.779	5.26	26.56	38.03	44.71	38.50	74.00	-35.50	peak
3	3415.787	6.38	32.06	37.95	45.58	46.07	68.20	-22.13	peak
4	4230.396	7.26	33.60	38.13	48.02	50.75	74.00	-23.25	peak
5	pp10440.000	11.25	37.16	35.13	33.29	46.57	68.20	-21.63	peak
6	15660.000	14.48	41.34	38.17	34.27	51.92	74.00	-22.08	peak



Mode:e; Polarization:Horizontal; Modulation:802.11ac; bandwidth:20MHz; Channel:High

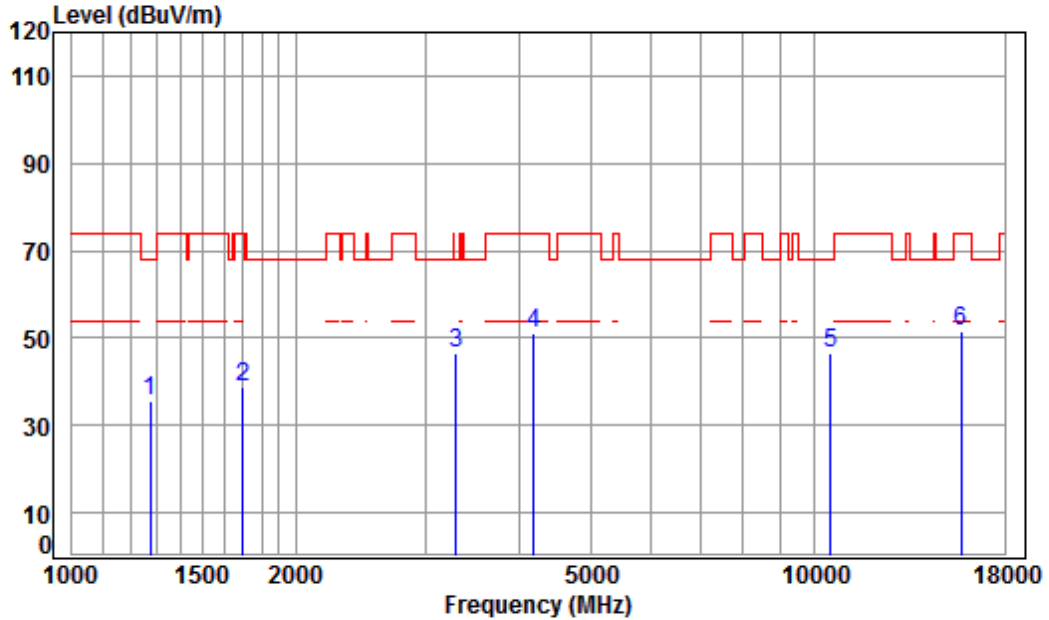

Condition: 3m HORIZONTAL
Job No : 04056CR/04057CR
Mode : 5240 TX RSE
Note : 5G WIFI 11AC20

	Freq	Cable Loss	Ant Factor	Preamp Factor	Read Level	Level	Limit	Over	Remark
	MHz	dB	dB/m	dB	dBuV	dBuV/m	dBuV/m	dB	
1	1274.802	4.71	24.84	38.06	44.21	35.70	68.20	-32.50	peak
2	1697.129	5.23	26.66	38.02	45.08	38.95	74.00	-35.05	peak
3 pp	3289.821	6.27	31.84	37.93	46.36	46.54	68.20	-21.66	peak
4	4181.768	7.20	33.60	38.10	48.22	50.92	74.00	-23.08	peak
5	10480.000	11.28	37.12	35.15	33.27	46.52	68.20	-21.68	peak
6	15720.000	14.57	41.31	38.10	33.63	51.41	74.00	-22.59	peak



Mode:e; Polarization:Vertical; Modulation:802.11ac; bandwidth:20MHz; Channel:High

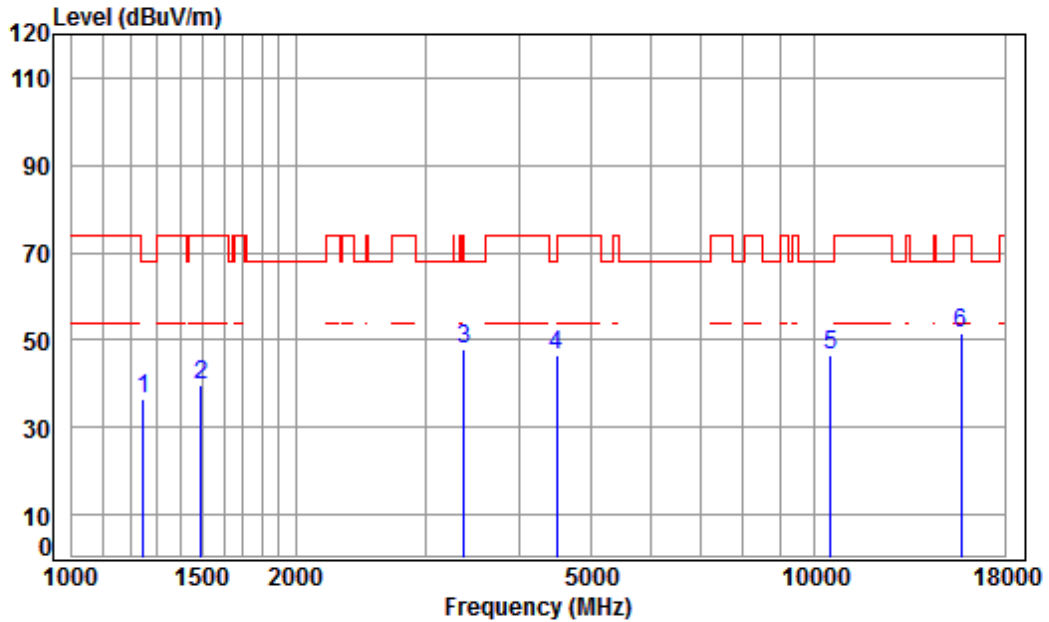

Condition: 3m VERTICAL
Job No : 04056CR/04057CR
Mode : 5240 TX RSE
Note : 5G WIFI 11AC20

	Freq	Cable Loss	Ant Factor	Preamp Factor	Read Level	Limit Level	Over Limit	Remark
	MHz	dB	dB/m	dB	dBuV	dBuV/m	dBuV/m	dB
1	1249.269	4.61	24.72	38.07	45.45	36.71	68.20	-31.49 peak
2	1494.455	5.46	25.78	38.04	46.37	39.57	74.00	-34.43 peak
3 pp	3366.778	6.34	31.97	37.94	47.32	47.69	68.20	-20.51 peak
4	4495.125	7.55	33.60	38.26	43.44	46.33	68.20	-21.87 peak
5	10480.000	11.28	37.12	35.15	33.43	46.68	68.20	-21.52 peak
6	15720.000	14.57	41.31	38.10	33.93	51.71	74.00	-22.29 peak



Mode:e; Polarization:Horizontal; Modulation:802.11ac; bandwidth:40MHz; Channel:Low

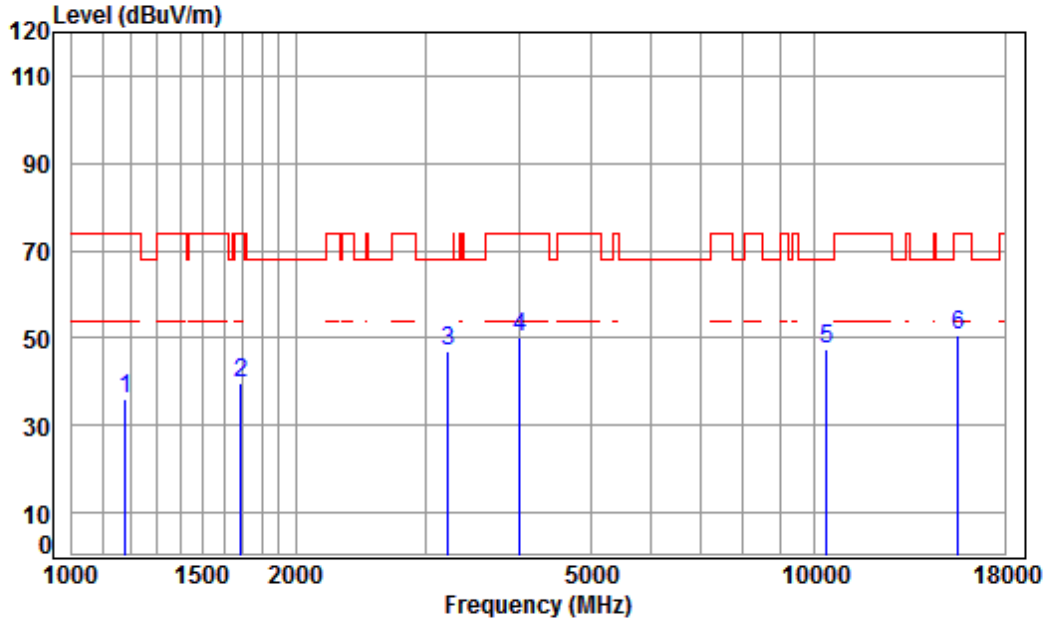

Condition: 3m HORIZONTAL
Job No : 04056CR/04057CR
Mode : 5190 TX RSE
Note : 5G WIFI 11AC40

	Freq	Cable Loss	Ant Factor	Preamp Factor	Read Level	Level	Limit	Over	Remark
	MHz	dB	dB/m	dB	dBuV	dBuV/m	dBuV/m	dB	
1	1179.100	4.33	24.38	38.08	45.30	35.93	74.00	-38.07	peak
2	1687.347	5.24	26.62	38.02	45.70	39.54	74.00	-34.46	peak
3	3205.345	6.19	31.69	37.92	46.82	46.78	68.20	-21.42	peak
4	4004.339	6.99	33.60	38.00	47.52	50.11	74.00	-23.89	peak
5	pp10380.000	11.21	37.22	35.10	34.06	47.39	68.20	-20.81	peak
6	15570.000	14.35	41.37	38.26	33.01	50.47	74.00	-23.53	peak



Mode:e; Polarization:Vertical; Modulation:802.11ac; bandwidth:40MHz; Channel:Low

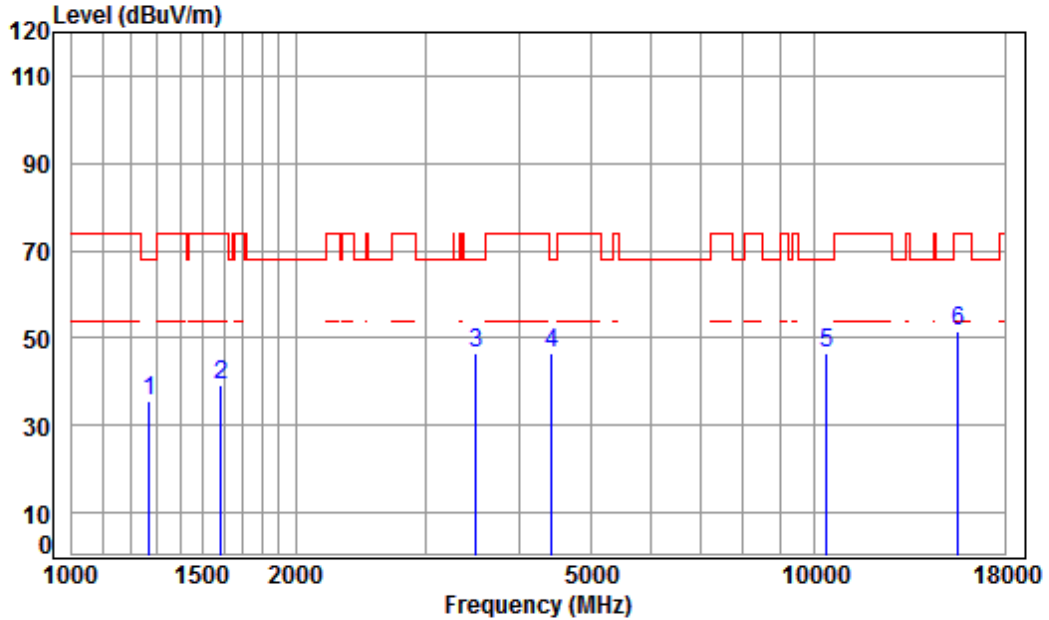

Condition: 3m VERTICAL
Job No : 04056CR/04057CR
Mode : 5190 TX RSE
Note : 5G WIFI 11AC40

	Freq	Cable Loss	Ant Factor	Preamp Factor	Read Level	Limit Level	Over Limit	Remark
	MHz	dB	dB/m	dB	dBuV	dBuV/m	dBuV/m	dB
1	1271.123	4.69	24.82	38.07	44.06	35.50	68.20	-32.70 peak
2	1587.975	5.37	26.20	38.03	45.48	39.02	74.00	-34.98 peak
3	3495.691	6.46	32.19	37.95	45.72	46.42	68.20	-21.78 peak
4 pp	4417.841	7.47	33.60	38.22	43.91	46.76	68.20	-21.44 peak
5	10380.000	11.21	37.22	35.10	33.26	46.59	68.20	-21.61 peak
6	15570.000	14.35	41.37	38.26	33.93	51.39	74.00	-22.61 peak



Mode:e; Polarization:Horizontal; Modulation:802.11ac; bandwidth:40MHz; Channel:High

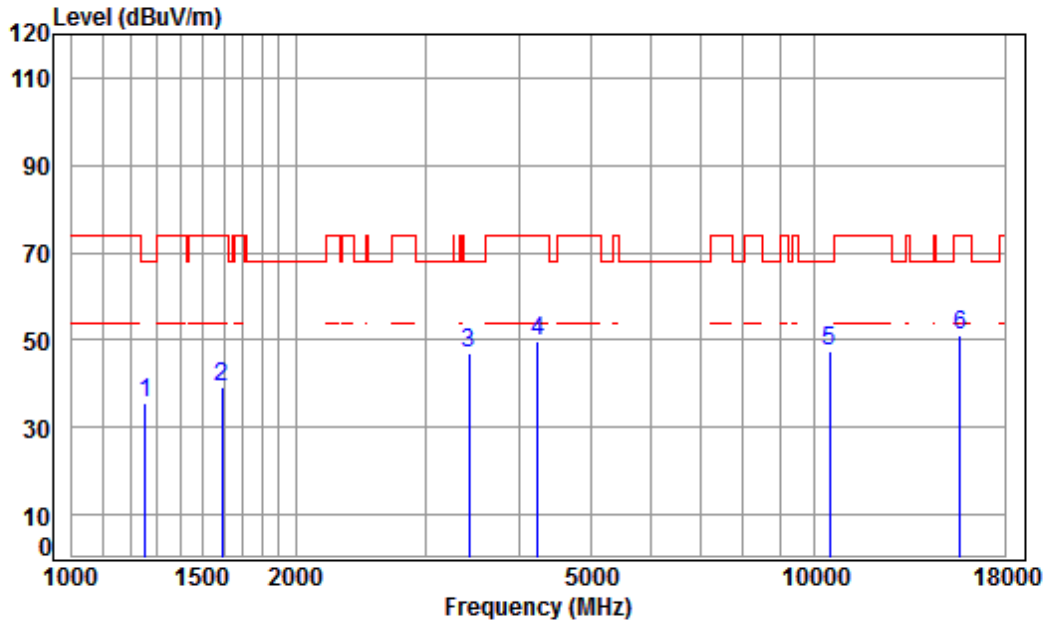

Condition: 3m HORIZONTAL
Job No : 04056CR/04057CR
Mode : 5230 TX RSE
Note : 5G WIFI 11AC40

	Freq	Cable Loss	Ant Factor	Preamplifier	Read Level	Level	Limit	Over	Remark
	MHz	dB	dB/m	dB	dBuV	dBuV/m	dBuV/m	dB	
1	1256.512	4.64	24.75	38.07	44.25	35.57	68.20	-32.63	peak
2	1592.571	5.36	26.22	38.03	45.72	39.27	74.00	-34.73	peak
3	3425.675	6.39	32.07	37.95	46.59	47.10	68.20	-21.10	peak
4	4230.396	7.26	33.60	38.13	46.87	49.60	74.00	-24.40	peak
5	pp10460.000	11.26	37.14	35.14	34.13	47.39	68.20	-20.81	peak
6	15690.000	14.53	41.32	38.13	33.16	50.88	74.00	-23.12	peak



Mode:e; Polarization:Vertical; Modulation:802.11ac; bandwidth:40MHz; Channel:High

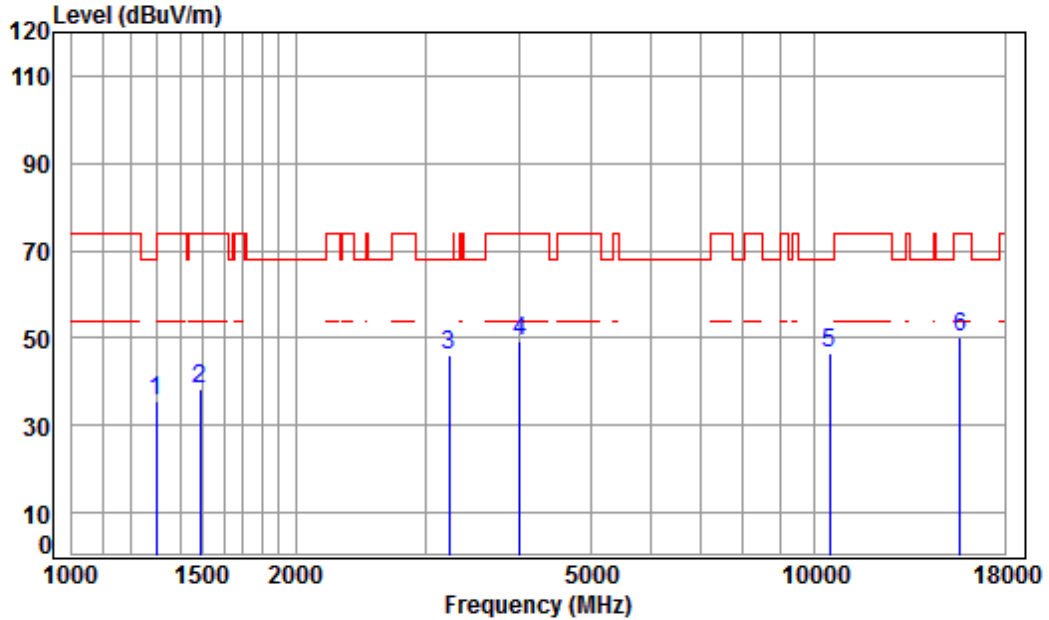

Condition: 3m VERTICAL
Job No : 04056CR/04057CR
Mode : 5230 TX RSE
Note : 5G WIFI 11AC40

	Cable	Ant	Preamp	Read	Limit	Over		
Freq	Loss	Factor	Factor	Level	Level	Line	Limit	Remark
MHz	dB	dB/m	dB	dBuV	dBuV/m	dBuV/m	dB	
1	1297.103	4.79	24.94	38.06	43.81	35.48	68.20	-32.72 peak
2	1485.841	5.43	25.74	38.04	45.08	38.21	74.00	-35.79 peak
3	3214.623	6.20	31.70	37.92	46.14	46.12	68.20	-22.08 peak
4	4004.339	6.99	33.60	38.00	46.78	49.37	74.00	-24.63 peak
5	pp10460.000	11.26	37.14	35.14	33.20	46.46	68.20	-21.74 peak
6	15690.000	14.53	41.32	38.13	32.70	50.42	74.00	-23.58 peak



Mode:e; Polarization:Horizontal; Modulation:802.11ac; bandwidth:80MHz; Channel:middle

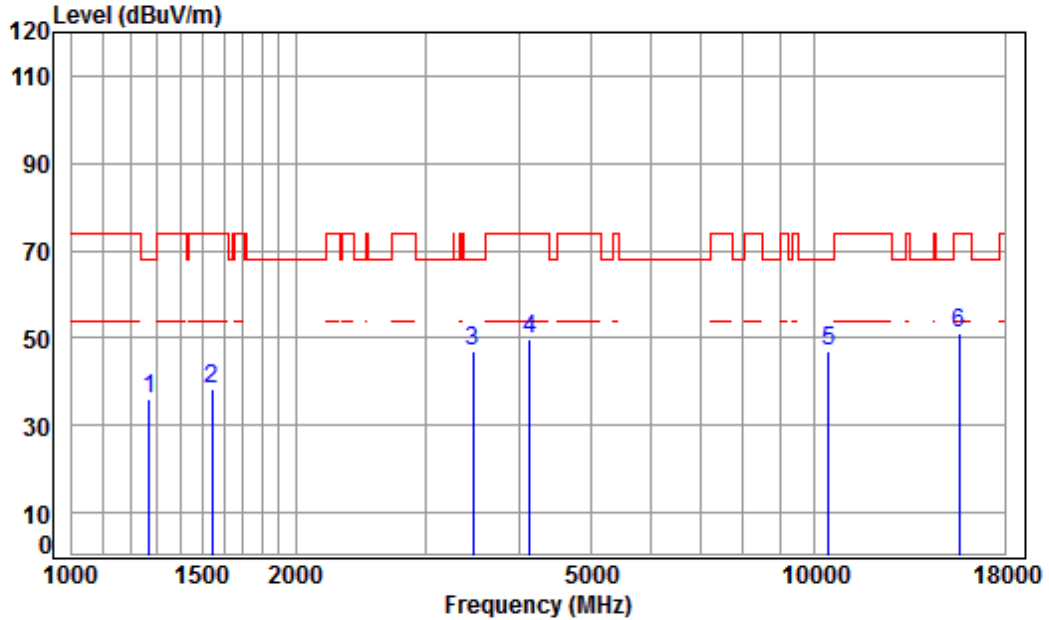

Condition: 3m HORIZONTAL
Job No : 04056CR/04057CR
Mode : 5210 TX RSE
Note : 5G WIFI 11AC80

	Freq	Cable Loss	Ant Factor	Preamp Factor	Read Level	Level	Limit	Over	Remark
	MHz	dB	dB/m	dB	dBuV	dBuV/m	dBuV/m	dB	
1	1271.123	4.69	24.82	38.07	44.45	35.89	68.20	-32.31	peak
2	1542.733	5.42	26.00	38.04	44.86	38.24	74.00	-35.76	peak
3 pp	3465.510	6.43	32.14	37.95	46.59	47.21	68.20	-20.99	peak
4	4133.699	7.14	33.60	38.07	46.95	49.62	74.00	-24.38	peak
5	10420.000	11.24	37.18	35.12	33.57	46.87	68.20	-21.33	peak
6	15630.000	14.44	41.35	38.20	33.68	51.27	74.00	-22.73	peak



Mode:e; Polarization:Vertical; Modulation:802.11ac; bandwidth:80MHz; Channel:middle

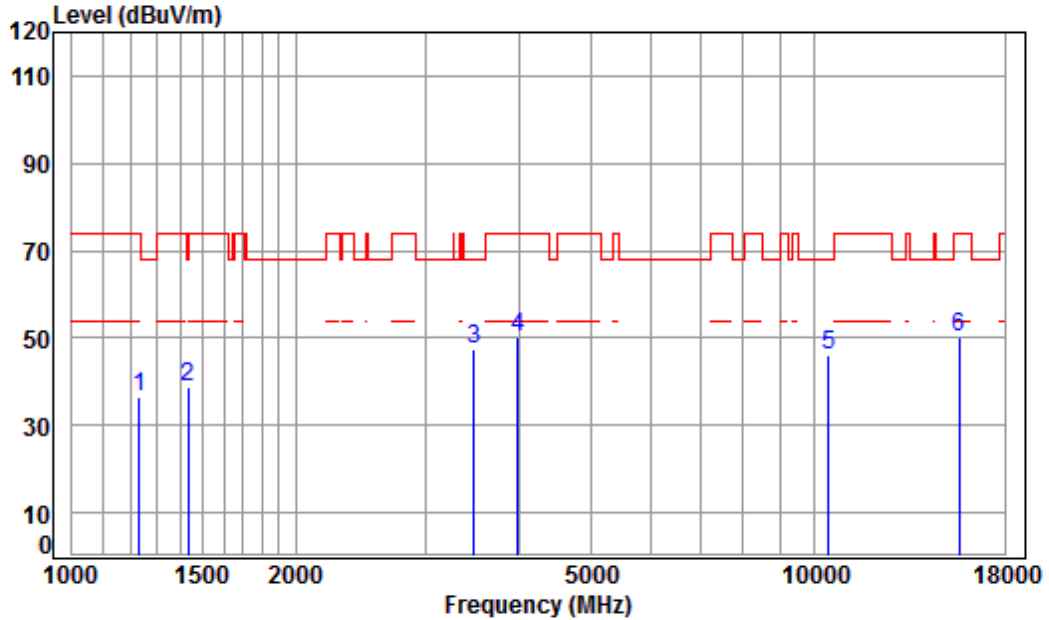

Condition: 3m VERTICAL
Job No : 04056CR/04057CR
Mode : 5210 TX RSE
Note : 5G WIFI 11AC80

	Freq	Cable Loss	Ant Factor	Preamp Factor	Read Level	Level	Limit	Over	Remark
	MHz	dB	dB/m	dB	dBuV	dBuV/m	dBuV/m	dB	
1	1231.345	4.54	24.63	38.07	45.26	36.36	74.00	-37.64	peak
2	1435.189	5.27	25.54	38.05	45.97	38.73	74.00	-35.27	peak
3 pp	3475.541	6.44	32.16	37.95	46.97	47.62	68.20	-20.58	peak
4	3981.257	6.96	33.55	38.00	47.48	49.99	74.00	-24.01	peak
5	10420.000	11.24	37.18	35.12	33.01	46.31	68.20	-21.89	peak
6	15630.000	14.44	41.35	38.20	32.39	49.98	74.00	-24.02	peak



Mode:f; Polarization:Horizontal; Modulation:802.11a; bandwidth:20MHz; Channel:Low

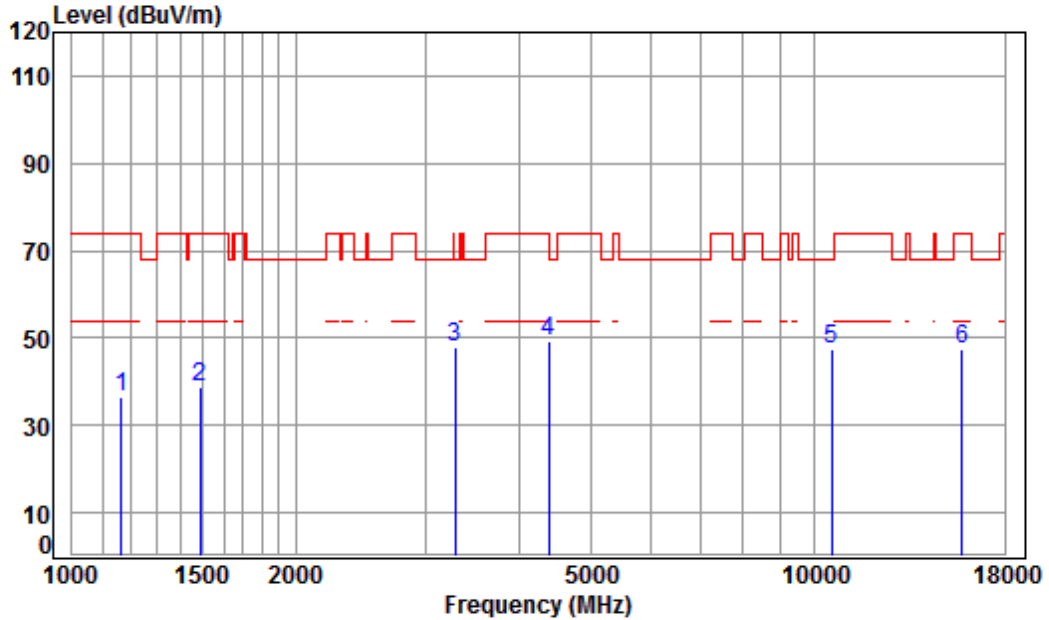

Condition: 3m HORIZONTAL
Job No : 04056CR/04057CR
Mode : 5260 TX RSE
Note : 5G WIFI 11A

	Freq	Cable Loss	Ant Factor	Preamp Factor	Read Level	Level	Limit	Over	Remark
	MHz	dB	dB/m	dB	dBuV	dBuV/m	dBuV/m	dB	
1	1165.546	4.28	24.31	38.08	46.19	36.70	74.00	-37.30	peak
2	1490.142	5.45	25.76	38.04	45.77	38.94	74.00	-35.06	peak
3 pp	3280.326	6.26	31.82	37.93	47.67	47.82	68.20	-20.38	peak
4	4379.699	7.43	33.60	38.20	46.36	49.19	74.00	-24.81	peak
5	10520.000	11.30	37.12	35.17	34.11	47.36	68.20	-20.84	peak
6	15780.000	14.66	41.29	38.04	29.41	47.32	74.00	-26.68	peak



Mode:f; Polarization:Vertical; Modulation:802.11a; bandwidth:20MHz; Channel:Low

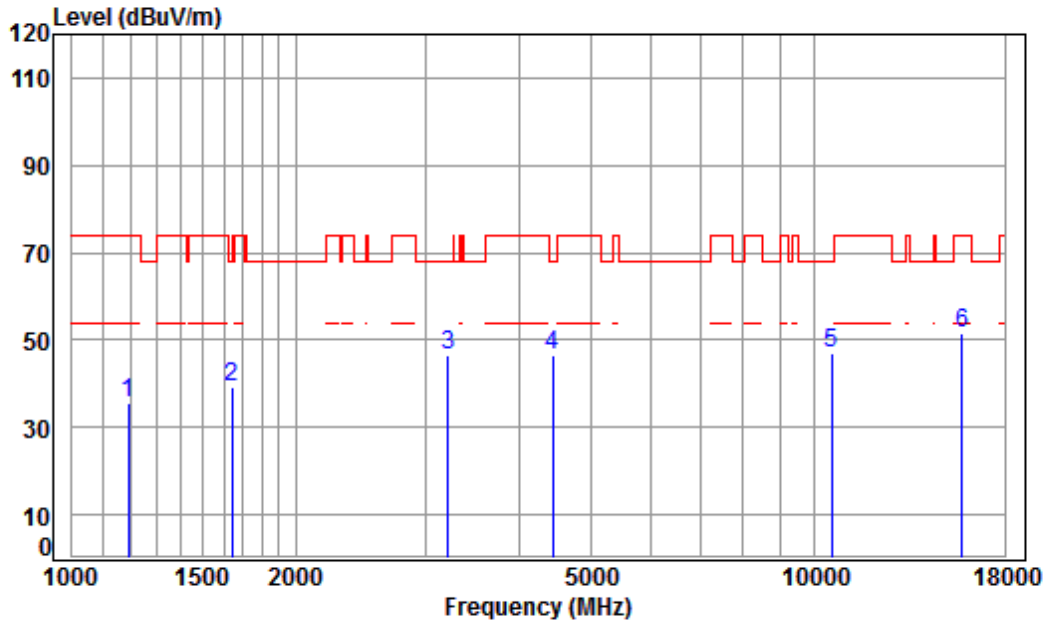

Condition: 3m VERTICAL
Job No : 04056CR/04057CR
Mode : 5260 TX RSE
Note : 5G WIFI 11A

	Cable	Ant	Preamp	Read	Limit	Over		
Freq	Loss	Factor	Factor	Level	Level	Line	Limit	Remark
MHz	dB	dB/m	dB	dBuV	dBuV/m	dBuV/m	dB	
1	1192.811	4.39	24.44	38.07	44.79	35.55	74.00	-38.45 peak
2	1644.019	5.30	26.44	38.03	45.38	39.09	68.20	-29.11 peak
3	3205.345	6.19	31.69	37.92	46.64	46.60	68.20	-21.60 peak
4	4443.453	7.50	33.60	38.24	43.84	46.70	68.20	-21.50 peak
5	pp10520.000	11.30	37.12	35.17	33.57	46.82	68.20	-21.38 peak
6	15780.000	14.66	41.29	38.04	33.62	51.53	74.00	-22.47 peak



Mode:f; Polarization:Horizontal; Modulation:802.11a; bandwidth:20MHz; Channel:middle

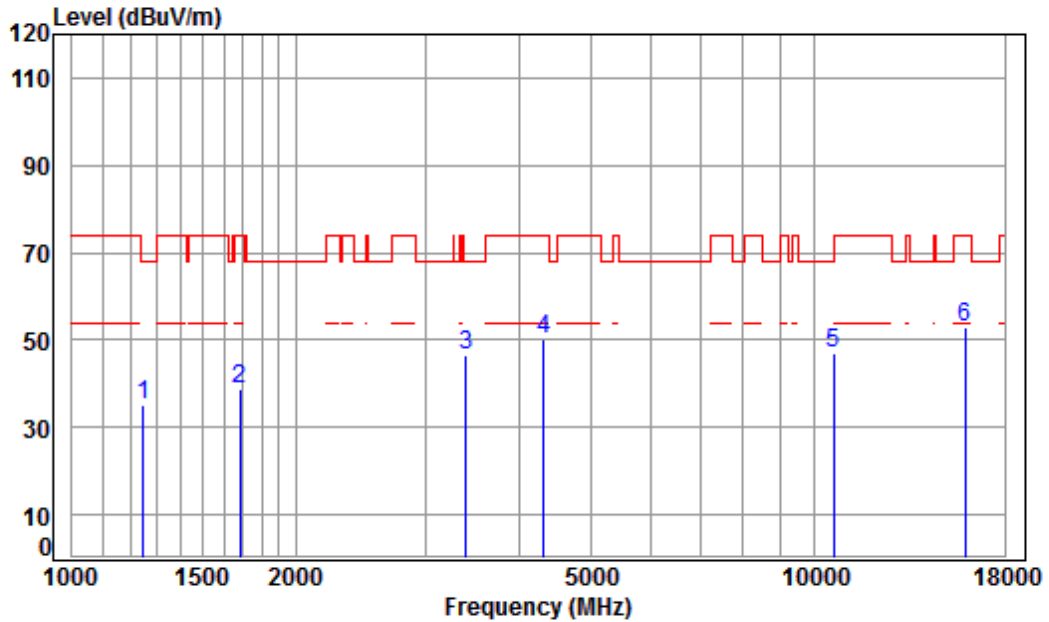

Condition: 3m HORIZONTAL
Job No : 04056CR/04057CR
Mode : 5300 TX RSE
Note : 5G WIFI 11A

	Freq	Cable Loss	Ant Factor	Preamp Factor	Read Level	Limit Level	Limit Line	Over Limit	Remark
	MHz	dB	dB/m	dB	dBuV	dBuV/m	dBuV/m	dB	
1	1249.269	4.61	24.72	38.07	44.09	35.35	68.20	-32.85	peak
2	1682.477	5.25	26.60	38.02	45.00	38.83	74.00	-35.17	peak
3	3396.098	6.37	32.02	37.94	46.28	46.73	68.20	-21.47	peak
4	4316.859	7.36	33.60	38.17	47.23	50.02	74.00	-23.98	peak
5	10600.000	11.36	37.22	35.21	33.40	46.77	68.20	-21.43	peak
6	pp15900.000	14.84	41.24	37.91	34.56	52.73	74.00	-21.27	peak



Mode:f; Polarization:Vertical; Modulation:802.11a; bandwidth:20MHz; Channel:middle

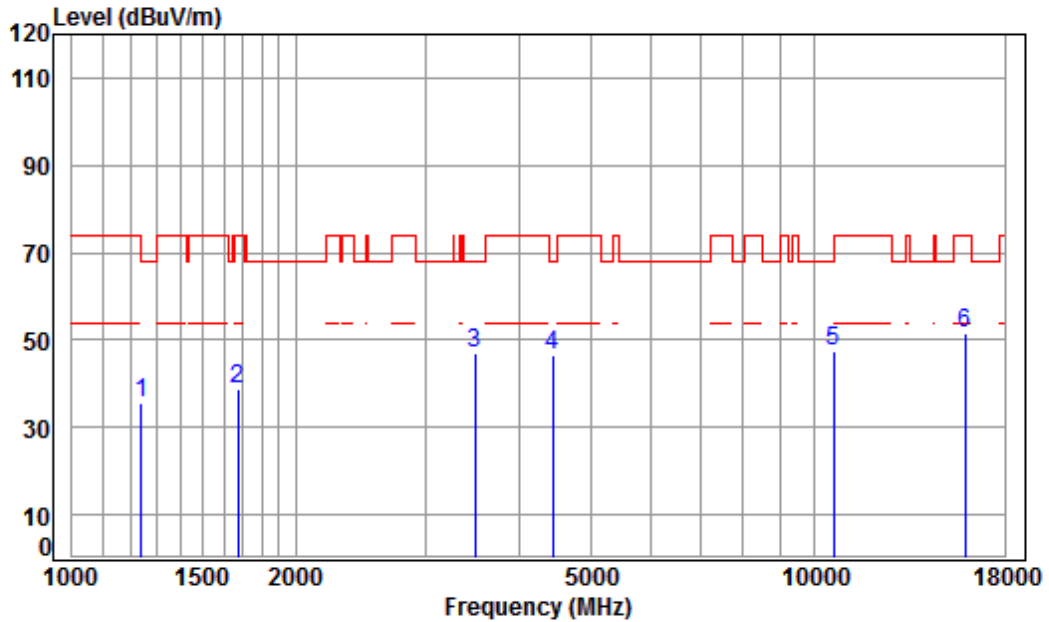

Condition: 3m VERTICAL
Job No : 04056CR/04057CR
Mode : 5300 TX RSE
Note : 5G WIFI 11A

	Freq	Cable Loss	Ant Factor	Preamp Factor	Read Level	Limit Level	Limit Line	Over Limit	Remark
	MHz	dB	dB/m	dB	dBuV	dBuV/m	dBuV/m	dB	
1	1238.483	4.57	24.67	38.07	44.61	35.78	74.00	-38.22	peak
2	1672.779	5.26	26.56	38.03	44.98	38.77	74.00	-35.23	peak
3	3485.601	6.45	32.18	37.95	46.34	47.02	68.20	-21.18	peak
4	4443.453	7.50	33.60	38.24	43.86	46.72	68.20	-21.48	peak
5	pp10600.000	11.36	37.22	35.21	33.86	47.23	68.20	-20.97	peak
6	15900.000	14.84	41.24	37.91	33.24	51.41	74.00	-22.59	peak



Mode:f; Polarization:Horizontal; Modulation:802.11a; bandwidth:20MHz; Channel:High

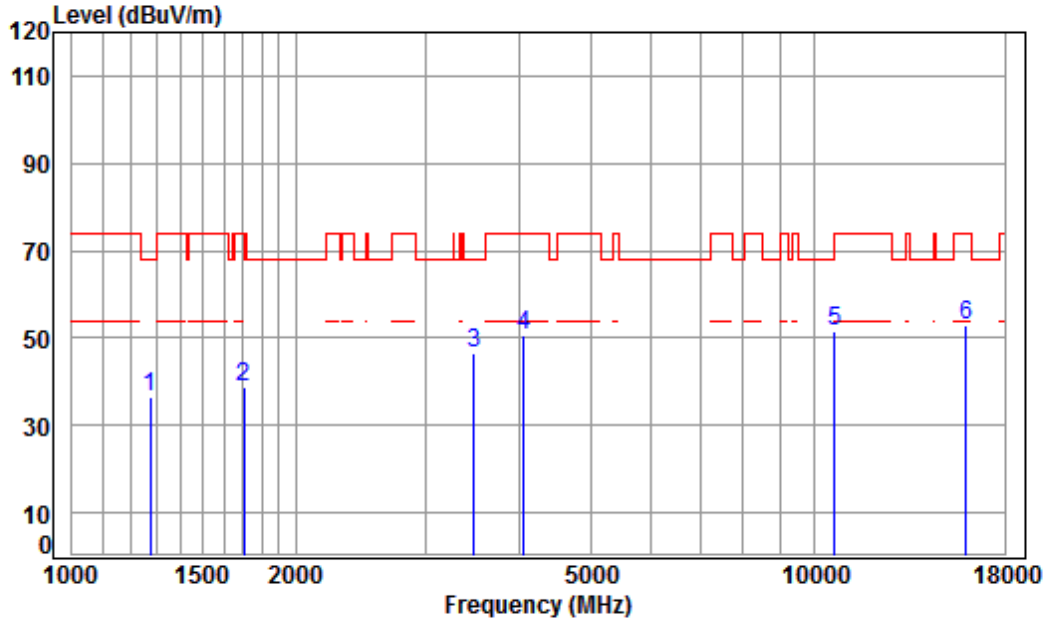

Condition: 3m HORIZONTAL
Job No : 04056CR/04057CR
Mode : 5320 TX RSE
Note : 5G WIFI 11A

	Freq	Cable Loss	Ant Factor	Preamp Factor	Read Level	Limit Level	Limit Line	Over Limit	Remark
	MHz	dB	dB/m	dB	dBuV	dBuV/m	dBuV/m	dB	
1	1274.802	4.71	24.84	38.06	45.08	36.57	68.20	-31.63	peak
2	1702.042	5.23	26.68	38.02	44.91	38.80	74.00	-35.20	peak
3	3475.541	6.44	32.16	37.95	45.89	46.54	68.20	-21.66	peak
4	4050.904	7.04	33.60	38.03	48.02	50.63	74.00	-23.37	peak
5	10640.000	11.39	37.27	35.23	38.05	51.48	74.00	-22.52	peak
6	pp15960.000	14.93	41.22	37.84	34.62	52.93	74.00	-21.07	peak



Mode:f; Polarization:Vertical; Modulation:802.11a; bandwidth:20MHz; Channel:High

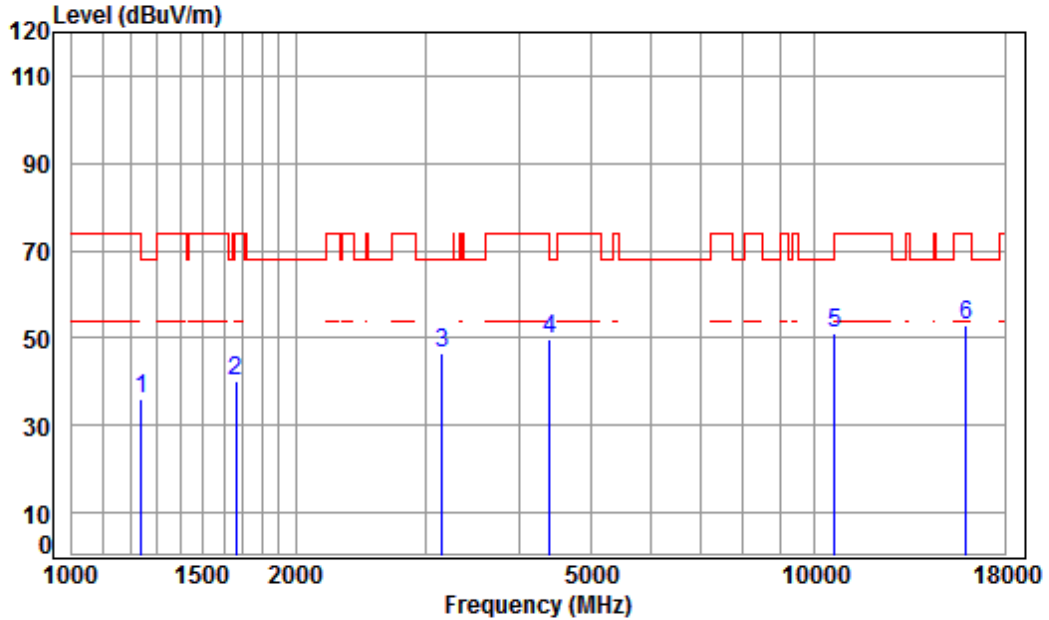

Condition: 3m VERTICAL
Job No : 04056CR/04057CR
Mode : 5320 TX RSE
Note : 5G WIFI 11A

	Freq	Cable Loss	Ant Factor	Preamp Factor	Read Level	Level	Limit	Over	Remark
	MHz	dB	dB/m	dB	dBuV	dBuV/m	dBuV/m	dB	
1	1238.483	4.57	24.67	38.07	44.76	35.93	74.00	-38.07	peak
2	1663.137	5.27	26.52	38.03	46.40	40.16	74.00	-33.84	peak
3	3150.237	6.13	31.59	37.92	46.78	46.58	68.20	-21.62	peak
4	4392.376	7.44	33.60	38.21	46.76	49.59	74.00	-24.41	peak
5	10640.000	11.39	37.27	35.23	37.51	50.94	74.00	-23.06	peak
6	pp15960.000	14.93	41.22	37.84	34.71	53.02	74.00	-20.98	peak



Mode:f; Polarization:Horizontal; Modulation:802.11n; bandwidth:20MHz; Channel:Low

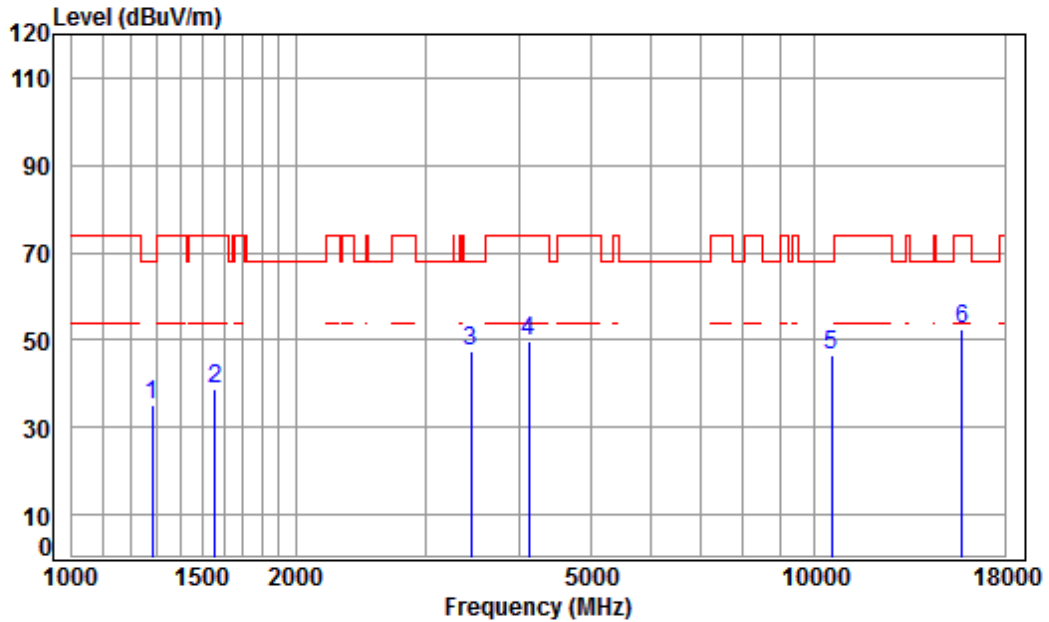

Condition: 3m HORIZONTAL
Job No : 04056CR/04057CR
Mode : 5260 TX RSE
Note : 5G WIFI 11N20

	Freq	Cable Loss	Ant Factor	Preamp Factor	Read Level	Level	Limit	Over	Remark
	MHz	dB	dB/m	dB	dBuV	dBuV/m	dBuV/m	dB	
1	1282.193	4.73	24.87	38.06	43.74	35.28	68.20	-32.92	peak
2	1556.169	5.41	26.06	38.04	45.22	38.65	74.00	-35.35	peak
3	pp 3445.535	6.41	32.11	37.95	46.74	47.31	68.20	-20.89	peak
4	4121.768	7.13	33.60	38.07	46.99	49.65	74.00	-24.35	peak
5	10520.000	11.30	37.12	35.17	33.39	46.64	68.20	-21.56	peak
6	15780.000	14.66	41.29	38.04	34.62	52.53	74.00	-21.47	peak



Mode:f; Polarization:Vertical; Modulation:802.11n; bandwidth:20MHz; Channel:Low

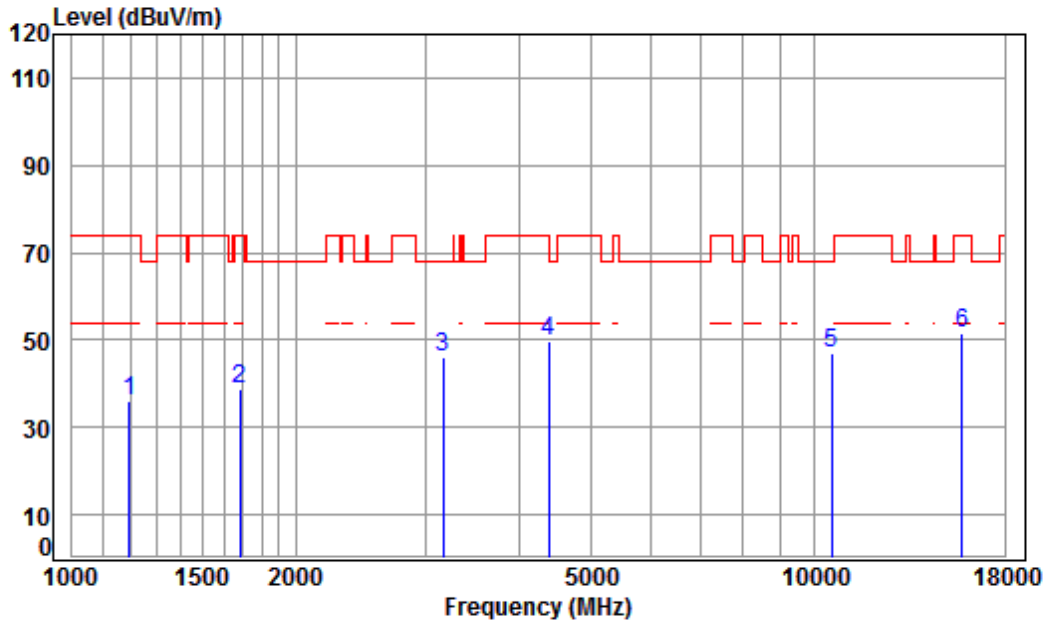

Condition: 3m VERTICAL
Job No : 04056CR/04057CR
Mode : 5260 TX RSE
Note : 5G WIFI 11N20

	Freq	Cable Loss	Ant Factor	Preamp Factor	Read Level	Limit Level	Over Limit	Remark
	MHz	dB	dB/m	dB	dBuV	dBuV/m	dBuV/m	dB
1	1196.264	4.40	24.46	38.07	45.27	36.06	74.00	-37.94 peak
2	1682.477	5.25	26.60	38.02	44.73	38.56	74.00	-35.44 peak
3	3159.355	6.14	31.60	37.92	46.32	46.14	68.20	-22.06 peak
4	4379.699	7.43	33.60	38.20	47.10	49.93	74.00	-24.07 peak
5	pp10520.000	11.30	37.12	35.17	33.91	47.16	68.20	-21.04 peak
6	15780.000	14.66	41.29	38.04	33.61	51.52	74.00	-22.48 peak



Mode:f; Polarization:Horizontal; Modulation:802.11n; bandwidth:20MHz; Channel:middle

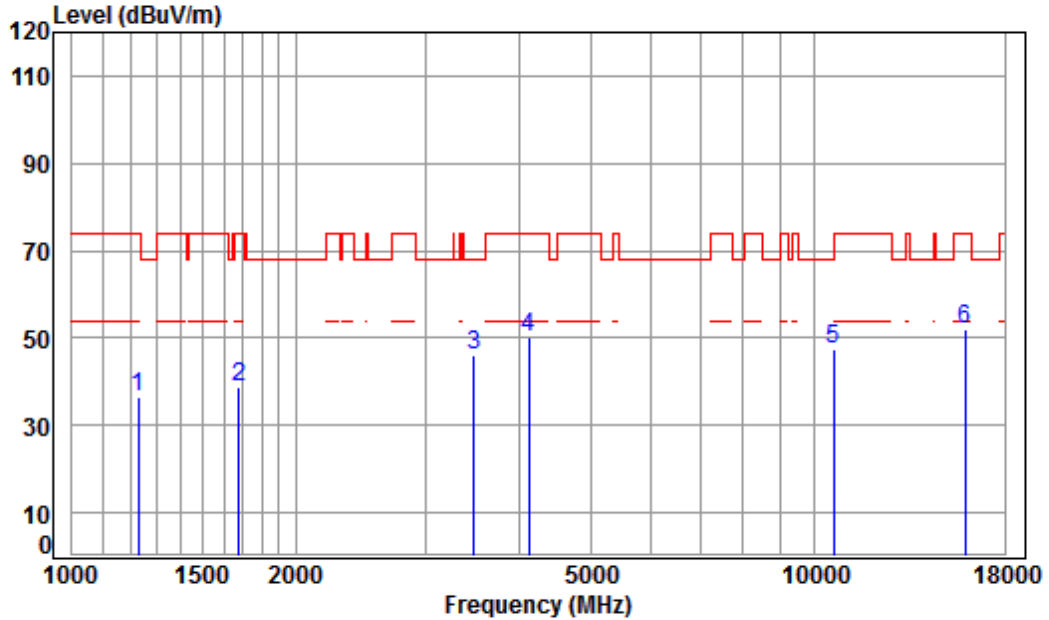

Condition: 3m HORIZONTAL
Job No : 04056CR/04057CR
Mode : 5300 TX RSE
Note : 5G WIFI 11N20

	Freq	Cable Loss	Ant Factor	Preamp Factor	Read Level	Level	Limit	Over	Remark
	MHz	dB	dB/m	dB	dBuV	dBuV/m	dBuV/m	dB	
1	1227.791	4.53	24.61	38.07	45.64	36.71	74.00	-37.29	peak
2	1677.621	5.25	26.58	38.03	44.95	38.75	74.00	-35.25	peak
3	3475.541	6.44	32.16	37.95	45.42	46.07	68.20	-22.13	peak
4	4121.768	7.13	33.60	38.07	47.73	50.39	74.00	-23.61	peak
5	pp10600.000	11.36	37.22	35.21	33.94	47.31	68.20	-20.89	peak
6	15900.000	14.84	41.24	37.91	33.93	52.10	74.00	-21.90	peak



Mode:f; Polarization:Vertical; Modulation:802.11n; bandwidth:20MHz; Channel:middle

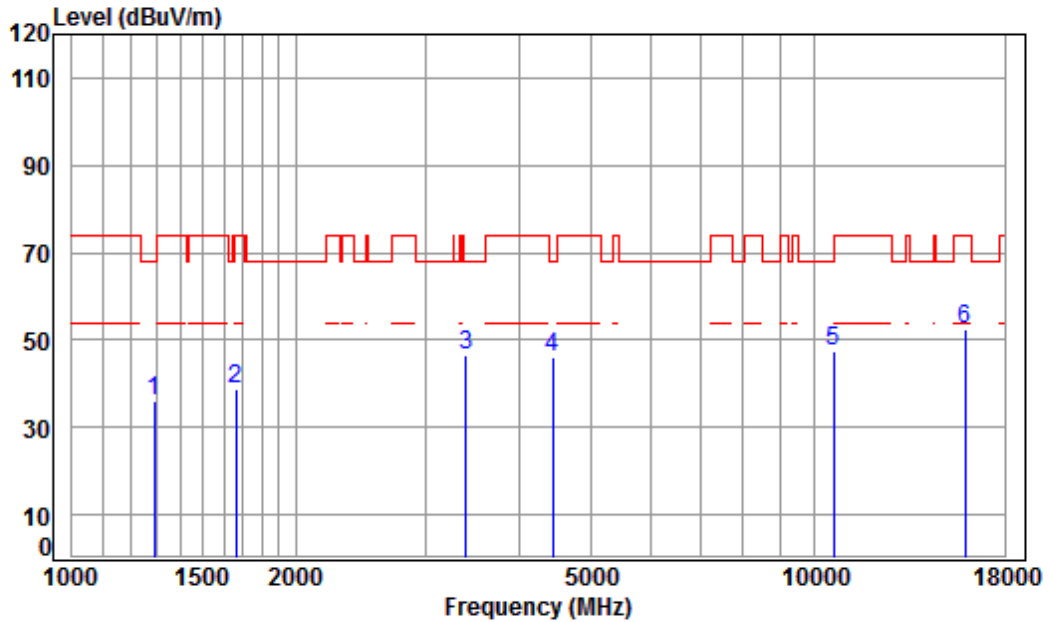

Condition: 3m VERTICAL
Job No : 04056CR/04057CR
Mode : 5300 TX RSE
Note : 5G WIFI 11N20

	Freq	Cable Loss	Ant Factor	Preamp Factor	Read Level	Limit Level	Limit Line	Over Limit	Remark
	MHz	dB	dB/m	dB	dBuV	dBuV/m	dBuV/m	dB	
1	1289.627	4.76	24.91	38.06	44.34	35.95	68.20	-32.25	peak
2	1663.137	5.27	26.52	38.03	44.95	38.71	74.00	-35.29	peak
3	3396.098	6.37	32.02	37.94	46.26	46.71	68.20	-21.49	peak
4	4443.453	7.50	33.60	38.24	43.44	46.30	68.20	-21.90	peak
5	pp10600.000	11.36	37.22	35.21	34.06	47.43	68.20	-20.77	peak
6	15900.000	14.84	41.24	37.91	34.12	52.29	74.00	-21.71	peak



Mode:f; Polarization:Horizontal; Modulation:802.11n; bandwidth:20MHz; Channel:High

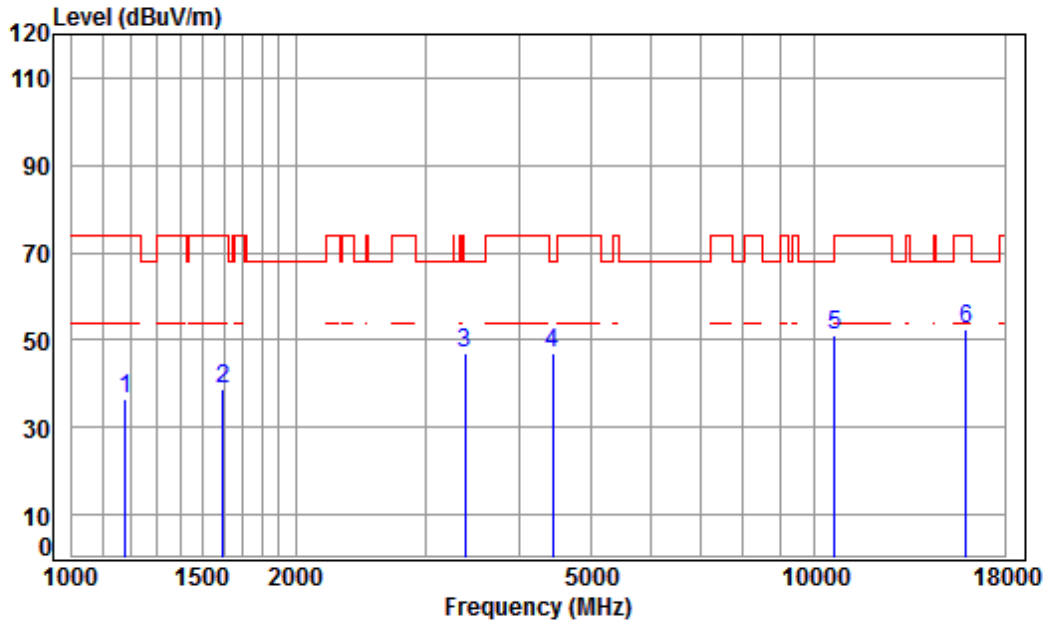

Condition: 3m HORIZONTAL
Job No : 04056CR/04057CR
Mode : 5320 TX RSE
Note : 5G WIFI 11N20

	Freq	Cable Loss	Ant Factor	Preamp Factor	Read Level	Limit Level	Limit Line	Over Limit	Remark
	MHz	dB	dB/m	dB	dBuV	dBuV/m	dBuV/m	dB	
1	1179.100	4.33	24.38	38.08	45.71	36.34	74.00	-37.66	peak
2	1597.181	5.35	26.24	38.03	45.17	38.73	74.00	-35.27	peak
3 pp	3376.523	6.35	31.99	37.94	46.60	47.00	68.20	-21.20	peak
4	4443.453	7.50	33.60	38.24	43.96	46.82	68.20	-21.38	peak
5	10640.000	11.39	37.27	35.23	37.88	51.31	74.00	-22.69	peak
6	15960.000	14.93	41.22	37.84	34.05	52.36	74.00	-21.64	peak



Mode:f; Polarization:Vertical; Modulation:802.11n; bandwidth:20MHz; Channel:High

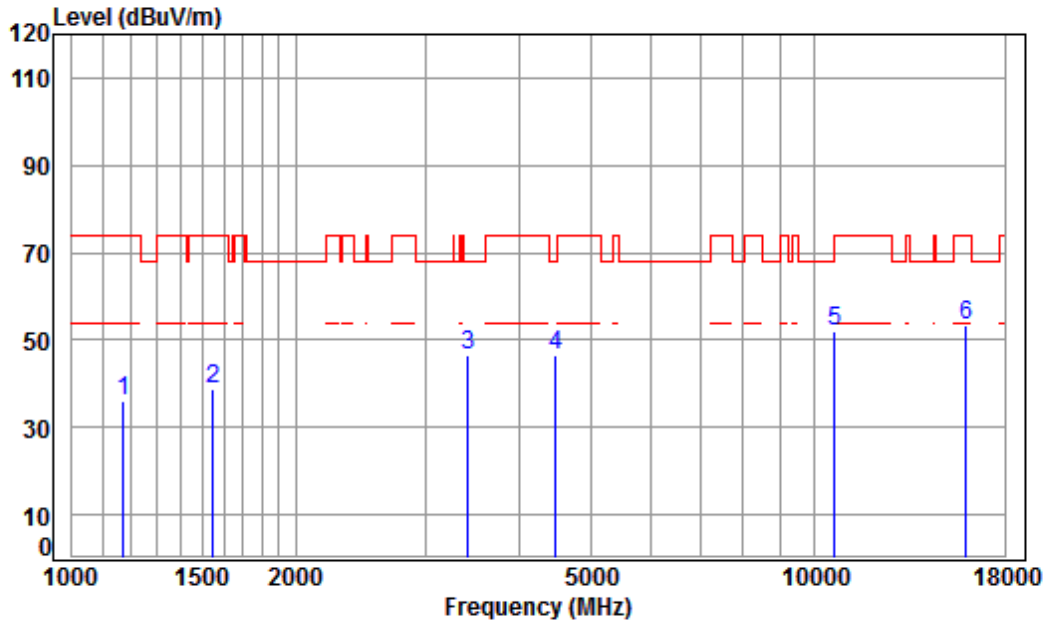

Condition: 3m VERTICAL
Job No : 04056CR/04057CR
Mode : 5320 TX RSE
Note : 5G WIFI 11N20

	Freq	Cable Loss	Ant Factor	Preamp Factor	Read Level	Limit Level	Limit Line	Over Limit	Remark
	MHz	dB	dB/m	dB	dBuV	dBuV/m	dBuV/m	dB	
1	1172.303	4.31	24.34	38.08	45.70	36.27	74.00	-37.73	peak
2	1547.199	5.42	26.02	38.04	45.34	38.74	74.00	-35.26	peak
3	3415.787	6.38	32.06	37.95	46.21	46.70	68.20	-21.50	peak
4	4482.150	7.54	33.60	38.26	43.73	46.61	68.20	-21.59	peak
5	10640.000	11.39	37.27	35.23	38.36	51.79	74.00	-22.21	peak
6	pp15960.000	14.93	41.22	37.84	35.10	53.41	74.00	-20.59	peak



Mode:f; Polarization:Horizontal; Modulation:802.11n; bandwidth:40MHz; Channel:Low

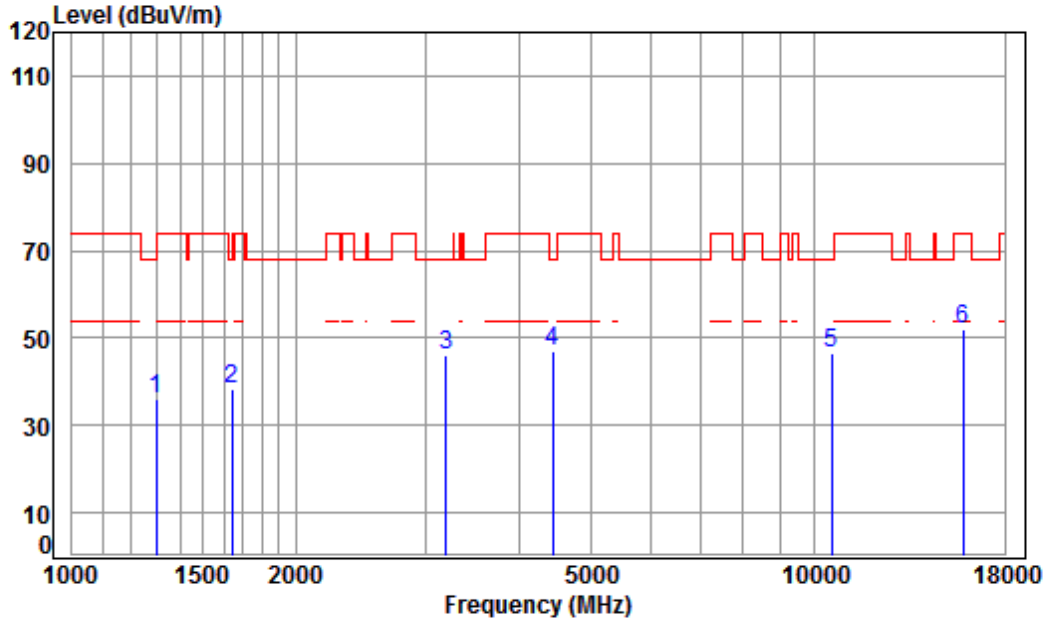

Condition: 3m HORIZONTAL
Job No : 04056CR/04057CR
Mode : 5270 TX RSE
Note : 5G WIFI 11N40

	Freq	Cable Loss	Ant Factor	Preamp Factor	Read Level	Level	Limit	Over	Remark
	MHz	dB	dB/m	dB	dBuV	dBuV/m	dBuV/m	dB	
1	1300.858	4.80	24.96	38.06	44.12	35.82	74.00	-38.18	peak
2	1644.019	5.30	26.44	38.03	44.58	38.29	68.20	-29.91	peak
3	3186.869	6.17	31.65	37.92	46.23	46.13	68.20	-22.07	peak
4	pp 4443.453	7.50	33.60	38.24	44.07	46.93	68.20	-21.27	peak
5	10540.000	11.32	37.15	35.18	33.10	46.39	68.20	-21.81	peak
6	15810.000	14.71	41.28	38.00	34.16	52.15	74.00	-21.85	peak



Mode:f; Polarization:Vertical; Modulation:802.11n; bandwidth:40MHz; Channel:Low

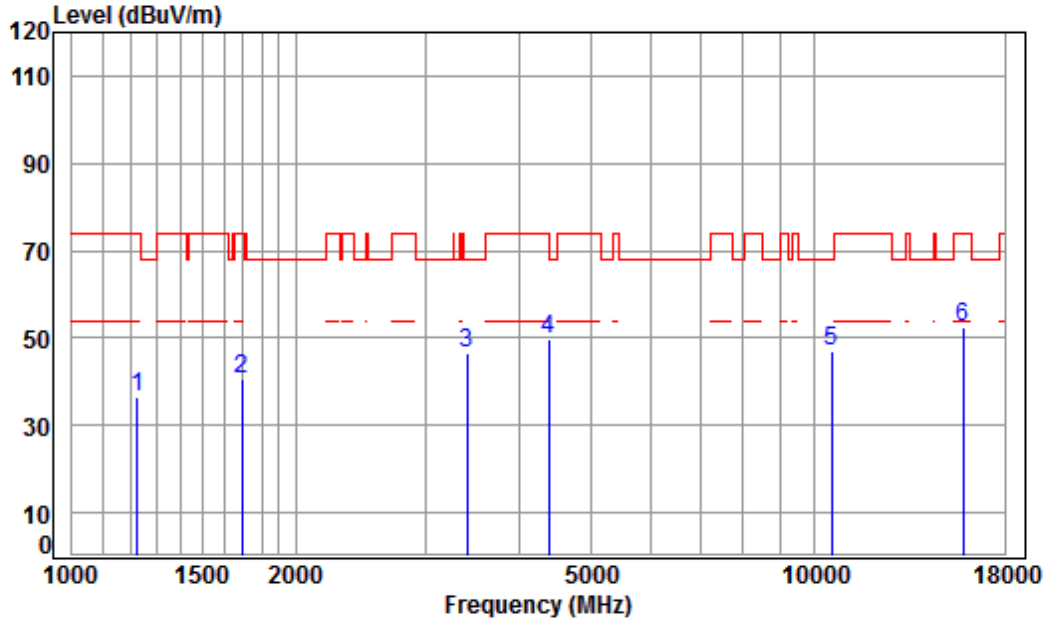

Condition: 3m VERTICAL
Job No : 04056CR/04057CR
Mode : 5270 TX RSE
Note : 5G WIFI 11N40

	Freq	Cable Loss	Ant Factor	Preamp Factor	Read Level	Limit Level	Over Limit	Remark
	MHz	dB	dB/m	dB	dBuV	dBuV/m	dBuV/m	dB
1	1224.247	4.51	24.60	38.07	45.31	36.35	74.00	-37.65 peak
2	1692.231	5.24	26.64	38.02	46.78	40.64	74.00	-33.36 peak
3	3405.929	6.38	32.04	37.94	46.08	46.56	68.20	-21.64 peak
4	4379.699	7.43	33.60	38.20	47.01	49.84	74.00	-24.16 peak
5	10540.000	11.32	37.15	35.18	33.57	46.86	68.20	-21.34 peak
6	pp15810.000	14.71	41.28	38.00	34.70	52.69	74.00	-21.31 peak



Mode:f; Polarization:Horizontal; Modulation:802.11n; bandwidth:40MHz; Channel:High

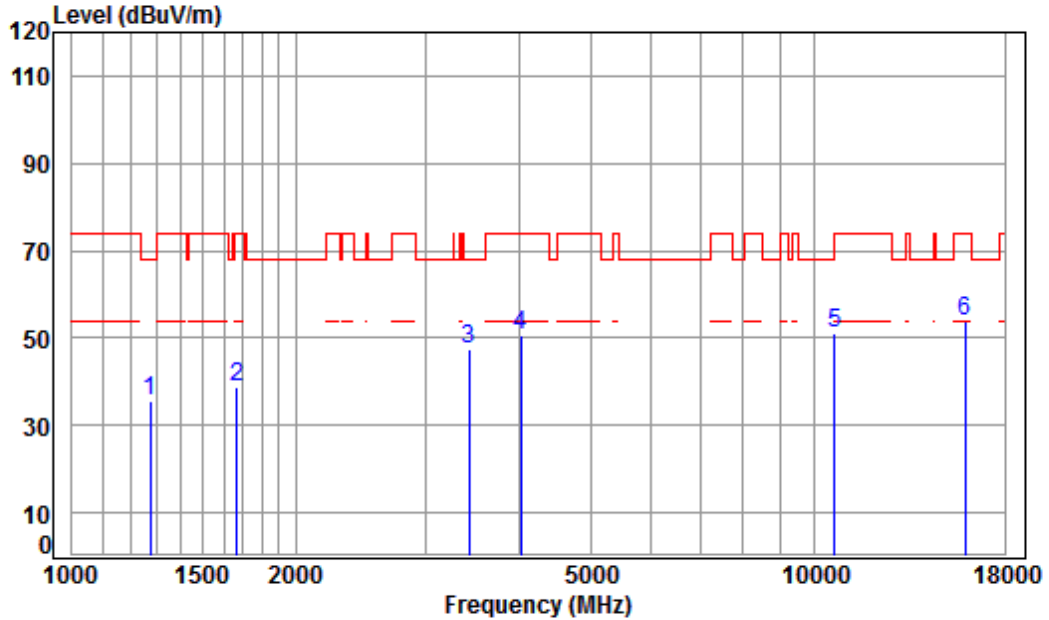

Condition: 3m HORIZONTAL
Job No : 04056CR/04057CR
Mode : 5310 TX RSE
Note : 5G WIFI 11N40

	Freq	Cable Loss	Ant Factor	Preamp Factor	Read Level	Level	Limit	Over	Remark
	MHz	dB	dB/m	dB	dBuV	dBuV/m	dBuV/m	dB	
1	1274.802	4.71	24.84	38.06	44.17	35.66	68.20	-32.54	peak
2	1667.951	5.27	26.54	38.03	45.17	38.95	74.00	-35.05	peak
3	3425.675	6.39	32.07	37.95	47.07	47.58	68.20	-20.62	peak
4	4015.929	7.00	33.60	38.01	47.88	50.47	74.00	-23.53	peak
5	10620.000	11.37	37.25	35.22	37.91	51.31	74.00	-22.69	peak
6	pp15930.000	14.89	41.23	37.87	35.38	53.63	74.00	-20.37	peak



Mode:f; Polarization:Vertical; Modulation:802.11n; bandwidth:40MHz; Channel:High

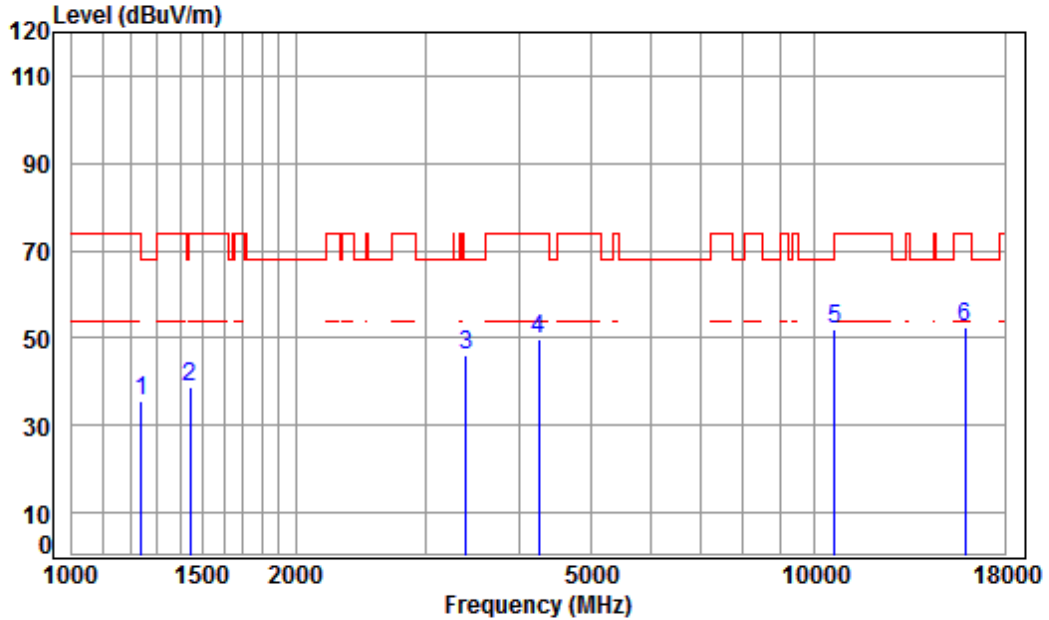

Condition: 3m VERTICAL
Job No : 04056CR/04057CR
Mode : 5310 TX RSE
Note : 5G WIFI 11N40

	Freq	Cable Loss	Ant Factor	Preamp Factor	Read Level	Level	Limit	Over	Remark
	MHz	dB	dB/m	dB	dBuV	dBuV/m	dBuV/m	dB	
1	1238.483	4.57	24.67	38.07	44.27	35.44	74.00	-38.56	peak
2	1443.509	5.30	25.57	38.05	45.79	38.61	74.00	-35.39	peak
3	3396.098	6.37	32.02	37.94	45.73	46.18	68.20	-22.02	peak
4	4242.641	7.27	33.60	38.13	47.14	49.88	74.00	-24.12	peak
5	10620.000	11.37	37.25	35.22	38.48	51.88	74.00	-22.12	peak
6	pp15930.000	14.89	41.23	37.87	34.07	52.32	74.00	-21.68	peak



Mode:f; Polarization:Horizontal; Modulation:802.11ac; bandwidth:20MHz; Channel:Low

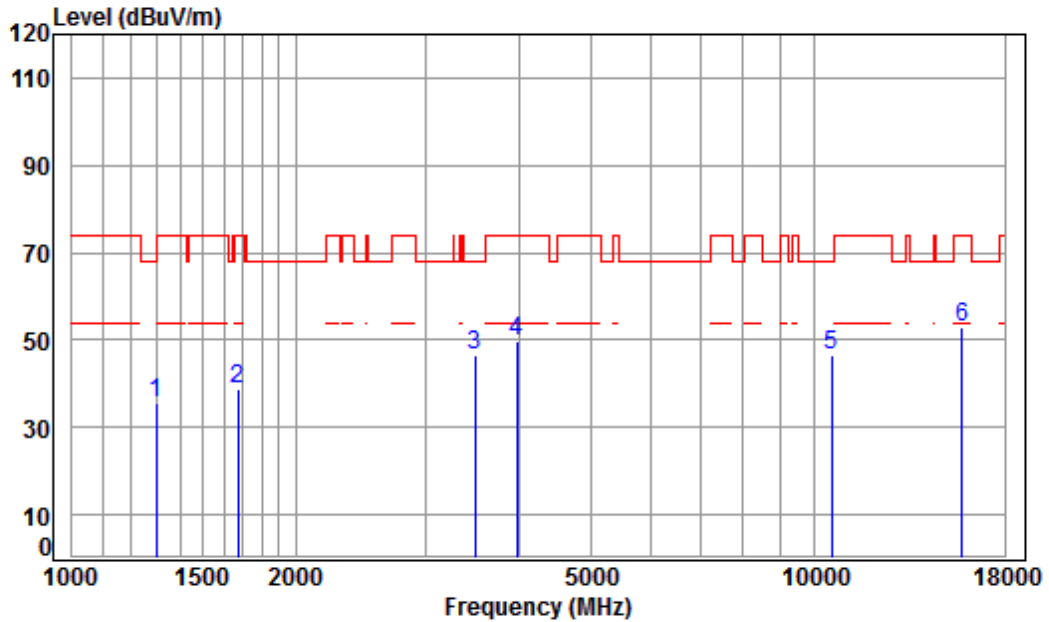

Condition: 3m HORIZONTAL
Job No : 04056CR/04057CR
Mode : 5260 TX RSE
Note : 5G WIFI 11AC20

	Cable	Ant	Preamp	Read	Limit	Over		
Freq	Loss	Factor	Factor	Level	Level	Line	Limit	Remark
MHz	dB	dB/m	dB	dBuV	dBuV/m	dBuV/m	dB	
1	1300.858	4.80	24.96	38.06	44.09	35.79	74.00	-38.21 peak
2	1672.779	5.26	26.56	38.03	44.86	38.65	74.00	-35.35 peak
3	3485.601	6.45	32.18	37.95	45.71	46.39	68.20	-21.81 peak
4	3969.767	6.95	33.52	38.00	47.32	49.79	74.00	-24.21 peak
5	10520.000	11.30	37.12	35.17	33.45	46.70	68.20	-21.50 peak
6	pp15780.000	14.66	41.29	38.04	34.85	52.76	74.00	-21.24 peak



Mode:f; Polarization:Vertical; Modulation:802.11ac; bandwidth:20MHz; Channel:Low

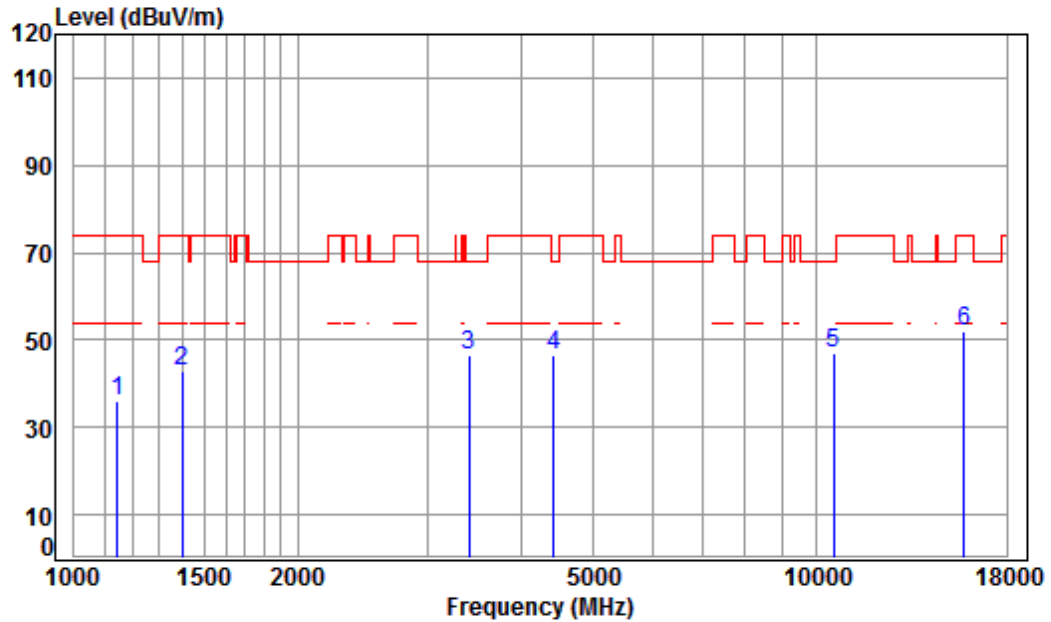

Condition: 3m VERTICAL
Job No : 04056CR/04057CR
Mode : 5260 TX RSE
Note : 5G WIFI 11AC20

	Freq	Cable Loss	Ant Factor	Preamp Factor	Read Level	Level	Limit	Over	Remark
	MHz	dB	dB/m	dB	dBuV	dBuV/m	dBuV/m	dB	
1	1145.507	4.20	24.20	38.08	45.91	36.23	74.00	-37.77	peak
2	1398.336	5.15	25.38	38.05	50.23	42.71	74.00	-31.29	peak
3	3405.929	6.38	32.04	37.94	45.95	46.43	68.20	-21.77	peak
4	4417.841	7.47	33.60	38.22	43.70	46.55	68.20	-21.65	peak
5	pp10520.000	11.30	37.12	35.17	33.60	46.85	68.20	-21.35	peak
6	15780.000	14.66	41.29	38.04	34.02	51.93	74.00	-22.07	peak



Mode:f; Polarization:Horizontal; Modulation:802.11ac; bandwidth:20MHz; Channel:middle

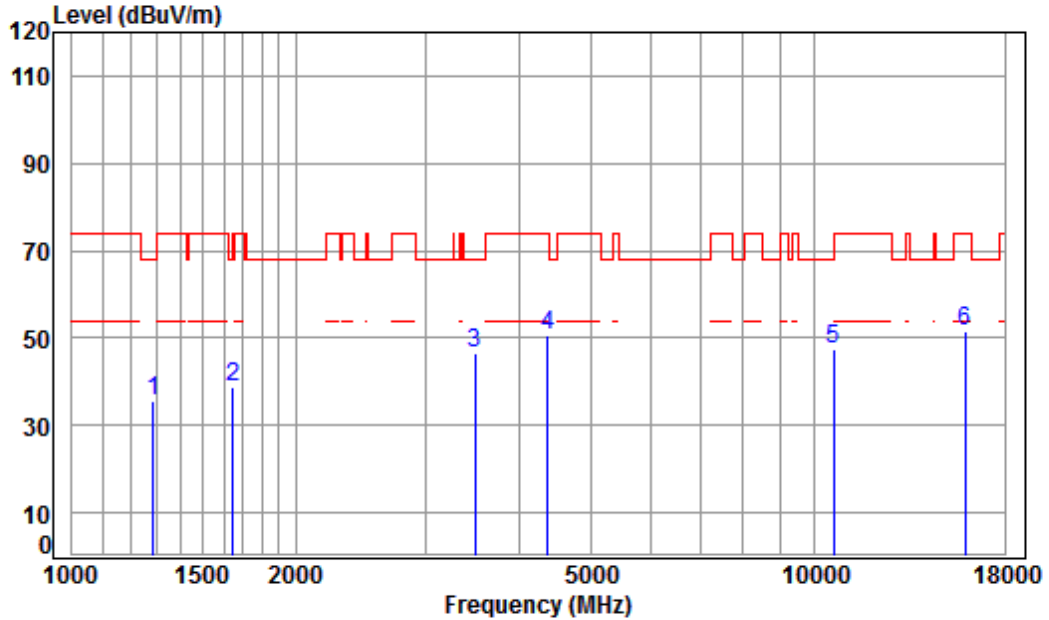

Condition: 3m HORIZONTAL
Job No : 04056CR/04057CR
Mode : 5300 TX RSE
Note : 5G WIFI 11AC20

	Freq	Cable Loss	Ant Factor	Preamp Factor	Read Level	Level	Limit	Over	Remark
	MHz	dB	dB/m	dB	dBuV	dBuV/m	dBuV/m	dB	
1	1285.904	4.75	24.89	38.06	44.19	35.77	68.20	-32.43	peak
2	1648.778	5.29	26.46	38.03	44.97	38.69	68.20	-29.51	peak
3	3485.601	6.45	32.18	37.95	45.97	46.65	68.20	-21.55	peak
4	4367.058	7.41	33.60	38.20	47.89	50.70	74.00	-23.30	peak
5	pp10600.000	11.36	37.22	35.21	34.07	47.44	68.20	-20.76	peak
6	15900.000	14.84	41.24	37.91	33.59	51.76	74.00	-22.24	peak



Mode:f; Polarization:Vertical; Modulation:802.11ac; bandwidth:20MHz; Channel:middle

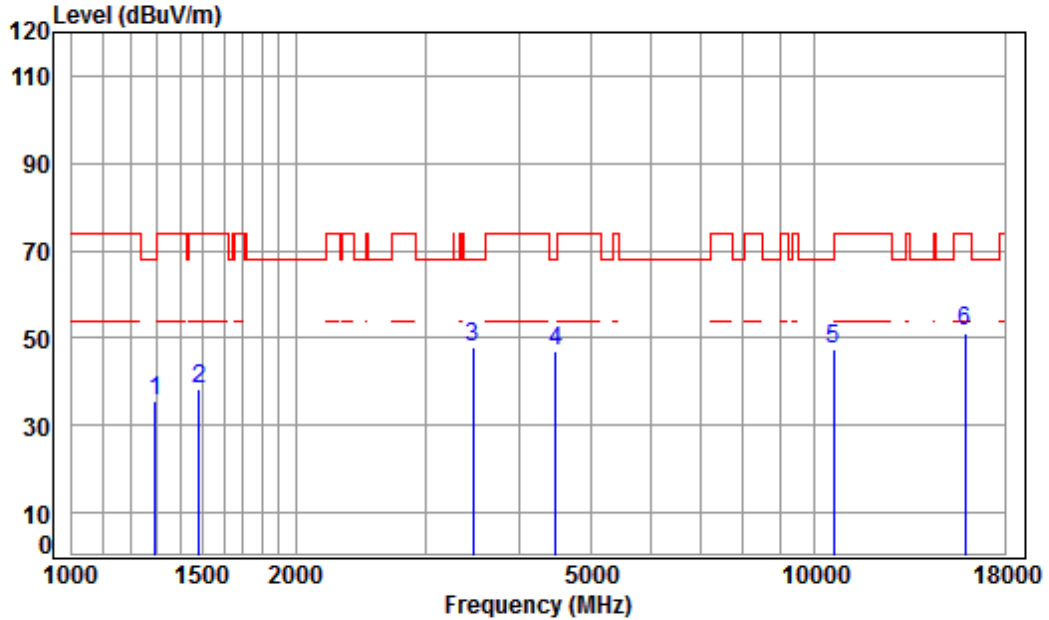

Condition: 3m VERTICAL
Job No : 04056CR/04057CR
Mode : 5300 TX RSE
Note : 5G WIFI 11AC20

	Freq	Cable Loss	Ant Factor	Preamp Factor	Read Level	Level	Limit	Over	Remark
	MHz	dB	dB/m	dB	dBuV	dBuV/m	dBuV/m	dB	
1	1293.359	4.77	24.92	38.06	44.09	35.72	68.20	-32.48	peak
2	1481.553	5.42	25.73	38.04	45.37	38.48	74.00	-35.52	peak
3	pp 3465.510	6.43	32.14	37.95	47.27	47.89	68.20	-20.31	peak
4	4482.150	7.54	33.60	38.26	43.98	46.86	68.20	-21.34	peak
5	10600.000	11.36	37.22	35.21	34.04	47.41	68.20	-20.79	peak
6	15900.000	14.84	41.24	37.91	33.16	51.33	74.00	-22.67	peak



Mode:f; Polarization:Horizontal; Modulation:802.11ac; bandwidth:20MHz; Channel:High

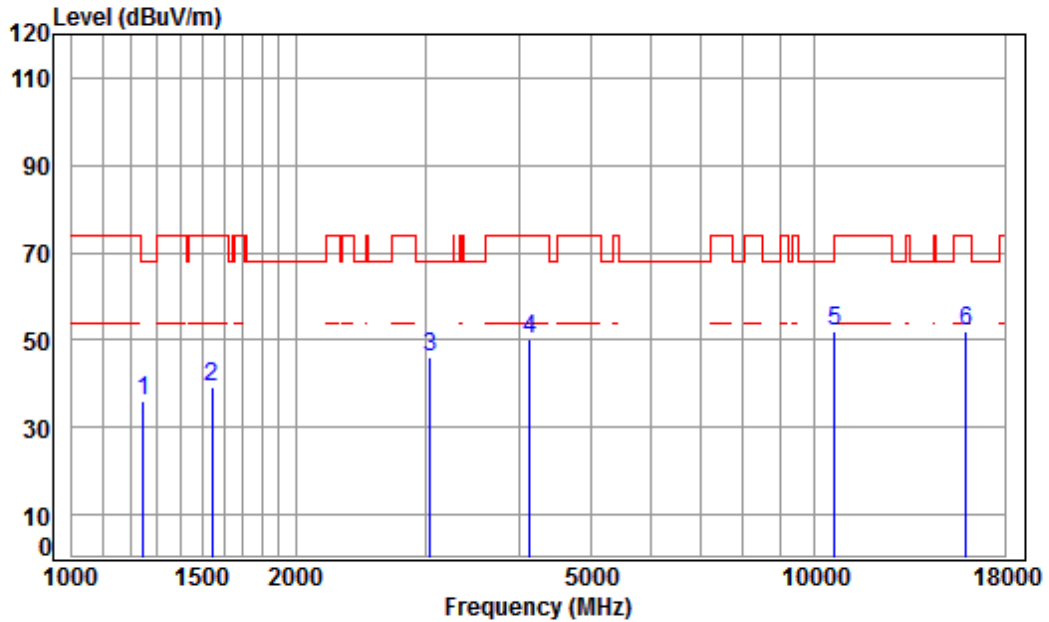

Condition: 3m HORIZONTAL
Job No : 04056CR/04057CR
Mode : 5320 TX RSE
Note : 5G WIFI 11AC20

	Freq	Cable Loss	Ant Factor	Preamp Factor	Read Level	Level	Limit	Over	Remark
	MHz	dB	dB/m	dB	dBuV	dBuV/m	dBuV/m	dB	
1	1249.269	4.61	24.72	38.07	44.92	36.18	68.20	-32.02	peak
2	1542.733	5.42	26.00	38.04	46.02	39.40	74.00	-34.60	peak
3	3034.063	6.02	31.37	37.90	46.49	45.98	68.20	-22.22	peak
4	4133.699	7.14	33.60	38.07	47.38	50.05	74.00	-23.95	peak
5	pp10640.000	11.39	37.27	35.23	38.56	51.99	74.00	-22.01	peak
6	15960.000	14.93	41.22	37.84	33.62	51.93	74.00	-22.07	peak



Mode:f; Polarization:Vertical; Modulation:802.11ac; bandwidth:20MHz; Channel:High

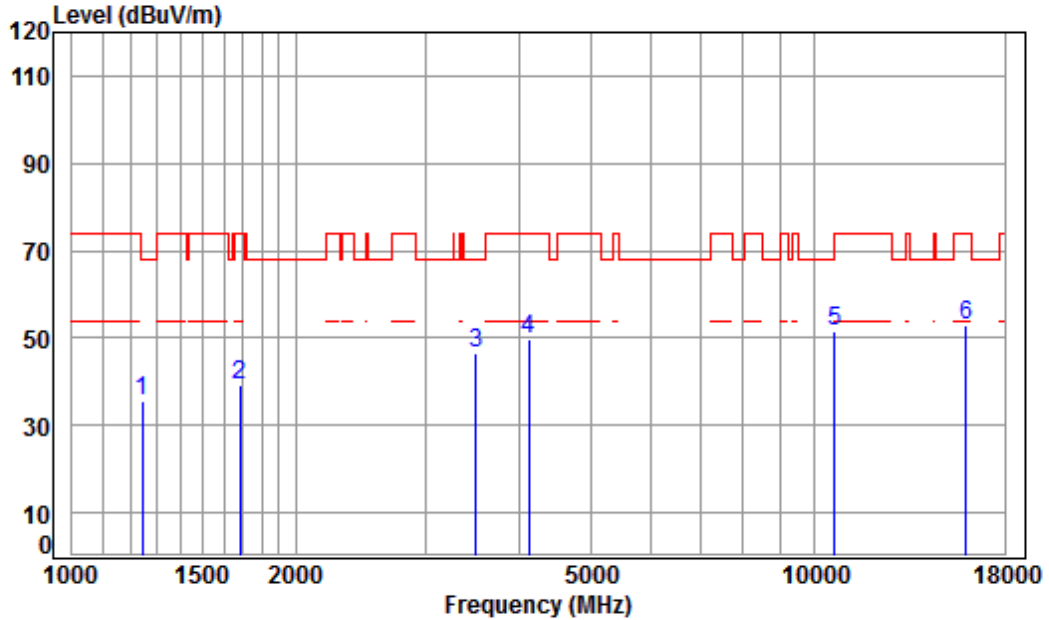

Condition: 3m VERTICAL
Job No : 04056CR/04057CR
Mode : 5320 TX RSE
Note : 5G WIFI 11AC20

	Freq	Cable Loss	Ant Factor	Preamp Factor	Read Level	Limit Level	Limit Line	Over Limit	Remark
	MHz	dB	dB/m	dB	dBuV	dBuV/m	dBuV/m	dB	
1	1245.663	4.60	24.70	38.07	44.44	35.67	68.20	-32.53	peak
2	1682.477	5.25	26.60	38.02	45.21	39.04	74.00	-34.96	peak
3	3495.691	6.46	32.19	37.95	45.73	46.43	68.20	-21.77	peak
4	4121.768	7.13	33.60	38.07	46.95	49.61	74.00	-24.39	peak
5	10640.000	11.39	37.27	35.23	38.35	51.78	74.00	-22.22	peak
6	pp15960.000	14.93	41.22	37.84	34.84	53.15	74.00	-20.85	peak



Mode:f; Polarization:Horizontal; Modulation:802.11ac; bandwidth:40MHz; Channel:Low

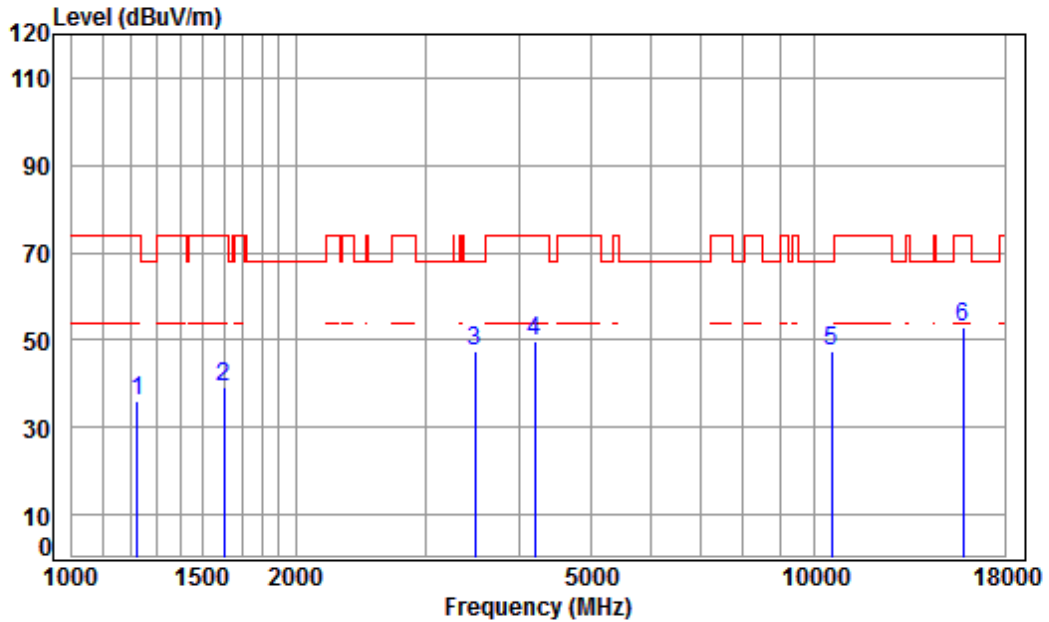

Condition: 3m HORIZONTAL
Job No : 04056CR/04057CR
Mode : 5270 TX RSE
Note : 5G WIFI 11AC40

	Freq	Cable Loss	Ant Factor	Preamp Factor	Read Level	Level	Limit	Over	Remark
	MHz	dB	dB/m	dB	dBuV	dBuV/m	dBuV/m	dB	
1	1224.247	4.51	24.60	38.07	45.09	36.13	74.00	-37.87	peak
2	1601.804	5.35	26.26	38.03	45.71	39.29	74.00	-34.71	peak
3	3485.601	6.45	32.18	37.95	46.62	47.30	68.20	-20.90	peak
4	4193.872	7.21	33.60	38.11	47.14	49.84	74.00	-24.16	peak
5	pp10540.000	11.32	37.15	35.18	34.11	47.40	68.20	-20.80	peak
6	15810.000	14.71	41.28	38.00	35.05	53.04	74.00	-20.96	peak



Mode:f; Polarization:Vertical; Modulation:802.11ac; bandwidth:40MHz; Channel:Low

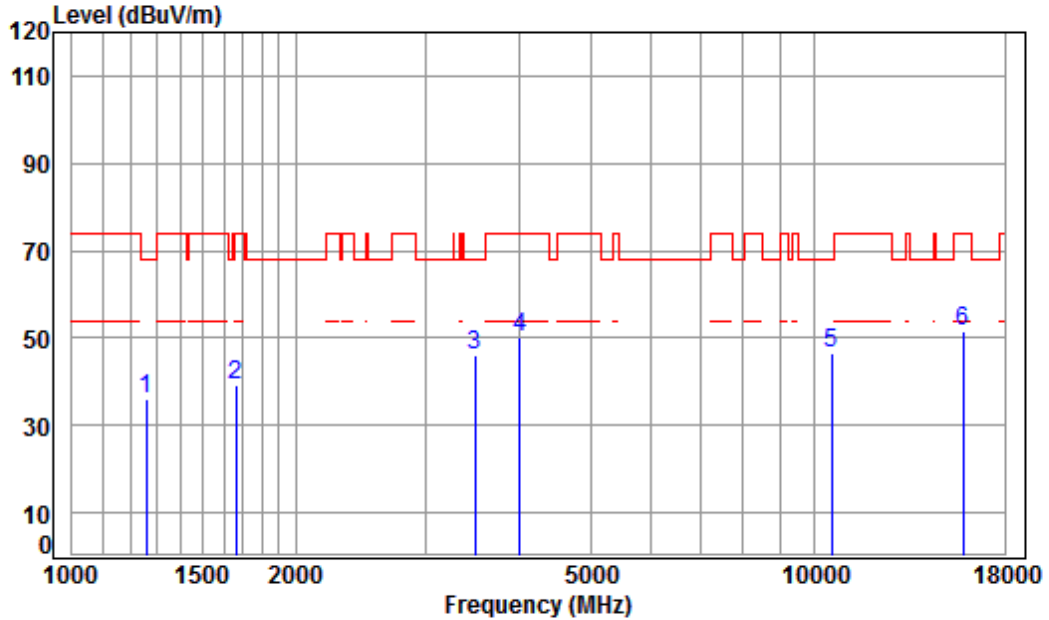

Condition: 3m VERTICAL
Job No : 04056CR/04057CR
Mode : 5270 TX RSE
Note : 5G WIFI 11AC40

	Cable	Ant	Preamp	Read	Limit	Over		
Freq	Loss	Factor	Factor	Level	Level	Line	Limit	Remark
MHz	dB	dB/m	dB	dBuV	dBuV/m	dBuV/m	dB	
1	1260.149	4.65	24.77	38.07	44.50	35.85	68.20	-32.35 peak
2	1663.137	5.27	26.52	38.03	45.29	39.05	74.00	-34.95 peak
3	3485.601	6.45	32.18	37.95	45.57	46.25	68.20	-21.95 peak
4	4004.339	6.99	33.60	38.00	47.55	50.14	74.00	-23.86 peak
5	pp10540.000	11.32	37.15	35.18	33.43	46.72	68.20	-21.48 peak
6	15810.000	14.71	41.28	38.00	33.59	51.58	74.00	-22.42 peak



Mode:f; Polarization:Horizontal; Modulation:802.11ac; bandwidth:40MHz; Channel:High

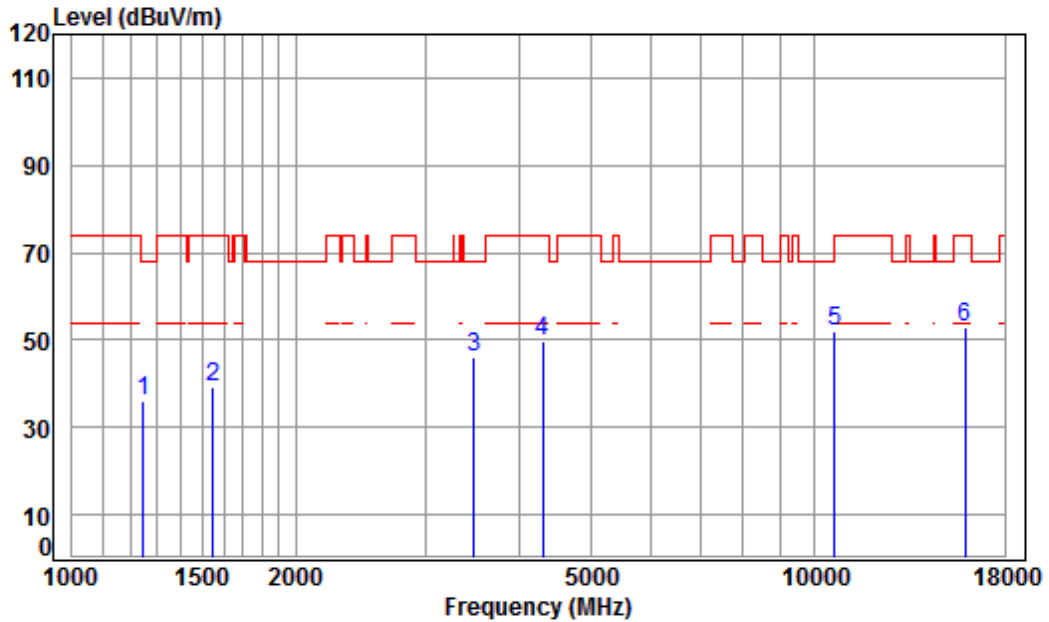

Condition: 3m HORIZONTAL
Job No : 04056CR/04057CR
Mode : 5310 TX RSE
Note : 5G WIFI 11AC40

	Freq	Cable Loss	Ant Factor	Preamp Factor	Read Level	Level	Limit	Over	Remark
	MHz	dB	dB/m	dB	dBuV	dBuV/m	dBuV/m	dB	
1	1249.269	4.61	24.72	38.07	44.71	35.97	68.20	-32.23	peak
2	1547.199	5.42	26.02	38.04	45.71	39.11	74.00	-34.89	peak
3	3475.541	6.44	32.16	37.95	45.50	46.15	68.20	-22.05	peak
4	4304.400	7.34	33.60	38.16	46.92	49.70	74.00	-24.30	peak
5	10620.000	11.37	37.25	35.22	38.73	52.13	74.00	-21.87	peak
6	pp15930.000	14.89	41.23	37.87	34.69	52.94	74.00	-21.06	peak



Mode:f; Polarization:Vertical; Modulation:802.11ac; bandwidth:40MHz; Channel:High

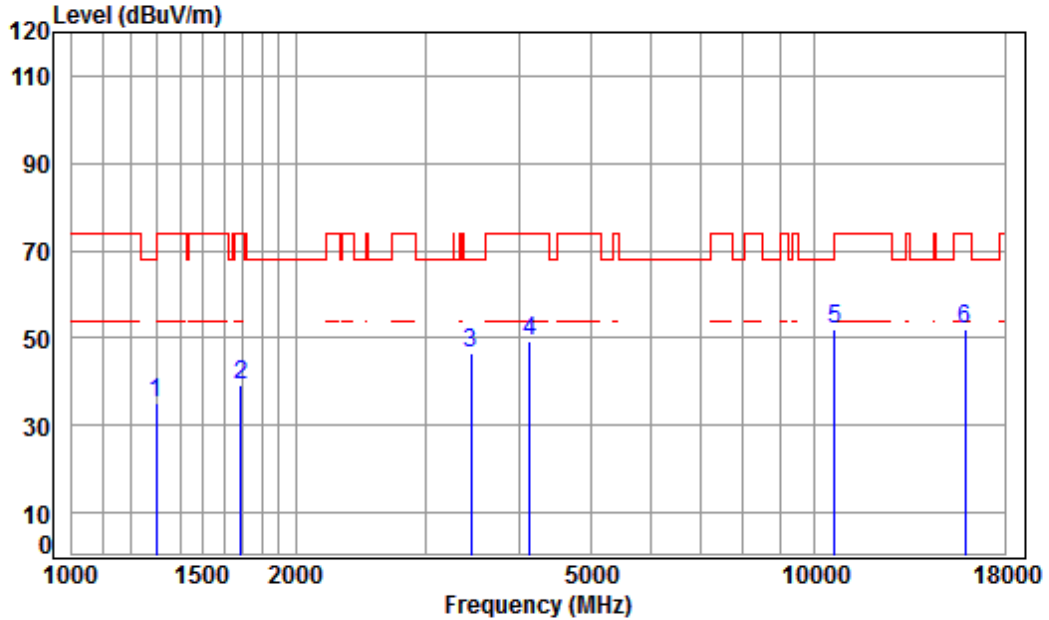

Condition: 3m VERTICAL
Job No : 04056CR/04057CR
Mode : 5310 TX RSE
Note : 5G WIFI 11AC40

	Freq	Cable Loss	Ant Factor	Preamp Factor	Read Level	Level	Limit	Over	Remark
	MHz	dB	dB/m	dB	dBuV	dBuV/m	dBuV/m	dB	
1	1300.858	4.80	24.96	38.06	43.64	35.34	74.00	-38.66	peak
2	1687.347	5.24	26.62	38.02	45.39	39.23	74.00	-34.77	peak
3	3445.535	6.41	32.11	37.95	45.77	46.34	68.20	-21.86	peak
4	4133.699	7.14	33.60	38.07	46.57	49.24	74.00	-24.76	peak
5	pp10620.000	11.37	37.25	35.22	38.74	52.14	74.00	-21.86	peak
6	15930.000	14.89	41.23	37.87	33.77	52.02	74.00	-21.98	peak



Mode:f; Polarization:Horizontal; Modulation:802.11ac; bandwidth:80MHz; Channel:middle

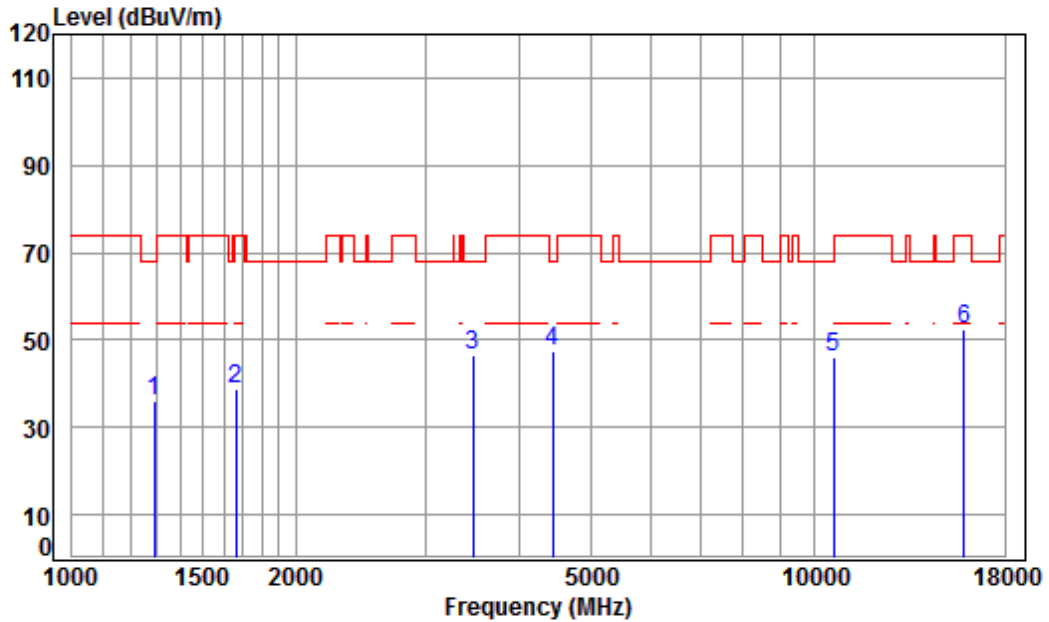

Condition: 3m HORIZONTAL
Job No : 04056CR/04057CR
Mode : 5290 TX RSE
Note : 5G WIFI 11AC80

	Cable	Ant	Preamp	Read	Limit	Over		
Freq	Loss	Factor	Factor	Level	Level	Line	Limit	Remark
MHz	dB	dB/m	dB	dBuV	dBuV/m	dBuV/m	dB	
1	1289.627	4.76	24.91	38.06	44.39	36.00	68.20	-32.20 peak
2	1663.137	5.27	26.52	38.03	44.92	38.68	74.00	-35.32 peak
3	3465.510	6.43	32.14	37.95	46.12	46.74	68.20	-21.46 peak
4	pp 4443.453	7.50	33.60	38.24	44.49	47.35	68.20	-20.85 peak
5	10580.000	11.35	37.20	35.20	32.91	46.26	68.20	-21.94 peak
6	15870.000	14.80	41.25	37.94	34.53	52.64	74.00	-21.36 peak



Mode:f; Polarization:Vertical; Modulation:802.11ac; bandwidth:80MHz; Channel:middle

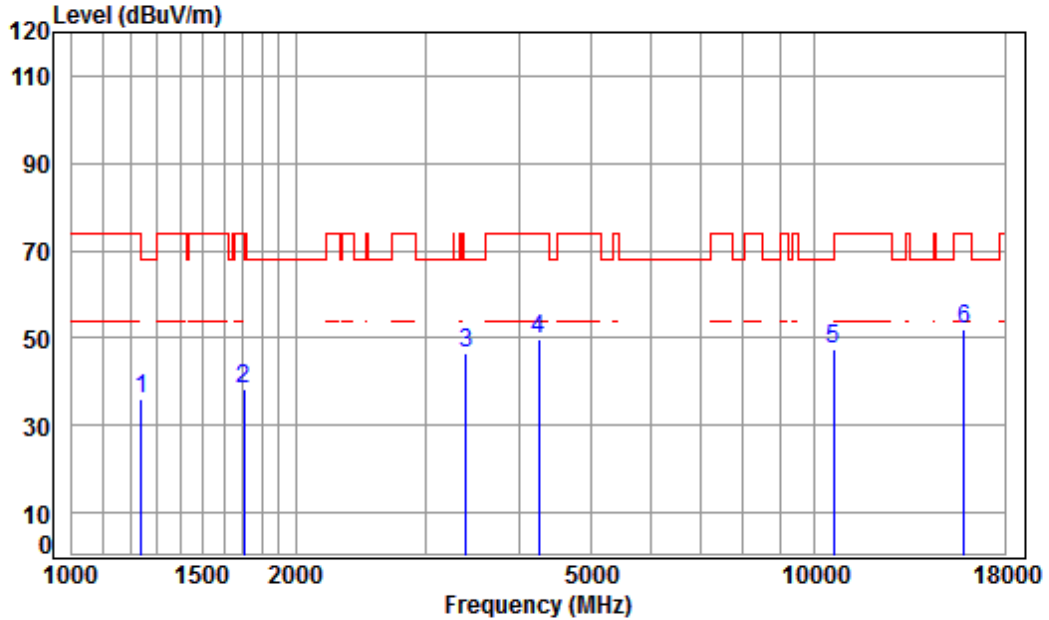

Condition: 3m VERTICAL
Job No : 04056CR/04057CR
Mode : 5290 TX RSE
Note : 5G WIFI 11AC80

	Freq	Cable Loss	Ant Factor	Preamp Factor	Read Level	Level	Limit	Over	Remark
	MHz	dB	dB/m	dB	dBuV	dBuV/m	dBuV/m	dB	
1	1242.068	4.58	24.68	38.07	44.90	36.09	68.20	-32.11	peak
2	1702.042	5.23	26.68	38.02	44.65	38.54	74.00	-35.46	peak
3	3396.098	6.37	32.02	37.94	46.11	46.56	68.20	-21.64	peak
4	4242.641	7.27	33.60	38.13	47.08	49.82	74.00	-24.18	peak
5	pp10580.000	11.35	37.20	35.20	34.18	47.53	68.20	-20.67	peak
6	15870.000	14.80	41.25	37.94	34.07	52.18	74.00	-21.82	peak



Mode:g; Polarization:Horizontal; Modulation:802.11a; bandwidth:20MHz; Channel:Low

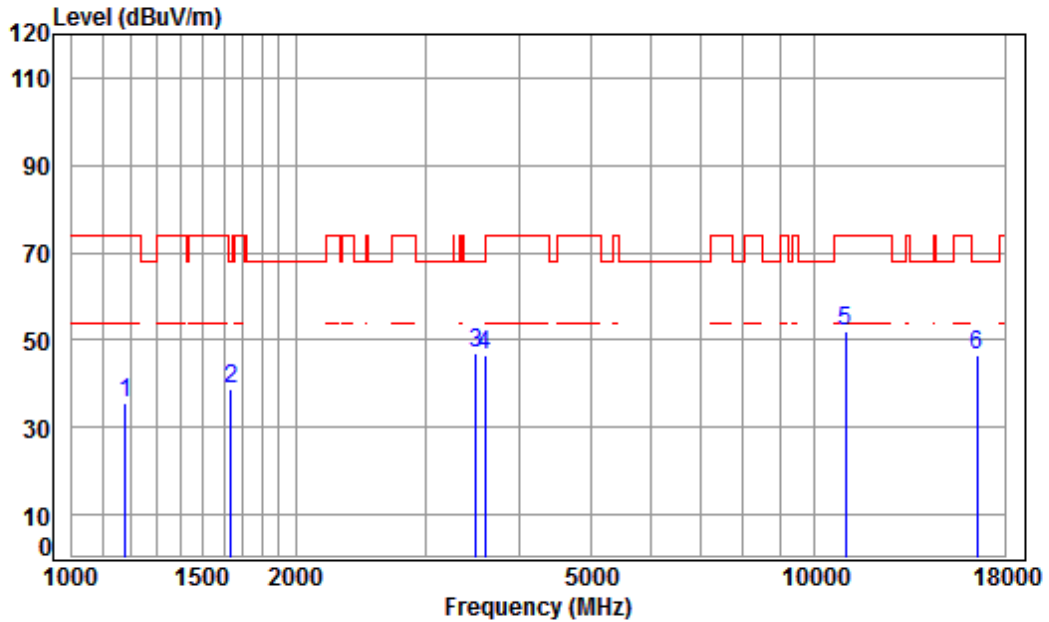

Condition: 3m HORIZONTAL
Job No : 04056CR/04057CR
Mode : 5500 TX RSE
Note : 5G WIFI 11A

	Freq	Cable Loss	Ant Factor	Preamp Factor	Read Level	Level	Limit	Over	Remark
	MHz	dB	dB/m	dB	dBuV	dBuV/m	dBuV/m	dB	
1	1179.100	4.33	24.38	38.08	44.93	35.56	74.00	-38.44	peak
2	1639.274	5.30	26.42	38.03	44.92	38.61	68.20	-29.59	peak
3 pp	3495.691	6.46	32.19	37.95	46.21	46.91	68.20	-21.29	peak
4	3598.203	6.57	32.49	37.96	45.22	46.32	68.20	-21.88	peak
5	11000.000	11.63	37.70	35.40	38.21	52.14	74.00	-21.86	peak
6	16500.000	14.50	42.70	37.04	26.29	46.45	68.20	-21.75	peak



Mode:g; Polarization:Vertical; Modulation:802.11a; bandwidth:20MHz; Channel:Low

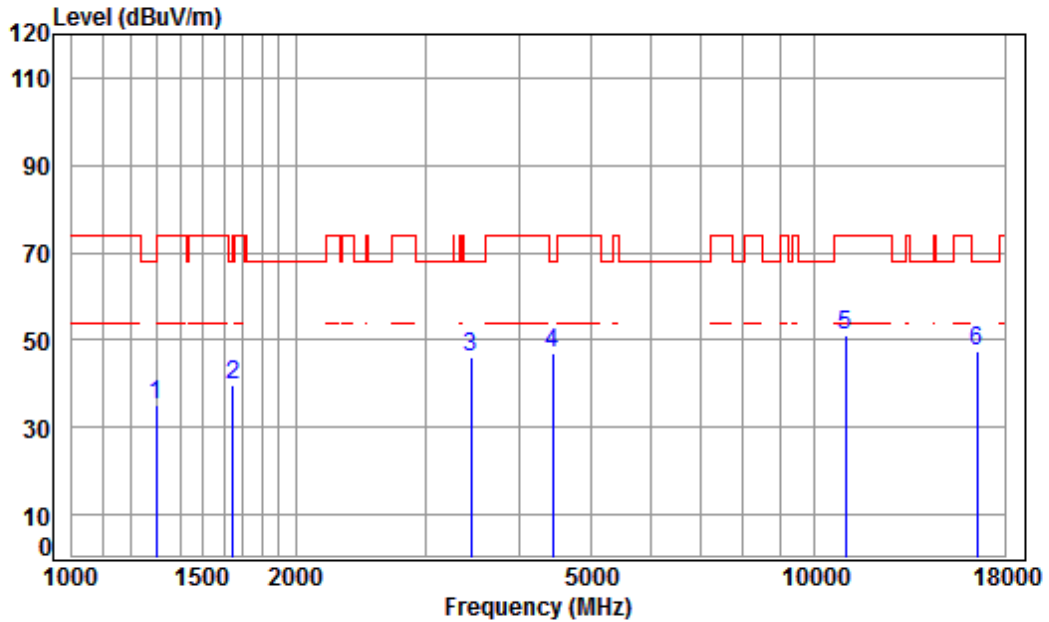

Condition: 3m VERTICAL
Job No : 04056CR/04057CR
Mode : 5500 TX RSE
Note : 5G WIFI 11A

	Cable	Ant	Preamp	Read	Limit	Over		
Freq	Loss	Factor	Factor	Level	Level	Line	Limit	Remark
MHz	dB	dB/m	dB	dBuV	dBuV/m	dBuV/m	dB	
1	1297.103	4.79	24.94	38.06	43.37	35.04	68.20	-33.16 peak
2	1648.778	5.29	26.46	38.03	45.93	39.65	68.20	-28.55 peak
3	3445.535	6.41	32.11	37.95	45.65	46.22	68.20	-21.98 peak
4	4443.453	7.50	33.60	38.24	44.32	47.18	68.20	-21.02 peak
5	11000.000	11.63	37.70	35.40	37.33	51.26	74.00	-22.74 peak
6	pp16500.000	14.50	42.70	37.04	27.14	47.30	68.20	-20.90 peak



Mode:g; Polarization:Horizontal; Modulation:802.11a; bandwidth:20MHz; Channel:middle

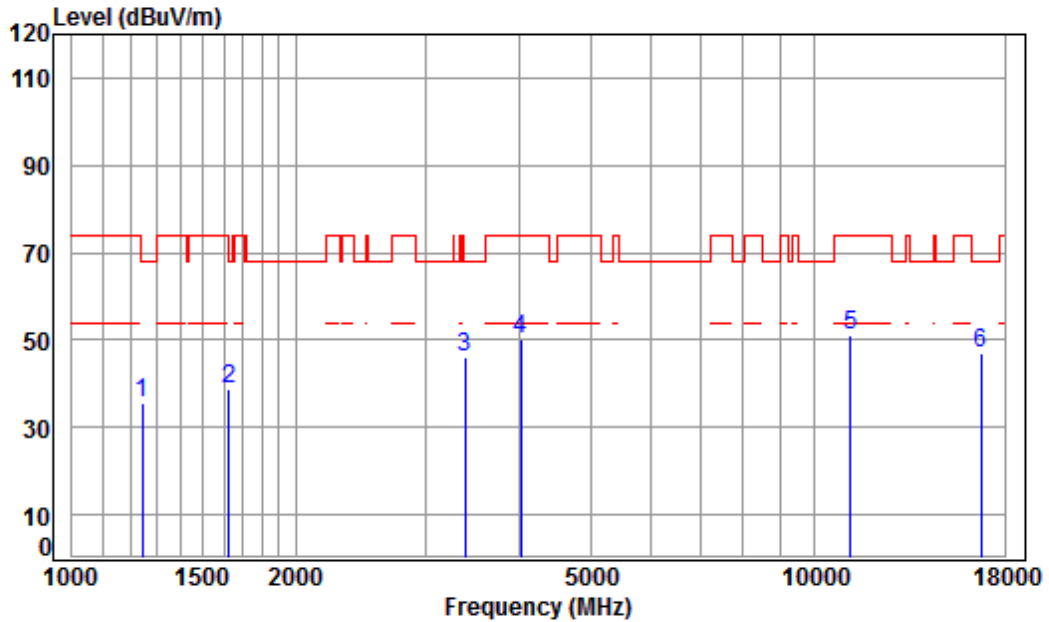

Condition: 3m HORIZONTAL
Job No : 04056CR/04057CR
Mode : 5580 TX RSE
Note : 5G WIFI 11A

	Cable	Ant	Preamp	Read	Limit	Over		
Freq	Loss	Factor	Factor	Level	Level	Line	Limit	Remark
MHz	dB	dB/m	dB	dBuV	dBuV/m	dBuV/m	dB	
1	1245.663	4.60	24.70	38.07	44.47	35.70	68.20	-32.50 peak
2	1625.121	5.32	26.36	38.03	44.92	38.57	74.00	-35.43 peak
3	3386.297	6.36	32.01	37.94	45.73	46.16	68.20	-22.04 peak
4	4015.929	7.00	33.60	38.01	47.75	50.34	74.00	-23.66 peak
5	11160.000	11.80	37.83	35.60	37.08	51.11	74.00	-22.89 peak
6	pp16740.000	15.57	42.75	36.68	25.43	47.07	68.20	-21.13 peak



Mode:g; Polarization:Vertical; Modulation:802.11a; bandwidth:20MHz; Channel:middle

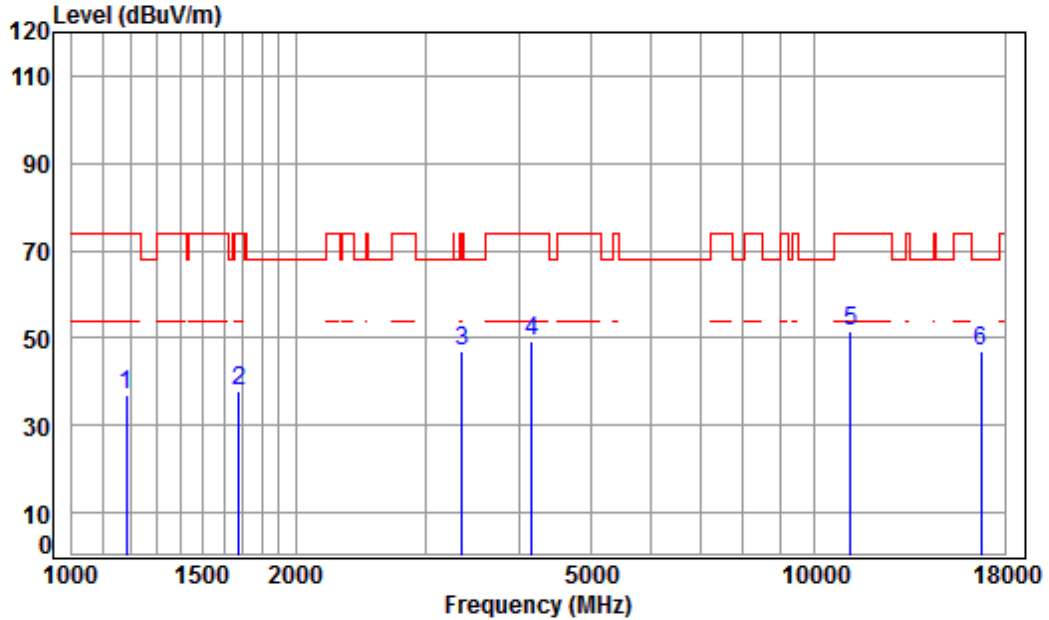

Condition: 3m VERTICAL
Job No : 04056CR/04057CR
Mode : 5580 TX RSE
Note : 5G WIFI 11A

	Freq	Cable Loss	Ant Factor	Preamp Factor	Read Level	Level	Limit	Over	Remark
	MHz	dB	dB/m	dB	dBuV	dBuV/m	dBuV/m	dB	
1	1185.936	4.36	24.41	38.08	46.06	36.75	74.00	-37.25	peak
2	1677.621	5.25	26.58	38.03	44.27	38.07	74.00	-35.93	peak
3	3347.371	6.32	31.94	37.94	46.49	46.81	74.00	-27.19	peak
4	4157.664	7.17	33.60	38.09	46.72	49.40	74.00	-24.60	peak
5	11160.000	11.80	37.83	35.60	37.52	51.55	74.00	-22.45	peak
6	pp16740.000	15.57	42.75	36.68	25.42	47.06	68.20	-21.14	peak



Mode:g; Polarization:Horizontal; Modulation:802.11a; bandwidth:20MHz; Channel:High

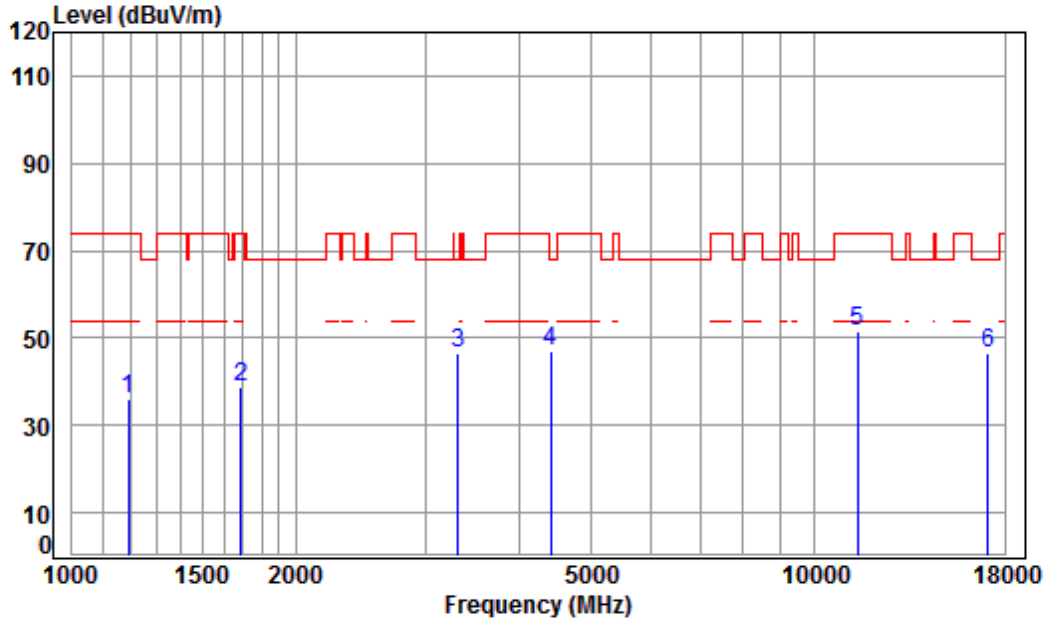

Condition: 3m HORIZONTAL
Job No : 04056CR/04057CR
Mode : 5700 TX RSE
Note : 5G WIFI 11A

	Cable	Ant	Preamp	Read	Limit	Over		
Freq	Loss	Factor	Factor	Level	Level	Line	Limit	Remark
MHz	dB	dB/m	dB	dBuV	dBuV/m	dBuV/m	dB	
1	1192.811	4.39	24.44	38.07	45.41	36.17	74.00	-37.83 peak
2	1687.347	5.24	26.62	38.02	44.94	38.78	74.00	-35.22 peak
3	3308.894	6.29	31.87	37.93	46.47	46.70	68.20	-21.50 peak
4	pp 4405.090	7.46	33.60	38.22	44.13	46.97	68.20	-21.23 peak
5	11400.000	12.04	38.02	35.89	37.35	51.52	74.00	-22.48 peak
6	17100.000	16.49	42.92	36.25	23.50	46.66	68.20	-21.54 peak



Mode:g; Polarization:Vertical; Modulation:802.11a; bandwidth:20MHz; Channel:High

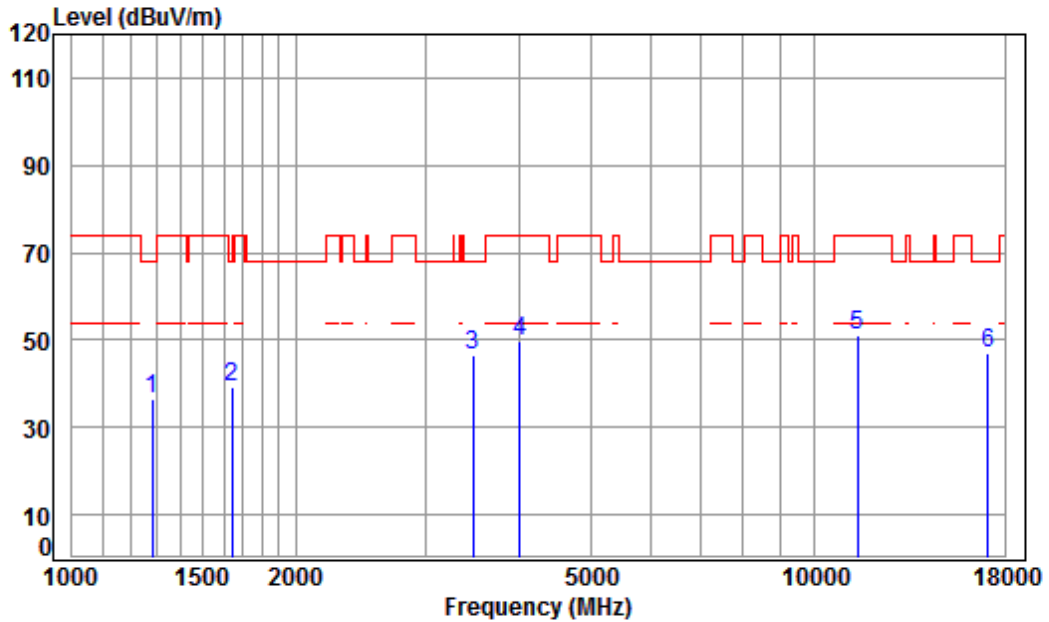

Condition: 3m VERTICAL
 Job No : 04056CR/04057CR
 Mode : 5700 TX RSE
 Note : 5G WIFI 11A

	Cable	Ant	Preamp	Read	Limit	Over		
Freq	Loss	Factor	Factor	Level	Level	Line	Limit	Remark
MHz	dB	dB/m	dB	dBuV	dBuV/m	dBuV/m	dB	
1	1282.193	4.73	24.87	38.06	45.04	36.58	68.20	-31.62 peak
2	1644.019	5.30	26.44	38.03	45.64	39.35	68.20	-28.85 peak
3	3465.510	6.43	32.14	37.95	46.03	46.65	68.20	-21.55 peak
4	4004.339	6.99	33.60	38.00	46.92	49.51	74.00	-24.49 peak
5	11400.000	12.04	38.02	35.89	37.00	51.17	74.00	-22.83 peak
6	pp17100.000	16.49	42.92	36.25	23.95	47.11	68.20	-21.09 peak



Mode:g; Polarization:Horizontal; Modulation:802.11n; bandwidth:20MHz; Channel:Low

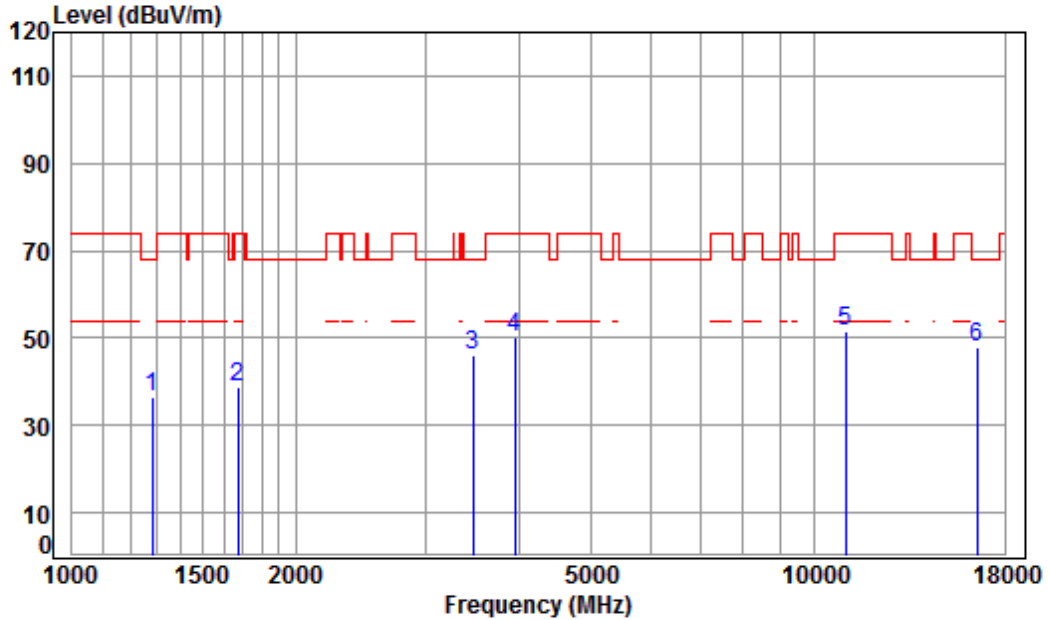

Condition: 3m HORIZONTAL
Job No : 04056CR/04057CR
Mode : 5500 TX RSE
Note : 5G WIFI 11N20

	Freq	Cable Loss	Ant Factor	Preamp Factor	Read Level	Limit Level	Limit Line	Over Limit	Remark
	MHz	dB	dB/m	dB	dBuV	dBuV/m	dBuV/m	dB	
1	1282.193	4.73	24.87	38.06	45.19	36.73	68.20	-31.47	peak
2	1672.779	5.26	26.56	38.03	45.09	38.88	74.00	-35.12	peak
3	3465.510	6.43	32.14	37.95	45.53	46.15	68.20	-22.05	peak
4	3946.885	6.93	33.46	38.00	48.01	50.40	74.00	-23.60	peak
5	11000.000	11.63	37.70	35.40	37.44	51.37	74.00	-22.63	peak
6	pp16500.000	14.50	42.70	37.04	27.58	47.74	68.20	-20.46	peak



Mode:g; Polarization:Vertical; Modulation:802.11n; bandwidth:20MHz; Channel:Low

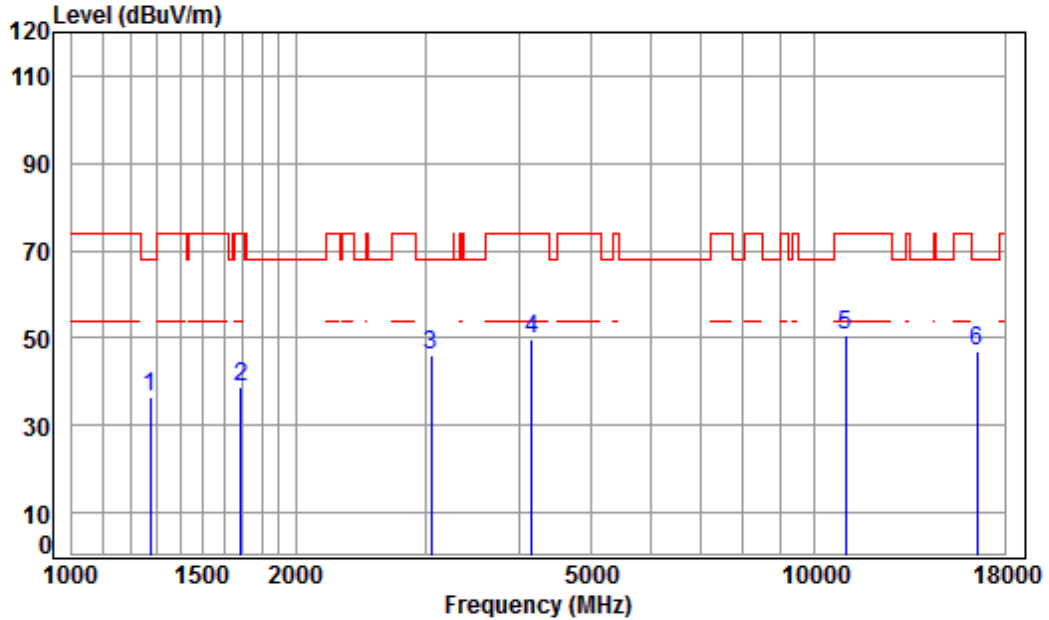

Condition: 3m HORIZONTAL
Job No : 04056CR/04057CR
Mode : 5500 TX RSE
Note : 5G WIFI 11N20

	Freq	Cable Loss	Ant Factor	Preamp Factor	Read Level	Level	Limit	Over	Remark
	MHz	dB	dB/m	dB	dBuV	dBuV/m	dBuV/m	dB	
1	1274.802	4.71	24.84	38.06	45.11	36.60	68.20	-31.60	peak
2	1687.347	5.24	26.62	38.02	45.15	38.99	74.00	-35.01	peak
3	3042.846	6.02	31.38	37.90	46.74	46.24	68.20	-21.96	peak
4	4157.664	7.17	33.60	38.09	47.16	49.84	74.00	-24.16	peak
5	11000.000	11.63	37.70	35.40	36.85	50.78	74.00	-23.22	peak
6	pp16500.000	14.50	42.70	37.04	26.77	46.93	68.20	-21.27	peak



Mode:g; Polarization:Horizontal; Modulation:802.11n; bandwidth:20MHz; Channel:middle

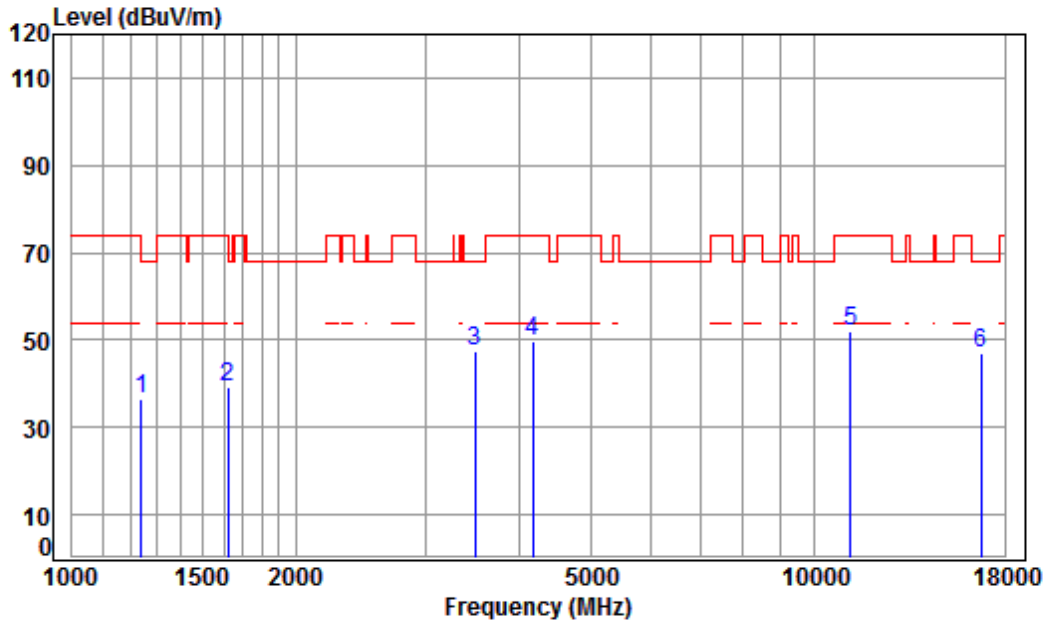

Condition: 3m VERTICAL
Job No : 04056CR/04057CR
Mode : 5580 TX RSE
Note : 5G WIFI 11N20

	Freq	Cable Loss	Ant Factor	Preamp Factor	Read Level	Level	Limit	Over	Remark
	MHz	dB	dB/m	dB	dBuV	dBuV/m	dBuV/m	dB	
1	1238.483	4.57	24.67	38.07	45.50	36.67	74.00	-37.33	peak
2	1620.431	5.32	26.34	38.03	45.45	39.08	74.00	-34.92	peak
3	pp 3485.601	6.45	32.18	37.95	46.76	47.44	68.20	-20.76	peak
4	4169.698	7.18	33.60	38.09	47.07	49.76	74.00	-24.24	peak
5	11160.000	11.80	37.83	35.60	37.88	51.91	74.00	-22.09	peak
6	16740.000	15.57	42.75	36.68	25.22	46.86	68.20	-21.34	peak



Mode:g; Polarization:Vertical; Modulation:802.11n; bandwidth:20MHz; Channel:middle

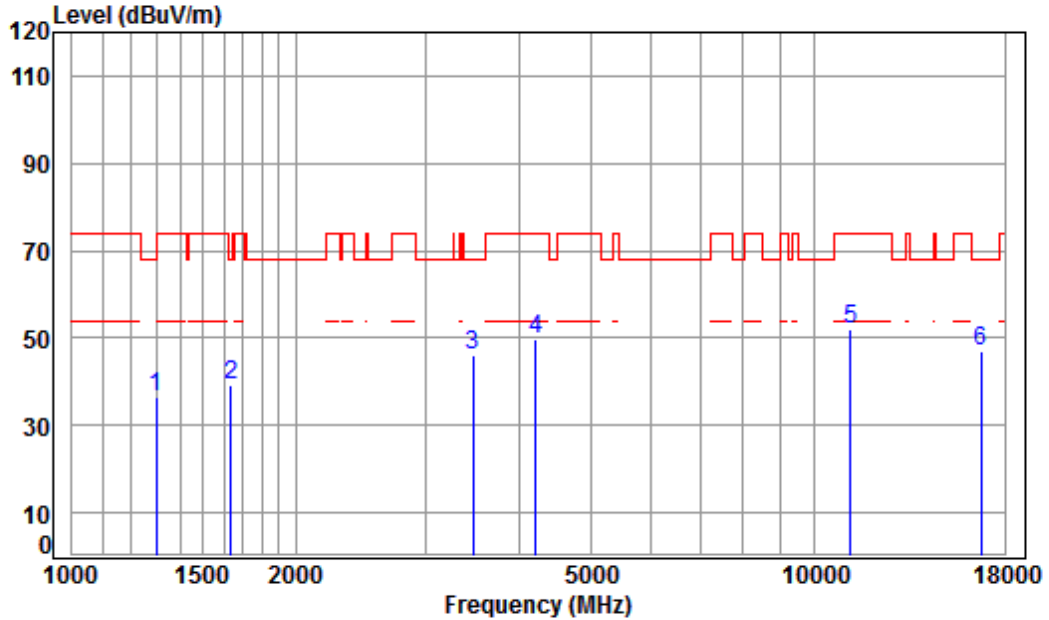

Condition: 3m HORIZONTAL
Job No : 04056CR/04057CR
Mode : 5580 TX RSE
Note : 5G WIFI 11N20

	Freq	Cable Loss	Ant Factor	Preamp Factor	Read Level	Level	Limit	Over	Remark
	MHz	dB	dB/m	dB	dBuV	dBuV/m	dBuV/m	dB	
1	1300.858	4.80	24.96	38.06	44.81	36.51	74.00	-37.49	peak
2	1639.274	5.30	26.42	38.03	45.55	39.24	68.20	-28.96	peak
3	3465.510	6.43	32.14	37.95	45.45	46.07	68.20	-22.13	peak
4	4206.011	7.23	33.60	38.11	47.19	49.91	74.00	-24.09	peak
5	11160.000	11.80	37.83	35.60	37.90	51.93	74.00	-22.07	peak
6	pp16740.000	15.57	42.75	36.68	25.22	46.86	68.20	-21.34	peak



Mode:g; Polarization:Horizontal; Modulation:802.11n; bandwidth:20MHz; Channel:High

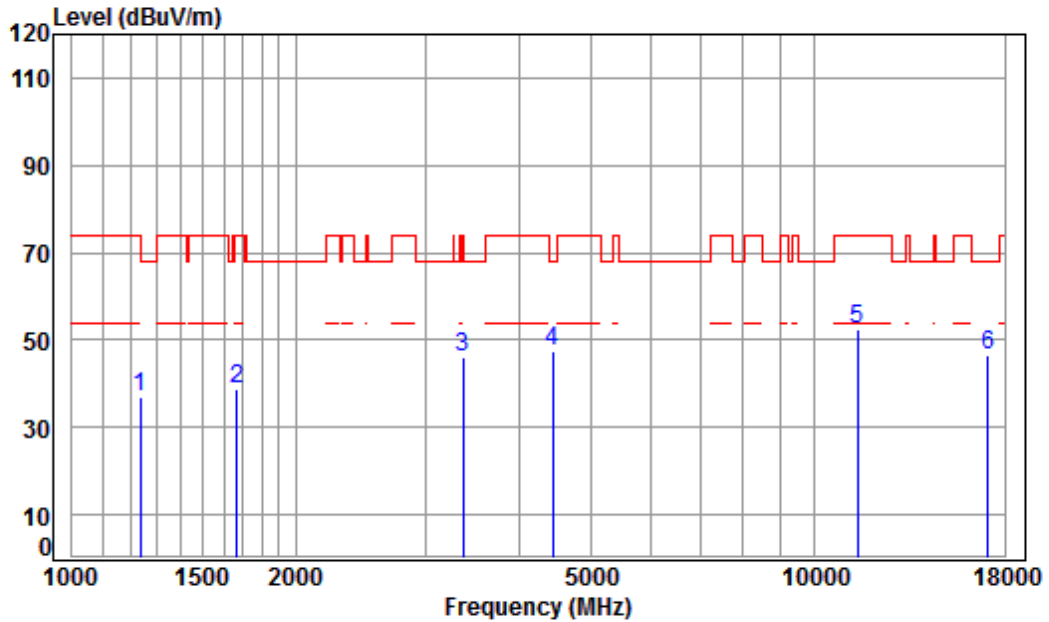

Condition: 3m HORIZONTAL
Job No : 04056CR/04057CR
Mode : 5700 TX RSE
Note : 5G WIFI 11N20

	Freq	Cable Loss	Ant Factor	Preamp Factor	Read Level	Level	Limit	Over	Remark
	MHz	dB	dB/m	dB	dBuV	dBuV/m	dBuV/m	dB	
1	1234.909	4.55	24.65	38.07	45.63	36.76	74.00	-37.24	peak
2	1667.951	5.27	26.54	38.03	44.94	38.72	74.00	-35.28	peak
3	3357.061	6.33	31.96	37.94	45.95	46.30	74.00	-27.70	peak
4	pp 4430.628	7.48	33.60	38.23	44.46	47.31	68.20	-20.89	peak
5	11400.000	12.04	38.02	35.89	38.11	52.28	74.00	-21.72	peak
6	17100.000	16.49	42.92	36.25	23.26	46.42	68.20	-21.78	peak



Mode:g; Polarization:Vertical; Modulation:802.11n; bandwidth:20MHz; Channel:High

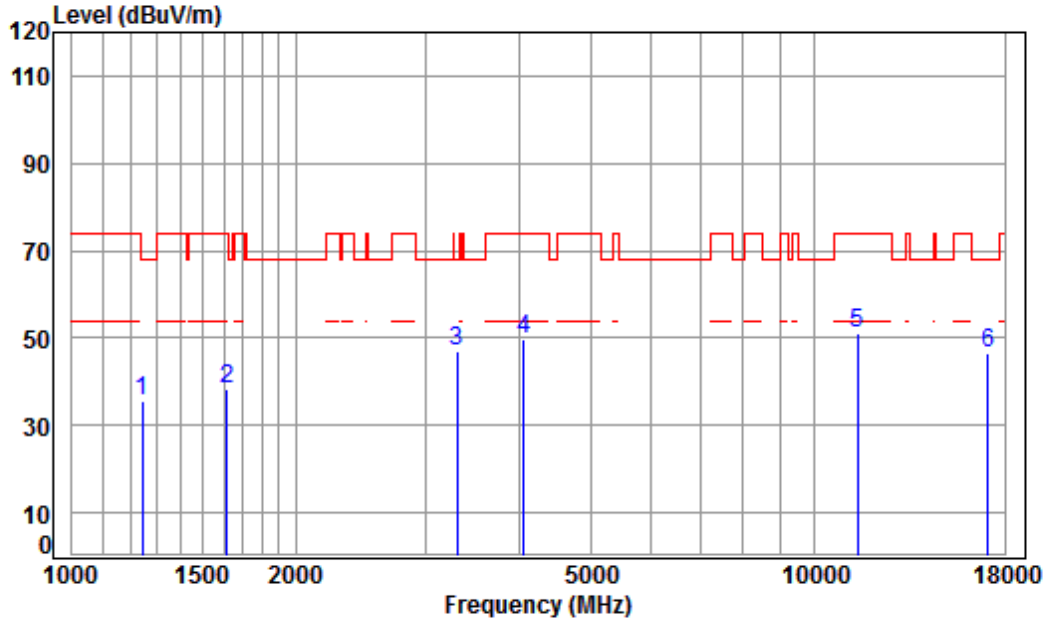

Condition: 3m VERTICAL
Job No : 04056CR/04057CR
Mode : 5700 TX RSE
Note : 5G WIFI 11N20

	Freq	Cable Loss	Ant Factor	Preamp Factor	Read Level	Level	Limit	Over	Remark
	MHz	dB	dB/m	dB	dBuV	dBuV/m	dBuV/m	dB	
1	1245.663	4.60	24.70	38.07	44.56	35.79	68.20	-32.41	peak
2	1615.754	5.33	26.32	38.03	44.81	38.43	74.00	-35.57	peak
3	pp 3299.344	6.28	31.86	37.93	46.88	47.09	68.20	-21.11	peak
4	4062.629	7.06	33.60	38.03	46.88	49.51	74.00	-24.49	peak
5	11400.000	12.04	38.02	35.89	37.05	51.22	74.00	-22.78	peak
6	17100.000	16.49	42.92	36.25	23.58	46.74	68.20	-21.46	peak



Mode:g; Polarization:Horizontal; Modulation:802.11n; bandwidth:40MHz; Channel:Low

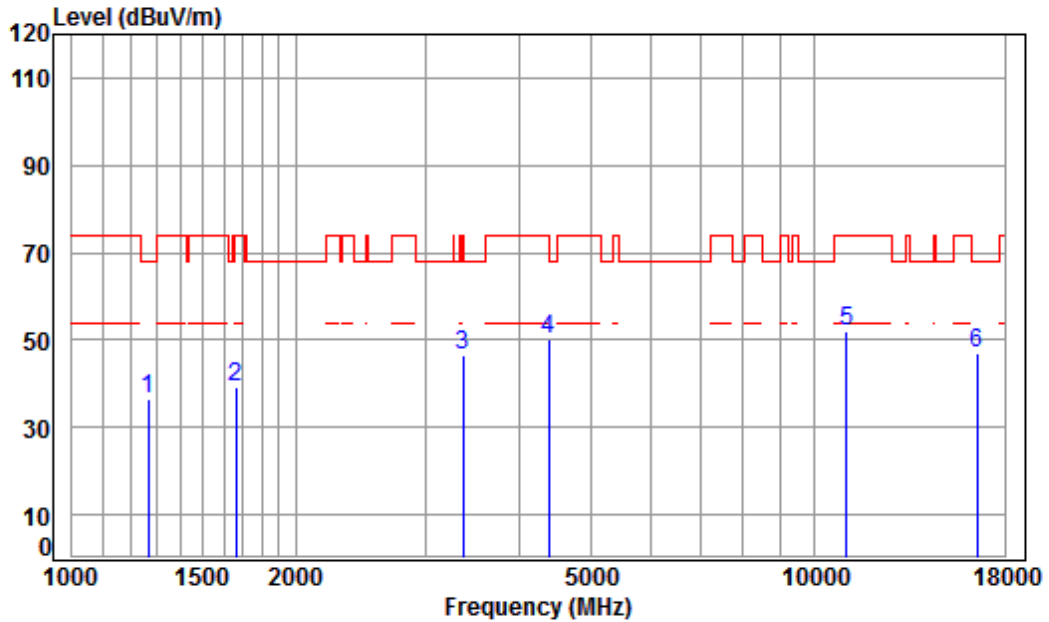

Condition: 3m HORIZONTAL
Job No : 04056CR/04057CR
Mode : 5510 TX RSE
Note : 5G WIFI 11N40

	Freq	Cable Loss	Ant Factor	Preamp Factor	Read Level	Limit Level	Limit Line	Over Limit	Remark
	MHz	dB	dB/m	dB	dBuV	dBuV/m	dBuV/m	dB	
1	1267.454	4.68	24.80	38.07	44.96	36.37	68.20	-31.83	peak
2	1663.137	5.27	26.52	38.03	45.54	39.30	74.00	-34.70	peak
3	3357.061	6.33	31.96	37.94	46.12	46.47	74.00	-27.53	peak
4	4379.699	7.43	33.60	38.20	47.36	50.19	74.00	-23.81	peak
5	11020.000	11.65	37.72	35.43	38.02	51.96	74.00	-22.04	peak
6	pp16530.000	14.63	42.71	36.99	26.85	47.20	68.20	-21.00	peak



Mode:g; Polarization:Vertical; Modulation:802.11n; bandwidth:40MHz; Channel:Low

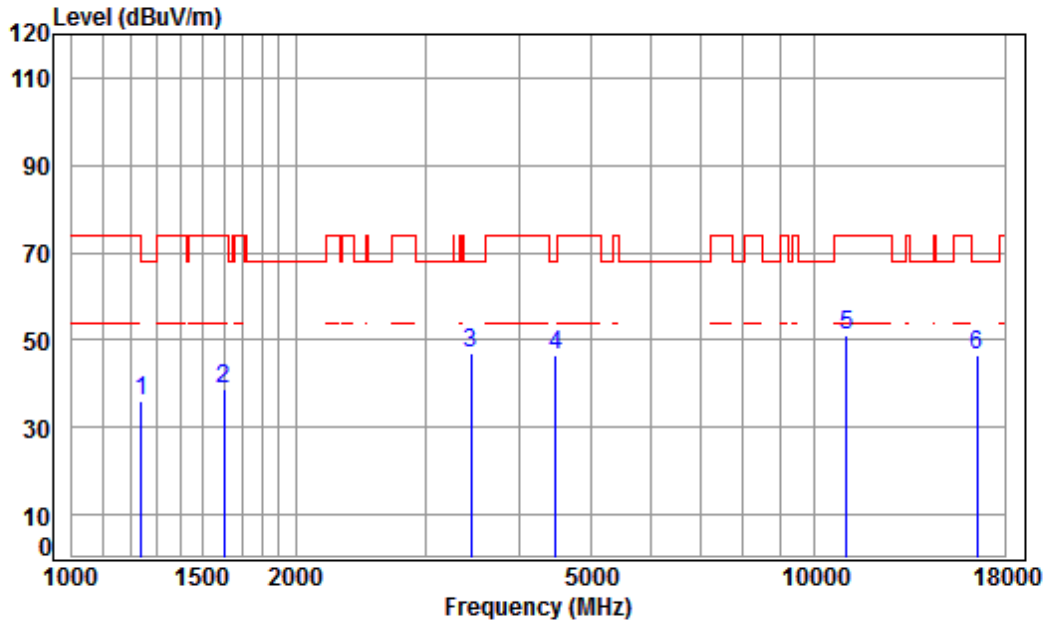

Condition: 3m VERTICAL
Job No : 04056CR/04057CR
Mode : 5510 TX RSE
Note : 5G WIFI 11N40

	Freq	Cable Loss	Ant Factor	Preamp Factor	Read Level	Limit Level	Over Line	Remark
	MHz	dB	dB/m	dB	dBuV	dBuV/m	dBuV/m	dB
1	1238.483	4.57	24.67	38.07	44.86	36.03	74.00	-37.97 peak
2	1601.804	5.35	26.26	38.03	45.17	38.75	74.00	-35.25 peak
3	pp 3445.535	6.41	32.11	37.95	46.30	46.87	68.20	-21.33 peak
4	4482.150	7.54	33.60	38.26	43.73	46.61	68.20	-21.59 peak
5	11020.000	11.65	37.72	35.43	37.24	51.18	74.00	-22.82 peak
6	16530.000	14.63	42.71	36.99	26.22	46.57	68.20	-21.63 peak



Mode:g; Polarization:Horizontal; Modulation:802.11n; bandwidth:40MHz; Channel:middle

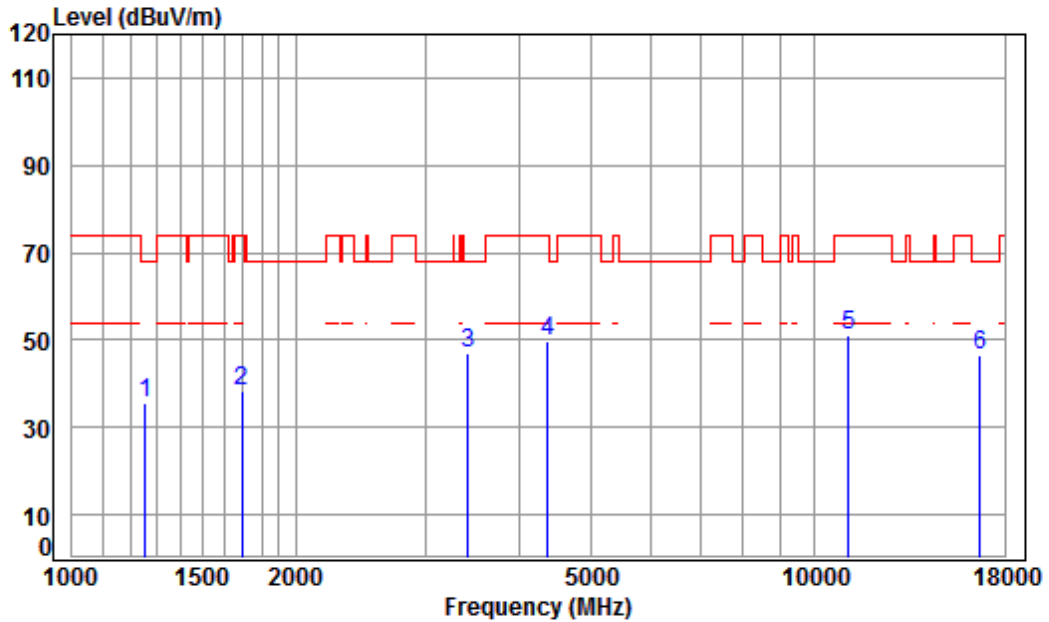

Condition: 3m HORIZONTAL
Job No : 04056CR/04057CR
Mode : 5550 TX RSE
Note : 5G WIFI 11N40

	Freq	Cable Loss	Ant Factor	Preamp Factor	Read Level	Limit Level	Limit Line	Over Limit	Remark
	MHz	dB	dB/m	dB	dBuV	dBuV/m	dBuV/m	dB	
1	1256.512	4.64	24.75	38.07	44.11	35.43	68.20	-32.77	peak
2	1692.231	5.24	26.64	38.02	44.68	38.54	74.00	-35.46	peak
3	pp 3415.787	6.38	32.06	37.95	46.41	46.90	68.20	-21.30	peak
4	4367.058	7.41	33.60	38.20	46.90	49.71	74.00	-24.29	peak
5	11100.000	11.73	37.78	35.52	37.16	51.15	74.00	-22.85	peak
6	16650.000	15.17	42.73	36.81	25.66	46.75	68.20	-21.45	peak



Mode:g; Polarization:Vertical; Modulation:802.11n; bandwidth:40MHz; Channel:middle

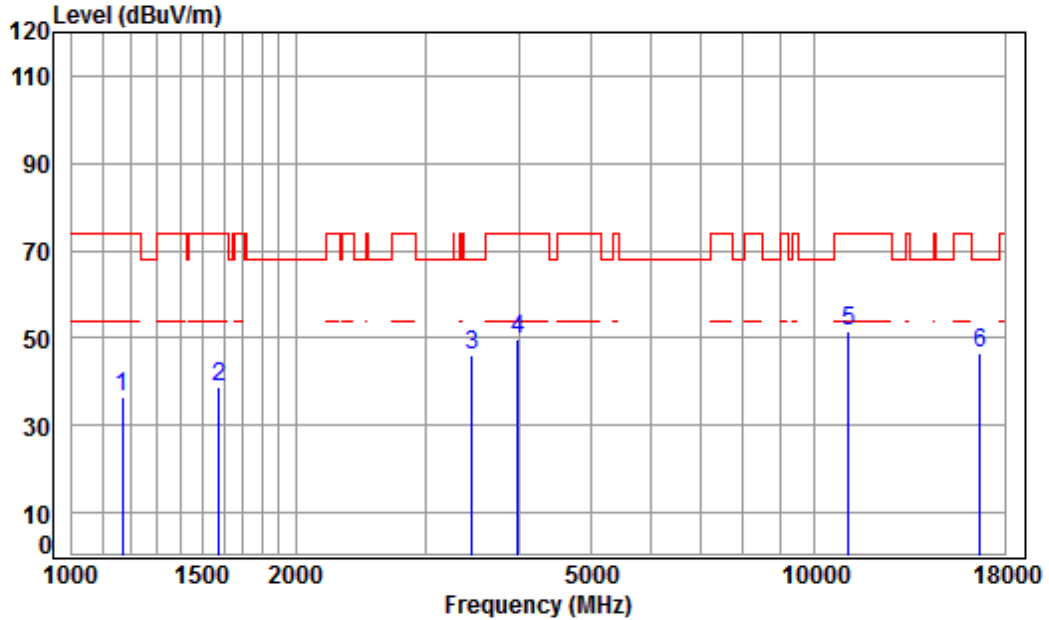

Condition: 3m VERTICAL
Job No : 04056CR/04057CR
Mode : 5550 TX RSE
Note : 5G WIFI 11N40

	Freq	Cable Loss	Ant Factor	Preamp Factor	Read Level	Level	Limit	Over	Remark
	MHz	dB	dB/m	dB	dBuV	dBuV/m	dBuV/m	dB	
1	1168.920	4.29	24.32	38.08	45.80	36.33	74.00	-37.67	peak
2	1578.822	5.38	26.16	38.03	45.48	38.99	74.00	-35.01	peak
3	3455.508	6.42	32.13	37.95	45.61	46.21	68.20	-21.99	peak
4	3981.257	6.96	33.55	38.00	47.41	49.92	74.00	-24.08	peak
5	11100.000	11.73	37.78	35.52	37.64	51.63	74.00	-22.37	peak
6	pp16650.000	15.17	42.73	36.81	25.65	46.74	68.20	-21.46	peak



Mode:g; Polarization:Horizontal; Modulation:802.11n; bandwidth:40MHz; Channel:High

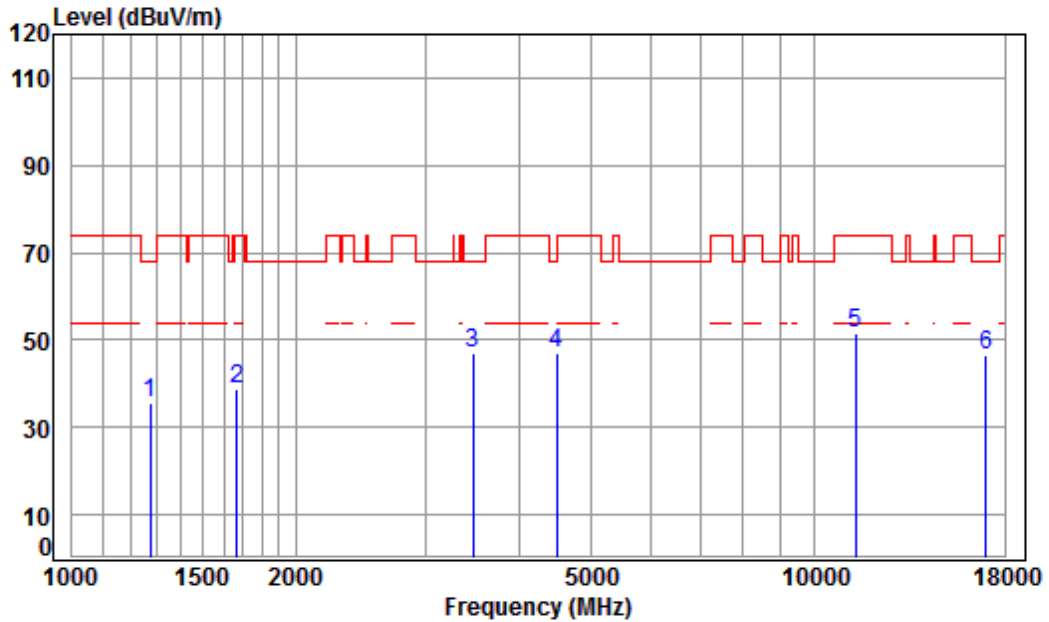

Condition: 3m HORIZONTAL
Job No : 04056CR/04057CR
Mode : 5670 TX RSE
Note : 5G WIFI 11N40

	Freq	Cable Loss	Ant Factor	Preamp Factor	Read Level	Limit Level	Limit Line	Over Limit	Remark
	MHz	dB	dB/m	dB	dBuV	dBuV/m	dBuV/m	dB	
1	1274.802	4.71	24.84	38.06	44.06	35.55	68.20	-32.65	peak
2	1667.951	5.27	26.54	38.03	44.92	38.70	74.00	-35.30	peak
3	3465.510	6.43	32.14	37.95	46.24	46.86	68.20	-21.34	peak
4	pp 4495.125	7.55	33.60	38.26	44.07	46.96	68.20	-21.24	peak
5	11340.000	11.98	37.97	35.82	37.31	51.44	74.00	-22.56	peak
6	17010.000	16.69	42.81	36.29	23.45	46.66	68.20	-21.54	peak



Mode:g; Polarization:Vertical; Modulation:802.11n; bandwidth:40MHz; Channel:High

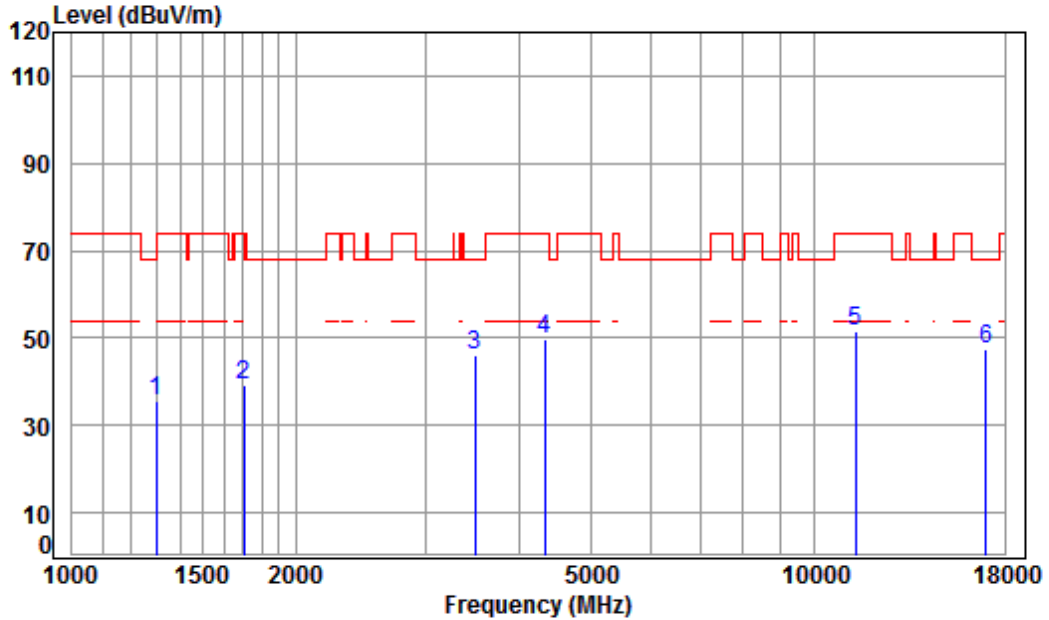

Condition: 3m VERTICAL
Job No : 04056CR/04057CR
Mode : 5670 TX RSE
Note : 5G WIFI 11N40

	Freq	Cable Loss	Ant Factor	Preamp Factor	Read Level	Limit Level	Over Limit	Remark
	MHz	dB	dB/m	dB	dBuV	dBuV/m	dBuV/m	dB
1	1297.103	4.79	24.94	38.06	43.98	35.65	68.20	-32.55 peak
2	1702.042	5.23	26.68	38.02	45.23	39.12	74.00	-34.88 peak
3	3485.601	6.45	32.18	37.95	45.58	46.26	68.20	-21.94 peak
4	4329.354	7.37	33.60	38.18	46.87	49.66	74.00	-24.34 peak
5	11340.000	11.98	37.97	35.82	37.28	51.41	74.00	-22.59 peak
6	pp17010.000	16.69	42.81	36.29	24.29	47.50	68.20	-20.70 peak



Mode:g; Polarization:Horizontal; Modulation:802.11ac; bandwidth:20MHz; Channel:Low

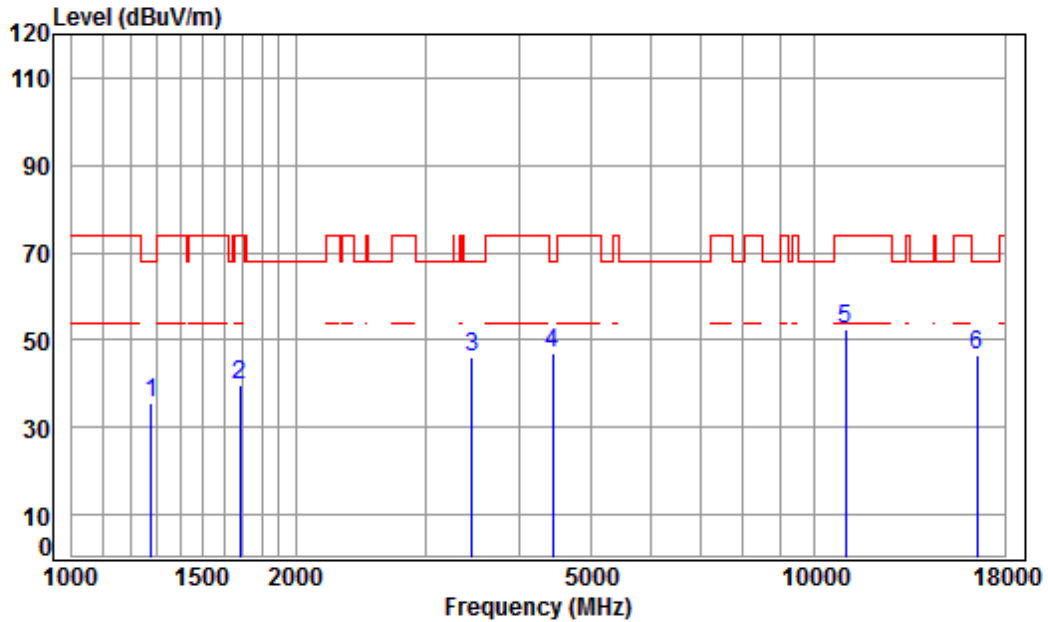

Condition: 3m HORIZONTAL
Job No : 04056CR/04057CR
Mode : 5500 TX RSE
Note : 5G WIFI 11AC20

	Freq	Cable Loss	Ant Factor	Preamp Factor	Read Level	Limit Level	Over Limit	Remark
	MHz	dB	dB/m	dB	dBuV	dBuV/m	dB	
1	1278.492	4.72	24.85	38.06	44.01	68.20	-32.68	peak
2	1682.477	5.25	26.60	38.02	45.83	74.00	-34.34	peak
3	3455.508	6.42	32.13	37.95	45.52	68.20	-22.08	peak
4	pp 4430.628	7.48	33.60	38.23	44.30	68.20	-21.05	peak
5	11000.000	11.63	37.70	35.40	38.51	74.00	-21.56	peak
6	16500.000	14.50	42.70	37.04	26.31	68.20	-21.73	peak



Mode:g; Polarization:Vertical; Modulation:802.11ac; bandwidth:20MHz; Channel:Low

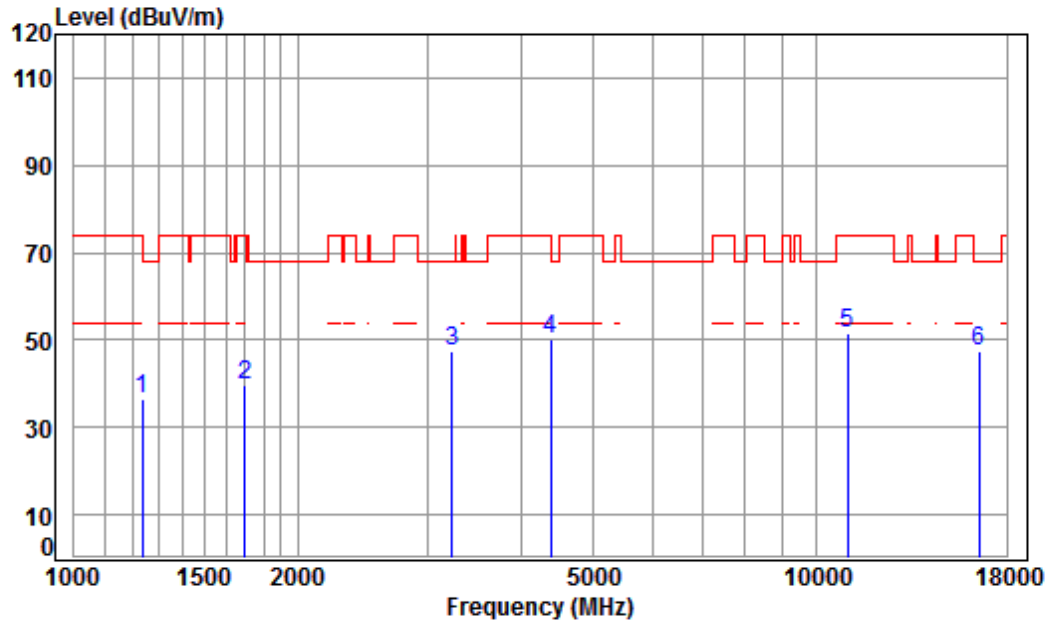

Condition: 3m VERTICAL
Job No : 04056CR/04057CR
Mode : 5500 TX RSE
Note : 5G WIFI 11AC20

	Freq	Cable Loss	Ant Factor	Preamp Factor	Read Level	Level	Limit	Over	Remark
	MHz	dB	dB/m	dB	dBuV	dBuV/m	dBuV/m	dB	
1	1234.909	4.55	24.65	38.07	45.21	36.34	74.00	-37.66	peak
2	1697.129	5.23	26.66	38.02	45.60	39.47	74.00	-34.53	peak
3 pp	3233.260	6.21	31.74	37.93	47.44	47.46	68.20	-20.74	peak
4	4379.699	7.43	33.60	38.20	47.18	50.01	74.00	-23.99	peak
5	11000.000	11.63	37.70	35.40	37.50	51.43	74.00	-22.57	peak
6	16500.000	14.50	42.70	37.04	27.20	47.36	68.20	-20.84	peak



Mode:g; Polarization:Horizontal; Modulation:802.11ac; bandwidth:20MHz; Channel:middle

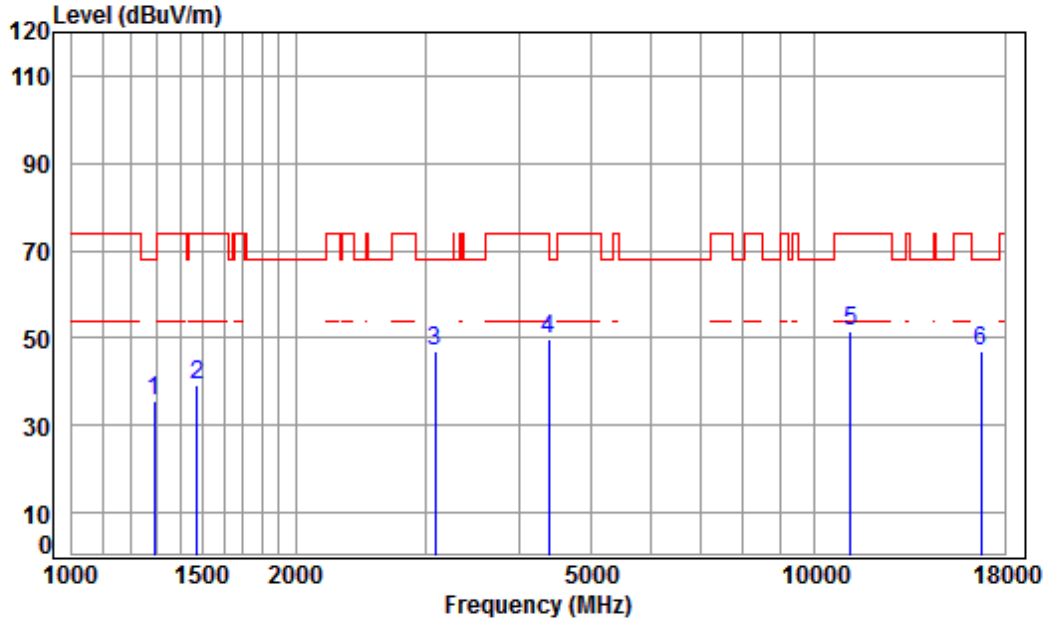

Condition: 3m HORIZONTAL
Job No : 04056CR/04057CR
Mode : 5580 TX RSE
Note : 5G WIFI 11AC20

	Freq	Cable Loss	Ant Factor	Preamp Factor	Read Level	Level	Limit	Over	Remark
	MHz	dB	dB/m	dB	dBuV	dBuV/m	dBuV/m	dB	
1	1289.627	4.76	24.91	38.06	44.20	35.81	68.20	-32.39	peak
2	1473.013	5.39	25.69	38.04	46.37	39.41	74.00	-34.59	peak
3	3078.229	6.06	31.45	37.91	47.48	47.08	68.20	-21.12	peak
4	4379.699	7.43	33.60	38.20	47.01	49.84	74.00	-24.16	peak
5	11160.000	11.80	37.83	35.60	37.69	51.72	74.00	-22.28	peak
6	pp16740.000	15.57	42.75	36.68	25.55	47.19	68.20	-21.01	peak



Mode:g; Polarization:Vertical; Modulation:802.11ac; bandwidth:20MHz; Channel:middle

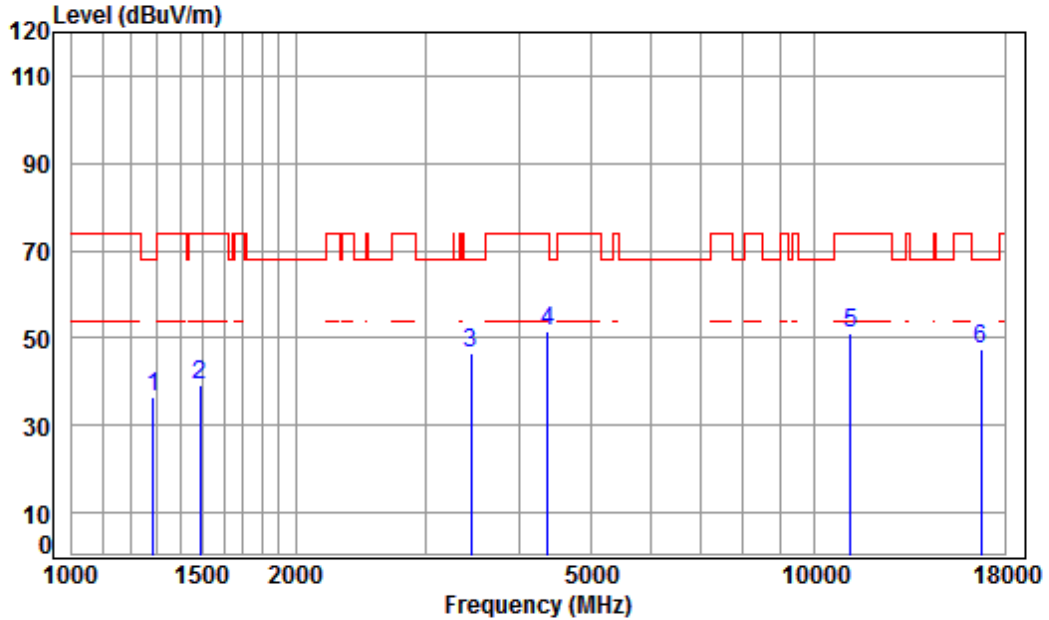

Condition: 3m VERTICAL
Job No : 04056CR/04057CR
Mode : 5580 TX RSE
Note : 5G WIFI 11AC20

	Freq	Cable Loss	Ant Factor	Preamp Factor	Read Level	Level	Limit	Over	Remark
	MHz	dB	dB/m	dB	dBuV	dBuV/m	dBuV/m	dB	
1	1285.904	4.75	24.89	38.06	44.80	36.38	68.20	-31.82	peak
2	1490.142	5.45	25.76	38.04	45.86	39.03	74.00	-34.97	peak
3	3445.535	6.41	32.11	37.95	45.91	46.48	68.20	-21.72	peak
4	4367.058	7.41	33.60	38.20	48.62	51.43	74.00	-22.57	peak
5	11160.000	11.80	37.83	35.60	37.19	51.22	74.00	-22.78	peak
6	pp16740.000	15.57	42.75	36.68	25.98	47.62	68.20	-20.58	peak



Mode:g; Polarization:Horizontal; Modulation:802.11ac; bandwidth:20MHz; Channel:High

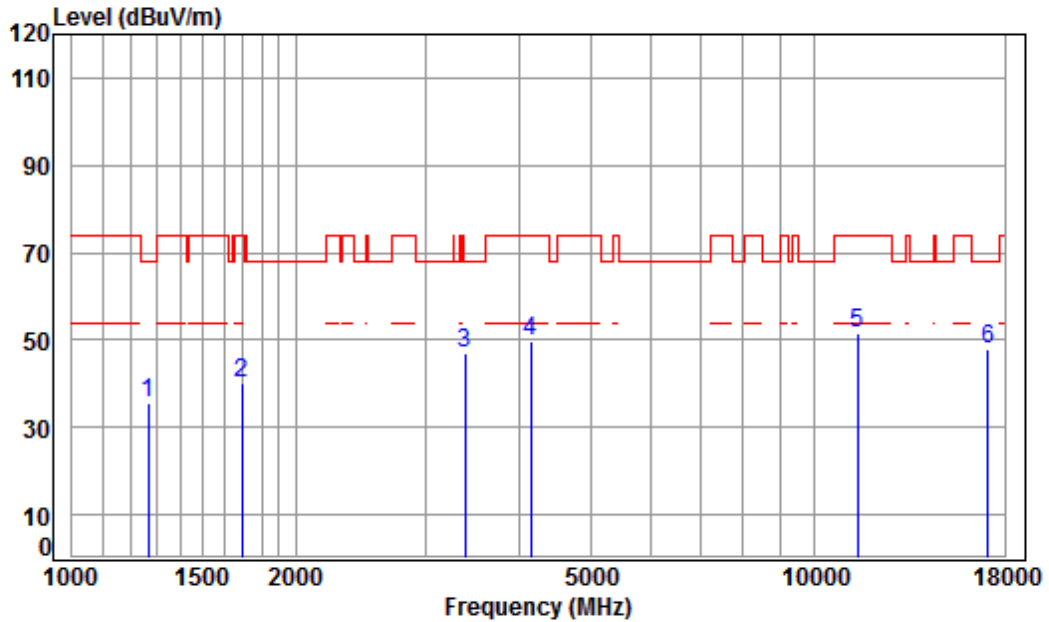

Condition: 3m HORIZONTAL
 Job No : 04056CR/04057CR
 Mode : 5700 TX RSE
 Note : 5G WIFI 11AC20

	Freq	Cable Loss	Ant Factor	Preamp Factor	Read Level	Level	Limit	Over	Remark
	MHz	dB	dB/m	dB	dBuV	dBuV/m	dBuV/m	dB	
1	1267.454	4.68	24.80	38.07	44.29	35.70	68.20	-32.50	peak
2	1692.231	5.24	26.64	38.02	46.20	40.06	74.00	-33.94	peak
3	3376.523	6.35	31.99	37.94	46.47	46.87	68.20	-21.33	peak
4	4145.664	7.16	33.60	38.08	47.12	49.80	74.00	-24.20	peak
5	11400.000	12.04	38.02	35.89	37.56	51.73	74.00	-22.27	peak
6	pp17100.000	16.49	42.92	36.25	24.59	47.75	68.20	-20.45	peak



Mode:g; Polarization:Vertical; Modulation:802.11ac; bandwidth:20MHz; Channel:High

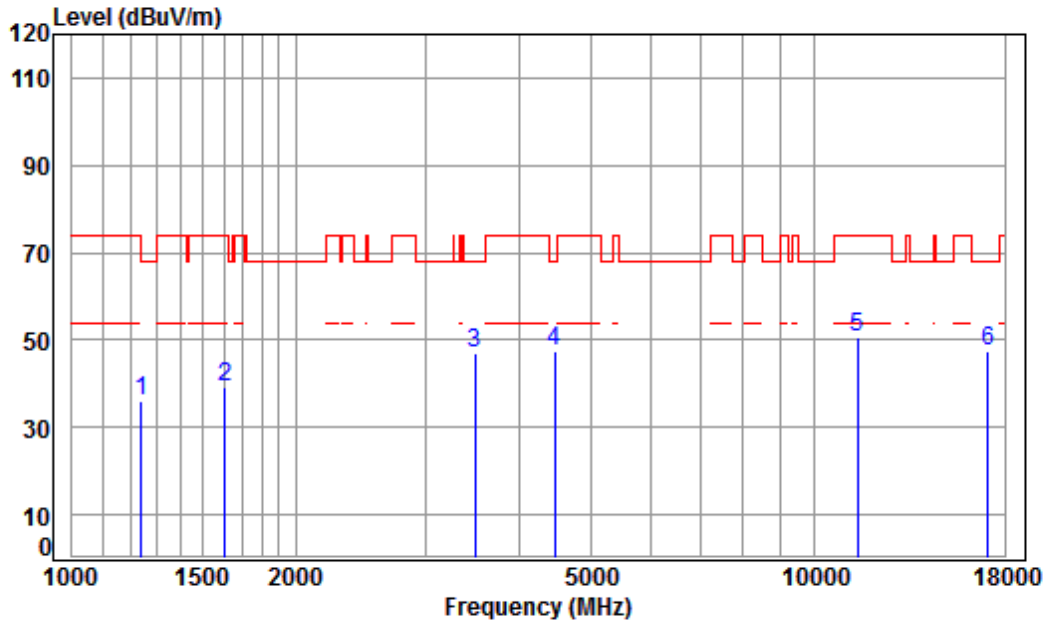

Condition: 3m VERTICAL
Job No : 04056CR/04057CR
Mode : 5700 TX RSE
Note : 5G WIFI 11AC20

	Cable	Ant	Preamp	Read	Limit	Over		
Freq	Loss	Factor	Factor	Level	Level	Line	Limit	Remark
MHz	dB	dB/m	dB	dBuV	dBuV/m	dBuV/m	dB	
1	1238.483	4.57	24.67	38.07	44.94	36.11	74.00	-37.89 peak
2	1606.441	5.34	26.28	38.03	45.72	39.31	74.00	-34.69 peak
3	3485.601	6.45	32.18	37.95	46.25	46.93	68.20	-21.27 peak
4	4469.214	7.53	33.60	38.25	44.45	47.33	68.20	-20.87 peak
5	11400.000	12.04	38.02	35.89	36.40	50.57	74.00	-23.43 peak
6	pp17100.000	16.49	42.92	36.25	24.45	47.61	68.20	-20.59 peak



Mode:g; Polarization:Horizontal; Modulation:802.11ac; bandwidth:40MHz; Channel:Low

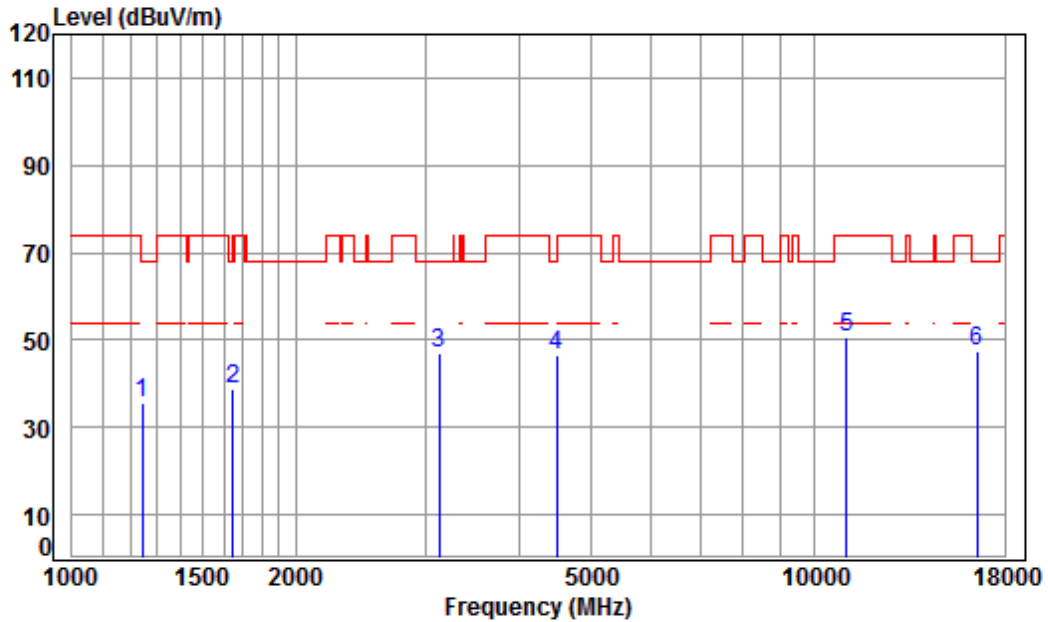

Condition: 3m HORIZONTAL
Job No : 04056CR/04057CR
Mode : 5510 TX RSE
Note : 5G WIFI 11AC40

	Freq	Cable Loss	Ant Factor	Preamp Factor	Read Level	Level	Limit	Over	Remark
	MHz	dB	dB/m	dB	dBuV	dBuV/m	dBuV/m	dB	
1	1245.663	4.60	24.70	38.07	44.30	35.53	68.20	-32.67	peak
2	1648.778	5.29	26.46	38.03	45.08	38.80	68.20	-29.40	peak
3	3123.039	6.11	31.53	37.91	47.35	47.08	68.20	-21.12	peak
4	4495.125	7.55	33.60	38.26	43.84	46.73	68.20	-21.47	peak
5	11020.000	11.65	37.72	35.43	36.82	50.76	74.00	-23.24	peak
6	pp16530.000	14.63	42.71	36.99	26.95	47.30	68.20	-20.90	peak



Mode:g; Polarization:Vertical; Modulation:802.11ac; bandwidth:40MHz; Channel:Low

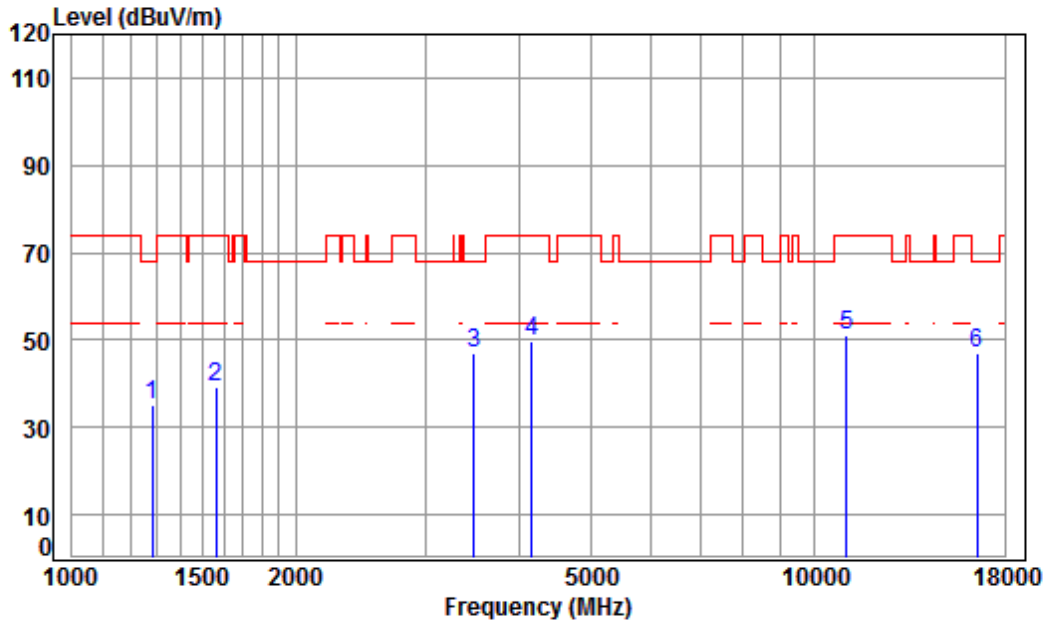

Condition: 3m VERTICAL
Job No : 04056CR/04057CR
Mode : 5510 TX RSE
Note : 5G WIFI 11AC40

	Freq	Cable Loss	Ant Factor	Preamp Factor	Read Level	Limit Level	Over Limit	Remark
	MHz	dB	dB/m	dB	dBuV	dBuV/m	dBuV/m	dB
1	1282.193	4.73	24.87	38.06	43.46	35.00	68.20	-33.20 peak
2	1565.191	5.39	26.10	38.04	45.62	39.07	74.00	-34.93 peak
3	3475.541	6.44	32.16	37.95	46.30	46.95	68.20	-21.25 peak
4	4157.664	7.17	33.60	38.09	47.14	49.82	74.00	-24.18 peak
5	11020.000	11.65	37.72	35.43	37.35	51.29	74.00	-22.71 peak
6	pp16530.000	14.63	42.71	36.99	26.85	47.20	68.20	-21.00 peak



Mode:g; Polarization:Horizontal; Modulation:802.11ac; bandwidth:40MHz; Channel:middle

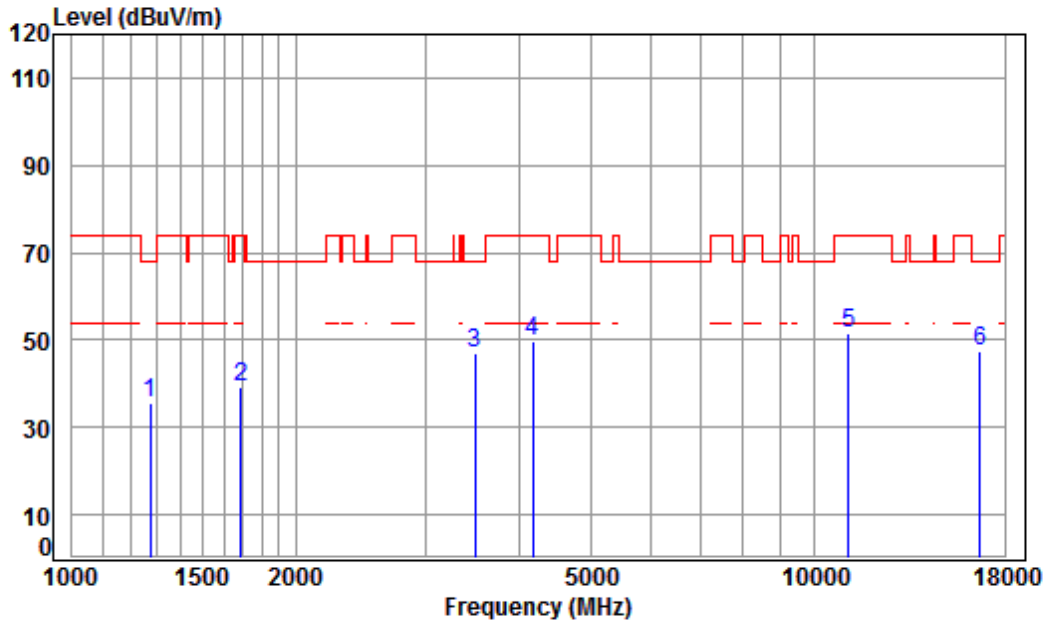

Condition: 3m HORIZONTAL
Job No : 04056CR/04057CR
Mode : 5550 TX RSE
Note : 5G WIFI 11AC40

	Cable	Ant	Preamp	Read	Limit	Over		
Freq	Loss	Factor	Factor	Level	Level	Line	Limit	Remark
MHz	dB	dB/m	dB	dBuV	dBuV/m	dBuV/m	dB	
1	1274.802	4.71	24.84	38.06	44.11	35.60	68.20	-32.60 peak
2	1687.347	5.24	26.62	38.02	45.54	39.38	74.00	-34.62 peak
3	3485.601	6.45	32.18	37.95	46.46	47.14	68.20	-21.06 peak
4	4169.698	7.18	33.60	38.09	47.27	49.96	74.00	-24.04 peak
5	11100.000	11.73	37.78	35.52	37.36	51.35	74.00	-22.65 peak
6	pp16650.000	15.17	42.73	36.81	26.21	47.30	68.20	-20.90 peak



Mode:g; Polarization:Vertical; Modulation:802.11ac; bandwidth:40MHz; Channel:middle

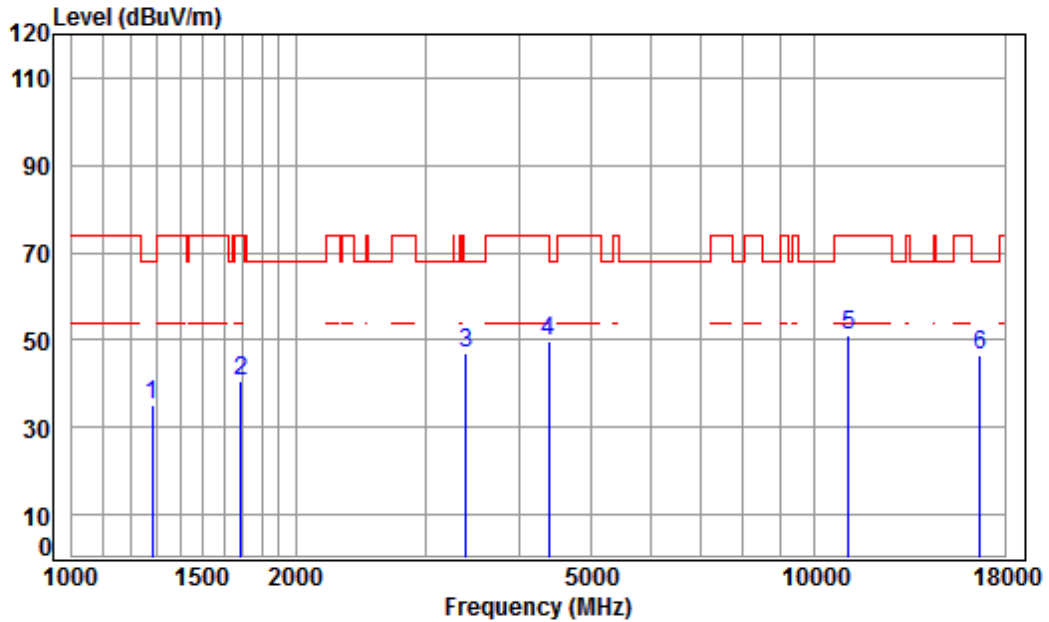

Condition: 3m VERTICAL
Job No : 04056CR/04057CR
Mode : 5550 TX RSE
Note : 5G WIFI 11AC40

	Freq	Cable Loss	Ant Factor	Preamp Factor	Read Level	Limit Level	Limit Line	Over Limit	Remark
	MHz	dB	dB/m	dB	dBuV	dBuV/m	dBuV/m	dB	
1	1282.193	4.73	24.87	38.06	43.49	35.03	68.20	-33.17	peak
2	1687.347	5.24	26.62	38.02	46.55	40.39	74.00	-33.61	peak
3 pp	3396.098	6.37	32.02	37.94	46.56	47.01	68.20	-21.19	peak
4	4379.699	7.43	33.60	38.20	46.97	49.80	74.00	-24.20	peak
5	11100.000	11.73	37.78	35.52	37.23	51.22	74.00	-22.78	peak
6	16650.000	15.17	42.73	36.81	25.38	46.47	68.20	-21.73	peak



Mode:g; Polarization:Horizontal; Modulation:802.11ac; bandwidth:40MHz; Channel:High

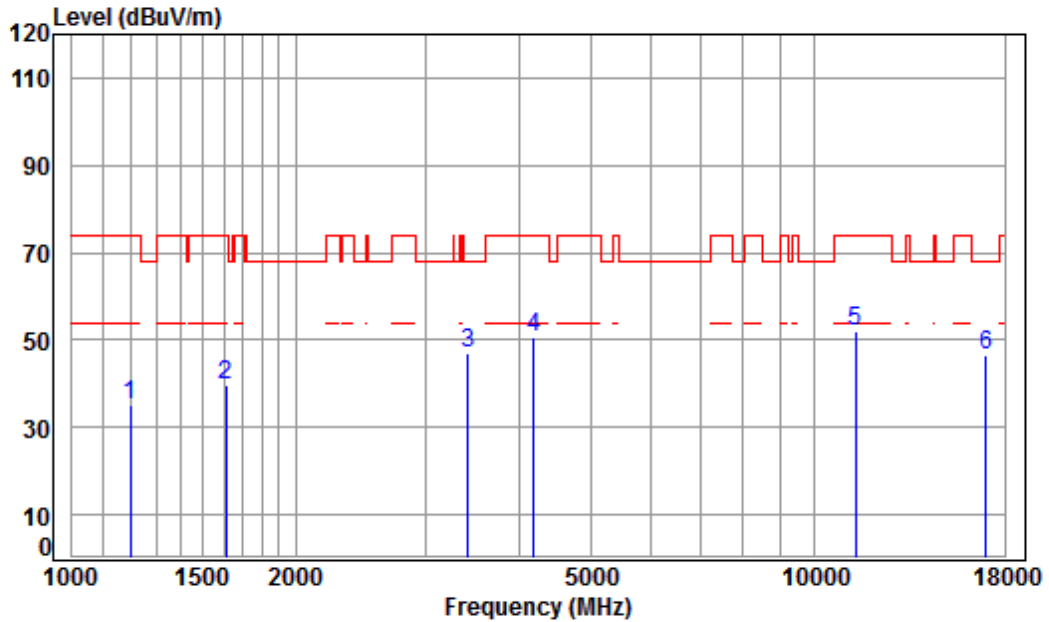

Condition: 3m HORIZONTAL
Job No : 04056CR/04057CR
Mode : 5670 TX RSE
Note : 5G WIFI 11AC40

	Freq	Cable Loss	Ant Factor	Preamp Factor	Read Level	Level	Limit	Over	Remark
	MHz	dB	dB/m	dB	dBuV	dBuV/m	dBuV/m	dB	
1	1199.726	4.42	24.48	38.07	44.49	35.32	74.00	-38.68	peak
2	1611.091	5.34	26.30	38.03	46.18	39.79	74.00	-34.21	peak
3	pp 3415.787	6.38	32.06	37.95	46.47	46.96	68.20	-21.24	peak
4	4181.768	7.20	33.60	38.10	48.03	50.73	74.00	-23.27	peak
5	11340.000	11.98	37.97	35.82	37.75	51.88	74.00	-22.12	peak
6	17010.000	16.69	42.81	36.29	23.56	46.77	68.20	-21.43	peak



Mode:g; Polarization:Vertical; Modulation:802.11ac; bandwidth:40MHz; Channel:High

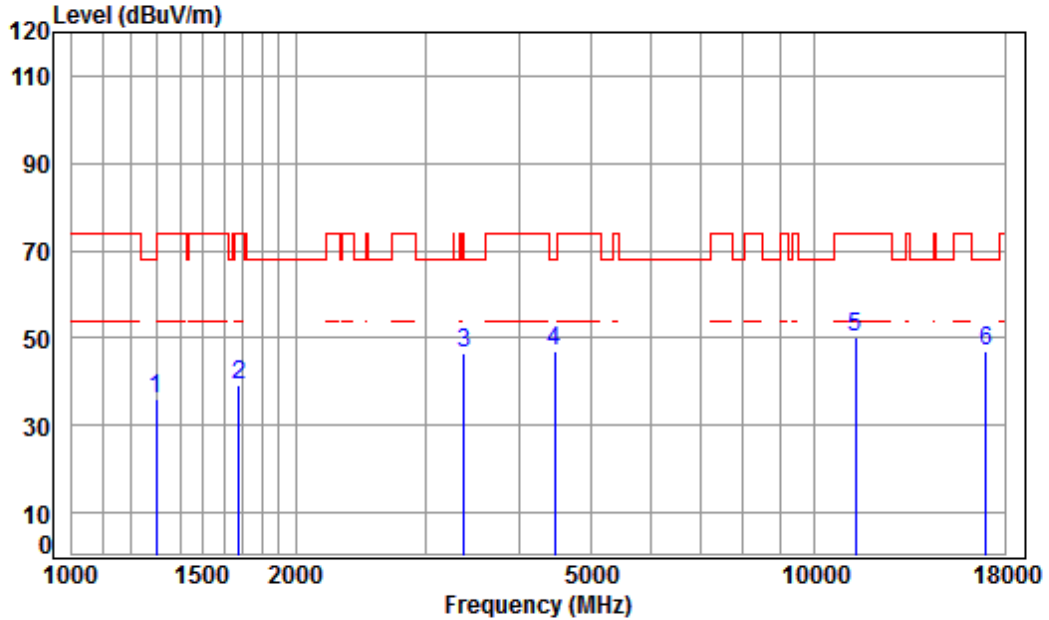

Condition: 3m VERTICAL
Job No : 04056CR/04057CR
Mode : 5670 TX RSE
Note : 5G WIFI 11AC40

	Freq	Cable Loss	Ant Factor	Preamp Factor	Read Level	Limit Level	Over Limit	Remark
	MHz	dB	dB/m	dB	dBuV	dBuV/m	dBuV/m	dB
1	1300.858	4.80	24.96	38.06	44.14	35.84	74.00	-38.16 peak
2	1677.621	5.25	26.58	38.03	45.40	39.20	74.00	-34.80 peak
3	3366.778	6.34	31.97	37.94	46.30	46.67	68.20	-21.53 peak
4	4469.214	7.53	33.60	38.25	43.97	46.85	68.20	-21.35 peak
5	11340.000	11.98	37.97	35.82	36.19	50.32	74.00	-23.68 peak
6	pp17010.000	16.69	42.81	36.29	23.67	46.88	68.20	-21.32 peak



Mode:g; Polarization:Horizontal; Modulation:802.11ac; bandwidth:80MHz; Channel:Low

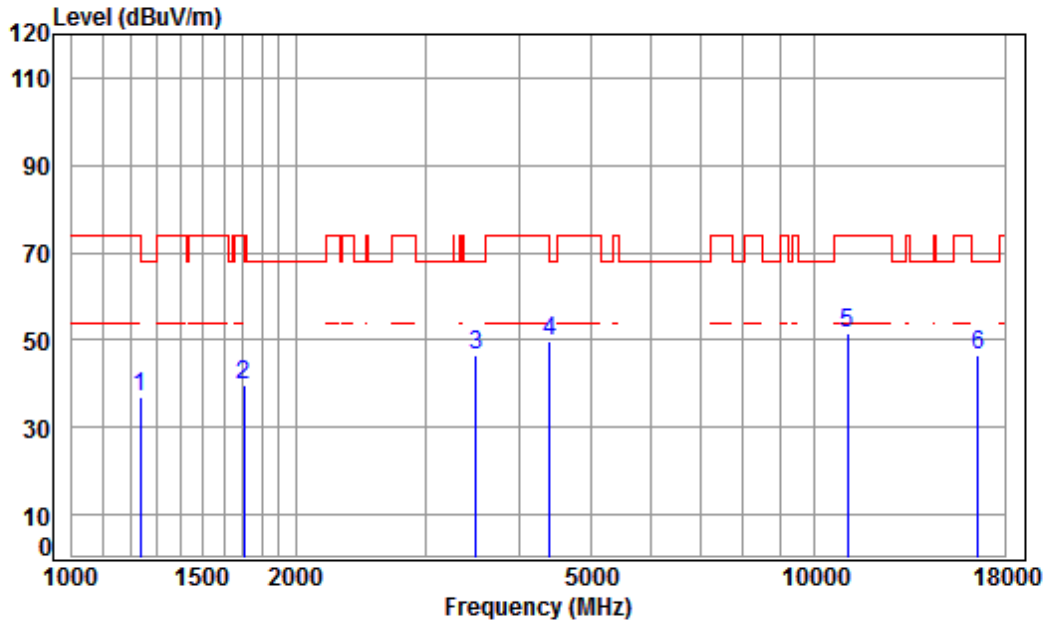

Condition: 3m HORIZONTAL
Job No : 04056CR/04057CR
Mode : 5530 TX RSE
Note : 5G WIFI 11AC80

	Freq	Cable Loss	Ant Factor	Preamp Factor	Read Level	Level	Limit	Over	Remark
	MHz	dB	dB/m	dB	dBuV	dBuV/m	dBuV/m	dB	
1	1234.909	4.55	24.65	38.07	45.91	37.04	74.00	-36.96	peak
2	1702.042	5.23	26.68	38.02	45.93	39.82	74.00	-34.18	peak
3	pp 3495.691	6.46	32.19	37.95	45.94	46.64	68.20	-21.56	peak
4	4392.376	7.44	33.60	38.21	47.09	49.92	74.00	-24.08	peak
5	11060.000	11.69	37.75	35.48	37.67	51.63	74.00	-22.37	peak
6	16590.000	14.90	42.72	36.90	25.71	46.43	68.20	-21.77	peak



Mode:g; Polarization:Vertical; Modulation:802.11ac; bandwidth:80MHz; Channel:Low

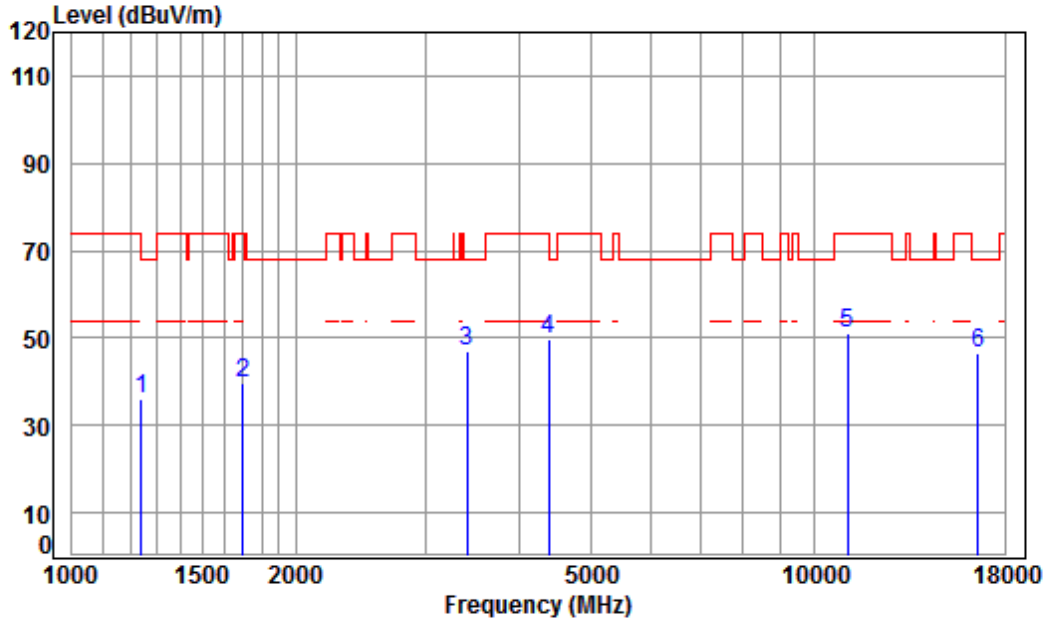

Condition: 3m VERTICAL
Job No : 04056CR/04057CR
Mode : 5530 TX RSE
Note : 5G WIFI 11AC80

	Freq	Cable Loss	Ant Factor	Preamp Factor	Read Level	Level	Limit	Over	Remark
	MHz	dB	dB/m	dB	dBuV	dBuV/m	dBuV/m	dB	
1	1238.483	4.57	24.67	38.07	44.94	36.11	74.00	-37.89	peak
2	1697.129	5.23	26.66	38.02	45.69	39.56	74.00	-34.44	peak
3 pp	3405.929	6.38	32.04	37.94	46.48	46.96	68.20	-21.24	peak
4	4379.699	7.43	33.60	38.20	46.99	49.82	74.00	-24.18	peak
5	11060.000	11.69	37.75	35.48	37.30	51.26	74.00	-22.74	peak
6	16590.000	14.90	42.72	36.90	26.00	46.72	68.20	-21.48	peak



Mode:g; Polarization:Horizontal; Modulation:802.11ac; bandwidth:80MHz; Channel:High

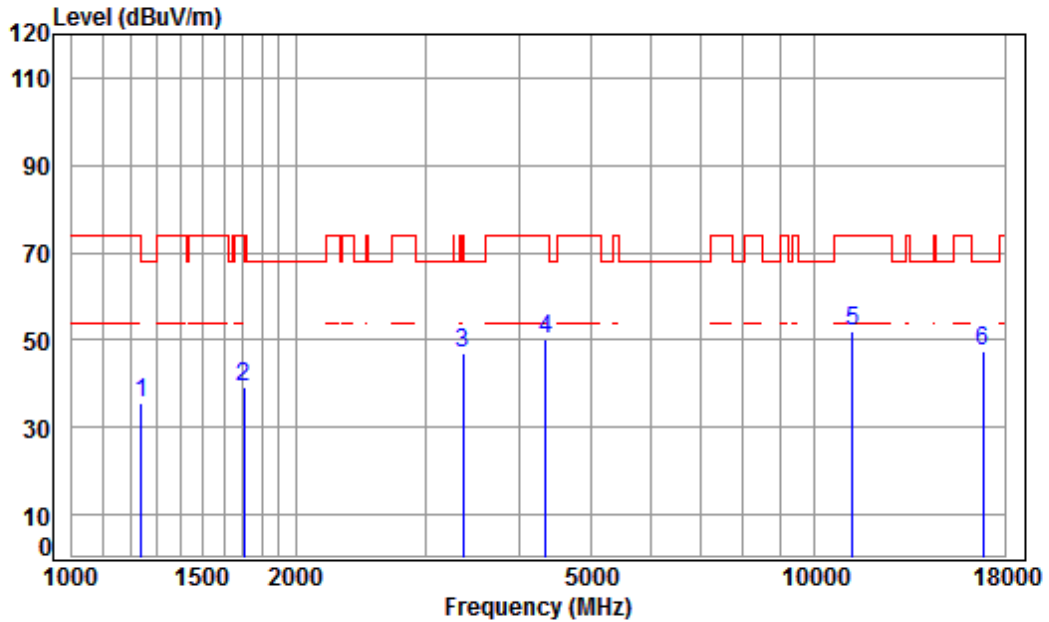

Condition: 3m HORIZONTAL
Job No : 04056CR/04057CR
Mode : 5610 TX RSE
Note : 5G WIFI 11AC80

	Freq	Cable Loss	Ant Factor	Preamplifier	Read Level	Limit Level	Over Limit	Remark
	MHz	dB	dB/m	dB	dBuV	dBuV/m	dB	
1	1238.483	4.57	24.67	38.07	44.19	35.36	74.00	-38.64 peak
2	1702.042	5.23	26.68	38.02	45.26	39.15	74.00	-34.85 peak
3	3357.061	6.33	31.96	37.94	46.55	46.90	74.00	-27.10 peak
4	4341.886	7.38	33.60	38.18	47.48	50.28	74.00	-23.72 peak
5	11220.000	11.86	37.88	35.67	37.85	51.92	74.00	-22.08 peak
6	pp16830.000	15.97	42.77	36.55	25.48	47.67	68.20	-20.53 peak



Mode:g; Polarization:Vertical; Modulation:802.11ac; bandwidth:80MHz; Channel:High

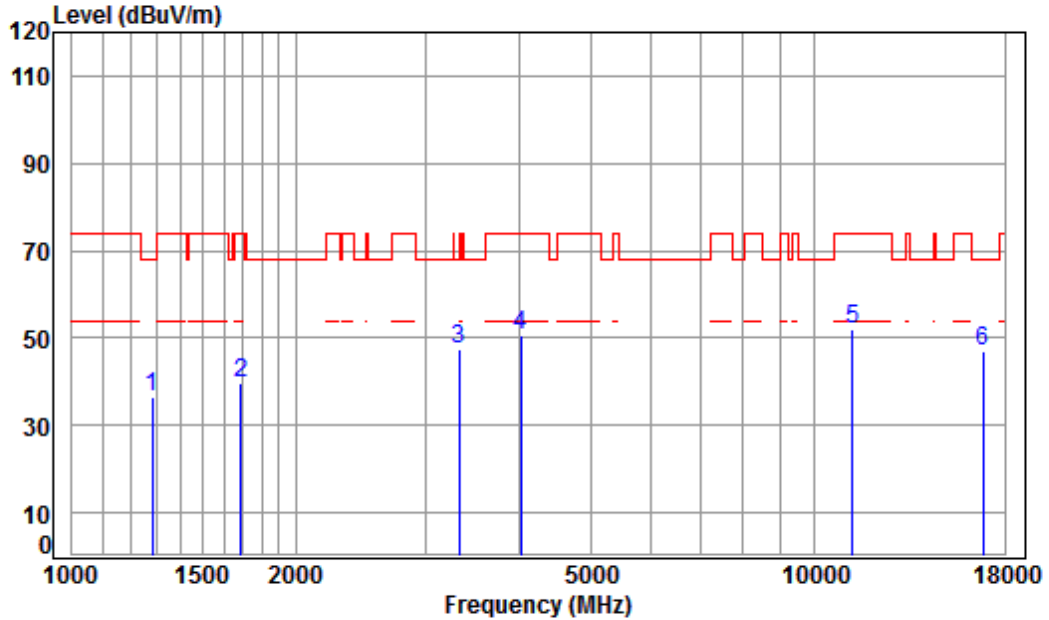

Condition: 3m VERTICAL
Job No : 04056CR/04057CR
Mode : 5610 TX RSE
Note : 5G WIFI 11AC80

	Freq	Cable Loss	Ant Factor	Preamp Factor	Read Level	Level	Limit	Over	Remark
	MHz	dB	dB/m	dB	dBuV	dBuV/m	dBuV/m	dB	
1	1282.193	4.73	24.87	38.06	44.77	36.31	68.20	-31.89	peak
2	1687.347	5.24	26.62	38.02	46.00	39.84	74.00	-34.16	peak
3 pp	3318.471	6.29	31.89	37.94	47.31	47.55	68.20	-20.65	peak
4	4015.929	7.00	33.60	38.01	48.07	50.66	74.00	-23.34	peak
5	11220.000	11.86	37.88	35.67	37.73	51.80	74.00	-22.20	peak
6	16830.000	15.97	42.77	36.55	24.95	47.14	68.20	-21.06	peak



Mode:h; Polarization:Horizontal; Modulation:802.11a; bandwidth:20MHz; Channel:Low

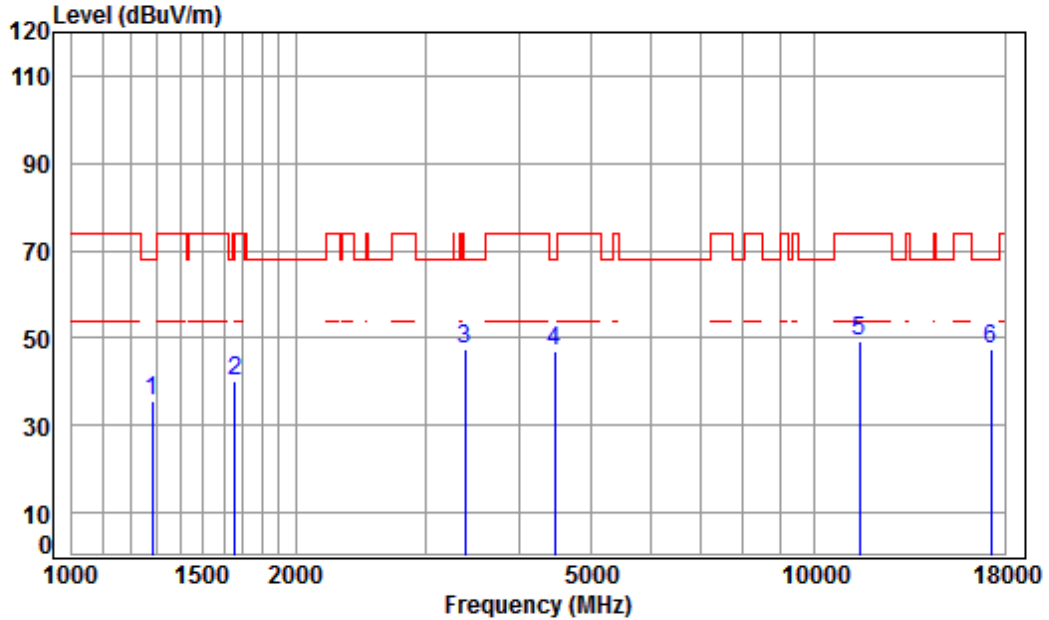

Condition: 3m HORIZONTAL
Job No : 04056CR/04057CR
Mode : 5745 TX RSE
Note : 5G WIFI 11A

	Freq	Cable Loss	Ant Factor	Preamp Factor	Read Level	Limit Level	Limit Line	Over Limit	Remark
	MHz	dB	dB/m	dB	dBuV	dBuV/m	dBuV/m	dB	
1	1282.193	4.73	24.87	38.06	44.22	35.76	68.20	-32.44	peak
2	1658.337	5.28	26.50	38.03	46.32	40.07	68.20	-28.13	peak
3	pp 3386.297	6.36	32.01	37.94	47.09	47.52	68.20	-20.68	peak
4	4469.214	7.53	33.60	38.25	44.13	47.01	68.20	-21.19	peak
5	11490.000	12.13	38.09	36.00	34.85	49.07	74.00	-24.93	peak
6	17235.000	16.18	43.08	36.18	24.18	47.26	68.20	-20.94	peak



Mode:h; Polarization:Vertical; Modulation:802.11a; bandwidth:20MHz; Channel:Low

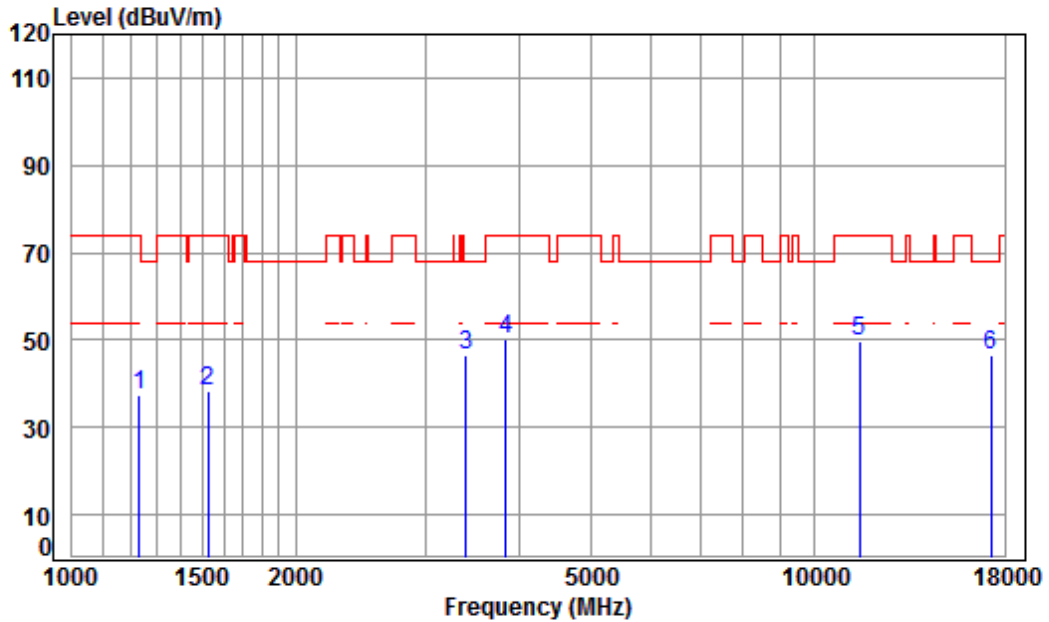

Condition: 3m VERTICAL
Job No : 04056CR/04057CR
Mode : 5745 TX RSE
Note : 5G WIFI 11A

	Freq	Cable Loss	Ant Factor	Preamp Factor	Read Level	Limit Level	Limit Line	Over Limit	Remark
	MHz	dB	dB/m	dB	dBuV	dBuV/m	dBuV/m	dB	
1	1231.345	4.54	24.63	38.07	46.37	37.47	74.00	-36.53	peak
2	1525.000	5.45	25.91	38.04	44.86	38.18	74.00	-35.82	peak
3 pp	3396.098	6.37	32.02	37.94	46.24	46.69	68.20	-21.51	peak
4	3834.438	6.82	33.16	37.99	48.33	50.32	74.00	-23.68	peak
5	11490.000	12.13	38.09	36.00	35.53	49.75	74.00	-24.25	peak
6	17235.000	16.18	43.08	36.18	23.35	46.43	68.20	-21.77	peak



Mode:h; Polarization:Horizontal; Modulation:802.11a; bandwidth:20MHz; Channel:middle

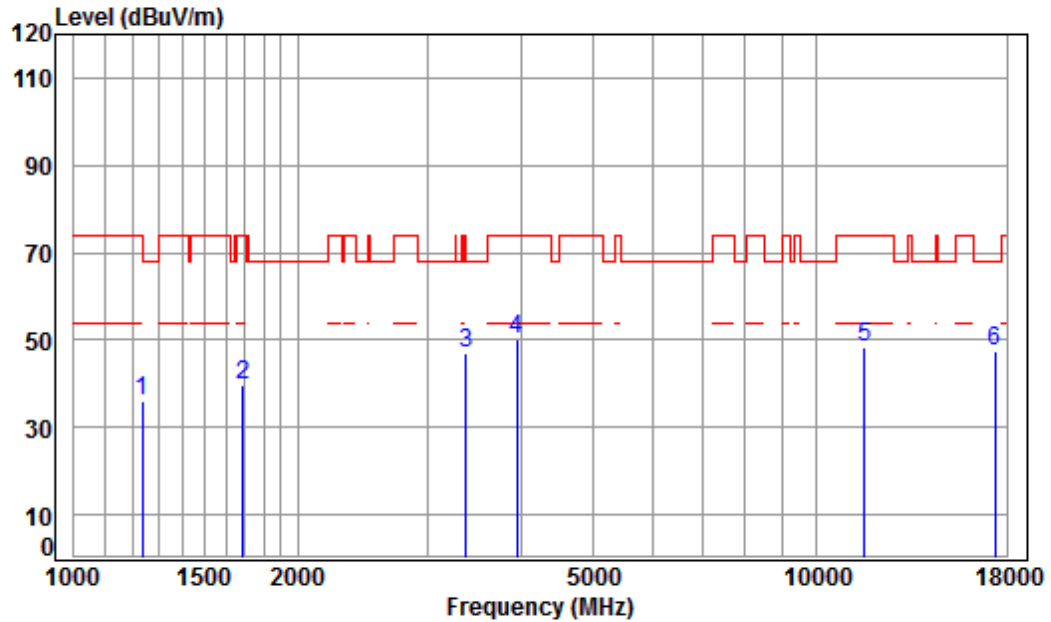

Condition: 3m HORIZONTAL
Job No : 04056CR/04057CR
Mode : 5785 TX RSE
Note : 5G WIFI 11A

	Cable	Ant	Preamp	Read	Limit	Over		
Freq	Loss	Factor	Factor	Level	Level	Line	Limit	Remark
MHz	dB	dB/m	dB	dBuV	dBuV/m	dBuV/m	dB	
1	1234.909	4.55	24.65	38.07	44.72	35.85	74.00	-38.15 peak
2	1687.347	5.24	26.62	38.02	45.96	39.80	74.00	-34.20 peak
3	3366.778	6.34	31.97	37.94	46.59	46.96	68.20	-21.24 peak
4	3946.885	6.93	33.46	38.00	47.92	50.31	74.00	-23.69 peak
5	11570.000	12.17	38.17	36.10	34.06	48.30	74.00	-25.70 peak
6	pp17355.000	15.92	43.23	36.12	24.28	47.31	68.20	-20.89 peak



Mode:h; Polarization:Vertical; Modulation:802.11a; bandwidth:20MHz; Channel:middle

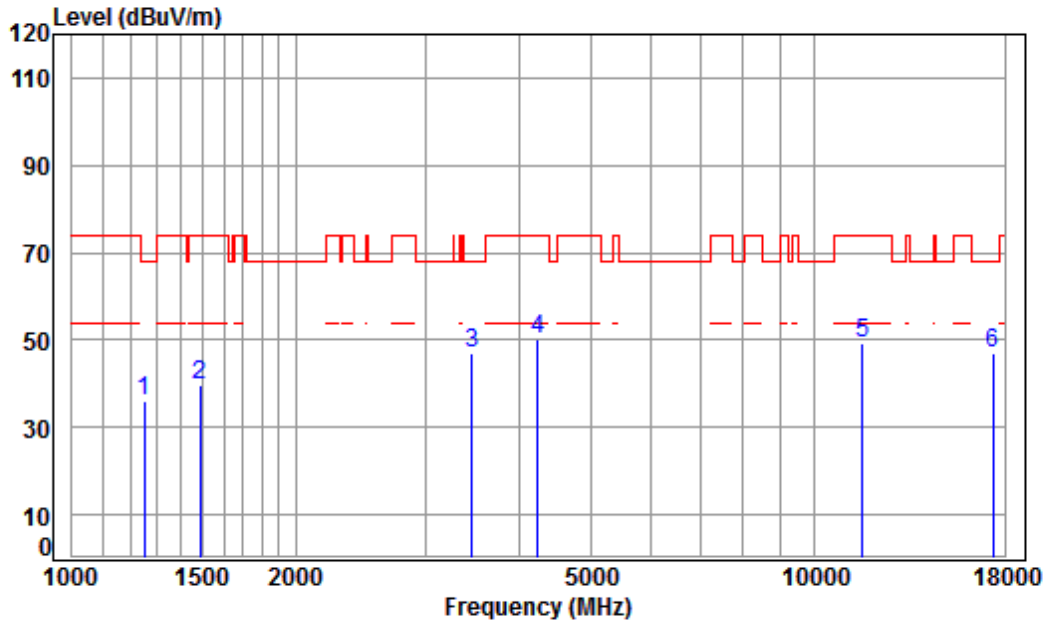

Condition: 3m VERTICAL
Job No : 04056CR/04057CR
Mode : 5785 TX RSE
Note : 5G WIFI 11A

	Freq	Cable Loss	Ant Factor	Preamp Factor	Read Level	Level	Limit	Over	Remark
	MHz	dB	dB/m	dB	dBuV	dBuV/m	dBuV/m	dB	
1	1252.885	4.62	24.73	38.07	44.64	35.92	68.20	-32.28	peak
2	1485.841	5.43	25.74	38.04	46.64	39.77	74.00	-34.23	peak
3	pp 3455.508	6.42	32.13	37.95	46.53	47.13	68.20	-21.07	peak
4	4230.396	7.26	33.60	38.13	47.36	50.09	74.00	-23.91	peak
5	11570.000	12.17	38.17	36.10	34.97	49.21	74.00	-24.79	peak
6	17355.000	15.92	43.23	36.12	24.05	47.08	68.20	-21.12	peak



Mode:h; Polarization:Horizontal; Modulation:802.11a; bandwidth:20MHz; Channel:High

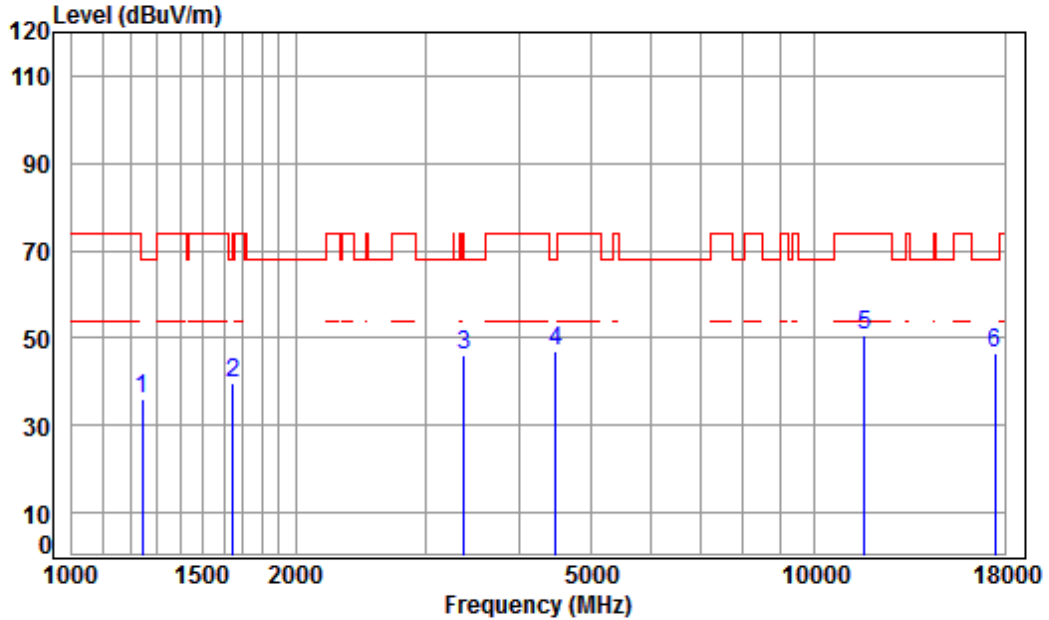

Condition: 3m HORIZONTAL
Job No : 04056CR/04057CR
Mode : 5825 TX RSE
Note : 5G WIFI 11A

	Freq	Cable Loss	Ant Factor	Preamp Factor	Read Level	Limit Level	Over Limit	Remark
	MHz	dB	dB/m	dB	dBuV	dBuV/m	dBuV/m	dB
1	1245.663	4.60	24.70	38.07	44.87	36.10	68.20	-32.10 peak
2	1648.778	5.29	26.46	38.03	46.00	39.72	68.20	-28.48 peak
3	3366.778	6.34	31.97	37.94	45.89	46.26	68.20	-21.94 peak
4	pp 4482.150	7.54	33.60	38.26	44.18	47.06	68.20	-21.14 peak
5	11650.000	12.20	38.25	36.19	36.34	50.60	74.00	-23.40 peak
6	17475.000	15.65	43.37	36.06	23.45	46.41	68.20	-21.79 peak



Mode:h; Polarization:Vertical; Modulation:802.11a; bandwidth:20MHz; Channel:High

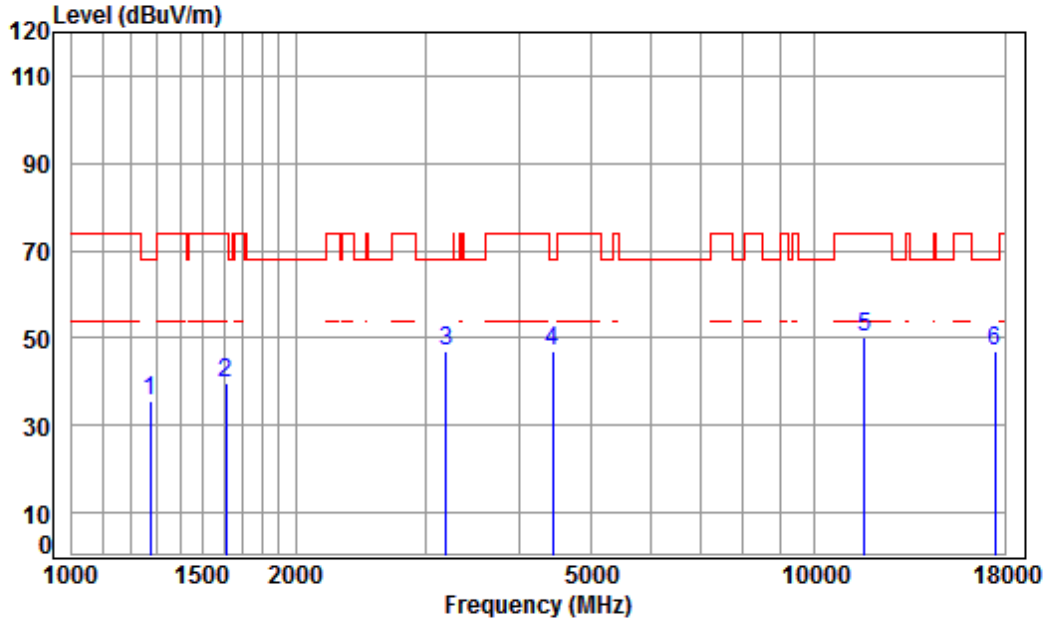

Condition: 3m VERTICAL
Job No : 04056CR/04057CR
Mode : 5825 TX RSE
Note : 5G WIFI 11A

	Freq	Cable Loss	Ant Factor	Preamp Factor	Read Level	Limit Level	Limit Line	Over Limit	Remark
	MHz	dB	dB/m	dB	dBuV	dBuV/m	dBuV/m	dB	
1	1274.802	4.71	24.84	38.06	44.32	35.81	68.20	-32.39	peak
2	1611.091	5.34	26.30	38.03	46.14	39.75	74.00	-34.25	peak
3	pp 3186.869	6.17	31.65	37.92	47.21	47.11	68.20	-21.09	peak
4	4430.628	7.48	33.60	38.23	44.21	47.06	68.20	-21.14	peak
5	11650.000	12.20	38.25	36.19	35.87	50.13	74.00	-23.87	peak
6	17475.000	15.65	43.37	36.06	24.04	47.00	68.20	-21.20	peak



Mode:h; Polarization:Horizontal; Modulation:802.11n; bandwidth:20MHz; Channel:Low

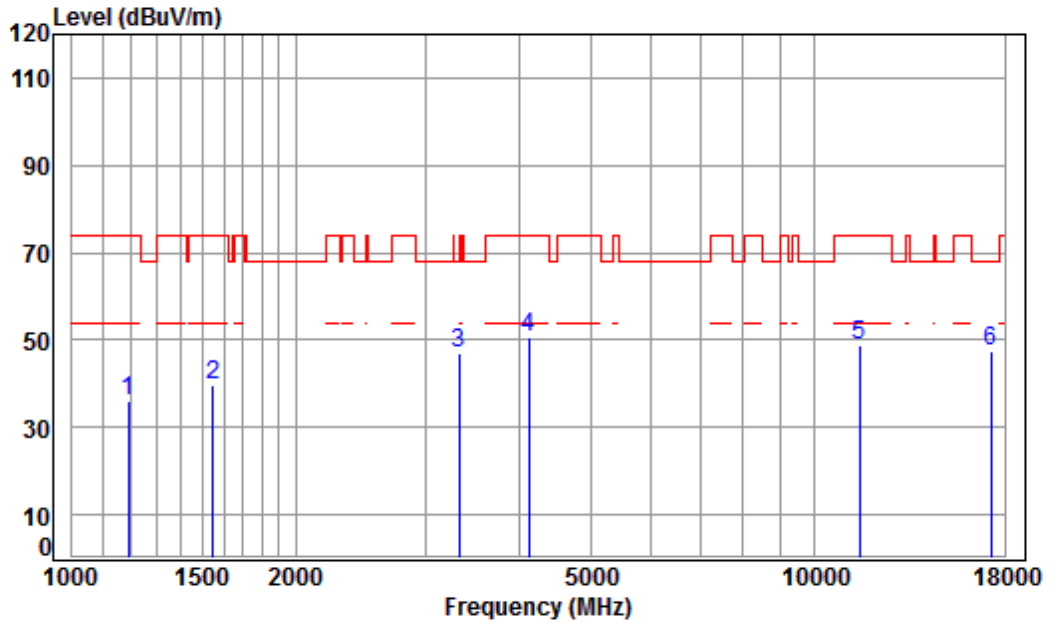

Condition: 3m HORIZONTAL
Job No : 04056CR/04057CR
Mode : 5745 TX RSE
Note : 5G WIFI 11N20

	Cable	Ant	Preamp	Read	Limit	Over		
Freq	Loss	Factor	Factor	Level	Level	Line	Limit	Remark
MHz	dB	dB/m	dB	dBuV	dBuV/m	dBuV/m	dB	
1	1192.811	4.39	24.44	38.07	45.27	36.03	74.00	-37.97 peak
2	1547.199	5.42	26.02	38.04	46.08	39.48	74.00	-34.52 peak
3	3318.471	6.29	31.89	37.94	46.60	46.84	68.20	-21.36 peak
4	4121.768	7.13	33.60	38.07	48.07	50.73	74.00	-23.27 peak
5	11490.000	12.13	38.09	36.00	34.70	48.92	74.00	-25.08 peak
6	pp17235.000	16.18	43.08	36.18	24.32	47.40	68.20	-20.80 peak



Mode:h; Polarization:Vertical; Modulation:802.11n; bandwidth:20MHz; Channel:Low

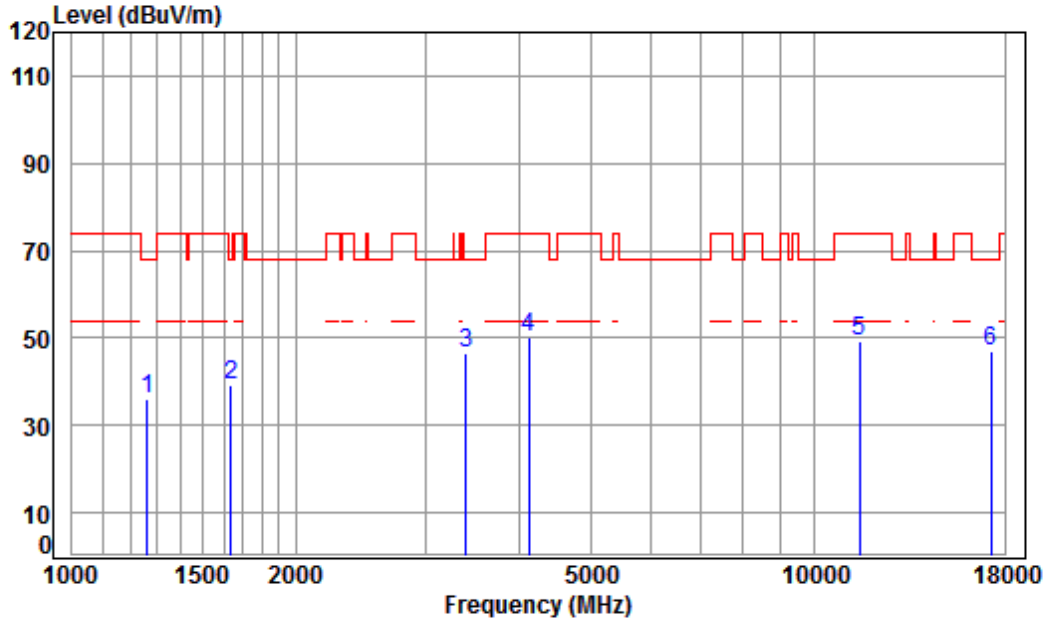

Condition: 3m VERTICAL
Job No : 04056CR/04057CR
Mode : 5745 TX RSE
Note : 5G WIFI 11N20

	Freq	Cable Loss	Ant Factor	Preamp Factor	Read Level	Level	Limit	Over	Remark
	MHz	dB	dB/m	dB	dBuV	dBuV/m	dBuV/m	dB	
1	1263.796	4.66	24.79	38.07	44.50	35.88	68.20	-32.32	peak
2	1639.274	5.30	26.42	38.03	45.43	39.12	68.20	-29.08	peak
3	3396.098	6.37	32.02	37.94	46.13	46.58	68.20	-21.62	peak
4	4121.768	7.13	33.60	38.07	47.45	50.11	74.00	-23.89	peak
5	11490.000	12.13	38.09	36.00	34.92	49.14	74.00	-24.86	peak
6	pp17235.000	16.18	43.08	36.18	23.97	47.05	68.20	-21.15	peak



Mode:h; Polarization:Horizontal; Modulation:802.11n; bandwidth:20MHz; Channel:middle

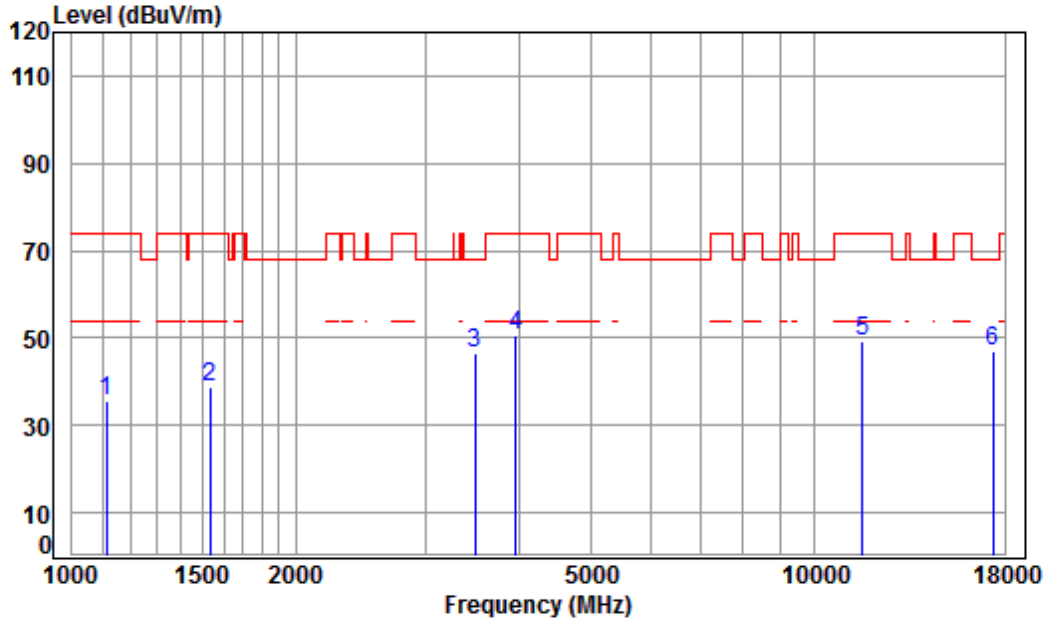

Condition: 3m HORIZONTAL
Job No : 04056CR/04057CR
Mode : 5785 TX RSE
Note : 5G WIFI 11N20

	Cable	Ant	Preamp	Read	Limit	Over		
Freq	Loss	Factor	Factor	Level	Level	Line	Limit	Remark
MHz	dB	dB/m	dB	dBuV	dBuV/m	dBuV/m	dB	
1	1112.872	4.06	24.03	38.08	45.55	35.56	74.00	-38.44 peak
2	1533.841	5.44	25.96	38.04	45.48	38.84	74.00	-35.16 peak
3	3485.601	6.45	32.18	37.95	45.79	46.47	68.20	-21.73 peak
4	3958.309	6.94	33.49	38.00	48.11	50.54	74.00	-23.46 peak
5	11570.000	12.17	38.17	36.10	34.92	49.16	74.00	-24.84 peak
6	pp17355.000	15.92	43.23	36.12	23.88	46.91	68.20	-21.29 peak



Mode:h; Polarization:Vertical; Modulation:802.11n; bandwidth:20MHz; Channel:middle

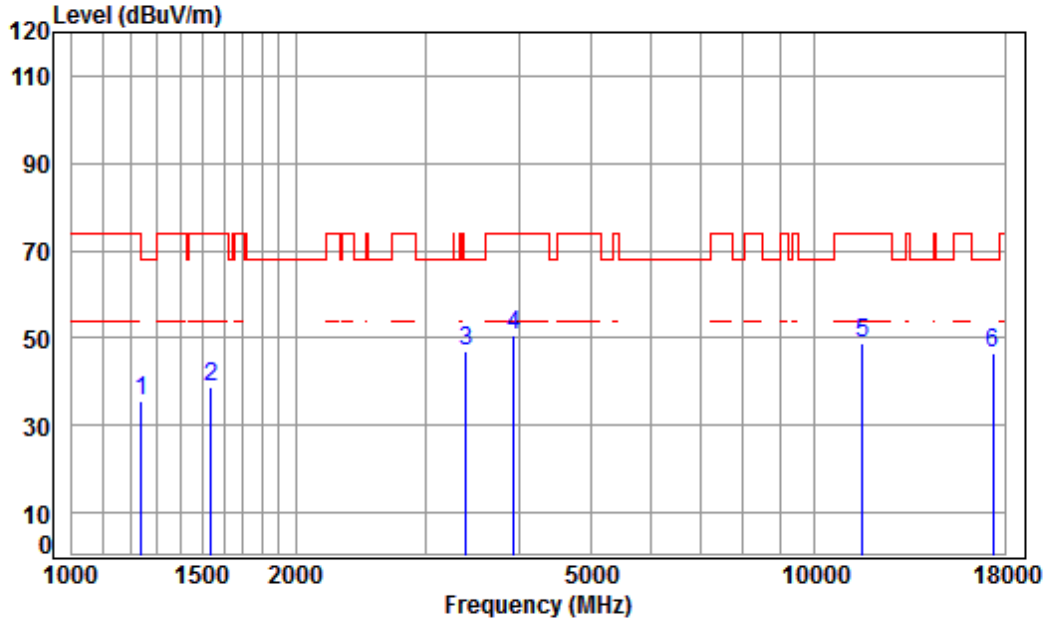

Condition: 3m VERTICAL
Job No : 04056CR/04057CR
Mode : 5785 TX RSE
Note : 5G WIFI 11N20

	Freq	Cable Loss	Ant Factor	Preamp Factor	Read Level	Level	Limit	Over	Remark
	MHz	dB	dB/m	dB	dBuV	dBuV/m	dBuV/m	dB	
1	1242.068	4.58	24.68	38.07	44.62	35.81	68.20	-32.39	peak
2	1538.281	5.43	25.98	38.04	45.22	38.59	74.00	-35.41	peak
3 pp	3396.098	6.37	32.02	37.94	46.33	46.78	68.20	-21.42	peak
4	3935.493	6.92	33.43	37.99	48.08	50.44	74.00	-23.56	peak
5	11570.000	12.17	38.17	36.10	34.45	48.69	74.00	-25.31	peak
6	17355.000	15.92	43.23	36.12	23.69	46.72	68.20	-21.48	peak



Mode:h; Polarization:Horizontal; Modulation:802.11n; bandwidth:20MHz; Channel:High

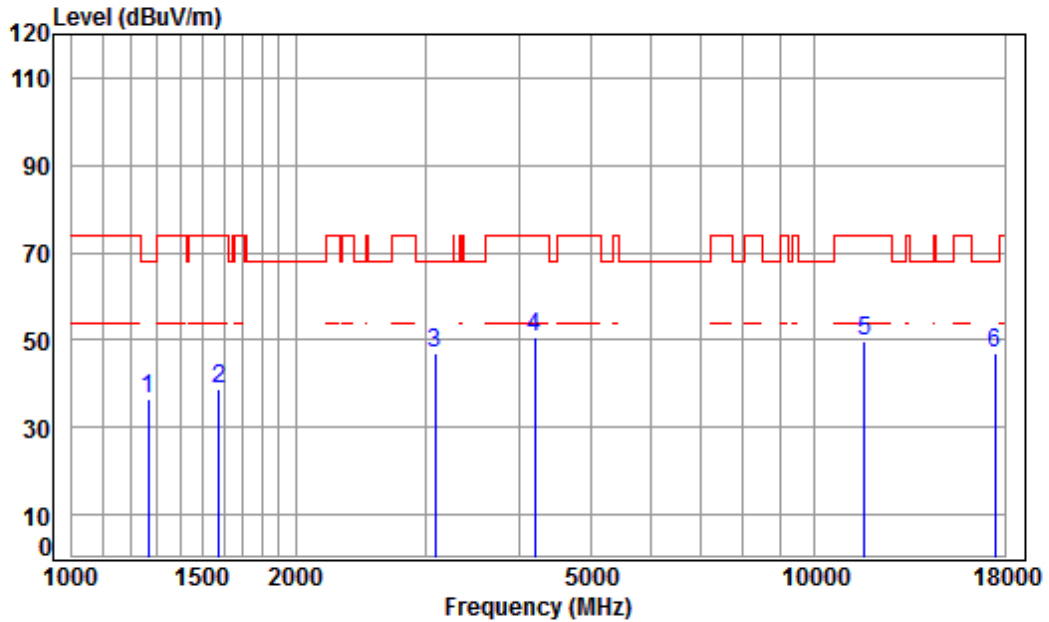

Condition: 3m HORIZONTAL
Job No : 04056CR/04057CR
Mode : 5825 TX RSE
Note : 5G WIFI 11N20

	Cable	Ant	Preamp	Read		Limit	Over	
Freq	Loss	Factor	Factor	Level	Level	Line	Limit	Remark
MHz	dB	dB/m	dB	dBuV	dBuV/m	dBuV/m	dB	
1	1267.454	4.68	24.80	38.07	45.14	36.55	68.20	-31.65 peak
2	1578.822	5.38	26.16	38.03	45.10	38.61	74.00	-35.39 peak
3	3087.140	6.07	31.47	37.91	47.17	46.80	68.20	-21.40 peak
4	4193.872	7.21	33.60	38.11	47.79	50.49	74.00	-23.51 peak
5	11650.000	12.20	38.25	36.19	35.62	49.88	74.00	-24.12 peak
6	pp17475.000	15.65	43.37	36.06	24.00	46.96	68.20	-21.24 peak



Mode:h; Polarization:Vertical; Modulation:802.11n; bandwidth:20MHz; Channel:High

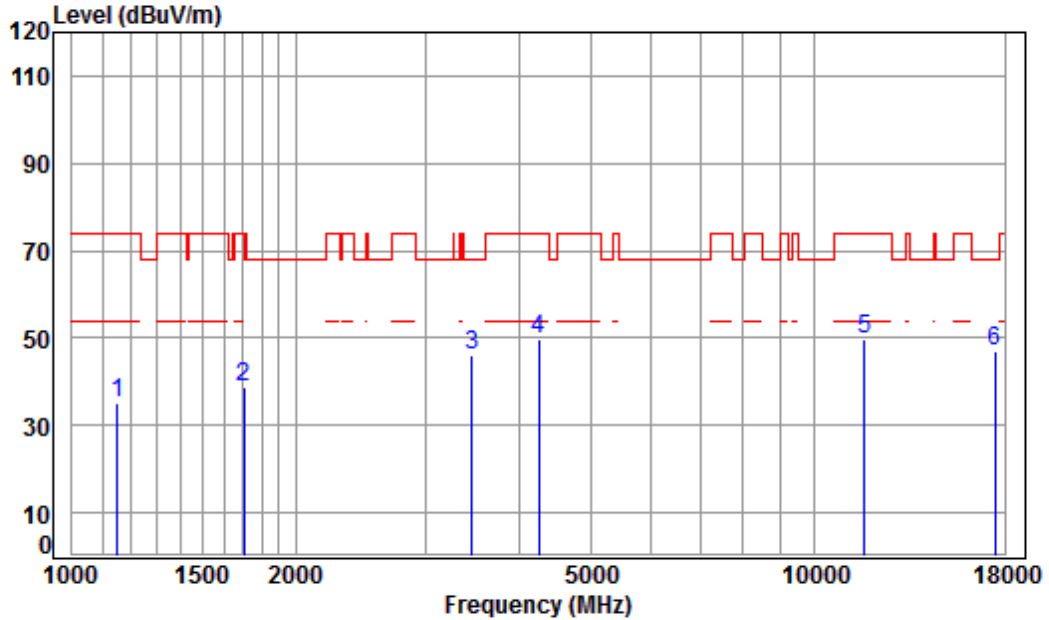

Condition: 3m VERTICAL
Job No : 04056CR/04057CR
Mode : 5825 TX RSE
Note : 5G WIFI 11N20

	Cable	Ant	Preamp	Read	Limit	Over		
Freq	Loss	Factor	Factor	Level	Level	Line	Limit	Remark
MHz	dB	dB/m	dB	dBuV	dBuV/m	dBuV/m	dB	
1	1152.148	4.22	24.24	38.08	44.97	35.35	74.00	-38.65 peak
2	1702.042	5.23	26.68	38.02	44.93	38.82	74.00	-35.18 peak
3	3455.508	6.42	32.13	37.95	45.51	46.11	68.20	-22.09 peak
4	4242.641	7.27	33.60	38.13	47.18	49.92	74.00	-24.08 peak
5	11650.000	12.20	38.25	36.19	35.59	49.85	74.00	-24.15 peak
6	pp17475.000	15.65	43.37	36.06	23.92	46.88	68.20	-21.32 peak



Mode:h; Polarization:Horizontal; Modulation:802.11n; bandwidth:40MHz; Channel:Low

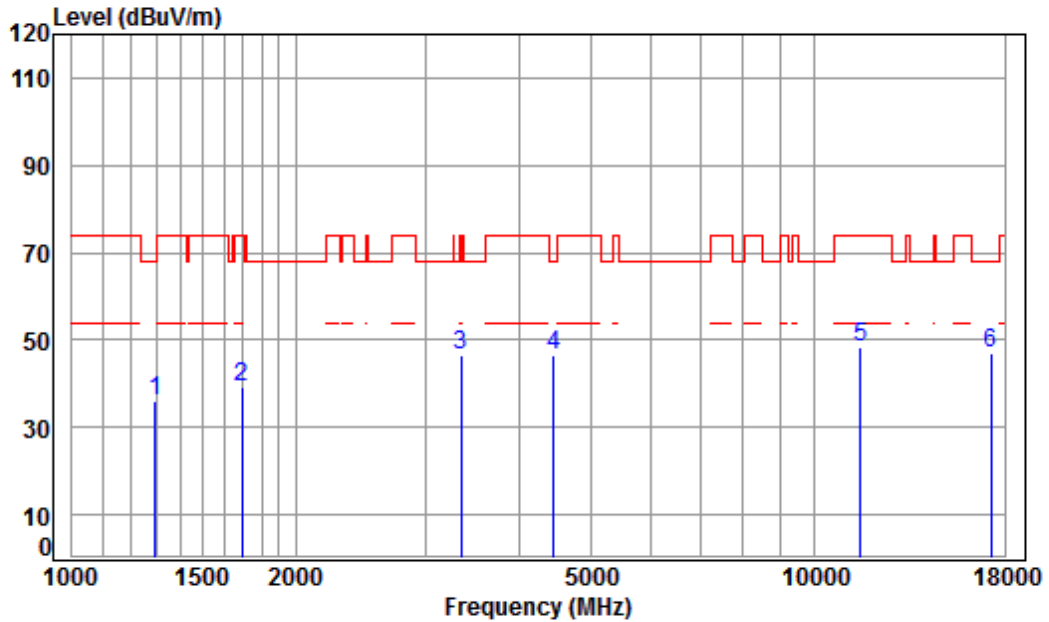

Condition: 3m HORIZONTAL
Job No : 04056CR/04057CR
Mode : 5755 TX RSE
Note : 5G WIFI 11N40

	Freq	Cable Loss	Ant Factor	Preamp Factor	Read Level	Level	Limit	Over	Remark
	MHz	dB	dB/m	dB	dBuV	dBuV/m	dBuV/m	dB	
1	1293.359	4.77	24.92	38.06	44.38	36.01	68.20	-32.19	peak
2	1692.231	5.24	26.64	38.02	45.20	39.06	74.00	-34.94	peak
3	3337.710	6.31	31.92	37.94	46.39	46.68	74.00	-27.32	peak
4	4456.315	7.51	33.60	38.24	43.67	46.54	68.20	-21.66	peak
5	11510.000	12.14	38.11	36.03	34.34	48.56	74.00	-25.44	peak
6	pp17265.000	16.12	43.12	36.16	23.83	46.91	68.20	-21.29	peak



Mode:h; Polarization:Vertical; Modulation:802.11n; bandwidth:40MHz; Channel:Low

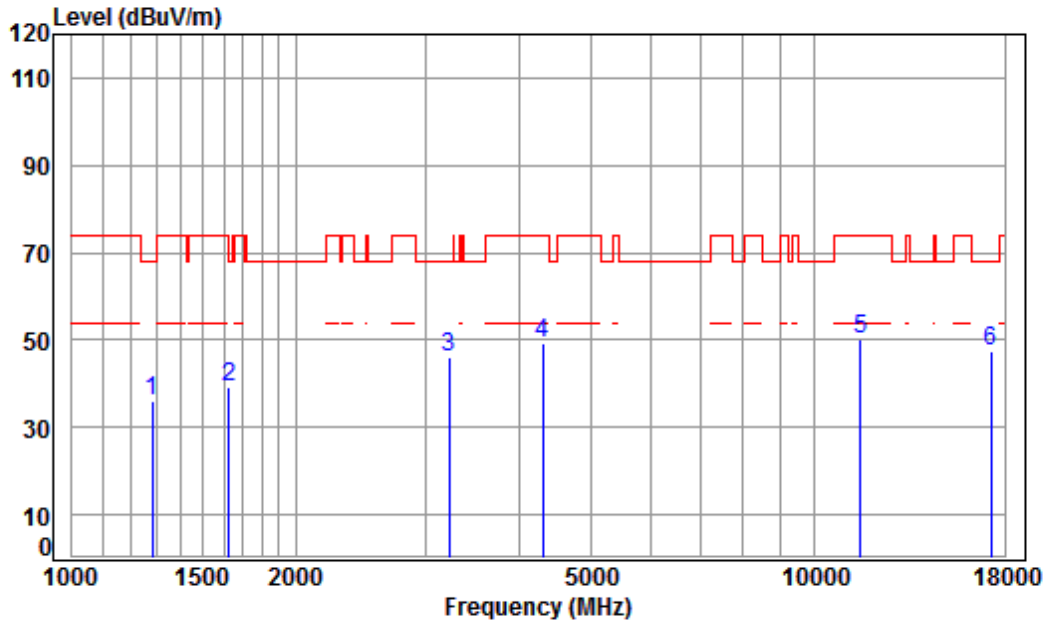

Condition: 3m VERTICAL
Job No : 04056CR/04057CR
Mode : 5755 TX RSE
Note : 5G WIFI 11N40

	Freq	Cable Loss	Ant Factor	Preamp Factor	Read Level	Level	Limit	Over	Remark
	MHz	dB	dB/m	dB	dBuV	dBuV/m	dBuV/m	dB	
1	1282.193	4.73	24.87	38.06	44.48	36.02	68.20	-32.18	peak
2	1625.121	5.32	26.36	38.03	45.51	39.16	74.00	-34.84	peak
3	3214.623	6.20	31.70	37.92	46.31	46.29	68.20	-21.91	peak
4	4304.400	7.34	33.60	38.16	46.68	49.46	74.00	-24.54	peak
5	11510.000	12.14	38.11	36.03	35.99	50.21	74.00	-23.79	peak
6	pp17265.000	16.12	43.12	36.16	24.60	47.68	68.20	-20.52	peak



Mode:h; Polarization:Horizontal; Modulation:802.11n; bandwidth:40MHz; Channel:High

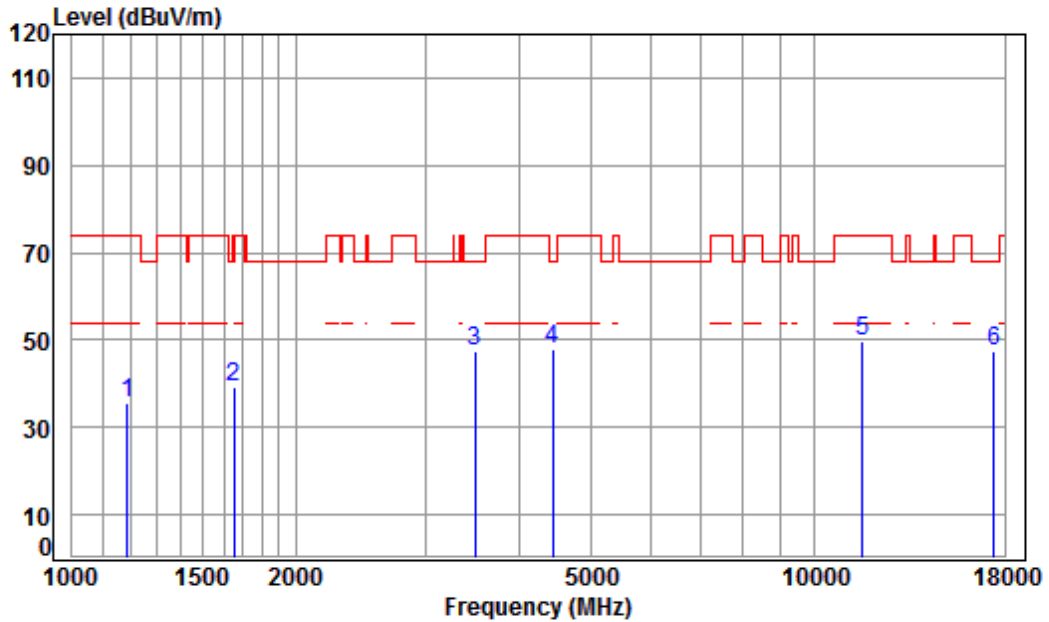

Condition: 3m HORIZONTAL
Job No : 04056CR/04057CR
Mode : 5795 TX RSE
Note : 5G WIFI 11N40

	Cable	Ant	Preamp	Read	Limit	Over		
Freq	Loss	Factor	Factor	Level	Level	Line	Limit	Remark
MHz	dB	dB/m	dB	dBuV	dBuV/m	dBuV/m	dB	
1	1189.368	4.38	24.43	38.07	44.90	35.64	74.00	-38.36 peak
2	1653.550	5.28	26.48	38.03	45.54	39.27	68.20	-28.93 peak
3	3485.601	6.45	32.18	37.95	46.86	47.54	68.20	-20.66 peak
4	pp 4443.453	7.50	33.60	38.24	44.92	47.78	68.20	-20.42 peak
5	11590.000	12.17	38.19	36.12	35.55	49.79	74.00	-24.21 peak
6	17385.000	15.85	43.26	36.10	24.34	47.35	68.20	-20.85 peak



Mode:h; Polarization:Vertical; Modulation:802.11n; bandwidth:40MHz; Channel:High

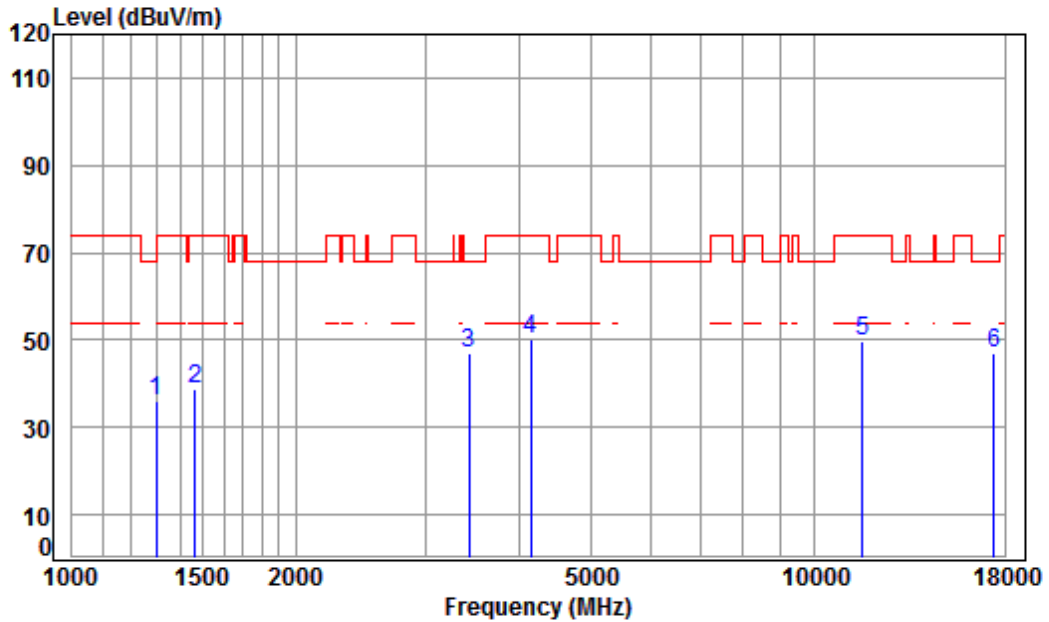

Condition: 3m VERTICAL
Job No : 04056CR/04057CR
Mode : 5795 TX RSE
Note : 5G WIFI 11N40

	Freq	Cable Loss	Ant Factor	Preamp Factor	Read Level	Limit Level	Over Limit	Remark
	MHz	dB	dB/m	dB	dBuV	dBuV/m	dBuV/m	dB
1	1300.858	4.80	24.96	38.06	44.54	36.24	74.00	-37.76 peak
2	1464.522	5.37	25.66	38.04	45.57	38.56	74.00	-35.44 peak
3 pp	3425.675	6.39	32.07	37.95	46.48	46.99	68.20	-21.21 peak
4	4145.664	7.16	33.60	38.08	47.44	50.12	74.00	-23.88 peak
5	11590.000	12.17	38.19	36.12	35.42	49.66	74.00	-24.34 peak
6	17385.000	15.85	43.26	36.10	23.90	46.91	68.20	-21.29 peak



Mode:h; Polarization:Horizontal; Modulation:802.11ac; bandwidth:20MHz; Channel:Low

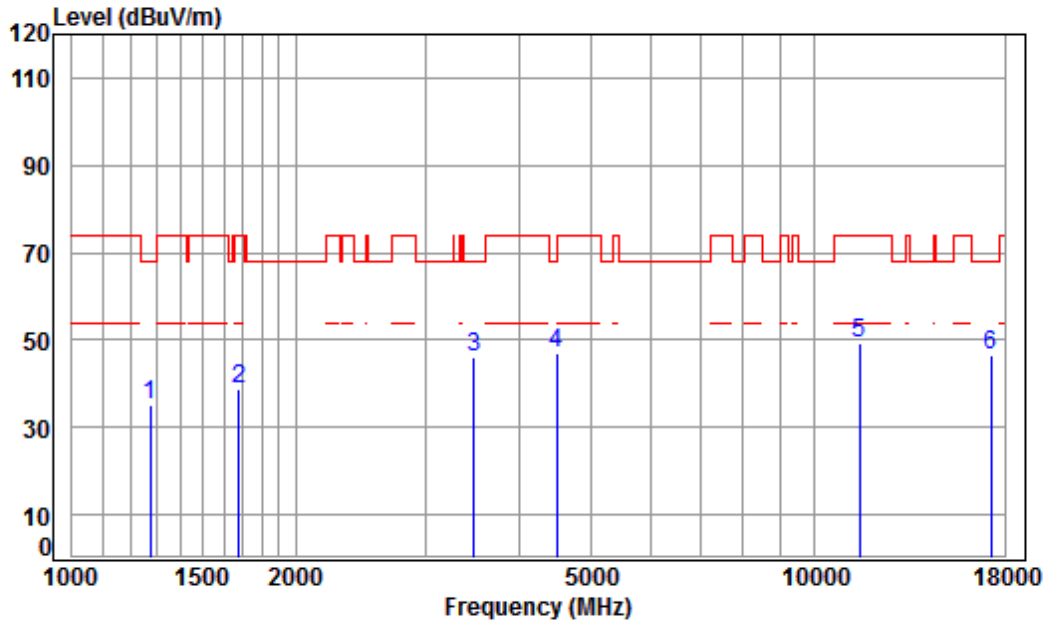

Condition: 3m HORIZONTAL
 Job No : 04056CR/04057CR
 Mode : 5745 TX RSE
 Note : 5G WIFI 11AC20

	Freq	Cable Loss	Ant Factor	Preamp Factor	Read Level	Level	Limit	Over	Remark
	MHz	dB	dB/m	dB	dBuV	dBuV/m	dBuV/m	dB	
1	1274.802	4.71	24.84	38.06	43.83	35.32	68.20	-32.88	peak
2	1677.621	5.25	26.58	38.03	44.99	38.79	74.00	-35.21	peak
3	3475.541	6.44	32.16	37.95	45.60	46.25	68.20	-21.95	peak
4	pp 4495.125	7.55	33.60	38.26	44.21	47.10	68.20	-21.10	peak
5	11490.000	12.13	38.09	36.00	35.21	49.43	74.00	-24.57	peak
6	17235.000	16.18	43.08	36.18	23.36	46.44	68.20	-21.76	peak



Mode:h; Polarization:Vertical; Modulation:802.11ac; bandwidth:20MHz; Channel:Low

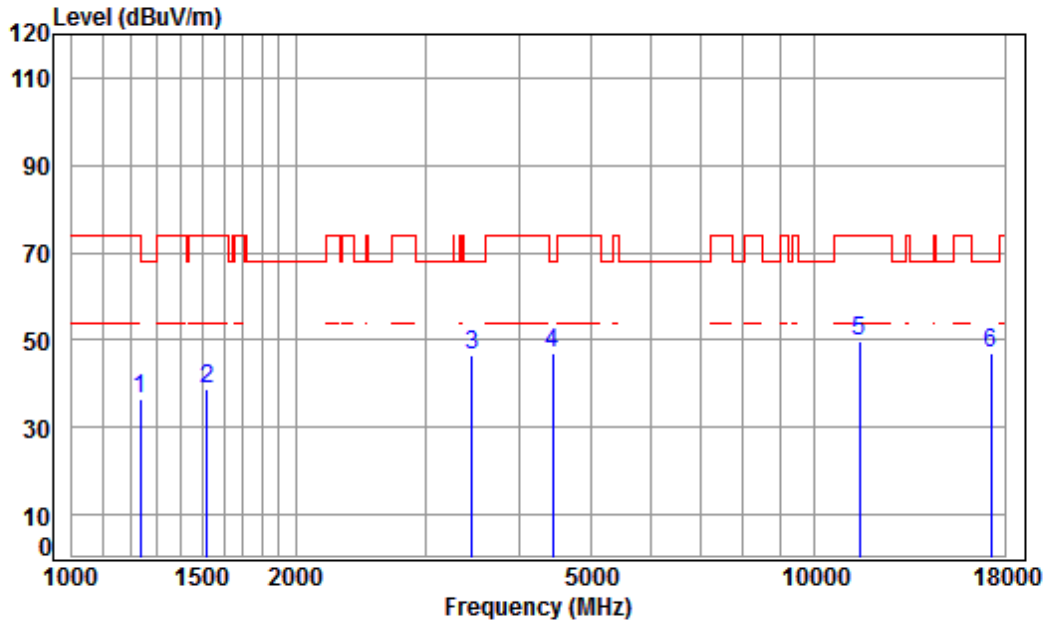

Condition: 3m VERTICAL
Job No : 04056CR/04057CR
Mode : 5745 TX RSE
Note : 5G WIFI 11AC20

	Freq	Cable Loss	Ant Factor	Preamp Factor	Read Level	Limit Level	Limit Line	Over Limit	Remark
	MHz	dB	dB/m	dB	dBuV	dBuV/m	dBuV/m	dB	
1	1234.909	4.55	24.65	38.07	45.24	36.37	74.00	-37.63	peak
2	1520.598	5.45	25.89	38.04	45.47	38.77	74.00	-35.23	peak
3	3455.508	6.42	32.13	37.95	45.74	46.34	68.20	-21.86	peak
4 pp	4443.453	7.50	33.60	38.24	44.25	47.11	68.20	-21.09	peak
5	11490.000	12.13	38.09	36.00	35.72	49.94	74.00	-24.06	peak
6	17235.000	16.18	43.08	36.18	23.98	47.06	68.20	-21.14	peak



Mode:h; Polarization:Horizontal; Modulation:802.11ac; bandwidth:20MHz; Channel:middle

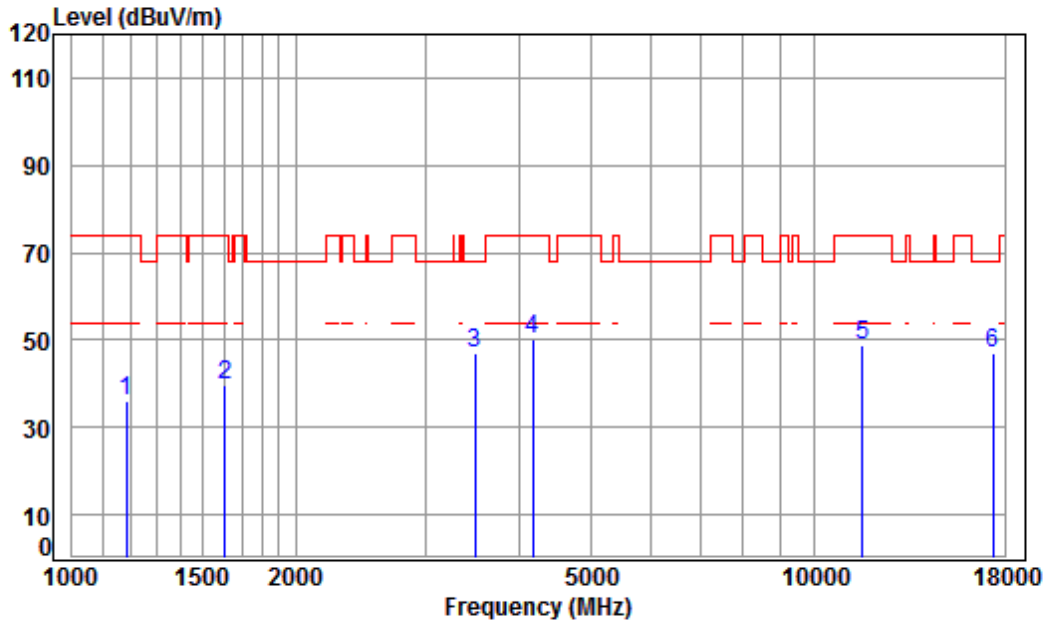

Condition: 3m HORIZONTAL
Job No : 04056CR/04057CR
Mode : 5785 TX RSE
Note : 5G WIFI 11AC20

	Freq	Cable Loss	Ant Factor	Preamp Factor	Read Level	Level	Limit	Over	Remark
	MHz	dB	dB/m	dB	dBuV	dBuV/m	dBuV/m	dB	
1	1185.936	4.36	24.41	38.08	45.29	35.98	74.00	-38.02	peak
2	1606.441	5.34	26.28	38.03	46.27	39.86	74.00	-34.14	peak
3	3485.601	6.45	32.18	37.95	46.20	46.88	68.20	-21.32	peak
4	4169.698	7.18	33.60	38.09	47.49	50.18	74.00	-23.82	peak
5	11570.000	12.17	38.17	36.10	34.64	48.88	74.00	-25.12	peak
6	pp17355.000	15.92	43.23	36.12	24.15	47.18	68.20	-21.02	peak



Mode:h; Polarization:Vertical; Modulation:802.11ac; bandwidth:20MHz; Channel:middle

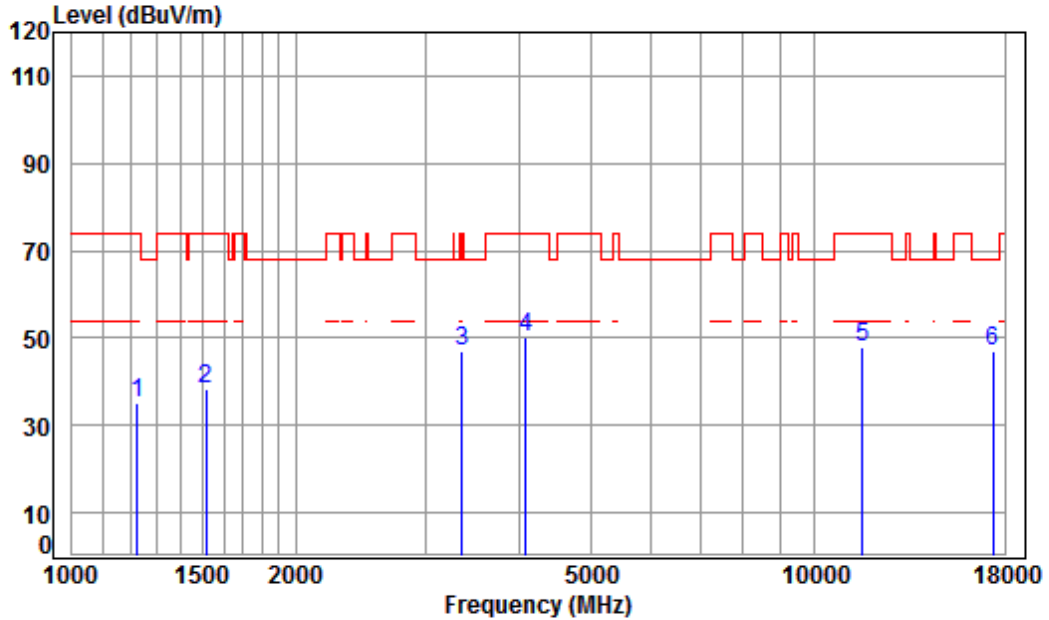

Condition: 3m VERTICAL
Job No : 04056CR/04057CR
Mode : 5785 TX RSE
Note : 5G WIFI 11AC20

	Freq	Cable Loss	Ant Factor	Preamp Factor	Read Level	Level	Limit	Over	Remark
	MHz	dB	dB/m	dB	dBuV	dBuV/m	dBuV/m	dB	
1	1224.247	4.51	24.60	38.07	43.88	34.92	74.00	-39.08	peak
2	1516.210	5.46	25.87	38.04	45.05	38.34	74.00	-35.66	peak
3	3347.371	6.32	31.94	37.94	46.54	46.86	74.00	-27.14	peak
4	4086.182	7.08	33.60	38.05	47.65	50.28	74.00	-23.72	peak
5	11570.000	12.17	38.17	36.10	33.79	48.03	74.00	-25.97	peak
6	pp17355.000	15.92	43.23	36.12	23.80	46.83	68.20	-21.37	peak



Mode:h; Polarization:Horizontal; Modulation:802.11ac; bandwidth:20MHz; Channel:High

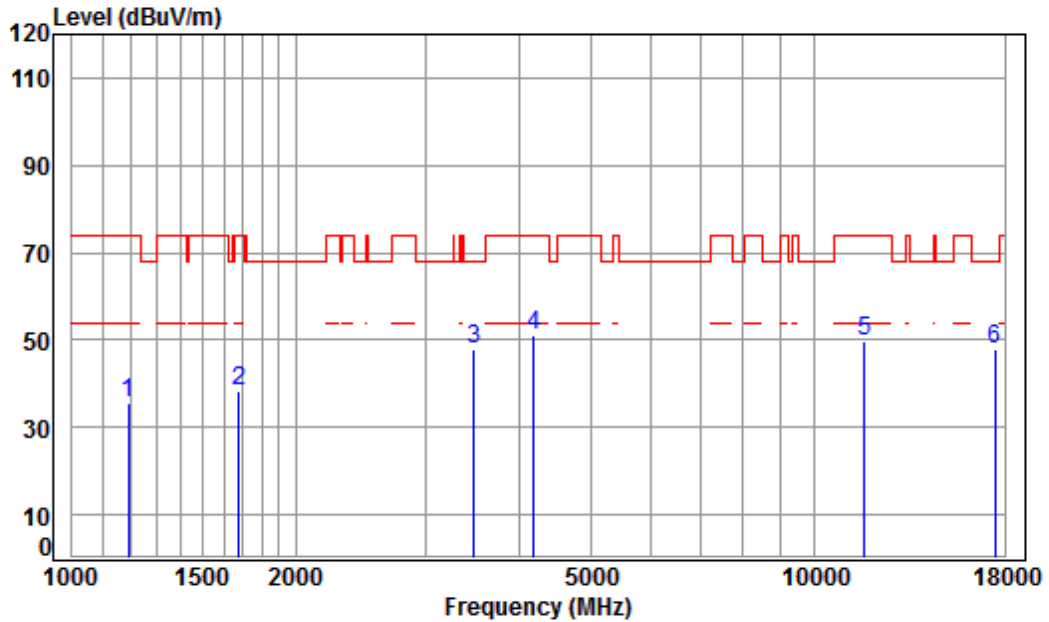

Condition: 3m HORIZONTAL
 Job No : 04056CR/04057CR
 Mode : 5825 TX RSE
 Note : 5G WIFI 11AC20

	Freq	Cable Loss	Ant Factor	Preamp Factor	Read Level	Level	Limit	Over	Remark
	MHz	dB	dB/m	dB	dBuV	dBuV/m	dBuV/m	dB	
1	1192.811	4.39	24.44	38.07	44.86	35.62	74.00	-38.38	peak
2	1677.621	5.25	26.58	38.03	44.73	38.53	74.00	-35.47	peak
3 pp	3475.541	6.44	32.16	37.95	47.12	47.77	68.20	-20.43	peak
4	4181.768	7.20	33.60	38.10	48.28	50.98	74.00	-23.02	peak
5	11650.000	12.20	38.25	36.19	35.25	49.51	74.00	-24.49	peak
6	17475.000	15.65	43.37	36.06	24.77	47.73	68.20	-20.47	peak



Mode:h; Polarization:Vertical; Modulation:802.11ac; bandwidth:20MHz; Channel:High

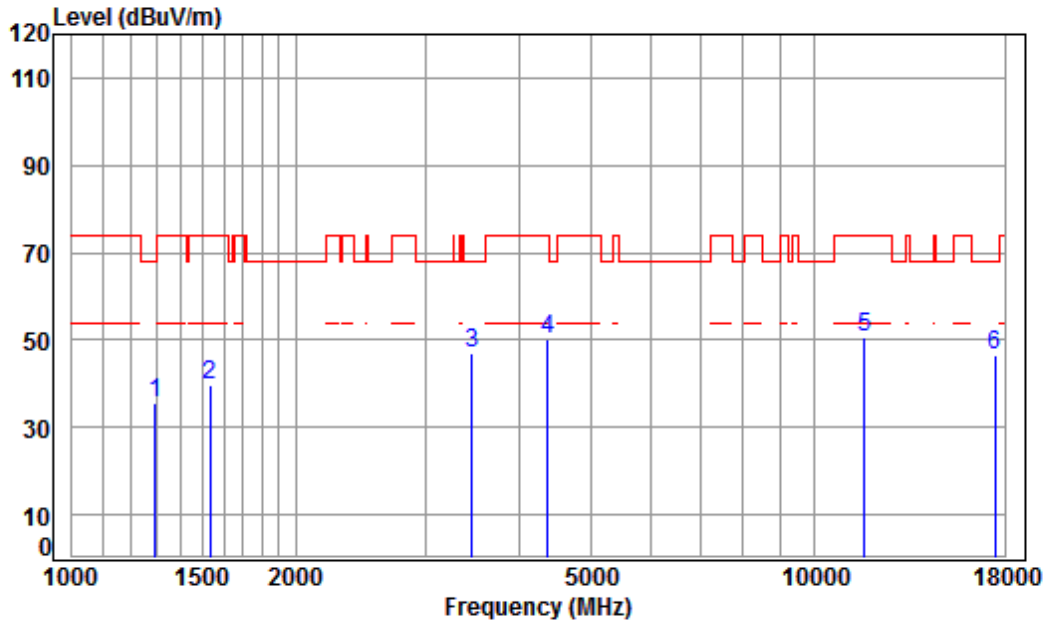

Condition: 3m VERTICAL
Job No : 04056CR/04057CR
Mode : 5825 TX RSE
Note : 5G WIFI 11AC20

	Freq	Cable Loss	Ant Factor	Preamp Factor	Read Level	Level	Limit	Over	Remark
	MHz	dB	dB/m	dB	dBuV	dBuV/m	dBuV/m	dB	
1	1293.359	4.77	24.92	38.06	43.84	35.47	68.20	-32.73	peak
2	1533.841	5.44	25.96	38.04	46.55	39.91	74.00	-34.09	peak
3 pp	3455.508	6.42	32.13	37.95	46.29	46.89	68.20	-21.31	peak
4	4367.058	7.41	33.60	38.20	47.30	50.11	74.00	-23.89	peak
5	11650.000	12.20	38.25	36.19	36.39	50.65	74.00	-23.35	peak
6	17475.000	15.65	43.37	36.06	23.41	46.37	68.20	-21.83	peak



Mode:h; Polarization:Horizontal; Modulation:802.11ac; bandwidth:40MHz; Channel:Low

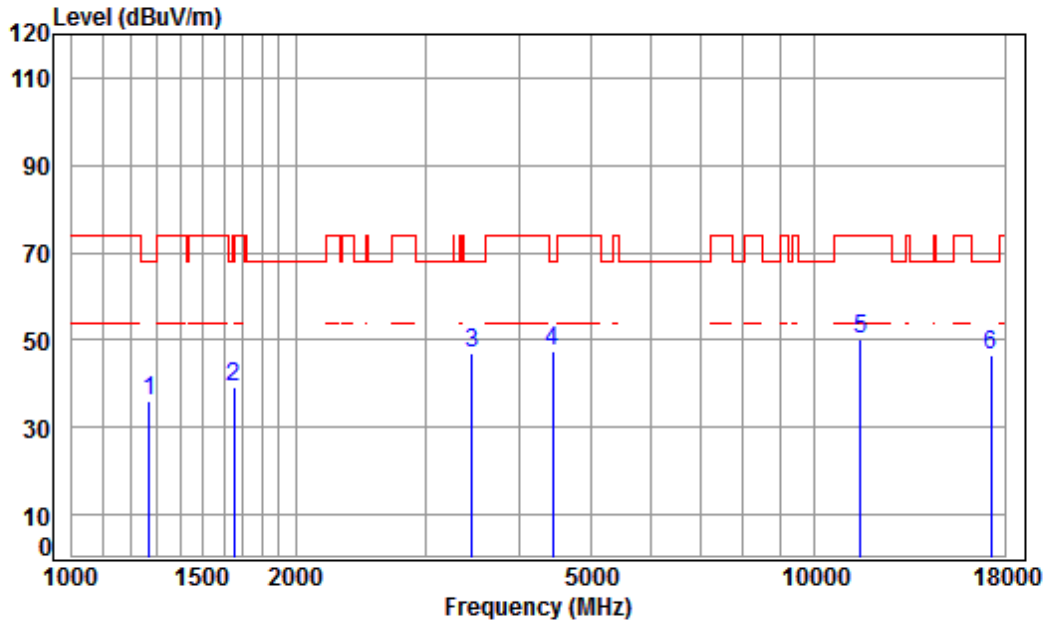

Condition: 3m HORIZONTAL
 Job No : 04056CR/04057CR
 Mode : 5755 TX RSE
 Note : 5G WIFI 11AC40

	Freq	Cable Loss	Ant Factor	Preamp Factor	Read Level	Level	Limit	Over	Remark
	MHz	dB	dB/m	dB	dBuV	dBuV/m	dBuV/m	dB	
1	1271.123	4.69	24.82	38.07	44.55	35.99	68.20	-32.21	peak
2	1653.550	5.28	26.48	38.03	45.67	39.40	68.20	-28.80	peak
3	3455.508	6.42	32.13	37.95	46.21	46.81	68.20	-21.39	peak
4	pp 4430.628	7.48	33.60	38.23	44.73	47.58	68.20	-20.62	peak
5	11510.000	12.14	38.11	36.03	36.16	50.38	74.00	-23.62	peak
6	17265.000	16.12	43.12	36.16	23.60	46.68	68.20	-21.52	peak



Mode:h; Polarization:Vertical; Modulation:802.11ac; bandwidth:40MHz; Channel:Low

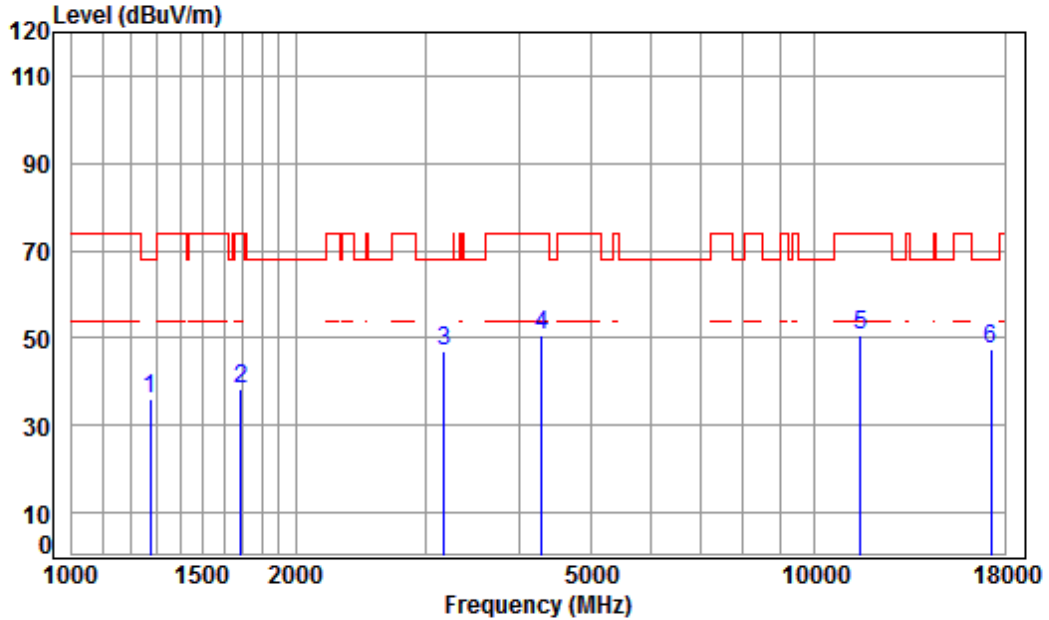

Condition: 3m VERTICAL
Job No : 04056CR/04057CR
Mode : 5755 TX RSE
Note : 5G WIFI 11AC40

	Freq	Cable Loss	Ant Factor	Preamp Factor	Read Level	Level	Limit	Over	Remark
	MHz	dB	dB/m	dB	dBuV	dBuV/m	dBuV/m	dB	
1	1274.802	4.71	24.84	38.06	44.66	36.15	68.20	-32.05	peak
2	1687.347	5.24	26.62	38.02	44.39	38.23	74.00	-35.77	peak
3	3168.500	6.15	31.62	37.92	47.31	47.16	68.20	-21.04	peak
4	4291.977	7.33	33.60	38.16	47.66	50.43	74.00	-23.57	peak
5	11510.000	12.14	38.11	36.03	36.33	50.55	74.00	-23.45	peak
6	pp17265.000	16.12	43.12	36.16	24.50	47.58	68.20	-20.62	peak



Mode:h; Polarization:Horizontal; Modulation:802.11ac; bandwidth:40MHz; Channel:High

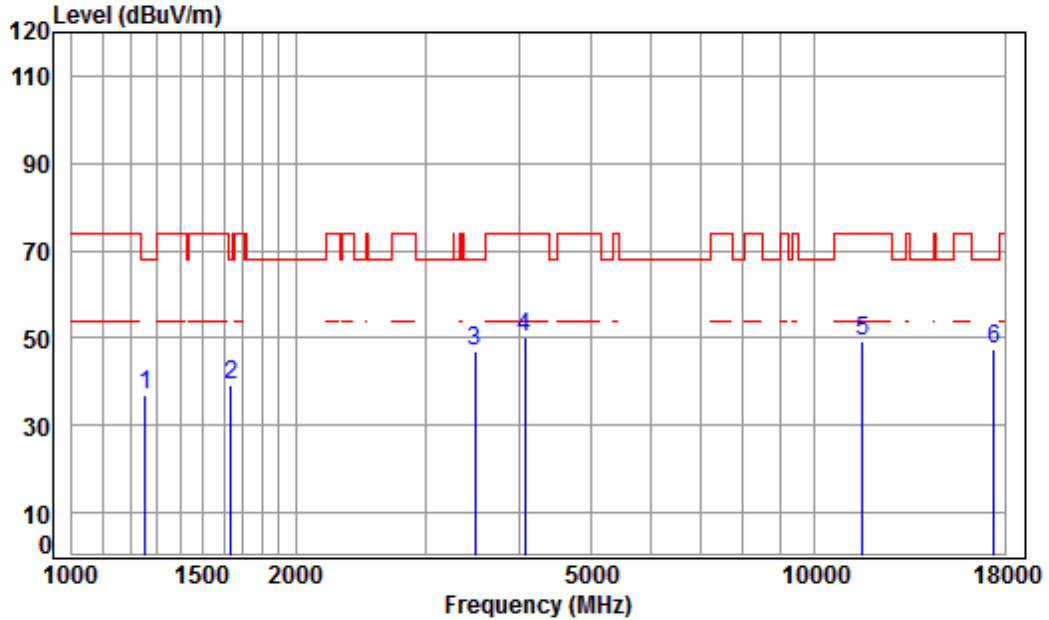

Condition: 3m HORIZONTAL
Job No : 04056CR/04057CR
Mode : 5795 TX RSE
Note : 5G WIFI 11AC40

	Freq	Cable Loss	Ant Factor	Preamp Factor	Read Level	Level	Limit	Over	Remark
	MHz	dB	dB/m	dB	dBuV	dBuV/m	dBuV/m	dB	
1	1256.512	4.64	24.75	38.07	45.44	36.76	68.20	-31.44	peak
2	1639.274	5.30	26.42	38.03	45.59	39.28	68.20	-28.92	peak
3	3485.601	6.45	32.18	37.95	46.25	46.93	68.20	-21.27	peak
4	4074.388	7.07	33.60	38.04	47.65	50.28	74.00	-23.72	peak
5	11590.000	12.17	38.19	36.12	35.03	49.27	74.00	-24.73	peak
6	pp17385.000	15.85	43.26	36.10	24.39	47.40	68.20	-20.80	peak



Mode:h; Polarization:Vertical; Modulation:802.11ac; bandwidth:40MHz; Channel:High

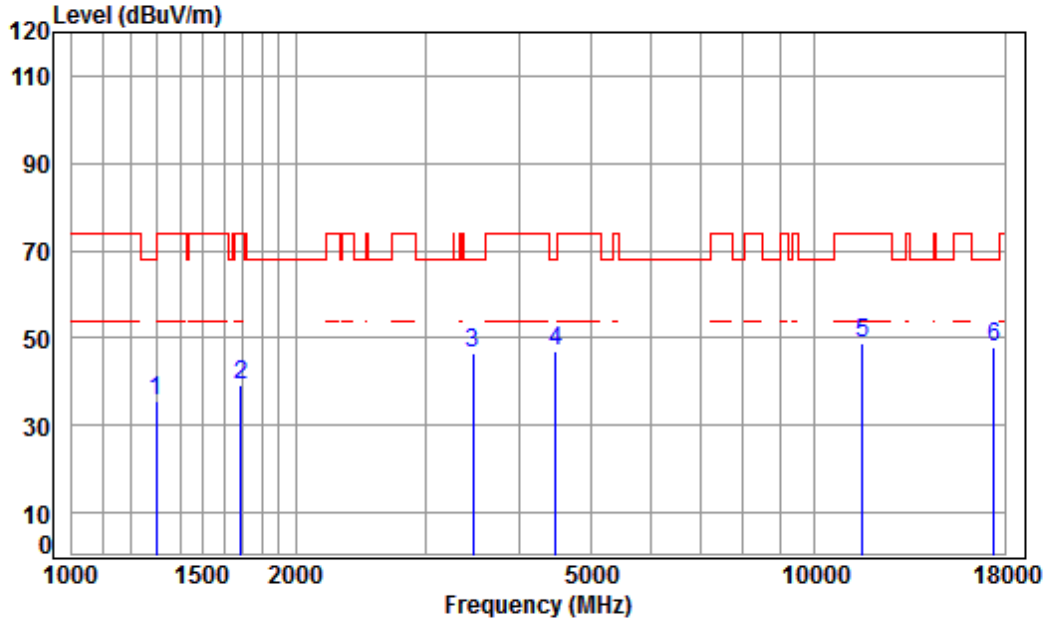

Condition: 3m VERTICAL
Job No : 04056CR/04057CR
Mode : 5795 TX RSE
Note : 5G WIFI 11AC40

	Freq	Cable Loss	Ant Factor	Preamp Factor	Read Level	Limit Level	Limit Line	Over Limit	Remark
	MHz	dB	dB/m	dB	dBuV	dBuV/m	dBuV/m	dB	
1	1297.103	4.79	24.94	38.06	44.01	35.68	68.20	-32.52	peak
2	1687.347	5.24	26.62	38.02	45.29	39.13	74.00	-34.87	peak
3	3465.510	6.43	32.14	37.95	46.01	46.63	68.20	-21.57	peak
4	4482.150	7.54	33.60	38.26	44.33	47.21	68.20	-20.99	peak
5	11590.000	12.17	38.19	36.12	34.80	49.04	74.00	-24.96	peak
6	pp17385.000	15.85	43.26	36.10	24.79	47.80	68.20	-20.40	peak



Mode:h; Polarization:Horizontal; Modulation:802.11ac; bandwidth:80MHz; Channel:middle

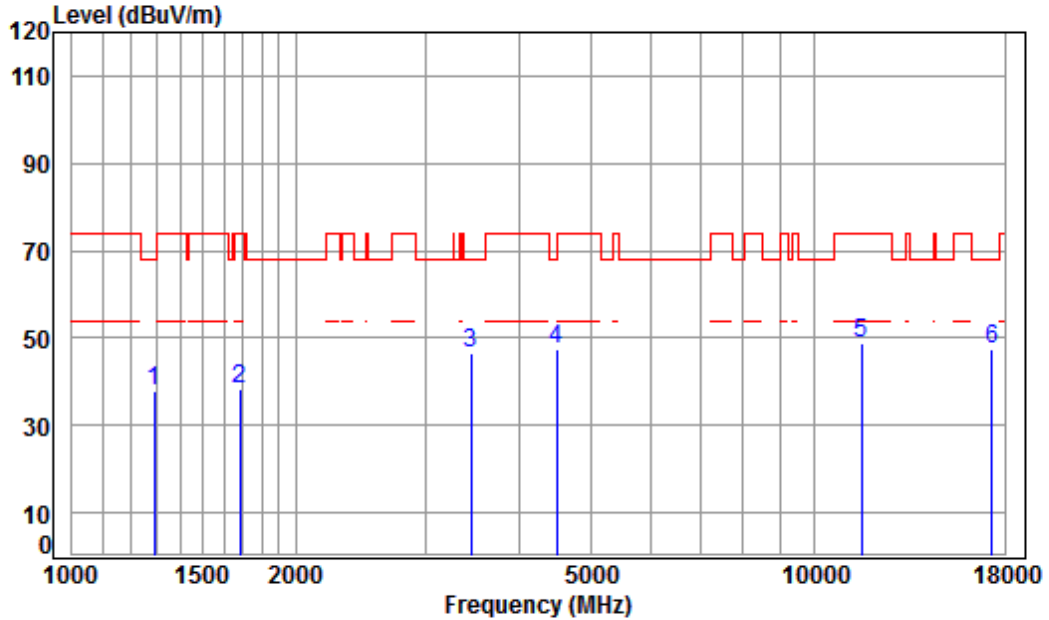

Condition: 3m HORIZONTAL
Job No : 04056CR/04057CR
Mode : 5775 TX RSE
Note : 5G WIFI 11AC80

	Freq	Cable Loss	Ant Factor	Preamp Factor	Read Level	Level	Limit	Over	Remark
	MHz	dB	dB/m	dB	dBuV	dBuV/m	dBuV/m	dB	
1	1289.627	4.76	24.91	38.06	46.24	37.85	68.20	-30.35	peak
2	1682.477	5.25	26.60	38.02	44.65	38.48	74.00	-35.52	peak
3	3445.535	6.41	32.11	37.95	46.03	46.60	68.20	-21.60	peak
4	4495.125	7.55	33.60	38.26	44.53	47.42	68.20	-20.78	peak
5	11550.000	12.16	38.15	36.07	34.71	48.95	74.00	-25.05	peak
6	pp17325.000	15.98	43.19	36.13	24.44	47.48	68.20	-20.72	peak



Mode:h; Polarization:Vertical; Modulation:802.11ac; bandwidth:80MHz; Channel:middle

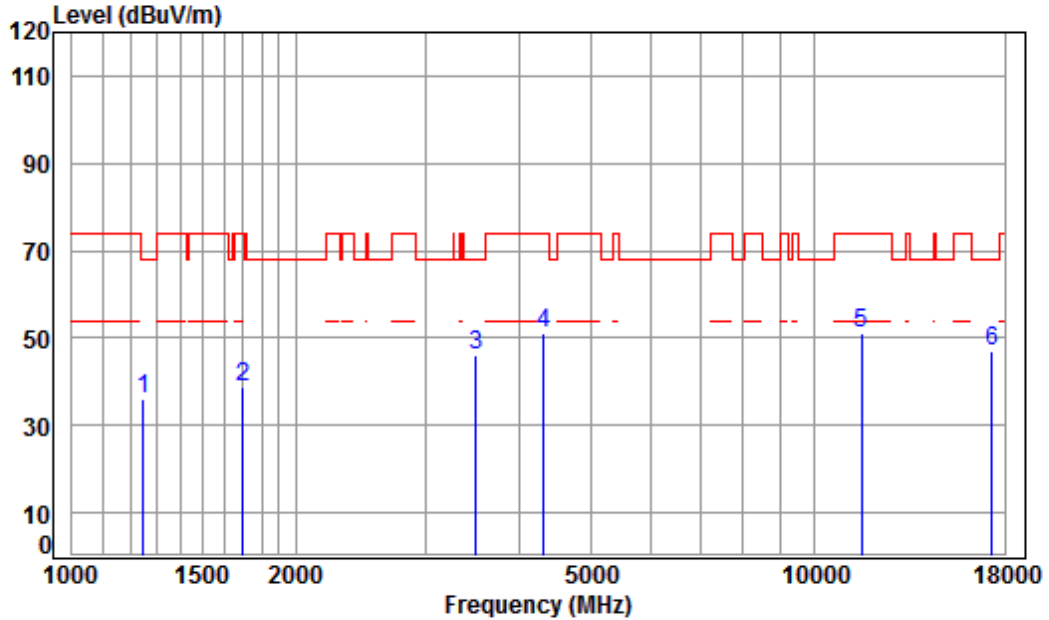

Condition: 3m VERTICAL
Job No : 04056CR/04057CR
Mode : 5775 TX RSE
Note : 5G WIFI 11AC80

	Freq	Cable Loss	Ant Factor	Preamplifier	Read Level	Limit Level	Over Limit	Remark
	MHz	dB	dB/m	dB	dBuV	dBuV/m	dBuV/m	dB
1	1249.269	4.61	24.72	38.07	44.94	36.20	68.20	-32.00 peak
2	1697.129	5.23	26.66	38.02	44.79	38.66	74.00	-35.34 peak
3	3495.691	6.46	32.19	37.95	45.35	46.05	68.20	-22.15 peak
4	4316.859	7.36	33.60	38.17	48.19	50.98	74.00	-23.02 peak
5	11550.000	12.16	38.15	36.07	36.90	51.14	74.00	-22.86 peak
6	pp17325.000	15.98	43.19	36.13	23.98	47.02	68.20	-21.18 peak



7.12 Radiated Emissions which fall in the restricted bands

Test Requirement 47 CFR Part 15, Subpart C 15.209 & 15.407(b)
Test Method: KDB 789033 D02 II G
Measurement Distance: 3m
Limit:

Frequency(MHz)	Field strength(microvolts/meter)	Measurement distance(meters)
0.009-0.490	2400/F(kHz)	300
0.490-1.705	24000/F(kHz)	30
1.705-30.0	30	30
30-88	100	3
88-216	150	3
216-960	200	3
Above 960	500	3

*(1) For transmitters operating in the 5.15-5.25 GHz band: All emissions outside of the 5.15-5.35 GHz band shall not exceed an e.i.r.p. of -27 dBm/MHz.

(2) For transmitters operating in the 5.25-5.35 GHz band: All emissions outside of the 5.15-5.35 GHz band shall not exceed an e.i.r.p. of -27 dBm/MHz.

(3) For transmitters operating in the 5.47-5.725 GHz band: All emissions outside of the 5.47-5.725 GHz band shall not exceed an e.i.r.p. of -27 dBm/MHz.

(4) For transmitters operating in the 5.725-5.85 GHz band:

(i) All emissions shall be limited to a level of -27 dBm/MHz at 75 MHz or more above or below the band edge increasing linearly to 10 dBm/MHz at 25 MHz above or below the band edge, and from 25 MHz above or below the band edge increasing linearly to a level of 15.6 dBm/MHz at 5 MHz above or below the band edge, and from 5 MHz above or below the band edge increasing linearly to a level of 27 dBm/MHz at the band edge.

Remark: The emission limits shown in the above table are based on measurements employing a CISPR quasi-peak detector except for the frequency bands 9-90kHz, 110-490kHz and above 1000 MHz. Radiated emission limits in these three bands are based on measurements employing an average detector, the peak field strength of any emission shall not exceed the maximum permitted average limits specified above by more than 20 dB under any condition of modulation.

7.12.1 E.U.T. Operation

Operating Environment:

Temperature: 24.2 °C Humidity: 57.6 % RH Atmospheric Pressure: 1015 mbar

Pretest these modes to find the worst case:

e:TX mode (Band 1)_Keep the EUT in continuously transmitting mode with all modulation types. All data rates for each modulation type have been tested and found the data rate @ 6Mbps is the worst case of IEEE 802.11a; data rate @ MCS0 is the worst case of IEEE 802.11n(HT20); data rate @ MCS0 is the worst case of IEEE 802.11n(HT40); data rate @ MCS0 is the worst case of IEEE 802.11ac(VHT20); data rate @ MCS0 is the worst case of IEEE 802.11ac(VHT40); data rate @ MCS0 is the worst case of IEEE 802.11ac(VHT80). Only the data of worst case is recorded in the report.

f:TX mode (Band 2A)_Keep the EUT in continuously transmitting mode with all modulation types. All data rates for each modulation type have been tested and found the data rate @ 6Mbps is the worst case of IEEE 802.11a; data rate @ MCS0 is the worst case of IEEE 802.11n(HT20); data rate @ MCS0 is the worst case of IEEE 802.11n(HT40); data rate @ MCS0 is the worst case of IEEE 802.11ac(VHT20); data rate @ MCS0 is the worst case of IEEE 802.11ac(VHT40); data rate @ MCS0 is the worst case of IEEE 802.11ac(VHT80). Only the data of worst case is recorded in the report.

g:TX mode (Band 2C)_Keep the EUT in continuously transmitting mode with all modulation types. All data rates for each modulation type have been tested and found the data rate @ 6Mbps is the worst case of IEEE 802.11a; data rate @ MCS0 is the worst case of IEEE 802.11n(HT20); data rate @ MCS0 is the worst case of IEEE 802.11n(HT40); data rate @ MCS0 is the worst case of IEEE 802.11ac(VHT20); data rate @ MCS0 is the worst case of IEEE 802.11ac(VHT40); data rate @ MCS0 is the worst case of IEEE 802.11ac(VHT80). Only the data of worst case is recorded in the report.

h:TX mode (Band 3)_Keep the EUT in continuously transmitting mode with all modulation types. All data rates for each modulation type have been tested and found the data rate @ 6Mbps is the worst case of IEEE 802.11a; data rate @ MCS0 is the worst case of IEEE 802.11n(HT20); data rate @ MCS0 is the worst case of IEEE 802.11n(HT40); data rate @ MCS0 is the worst case of IEEE 802.11ac(VHT20); data rate @ MCS0 is the worst case of IEEE 802.11ac(VHT40); data rate @ MCS0 is the worst case of IEEE 802.11ac(VHT80). Only the data of worst case is recorded in the report.

The worst case for final test:

e:TX mode (Band 1)_Keep the EUT in continuously transmitting mode with all modulation types. All data rates for each modulation type have been tested and found the data rate @ 6Mbps is the worst case of IEEE 802.11a; data rate @ MCS0 is the worst case of IEEE 802.11n(HT20); data rate @ MCS0 is the worst case of IEEE 802.11n(HT40); data rate @ MCS0 is the worst case of IEEE 802.11ac(VHT20); data rate @ MCS0 is the worst case of IEEE 802.11ac(VHT40); data rate @ MCS0 is the worst case of IEEE 802.11ac(VHT80). Only the data of worst case is recorded in the report.

f:TX mode (Band 2A)_Keep the EUT in continuously transmitting mode with all modulation types. All data rates for each modulation type have been tested and found the data rate @ 6Mbps is the worst case of IEEE 802.11a; data rate @ MCS0 is the worst case of IEEE 802.11n(HT20); data rate @ MCS0 is the worst case of IEEE 802.11n(HT40); data rate @ MCS0 is the worst case of IEEE 802.11ac(VHT20); data rate @ MCS0 is the worst case of IEEE 802.11ac(VHT40); data rate @ MCS0 is the worst case of IEEE 802.11ac(VHT80). Only the data of worst case is recorded in the report.

g:TX mode (Band 2C)_Keep the EUT in continuously transmitting mode with all

modulation types. All data rates for each modulation type have been tested and found the data rate @ 6Mbps is the worst case of IEEE 802.11a; data rate @ MCS0 is the worst case of IEEE 802.11n(HT20); data rate @ MCS0 is the worst case of IEEE 802.11n(HT40); data rate @ MCS0 is the worst case of IEEE 802.11ac(VHT20); data rate @ MCS0 is the worst case of IEEE 802.11ac(VHT40); data rate @ MCS0 is the worst case of IEEE 802.11ac(VHT80). Only the data of worst case is recorded in the report.

h:TX mode (Band 3)_Keep the EUT in continuously transmitting mode with all modulation types. All data rates for each modulation type have been tested and found the data rate @ 6Mbps is the worst case of IEEE 802.11a; data rate @ MCS0 is the worst case of IEEE 802.11n(HT20); data rate @ MCS0 is the worst case of IEEE 802.11n(HT40); data rate @ MCS0 is the worst case of IEEE 802.11ac(VHT20); data rate @ MCS0 is the worst case of IEEE 802.11ac(VHT40); data rate @ MCS0 is the worst case of IEEE 802.11ac(VHT80). Only the data of worst case is recorded in the report.

7.12.2 Test Setup Diagram

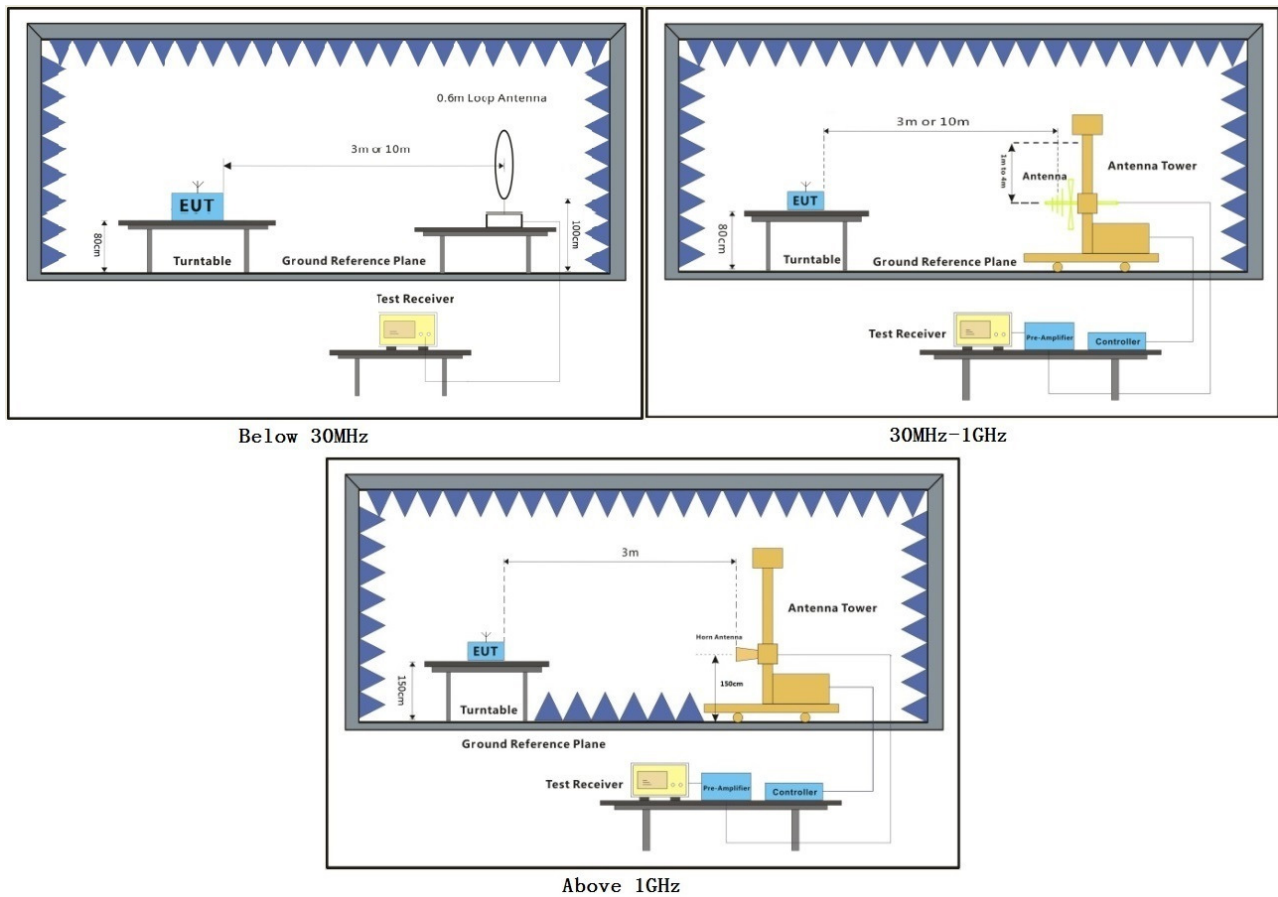

7.12.3 Measurement Procedure and Data

- a. For below 1GHz, the EUT was placed on the top of a rotating table 0.8 meters above the ground at a 3 or 10 meter semi-anechoic chamber. The table was rotated 360 degrees to determine the position of the highest radiation.
- b. For above 1GHz, the EUT was placed on the top of a rotating table 1.5 meters above the ground at a 3 meter fully-anechoic chamber. The table was rotated 360 degrees to determine the position of the highest radiation.
- c. The EUT was set 3 or 10 meters away from the interference-receiving antenna, which was mounted on the top of a variable-height antenna tower.
- d. The antenna height is varied from one meter to four meters above the ground to determine the maximum value of the field strength. Both horizontal and vertical polarizations of the antenna are set to make the measurement.
- e. For each suspected emission, the EUT was arranged to its worst case and then the antenna was tuned to heights from 1 meter to 4 meters (for the test frequency of below 30MHz, the antenna was tuned to heights 1 meter) and the rotatable table was turned from 0 degrees to 360 degrees to find the maximum reading.
- f. The test-receiver system was set to Peak Detect Function and Specified Bandwidth with Maximum Hold Mode.
- g. If the emission level of the EUT in peak mode was 10dB lower than the limit specified, then testing could be stopped and the peak values of the EUT would be reported. Otherwise the emissions that did not have 10dB margin would be re-tested one by one using peak, quasi-peak or average method as specified and then reported in a data sheet.
- h. Test the EUT in the lowest channel, the middle channel, the Highest channel.
- i. The radiation measurements are performed in X, Y, Z axis positioning for Transmitting mode, and found the X axis positioning which it is the worst case.
- j. Repeat above procedures until all frequencies measured was complete.

Remark: Level= Read Level+ Cable Loss+ Antenna Factor- Preamp Factor

Pretest the EUT at antenna 1 and antenna 2 and found the antenna 2 which is worst case for 802.11a mode, Pretest the EUT at antenna 1, antenna 2 and MIMO mode and found the MIMO mode which is worst case for 802.11n/ac mode; So, Only the worst test data is recorded in the report.

Transmitter emission above 1GHz

Mode:e; Polarization:Horizontal; Modulation:802.11a; bandwidth:20MHz; Channel:Low

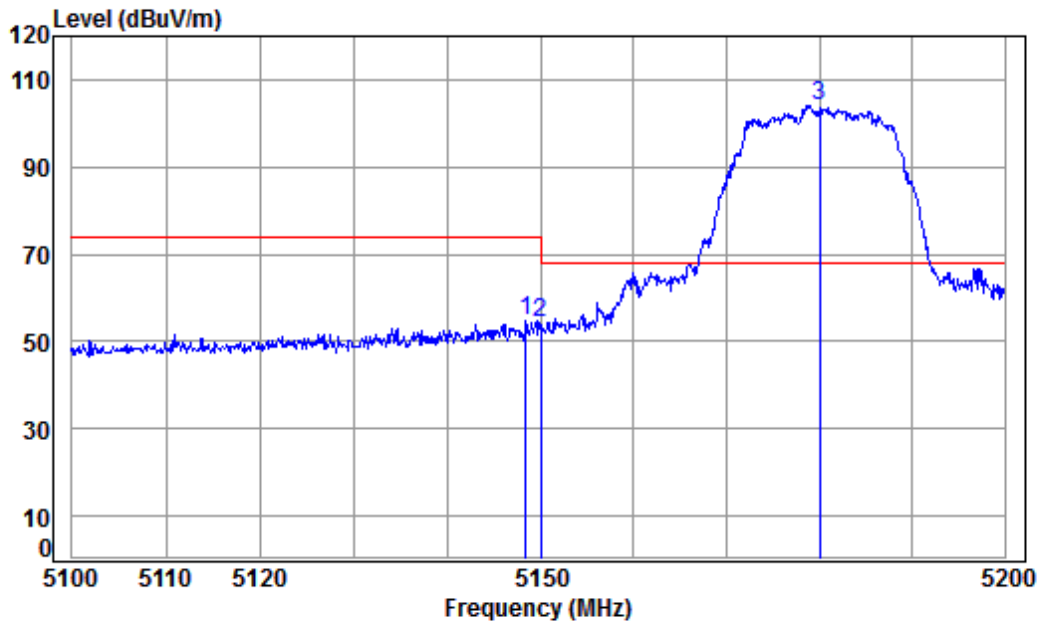

Condition: 3m HORIZONTAL
 Job No : 04056CR/04057CR
 Mode : 5180 Band edge
 : 5G WIFI 11A

	Freq	Cable Loss	Ant Factor	Preamp Factor	Read Level	Level	Limit Line	Over Limit	Remark
	MHz	dB	dB/m	dB	dBuV	dBuV/m	dBuV/m	dB	
1	5148.458	8.32	34.32	42.36	54.67	54.95	74.00	-19.05	peak
2	5149.980	8.33	34.32	42.36	54.14	54.43	74.00	-19.57	peak
3	pp 5180.000	8.37	34.35	42.33	103.77	104.16	68.20	35.96	peak



Mode:e; Polarization:Horizontal; Modulation:802.11a; bandwidth:20MHz; Channel:Low

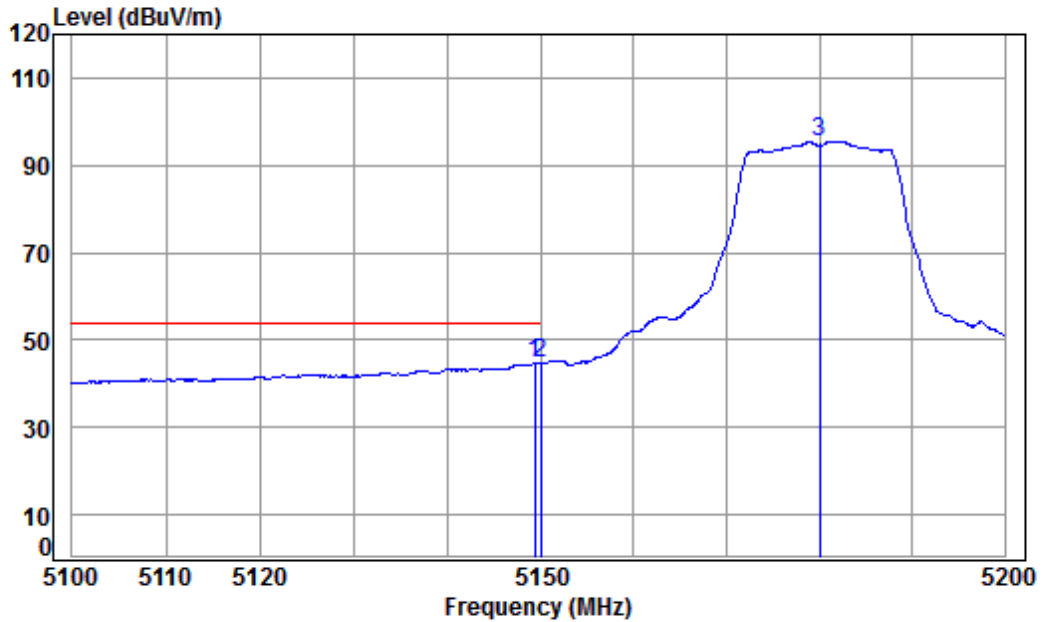

Condition: 3m HORIZONTAL
Job No : 04056CR/04057CR
Mode : 5180 Band edge
: 5G WIFI 11A

		Cable	Ant	Preamp	Read	Limit	Over		
	Freq	Loss	Factor	Factor	Level	Level	Line	Limit	Remark
	MHz	dB	dB/m	dB	dBuV	dBuV/m	dBuV/m	dB	
1	pp 5149.357	8.32	34.32	42.36	44.46	44.74	54.00	-9.26	Average
2	5149.980	8.33	34.32	42.36	44.44	44.73	54.00	-9.27	Average
3	5180.000	8.37	34.35	42.33	95.13	95.52	-----	-----	Average



Mode:e; Polarization:Vertical; Modulation:802.11a; bandwidth:20MHz; Channel:Low

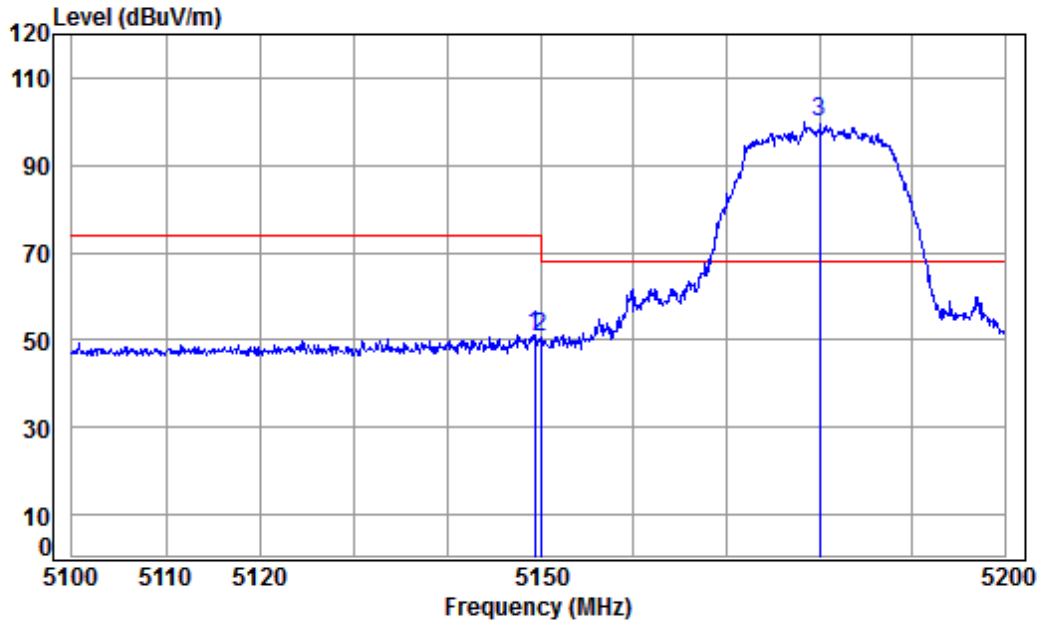

Condition: 3m VERTICAL
Job No : 04056CR/04057CR
Mode : 5180 Band edge
: 5G WIFI 11A

	Freq	Cable Loss	Ant Factor	Preamp Factor	Read Level	Limit Level	Limit Line	Over Limit	Remark
	MHz	dB	dB/m	dB	dBuV	dBuV/m	dBuV/m	dB	
1	5149.357	8.32	34.32	42.36	50.84	51.12	74.00	-22.88	Peak
2	5149.980	8.33	34.32	42.36	50.25	50.54	74.00	-23.46	Peak
3 pp	5180.000	8.37	34.35	42.33	99.40	99.79	68.20	31.59	Peak



Mode:e; Polarization:Vertical; Modulation:802.11a; bandwidth:20MHz; Channel:Low

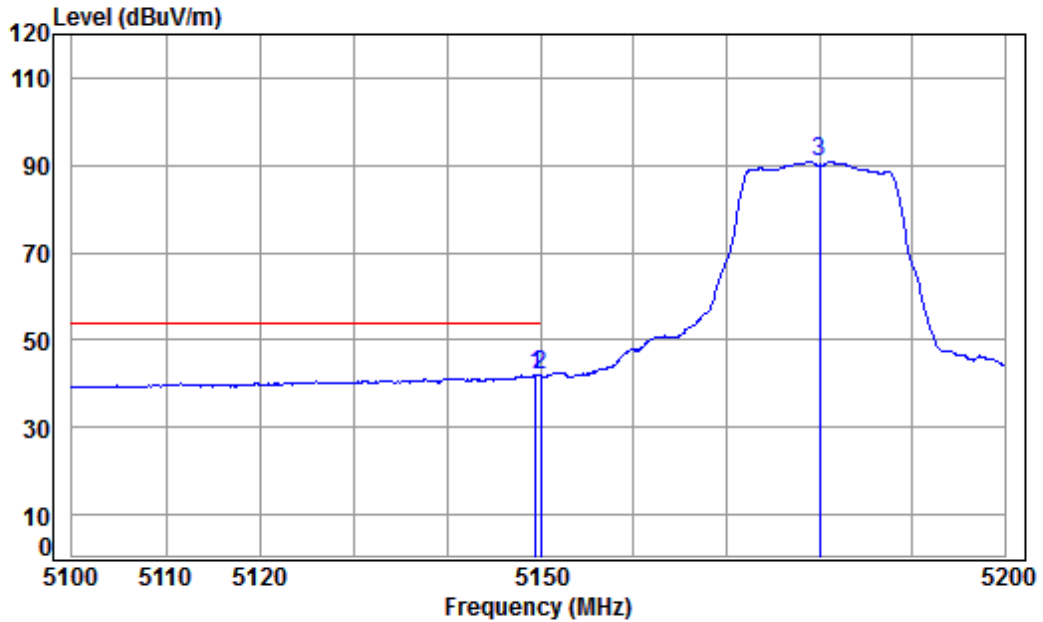

Condition: 3m VERTICAL
Job No : 04056CR/04057CR
Mode : 5180 Band edge
: 5G WIFI 11A

	Freq	Cable Loss	Ant Factor	Preamp Factor	Read Level	Limit Level	Over Limit	Remark
	MHz	dB	dB/m	dB	dBuV	dBuV/m	dB	
1	5149.458	8.32	34.32	42.36	41.52	54.00	-12.20	Average
2 pp	5149.980	8.33	34.32	42.36	41.56	54.00	-12.15	Average
3	5180.000	8.37	34.35	42.33	90.38	-----	-----	Average



Mode:e; Polarization:Horizontal; Modulation:802.11a; bandwidth:20MHz; Channel:High

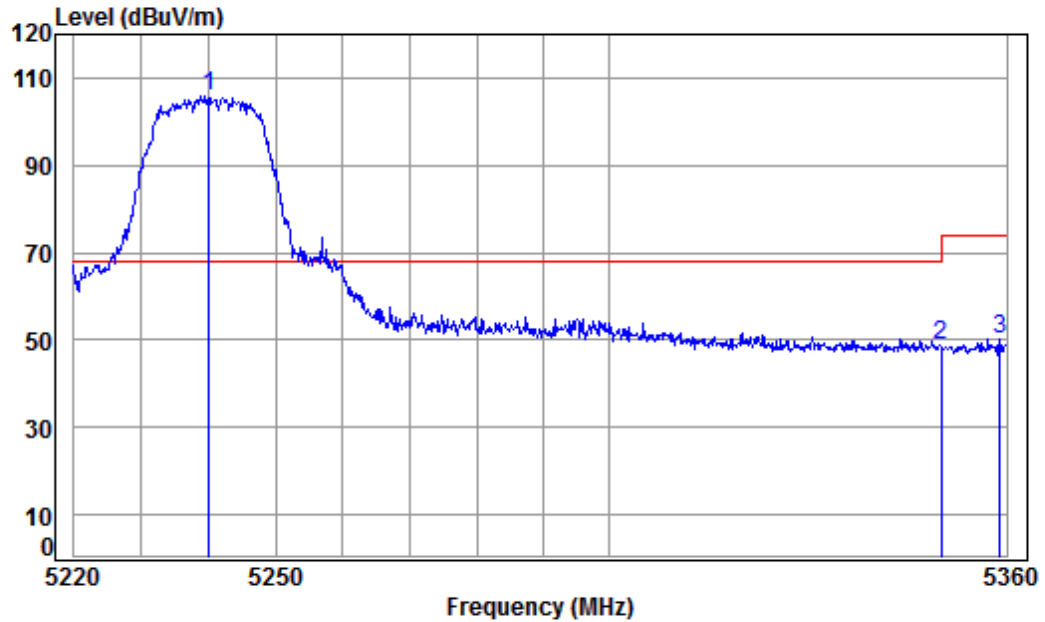

Condition: 3m HORIZONTAL
Job No : 04056CR/04057CR
Mode : 5240 Band edge
: 5G WIFI 11A

		Cable	Ant	Preamp	Read	Limit	Over		
	Freq	Loss	Factor	Factor	Level	Level	Line	Limit	Remark
	MHz	dB	dB/m	dB	dBuV	dBuV/m	dBuV/m	dB	
1	pp 5240.000	8.46	34.40	42.27	105.37	105.96	68.20	37.76	peak
2	5350.020	8.63	34.48	42.17	47.69	48.63	74.00	-25.37	peak
3	5359.007	8.64	34.49	42.16	49.10	50.07	74.00	-23.93	peak



Mode:e; Polarization:Horizontal; Modulation:802.11a; bandwidth:20MHz; Channel:High

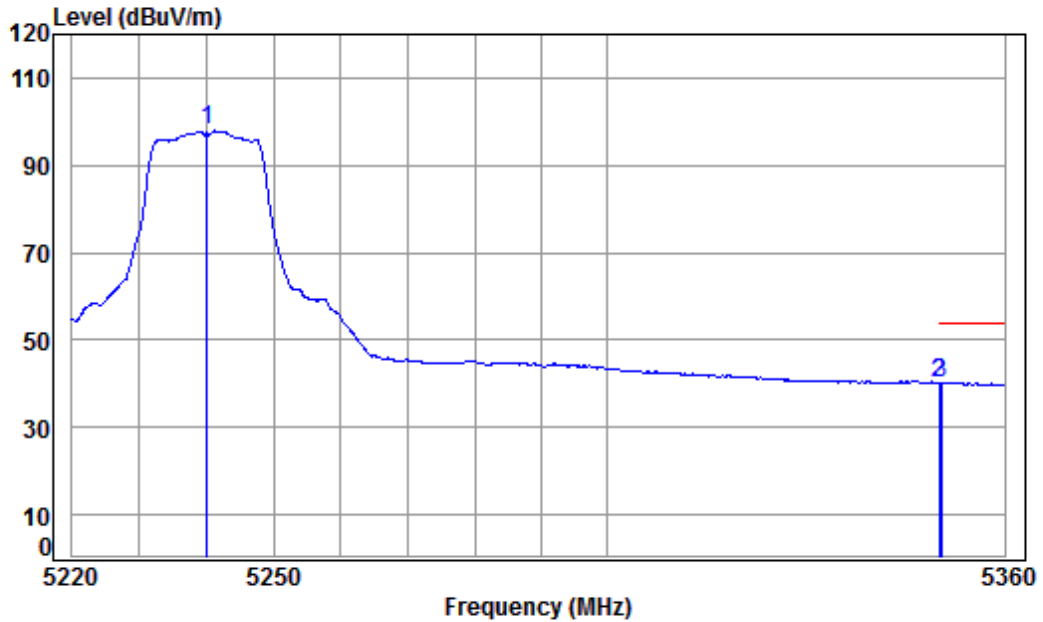

Condition: 3m HORIZONTAL
Job No : 04056CR/04057CR
Mode : 5240 Band edge
: 5G WIFI 11A

	Freq	Cable Loss	Ant Factor	Preamp Factor	Read Level	Level	Limit Line	Over Limit	Remark
	MHz	dB	dB/m	dB	dBuV	dBuV/m	dBuV/m	dB	
1	5240.000	8.46	34.40	42.27	97.32	97.91	-----	-----	Average
2	pp 5350.020	8.63	34.48	42.17	39.24	40.18	54.00	-13.82	Average
3	5350.362	8.63	34.48	42.17	39.23	40.17	54.00	-13.83	Average

Mode:e; Polarization:Vertical; Modulation:802.11a; bandwidth:20MHz; Channel:High

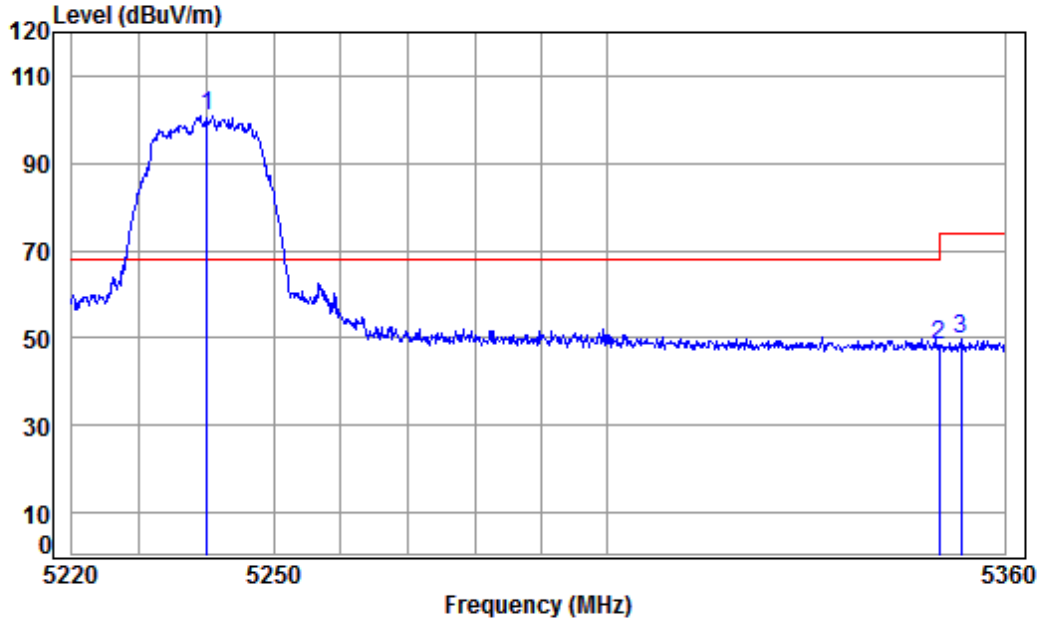

Condition: 3m VERTICAL
 Job No : 04056CR/04057CR
 Mode : 5240 Band edge
 : 5G WIFI 11A

		Cable	Ant	Preamp	Read	Limit	Over		
	Freq	Loss	Factor	Factor	Level	Level	Line	Limit	Remark
	MHz	dB	dB/m	dB	dBuV	dBuV/m	dBuV/m	dB	
1	pp 5240.000	8.46	34.40	42.27	100.30	100.89	68.20	32.69	Peak
2	5350.020	8.63	34.48	42.17	47.35	48.29	74.00	-25.71	Peak
3	5353.337	8.63	34.49	42.17	48.94	49.89	74.00	-24.11	Peak



Mode:e; Polarization:Vertical; Modulation:802.11a; bandwidth:20MHz; Channel:High

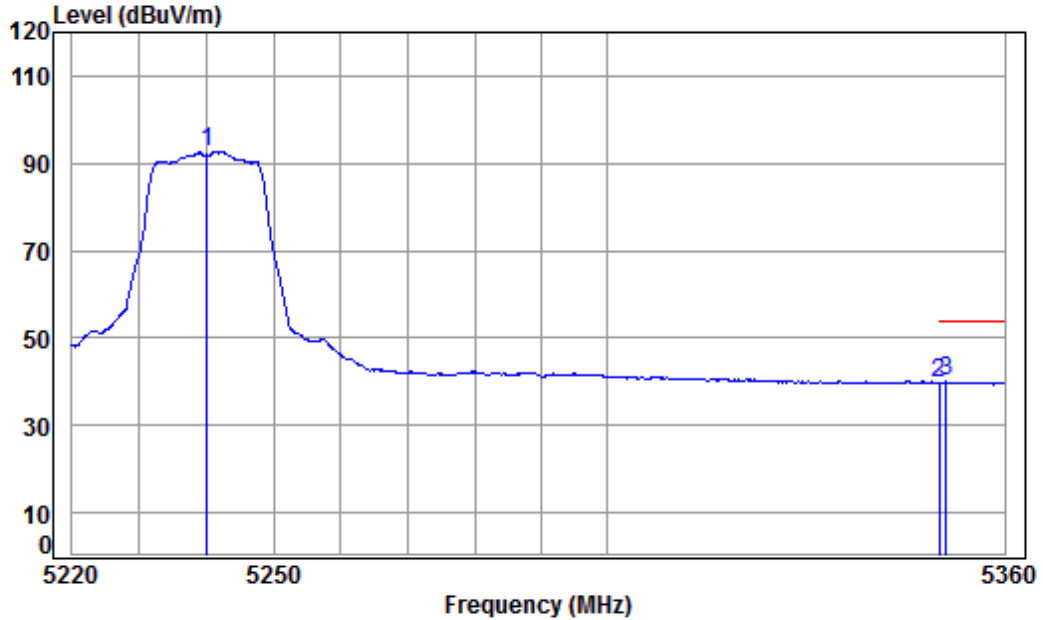

Condition: 3m VERTICAL
Job No : 04056CR/04057CR
Mode : 5240 Band edge
: 5G WIFI 11A

	Freq	Cable Loss	Ant Factor	Preamp Factor	Read Level	Limit Level	Limit Line	Over Limit	Remark
	MHz	dB	dB/m	dB	dBuV	dBuV/m	dBuV/m	dB	
1	5240.000	8.46	34.40	42.27	92.03	92.62	-----	-----	Average
2	5350.020	8.63	34.48	42.17	38.89	39.83	54.00	-14.17	Average
3 pp	5351.070	8.63	34.48	42.17	38.99	39.93	54.00	-14.07	Average



Mode:e; Polarization:Horizontal; Modulation:802.11n; bandwidth:20MHz; Channel:Low

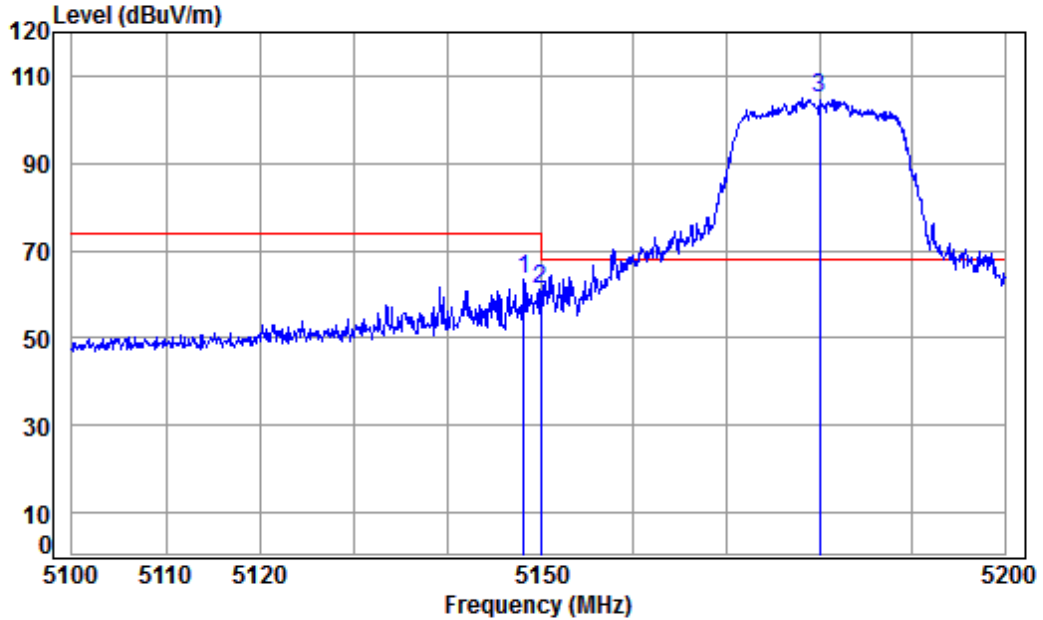

Condition: 3m HORIZONTAL
Job No : 04056CR/04057CR
Mode : 5180 Band edge
: 5G WIFI 11N20

	Cable	Ant	Preamp	Read	Limit	Over		
Freq	Loss	Factor	Factor	Level	Level	Line	Limit	Remark
MHz	dB	dB/m	dB	dBuV	dBuV/m	dBuV/m	dB	
1	5148.158	8.32	34.32	42.36	63.14	63.42	74.00	-10.58 peak
2	5149.980	8.33	34.32	42.36	60.98	61.27	74.00	-12.73 peak
3 pp	5180.000	8.37	34.35	42.33	104.72	105.11	68.20	36.91 peak



Mode:e; Polarization:Horizontal; Modulation:802.11n; bandwidth:20MHz; Channel:Low

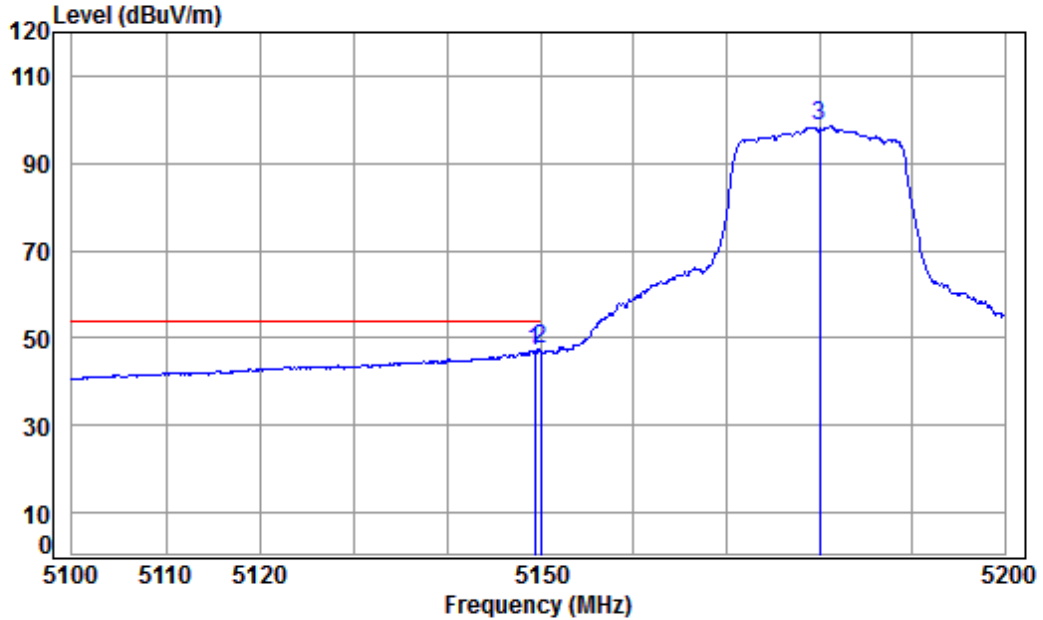

Condition: 3m HORIZONTAL
Job No : 04056CR/04057CR
Mode : 5180 Band edge
: 5G WIFI 11N20

	Freq	Cable Loss	Ant Factor	Preamp Factor	Read Level	Level	Limit	Over	Remark
	MHz	dB	dB/m	dB	dBuV	dBuV/m	dBuV/m	dB	
1	5149.357	8.32	34.32	42.36	46.87	47.15	54.00	-6.85	Average
2	pp 5149.980	8.33	34.32	42.36	47.13	47.42	54.00	-6.58	Average
3	5180.000	8.37	34.35	42.33	98.10	98.49	-----	-----	Average



Mode:e; Polarization:Vertical; Modulation:802.11n; bandwidth:20MHz; Channel:Low

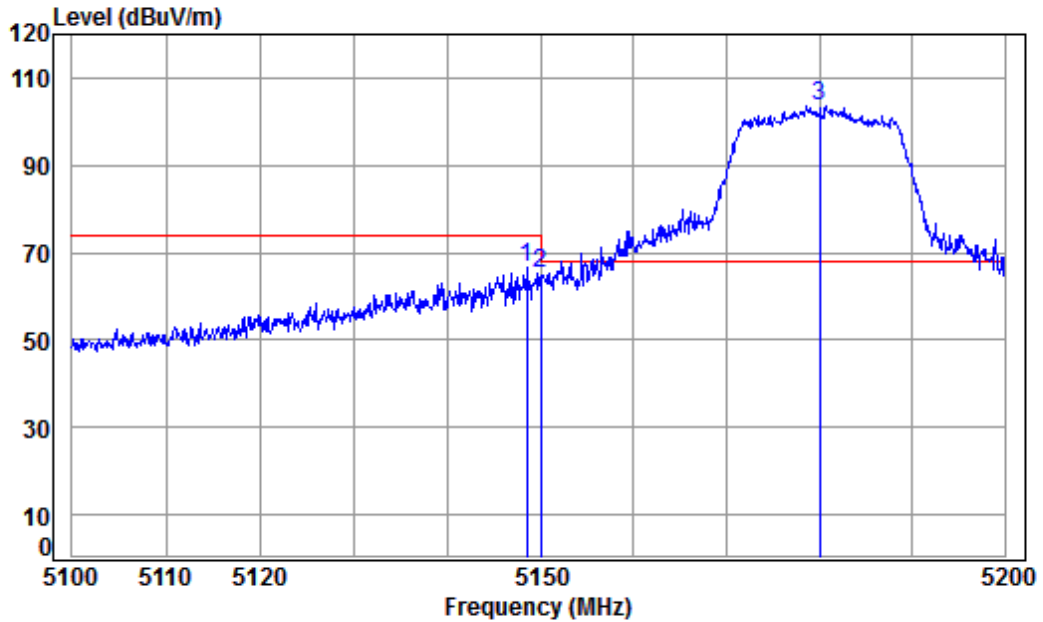

Condition: 3m VERTICAL
Job No : 04056CR/04057CR
Mode : 5180 Band edge
: 5G WIFI 11N20

	Freq	Cable Loss	Ant Factor	Preamp Factor	Read Level	Level	Limit	Over	Remark
	MHz	dB	dB/m	dB	dBuV	dBuV/m	dBuV/m	dB	
1	5148.558	8.32	34.32	42.36	66.23	66.51	74.00	-7.49	Peak
2	5149.980	8.33	34.32	42.36	64.79	65.08	74.00	-8.92	Peak
3	pp 5180.000	8.37	34.35	42.33	103.40	103.79	68.20	35.59	Peak



Mode:e; Polarization:Vertical; Modulation:802.11n; bandwidth:20MHz; Channel:Low

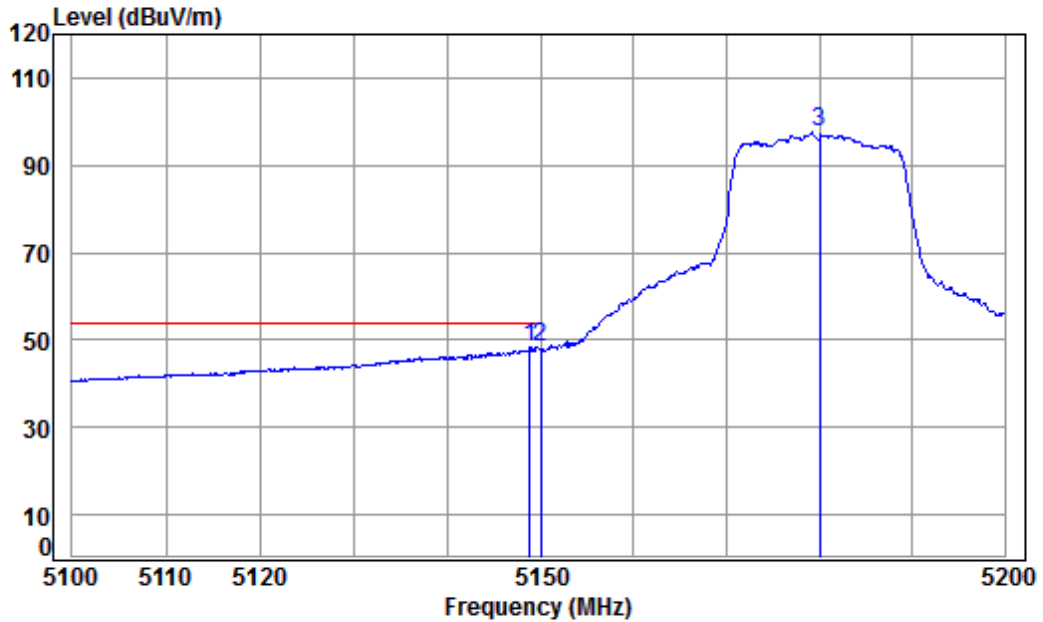

Condition: 3m VERTICAL
Job No : 04056CR/04057CR
Mode : 5180 Band edge
: 5G WIFI 11N20

		Cable	Ant	Preamp	Read	Limit	Over		
	Freq	Loss	Factor	Factor	Level	Level	Line	Limit	Remark
	MHz	dB	dB/m	dB	dBuV	dBuV/m	dBuV/m	dB	
1	pp 5148.857	8.32	34.32	42.36	48.24	48.52	54.00	-5.48	Average
2	5149.980	8.33	34.32	42.36	47.92	48.21	54.00	-5.79	Average
3	5180.000	8.37	34.35	42.33	97.08	97.47	-----	-----	Average



Mode:e; Polarization:Horizontal; Modulation:802.11n; bandwidth:20MHz; Channel:High

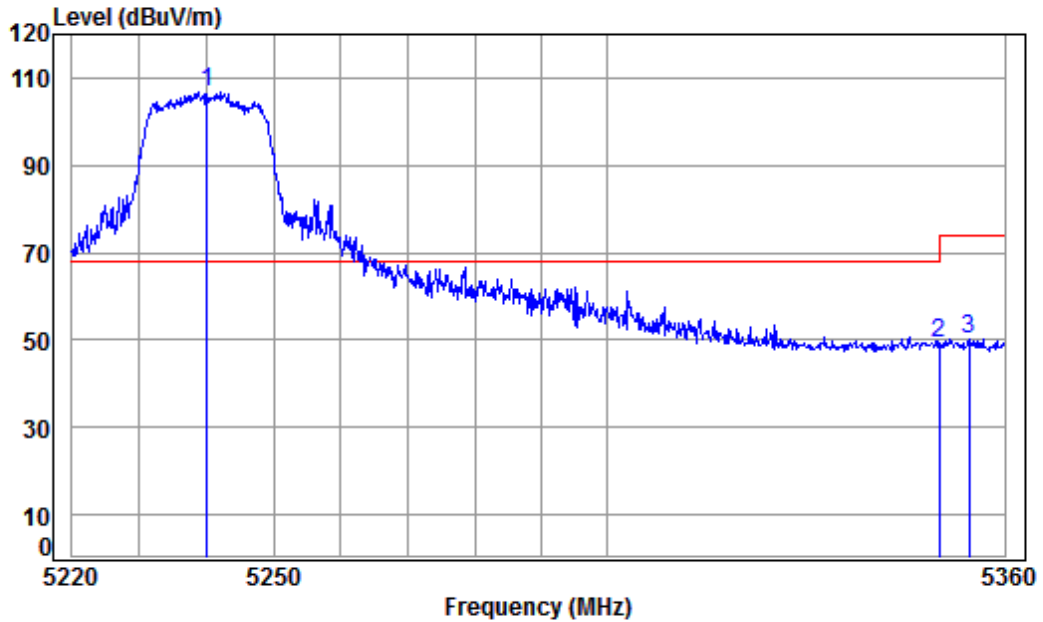

Condition: 3m HORIZONTAL
Job No : 04056CR/04057CR
Mode : 5240 Band edge
: 5G WIFI 11N20

		Cable	Ant	Preamp	Read	Limit	Over		
	Freq	Loss	Factor	Factor	Level	Level	Line	Limit	Remark
	MHz	dB	dB/m	dB	dBuV	dBuV/m	dBuV/m	dB	
1	pp 5240.000	8.46	34.40	42.27	106.02	106.61	68.20	38.41	peak
2	5350.020	8.63	34.48	42.17	48.37	49.31	74.00	-24.69	peak
3	5354.612	8.64	34.49	42.16	49.42	50.39	74.00	-23.61	peak



Mode:e; Polarization:Horizontal; Modulation:802.11n; bandwidth:20MHz; Channel:High

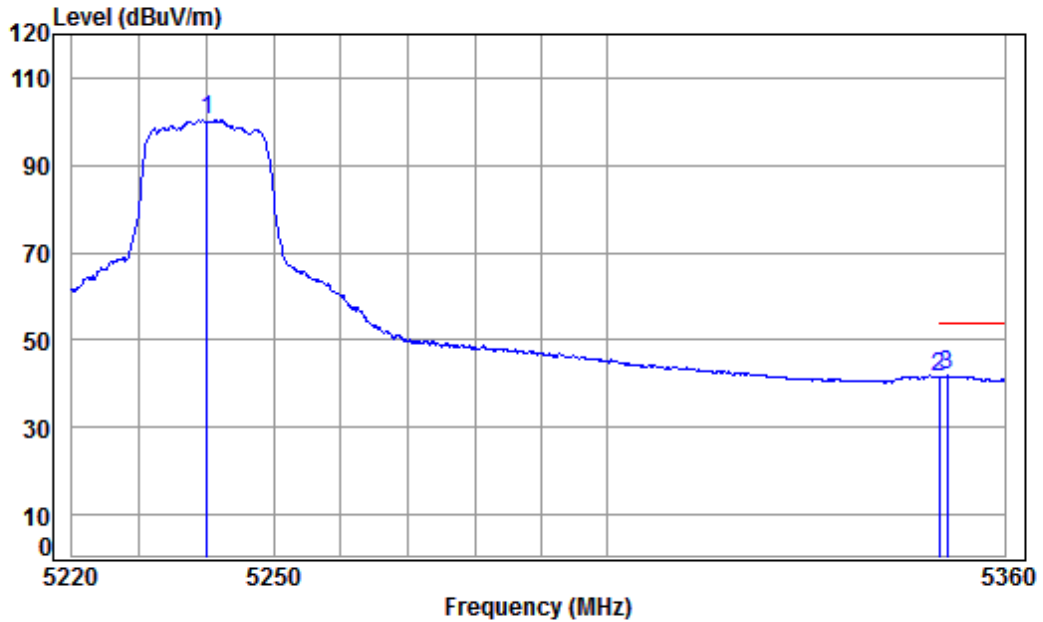

Condition: 3m HORIZONTAL
Job No : 04056CR/04057CR
Mode : 5240 Band edge
: 5G WIFI 11N20

	Freq	Cable Loss	Ant Factor	Preamp Factor	Read Level	Limit Level	Limit Line	Over Limit	Remark
	MHz	dB	dB/m	dB	dBuV	dBuV/m	dBuV/m	dB	
1	5240.000	8.46	34.40	42.27	99.76	100.35	-----	-----	Average
2	5350.020	8.63	34.48	42.17	40.66	41.60	54.00	-12.40	Average
3 pp	5351.212	8.63	34.48	42.17	40.86	41.80	54.00	-12.20	Average



Mode:e; Polarization:Vertical; Modulation:802.11n; bandwidth:20MHz; Channel:High

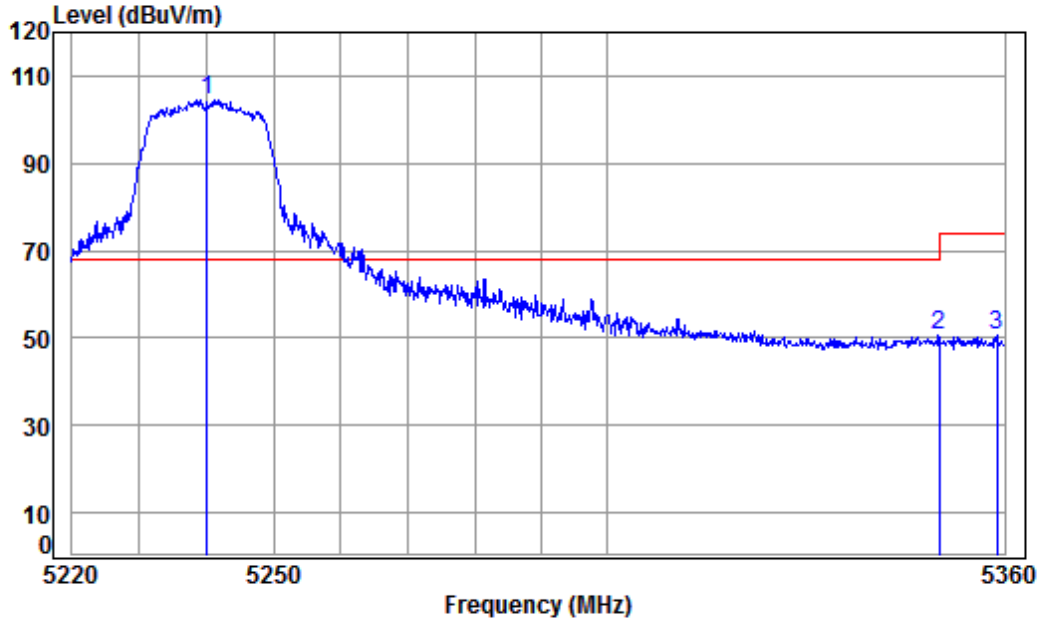

Condition: 3m VERTICAL
Job No : 04056CR/04057CR
Mode : 5240 Band edge
: 5G WIFI 11N20

		Cable	Ant	Preamp	Read	Limit	Over		
	Freq	Loss	Factor	Factor	Level	Level	Line	Limit	Remark
	MHz	dB	dB/m	dB	dBuV	dBuV/m	dBuV/m	dB	
1	pp 5240.000	8.46	34.40	42.27	103.77	104.36	68.20	36.16	Peak
2	5350.020	8.63	34.48	42.17	49.72	50.66	74.00	-23.34	Peak
3	5358.865	8.64	34.49	42.16	49.62	50.59	74.00	-23.41	Peak



Mode:e; Polarization:Vertical; Modulation:802.11n; bandwidth:20MHz; Channel:High

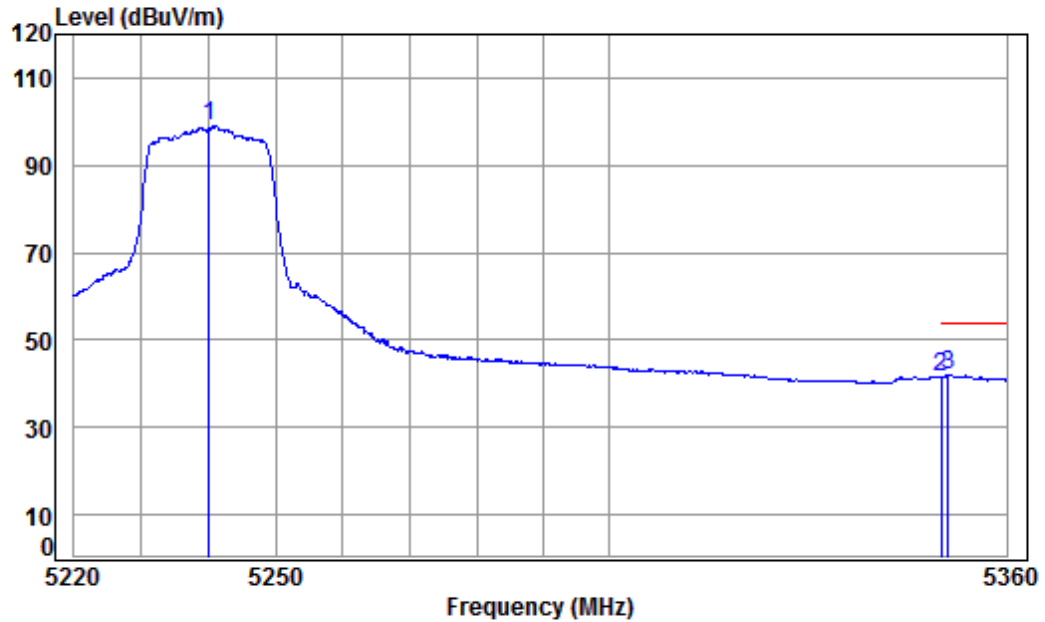

Condition: 3m VERTICAL
Job No : 04056CR/04057CR
Mode : 5240 Band edge
: 5G WIFI 11N20

	Freq	Cable Loss	Ant Factor	Preamp Factor	Read Level	Limit Level	Limit Line	Over Limit	Remark
	MHz	dB	dB/m	dB	dBuV	dBuV/m	dBuV/m	dB	
1	5240.000	8.46	34.40	42.27	98.28	98.87	-----	-----	Average
2	5350.020	8.63	34.48	42.17	40.55	41.49	54.00	-12.51	Average
3 pp	5351.070	8.63	34.48	42.17	41.04	41.98	54.00	-12.02	Average



Mode:e; Polarization:Horizontal; Modulation:802.11n; bandwidth:40MHz; Channel:Low

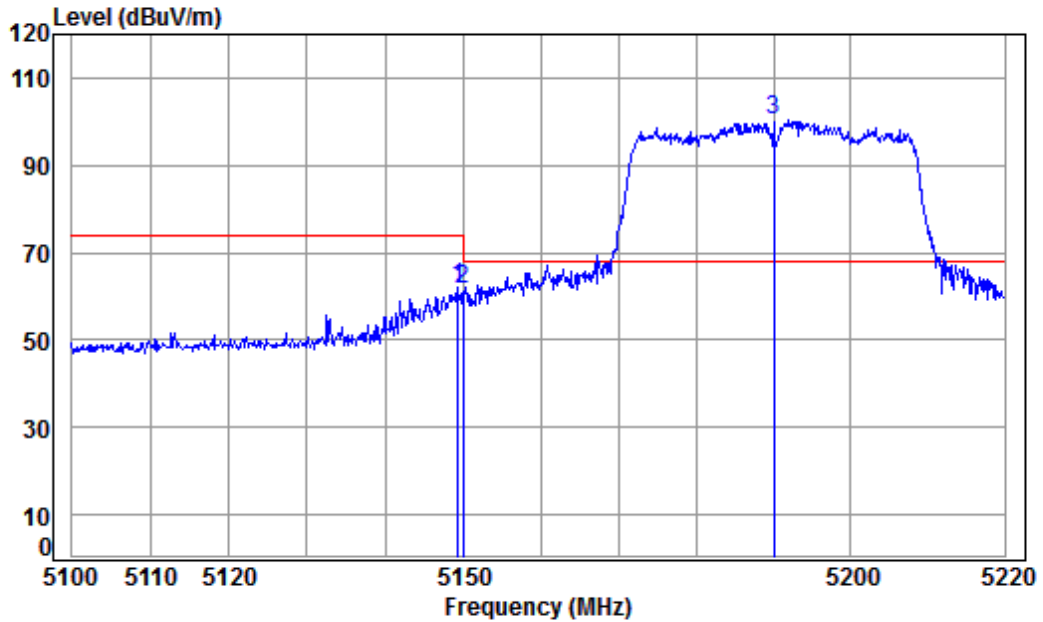

Condition: 3m HORIZONTAL
Job No : 04056CR/04057CR
Mode : 5190 Band edge
: 5G WIFI 11N40

	Freq	Cable Loss	Ant Factor	Preamp Factor	Read Level	Level	Limit	Over	Remark
	MHz	dB	dB/m	dB	dBuV	dBuV/m	dBuV/m	dB	
1	5149.342	8.32	34.32	42.36	61.61	61.89	74.00	-12.11	peak
2	5149.980	8.33	34.32	42.36	61.24	61.53	74.00	-12.47	peak
3	pp 5190.000	8.39	34.36	42.32	99.73	100.16	68.20	31.96	peak



Mode:e; Polarization:Horizontal; Modulation:802.11n; bandwidth:40MHz; Channel:Low

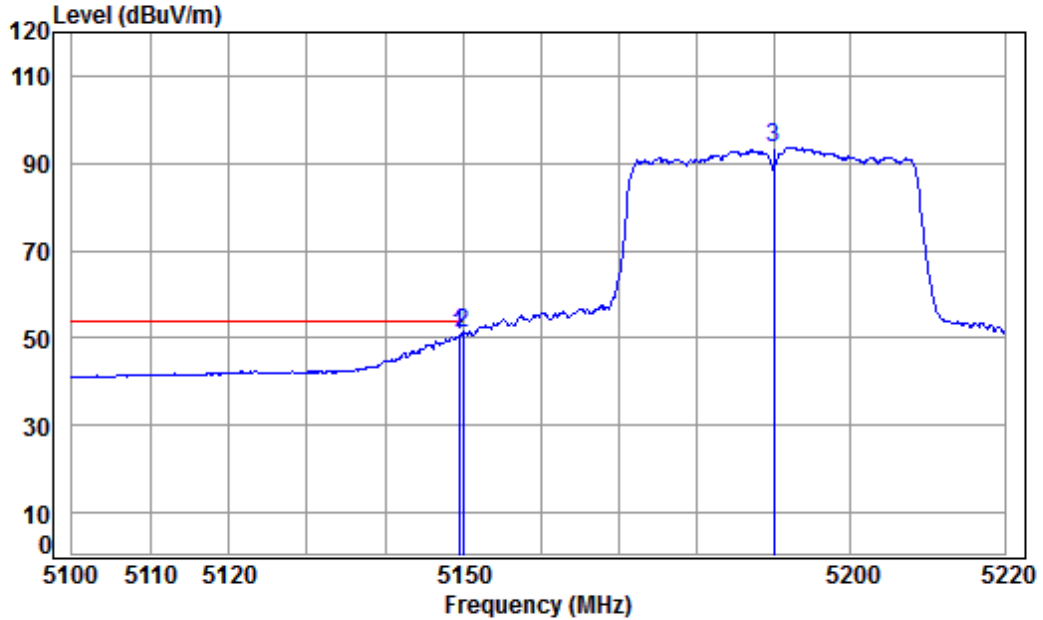

Condition: 3m HORIZONTAL
Job No : 04056CR/04057CR
Mode : 5190 Band edge
: 5G WIFI 11N40

	Freq	Cable Loss	Ant Factor	Preamp Factor	Read Level	Limit Level	Limit Line	Over Limit	Remark
	MHz	dB	dB/m	dB	dBuV	dBuV/m	dBuV/m	dB	
1	5149.461	8.32	34.32	42.36	50.34	50.62	54.00	-3.38	Average
2	pp 5149.980	8.33	34.32	42.36	50.65	50.94	54.00	-3.06	Average
3	5190.000	8.39	34.36	42.32	93.16	93.59	-----	-----	Average



Mode:e; Polarization:Vertical; Modulation:802.11n; bandwidth:40MHz; Channel:Low

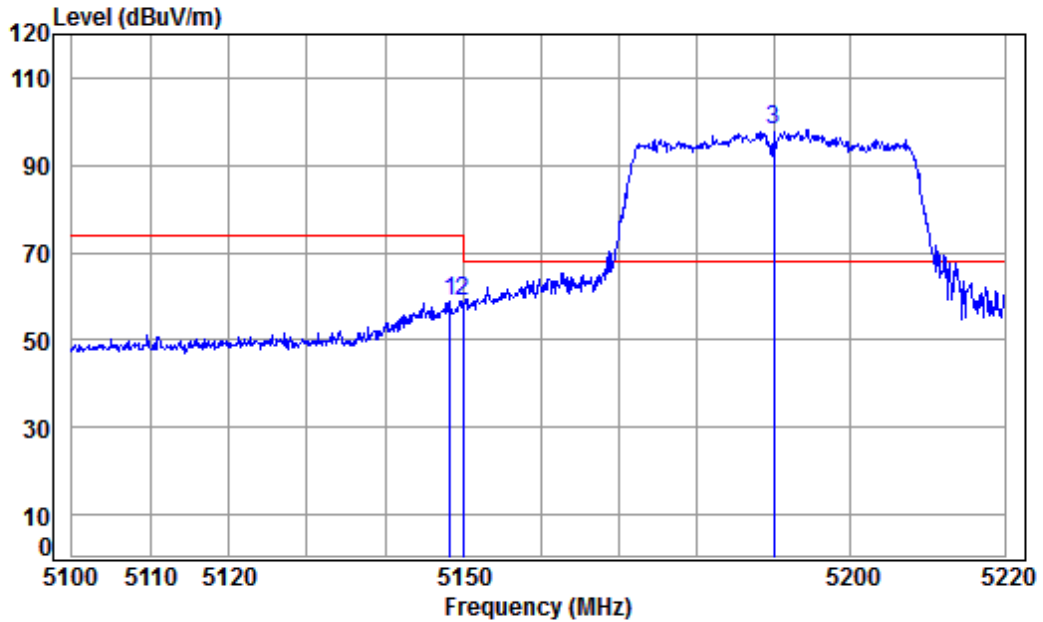

Condition: 3m VERTICAL
Job No : 04056CR/04057CR
Mode : 5190 Band edge
: 5G WIFI 11N40

	Freq	Cable Loss	Ant Factor	Preamp Factor	Read Level	Level	Limit	Over	Remark
	MHz	dB	dB/m	dB	dBuV	dBuV/m	dBuV/m	dB	
1	5148.264	8.32	34.32	42.36	58.40	58.68	74.00	-15.32	Peak
2	5149.980	8.33	34.32	42.36	58.59	58.88	74.00	-15.12	Peak
3	pp 5190.000	8.39	34.36	42.32	97.47	97.90	68.20	29.70	Peak



Mode:e; Polarization:Vertical; Modulation:802.11n; bandwidth:40MHz; Channel:Low

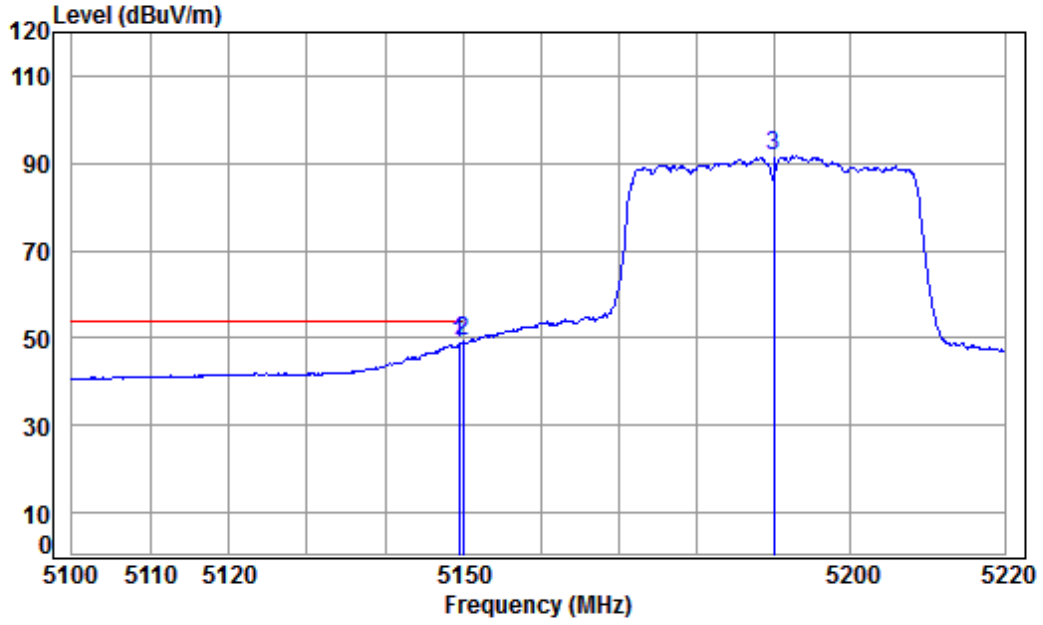

Condition: 3m VERTICAL
Job No : 04056CR/04057CR
Mode : 5190 Band edge
: 5G WIFI 11N40

	Freq	Cable Loss	Ant Factor	Preamp Factor	Read Level	Level	Limit	Over	Remark
	MHz	dB	dB/m	dB	dBuV	dBuV/m	dBuV/m	dB	
1	5149.461	8.32	34.32	42.36	48.36	48.64	54.00	-5.36	Average
2	pp 5149.980	8.33	34.32	42.36	48.98	49.27	54.00	-4.73	Average
3	5190.000	8.39	34.36	42.32	91.24	91.67	-----	-----	Average



Mode:e; Polarization:Horizontal; Modulation:802.11n; bandwidth:40MHz; Channel:High

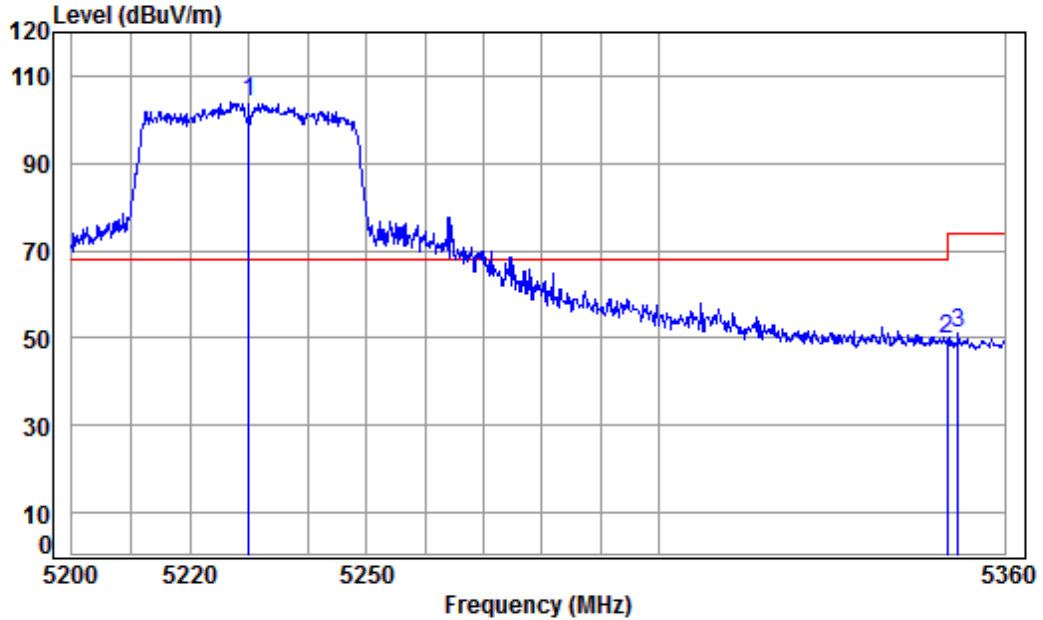

Condition: 3m HORIZONTAL
Job No : 04056CR/04057CR
Mode : 5230 Band edge
: 5G WIFI 11N40

		Cable	Ant	Preamp	Read	Limit	Over		
	Freq	Loss	Factor	Factor	Level	Level	Line	Limit	Remark
	MHz	dB	dB/m	dB	dBuV	dBuV/m	dBuV/m	dB	
1	pp 5230.000	8.45	34.39	42.28	103.48	104.04	68.20	35.84	peak
2	5350.020	8.63	34.48	42.17	48.64	49.58	74.00	-24.42	peak
3	5351.884	8.63	34.49	42.17	49.99	50.94	74.00	-23.06	peak



Mode:e; Polarization:Horizontal; Modulation:802.11n; bandwidth:40MHz; Channel:High

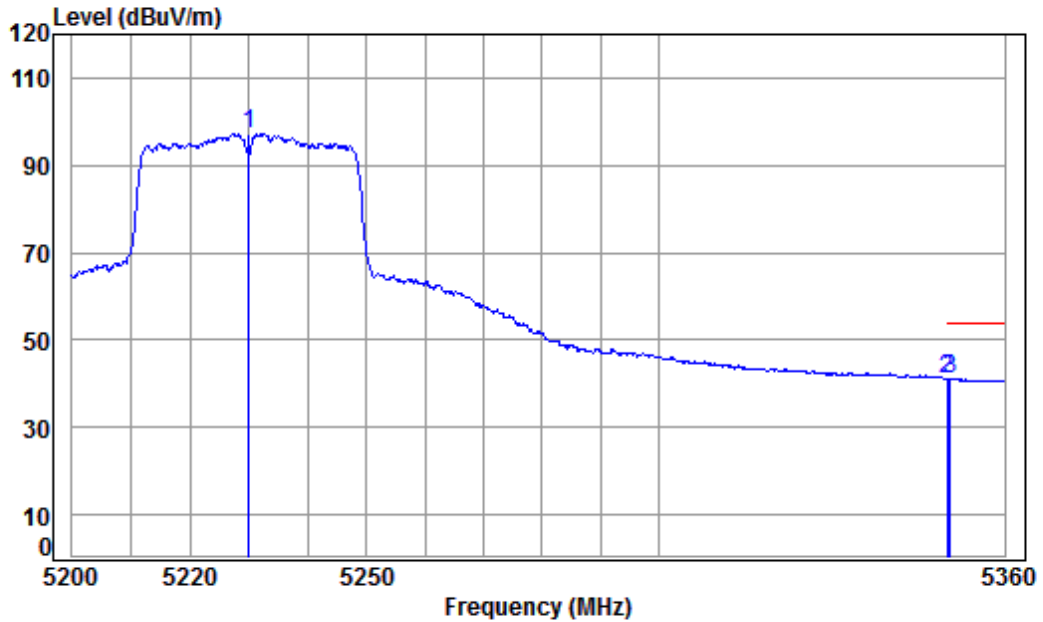

Condition: 3m HORIZONTAL
Job No : 04056CR/04057CR
Mode : 5230 Band edge
: 5G WIFI 11N40

	Freq	Cable Loss	Ant Factor	Preamp Factor	Read Level	Limit Level	Limit Line	Over Limit	Remark
	MHz	dB	dB/m	dB	dBuV	dBuV/m	dBuV/m	dB	
1	5230.000	8.45	34.39	42.28	96.69	97.25	-----	-----	Average
2	5350.020	8.63	34.48	42.17	40.30	41.24	54.00	-12.76	Average
3 pp	5350.587	8.63	34.48	42.17	40.31	41.25	54.00	-12.75	Average



Mode:e; Polarization:Vertical; Modulation:802.11n; bandwidth:40MHz; Channel:High

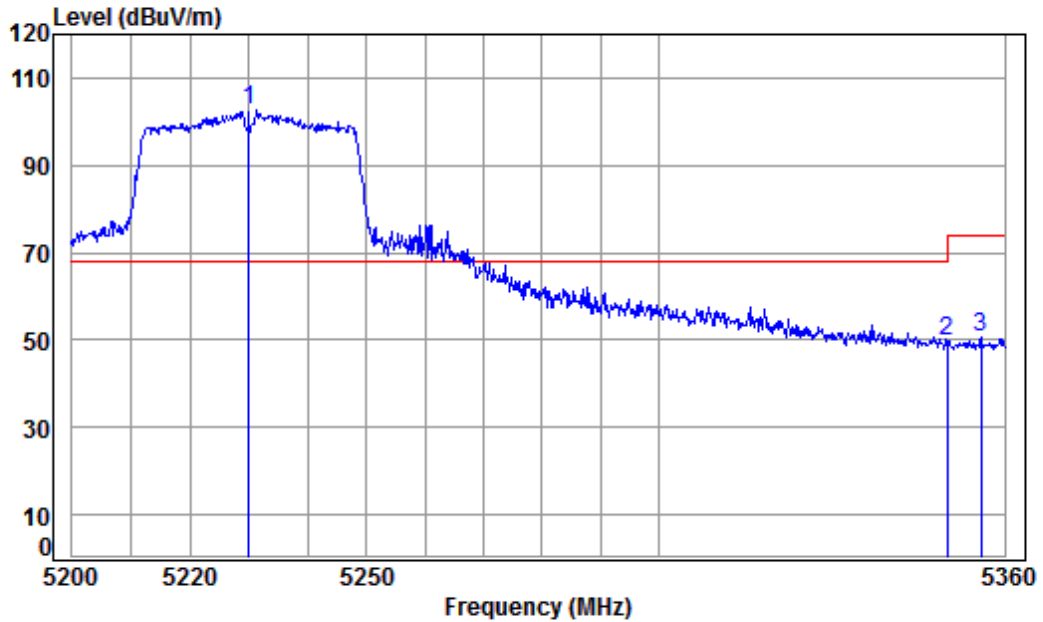

Condition: 3m VERTICAL
Job No : 04056CR/04057CR
Mode : 5230 Band edge
: 5G WIFI 11N40

		Cable	Ant	Preamp	Read	Limit	Over		
	Freq	Loss	Factor	Factor	Level	Level	Line	Limit	Remark
	MHz	dB	dB/m	dB	dBuV	dBuV/m	dBuV/m	dB	
1	pp 5230.000	8.45	34.39	42.28	101.93	102.49	68.20	34.29	Peak
2	5350.020	8.63	34.48	42.17	48.78	49.72	74.00	-24.28	Peak
3	5355.940	8.64	34.49	42.16	49.64	50.61	74.00	-23.39	Peak



Mode:e; Polarization:Vertical; Modulation:802.11n; bandwidth:40MHz; Channel:High

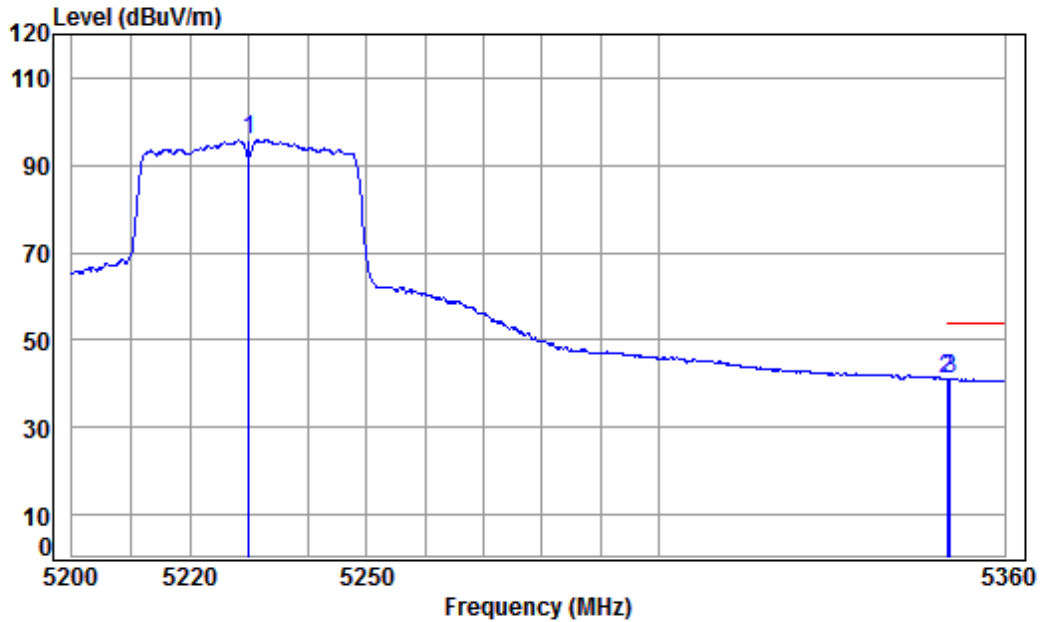

Condition: 3m VERTICAL
Job No : 04056CR/04057CR
Mode : 5230 Band edge
: 5G WIFI 11N40

	Freq	Cable Loss	Ant Factor	Preamp Factor	Read Level	Limit Level	Limit Line	Over Limit	Remark
	MHz	dB	dB/m	dB	dBuV	dBuV/m	dBuV/m	dB	
1	5230.000	8.45	34.39	42.28	95.21	95.77	-----	-----	Average
2	pp 5350.020	8.63	34.48	42.17	40.33	41.27	54.00	-12.73	Average
3	5350.587	8.63	34.48	42.17	40.18	41.12	54.00	-12.88	Average



Mode:e; Polarization:Horizontal; Modulation:802.11ac; bandwidth:20MHz; Channel:Low

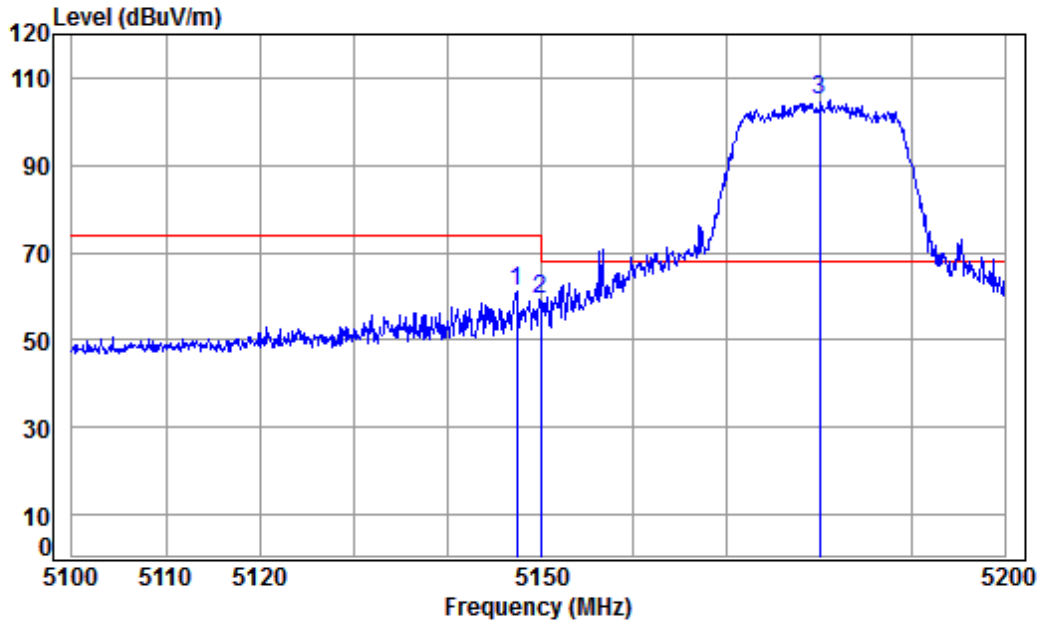

Condition: 3m HORIZONTAL
Job No : 04056CR/04057CR
Mode : 5180 Band edge
: 5G WIFI 11AC20

	Cable	Ant	Preamp	Read	Limit	Over		
Freq	Loss	Factor	Factor	Level	Level	Line	Limit	Remark
MHz	dB	dB/m	dB	dBuV	dBuV/m	dBuV/m	dB	
1	5147.458	8.32	34.32	42.36	60.78	61.06	74.00	-12.94 peak
2	5149.980	8.33	34.32	42.36	59.03	59.32	74.00	-14.68 peak
3	pp 5180.000	8.37	34.35	42.33	104.50	104.89	68.20	36.69 peak



Mode:e; Polarization:Horizontal; Modulation:802.11ac; bandwidth:20MHz; Channel:Low

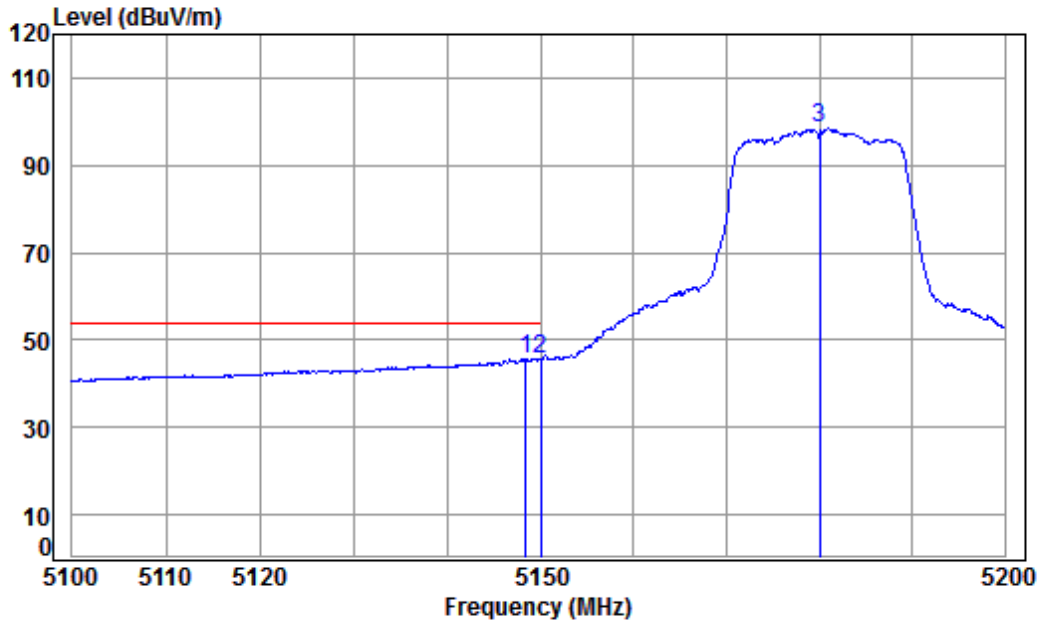

Condition: 3m HORIZONTAL
 Job No : 04056CR/04057CR
 Mode : 5180 Band edge
 : 5G WIFI 11AC20

	Freq	Cable Loss	Ant Factor	Preamp Factor	Read Level	Level	Limit	Over	Remark
	MHz	dB	dB/m	dB	dBuV	dBuV/m	dBuV/m	dB	
1	5148.458	8.32	34.32	42.36	45.45	45.73	54.00	-8.27	Average
2 pp	5149.980	8.33	34.32	42.36	45.51	45.80	54.00	-8.20	Average
3	5180.000	8.37	34.35	42.33	98.01	98.40	-----	-----	Average



Mode:e; Polarization:Vertical; Modulation:802.11ac; bandwidth:20MHz; Channel:Low

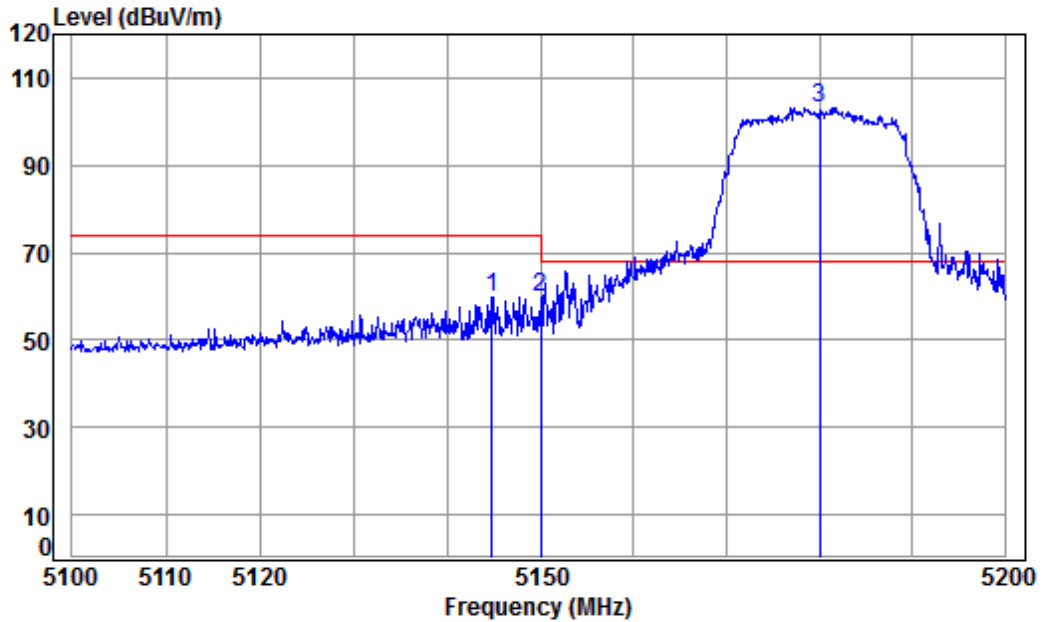

Condition: 3m VERTICAL
Job No : 04056CR/04057CR
Mode : 5180 Band edge
: 5G WIFI 11AC20

	Cable	Ant	Preamp	Read	Limit	Over		
Freq	Loss	Factor	Factor	Level	Level	Line	Limit	Remark
MHz	dB	dB/m	dB	dBuV	dBuV/m	dBuV/m	dB	
1	5144.760	8.32	34.32	42.36	59.61	59.89	74.00	-14.11 Peak
2	5149.980	8.33	34.32	42.36	59.59	59.88	74.00	-14.12 Peak
3	pp 5180.000	8.37	34.35	42.33	102.78	103.17	68.20	34.97 Peak



Mode:e; Polarization:Vertical; Modulation:802.11ac; bandwidth:20MHz; Channel:Low

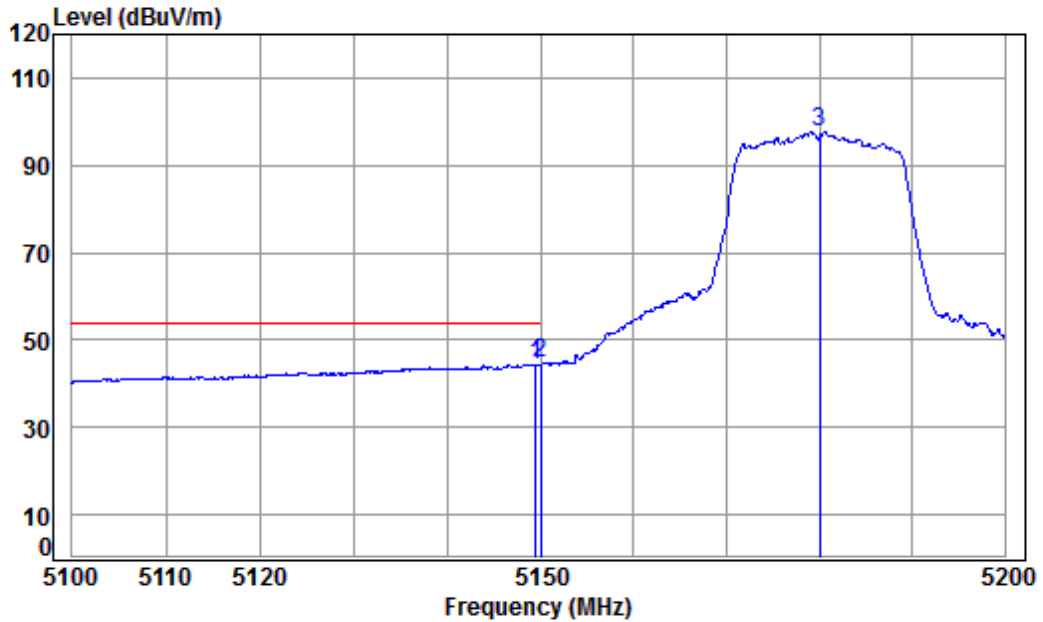

Condition: 3m VERTICAL
Job No : 04056CR/04057CR
Mode : 5180 Band edge
: 5G WIFI 11AC20

	Freq	Cable Loss	Ant Factor	Preamp Factor	Read Level	Limit Level	Over Limit	Remark
	MHz	dB	dB/m	dB	dBuV	dBuV/m	dBuV/m	dB
1	5149.458	8.32	34.32	42.36	44.18	44.46	54.00	-9.54 Average
2 pp	5149.980	8.33	34.32	42.36	44.49	44.78	54.00	-9.22 Average
3	5180.000	8.37	34.35	42.33	97.32	97.71	-----	----- Average



Mode:e; Polarization:Horizontal; Modulation:802.11ac; bandwidth:20MHz; Channel:High

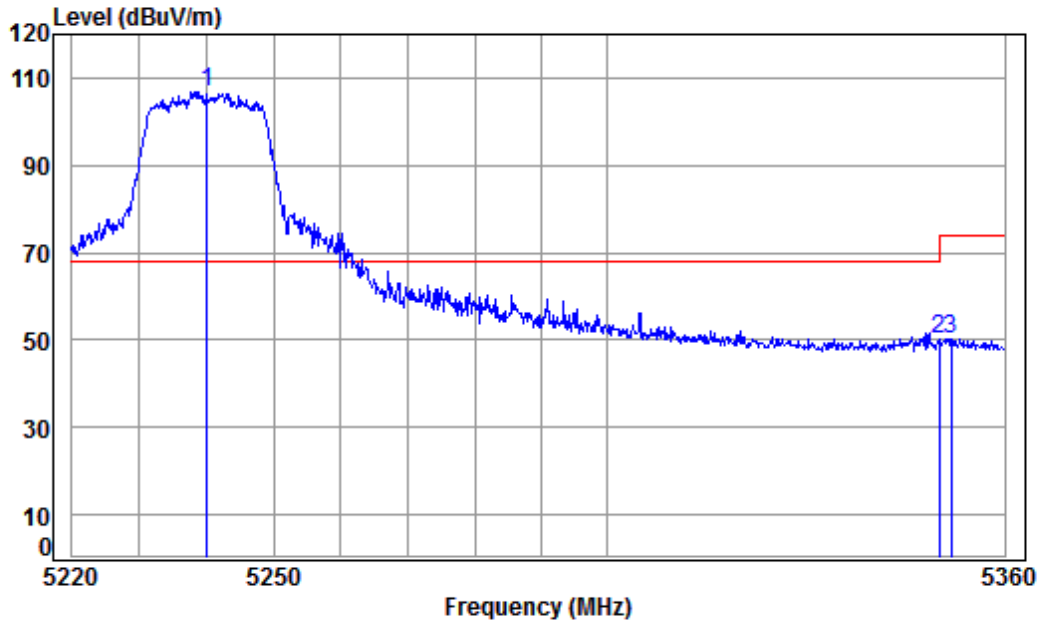

Condition: 3m HORIZONTAL
Job No : 04056CR/04057CR
Mode : 5240 Band edge
: 5G WIFI 11AC20

		Cable	Ant	Preamp	Read	Limit	Over		
	Freq	Loss	Factor	Factor	Level	Level	Line	Limit	Remark
	MHz	dB	dB/m	dB	dBuV	dBuV/m	dBuV/m	dB	
1	pp 5240.000	8.46	34.40	42.27	106.26	106.85	68.20	38.65	peak
2	5350.020	8.63	34.48	42.17	49.20	50.14	74.00	-23.86	peak
3	5351.920	8.63	34.49	42.17	49.44	50.39	74.00	-23.61	peak



Mode:e; Polarization:Horizontal; Modulation:802.11ac; bandwidth:20MHz; Channel:High

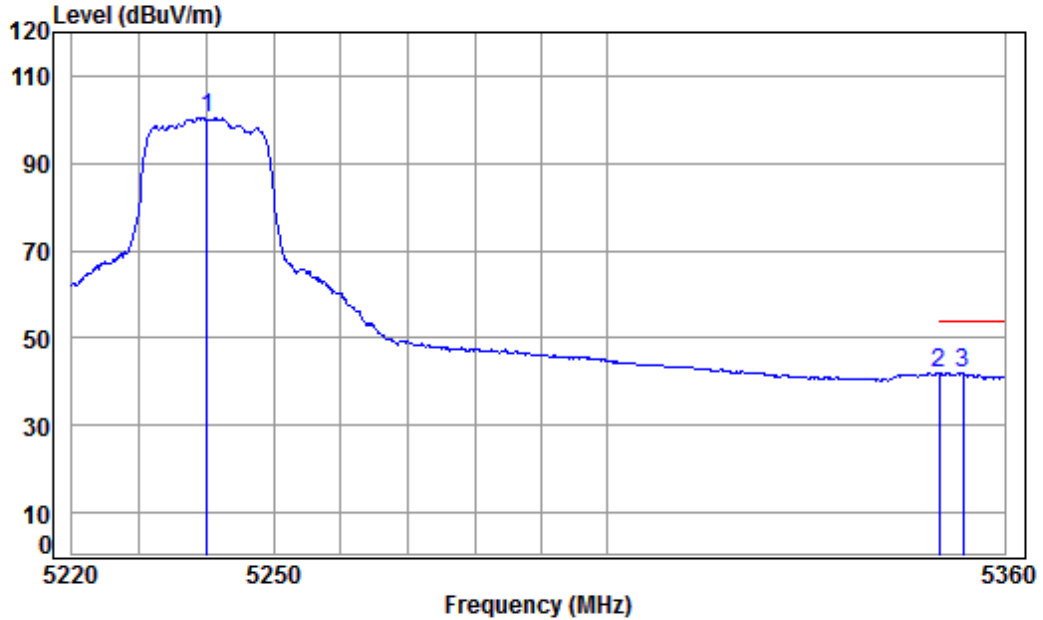

Condition: 3m HORIZONTAL
Job No : 04056CR/04057CR
Mode : 5240 Band edge
: 5G WIFI 11AC20

	Freq	Cable Loss	Ant Factor	Preamplifier	Read Level	Limit Level	Over Line	Over Limit	Remark
	MHz	dB	dB/m	dB	dBuV	dBuV/m	dBuV/m	dB	
1	5240.000	8.46	34.40	42.27	99.96	100.55	-----	-----	Average
2	5350.020	8.63	34.48	42.17	41.00	41.94	54.00	-12.06	Average
3 pp	5353.620	8.63	34.49	42.17	41.11	42.06	54.00	-11.94	Average



Mode:e; Polarization:Vertical; Modulation:802.11ac; bandwidth:20MHz; Channel:High

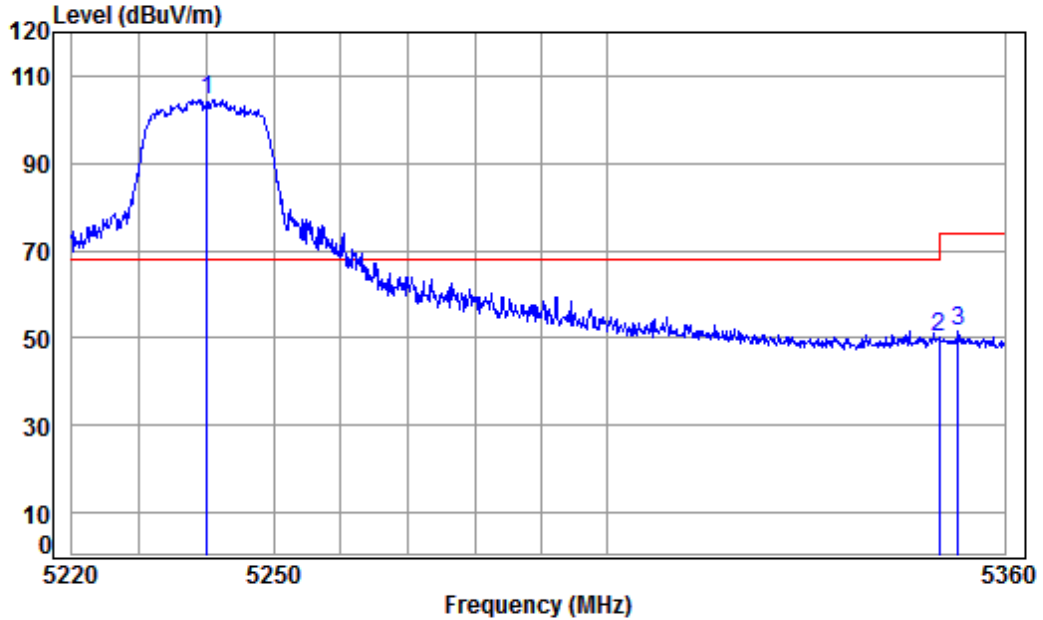

Condition: 3m VERTICAL
Job No : 04056CR/04057CR
Mode : 5240 Band edge
: 5G WIFI 11AC20

		Cable	Ant	Preamp	Read	Limit	Over		
	Freq	Loss	Factor	Factor	Level	Level	Line	Limit	Remark
	MHz	dB	dB/m	dB	dBuV	dBuV/m	dBuV/m	dB	
1	pp 5240.000	8.46	34.40	42.27	104.09	104.68	68.20	36.48	Peak
2	5350.020	8.63	34.48	42.17	49.05	49.99	74.00	-24.01	Peak
3	5352.912	8.63	34.49	42.17	50.71	51.66	74.00	-22.34	Peak



Mode:e; Polarization:Vertical; Modulation:802.11ac; bandwidth:20MHz; Channel:High

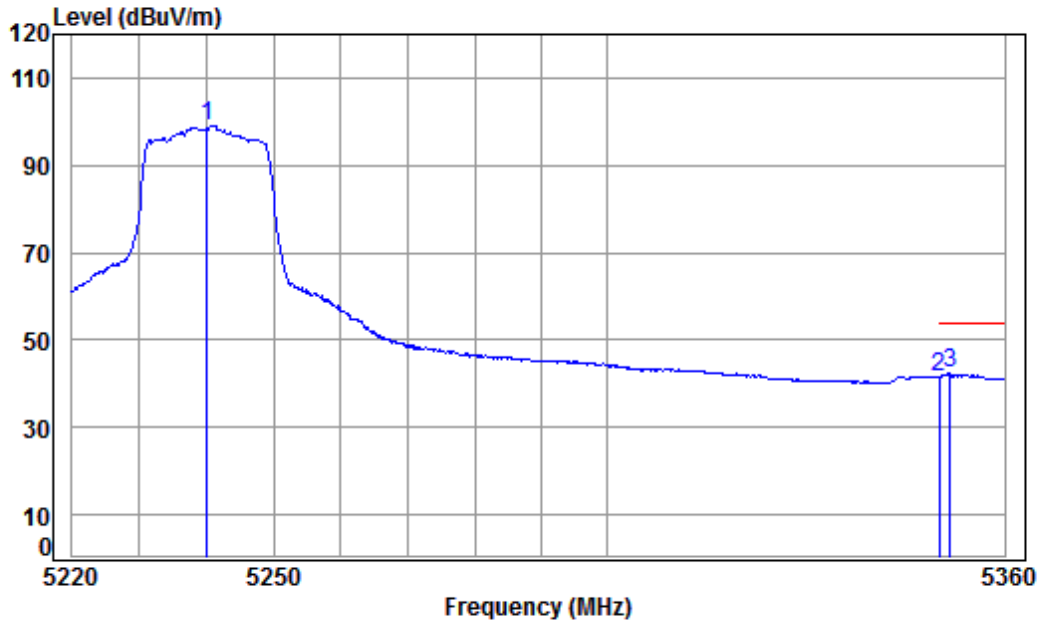

Condition: 3m VERTICAL
Job No : 04056CR/04057CR
Mode : 5240 Band edge
: 5G WIFI 11AC20

	Cable	Ant	Preamp	Read	Limit	Over		
Freq	Loss	Factor	Factor	Level	Level	Line	Limit	Remark
MHz	dB	dB/m	dB	dBuV	dBuV/m	dBuV/m	dB	
1	5240.000	8.46	34.40	42.27	98.52	99.11	-----	----- Average
2	5350.020	8.63	34.48	42.17	40.79	41.73	54.00	-12.27 Average
3	pp 5351.637	8.63	34.49	42.17	41.30	42.25	54.00	-11.75 Average



Mode:e; Polarization:Horizontal; Modulation:802.11ac; bandwidth:40MHz; Channel:Low

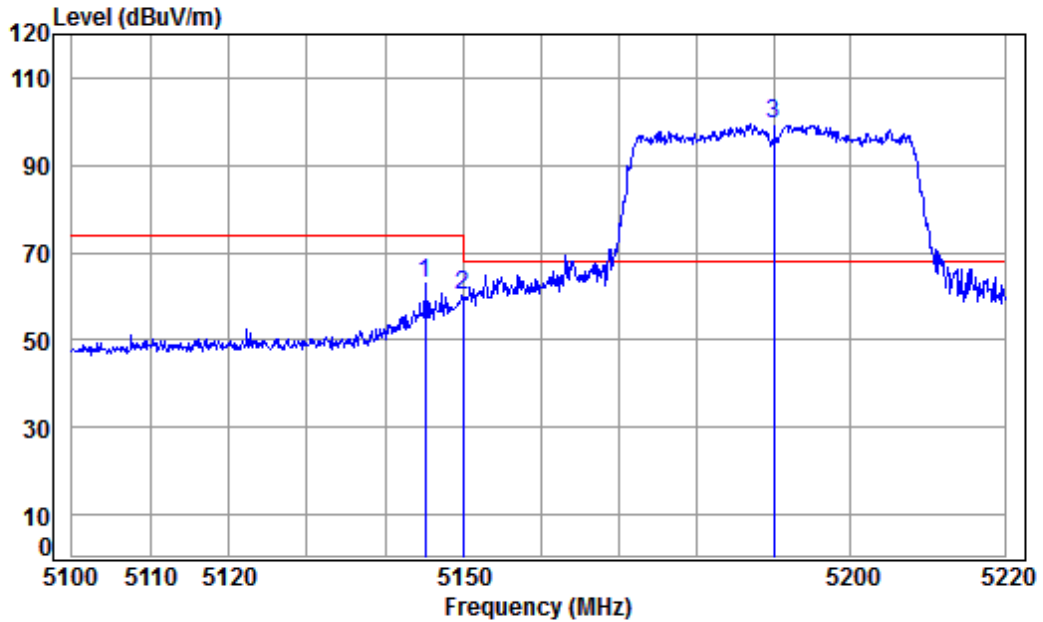

Condition: 3m HORIZONTAL
Job No : 04056CR/04057CR
Mode : 5190 Band edge
: 5G WIFI 11AC40

	Cable	Ant	Preamp	Read	Limit	Over		
Freq	Loss	Factor	Factor	Level	Level	Line	Limit	Remark
MHz	dB	dB/m	dB	dBuV	dBuV/m	dBuV/m	dB	
1	5145.152	8.32	34.32	42.36	62.52	62.80	74.00	-11.20 peak
2	5149.980	8.33	34.32	42.36	59.83	60.12	74.00	-13.88 peak
3	pp 5190.000	8.39	34.36	42.32	98.84	99.27	68.20	31.07 peak



Mode:e; Polarization:Horizontal; Modulation:802.11ac; bandwidth:40MHz; Channel:Low

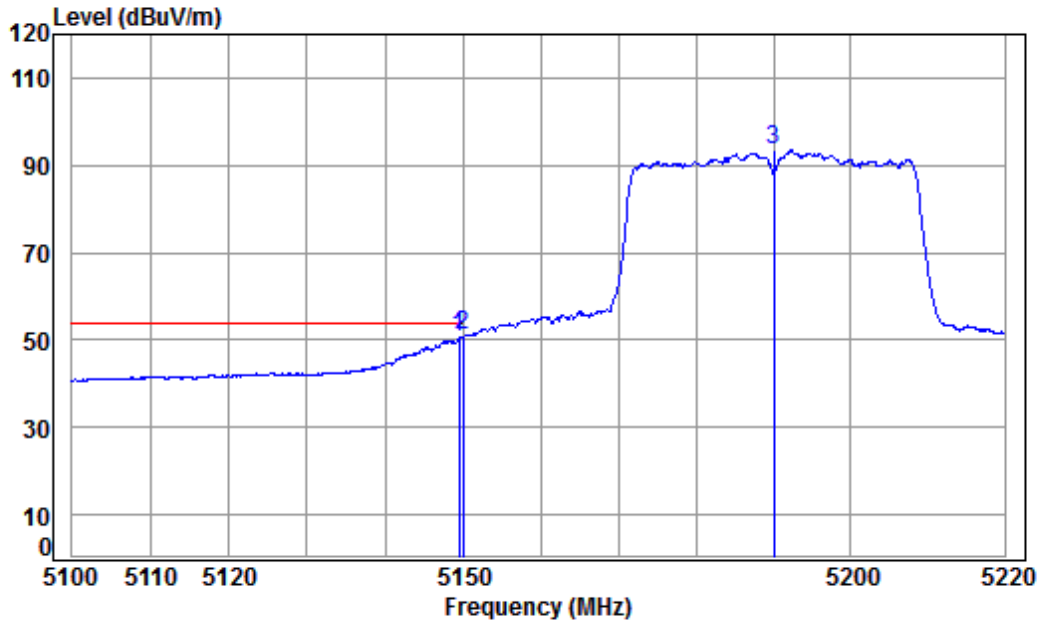

Condition: 3m HORIZONTAL
Job No : 04056CR/04057CR
Mode : 5190 Band edge
: 5G WIFI 11AC40

	Freq	Cable Loss	Ant Factor	Preamplifier	Read Level	Level	Limit	Over Limit	Remark
	MHz	dB	dB/m	dB	dBuV	dBuV/m	dBuV/m	dB	
1	5149.461	8.32	34.32	42.36	50.27	50.55	54.00	-3.45	Average
2	5149.980	8.33	34.32	42.36	50.63	50.92	54.00	-3.08	Average
3	5190.000	8.39	34.36	42.32	92.93	93.36	-----	-----	Average



Mode:e; Polarization:Vertical; Modulation:802.11ac; bandwidth:40MHz; Channel:Low

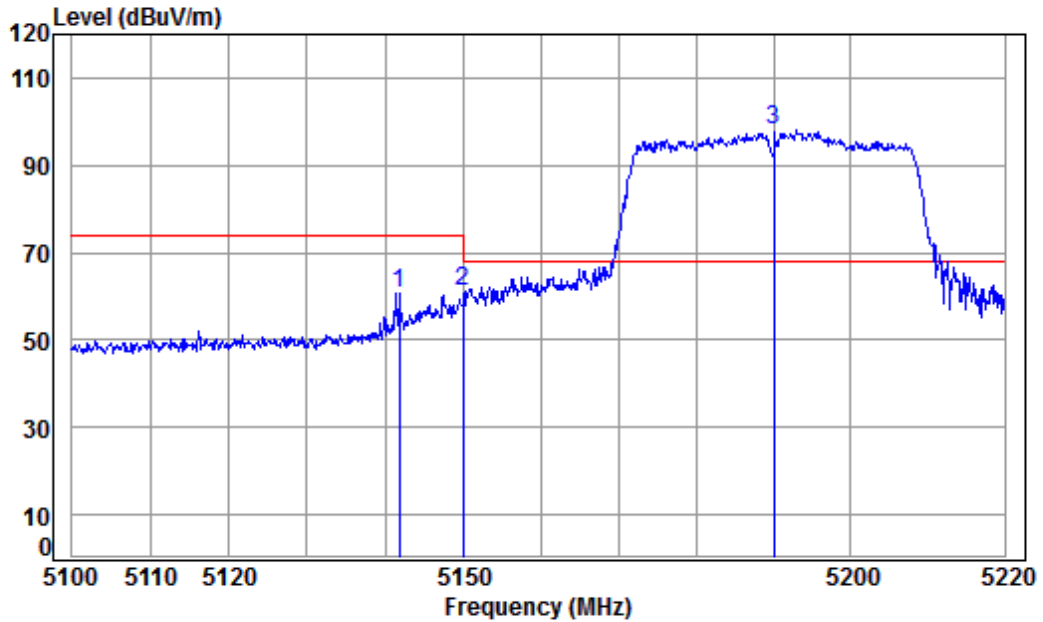

Condition: 3m VERTICAL
Job No : 04056CR/04057CR
Mode : 5190 Band edge
: 5G WIFI 11AC40

	Cable	Ant	Preamp	Read		Limit	Over		
Freq	Loss	Factor	Factor	Level	Level	Line	Limit	Remark	
MHz	dB	dB/m	dB	dBuV	dBuV/m	dBuV/m	dB		
1	5141.803	8.31	34.32	42.36	60.61	60.88	74.00	-13.12	Peak
2	5149.980	8.33	34.32	42.36	60.78	61.07	74.00	-12.93	Peak
3	pp 5190.000	8.39	34.36	42.32	97.45	97.88	68.20	29.68	Peak

Mode:e; Polarization:Vertical; Modulation:802.11ac; bandwidth:40MHz; Channel:Low

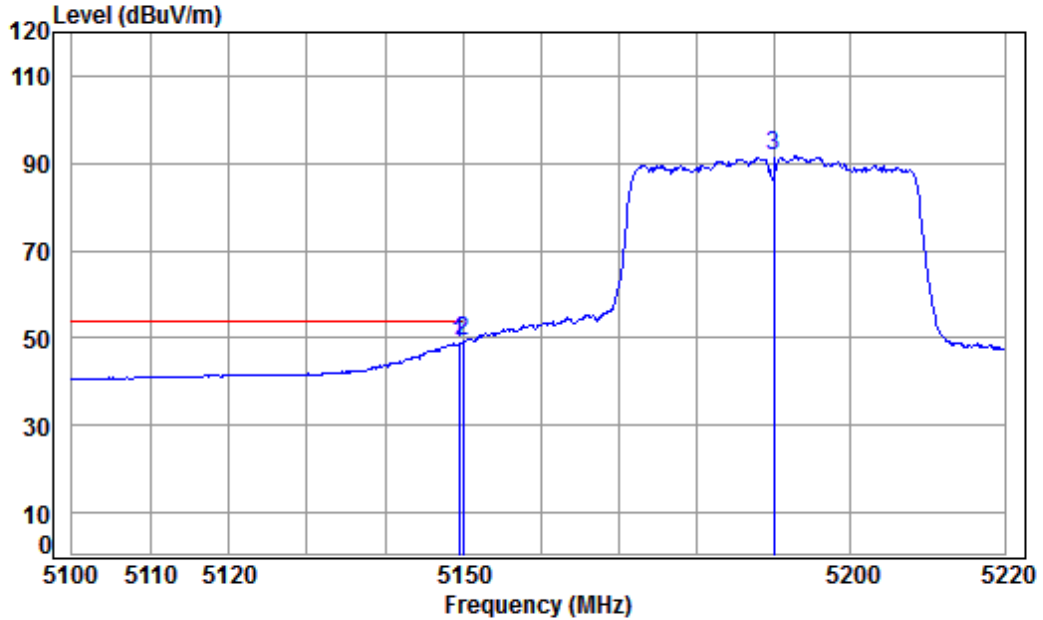

Condition: 3m VERTICAL
 Job No : 04056CR/04057CR
 Mode : 5190 Band edge
 : 5G WIFI 11AC40

	Freq	Cable Loss	Ant Factor	Preamplifier	Read Level	Limit Level	Limit Line	Over Limit	Remark
	MHz	dB	dB/m	dB	dBuV	dBuV/m	dBuV/m	dB	
1	5149.461	8.32	34.32	42.36	48.47	48.75	54.00	-5.25	Average
2	pp 5149.980	8.33	34.32	42.36	49.09	49.38	54.00	-4.62	Average
3	5190.000	8.39	34.36	42.32	91.11	91.54	-----	-----	Average



Mode:e; Polarization:Horizontal; Modulation:802.11ac; bandwidth:40MHz; Channel:High

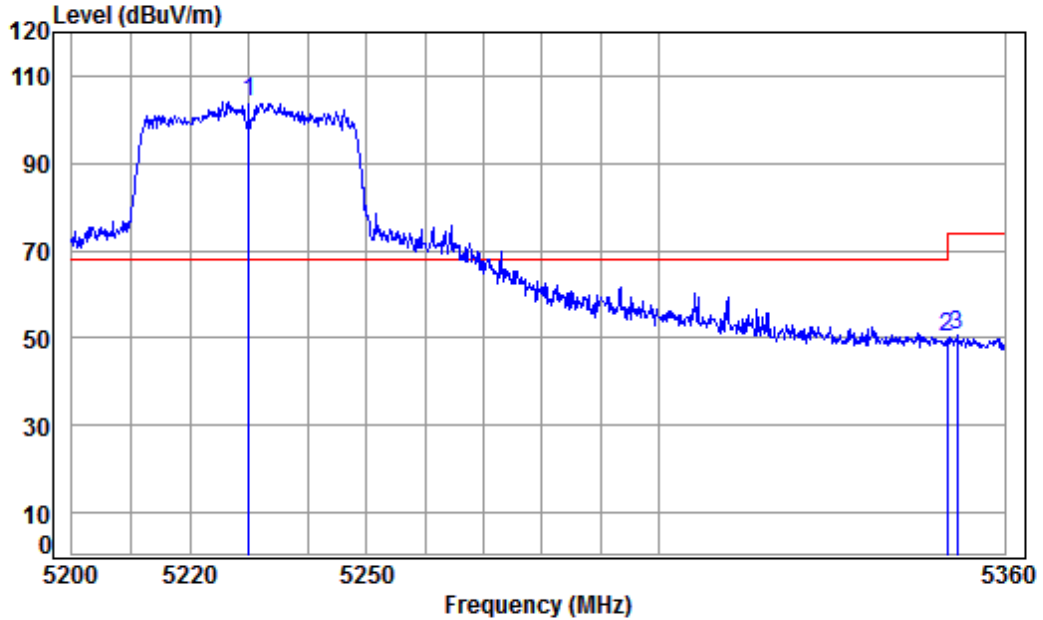

Condition: 3m HORIZONTAL
Job No : 04056CR/04057CR
Mode : 5230 Band edge
: 5G WIFI 11AC40

		Cable	Ant	Preamp	Read	Limit	Over		
	Freq	Loss	Factor	Factor	Level	Level	Line	Limit	
	MHz	dB	dB/m	dB	dBuV	dBuV/m	dBuV/m	dB	
1	pp 5230.000	8.45	34.39	42.28	103.65	104.21	68.20	36.01	peak
2	5350.020	8.63	34.48	42.17	49.03	49.97	74.00	-24.03	peak
3	5351.722	8.63	34.49	42.17	49.76	50.71	74.00	-23.29	peak



Mode:e; Polarization:Horizontal; Modulation:802.11ac; bandwidth:40MHz; Channel:High

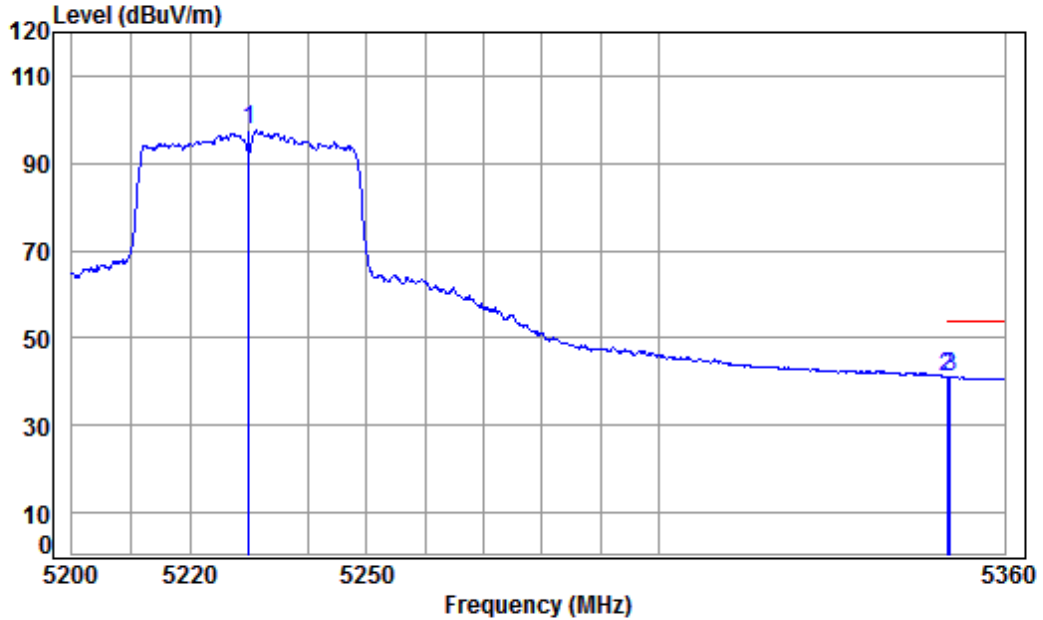

Condition: 3m HORIZONTAL
Job No : 04056CR/04057CR
Mode : 5230 Band edge
: 5G WIFI 11AC40

	Freq	Cable Loss	Ant Factor	Preamplifier	Read Level	Limit Level	Limit Line	Over Limit	Remark
	MHz	dB	dB/m	dB	dBuV	dBuV/m	dBuV/m	dB	
1	5230.000	8.45	34.39	42.28	96.90	97.46	-----	-----	Average
2	pp 5350.020	8.63	34.48	42.17	40.24	41.18	54.00	-12.82	Average
3	5350.587	8.63	34.48	42.17	40.20	41.14	54.00	-12.86	Average

Mode:e; Polarization:Vertical; Modulation:802.11ac; bandwidth:40MHz; Channel:High

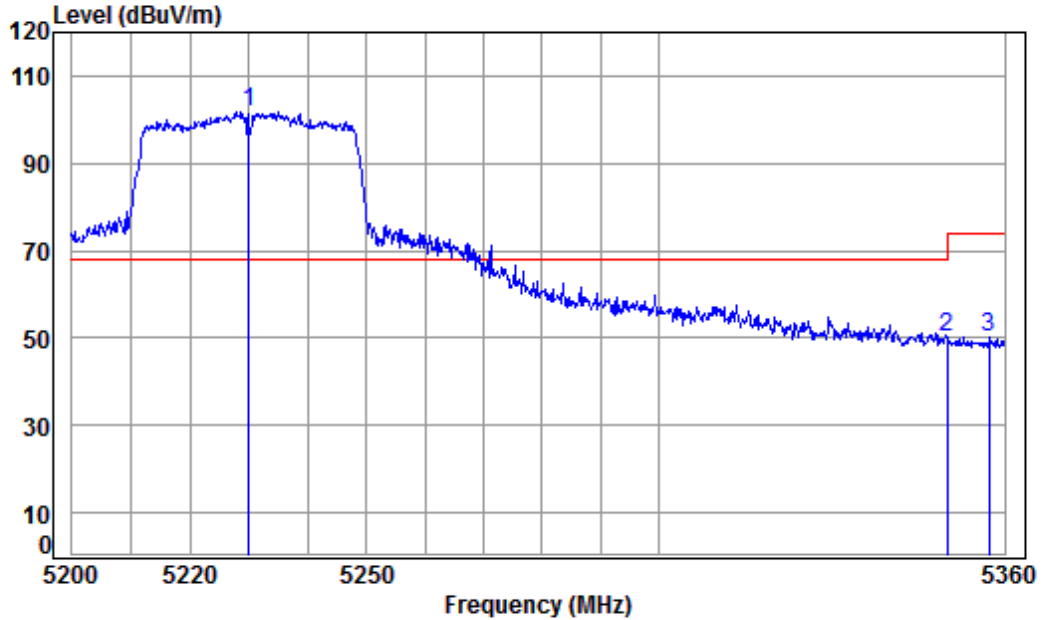

Condition: 3m VERTICAL
 Job No : 04056CR/04057CR
 Mode : 5230 Band edge
 : 5G WIFI 11AC40

	Cable	Ant	Preamp	Read	Limit	Over		
Freq	Loss	Factor	Factor	Level	Level	Line	Limit	Remark
MHz	dB	dB/m	dB	dBuV	dBuV/m	dBuV/m	dB	
1 pp 5230.000	8.45	34.39	42.28	101.21	101.77	68.20	33.57	Peak
2 5350.020	8.63	34.48	42.17	49.26	50.20	74.00	-23.80	Peak
3 5357.239	8.64	34.49	42.16	49.36	50.33	74.00	-23.67	Peak



Mode:e; Polarization:Vertical; Modulation:802.11ac; bandwidth:40MHz; Channel:High

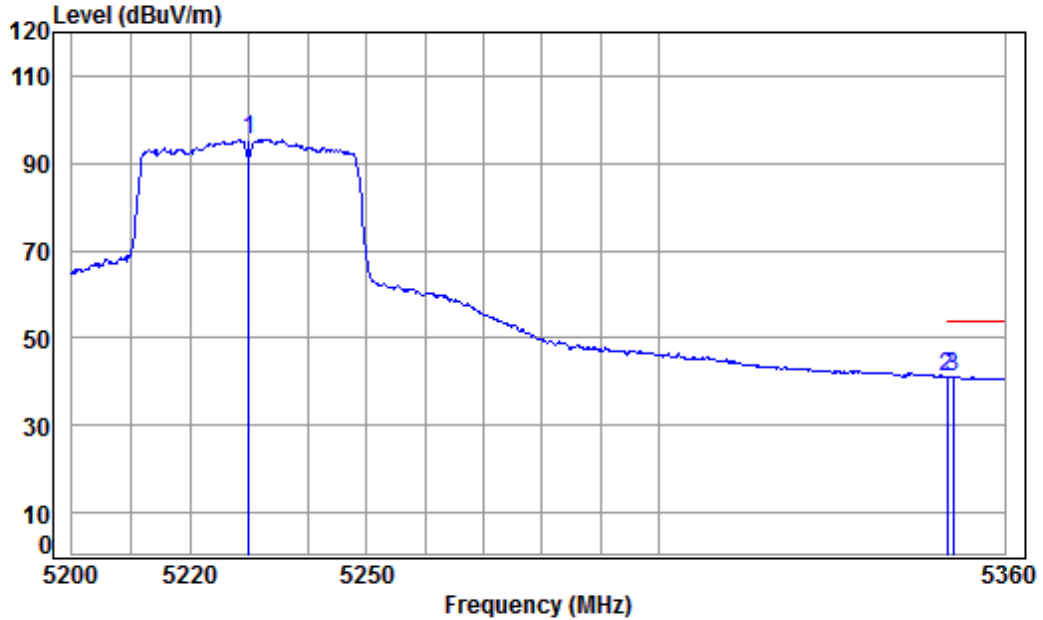

Condition: 3m VERTICAL
Job No : 04056CR/04057CR
Mode : 5230 Band edge
: 5G WIFI 11AC40

	Freq	Cable Loss	Ant Factor	Preamplifier	Read Level	Limit Level	Limit Line	Over Limit	Remark
	MHz	dB	dB/m	dB	dBuV	dBuV/m	dBuV/m	dB	
1	5230.000	8.45	34.39	42.28	95.00	95.56	-----	-----	Average
2	5350.020	8.63	34.48	42.17	40.02	40.96	54.00	-13.04	Average
3 pp	5351.073	8.63	34.48	42.17	40.19	41.13	54.00	-12.87	Average



Mode:e; Polarization:Horizontal; Modulation:802.11ac; bandwidth:80MHz;

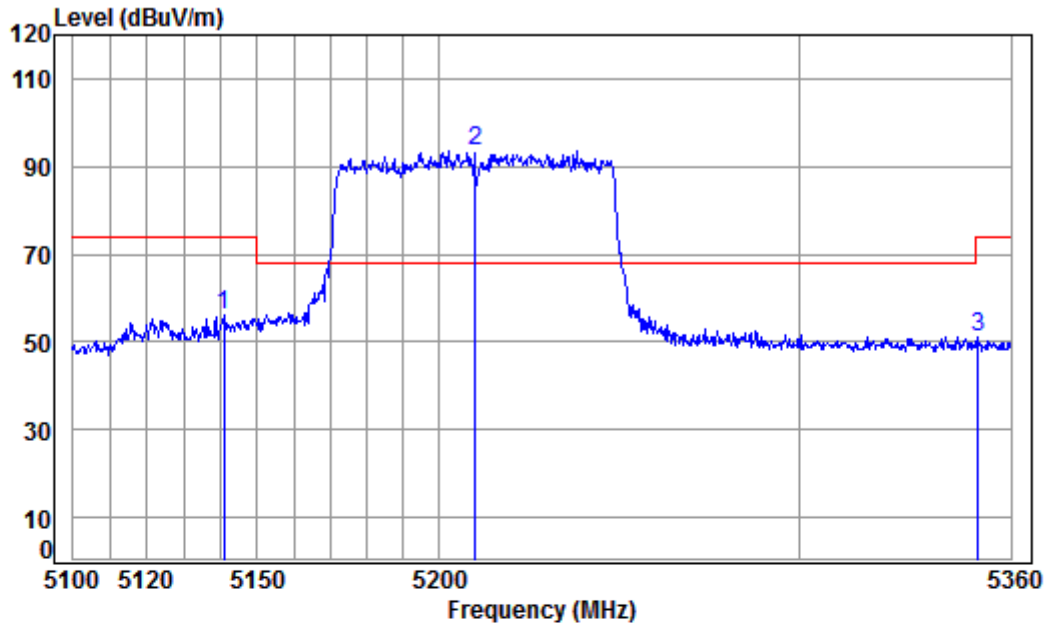

Condition: 3m HORIZONTAL
Job No : 04056CR/04057CR
Mode : 5210 Band edge
: 5G WIFI 11AC80

	Freq	Cable Loss	Ant Factor	Preamp Factor	Read Level	Level	Limit Line	Over Limit	Remark
	MHz	dB	dB/m	dB	dBuV	dBuV/m	dBuV/m	dB	
1	5140.992	8.31	34.32	42.36	55.73	56.00	74.00	-18.00	peak
2	5210.000	8.42	34.37	42.30	92.90	93.39	68.20	25.19	peak
3	5350.680	8.63	34.48	42.17	50.23	51.17	74.00	-22.83	peak



Mode:e; Polarization:Horizontal; Modulation:802.11ac; bandwidth:80MHz;

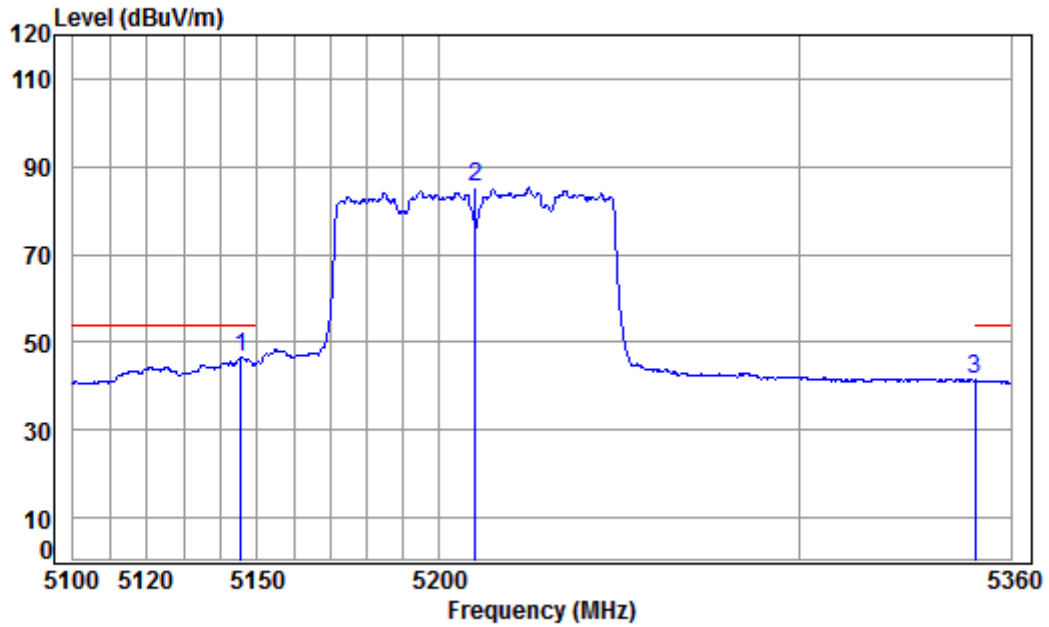

Condition: 3m HORIZONTAL
Job No : 04056CR/04057CR
Mode : 5210 Band edge
: 5G WIFI 11AC80

		Cable	Ant	Preamp	Read	Limit	Over		
	Freq	Loss	Factor	Factor	Level	Level	Line	Limit	Remark
	MHz	dB	dB/m	dB	dBuV	dBuV/m	dBuV/m	dB	
1	pp 5145.595	8.32	34.32	42.36	46.23	46.51	54.00	-7.49	Average
2	5210.000	8.42	34.37	42.30	84.63	85.12	-----	-----	Average
3	5349.882	8.63	34.48	42.17	40.39	41.33	-----	-----	Average

Mode:e; Polarization:Vertical; Modulation:802.11ac; bandwidth:80MHz;

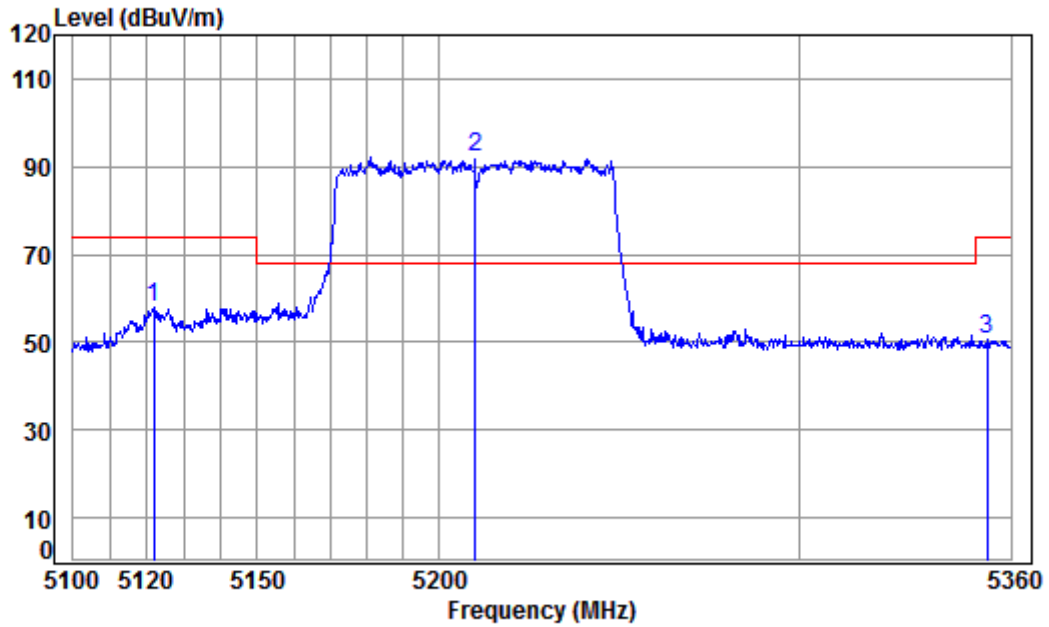

Condition: 3m VERTICAL
 Job No : 04056CR/04057CR
 Mode : 5210 Band edge
 : 5G WIFI 11AC80

	Freq	Cable Loss	Ant Factor	Preamp Factor	Read Level	Limit Level	Over Line	Over Limit	Remark
	MHz	dB	dB/m	dB	dBuV	dBuV/m	dBuV/m	dB	
1	5121.855	8.28	34.30	42.38	57.90	58.10	74.00	-15.90	Peak
2 pp	5210.000	8.42	34.37	42.30	91.49	91.98	68.20	23.78	Peak
3	5353.341	8.63	34.49	42.17	49.64	50.59	74.00	-23.41	Peak



Mode:e; Polarization:Vertical; Modulation:802.11ac; bandwidth:80MHz;

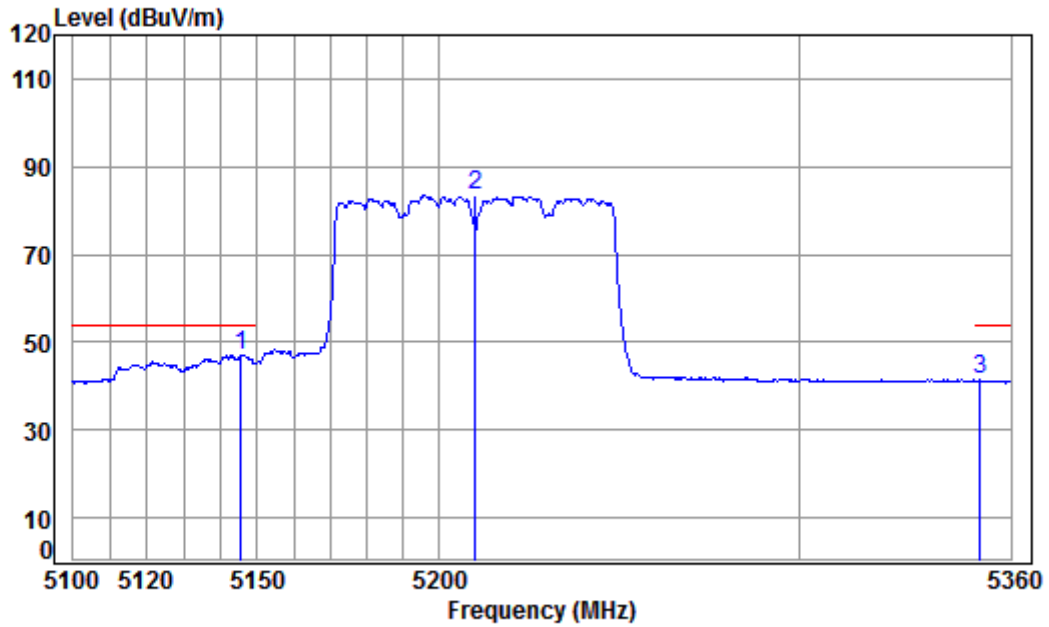

Condition: 3m VERTICAL
Job No : 04056CR/04057CR
Mode : 5210 Band edge
: 5G WIFI 11AC80

		Cable	Ant	Preamp	Read	Limit	Over		
	Freq	Loss	Factor	Factor	Level	Level	Line	Limit	Remark
	MHz	dB	dB/m	dB	dBuV	dBuV/m	dBuV/m	dB	
1	pp 5145.595	8.32	34.32	42.36	46.71	46.99	54.00	-7.01	Average
2	5210.000	8.42	34.37	42.30	83.00	83.49	-----	-----	Average
3	5351.212	8.63	34.48	42.17	40.37	41.31	54.00	-12.69	Average



Mode:f; Polarization:Horizontal; Modulation:802.11a; bandwidth:20MHz; Channel:Low

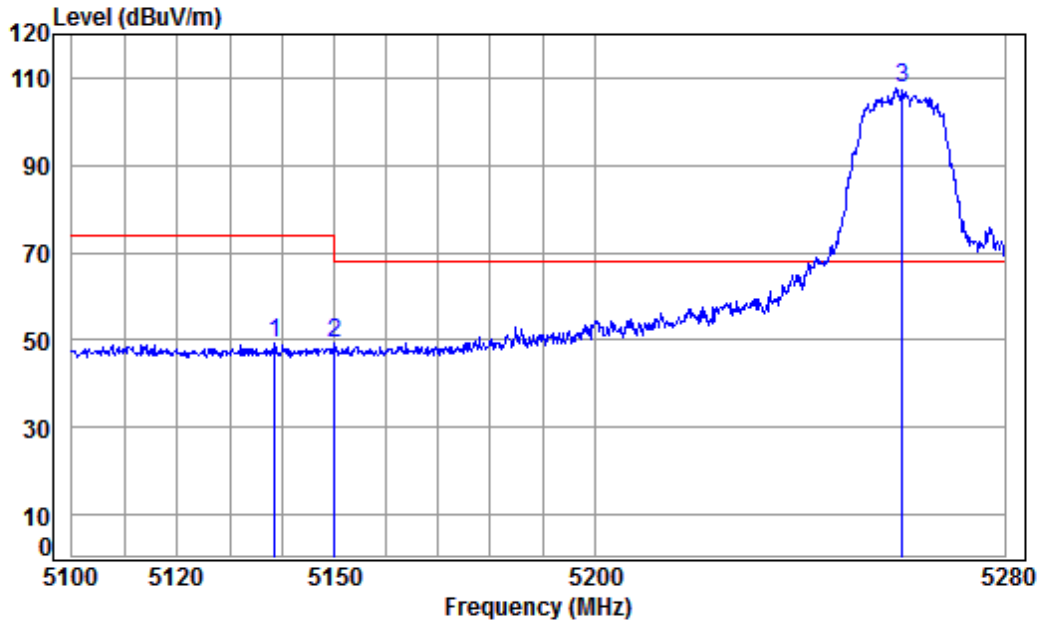

Condition: 3m HORIZONTAL
Job No : 04056CR/04057CR
Mode : 5260 Band edge
: 5G WIFI 11A

	Cable	Ant	Preamp	Read	Limit	Over		
Freq	Loss	Factor	Factor	Level	Level	Line	Limit	Remark
MHz	dB	dB/m	dB	dBuV	dBuV/m	dBuV/m	dB	
1	5138.709	8.31	34.31	42.37	49.10	49.35	74.00	-24.65 peak
2	5149.980	8.33	34.32	42.36	49.11	49.40	74.00	-24.60 peak
3 pp	5260.000	8.49	34.41	42.25	106.88	107.53	68.20	39.33 peak



Mode:f; Polarization:Horizontal; Modulation:802.11a; bandwidth:20MHz; Channel:Low

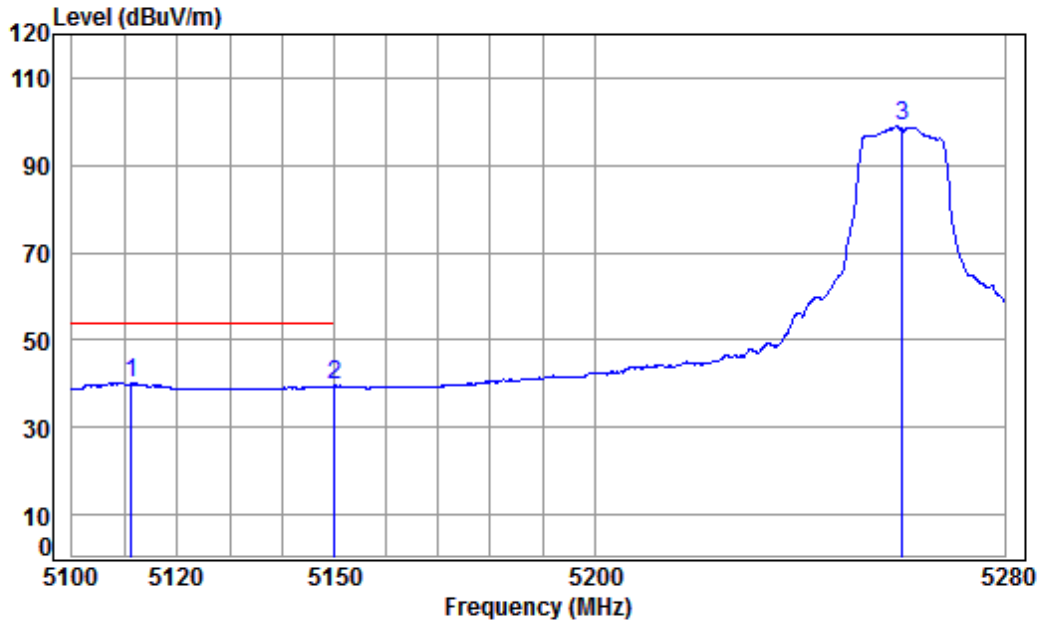

Condition: 3m HORIZONTAL
Job No : 04056CR/04057CR
Mode : 5260 Band edge
: 5G WIFI 11A

		Cable	Ant	Preamp	Read	Limit	Over		
	Freq	Loss	Factor	Factor	Level	Level	Line	Limit	Remark
	MHz	dB	dB/m	dB	dBuV	dBuV/m	dBuV/m	dB	
1	pp 5111.334	8.27	34.29	42.39	39.94	40.11	54.00	-13.89	Average
2	5149.980	8.33	34.32	42.36	39.25	39.54	54.00	-14.46	Average
3	5260.000	8.49	34.41	42.25	98.20	98.85	-----	-----	Average



Mode:f; Polarization:Vertical; Modulation:802.11a; bandwidth:20MHz; Channel:Low

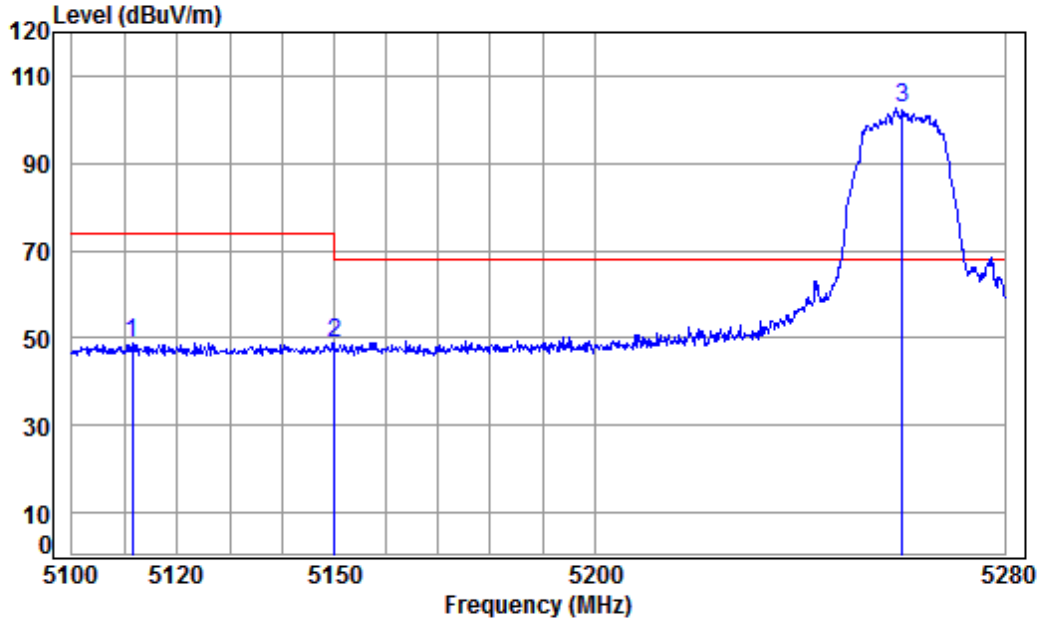

Condition: 3m VERTICAL
Job No : 04056CR/04057CR
Mode : 5260 Band edge
: 5G WIFI 11A

	Cable	Ant	Preamp	Read		Limit	Over	
Freq	Loss	Factor	Factor	Level	Level	Line	Limit	Remark
MHz	dB	dB/m	dB	dBuV	dBuV/m	dBuV/m	dB	
1	5111.511	8.27	34.29	42.39	48.76	48.93	74.00	-25.07 Peak
2	5149.980	8.33	34.32	42.36	48.59	48.88	74.00	-25.12 Peak
3	pp 5260.000	8.49	34.41	42.25	101.90	102.55	68.20	34.35 Peak



Mode:f; Polarization:Vertical; Modulation:802.11a; bandwidth:20MHz; Channel:Low

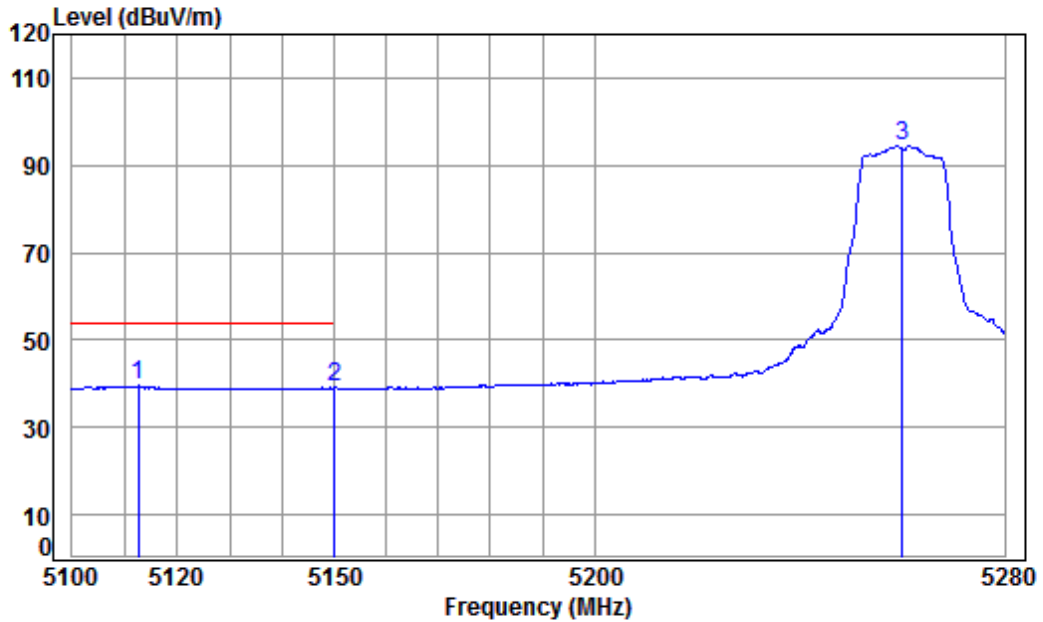

Condition: 3m VERTICAL
Job No : 04056CR/04057CR
Mode : 5260 Band edge
: 5G WIFI 11A

		Cable	Ant	Preamp	Read	Limit	Over		
	Freq	Loss	Factor	Factor	Level	Level	Line	Limit	Remark
	MHz	dB	dB/m	dB	dBuV	dBuV/m	dBuV/m	dB	
1	pp 5112.575	8.27	34.29	42.39	39.34	39.51	54.00	-14.49	Average
2	5149.980	8.33	34.32	42.36	38.81	39.10	54.00	-14.90	Average
3	5260.000	8.49	34.41	42.25	93.75	94.40	-----	-----	Average



Mode:f; Polarization:Horizontal; Modulation:802.11a; bandwidth:20MHz; Channel:High

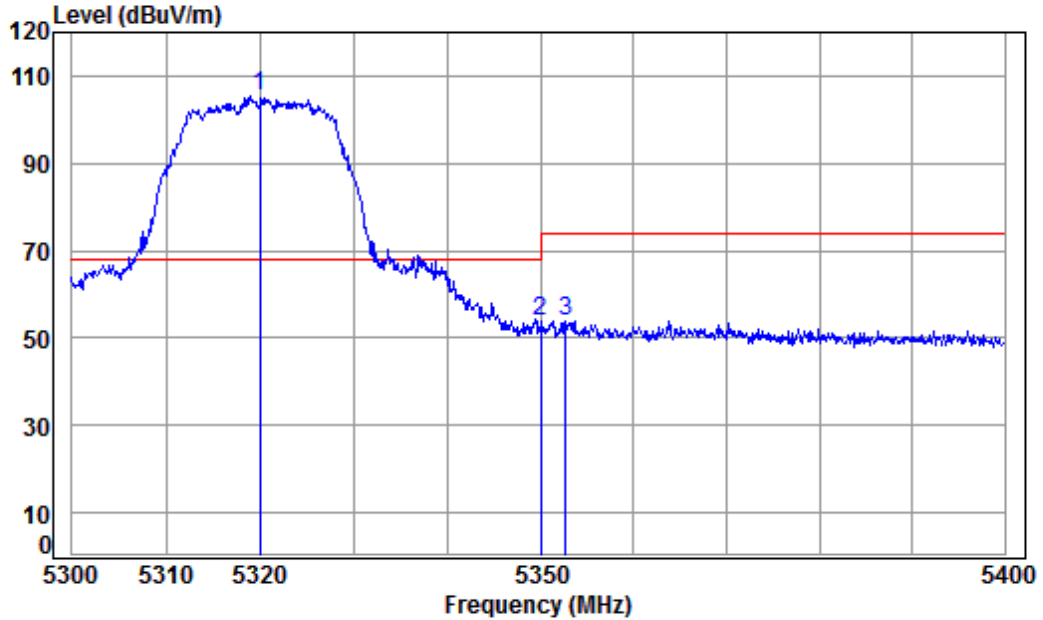

Condition: 3m HORIZONTAL
Job No : 04056CR/04057CR
Mode : 5320 Band edge
: 5G WIFI 11A

		Cable	Ant	Preamp	Read	Limit	Over		
	Freq	Loss	Factor	Factor	Level	Level	Line	Limit	Remark
	MHz	dB	dB/m	dB	dBuV	dBuV/m	dBuV/m	dB	
1	pp 5320.000	8.58	34.46	42.20	104.73	105.57	68.20	37.37	peak
2	5350.020	8.63	34.48	42.17	52.71	53.65	74.00	-20.35	peak
3	5352.667	8.63	34.49	42.17	53.09	54.04	74.00	-19.96	peak



Mode:f; Polarization:Horizontal; Modulation:802.11a; bandwidth:20MHz; Channel:High

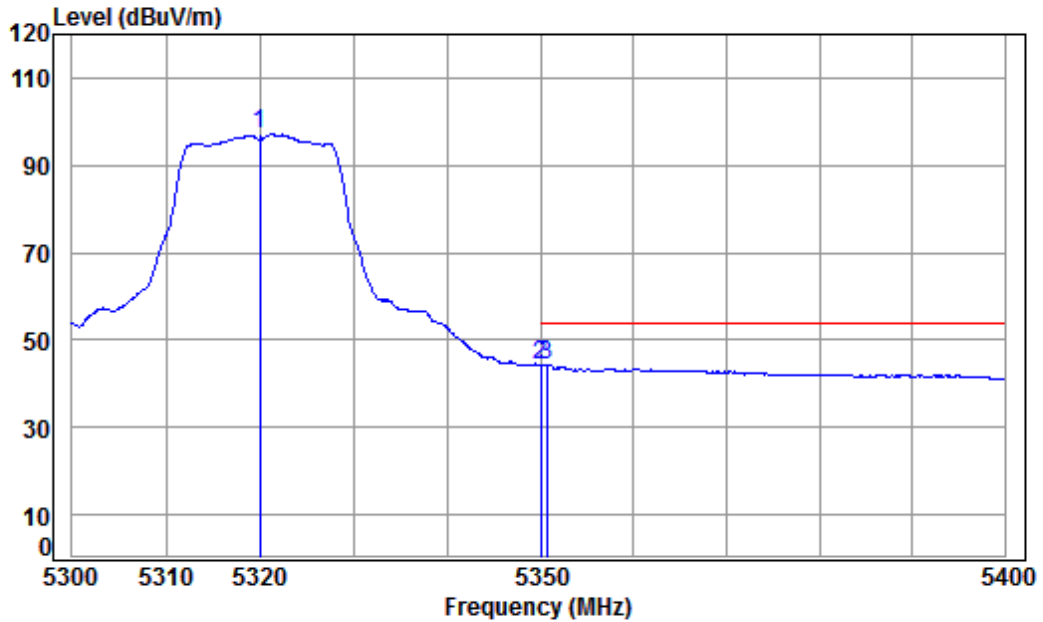

Condition: 3m HORIZONTAL
Job No : 04056CR/04057CR
Mode : 5320 Band edge
: 5G WIFI 11A

	Freq	Cable Loss	Ant Factor	Preamp Factor	Read Level	Limit Level	Limit Line	Over Limit	Remark
	MHz	dB	dB/m	dB	dBuV	dBuV/m	dBuV/m	dB	
1	5320.000	8.58	34.46	42.20	96.25	97.09	-----	-----	Average
2	5350.020	8.63	34.48	42.17	43.34	44.28	54.00	-9.72	Average
3 pp	5350.667	8.63	34.48	42.17	43.35	44.29	54.00	-9.71	Average



Mode:f; Polarization:Vertical; Modulation:802.11a; bandwidth:20MHz; Channel:High

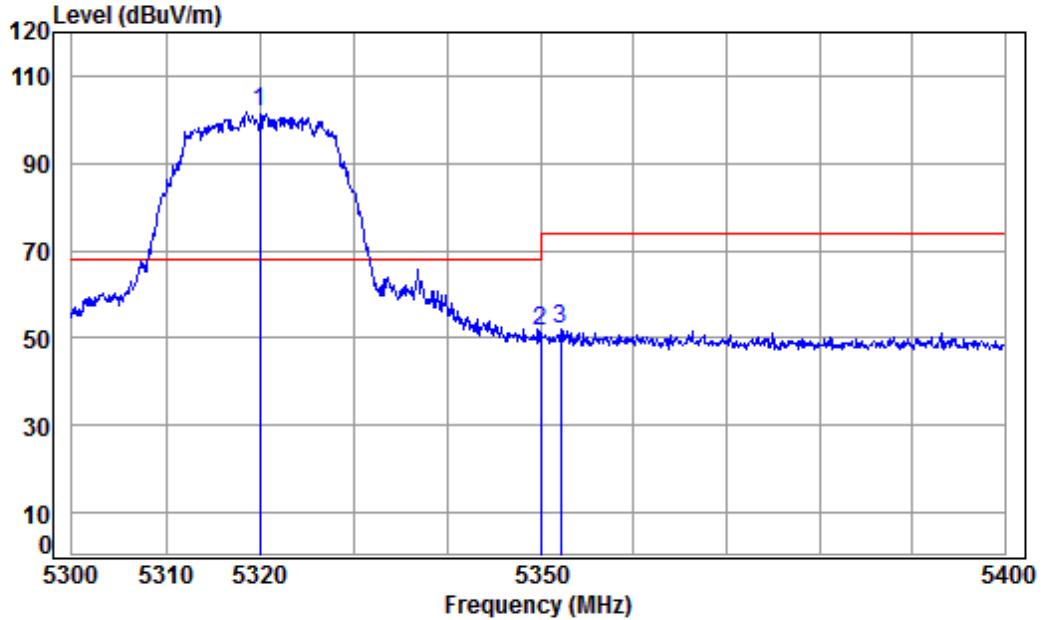

Condition: 3m VERTICAL
Job No : 04056CR/04057CR
Mode : 5320 Band edge
: 5G WIFI 11A

		Cable	Ant	Preamp	Read	Limit	Over		
	Freq	Loss	Factor	Factor	Level	Level	Line	Limit	Remark
	MHz	dB	dB/m	dB	dBuV	dBuV/m	dBuV/m	dB	
1	pp 5320.000	8.58	34.46	42.20	100.93	101.77	68.20	33.57	Peak
2	5350.020	8.63	34.48	42.17	50.42	51.36	74.00	-22.64	Peak
3	5352.167	8.63	34.49	42.17	50.92	51.87	74.00	-22.13	Peak



Mode:f; Polarization:Vertical; Modulation:802.11a; bandwidth:20MHz; Channel:High

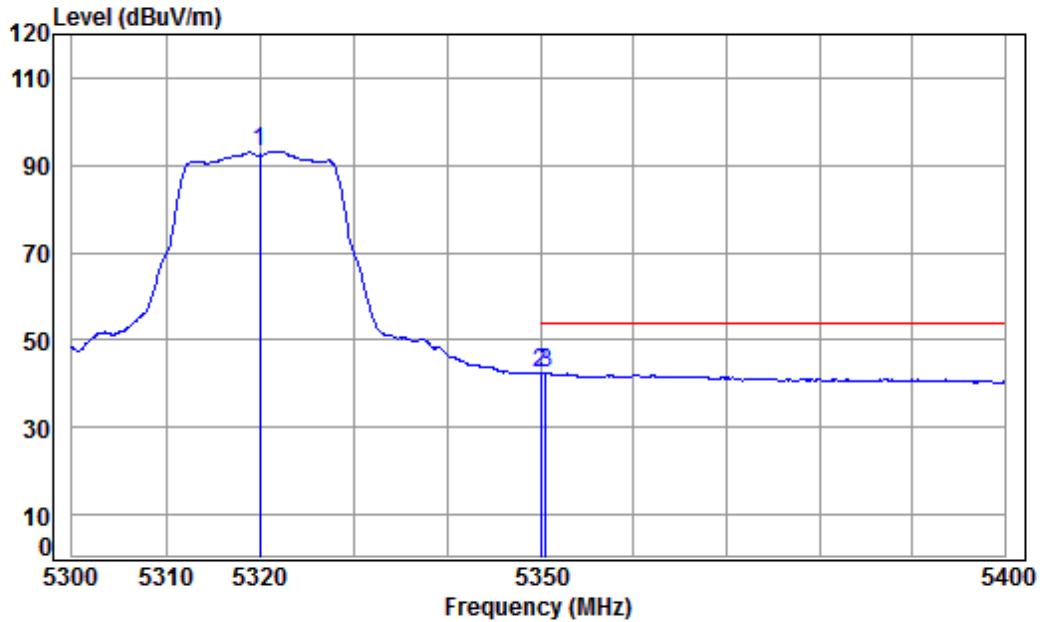

Condition: 3m VERTICAL
Job No : 04056CR/04057CR
Mode : 5320 Band edge
: 5G WIFI 11A

	Freq	Cable Loss	Ant Factor	Preamp Factor	Read Level	Limit Level	Limit Line	Over Limit	Remark
	MHz	dB	dB/m	dB	dBuV	dBuV/m	dBuV/m	dB	
1	5320.000	8.58	34.46	42.20	92.30	93.14	-----	-----	Average
2	pp 5350.020	8.63	34.48	42.17	41.61	42.55	54.00	-11.45	Average
3	5350.566	8.63	34.48	42.17	41.40	42.34	54.00	-11.66	Average



Mode:f; Polarization:Horizontal; Modulation:802.11n; bandwidth:20MHz; Channel:Low

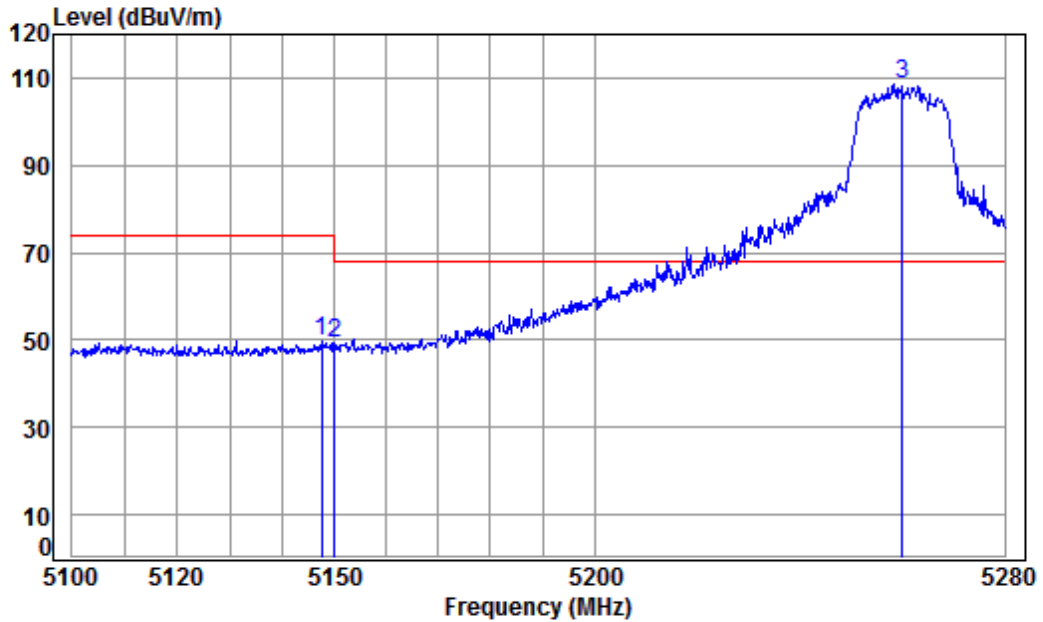

Condition: 3m HORIZONTAL
 Job No : 04056CR/04057CR
 Mode : 5260 Band edge
 : 5G WIFI 11N20

	Freq	Cable Loss	Ant Factor	Preamp Factor	Read Level	Level	Limit	Over	Remark
	MHz	dB	dB/m	dB	dBuV	dBuV/m	dBuV/m	dB	
1	5147.629	8.32	34.32	42.36	49.51	49.79	74.00	-24.21	peak
2	5149.980	8.33	34.32	42.36	49.20	49.49	74.00	-24.51	peak
3	pp 5260.000	8.49	34.41	42.25	107.96	108.61	68.20	40.41	peak



Mode:f; Polarization:Horizontal; Modulation:802.11n; bandwidth:20MHz; Channel:Low

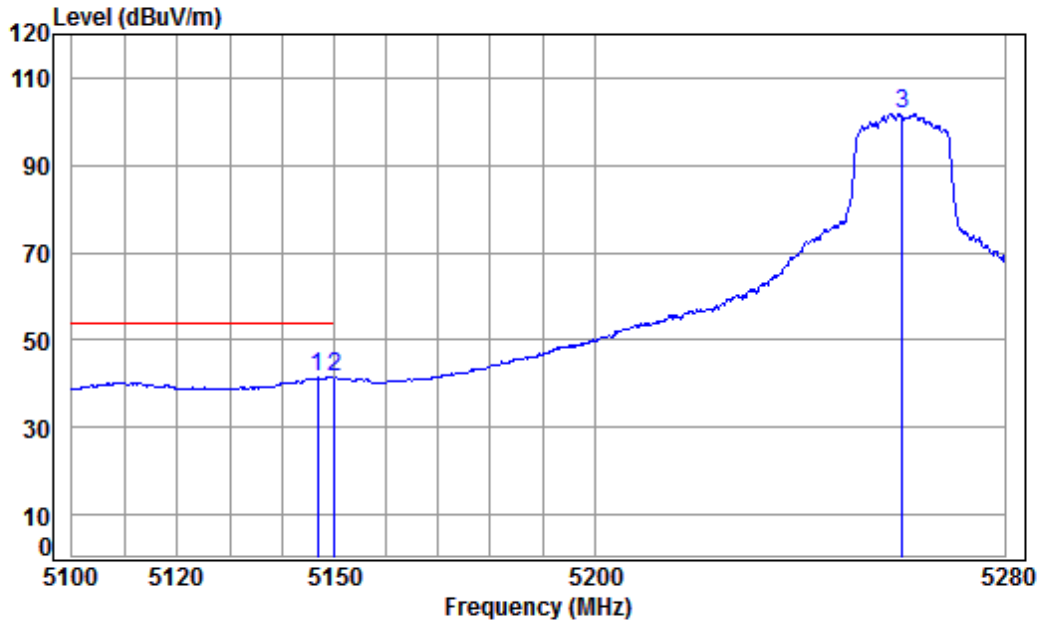

Condition: 3m HORIZONTAL
 Job No : 04056CR/04057CR
 Mode : 5260 Band edge
 : 5G WIFI 11N20

	Freq	Cable Loss	Ant Factor	Preamp Factor	Read Level	Limit Level	Limit Line	Over Limit	Remark
	MHz	dB	dB/m	dB	dBuV	dBuV/m	dBuV/m	dB	
1 pp	5146.915	8.32	34.32	42.36	41.27	41.55	54.00	-12.45	Average
2	5149.980	8.33	34.32	42.36	41.09	41.38	54.00	-12.62	Average
3	5260.000	8.49	34.41	42.25	101.23	101.88	-----	-----	Average



Mode:f; Polarization:Vertical; Modulation:802.11n; bandwidth:20MHz; Channel:Low

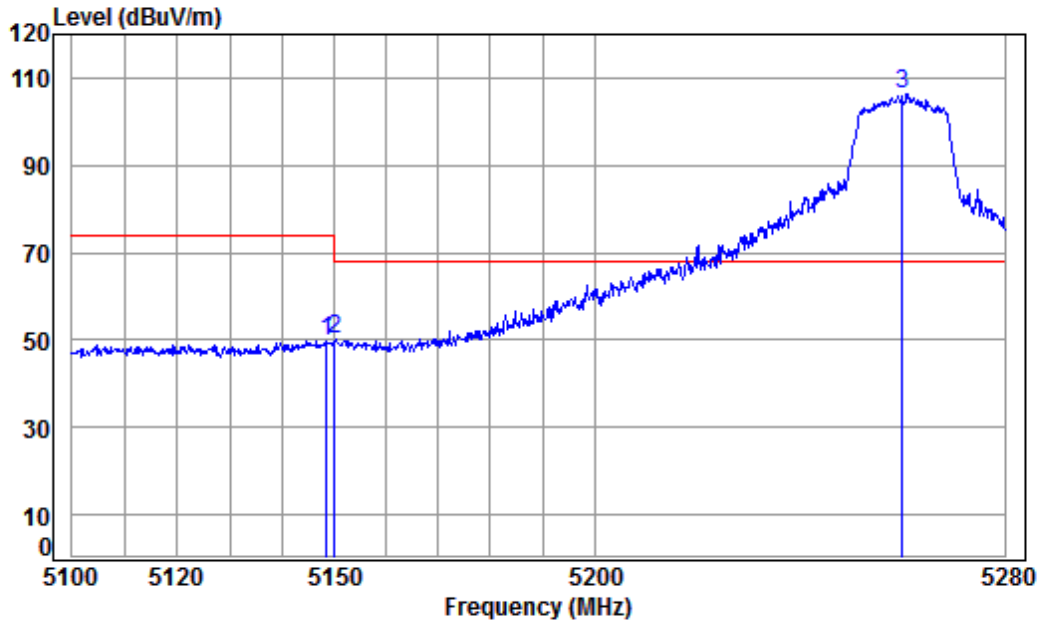

Condition: 3m VERTICAL
Job No : 04056CR/04057CR
Mode : 5260 Band edge
: 5G WIFI 11N20

	Freq	Cable Loss	Ant Factor	Preamp Factor	Read Level	Level	Limit	Over	Remark
	MHz	dB	dB/m	dB	dBuV	dBuV/m	dBuV/m	dB	
1	5148.522	8.32	34.32	42.36	49.30	49.58	74.00	-24.42	Peak
2	5149.980	8.33	34.32	42.36	49.83	50.12	74.00	-23.88	Peak
3	pp 5260.000	8.49	34.41	42.25	105.80	106.45	68.20	38.25	Peak



Mode:f; Polarization:Vertical; Modulation:802.11n; bandwidth:20MHz; Channel:Low

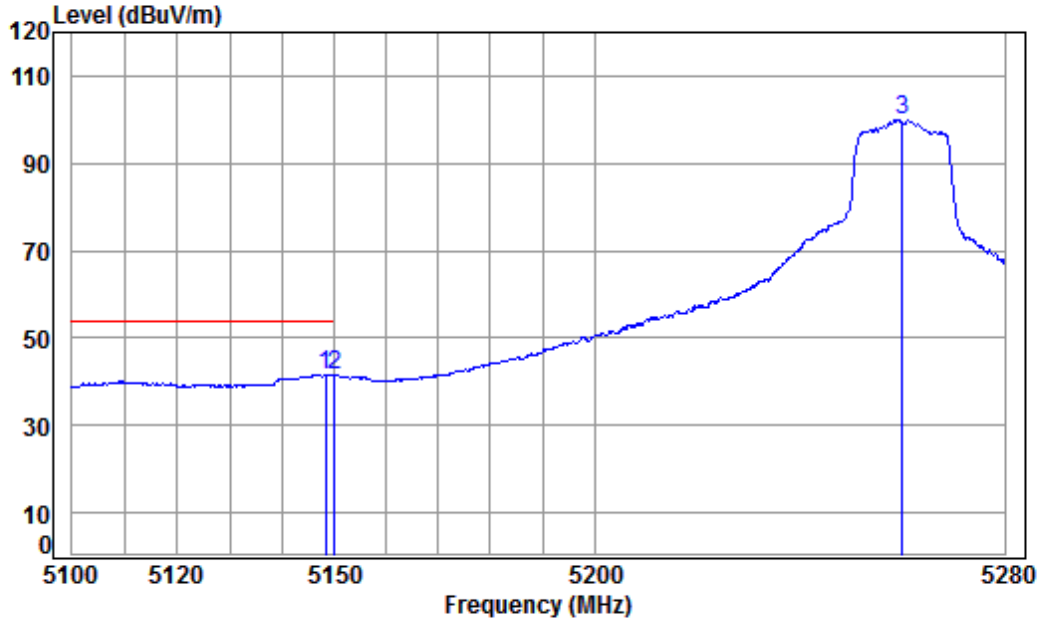

Condition: 3m VERTICAL
Job No : 04056CR/04057CR
Mode : 5260 Band edge
: 5G WIFI 11N20

		Cable	Ant	Preamp	Read	Limit	Over		
	Freq	Loss	Factor	Factor	Level	Level	Line	Limit	Remark
	MHz	dB	dB/m	dB	dBuV	dBuV/m	dBuV/m	dB	
1	pp 5148.343	8.32	34.32	42.36	41.41	41.69	54.00	-12.31	Average
2	5149.980	8.33	34.32	42.36	41.34	41.63	54.00	-12.37	Average
3	5260.000	8.49	34.41	42.25	99.39	100.04	-----	-----	Average

Mode:f; Polarization:Horizontal; Modulation:802.11n; bandwidth:20MHz; Channel:High

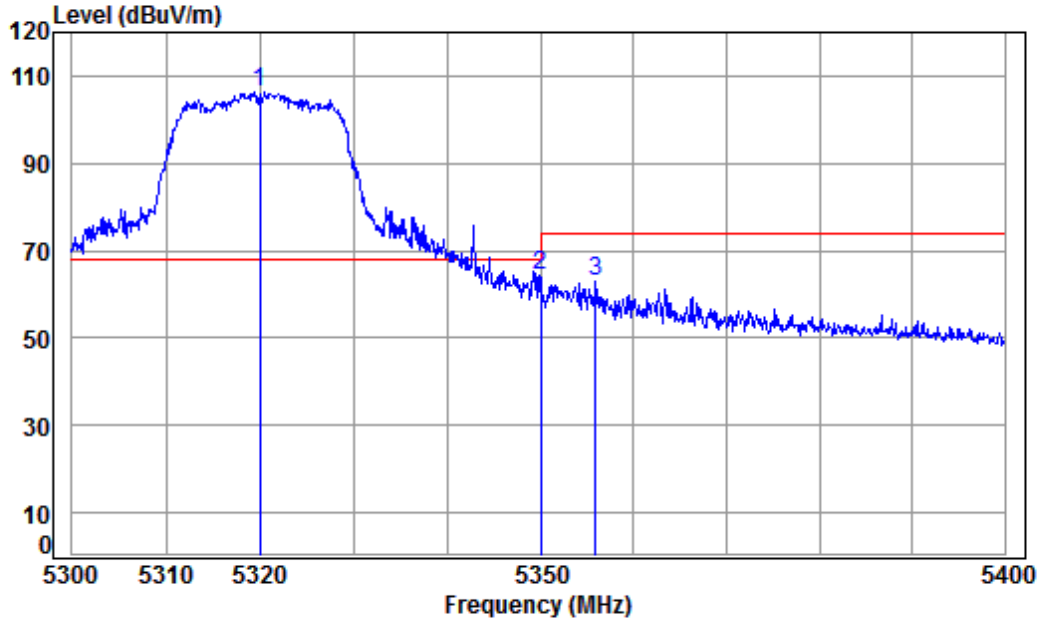

Condition: 3m HORIZONTAL
 Job No : 04056CR/04057CR
 Mode : 5320 Band edge
 : 5G WIFI 11N20

		Cable	Ant	Preamp	Read	Limit	Over		
	Freq	Loss	Factor	Factor	Level	Level	Line	Limit	Remark
	MHz	dB	dB/m	dB	dBuV	dBuV/m	dBuV/m	dB	
1	pp 5320.000	8.58	34.46	42.20	105.42	106.26	68.20	38.06	peak
2	5350.020	8.63	34.48	42.17	63.18	64.12	74.00	-9.88	peak
3	5355.870	8.64	34.49	42.16	61.86	62.83	74.00	-11.17	peak



Mode:f; Polarization:Horizontal; Modulation:802.11n; bandwidth:20MHz; Channel:High

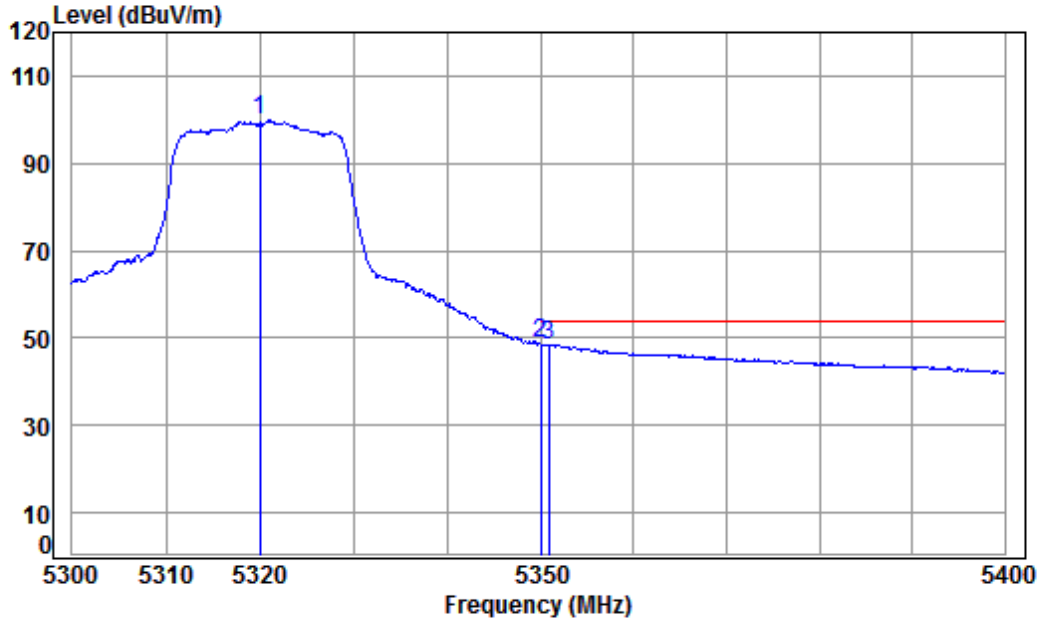

Condition: 3m HORIZONTAL
Job No : 04056CR/04057CR
Mode : 5320 Band edge
: 5G WIFI 11N20

	Freq	Cable Loss	Ant Factor	Preamp Factor	Read Level	Level	Limit Line	Over Limit	Remark
	MHz	dB	dB/m	dB	dBuV	dBuV/m	dBuV/m	dB	
1	5320.000	8.58	34.46	42.20	98.86	99.70	-----	-----	Average
2	pp 5350.020	8.63	34.48	42.17	47.72	48.66	54.00	-5.34	Average
3	5350.866	8.63	34.48	42.17	47.60	48.54	54.00	-5.46	Average



Mode:f; Polarization:Vertical; Modulation:802.11n; bandwidth:20MHz; Channel:High

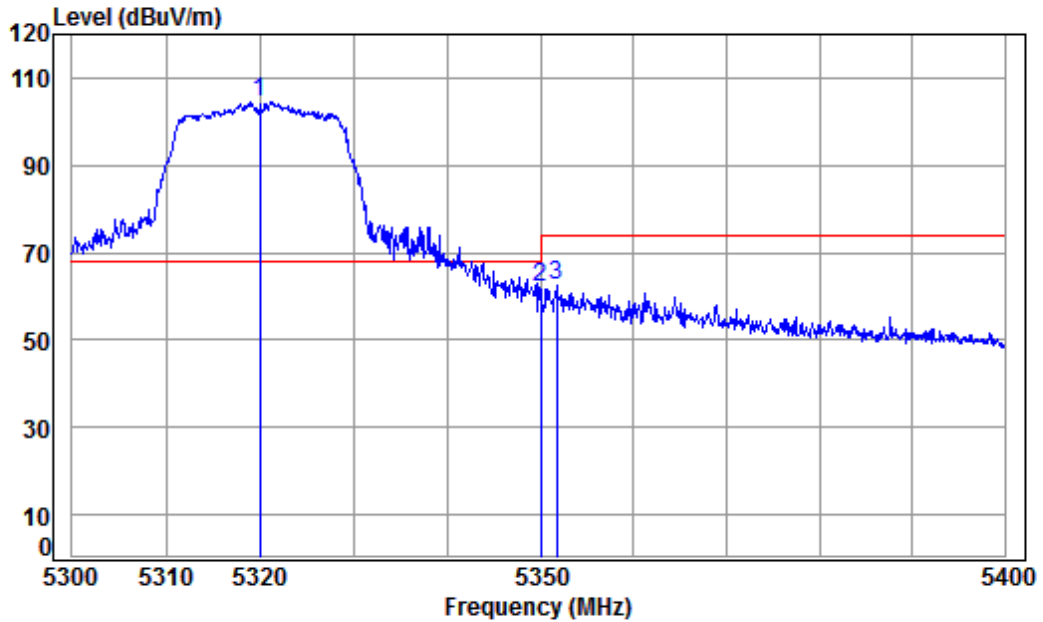

Condition: 3m VERTICAL
Job No : 04056CR/04057CR
Mode : 5320 Band edge
: 5G WIFI 11N20

		Cable	Ant	Preamp	Read	Limit	Over		
	Freq	Loss	Factor	Factor	Level	Level	Line	Limit	Remark
	MHz	dB	dB/m	dB	dBuV	dBuV/m	dBuV/m	dB	
1	pp 5320.000	8.58	34.46	42.20	103.85	104.69	68.20	36.49	Peak
2	5350.020	8.63	34.48	42.17	60.92	61.86	74.00	-12.14	Peak
3	5351.767	8.63	34.49	42.17	61.50	62.45	74.00	-11.55	Peak



Mode:f; Polarization:Vertical; Modulation:802.11n; bandwidth:20MHz; Channel:High

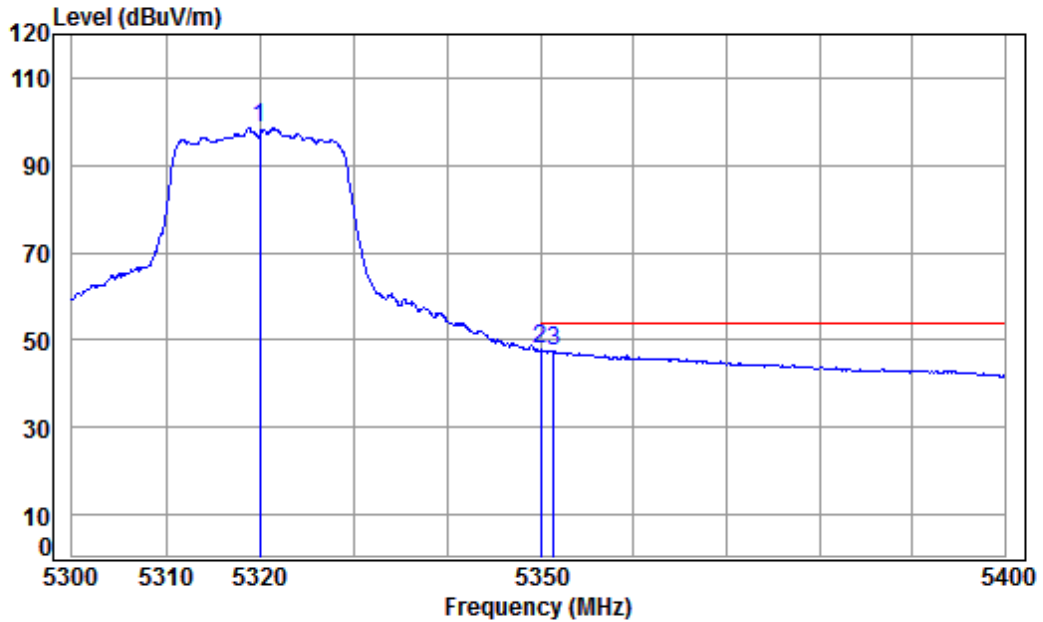

Condition: 3m VERTICAL
Job No : 04056CR/04057CR
Mode : 5320 Band edge
: 5G WIFI 11N20

	Freq	Cable Loss	Ant Factor	Preamp Factor	Read Level	Limit Level	Limit Line	Over Limit	Remark
	MHz	dB	dB/m	dB	dBuV	dBuV/m	dBuV/m	dB	
1	5320.000	8.58	34.46	42.20	97.71	98.55	-----	-----	Average
2	pp 5350.020	8.63	34.48	42.17	46.87	47.81	54.00	-6.19	Average
3	5351.467	8.63	34.49	42.17	46.68	47.63	54.00	-6.37	Average



Mode:f; Polarization:Horizontal; Modulation:802.11n; bandwidth:40MHz; Channel:Low

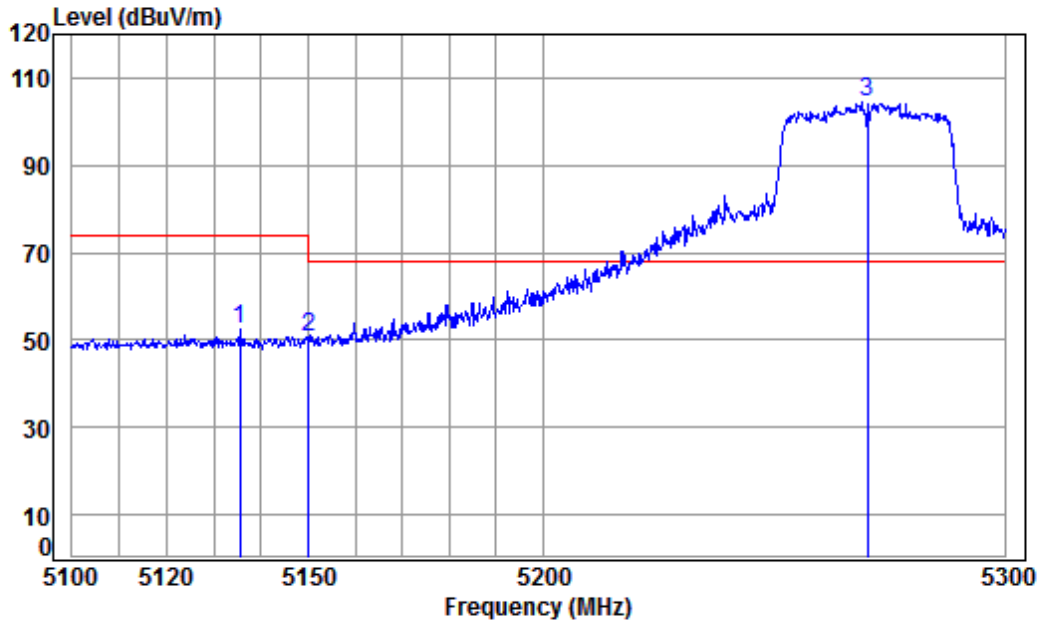

Condition: 3m HORIZONTAL
Job No : 04056CR/04057CR
Mode : 5270 Band edge
: 5G WIFI 11N40

	Freq	Cable Loss	Ant Factor	Preamp Factor	Read Level	Limit Level	Over Line	Over Limit	Remark
	MHz	dB	dB/m	dB	dBuV	dBuV/m	dBuV/m	dB	
1	5135.435	8.30	34.31	42.37	52.12	52.36	74.00	-21.64	peak
2	5149.980	8.33	34.32	42.36	50.39	50.68	74.00	-23.32	peak
3	pp 5270.000	8.51	34.42	42.24	103.68	104.37	68.20	36.17	peak



Mode:f; Polarization:Horizontal; Modulation:802.11n; bandwidth:40MHz; Channel:Low

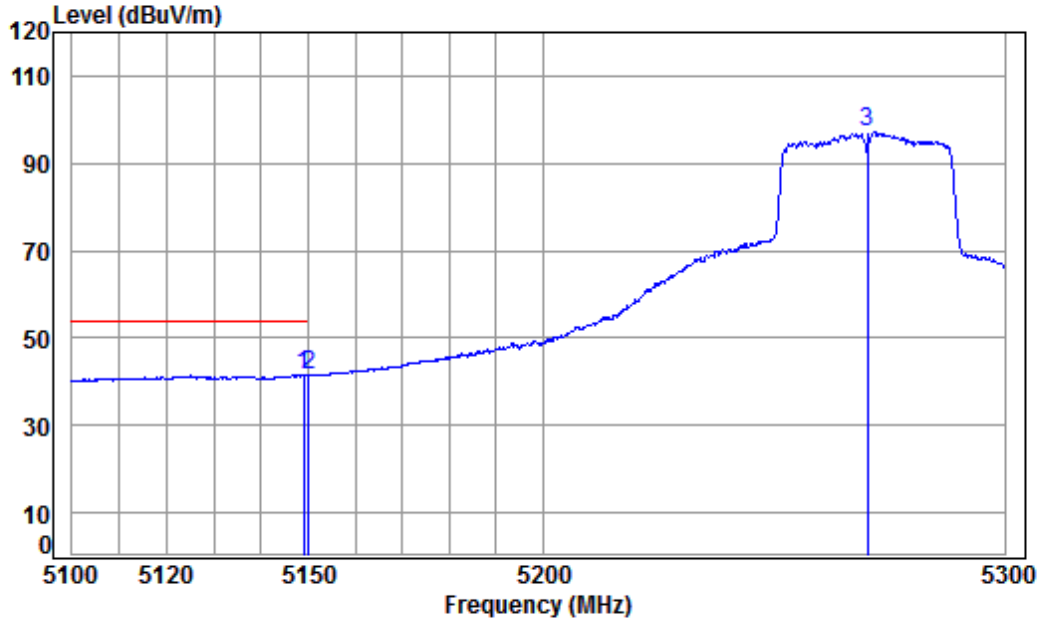

Condition: 3m HORIZONTAL
Job No : 04056CR/04057CR
Mode : 5270 Band edge
: 5G WIFI 11N40

	Freq	Cable Loss	Ant Factor	Preamplifier	Read Level	Limit Level	Limit Line	Over Limit	Remark
	MHz	dB	dB/m	dB	dBuV	dBuV/m	dBuV/m	dB	
1	5149.083	8.32	34.32	42.36	41.28	41.56	54.00	-12.44	Average
2	pp 5149.980	8.33	34.32	42.36	41.27	41.56	54.00	-12.44	Average
3	5270.000	8.51	34.42	42.24	96.68	97.37	-----	-----	Average



Mode:f; Polarization:Vertical; Modulation:802.11n; bandwidth:40MHz; Channel:Low

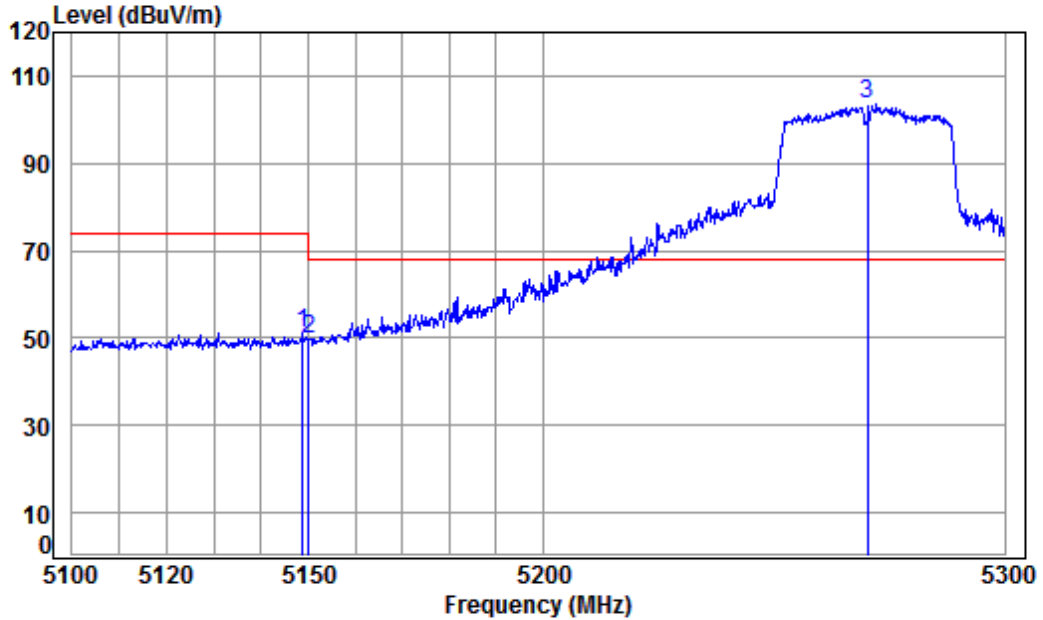

Condition: 3m VERTICAL
Job No : 04056CR/04057CR
Mode : 5270 Band edge
: 5G WIFI 11N40

	Freq	Cable Loss	Ant Factor	Preamp Factor	Read Level	Level	Limit	Over	Remark
	MHz	dB	dB/m	dB	dBuV	dBuV/m	dBuV/m	dB	
1	5148.885	8.32	34.32	42.36	51.00	51.28	74.00	-22.72	Peak
2	5149.980	8.33	34.32	42.36	49.58	49.87	74.00	-24.13	Peak
3	pp 5270.000	8.51	34.42	42.24	102.74	103.43	68.20	35.23	Peak



Mode:f; Polarization:Vertical; Modulation:802.11n; bandwidth:40MHz; Channel:Low

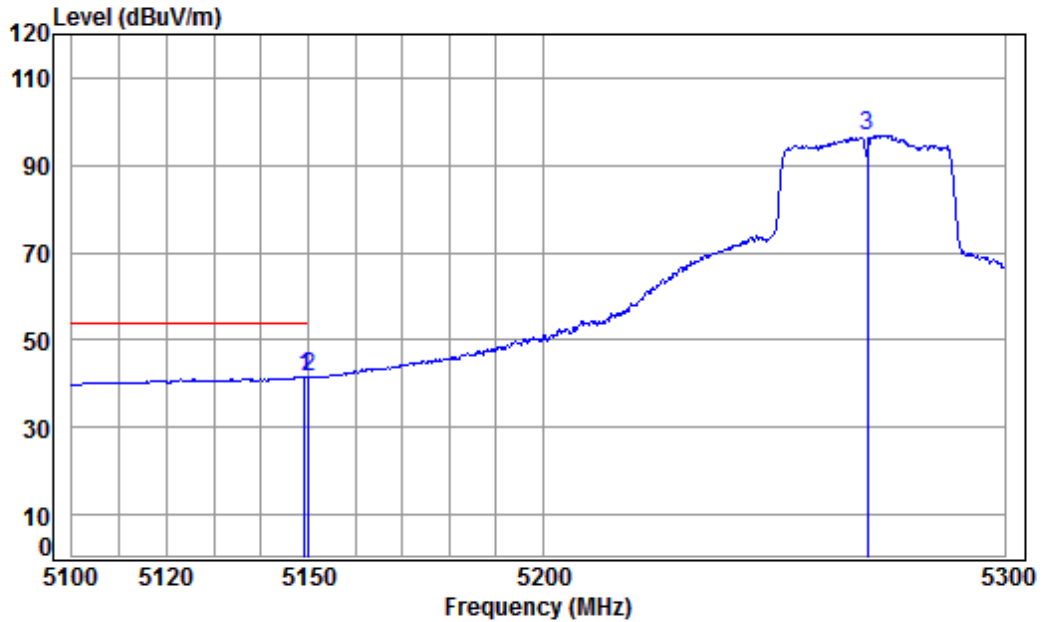

Condition: 3m VERTICAL
Job No : 04056CR/04057CR
Mode : 5270 Band edge
: 5G WIFI 11N40

	Freq	Cable Loss	Ant Factor	Preamp Factor	Read Level	Level	Limit	Over	Remark
	MHz	dB	dB/m	dB	dBuV	dBuV/m	dBuV/m	dB	
1	5149.281	8.32	34.32	42.36	41.33	41.61	54.00	-12.39	Average
2	pp 5149.980	8.33	34.32	42.36	41.34	41.63	54.00	-12.37	Average
3	5270.000	8.51	34.42	42.24	96.16	96.85	-----	-----	Average

Mode:f; Polarization:Horizontal; Modulation:802.11n; bandwidth:40MHz; Channel:High

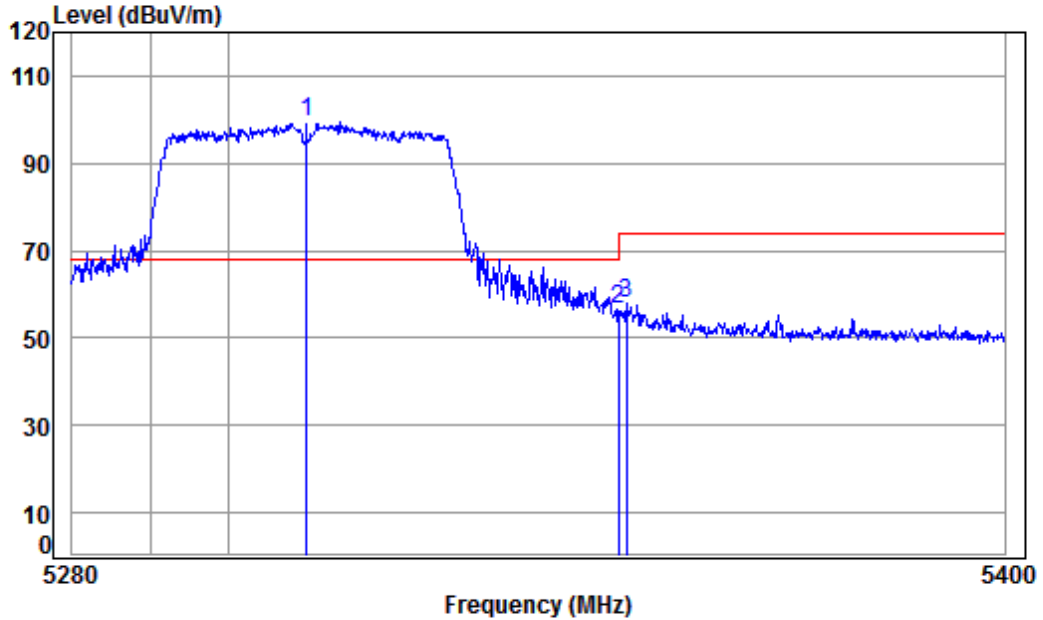

Condition: 3m HORIZONTAL
 Job No : 04056CR/04057CR
 Mode : 5310 Band edge
 : 5G WIFI 11N40

		Cable	Ant	Preamp	Read	Limit	Over	
	Freq	Loss	Factor	Factor	Level	Level	Line	Limit Remark
	MHz	dB	dB/m	dB	dBuV	dBuV/m	dBuV/m	dB
1	pp 5310.000	8.57	34.45	42.21	98.45	99.26	68.20	31.06 peak
2	5350.020	8.63	34.48	42.17	55.50	56.44	74.00	-17.56 peak
3	5351.075	8.63	34.48	42.17	56.98	57.92	74.00	-16.08 peak



Mode:f; Polarization:Horizontal; Modulation:802.11n; bandwidth:40MHz; Channel:High

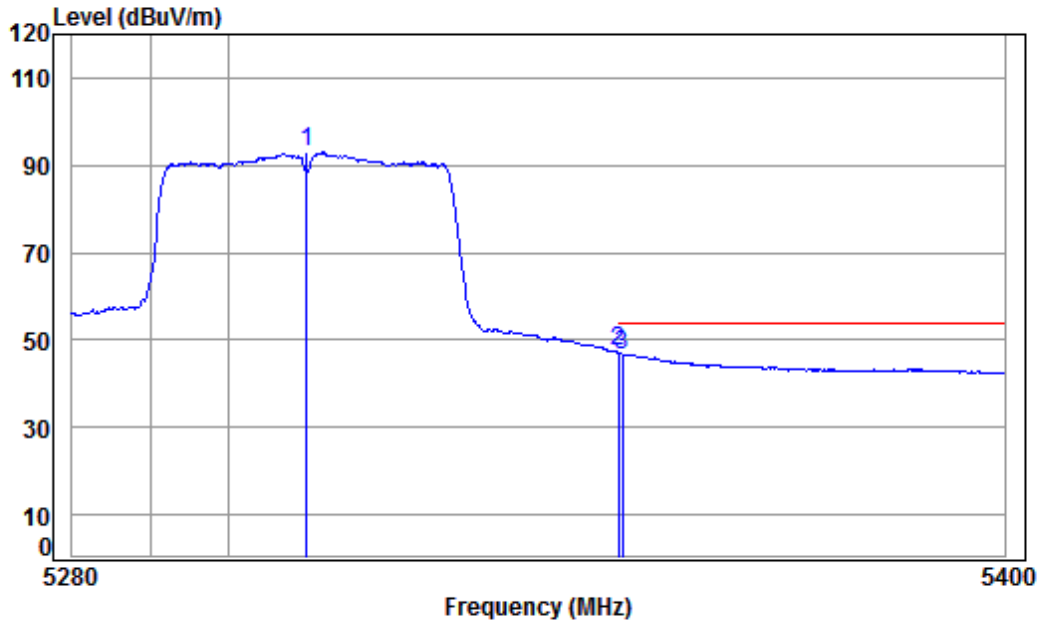

Condition: 3m HORIZONTAL
Job No : 04056CR/04057CR
Mode : 5310 Band edge
: 5G WIFI 11N40

	Freq	Cable Loss	Ant Factor	Preamp Factor	Read Level	Limit Level	Limit Line	Over Limit	Remark
	MHz	dB	dB/m	dB	dBuV	dBuV/m	dBuV/m	dB	
1	5310.000	8.57	34.45	42.21	92.10	92.91	-----	-----	Average
2	pp 5350.020	8.63	34.48	42.17	46.41	47.35	54.00	-6.65	Average
3	5350.474	8.63	34.48	42.17	45.79	46.73	54.00	-7.27	Average



Mode:f; Polarization:Vertical; Modulation:802.11n; bandwidth:40MHz; Channel:High

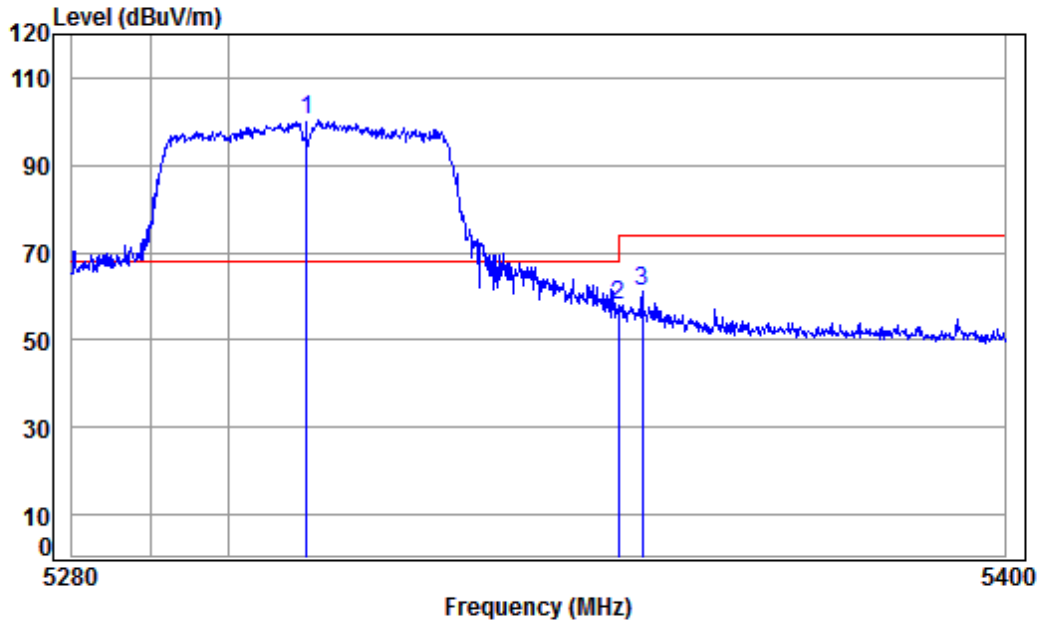

Condition: 3m VERTICAL
Job No : 04056CR/04057CR
Mode : 5310 Band edge
: 5G WIFI 11N40

		Cable	Ant	Preamp	Read	Limit	Over		
	Freq	Loss	Factor	Factor	Level	Level	Line	Limit	Remark
	MHz	dB	dB/m	dB	dBuV	dBuV/m	dBuV/m	dB	
1	pp 5310.000	8.57	34.45	42.21	99.45	100.26	68.20	32.06	Peak
2	5350.020	8.63	34.48	42.17	57.09	58.03	74.00	-15.97	Peak
3	5353.120	8.63	34.49	42.17	60.28	61.23	74.00	-12.77	Peak



Mode:f; Polarization:Vertical; Modulation:802.11n; bandwidth:40MHz; Channel:High

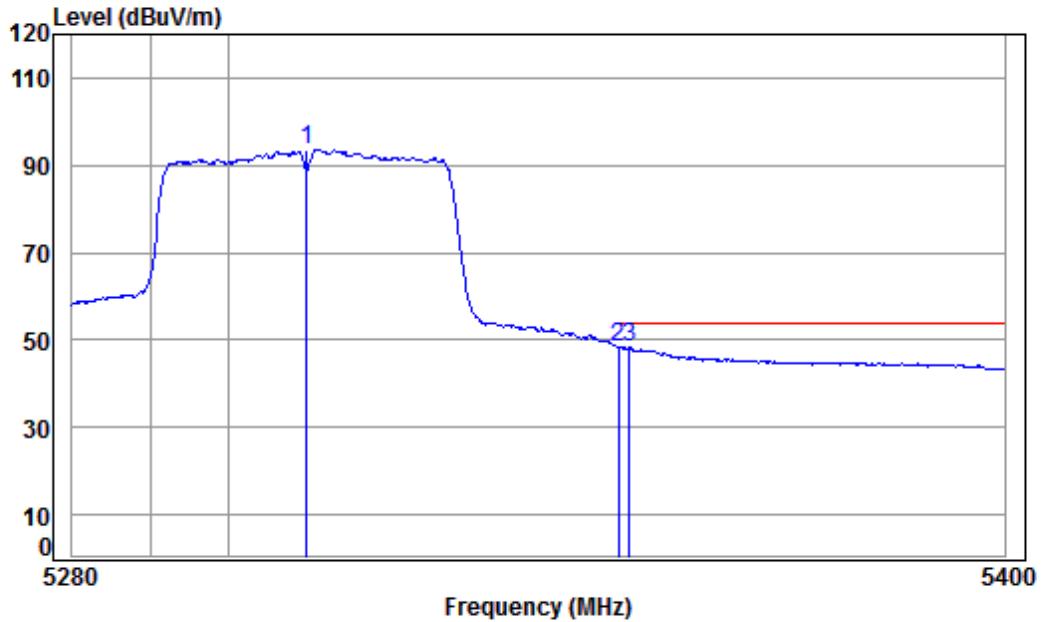

Condition: 3m VERTICAL
Job No : 04056CR/04057CR
Mode : 5310 Band edge
: 5G WIFI 11N40

	Freq	Cable Loss	Ant Factor	Preamp Factor	Read Level	Limit Level	Limit Line	Over Limit	Remark
	MHz	dB	dB/m	dB	dBuV	dBuV/m	dBuV/m	dB	
1	5310.000	8.57	34.45	42.21	92.94	93.75	-----	-----	Average
2	pp 5350.020	8.63	34.48	42.17	47.64	48.58	54.00	-5.42	Average
3	5351.436	8.63	34.49	42.17	47.34	48.29	54.00	-5.71	Average



Mode:f; Polarization:Horizontal; Modulation:802.11ac; bandwidth:20MHz; Channel:Low

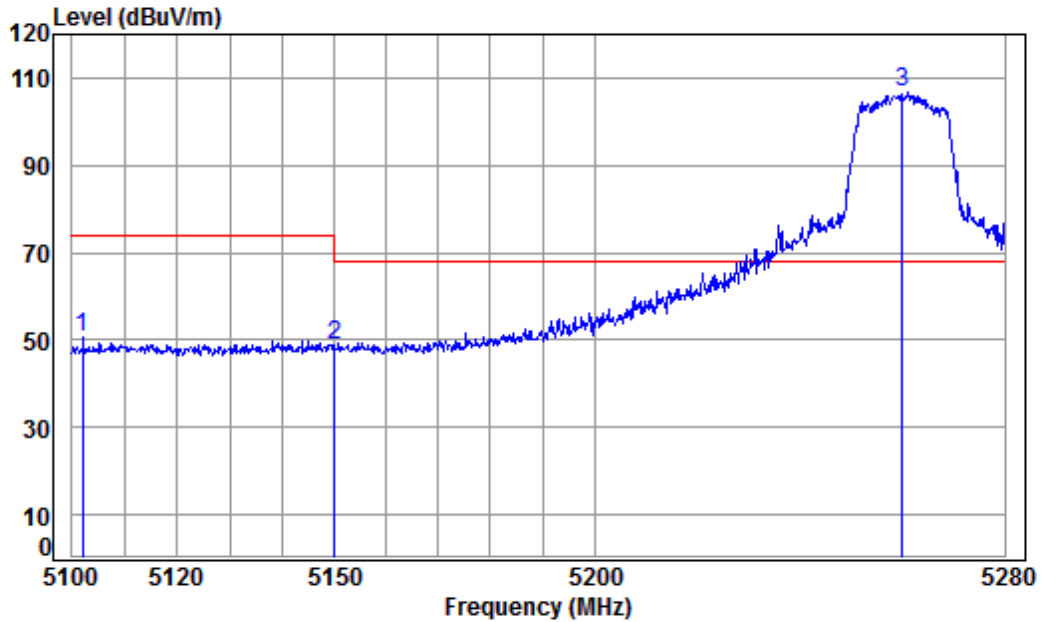

Condition: 3m HORIZONTAL
Job No : 04056CR/04057CR
Mode : 5260 Band edge
: 5G WIFI 11AC20

	Freq	Cable Loss	Ant Factor	Preamplifier	Read Level	Limit Level	Limit Line	Over Limit	Remark
	MHz	dB	dB/m	dB	dBuV	dBuV/m	dBuV/m	dB	
1	5102.123	8.25	34.28	42.40	50.32	50.45	74.00	-23.55	peak
2	5149.980	8.33	34.32	42.36	48.35	48.64	74.00	-25.36	peak
3	pp 5260.000	8.49	34.41	42.25	106.14	106.79	68.20	38.59	peak



Mode:f; Polarization:Horizontal; Modulation:802.11ac; bandwidth:20MHz; Channel:Low

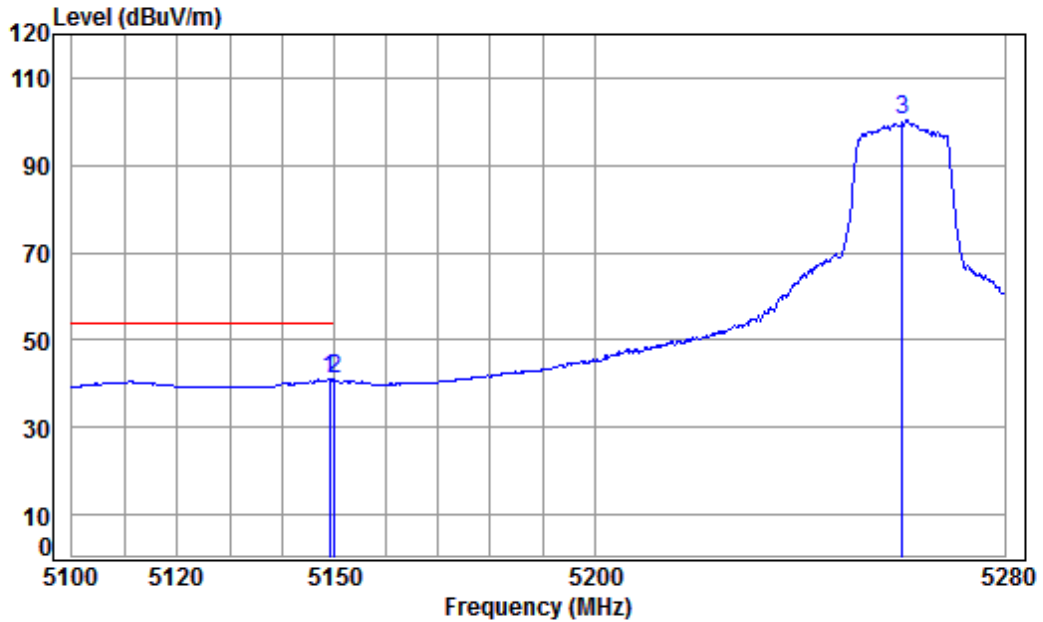

Condition: 3m HORIZONTAL
Job No : 04056CR/04057CR
Mode : 5260 Band edge
: 5G WIFI 11AC20

	Freq	Cable Loss	Ant Factor	Preamp Factor	Read Level	Limit Level	Limit Line	Over Limit	Remark
	MHz	dB	dB/m	dB	dBuV	dBuV/m	dBuV/m	dB	
1	5149.058	8.32	34.32	42.36	40.62	40.90	54.00	-13.10	Average
2	pp 5149.980	8.33	34.32	42.36	40.71	41.00	54.00	-13.00	Average
3	5260.000	8.49	34.41	42.25	99.92	100.57	-----	-----	Average



Mode:f; Polarization:Vertical; Modulation:802.11ac; bandwidth:20MHz; Channel:Low

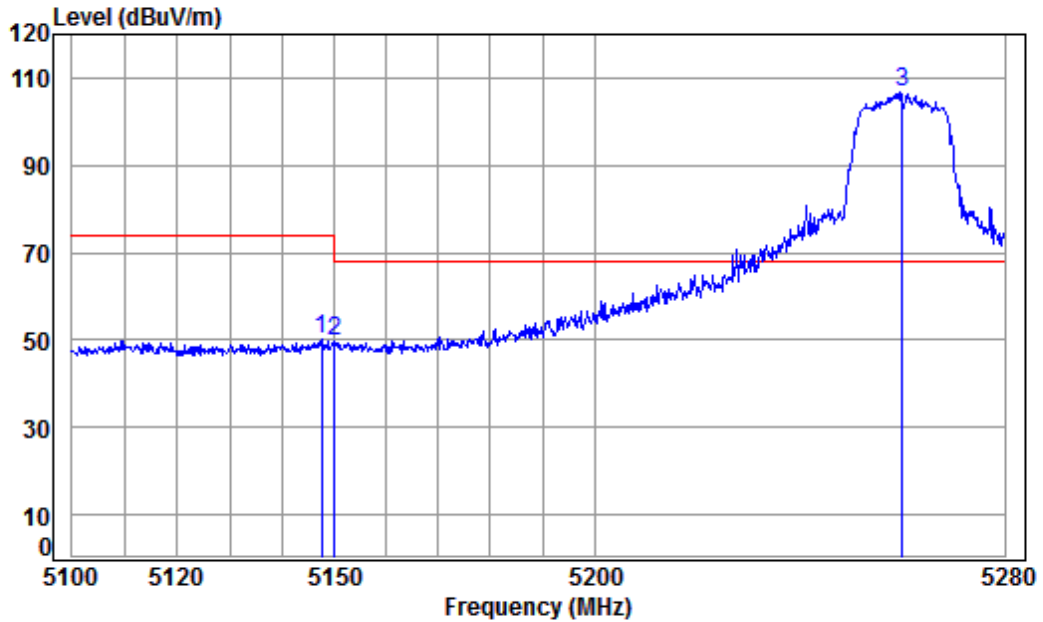

Condition: 3m VERTICAL
 Job No : 04056CR/04057CR
 Mode : 5260 Band edge
 : 5G WIFI 11AC20

	Freq	Cable Loss	Ant Factor	Preamplifier	Read Level	Level	Limit	Over	Remark
	MHz	dB	dB/m	dB	dBuV	dBuV/m	dBuV/m	dB	
1	5147.629	8.32	34.32	42.36	49.97	50.25	74.00	-23.75	Peak
2	5149.980	8.33	34.32	42.36	49.23	49.52	74.00	-24.48	Peak
3	pp 5260.000	8.49	34.41	42.25	105.93	106.58	68.20	38.38	Peak



Mode:f; Polarization:Vertical; Modulation:802.11ac; bandwidth:20MHz; Channel:Low

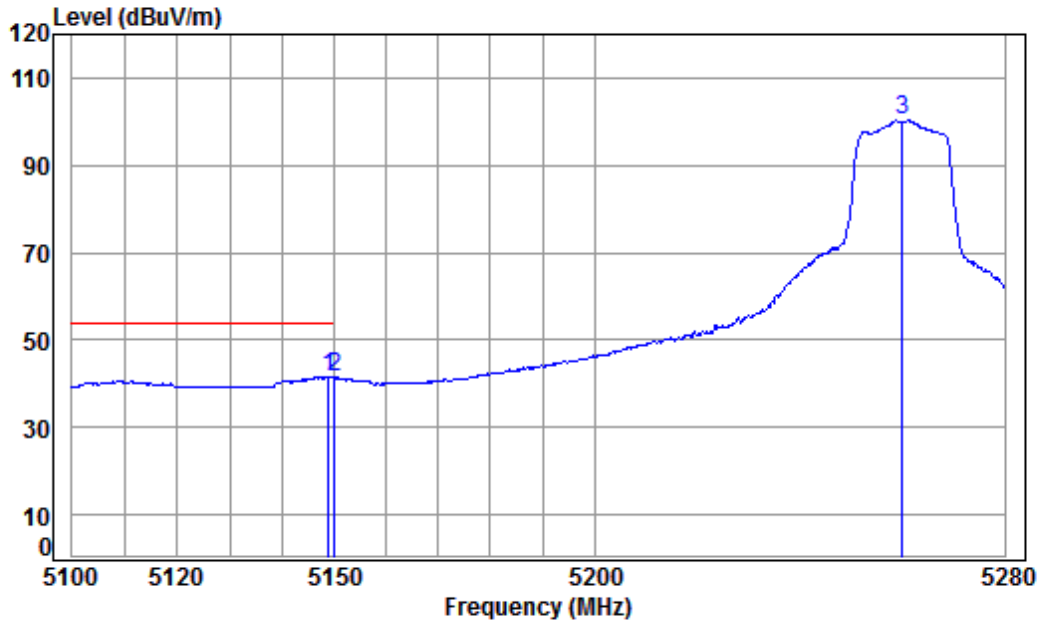

Condition: 3m VERTICAL
Job No : 04056CR/04057CR
Mode : 5260 Band edge
: 5G WIFI 11AC20

		Cable	Ant	Preamp	Read	Limit	Over		
	Freq	Loss	Factor	Factor	Level	Level	Line	Limit	Remark
	MHz	dB	dB/m	dB	dBuV	dBuV/m	dBuV/m	dB	
1	pp 5148.879	8.32	34.32	42.36	41.32	41.60	54.00	-12.40	Average
2	5149.980	8.33	34.32	42.36	41.21	41.50	54.00	-12.50	Average
3	5260.000	8.49	34.41	42.25	99.63	100.28	-----	-----	Average



Mode:f; Polarization:Horizontal; Modulation:802.11ac; bandwidth:20MHz; Channel:High

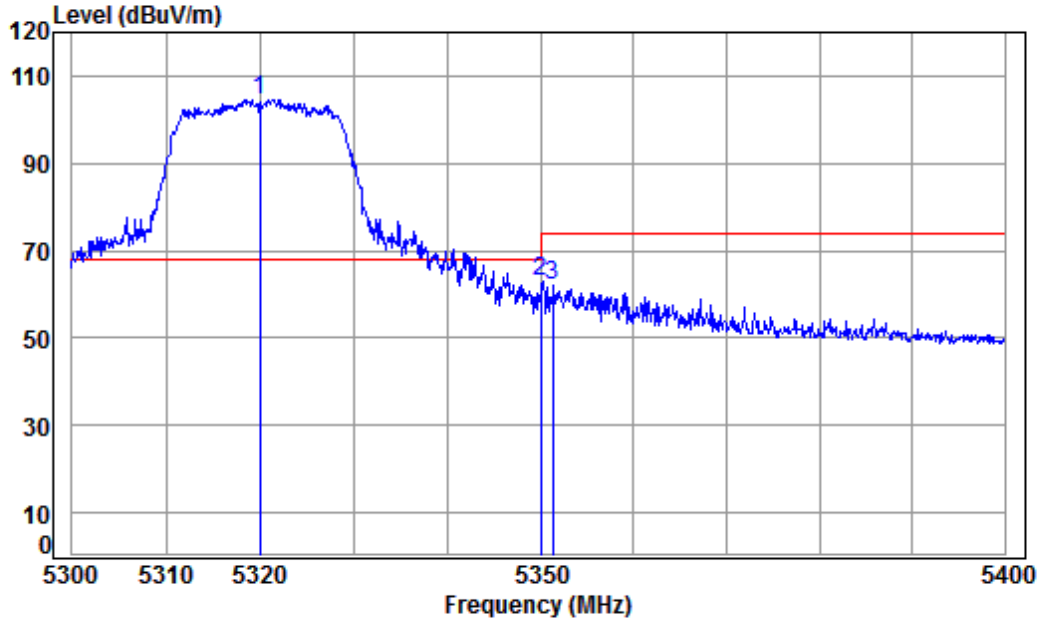

Condition: 3m HORIZONTAL
Job No : 04056CR/04057CR
Mode : 5320 Band edge
: 5G WIFI 11AC20

		Cable	Ant	Preamp	Read	Limit	Over		
	Freq	Loss	Factor	Factor	Level	Level	Line	Limit	Remark
	MHz	dB	dB/m	dB	dBuV	dBuV/m	dBuV/m	dB	
1	pp 5320.000	8.58	34.46	42.20	103.79	104.63	68.20	36.43	peak
2	5350.020	8.63	34.48	42.17	61.89	62.83	74.00	-11.17	peak
3	5351.367	8.63	34.49	42.17	61.15	62.10	74.00	-11.90	peak



Mode:f; Polarization:Horizontal; Modulation:802.11ac; bandwidth:20MHz; Channel:High

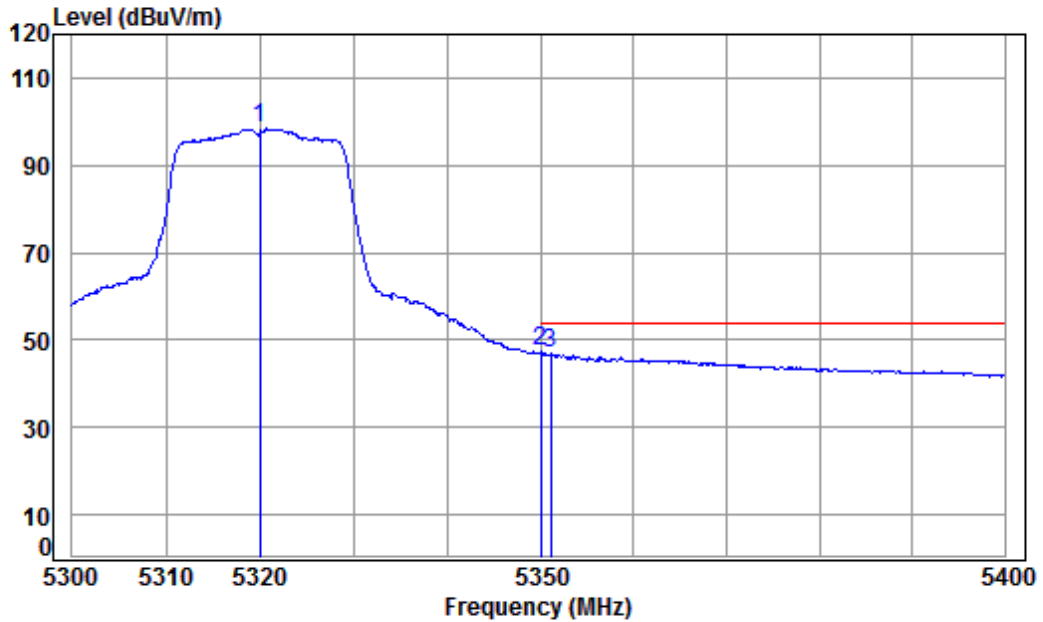

Condition: 3m HORIZONTAL
Job No : 04056CR/04057CR
Mode : 5320 Band edge
: 5G WIFI 11AC20

	Freq	Cable Loss	Ant Factor	Preamplifier	Read Level	Limit Level	Limit Line	Over Limit	Remark
	MHz	dB	dB/m	dB	dBuV	dBuV/m	dBuV/m	dB	
1	5320.000	8.58	34.46	42.20	97.49	98.33	-----	-----	Average
2	pp 5350.020	8.63	34.48	42.17	46.33	47.27	54.00	-6.73	Average
3	5351.066	8.63	34.48	42.17	45.90	46.84	54.00	-7.16	Average



Mode:f; Polarization:Vertical; Modulation:802.11ac; bandwidth:20MHz; Channel:High

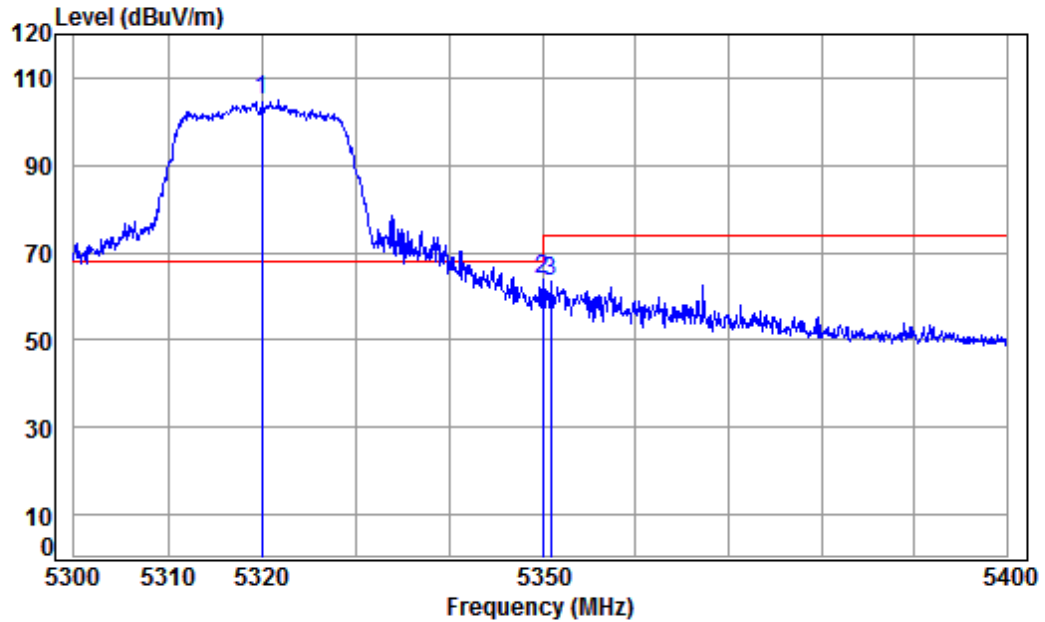

Condition: 3m VERTICAL
Job No : 04056CR/04057CR
Mode : 5320 Band edge
: 5G WIFI 11AC20

		Cable	Ant	Preamp	Read	Limit	Over		
	Freq	Loss	Factor	Factor	Level	Level	Line	Limit	Remark
	MHz	dB	dB/m	dB	dBuV	dBuV/m	dBuV/m	dB	
1	pp 5320.000	8.58	34.46	42.20	104.02	104.86	68.20	36.66	Peak
2	5350.020	8.63	34.48	42.17	63.03	63.97	74.00	-10.03	Peak
3	5350.866	8.63	34.48	42.17	62.51	63.45	74.00	-10.55	Peak



Mode:f; Polarization:Vertical; Modulation:802.11ac; bandwidth:20MHz; Channel:High

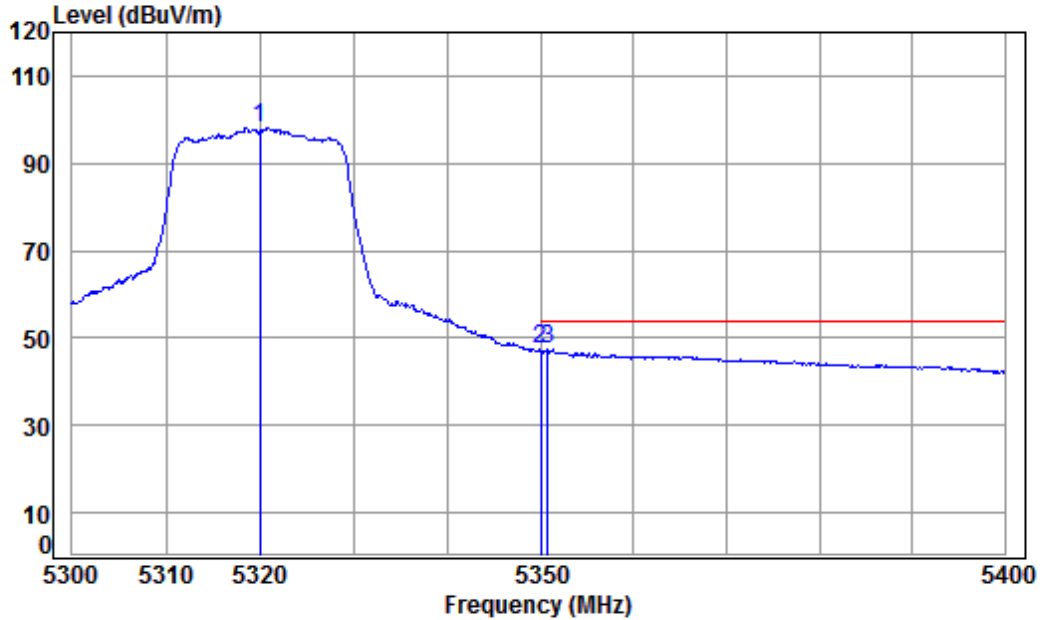

Condition: 3m VERTICAL
Job No : 04056CR/04057CR
Mode : 5320 Band edge
: 5G WIFI 11AC20

	Freq	Cable Loss	Ant Factor	Preamplifier	Read Level	Limit Level	Limit Line	Over Limit	Remark
	MHz	dB	dB/m	dB	dBuV	dBuV/m	dBuV/m	dB	
1	5320.000	8.58	34.46	42.20	97.20	98.04	-----	-----	Average
2	5350.020	8.63	34.48	42.17	46.34	47.28	54.00	-6.72	Average
3 pp	5350.767	8.63	34.48	42.17	46.53	47.47	54.00	-6.53	Average



Mode:f; Polarization:Horizontal; Modulation:802.11ac; bandwidth:40MHz; Channel:Low

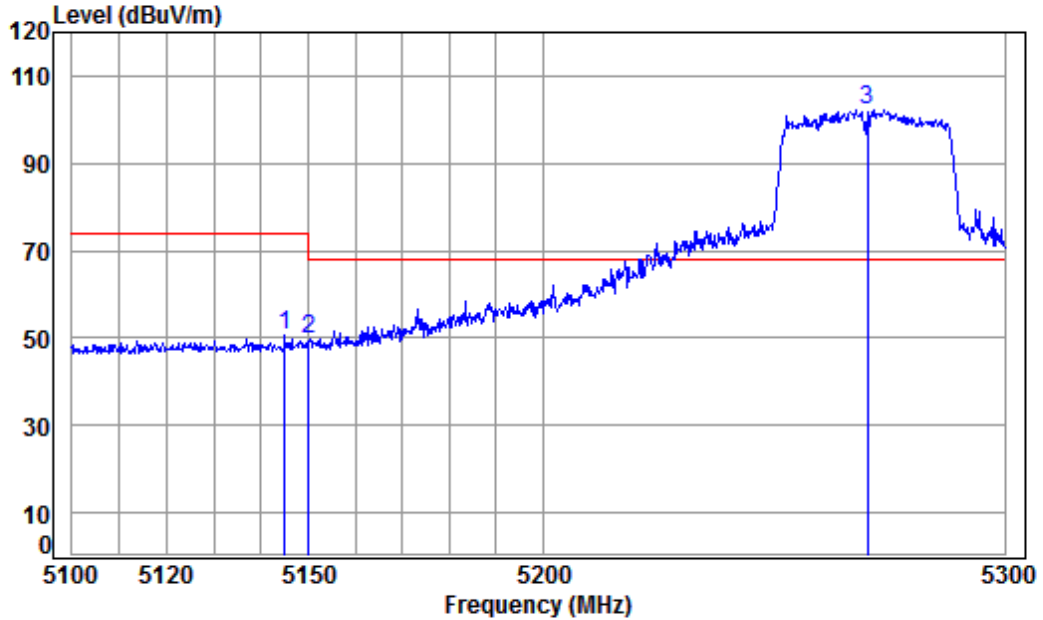

Condition: 3m HORIZONTAL
Job No : 04056CR/04057CR
Mode : 5270 Band edge
: 5G WIFI 11AC40

	Freq	Cable Loss	Ant Factor	Preamp Factor	Read Level	Level	Limit	Over	Remark
	MHz	dB	dB/m	dB	dBuV	dBuV/m	dBuV/m	dB	
1	5144.925	8.32	34.32	42.36	50.30	50.58	74.00	-23.42	peak
2	5149.980	8.33	34.32	42.36	49.56	49.85	74.00	-24.15	peak
3	pp 5270.000	8.51	34.42	42.24	101.59	102.28	68.20	34.08	peak



Mode:f; Polarization:Horizontal; Modulation:802.11ac; bandwidth:40MHz; Channel:Low

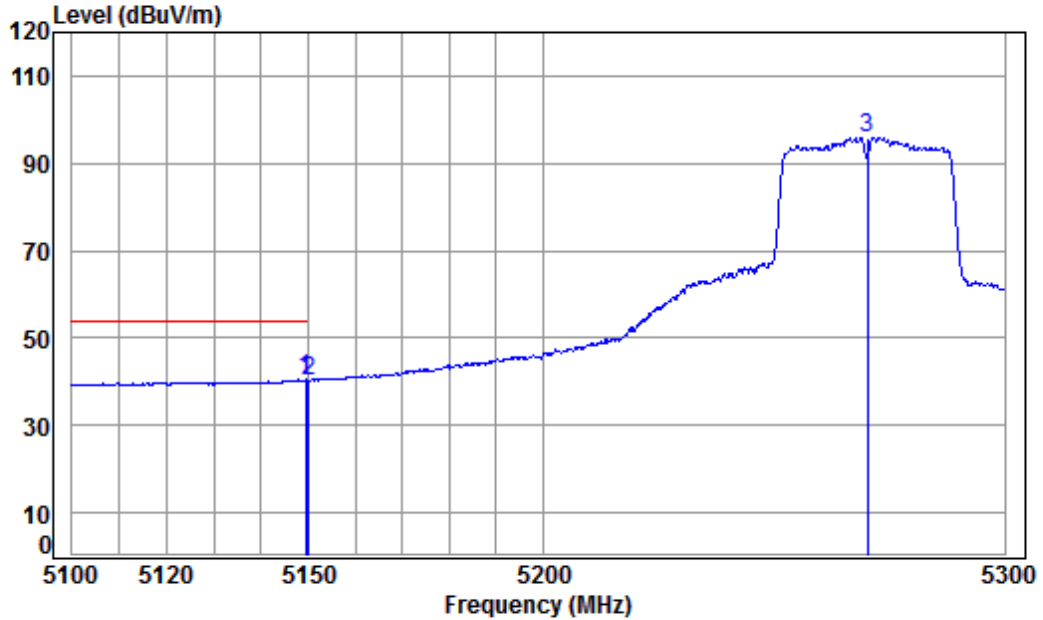

Condition: 3m HORIZONTAL
Job No : 04056CR/04057CR
Mode : 5270 Band edge
: 5G WIFI 11AC40

		Cable	Ant	Preamp	Read	Limit	Over		
	Freq	Loss	Factor	Factor	Level	Level	Line	Limit	Remark
	MHz	dB	dB/m	dB	dBuV	dBuV/m	dBuV/m	dB	
1	pp 5149.479	8.32	34.32	42.36	40.11	40.39	54.00	-13.61	Average
2	5149.980	8.33	34.32	42.36	39.97	40.26	54.00	-13.74	Average
3	5270.000	8.51	34.42	42.24	95.26	95.95	-----	-----	Average



Mode:f; Polarization:Vertical; Modulation:802.11ac; bandwidth:40MHz; Channel:Low

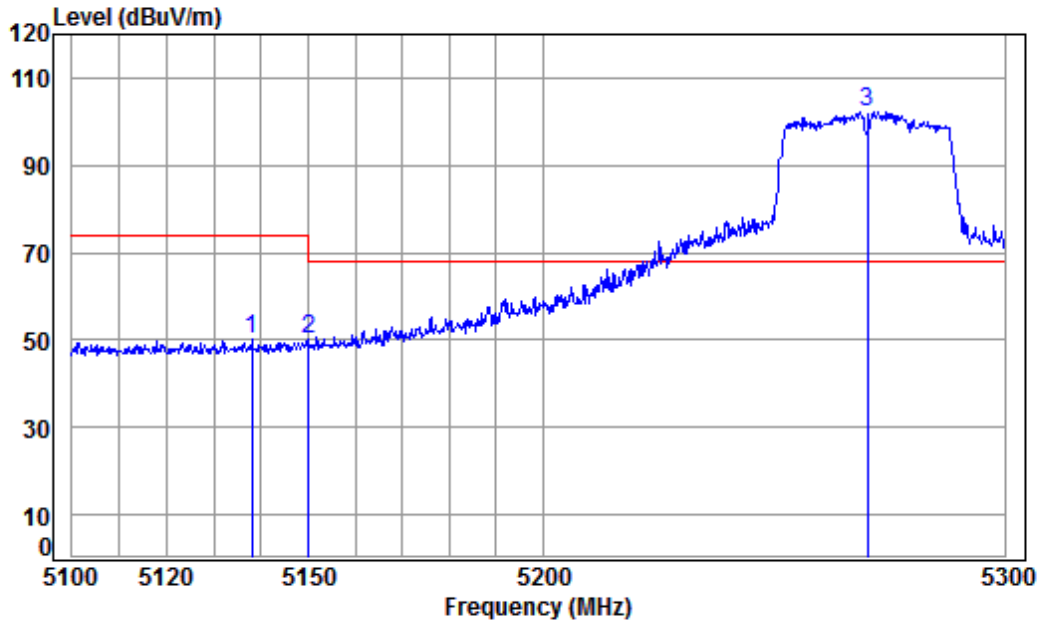

Condition: 3m VERTICAL
Job No : 04056CR/04057CR
Mode : 5270 Band edge
: 5G WIFI 11AC40

	Cable	Ant	Preamp	Read	Limit	Over		
Freq	Loss	Factor	Factor	Level	Level	Line	Limit	Remark
MHz	dB	dB/m	dB	dBuV	dBuV/m	dBuV/m	dB	
1	5138.003	8.31	34.31	42.37	49.86	50.11	74.00	-23.89 Peak
2	5149.980	8.33	34.32	42.36	49.81	50.10	74.00	-23.90 Peak
3	pp 5270.000	8.51	34.42	42.24	101.56	102.25	68.20	34.05 Peak



Mode:f; Polarization:Vertical; Modulation:802.11ac; bandwidth:40MHz; Channel:Low

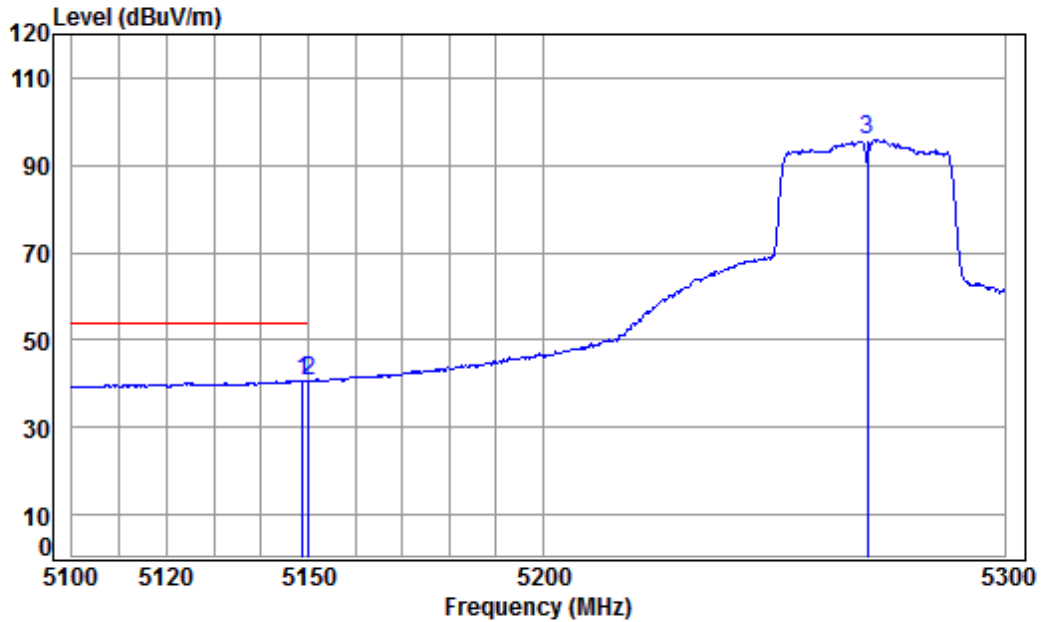

Condition: 3m VERTICAL
Job No : 04056CR/04057CR
Mode : 5270 Band edge
: 5G WIFI 11AC40

		Cable	Ant	Preamp	Read	Limit	Over		
	Freq	Loss	Factor	Factor	Level	Level	Line	Limit	Remark
	MHz	dB	dB/m	dB	dBuV	dBuV/m	dBuV/m	dB	
1	pp 5148.687	8.32	34.32	42.36	40.37	40.65	54.00	-13.35	Average
2	5149.980	8.33	34.32	42.36	40.33	40.62	54.00	-13.38	Average
3	5270.000	8.51	34.42	42.24	95.19	95.88	-----	-----	Average



Mode:f; Polarization:Horizontal; Modulation:802.11ac; bandwidth:40MHz; Channel:High

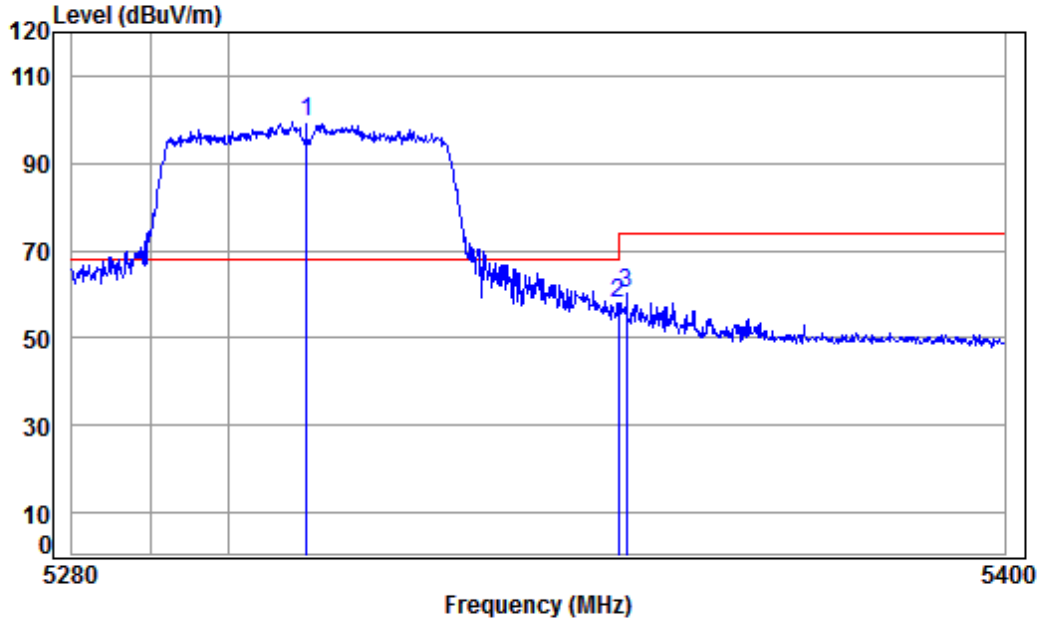

Condition: 3m HORIZONTAL
Job No : 04056CR/04057CR
Mode : 5310 Band edge
: 5G WIFI 11AC40

		Cable	Ant	Preamp	Read	Limit	Over	
	Freq	Loss	Factor	Factor	Level	Level	Line	Limit
	MHz	dB	dB/m	dB	dBuV	dBuV/m	dBuV/m	dB
1	pp 5310.000	8.57	34.45	42.21	98.46	99.27	68.20	31.07
2	5350.020	8.63	34.48	42.17	57.05	57.99	74.00	-16.01
3	5351.075	8.63	34.48	42.17	59.15	60.09	74.00	-13.91



Mode:f; Polarization:Horizontal; Modulation:802.11ac; bandwidth:40MHz; Channel:High

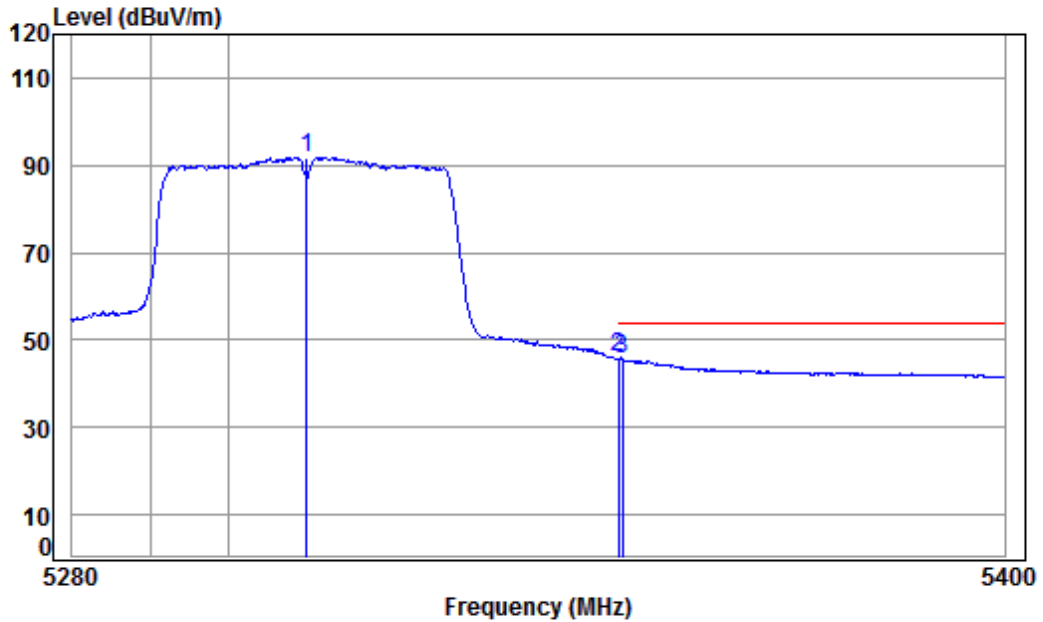

Condition: 3m HORIZONTAL
Job No : 04056CR/04057CR
Mode : 5310 Band edge
: 5G WIFI 11AC40

	Freq	Cable Loss	Ant Factor	Preamplifier	Read Level	Limit Level	Limit Line	Over Limit	Remark
	MHz	dB	dB/m	dB	dBuV	dBuV/m	dBuV/m	dB	
1	5310.000	8.57	34.45	42.21	91.05	91.86	-----	-----	Average
2	pp 5350.020	8.63	34.48	42.17	45.00	45.94	54.00	-8.06	Average
3	5350.474	8.63	34.48	42.17	44.55	45.49	54.00	-8.51	Average



Mode:f; Polarization:Vertical; Modulation:802.11ac; bandwidth:40MHz; Channel:High

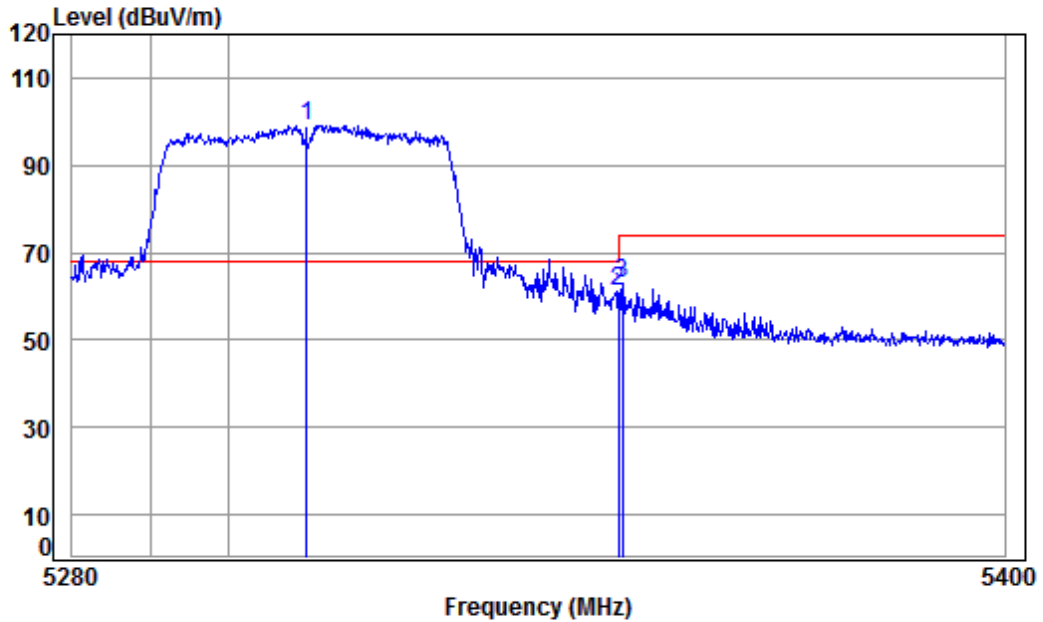

Condition: 3m VERTICAL
Job No : 04056CR/04057CR
Mode : 5310 Band edge
: 5G WIFI 11AC40

		Cable	Ant	Preamp	Read	Limit	Over		
	Freq	Loss	Factor	Factor	Level	Level	Line	Limit	Remark
	MHz	dB	dB/m	dB	dBuV	dBuV/m	dBuV/m	dB	
1	pp 5310.000	8.57	34.45	42.21	98.42	99.23	68.20	31.03	Peak
2	5350.020	8.63	34.48	42.17	60.05	60.99	74.00	-13.01	Peak
3	5350.474	8.63	34.48	42.17	61.84	62.78	74.00	-11.22	Peak

Mode:f; Polarization:Vertical; Modulation:802.11ac; bandwidth:40MHz; Channel:High

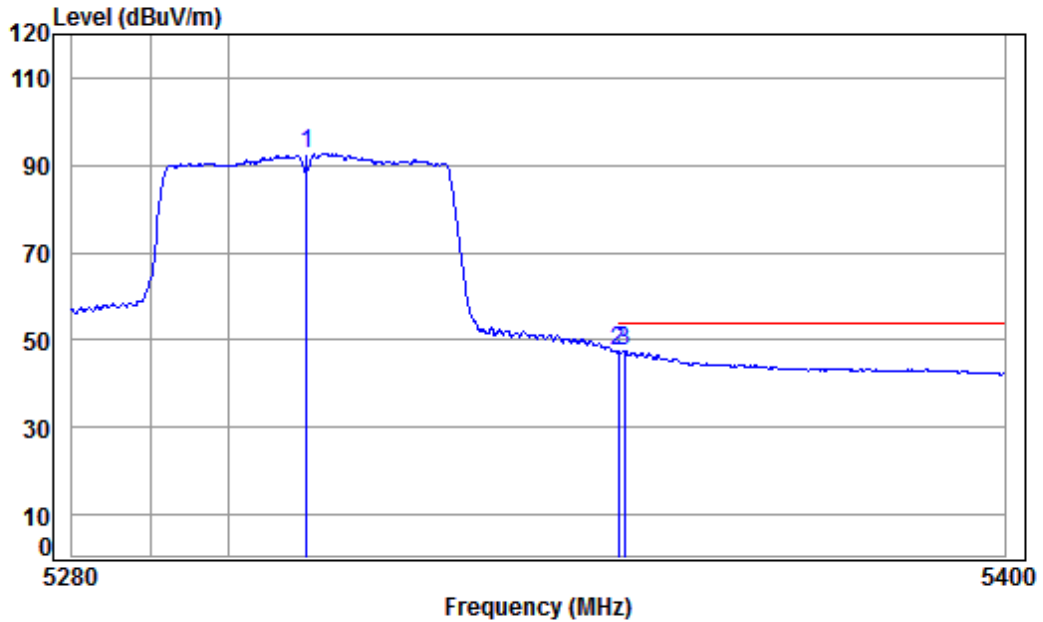

Condition: 3m VERTICAL
 Job No : 04056CR/04057CR
 Mode : 5310 Band edge
 : 5G WIFI 11AC40

	Freq	Cable Loss	Ant Factor	Preamplifier	Read Level	Limit Level	Limit Line	Over Limit	Remark
	MHz	dB	dB/m	dB	dBuV	dBuV/m	dBuV/m	dB	
1	5310.000	8.57	34.45	42.21	91.95	92.76	-----	-----	Average
2	5350.020	8.63	34.48	42.17	46.50	47.44	54.00	-6.56	Average
3 pp	5350.714	8.63	34.48	42.17	46.73	47.67	54.00	-6.33	Average

Mode:f; Polarization:Horizontal; Modulation:802.11ac; bandwidth:80MHz;

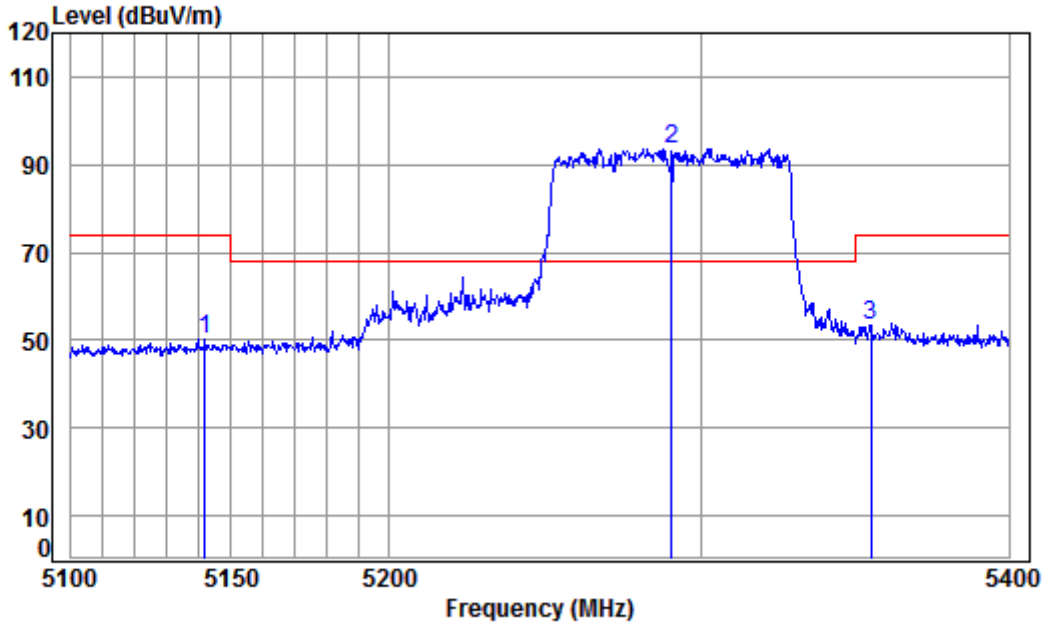

Condition: 3m HORIZONTAL
 Job No : 04056CR/04057CR
 Mode : 5290 Band edge
 : 5G WIFI 11AC80

	Freq	Cable Loss	Ant Factor	Preamp Factor	Read Level	Level	Limit Line	Over Limit	Remark
	MHz	dB	dB/m	dB	dBuV	dBuV/m	dBuV/m	dB	
1	5141.856	8.31	34.32	42.36	49.79	50.06	74.00	-23.94	peak
2	pp 5290.000	8.54	34.44	42.22	92.98	93.74	68.20	25.54	peak
3	5354.818	8.64	34.49	42.16	52.51	53.48	74.00	-20.52	peak



Mode:f; Polarization:Horizontal; Modulation:802.11ac; bandwidth:80MHz;

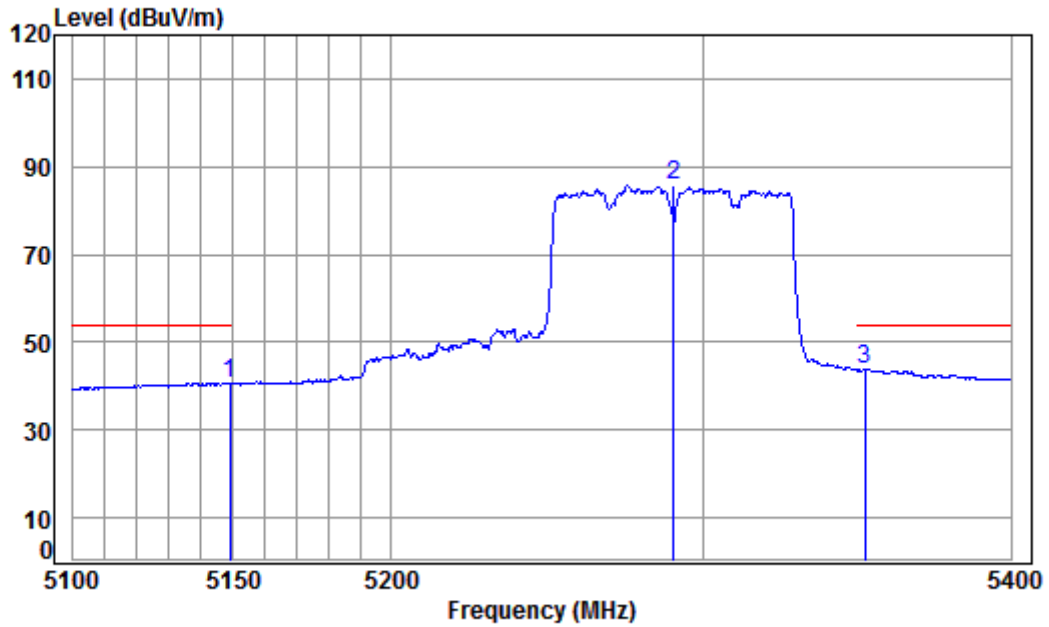

Condition: 3m HORIZONTAL
Job No : 04056CR/04057CR
Mode : 5290 Band edge
: 5G WIFI 11AC80

	Freq	Cable Loss	Ant Factor	Preamp Factor	Read Level	Limit	Over	Remark
	MHz	dB	dB/m	dB	dBuV	dBuV/m	dB	
1	5148.915	8.32	34.32	42.36	40.41	54.00	-13.31	Average
2	5290.000	8.54	34.44	42.22	84.82	-----	-----	Average
3	pp 5352.064	8.63	34.49	42.17	42.96	54.00	-10.09	Average

Mode:f; Polarization:Vertical; Modulation:802.11ac; bandwidth:80MHz;

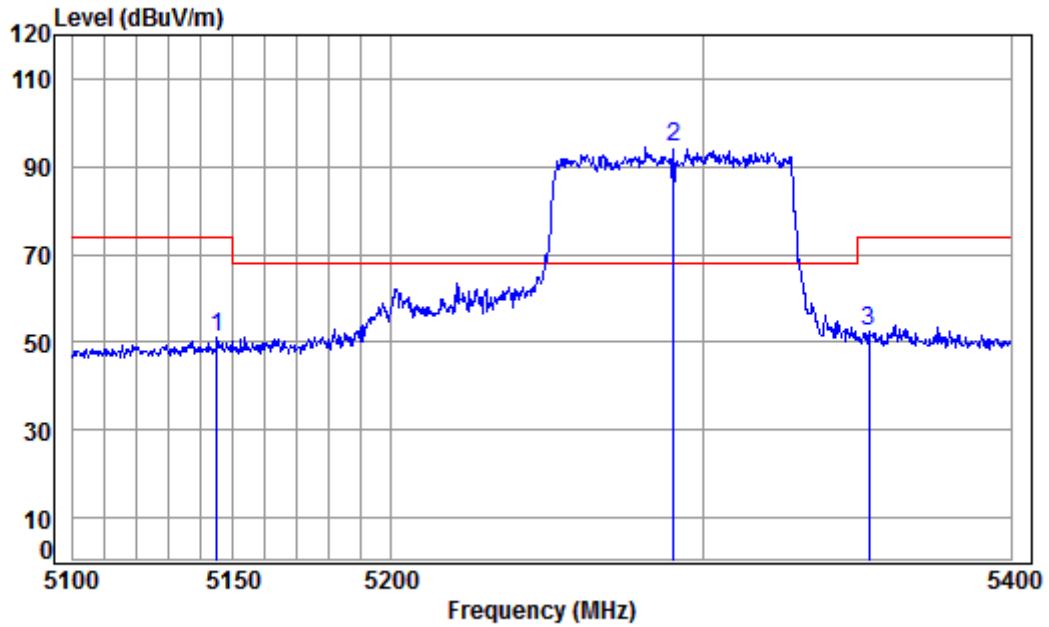

Condition: 3m VERTICAL
 Job No : 04056CR/04057CR
 Mode : 5290 Band edge
 : 5G WIFI 11AC80

	Freq	Cable Loss	Ant Factor	Preamp Factor	Read Level	Level	Limit Line	Over Limit	Remark
	MHz	dB	dB/m	dB	dBuV	dBuV/m	dBuV/m	dB	
1	5145.090	8.32	34.32	42.36	50.73	51.01	74.00	-22.99	Peak
2	pp 5290.000	8.54	34.44	42.22	93.66	94.42	68.20	26.22	Peak
3	5353.594	8.63	34.49	42.17	51.48	52.43	74.00	-21.57	Peak



Mode:f; Polarization:Vertical; Modulation:802.11ac; bandwidth:80MHz;

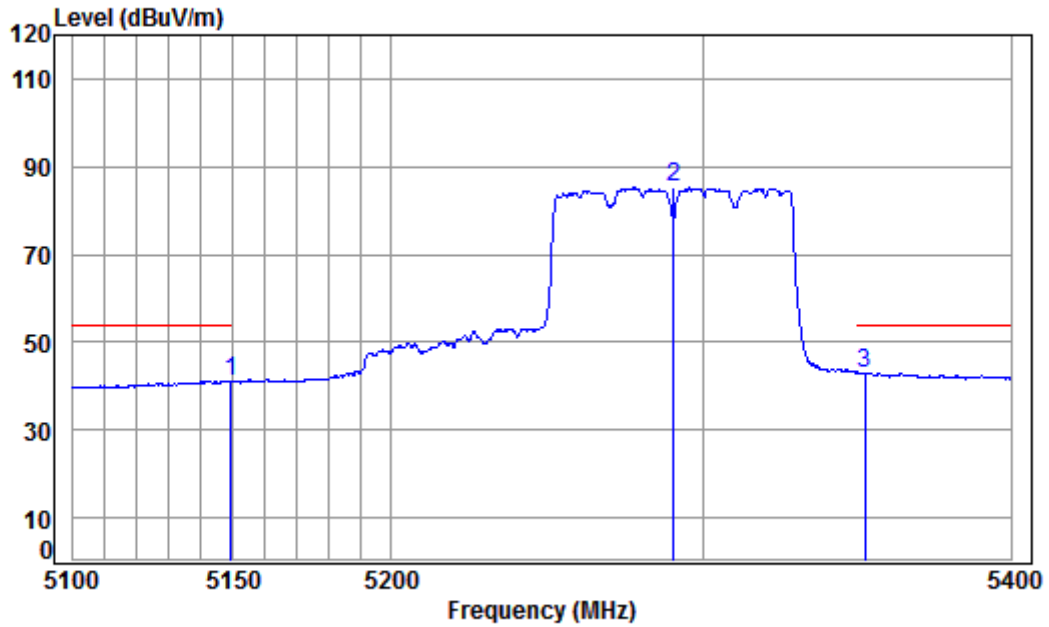

Condition: 3m VERTICAL
Job No : 04056CR/04057CR
Mode : 5290 Band edge
: 5G WIFI 11AC80

	Freq	Cable Loss	Ant Factor	Preamp Factor	Read Level	Limit	Over	Remark
	MHz	dB	dB/m	dB	dBuV	dBuV/m	dB	
1	5149.209	8.32	34.32	42.36	40.84	54.00	-12.88	Average
2	5290.000	8.54	34.44	42.22	84.45	-----	-----	Average
3	pp 5352.064	8.63	34.49	42.17	42.14	54.00	-10.91	Average



Mode:g; Polarization:Horizontal; Modulation:802.11a; bandwidth:20MHz; Channel:Low

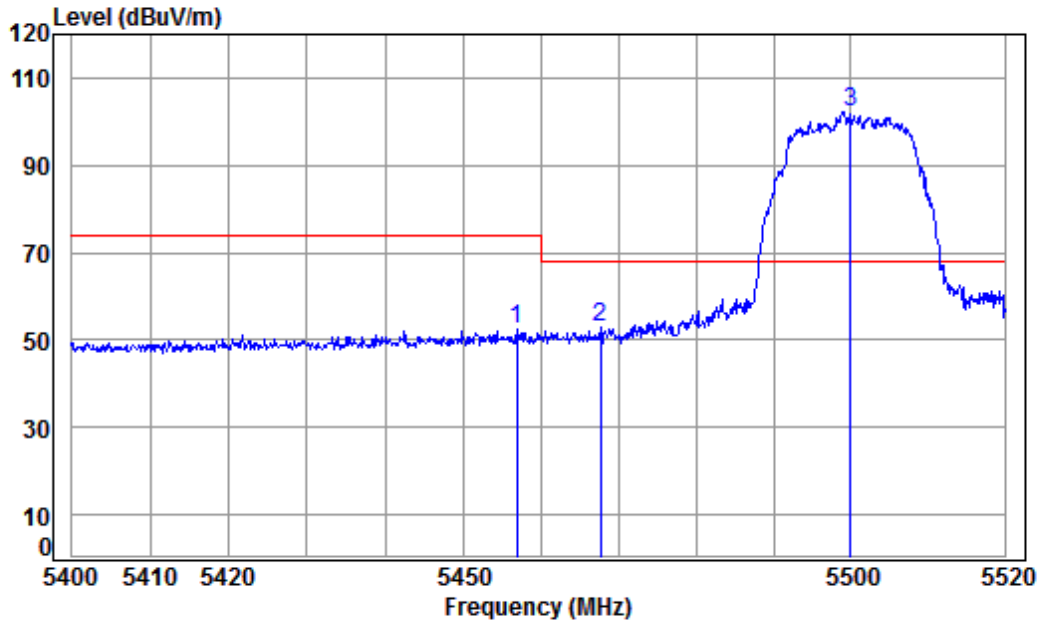

Condition: 3m HORIZONTAL
Job No : 04056CR/04057CR
Mode : 5500 Band edge
: 5G WIFI 11A

	Cable	Ant	Preamp	Read		Limit	Over	
Freq	Loss	Factor	Factor	Level	Level	Line	Limit	Remark
MHz	dB	dB/m	dB	dBuV	dBuV/m	dBuV/m	dB	
1	5456.911	8.79	34.57	42.07	51.00	52.29	74.00	-21.71 peak
2	5467.716	8.80	34.58	42.06	51.58	52.90	68.20	-15.30 peak
3 pp	5500.000	8.85	34.60	42.03	100.61	102.03	68.20	33.83 peak



Mode:g; Polarization:Horizontal; Modulation:802.11a; bandwidth:20MHz; Channel:Low

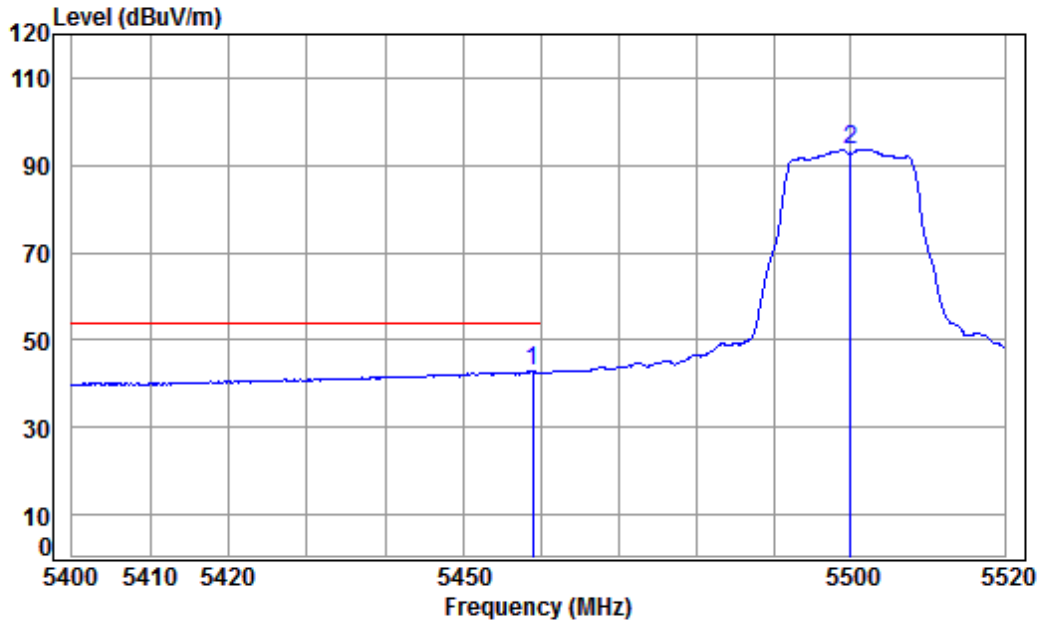

Condition: 3m HORIZONTAL
Job No : 04056CR/04057CR
Mode : 5500 Band edge
: 5G WIFI 11A

		Cable	Ant	Preamp	Read	Limit	Over		
	Freq	Loss	Factor	Factor	Level	Level	Line	Limit	Remark
	MHz	dB	dB/m	dB	dBuV	dBuV/m	dBuV/m	dB	
1	pp 5458.950	8.79	34.57	42.07	41.56	42.85	54.00	-11.15	Average
2	5500.000	8.85	34.60	42.03	92.30	93.72	-----	-----	Average



Mode:g; Polarization:Vertical; Modulation:802.11a; bandwidth:20MHz; Channel:Low

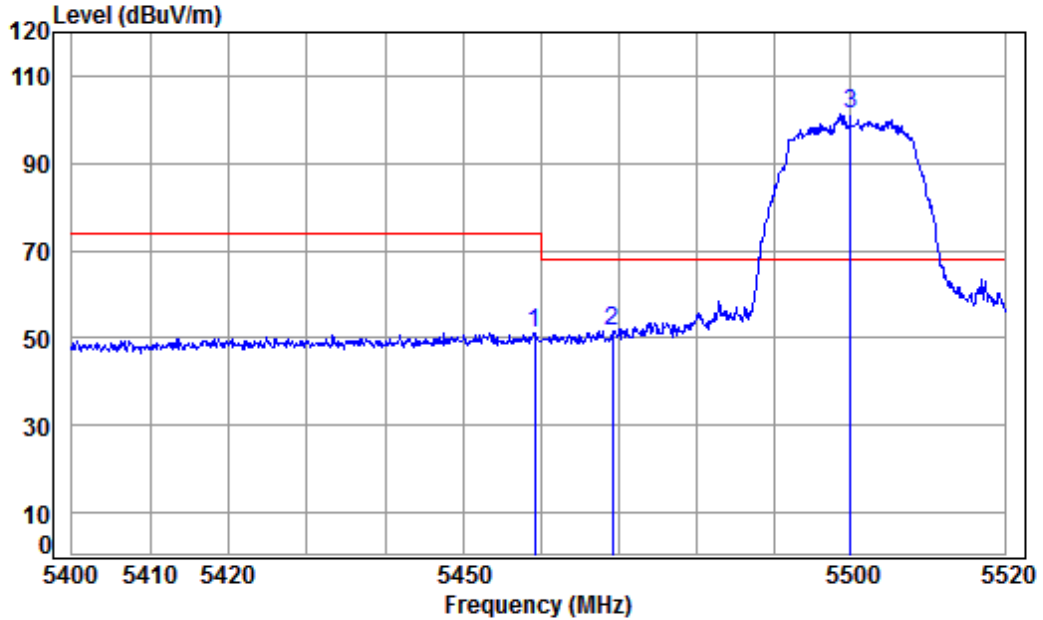

Condition: 3m VERTICAL
Job No : 04056CR/04057CR
Mode : 5500 Band edge
: 5G WIFI 11A

	Cable	Ant	Preamp	Read		Limit	Over	
Freq	Loss	Factor	Factor	Level	Level	Line	Limit	Remark
MHz	dB	dB/m	dB	dBuV	dBuV/m	dBuV/m	dB	
1	5459.190	8.79	34.57	42.07	49.92	51.21	74.00	-22.79 Peak
2	5469.279	8.81	34.58	42.06	50.11	51.44	68.20	-16.76 peak
3 pp	5500.000	8.85	34.60	42.03	99.68	101.10	68.20	32.90 Peak



Mode:g; Polarization:Vertical; Modulation:802.11a; bandwidth:20MHz; Channel:Low

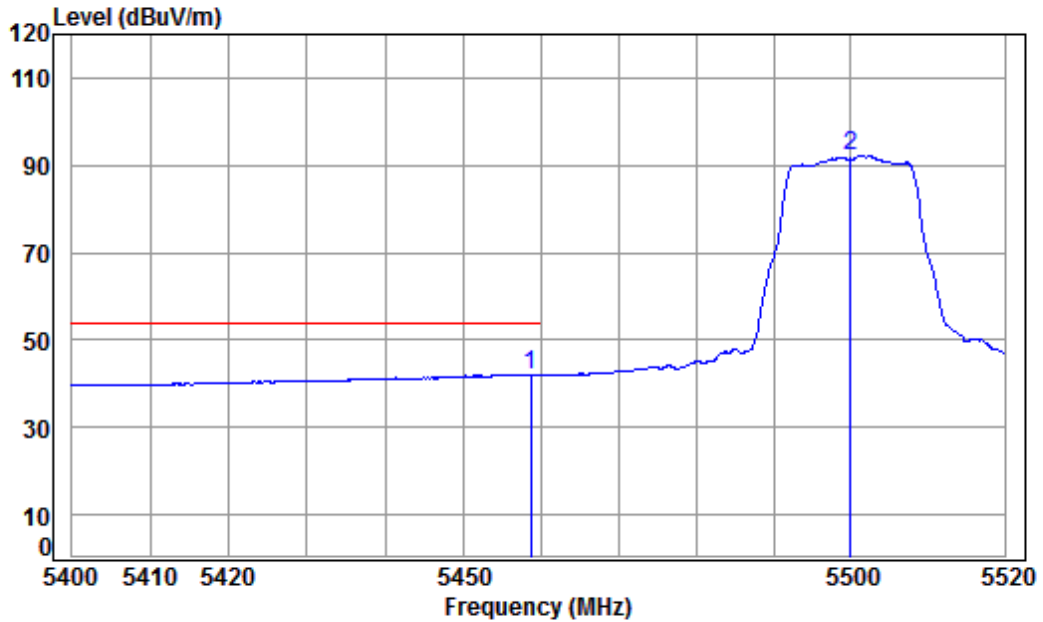

Condition: 3m VERTICAL
Job No : 04056CR/04057CR
Mode : 5500 Band edge
: 5G WIFI 11A

		Cable	Ant	Preamp	Read	Limit	Over		
	Freq	Loss	Factor	Factor	Level	Level	Line	Limit	Remark
	MHz	dB	dB/m	dB	dBuV	dBuV/m	dBuV/m	dB	
1	pp 5458.710	8.79	34.57	42.07	40.89	42.18	54.00	-11.82	Average
2	5500.000	8.85	34.60	42.03	90.82	92.24	-----	-----	Average



Mode:g; Polarization:Horizontal; Modulation:802.11a; bandwidth:20MHz; Channel:High

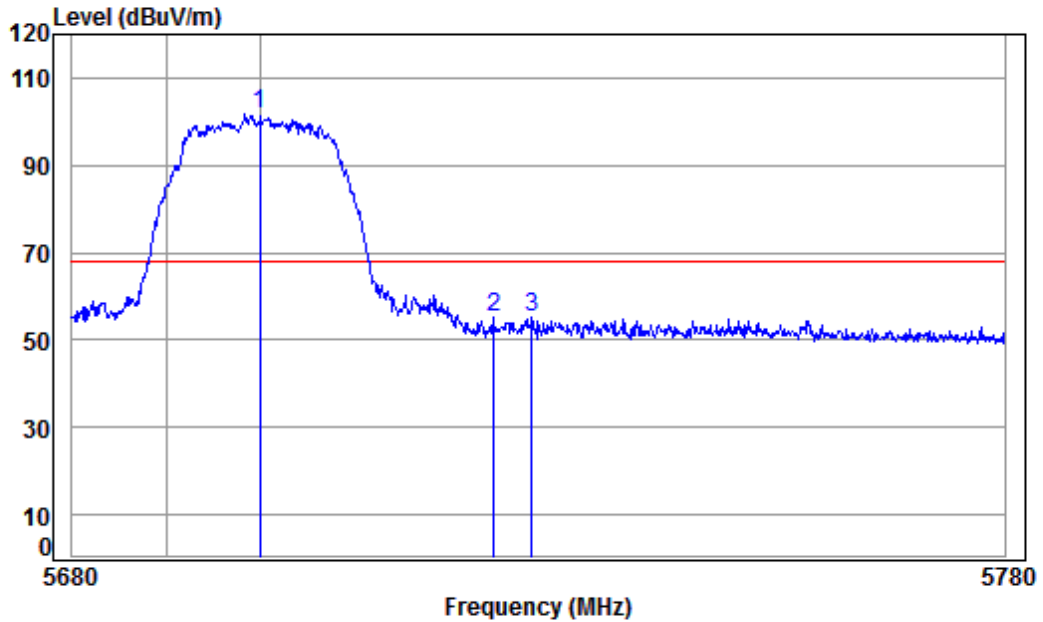

Condition: 3m HORIZONTAL
Job No : 04056CR/04057CR
Mode : 5700 Band edge
: 5G WIFI 11A

		Cable	Ant	Preamp	Read	Limit	Over		
	Freq	Loss	Factor	Factor	Level	Level	Line	Limit	Remark
	MHz	dB	dB/m	dB	dBuV	dBuV/m	dBuV/m	dB	
1	pp 5700.000	9.56	34.81	41.86	99.10	101.61	68.20	33.41	peak
2	5725.000	9.64	34.83	41.84	52.80	55.43	68.20	-12.77	peak
3	5729.082	9.66	34.83	41.83	52.61	55.27	68.20	-12.93	peak



Mode:g; Polarization: Vertical; Modulation:802.11a; bandwidth:20MHz; Channel:High

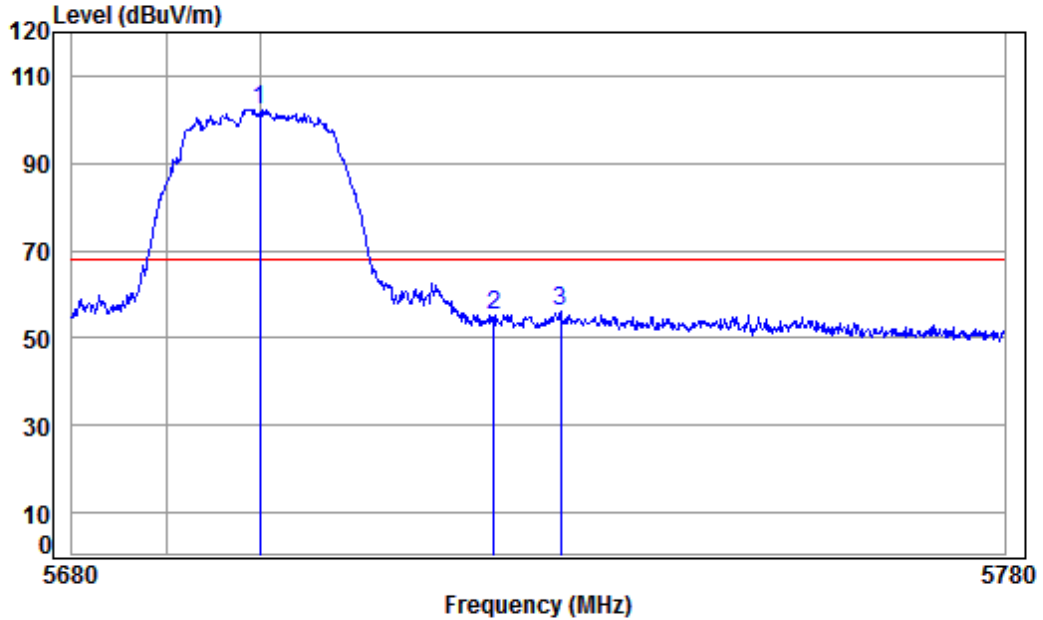

Condition: 3m VERTICAL
Job No : 04056CR/04057CR
Mode : 5700 Band edge
: 5G WIFI 11A

	Cable	Ant	Preamp	Read	Limit	Over		
Freq	Loss	Factor	Factor	Level	Level	Line	Limit	Remark
MHz	dB	dB/m	dB	dBuV	dBuV/m	dBuV/m	dB	
1 pp 5700.000	9.56	34.81	41.86	99.78	102.29	68.20	34.09	Peak
2 5725.000	9.64	34.83	41.84	52.38	55.01	68.20	-13.19	Peak
3 5732.182	9.67	34.84	41.83	53.22	55.90	68.20	-12.30	Peak



Mode:g; Polarization:Horizontal; Modulation:802.11n; bandwidth:20MHz; Channel:Low

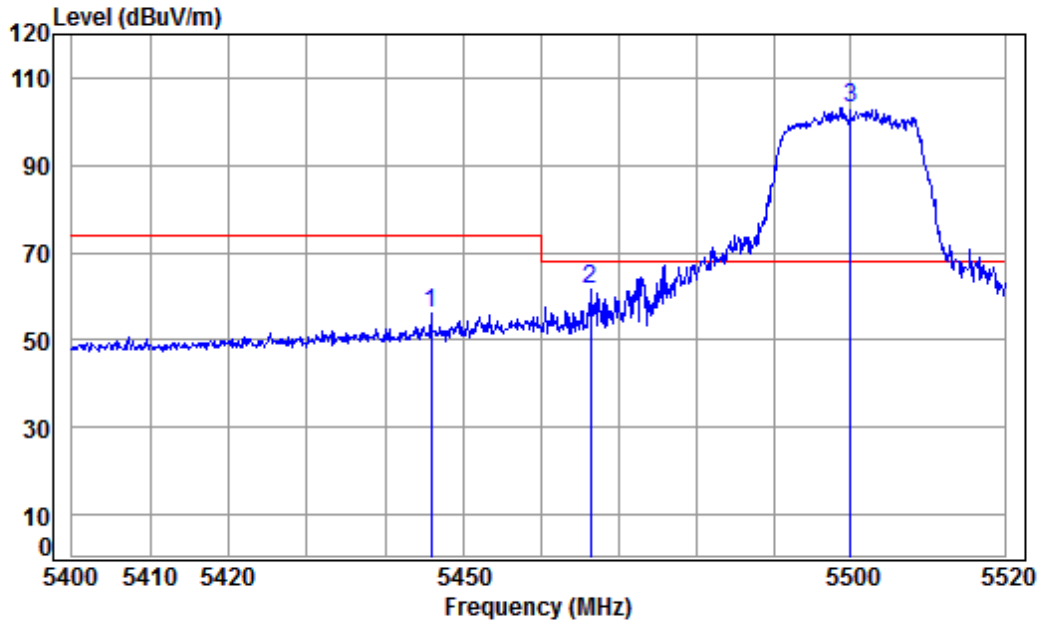

Condition: 3m HORIZONTAL
 Job No : 04056CR/04057CR
 Mode : 5500 Band edge
 : 5G WIFI 11N20

	Cable	Ant	Preamp	Read		Limit	Over	
Freq	Loss	Factor	Factor	Level	Level	Line	Limit	Remark
MHz	dB	dB/m	dB	dBuV	dBuV/m	dBuV/m	dB	
1	5445.888	8.77	34.56	42.08	54.72	55.97	74.00	-18.03 peak
2	5466.395	8.80	34.57	42.06	60.16	61.47	68.20	-6.73 peak
3	pp 5500.000	8.85	34.60	42.03	101.49	102.91	68.20	34.71 peak



Mode:g; Polarization: Horizontal; Modulation:802.11n; bandwidth:20MHz; Channel:Low

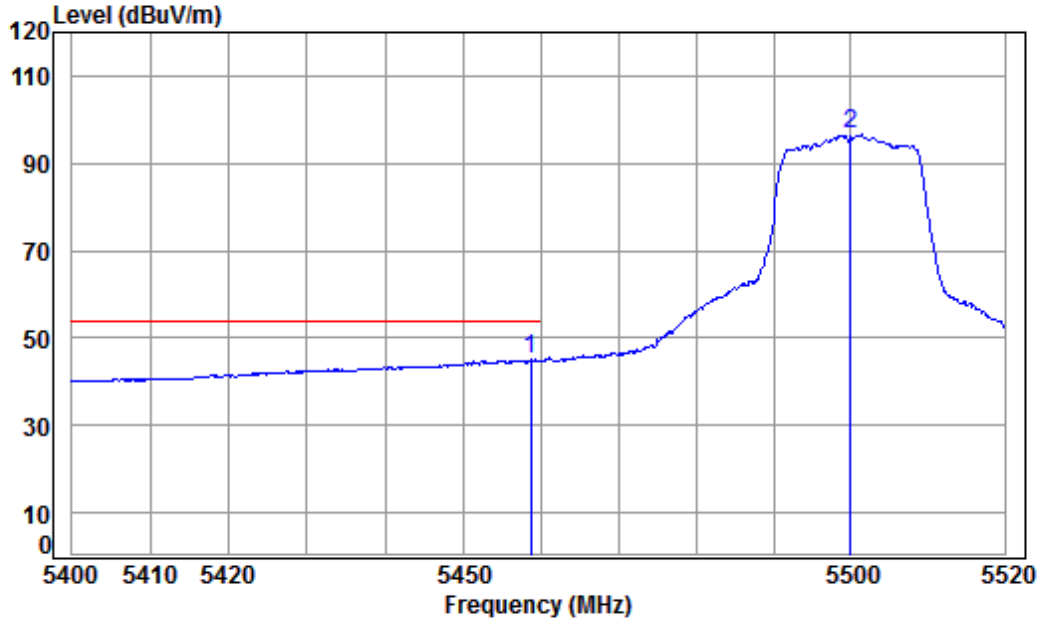

Condition: 3m HORIZONTAL
Job No : 04056CR/04057CR
Mode : 5500 Band edge
: 5G WIFI 11N20

	Freq	Cable Loss	Ant Factor	Preamp Factor	Read Level	Limit Level	Limit Line	Over Limit	Remark
	MHz	dB	dB/m	dB	dBuV	dBuV/m	dBuV/m	dB	
1	pp 5458.710	8.79	34.57	42.07	43.70	44.99	54.00	-9.01	Average
2	5500.000	8.85	34.60	42.03	95.08	96.50	-----	-----	Average



Mode:g; Polarization:Vertical; Modulation:802.11n; bandwidth:20MHz; Channel:Low

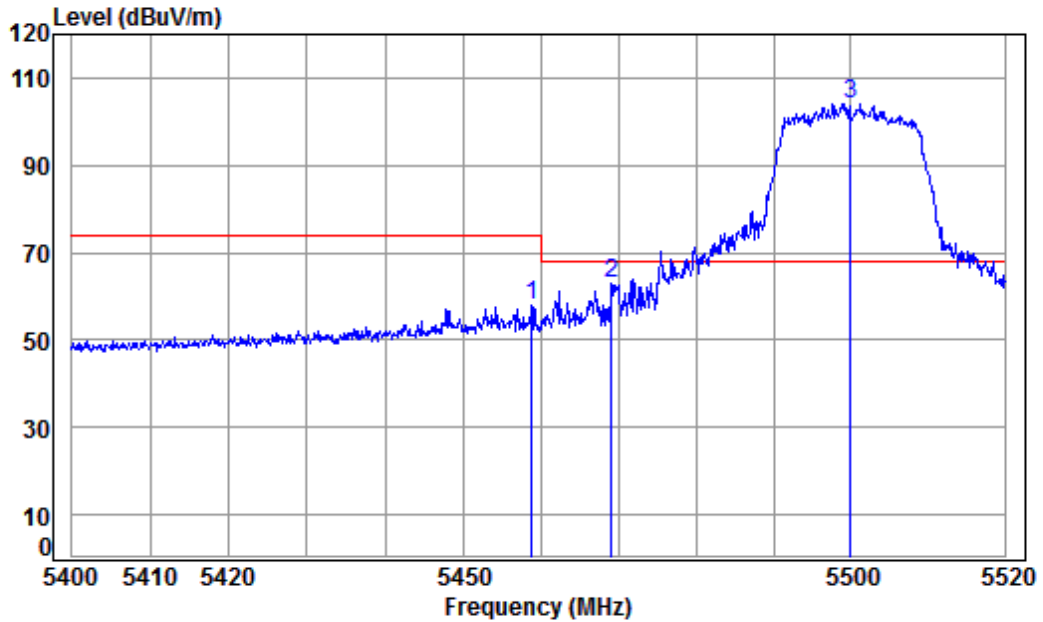

Condition: 3m VERTICAL
Job No : 04056CR/04057CR
Mode : 5500 Band edge
: 5G WIFI 11N20

	Cable	Ant	Preamp	Read	Limit	Over		
Freq	Loss	Factor	Factor	Level	Level	Line	Limit	Remark
MHz	dB	dB/m	dB	dBuV	dBuV/m	dBuV/m	dB	
1	5458.831	8.79	34.57	42.07	56.78	58.07	74.00	-15.93 Peak
2	5469.158	8.81	34.58	42.06	61.54	62.87	68.20	-5.33 peak
3 pp	5500.000	8.85	34.60	42.03	102.68	104.10	68.20	35.90 Peak



Mode:g; Polarization:Vertical; Modulation:802.11n; bandwidth:20MHz; Channel:Low

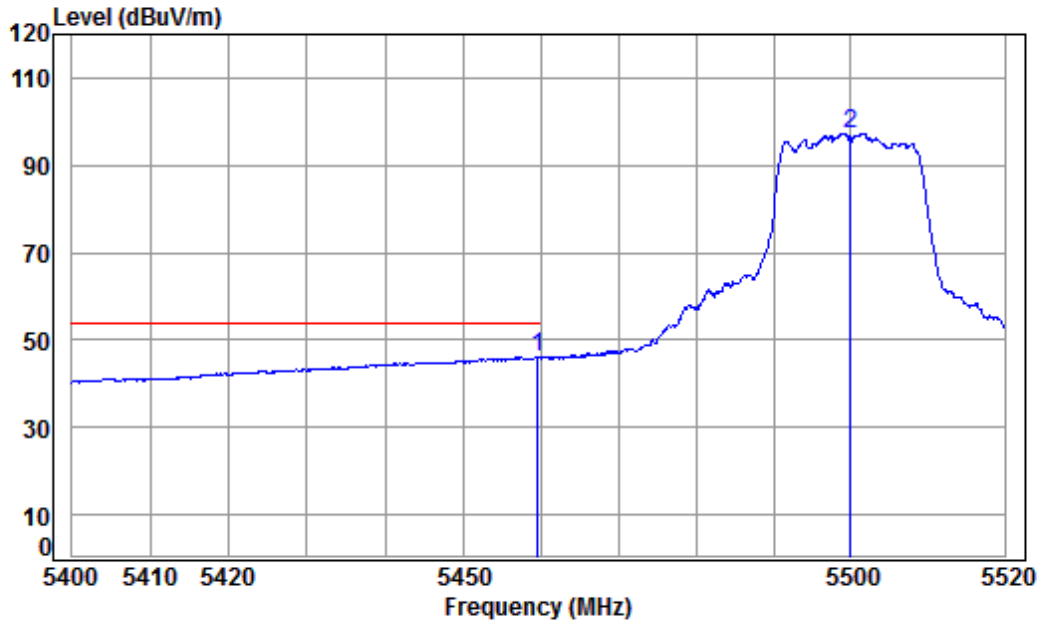

Condition: 3m VERTICAL
Job No : 04056CR/04057CR
Mode : 5500 Band edge
: 5G WIFI 11N20

		Cable	Ant	Preamp	Read	Limit	Over	
	Freq	Loss	Factor	Factor	Level	Level	Line	Limit Remark
	MHz	dB	dB/m	dB	dBuV	dBuV/m	dBuV/m	dB
1	pp 5459.670	8.79	34.57	42.07	44.78	46.07	54.00	-7.93 Average
2	5500.000	8.85	34.60	42.03	95.93	97.35	-----	----- Average



Mode:g; Polarization:Horizontal; Modulation:802.11n; bandwidth:20MHz; Channel:High

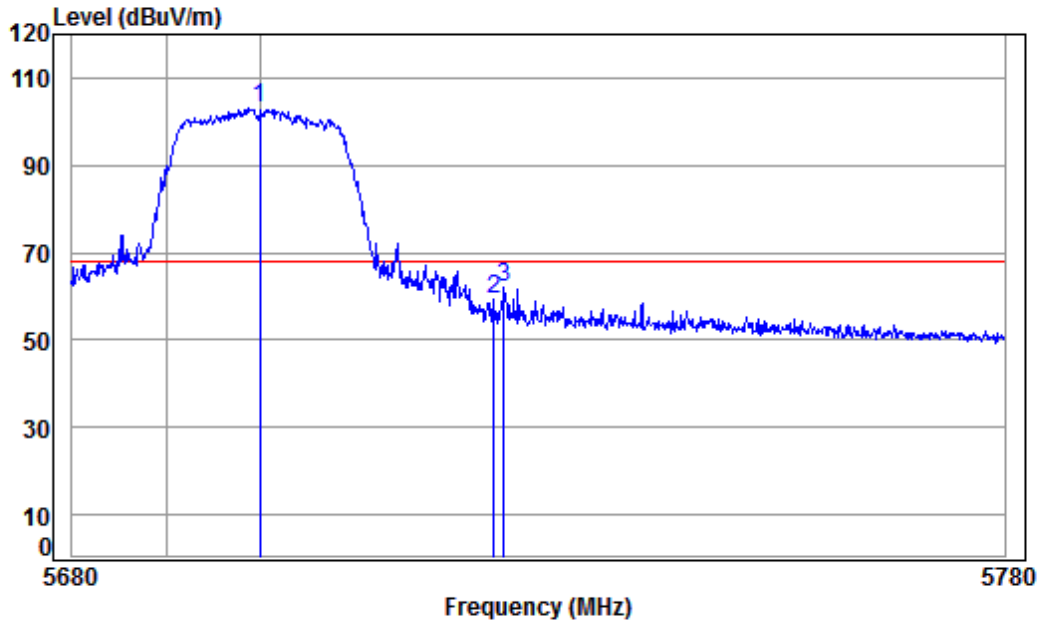

Condition: 3m HORIZONTAL
Job No : 04056CR/04057CR
Mode : 5700 Band edge
: 5G WIFI 11N20

		Cable	Ant	Preamp	Read	Limit	Over		
	Freq	Loss	Factor	Factor	Level	Level	Line	Limit	Remark
	MHz	dB	dB/m	dB	dBuV	dBuV/m	dBuV/m	dB	
1	pp 5700.000	9.56	34.81	41.86	100.40	102.91	68.20	34.71	peak
2	5725.000	9.64	34.83	41.84	56.83	59.46	68.20	-8.74	peak
3	5726.083	9.65	34.83	41.84	59.19	61.83	68.20	-6.37	peak



Mode:g; Polarization:Vertical; Modulation:802.11n; bandwidth:20MHz; Channel:High

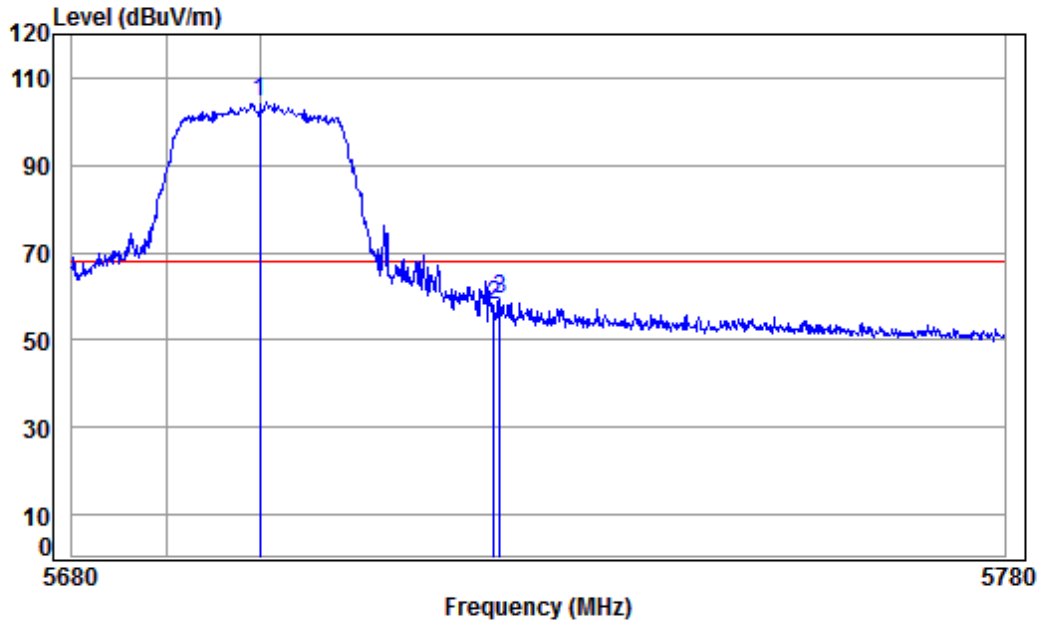

Condition: 3m VERTICAL
Job No : 04056CR/04057CR
Mode : 5700 Band edge
: 5G WIFI 11N20

		Cable	Ant	Preamp	Read	Limit	Over	
	Freq	Loss	Factor	Factor	Level	Level	Line	Limit Remark
	MHz	dB	dB/m	dB	dBuV	dBuV/m	dBuV/m	dB
1	pp 5700.000	9.56	34.81	41.86	101.90	104.41	68.20	36.21 Peak
2	5725.000	9.64	34.83	41.84	55.19	57.82	68.20	-10.38 Peak
3	5725.684	9.64	34.83	41.84	56.57	59.20	68.20	-9.00 Peak



Mode:g; Polarization:Horizontal; Modulation:802.11n; bandwidth:40MHz; Channel:Low

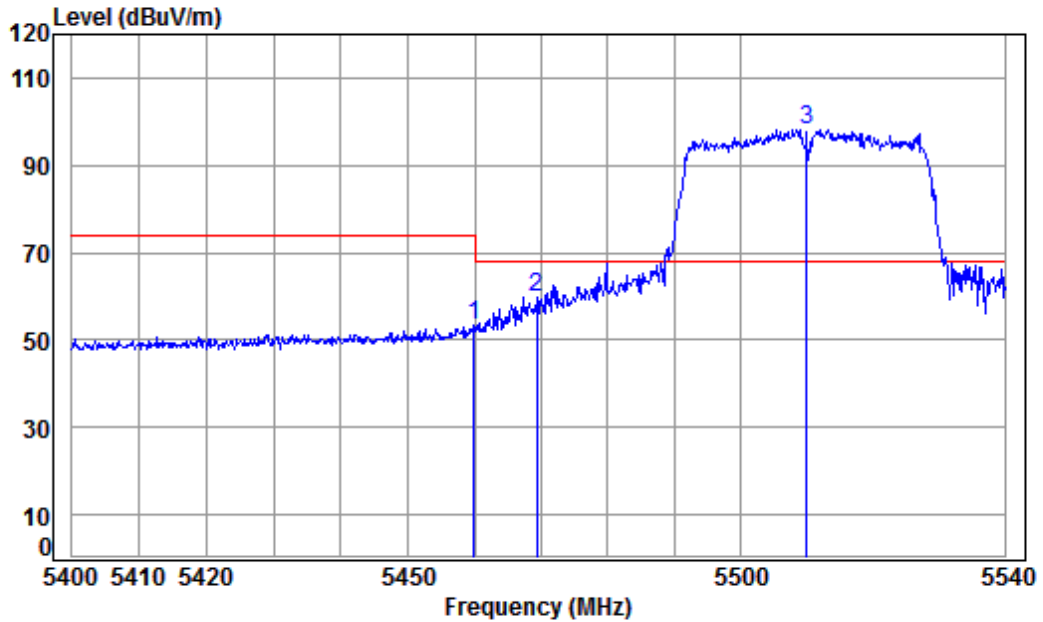

Condition: 3m HORIZONTAL
Job No : 04056CR/04057CR
Mode : 5510 Band edge
: 5G WIFI 11N40

	Cable	Ant	Preamp	Read	Limit	Over		
Freq	Loss	Factor	Factor	Level	Level	Line	Limit	Remark
MHz	dB	dB/m	dB	dBuV	dBuV/m	dBuV/m	dB	
1	5459.901	8.79	34.57	42.07	52.19	53.48	74.00	-20.52 peak
2	5469.272	8.81	34.58	42.06	58.40	59.73	68.20	-8.47 peak
3 pp	5510.000	8.89	34.61	42.02	96.69	98.17	68.20	29.97 peak



Mode:g; Polarization:Horizontal; Modulation:802.11n; bandwidth:40MHz; Channel:Low

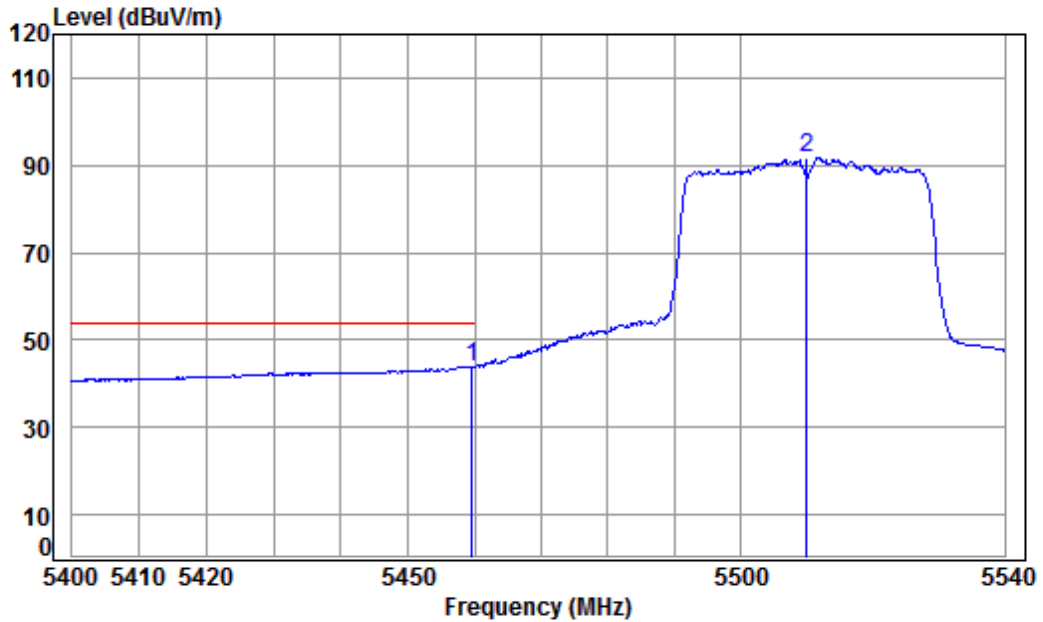

Condition: 3m HORIZONTAL
Job No : 04056CR/04057CR
Mode : 5510 Band edge
: 5G WIFI 11N40

		Cable	Ant	Preamp	Read	Limit	Over	
	Freq	Loss	Factor	Factor	Level	Level	Line	Limit Remark
	MHz	dB	dB/m	dB	dBuV	dBuV/m	dBuV/m	dB
1	pp 5459.622	8.79	34.57	42.07	42.65	43.94	54.00	-10.06 Average
2	5510.000	8.89	34.61	42.02	90.24	91.72	-----	----- Average



Mode:g; Polarization:Vertical; Modulation:802.11n; bandwidth:40MHz; Channel:Low

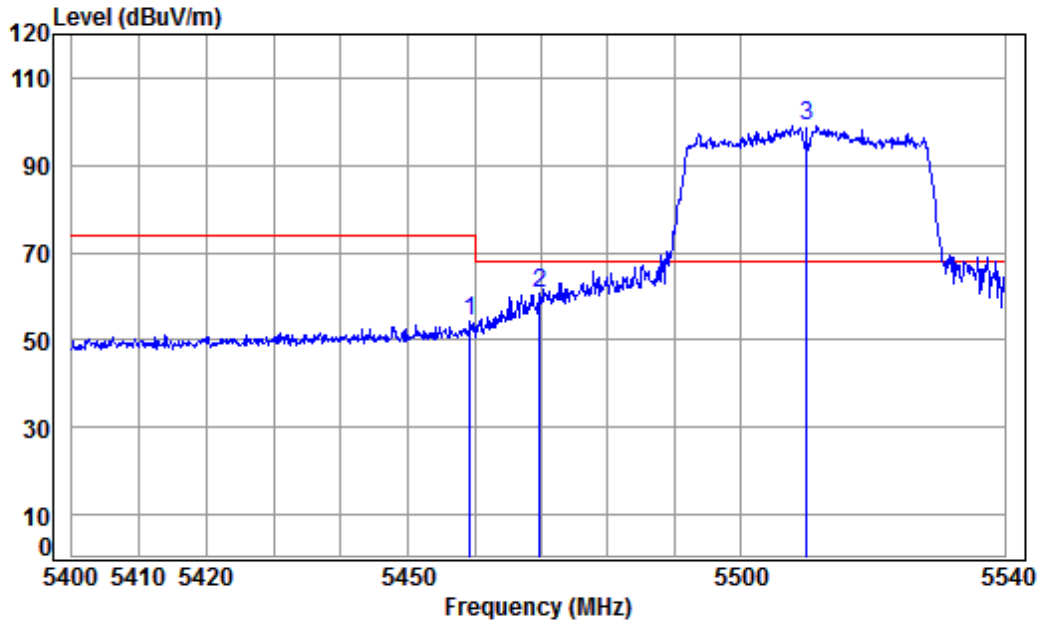

Condition: 3m VERTICAL
Job No : 04056CR/04057CR
Mode : 5510 Band edge
: 5G WIFI 11N40

	Cable	Ant	Preamp	Read	Limit	Over		
Freq	Loss	Factor	Factor	Level	Level	Line	Limit	Remark
MHz	dB	dB/m	dB	dBuV	dBuV/m	dBuV/m	dB	
1	5459.342	8.79	34.57	42.07	53.08	54.37	74.00	-19.63 Peak
2	5469.832	8.81	34.58	42.06	59.32	60.65	68.20	-7.55 peak
3 pp	5510.000	8.89	34.61	42.02	97.52	99.00	68.20	30.80 Peak



Mode:g; Polarization:Vertical; Modulation:802.11n; bandwidth:40MHz; Channel:Low

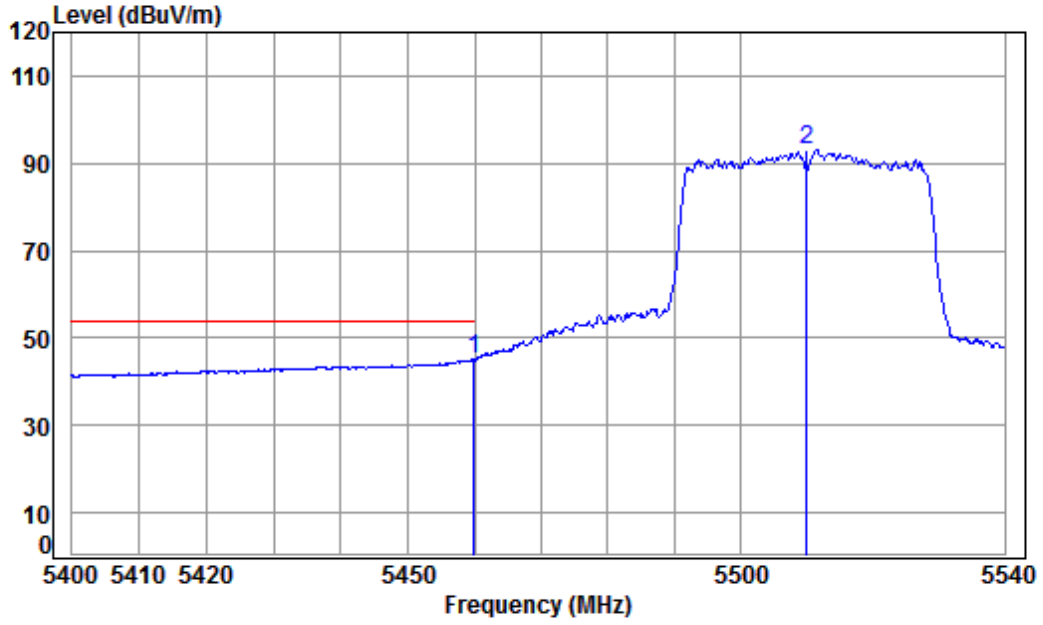

Condition: 3m VERTICAL
Job No : 04056CR/04057CR
Mode : 5510 Band edge
: 5G WIFI 11N40

		Cable	Ant	Preamp	Read	Limit	Over		
	Freq	Loss	Factor	Factor	Level	Level	Line	Limit	Remark
	MHz	dB	dB/m	dB	dBuV	dBuV/m	dBuV/m	dB	
1	pp 5459.901	8.79	34.57	42.07	44.06	45.35	54.00	-8.65	Average
2	5510.000	8.89	34.61	42.02	91.55	93.03	-----	-----	Average



Mode:g; Polarization:Horizontal; Modulation:802.11n; bandwidth:40MHz; Channel:high

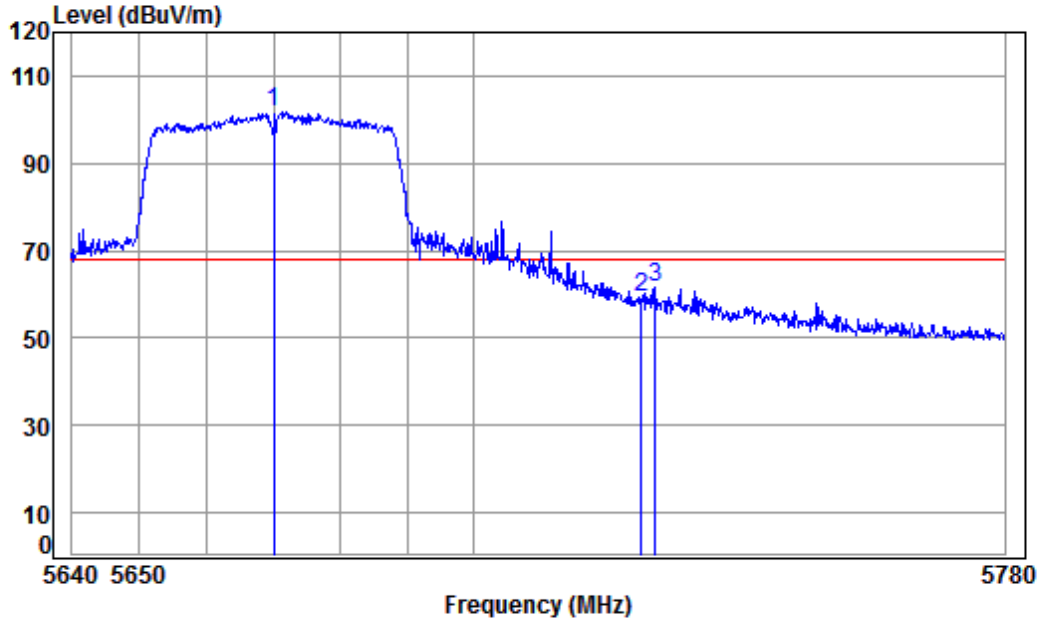

Condition: 3m HORIZONTAL
Job No : 04056CR/04057CR
Mode : 5670 Band edge
: 5G WIFI 11N40

		Cable	Ant	Preamp	Read	Limit	Over		
	Freq	Loss	Factor	Factor	Level	Level	Line	Limit	Remark
	MHz	dB	dB/m	dB	dBuV	dBuV/m	dBuV/m	dB	
1	pp 5670.000	9.45	34.77	41.88	99.43	101.77	68.20	33.57	peak
2	5725.000	9.64	34.83	41.84	56.65	59.28	68.20	-8.92	peak
3	5727.097	9.65	34.83	41.84	59.09	61.73	68.20	-6.47	peak



Mode:g; Polarization:Vertical; Modulation:802.11n; bandwidth:40MHz; Channel:High

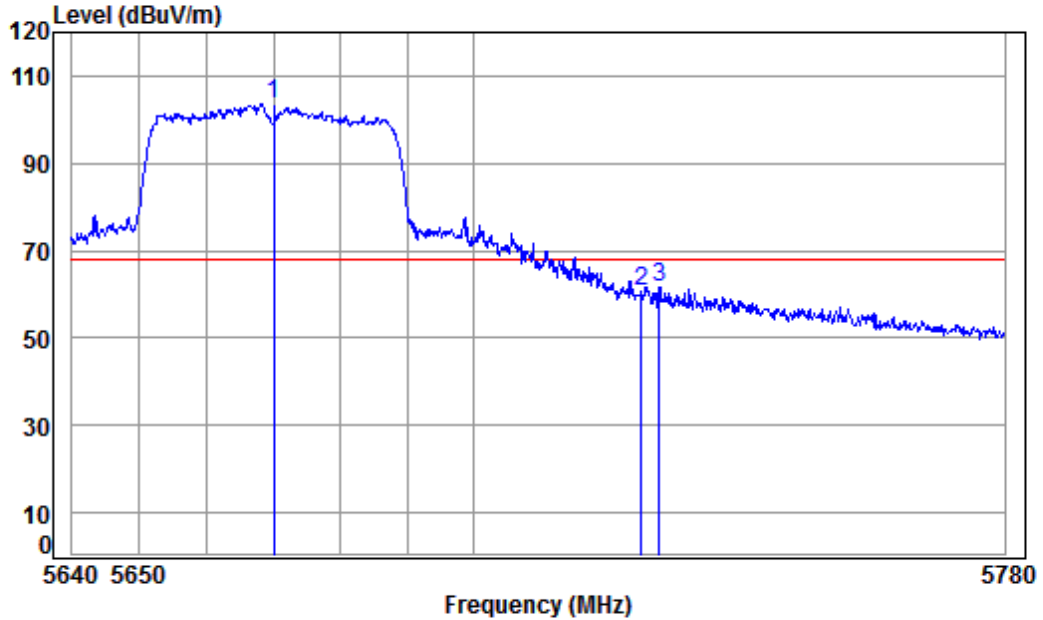

Condition: 3m VERTICAL
Job No : 04056CR/04057CR
Mode : 5670 Band edge
: 5G WIFI 11N40

		Cable	Ant	Preamp	Read	Limit	Over		
	Freq	Loss	Factor	Factor	Level	Level	Line	Limit	Remark
	MHz	dB	dB/m	dB	dBuV	dBuV/m	dBuV/m	dB	
1	pp 5670.000	9.45	34.77	41.88	101.28	103.62	68.20	35.42	Peak
2	5725.000	9.64	34.83	41.84	58.25	60.88	68.20	-7.32	Peak
3	5727.799	9.65	34.83	41.83	59.14	61.79	68.20	-6.41	Peak



Mode:g; Polarization:Horizontal; Modulation:802.11ac; bandwidth:20MHz; Channel:Low

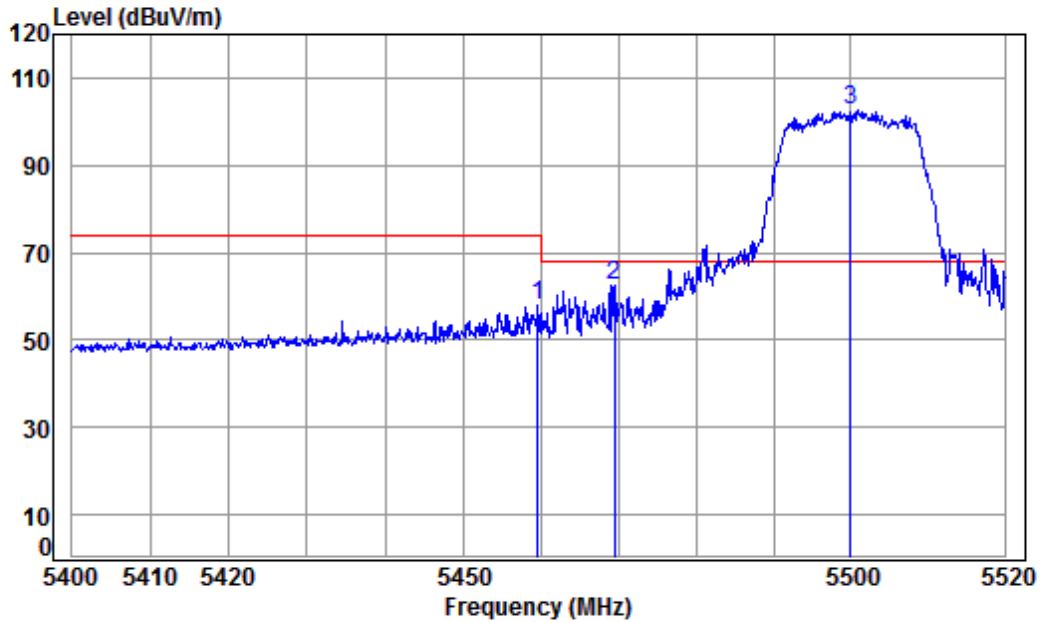

Condition: 3m HORIZONTAL
Job No : 04056CR/04057CR
Mode : 5500 Band edge
: 5G WIFI 11AC20

	Cable	Ant	Preamp	Read		Limit	Over	
Freq	Loss	Factor	Factor	Level	Level	Line	Limit	Remark
MHz	dB	dB/m	dB	dBuV	dBuV/m	dBuV/m	dB	
1	5459.670	8.79	34.57	42.07	56.49	57.78	74.00	-16.22 peak
2	5469.519	8.81	34.58	42.06	61.34	62.67	68.20	-5.53 peak
3	pp 5500.000	8.85	34.60	42.03	101.14	102.56	68.20	34.36 peak



Mode:g; Polarization:Horizontal; Modulation:802.11ac; bandwidth:20MHz; Channel:Low

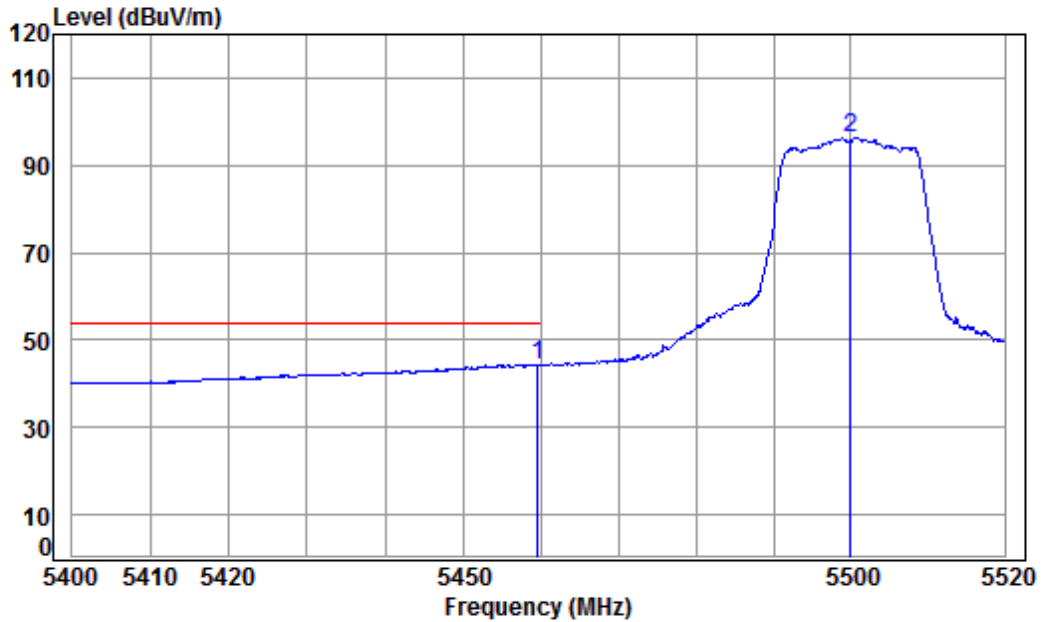

Condition: 3m HORIZONTAL
 Job No : 04056CR/04057CR
 Mode : 5500 Band edge
 : 5G WIFI 11AC20

		Cable	Ant	Preamp	Read	Limit	Over	
	Freq	Loss	Factor	Factor	Level	Level	Line	Limit Remark
	MHz	dB	dB/m	dB	dBuV	dBuV/m	dBuV/m	dB
1	pp 5459.550	8.79	34.57	42.07	43.16	44.45	54.00	-9.55 Average
2	5500.000	8.85	34.60	42.03	94.99	96.41	-----	----- Average



Mode:g; Polarization:Vertical; Modulation:802.11ac; bandwidth:20MHz; Channel:Low

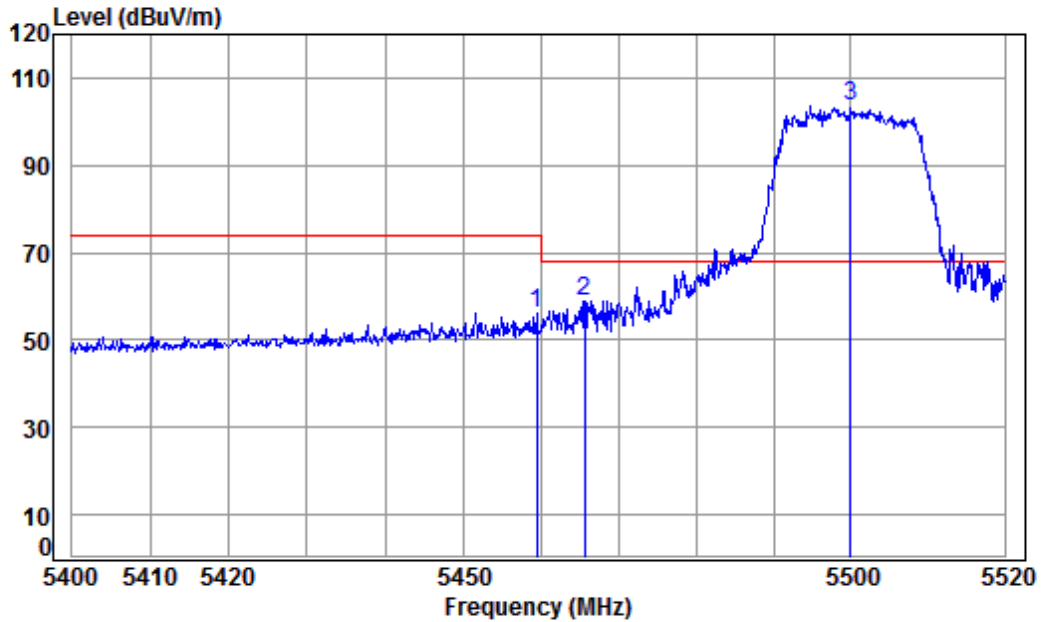

Condition: 3m VERTICAL
Job No : 04056CR/04057CR
Mode : 5500 Band edge
: 5G WIFI 11AC20

	Freq	Cable Loss	Ant Factor	Preamplifier	Read Level	Limit Level	Over Limit	Remark
	MHz	dB	dB/m	dB	dBuV	dBuV/m	dBuV/m	dB
1	5459.430	8.79	34.57	42.07	55.05	56.34	74.00	-17.66 Peak
2	5465.673	8.80	34.57	42.06	57.62	58.93	68.20	-9.27 peak
3 pp	5500.000	8.85	34.60	42.03	102.30	103.72	68.20	35.52 Peak



Mode:g; Polarization:Vertical; Modulation:802.11ac; bandwidth:20MHz; Channel:Low

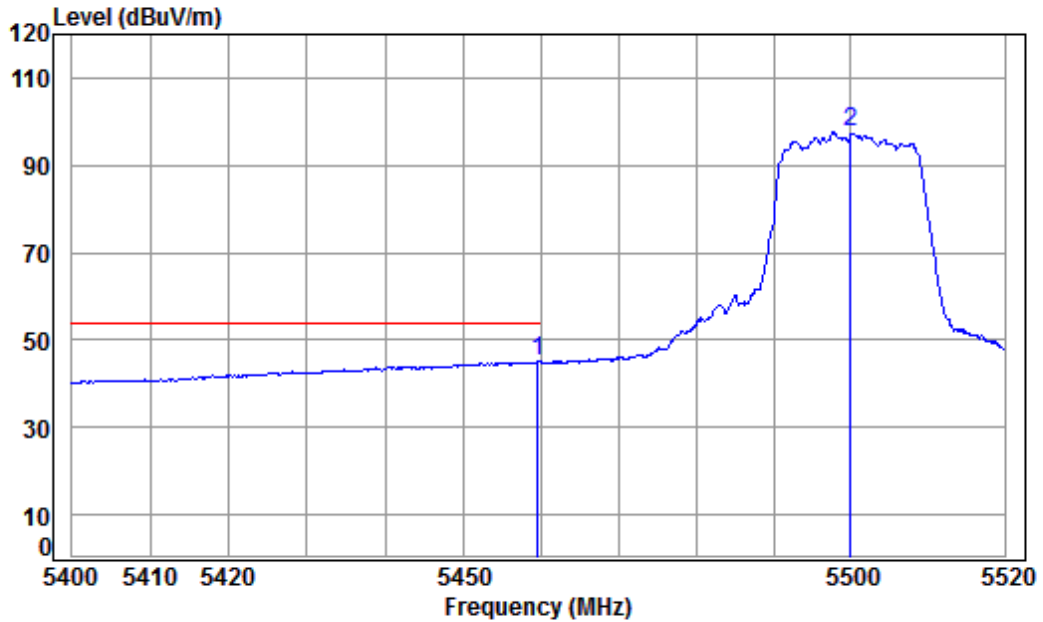

Condition: 3m VERTICAL
Job No : 04056CR/04057CR
Mode : 5500 Band edge
: 5G WIFI 11AC20

		Cable	Ant	Preamp	Read	Limit	Over		
	Freq	Loss	Factor	Factor	Level	Level	Line	Limit	Remark
	MHz	dB	dB/m	dB	dBuV	dBuV/m	dBuV/m	dB	
1	pp 5459.670	8.79	34.57	42.07	43.86	45.15	54.00	-8.85	Average
2	5500.000	8.85	34.60	42.03	96.00	97.42	-----	-----	Average



Mode:g; Polarization:Horizontal; Modulation:802.11ac; bandwidth:20MHz; Channel:High

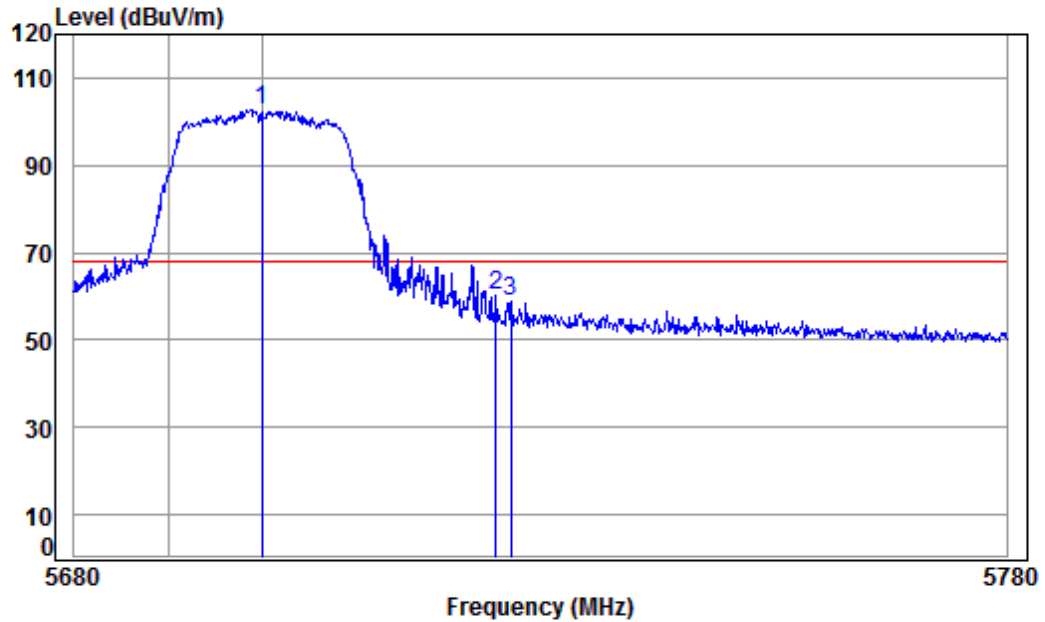

Condition: 3m HORIZONTAL
Job No : 04056CR/04057CR
Mode : 5700 Band edge
: 5G WIFI 11AC20

		Cable	Ant	Preamp	Read	Limit	Over		
	Freq	Loss	Factor	Factor	Level	Level	Line	Limit	Remark
	MHz	dB	dB/m	dB	dBuV	dBuV/m	dBuV/m	dB	
1	pp 5700.000	9.56	34.81	41.86	100.27	102.78	68.20	34.58	peak
2	5725.000	9.64	34.83	41.84	57.48	60.11	68.20	-8.09	peak
3	5726.583	9.65	34.83	41.84	56.25	58.89	68.20	-9.31	peak

Mode:g; Polarization:Vertical; Modulation:802.11ac; bandwidth:20MHz; Channel:High

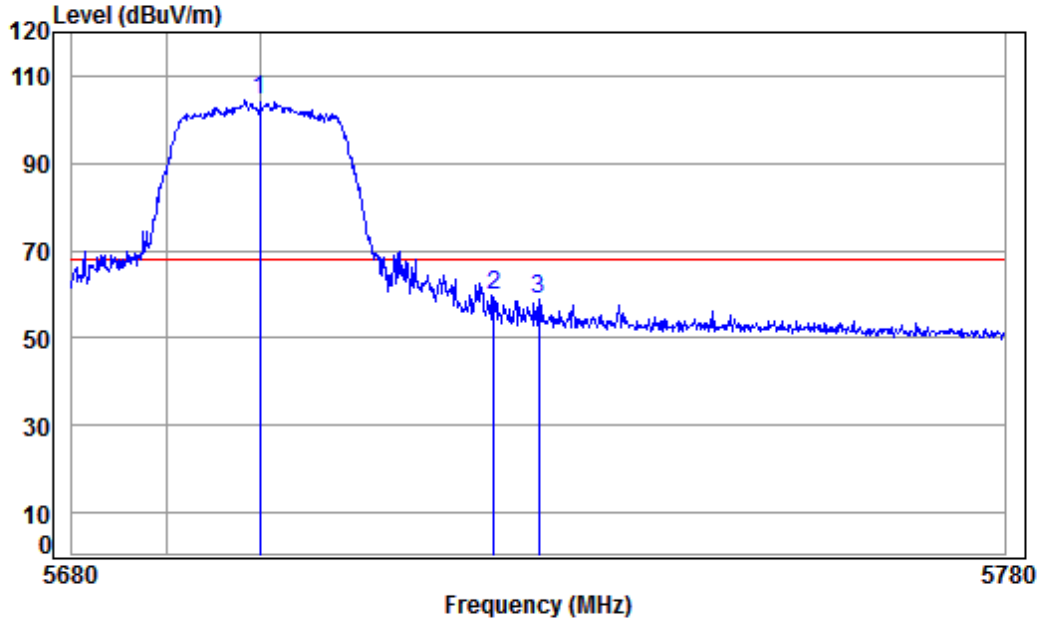

Condition: 3m VERTICAL
 Job No : 04056CR/04057CR
 Mode : 5700 Band edge
 : 5G WIFI 11AC20

		Cable	Ant	Preamp	Read	Limit	Over		
	Freq	Loss	Factor	Factor	Level	Level	Line	Limit	Remark
	MHz	dB	dB/m	dB	dBuV	dBuV/m	dBuV/m	dB	
1	pp 5700.000	9.56	34.81	41.86	101.77	104.28	68.20	36.08	Peak
2	5725.000	9.64	34.83	41.84	57.06	59.69	68.20	-8.51	Peak
3	5729.882	9.66	34.84	41.83	56.20	58.87	68.20	-9.33	Peak



Mode:g; Polarization:Horizontal; Modulation:802.11ac; bandwidth:40MHz; Channel:Low

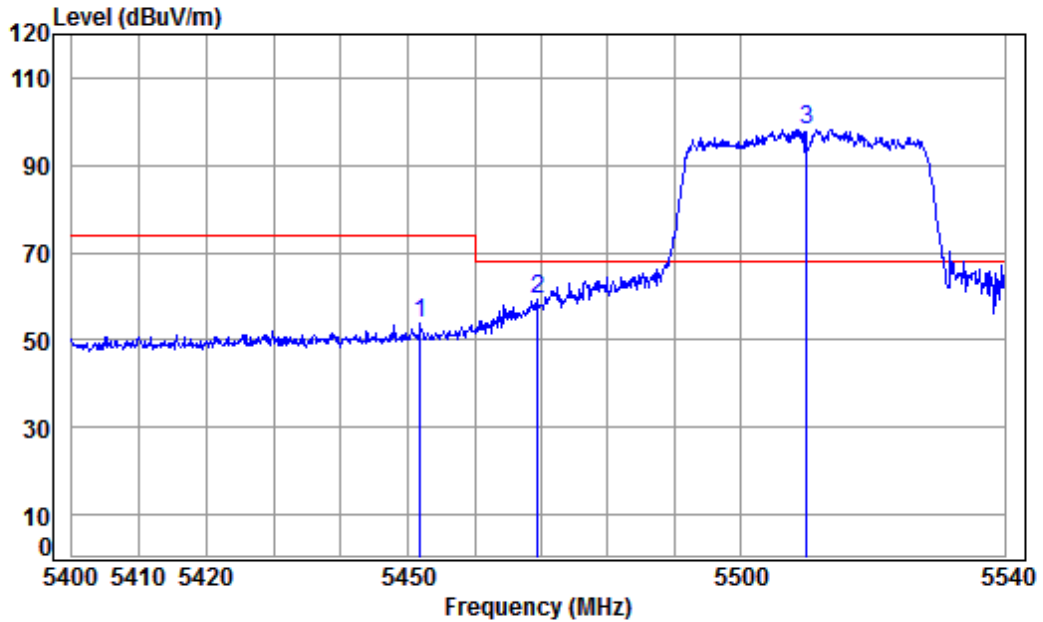

Condition: 3m HORIZONTAL
 Job No : 04056CR/04057CR
 Mode : 5510 Band edge
 : 5G WIFI 11AC40

	Cable	Ant	Preamp	Read	Limit	Over		
Freq	Loss	Factor	Factor	Level	Level	Line	Limit	Remark
MHz	dB	dB/m	dB	dBuV	dBuV/m	dBuV/m	dB	
1	5451.941	8.78	34.56	42.08	52.67	53.93	74.00	-20.07 peak
2	5469.412	8.81	34.58	42.06	58.03	59.36	68.20	-8.84 peak
3 pp	5510.000	8.89	34.61	42.02	96.82	98.30	68.20	30.10 peak



Mode:g; Polarization:Horizontal; Modulation:802.11ac; bandwidth:40MHz; Channel:Low

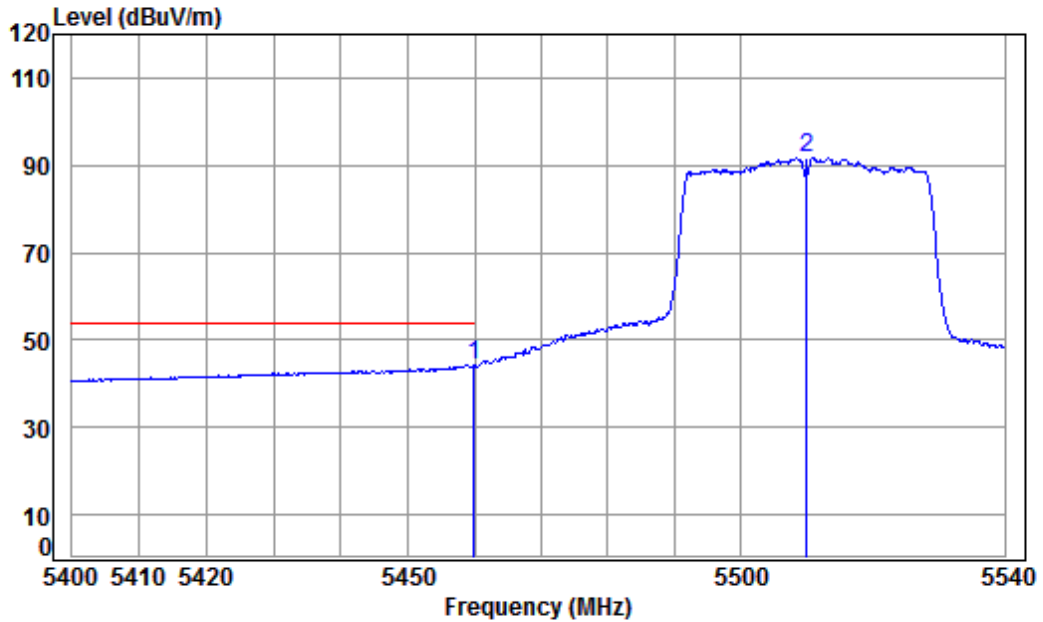

Condition: 3m HORIZONTAL
Job No : 04056CR/04057CR
Mode : 5510 Band edge
: 5G WIFI 11AC40

		Cable	Ant	Preamp	Read	Limit	Over	
	Freq	Loss	Factor	Factor	Level	Level	Line	Limit Remark
	MHz	dB	dB/m	dB	dBuV	dBuV/m	dBuV/m	dB
1	pp 5459.901	8.79	34.57	42.07	42.97	44.26	54.00	-9.74 Average
2	5510.000	8.89	34.61	42.02	90.35	91.83	-----	----- Average



Mode:g; Polarization:Vertical; Modulation:802.11ac; bandwidth:40MHz; Channel:Low

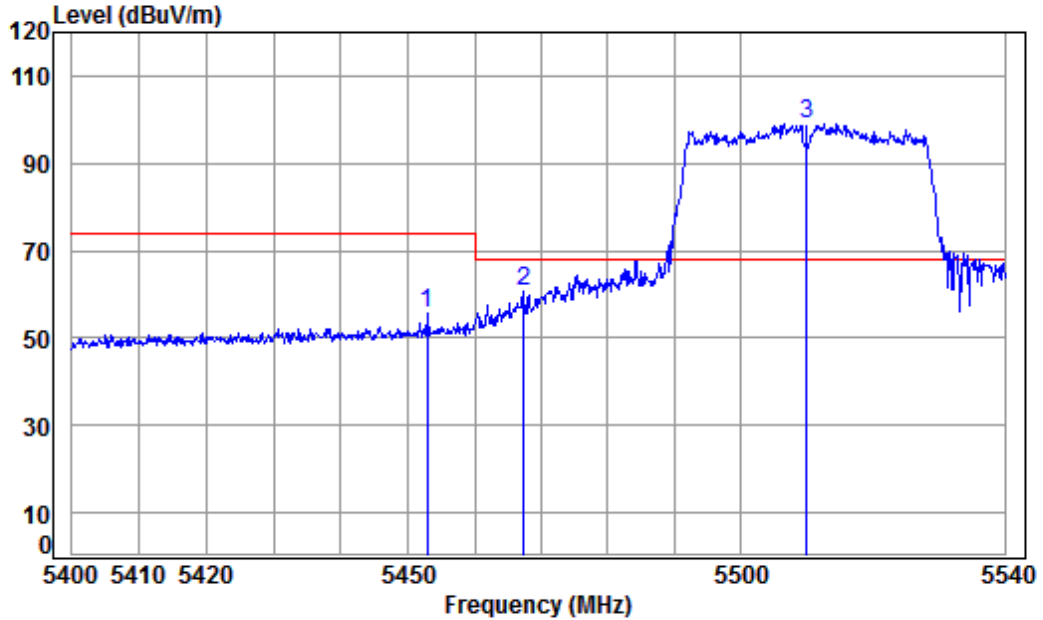

Condition: 3m VERTICAL
Job No : 04056CR/04057CR
Mode : 5510 Band edge
: 5G WIFI 11AC40

	Cable	Ant	Preamp	Read	Limit	Over		
Freq	Loss	Factor	Factor	Level	Level	Line	Limit	Remark
MHz	dB	dB/m	dB	dBuV	dBuV/m	dBuV/m	dB	
1	5452.918	8.78	34.56	42.08	54.34	55.60	74.00	-18.40 Peak
2	5467.313	8.80	34.57	42.06	59.55	60.86	68.20	-7.34 peak
3 pp	5510.000	8.89	34.61	42.02	97.67	99.15	68.20	30.95 Peak



Mode:g; Polarization:Vertical; Modulation:802.11ac; bandwidth:40MHz; Channel:Low

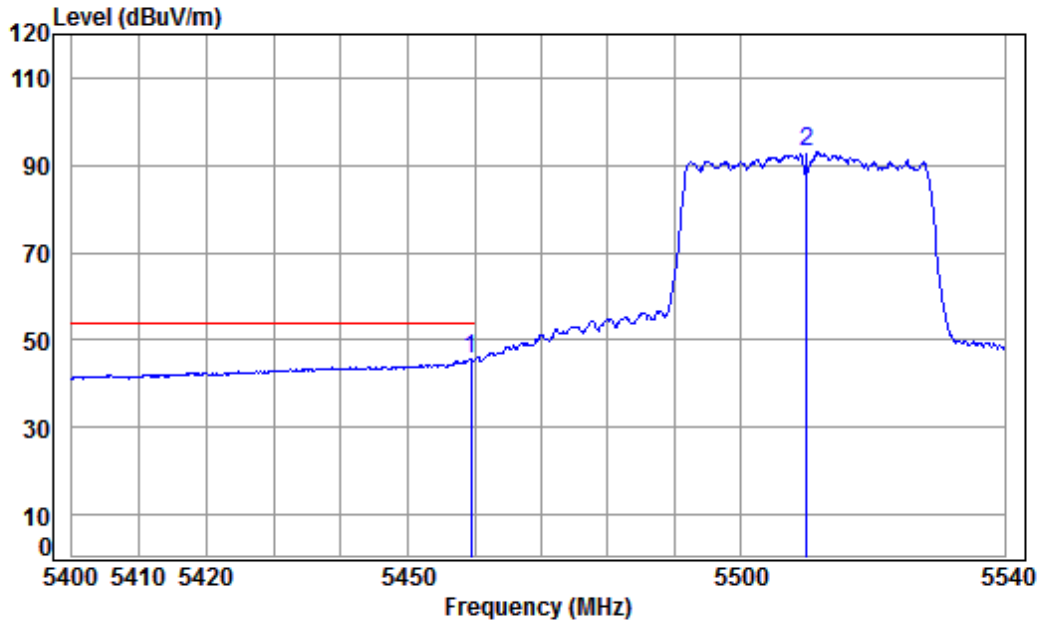

Condition: 3m VERTICAL
Job No : 04056CR/04057CR
Mode : 5510 Band edge
: 5G WIFI 11AC40

		Cable	Ant	Preamp	Read	Limit	Over	
	Freq	Loss	Factor	Factor	Level	Level	Line	Limit Remark
	MHz	dB	dB/m	dB	dBuV	dBuV/m	dBuV/m	dB
1	pp 5459.481	8.79	34.57	42.07	44.36	45.65	54.00	-8.35 Average
2	5510.000	8.89	34.61	42.02	91.53	93.01	-----	----- Average



Mode:g; Polarization:Horizontal; Modulation:802.11ac; bandwidth:40MHz; Channel:High

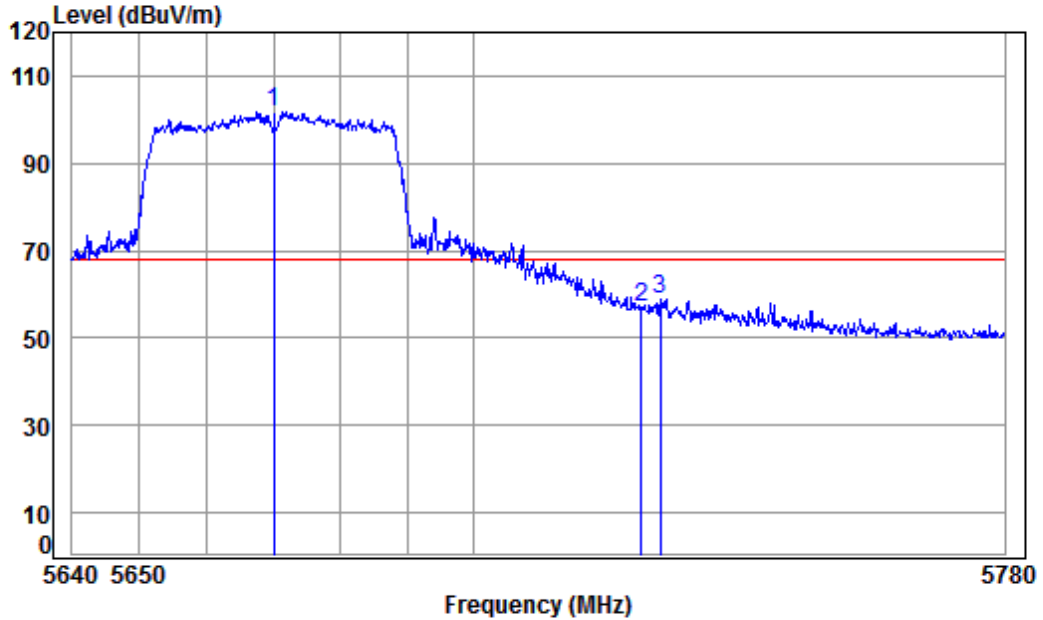

Condition: 3m HORIZONTAL
Job No : 04056CR/04057CR
Mode : 5670 Band edge
: 5G WIFI 11AC40

		Cable	Ant	Preamp	Read	Limit	Over		
	Freq	Loss	Factor	Factor	Level	Level	Line	Limit	Remark
	MHz	dB	dB/m	dB	dBuV	dBuV/m	dBuV/m	dB	
1	pp 5670.000	9.45	34.77	41.88	99.58	101.92	68.20	33.72	peak
2	5725.000	9.64	34.83	41.84	54.62	57.25	68.20	-10.95	peak
3	5727.940	9.65	34.83	41.83	56.37	59.02	68.20	-9.18	peak



Mode:g; Polarization:Vertical; Modulation:802.11ac; bandwidth:40MHz; Channel:High

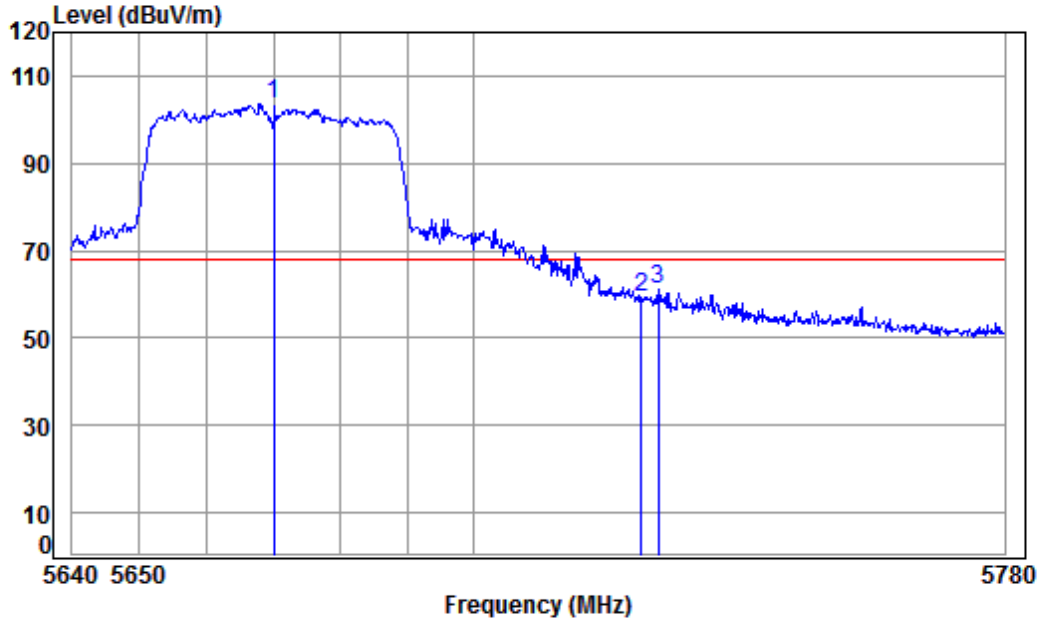

Condition: 3m VERTICAL
Job No : 04056CR/04057CR
Mode : 5670 Band edge
: 5G WIFI 11AC40

		Cable	Ant	Preamp	Read	Limit	Over		
	Freq	Loss	Factor	Factor	Level	Level	Line	Limit	Remark
	MHz	dB	dB/m	dB	dBuV	dBuV/m	dBuV/m	dB	
1	pp 5670.000	9.45	34.77	41.88	101.18	103.52	68.20	35.32	Peak
2	5725.000	9.64	34.83	41.84	56.53	59.16	68.20	-9.04	Peak
3	5727.659	9.65	34.83	41.84	58.31	60.95	68.20	-7.25	Peak



Mode:g; Polarization:Horizontal; Modulation:802.11ac; bandwidth:80MHz; Channel:Low

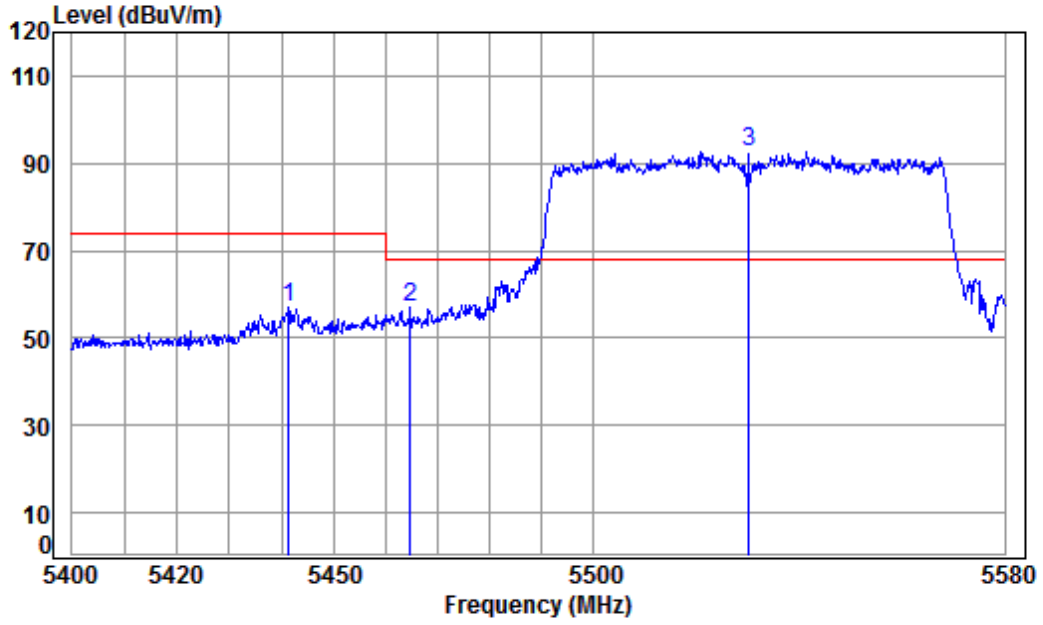

Condition: 3m HORIZONTAL
Job No : 04056CR/04057CR
Mode : 5530 Band edge
: 5G WIFI 11AC80

	Freq	Cable Loss	Ant Factor	Preamplifier	Read Level	Level	Limit	Over	Remark
	MHz	dB	dB/m	dB	dBuV	dBuV/m	dBuV/m	dB	
1	5441.236	8.76	34.55	42.09	55.65	56.87	74.00	-17.13	peak
2	5464.659	8.80	34.57	42.07	55.66	56.96	68.20	-11.24	peak
3 pp	5530.000	8.96	34.63	42.01	90.85	92.43	68.20	24.23	peak



Mode:g; Polarization:Horizontal; Modulation:802.11ac; bandwidth:80MHz; Channel:Low

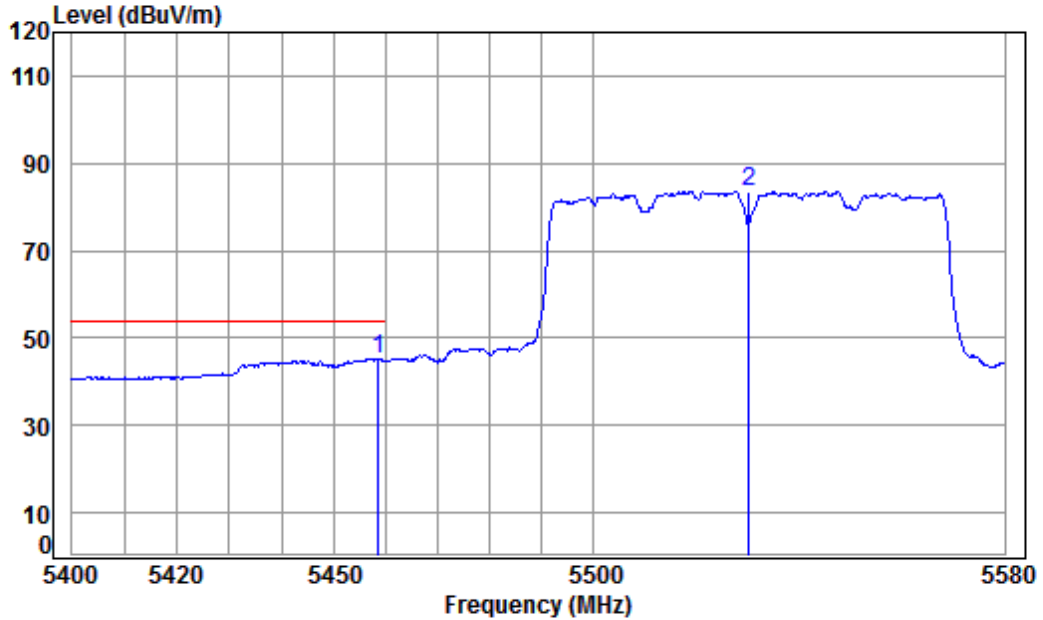

Condition: 3m HORIZONTAL
Job No : 04056CR/04057CR
Mode : 5530 Band edge
: 5G WIFI 11AC80

		Cable	Ant	Preamp	Read	Limit	Over	
	Freq	Loss	Factor	Factor	Level	Level	Line	Limit Remark
	MHz	dB	dB/m	dB	dBuV	dBuV/m	dBuV/m	dB
1	pp 5458.570	8.79	34.57	42.07	44.07	45.36	54.00	-8.64 Average
2	5530.000	8.96	34.63	42.01	81.96	83.54	-----	----- Average



Mode:g; Polarization:Vertical; Modulation:802.11ac; bandwidth:80MHz; Channel:Low

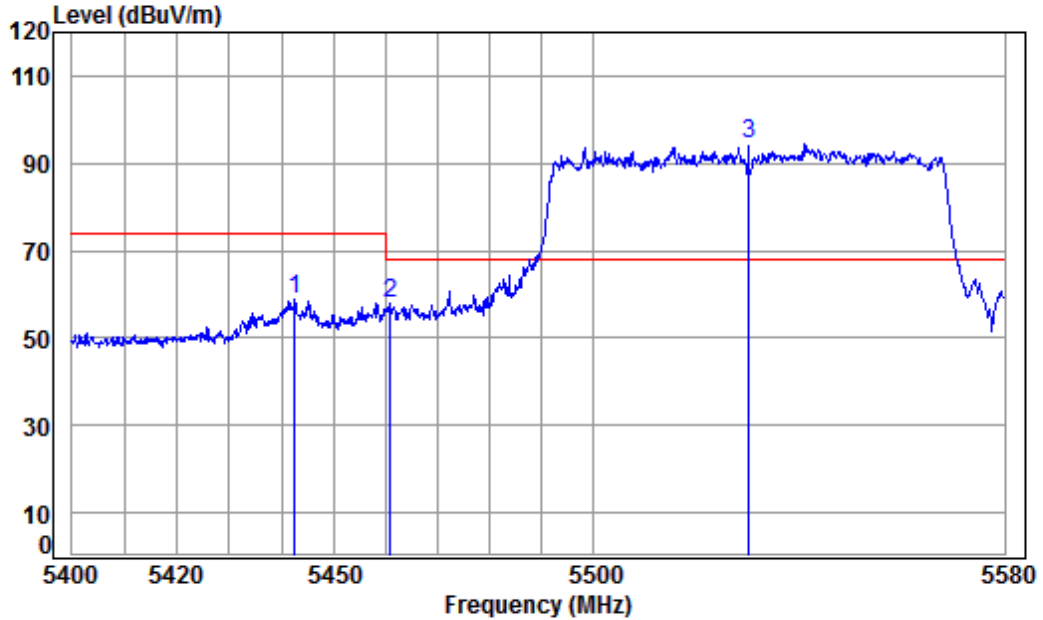

Condition: 3m VERTICAL
Job No : 04056CR/04057CR
Mode : 5530 Band edge
: 5G WIFI 11AC80

	Cable	Ant	Preamp	Read	Limit	Over		
Freq	Loss	Factor	Factor	Level	Level	Line	Limit	Remark
MHz	dB	dB/m	dB	dBuV	dBuV/m	dBuV/m	dB	
1	5442.485	8.77	34.56	42.09	57.74	58.98	74.00	-15.02 Peak
2	5460.718	8.79	34.57	42.07	56.53	57.82	68.20	-10.38 peak
3 pp	5530.000	8.96	34.63	42.01	92.67	94.25	68.20	26.05 Peak



Mode:g; Polarization:Vertical; Modulation:802.11ac; bandwidth:80MHz; Channel:Low

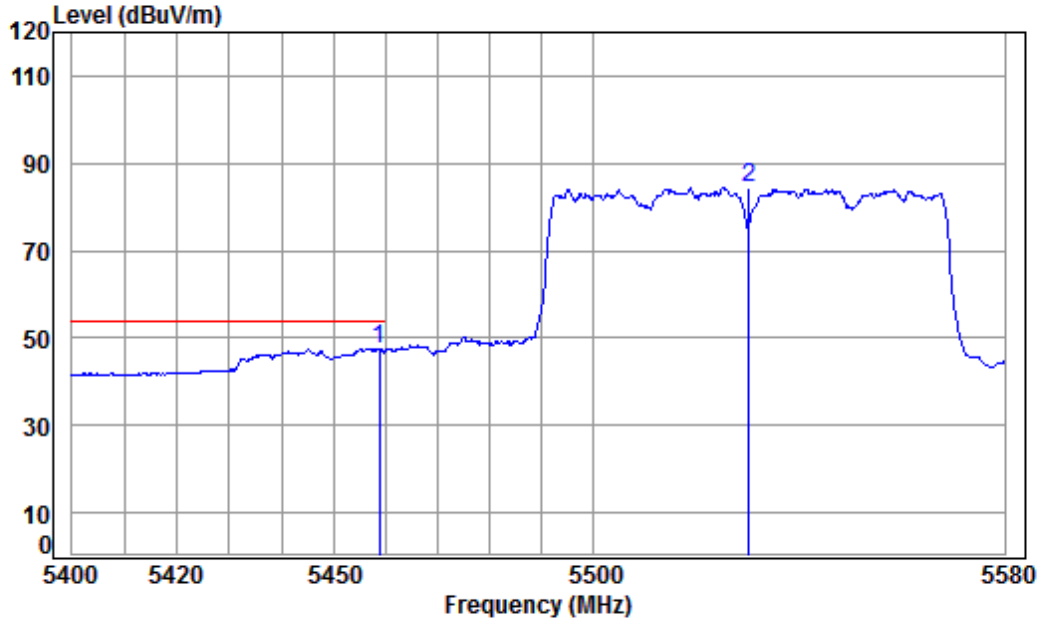

Condition: 3m VERTICAL
 Job No : 04056CR/04057CR
 Mode : 5530 Band edge
 : 5G WIFI 11AC80

		Cable	Ant	Preamp	Read	Limit	Over		
	Freq	Loss	Factor	Factor	Level	Level	Line	Limit	Remark
	MHz	dB	dB/m	dB	dBuV	dBuV/m	dBuV/m	dB	
1	pp 5458.749	8.79	34.57	42.07	46.30	47.59	54.00	-6.41	Average
2	5530.000	8.96	34.63	42.01	82.95	84.53	-----	-----	Average



Mode:g; Polarization:Horizontal; Modulation:802.11ac; bandwidth:80MHz; Channel:High

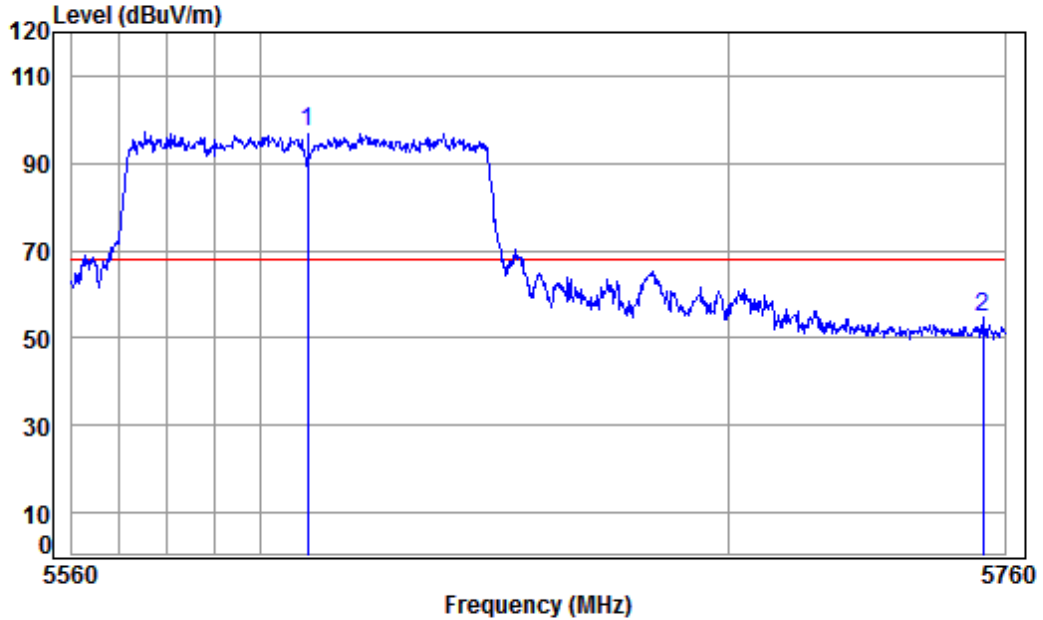

Condition: 3m HORIZONTAL
Job No : 04056CR/04057CR
Mode : 5610 Band edge
: 5G WIFI 11AC80

		Cable	Ant	Preamp	Read	Limit	Over	
	Freq	Loss	Factor	Factor	Level	Level	Line	Limit Remark
	MHz	dB	dB/m	dB	dBuV	dBuV/m	dBuV/m	dB
1	pp 5610.000	9.24	34.71	41.94	95.20	97.21	68.20	29.01 peak
2	5755.320	9.75	34.86	41.81	51.87	54.67	68.20	-13.53 peak



Mode:g; Polarization:Vertical; Modulation:802.11ac; bandwidth:80MHz; Channel:High

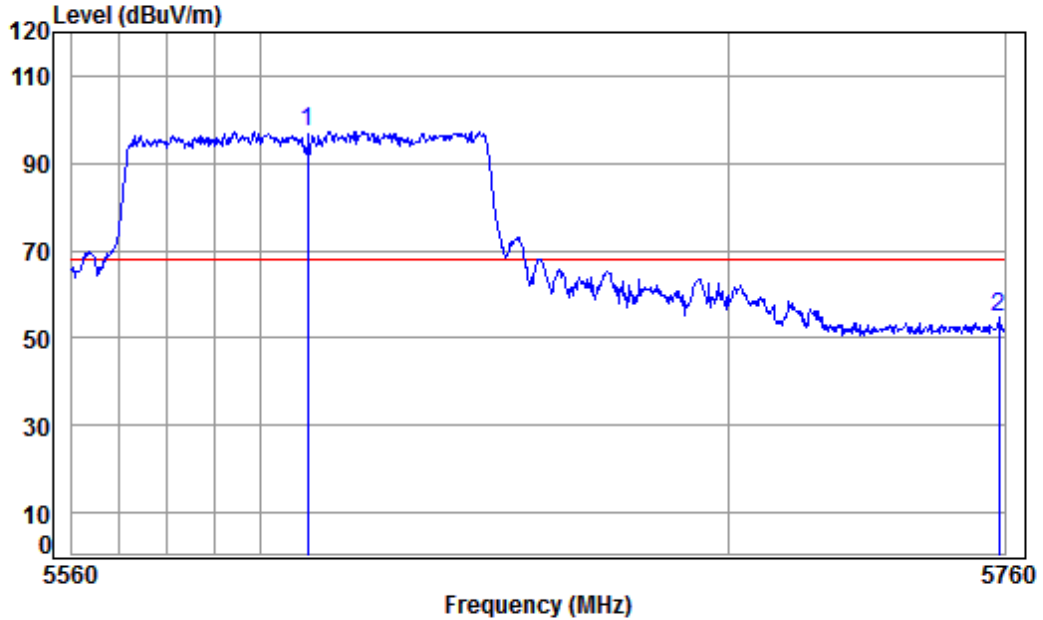

Condition: 3m VERTICAL
Job No : 04056CR/04057CR
Mode : 5610 Band edge
: 5G WIFI 11AC80

		Cable	Ant	Preamp	Read	Limit	Over		
	Freq	Loss	Factor	Factor	Level	Level	Line	Limit	Remark
	MHz	dB	dB/m	dB	dBuV	dBuV/m	dBuV/m	dB	
1	pp 5610.000	9.24	34.71	41.94	95.35	97.36	68.20	29.16	Peak
2	5758.779	9.76	34.86	41.81	51.95	54.76	68.20	-13.44	Peak



Mode:h; Polarization:Horizontal; Modulation:802.11a; bandwidth:20MHz; Channel:Low

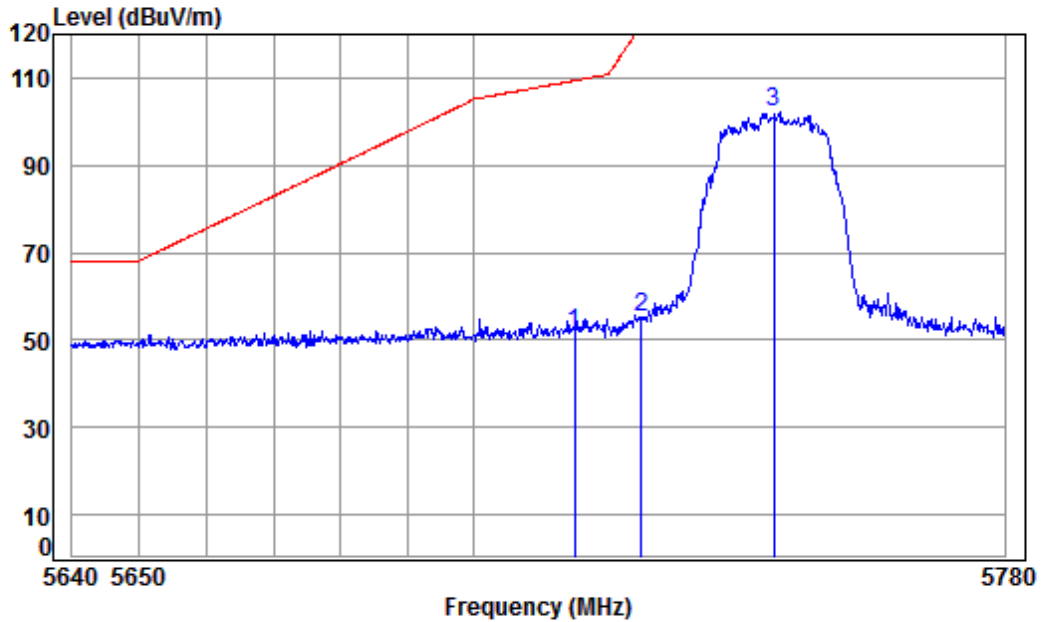

Condition : 3m HORIZONTAL
Job No : 04056CR/04057CR
Mode : 5745 Band edge
: 5G WIFI 11A

Powersetting:

	Freq	Cable Loss	Ant Factor	Preamp Factor	Read Level	Limit Level	Limit Line	Over Limit	Remark
	MHz	dB	dB/m	dB	dBuV	dBuV/m	dBuV/m	dB	
1	5715.000	9.61	34.82	41.85	48.99	51.57	109.40	-57.83	peak
2	5725.000	9.64	34.83	41.84	52.37	55.00	122.20	-67.20	peak
3	5745.000	9.71	34.85	41.82	99.24	101.98	125.20	-23.22	peak



Mode:h; Polarization:Vertical; Modulation:802.11a; bandwidth:20MHz; Channel:Low

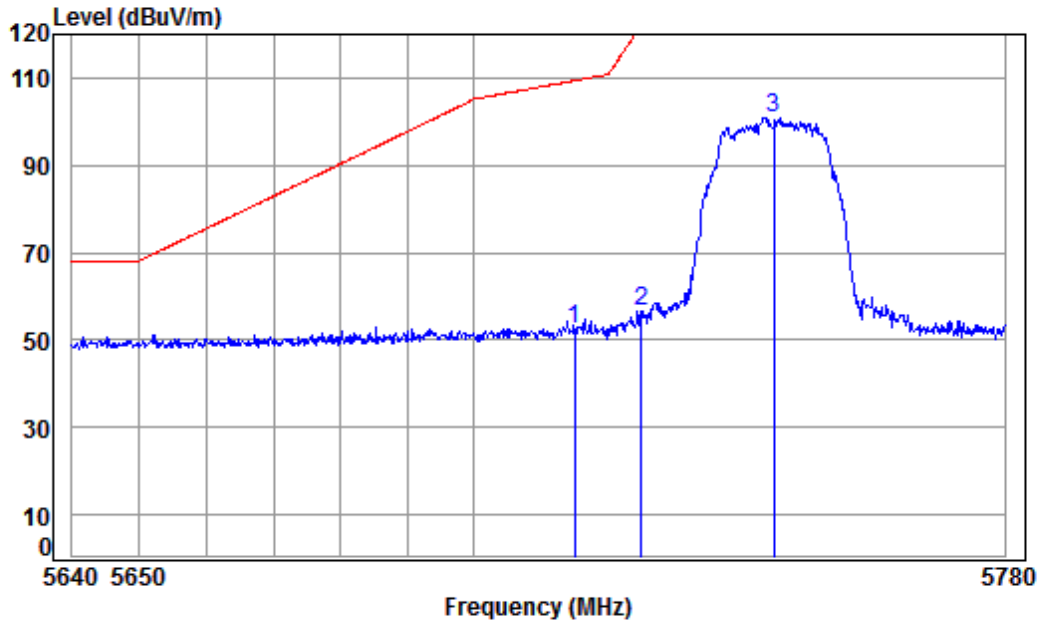

Condition : 3m VERTICAL
Job No : 04056CR/04057CR
Mode : 5745 Band edge
: 5G WIFI 11A

Powersetting:

	Freq	Cable Loss	Ant Factor	Preamp Factor	Read Level	Limit Level	Limit Line	Over Limit	Remark
	MHz	dB	dB/m	dB	dBuV	dBuV/m	dBuV/m	dB	
1	5715.000	9.61	34.82	41.85	49.95	52.53	109.40	-56.87	peak
2	5725.000	9.64	34.83	41.84	53.91	56.54	122.20	-65.66	peak
3	5745.000	9.71	34.85	41.82	98.24	100.98	125.20	-24.22	peak



Mode:h; Polarization:Horizontal; Modulation:802.11a; bandwidth:20MHz; Channel:High

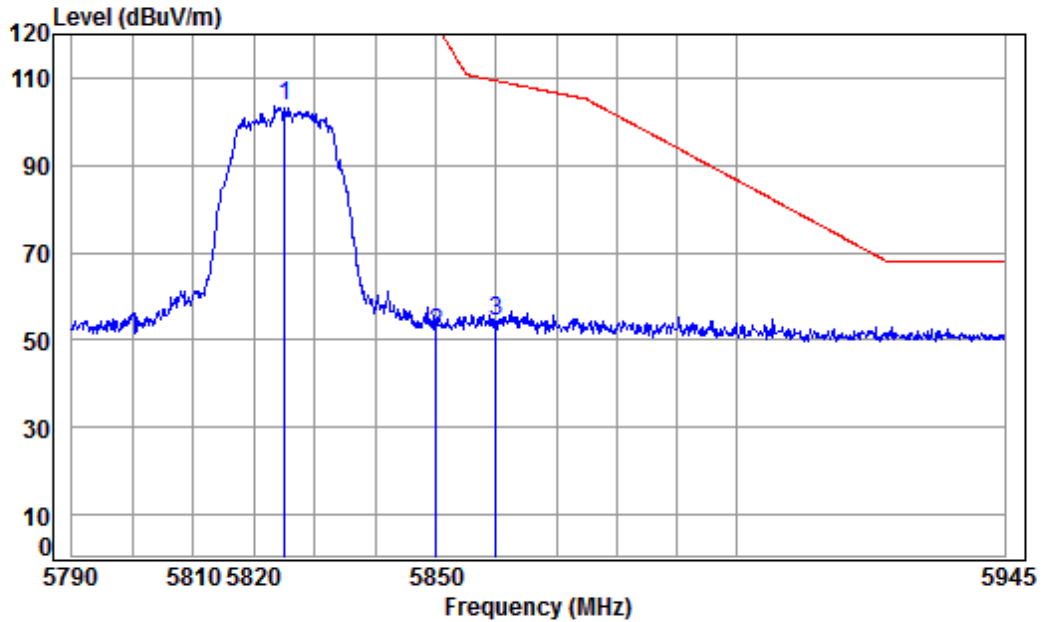

Condition : 3m HORIZONTAL
Job No : 04056CR/04057CR
Mode : 5825 Band edge
: 5G WIFI 11A

Powersetting:

	Cable	Ant	Preamp	Read	Limit	Over		
Freq	Loss	Factor	Factor	Level	Level	Line	Limit	Remark
MHz	dB	dB/m	dB	dBuV	dBuV/m	dBuV/m	dB	
1 pp 5825.000	9.98	34.93	41.75	100.24	103.40	125.20	-21.80	peak
2 5850.000	10.07	34.95	41.73	48.46	51.75	122.20	-70.45	peak
3 5860.000	10.10	34.96	41.72	50.81	54.15	109.40	-55.25	peak



Mode:h; Polarization:Vertical; Modulation:802.11a; bandwidth:20MHz; Channel:High

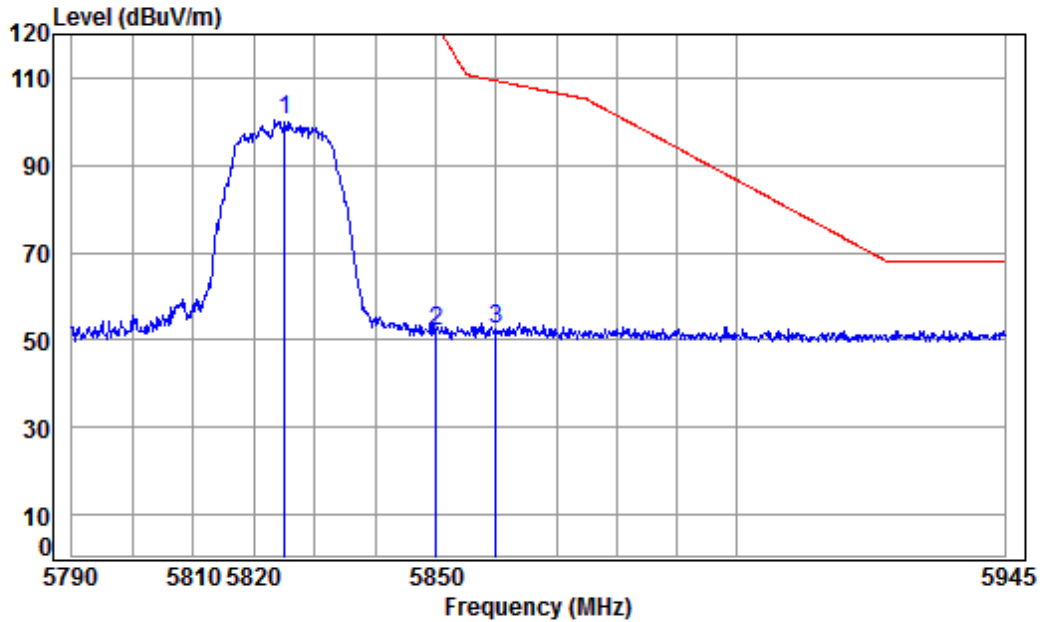

Condition : 3m VERTICAL
Job No : 04056CR/04057CR
Mode : 5825 Band edge
: 5G WIFI 11A

Powersetting:

	Freq	Cable Loss	Ant Factor	Preamp Factor	Read Level	Limit Level	Limit Line	Over Limit	Remark
	MHz	dB	dB/m	dB	dBuV	dBuV/m	dBuV/m	dB	
1	pp 5825.000	9.98	34.93	41.75	97.08	100.24	125.20	-24.96	peak
2	5850.000	10.07	34.95	41.73	48.64	51.93	122.20	-70.27	peak
3	5860.000	10.10	34.96	41.72	49.07	52.41	109.40	-56.99	peak



Mode:h; Polarization:Horizontal; Modulation:802.11n; bandwidth:20MHz; Channel:Low

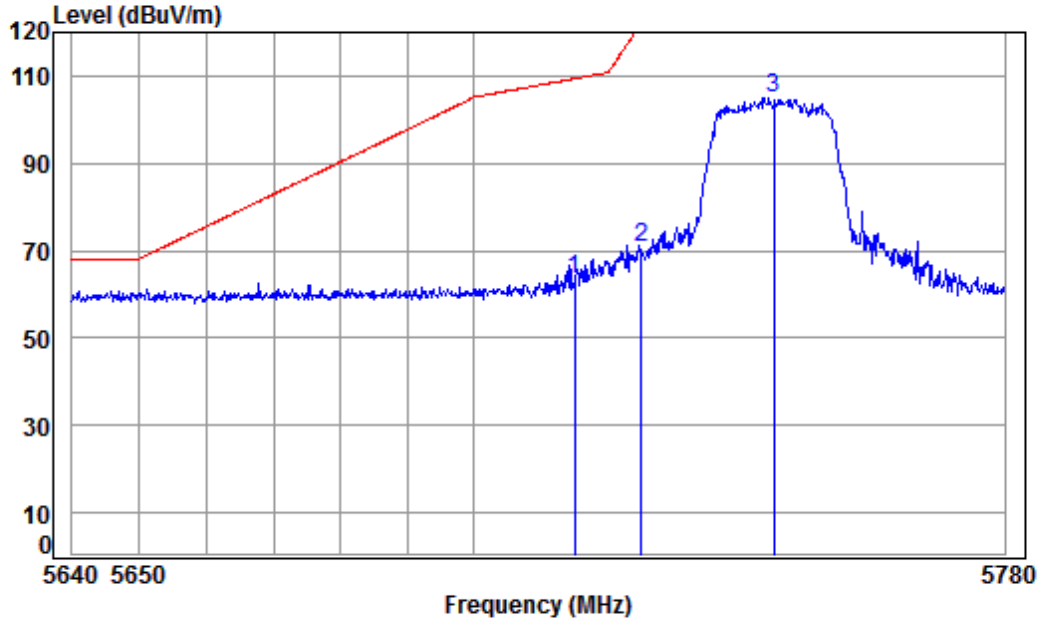

Condition : 3m HORIZONTAL
Job No : 04056CR/04057CR
Mode : 5745 Band edge
: 5G WIFI 11N20

Powersetting:

	Freq	Cable Loss	Ant Factor	Preamp Factor	Read Level	Level	Limit Line	Over Limit	Remark
	MHz	dB	dB/m	dB	dBuV	dBuV/m	dBuV/m	dB	
1	5715.000	9.61	34.82	41.85	60.70	63.28	109.40	-46.12	peak
2	5725.000	9.64	34.83	41.84	68.23	70.86	122.20	-51.34	peak
3	pp 5745.000	9.71	34.85	41.82	102.26	105.00	125.20	-20.20	peak



Mode:h; Polarization:Vertical; Modulation:802.11n; bandwidth:20MHz; Channel:Low

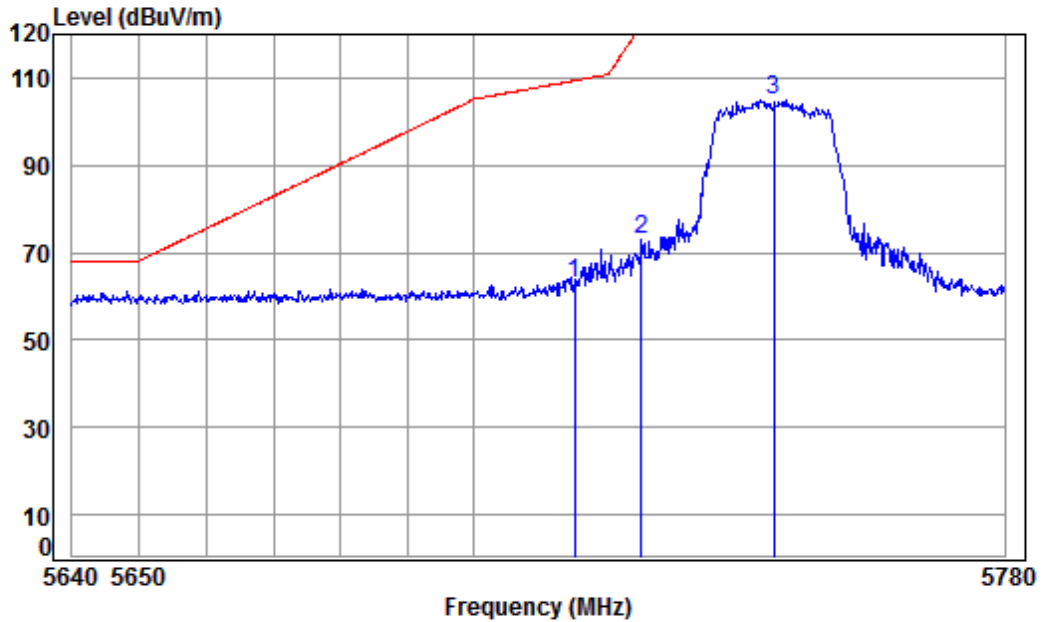

Condition : 3m VERTICAL
Job No : 04056CR/04057CR
Mode : 5745 Band edge
: 5G WIFI 11N20

Powersetting:

	Freq	Cable Loss	Ant Factor	Preamp Factor	Read Level	Level	Limit Line	Over Limit	Remark
	MHz	dB	dB/m	dB	dBuV	dBuV/m	dBuV/m	dB	
1	5715.000	9.61	34.82	41.85	60.44	63.02	109.40	-46.38	peak
2	5725.000	9.64	34.83	41.84	70.30	72.93	122.20	-49.27	peak
3	5745.000	9.71	34.85	41.82	102.25	104.99	125.20	-20.21	peak



Mode:h; Polarization:Horizontal; Modulation:802.11n; bandwidth:20MHz; Channel:High

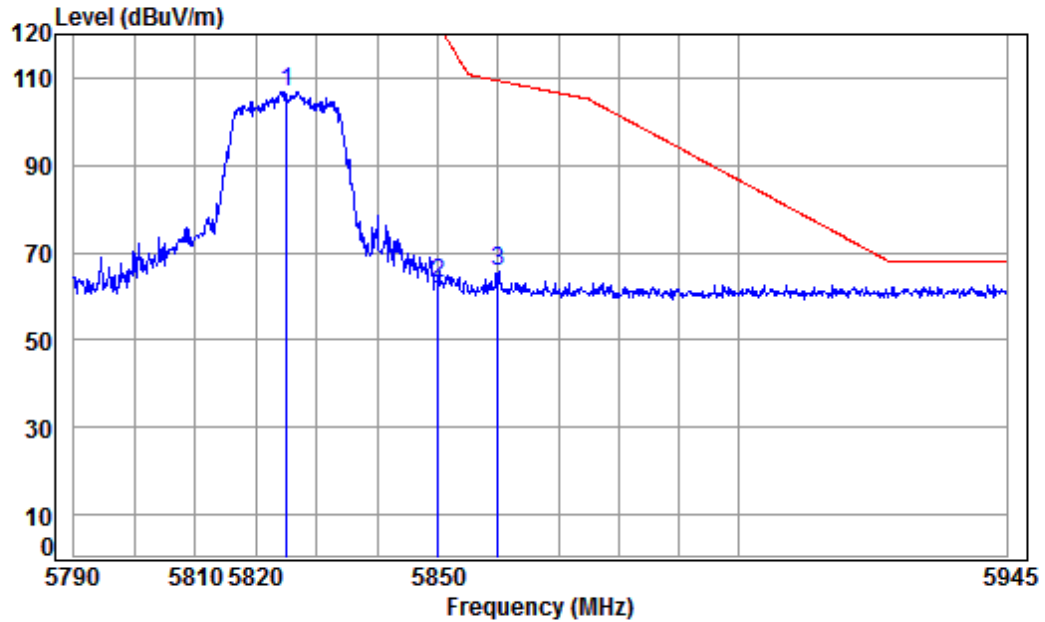

Condition : 3m HORIZONTAL
Job No : 04056CR/04057CR
Mode : 5825 Band edge
: 5G WIFI 11N20

Powersetting:

	Freq	Cable Loss	Ant Factor	Preamp Factor	Read Level	Limit Level	Limit Line	Over Limit	Remark
	MHz	dB	dB/m	dB	dBuV	dBuV/m	dBuV/m	dB	
1	pp 5825.000	9.98	34.93	41.75	103.58	106.74	125.20	-18.46	peak
2	5850.000	10.07	34.95	41.73	59.62	62.91	122.20	-59.29	peak
3	5860.000	10.10	34.96	41.72	62.42	65.76	109.40	-43.64	peak