

Maximum Power Spectral Density_TNVN_11AC80MIMO_5530_Ant1

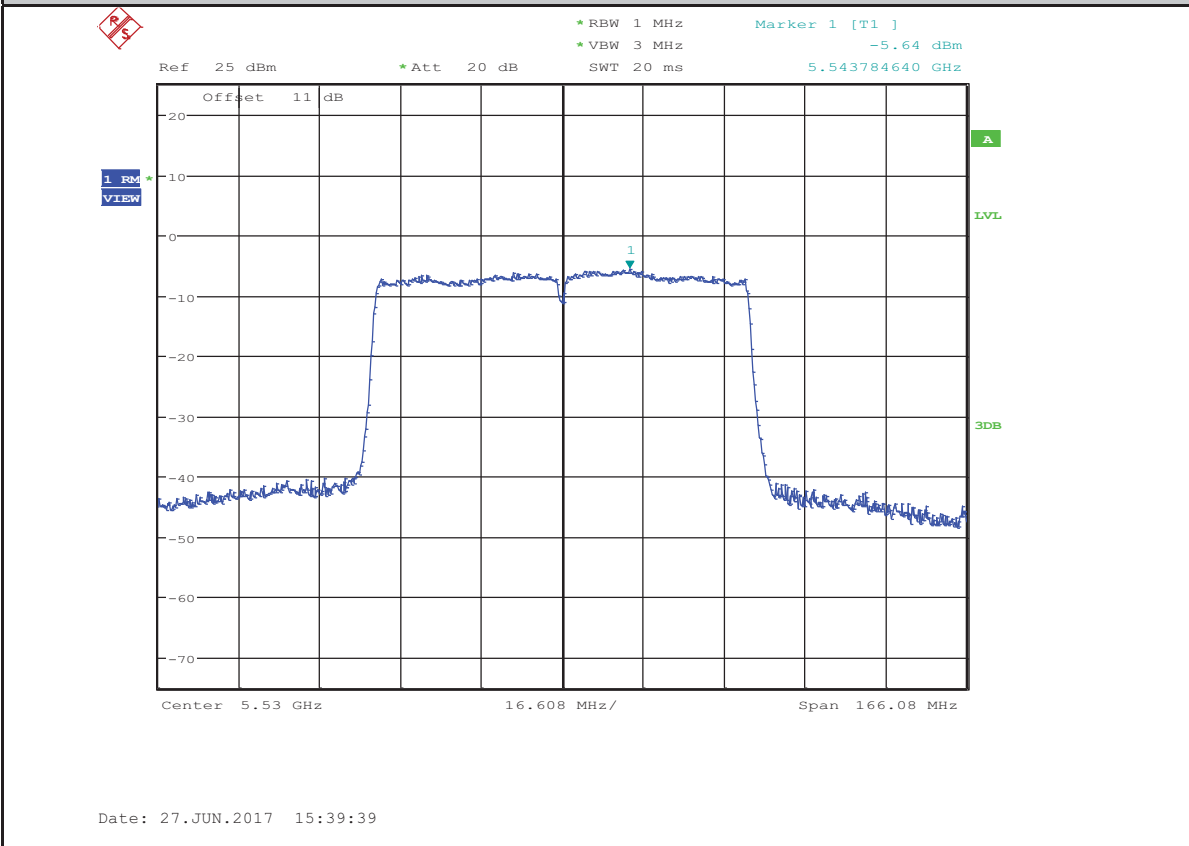

Maximum Power Spectral Density_TNVN_11AC80MIMO_5530_Ant2

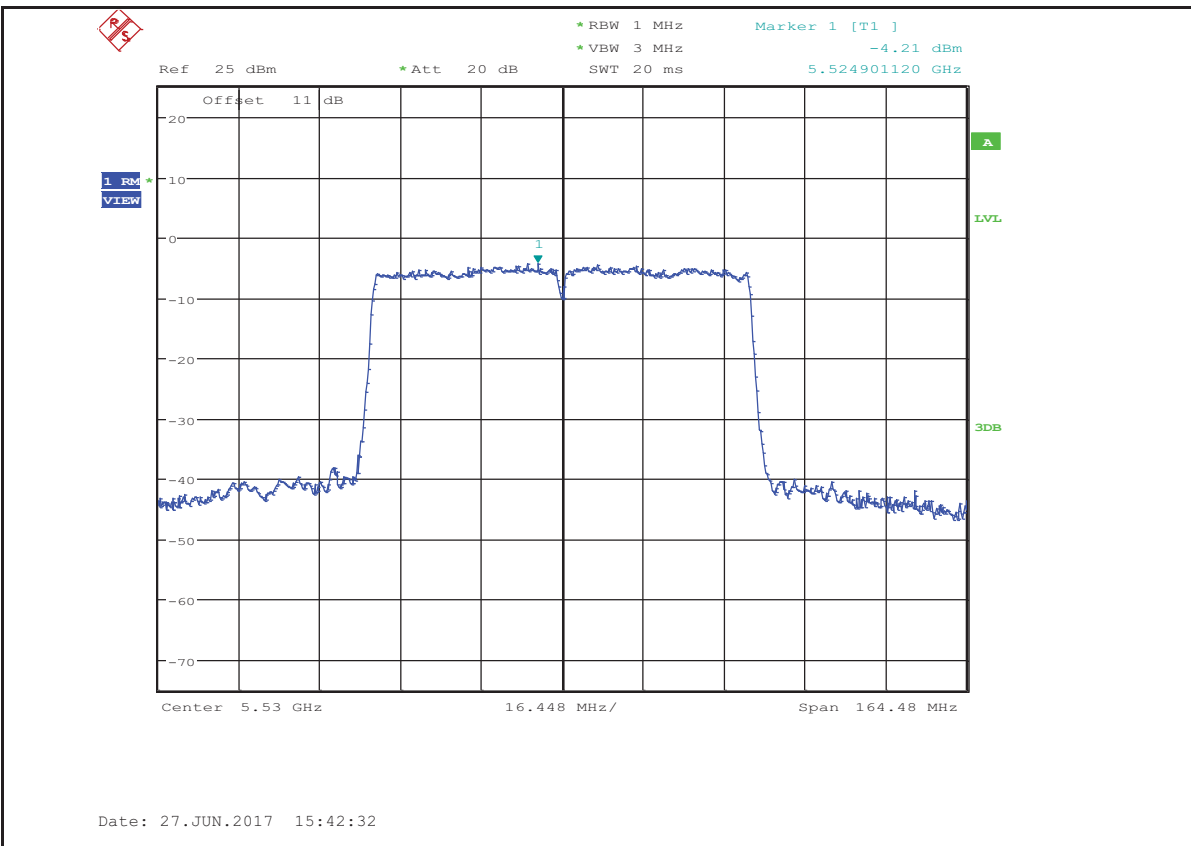

Maximum Power Spectral Density_TNVN_11AC80MIMO_5530_Ant1+Ant2

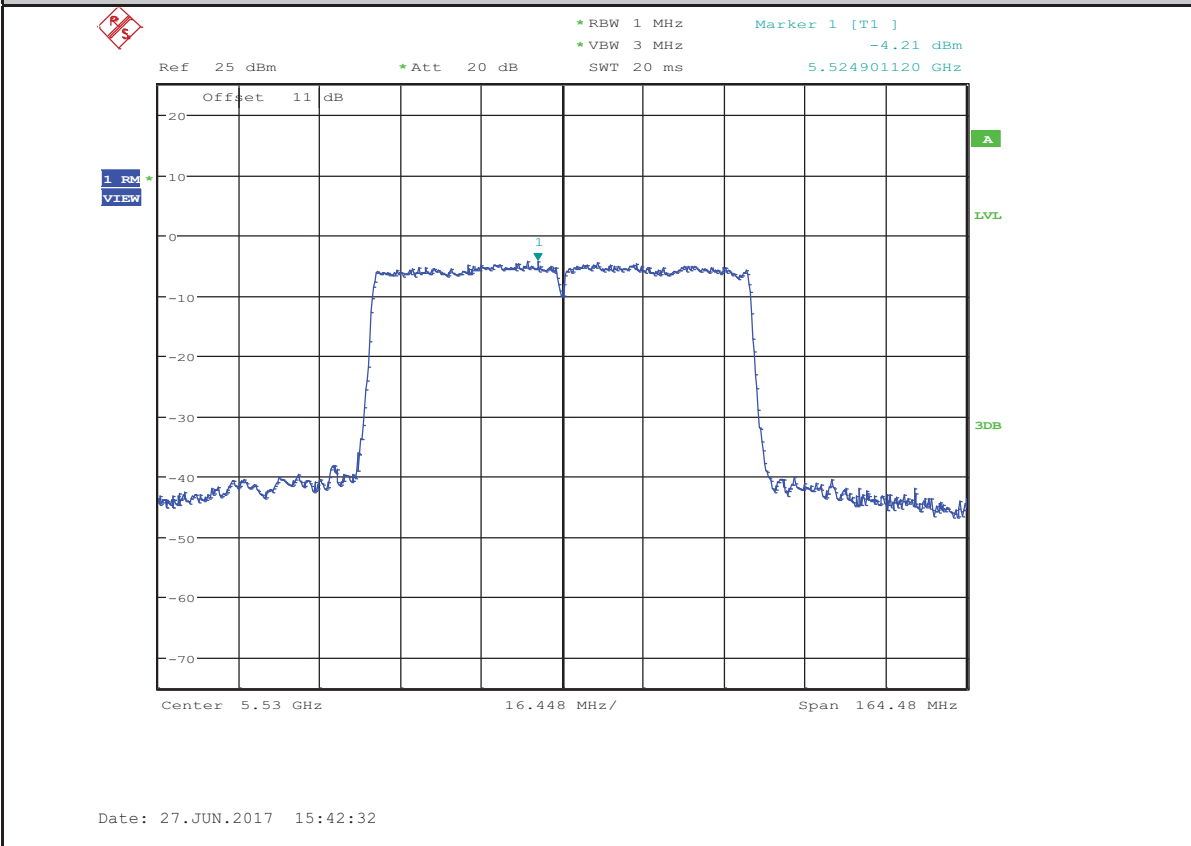

Maximum Power Spectral Density_TNVN_11AC80MIMO_5775_Ant1

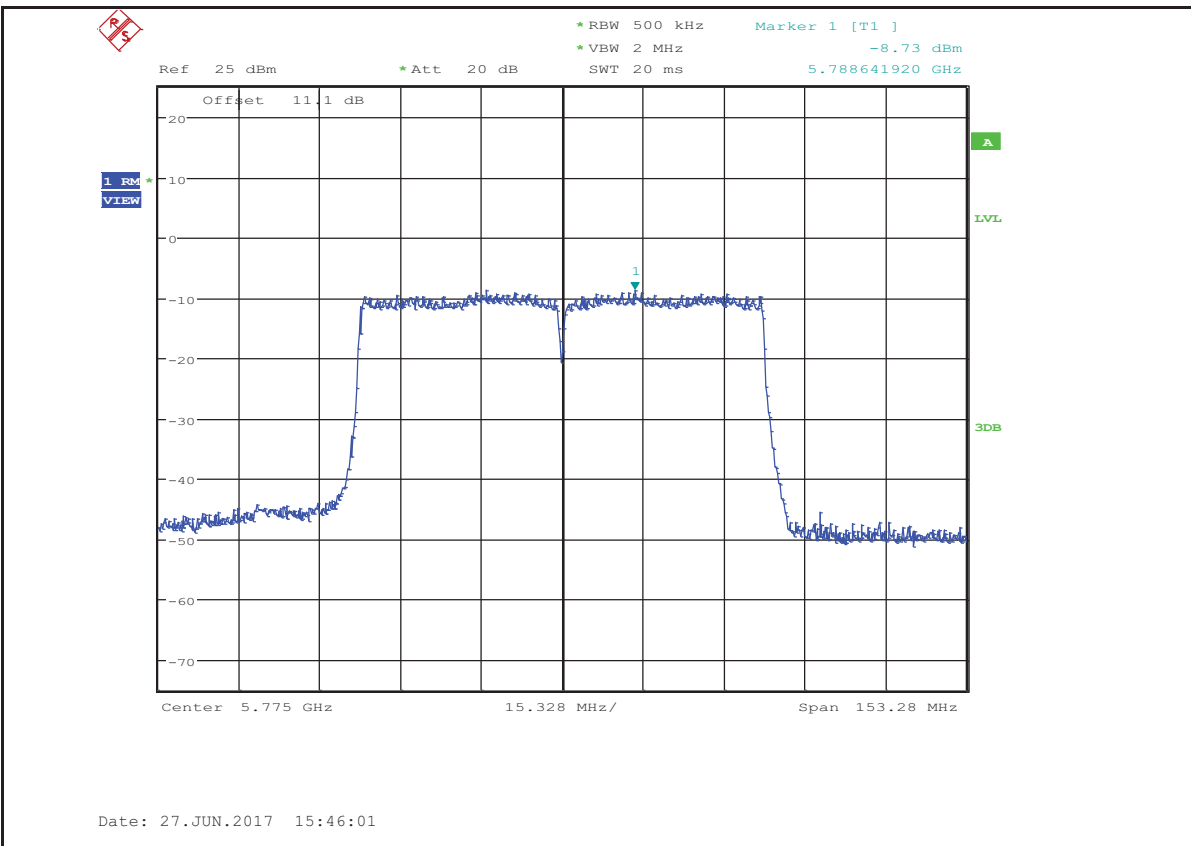

Maximum Power Spectral Density_TNVN_11AC80MIMO_5775_Ant2

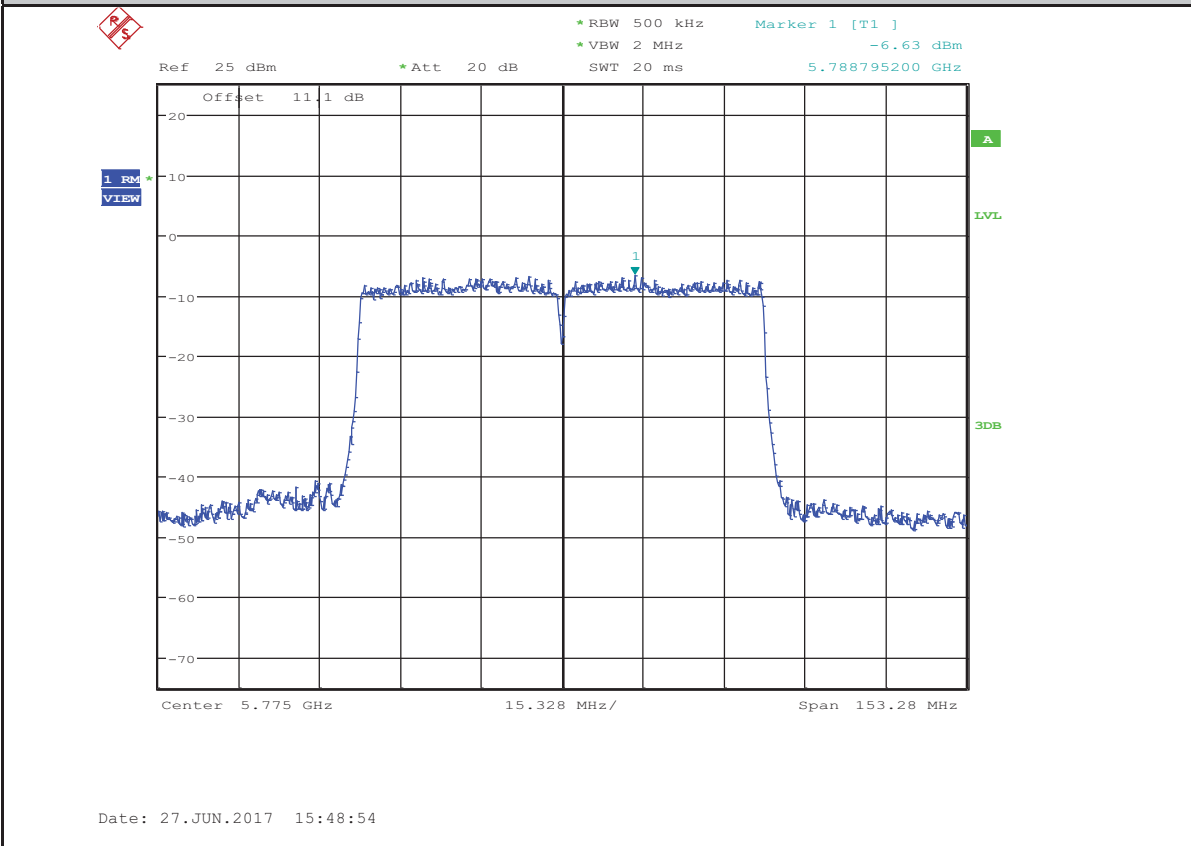

Maximum Power Spectral Density_TNVN_11AC80MIMO_5775_Ant1+Ant2

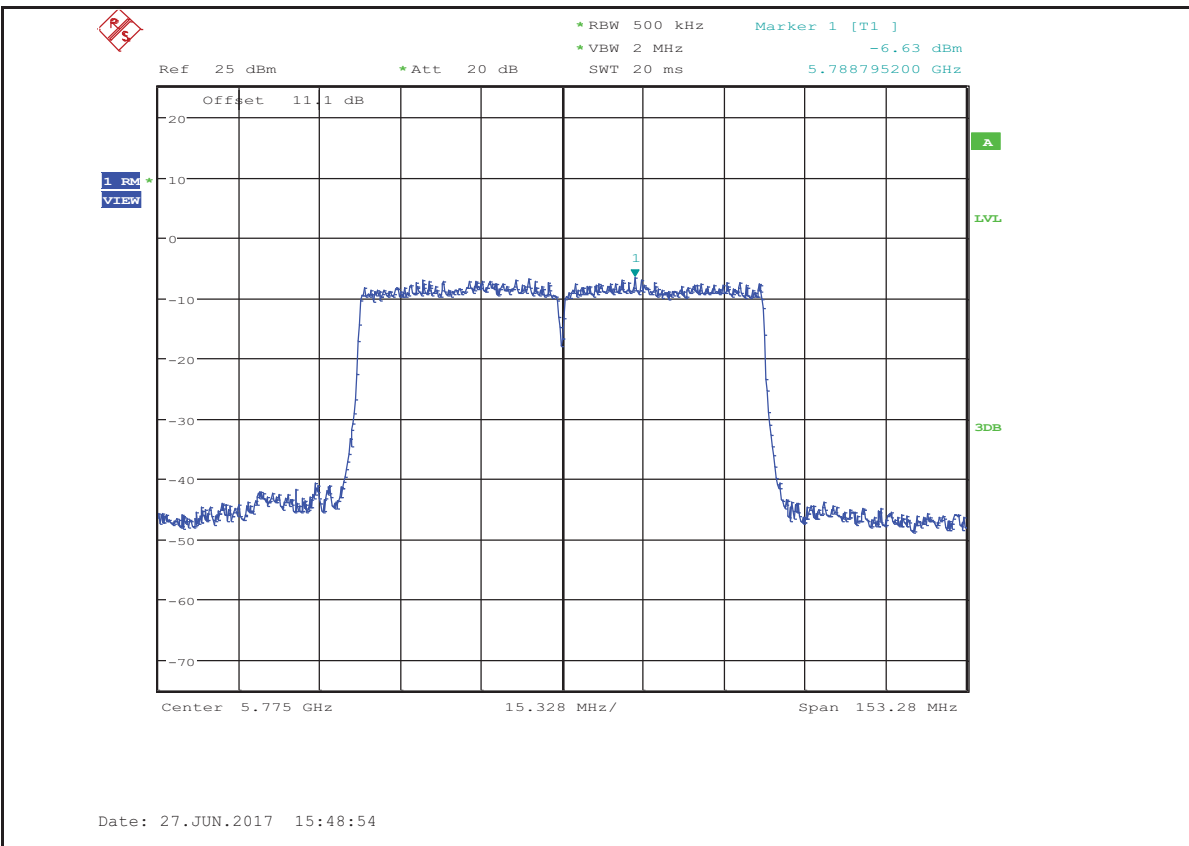

Maximum Power Spectral Density_TNVN_11AMIMO_5180_Ant1

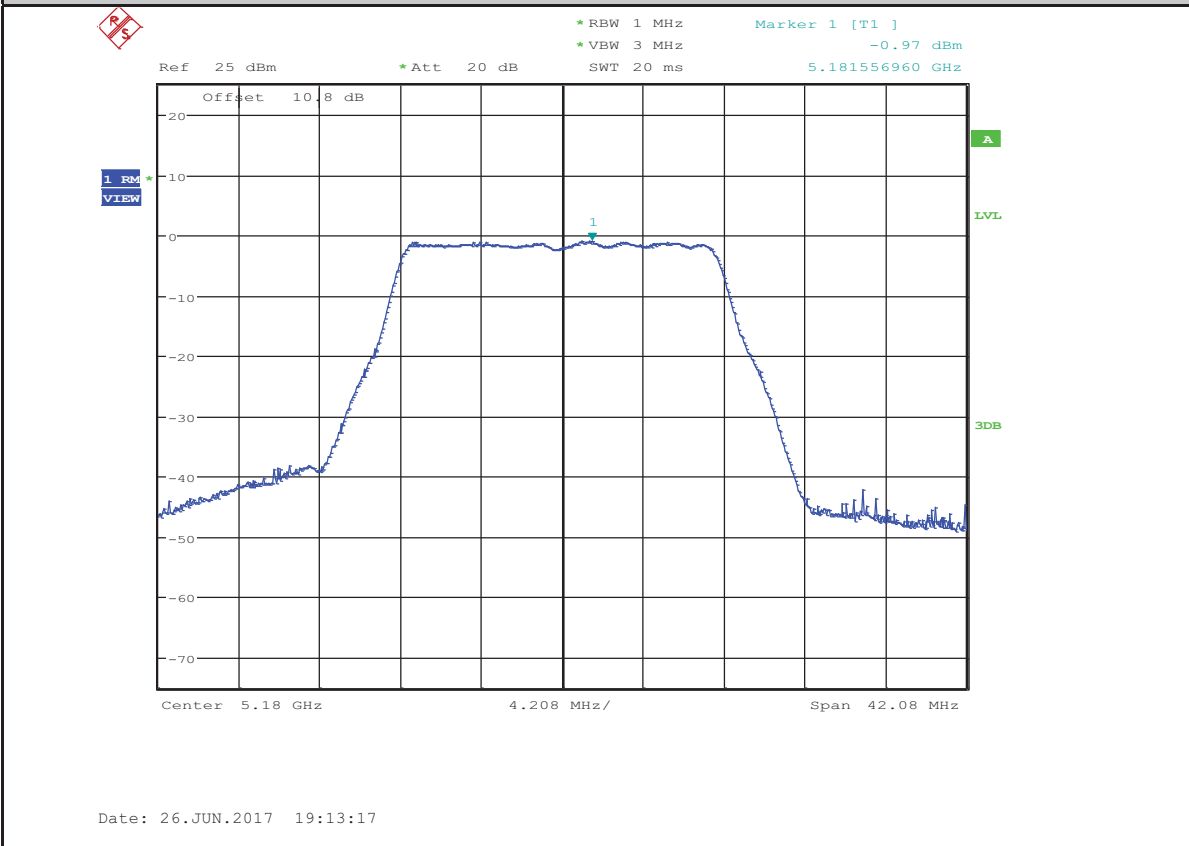

Maximum Power Spectral Density_TNVN_11AMIMO_5180_Ant2

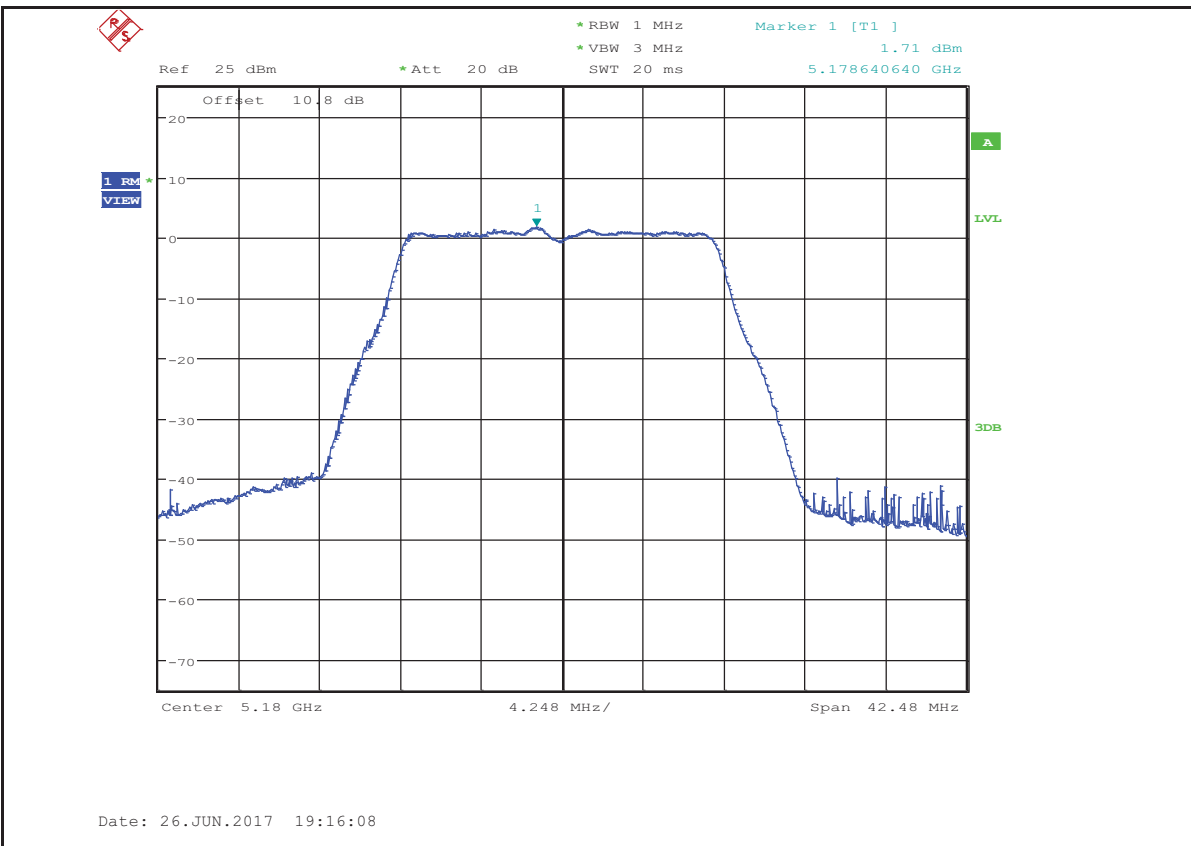

Maximum Power Spectral Density_TNVN_11AMIMO_5180_Ant1+Ant2

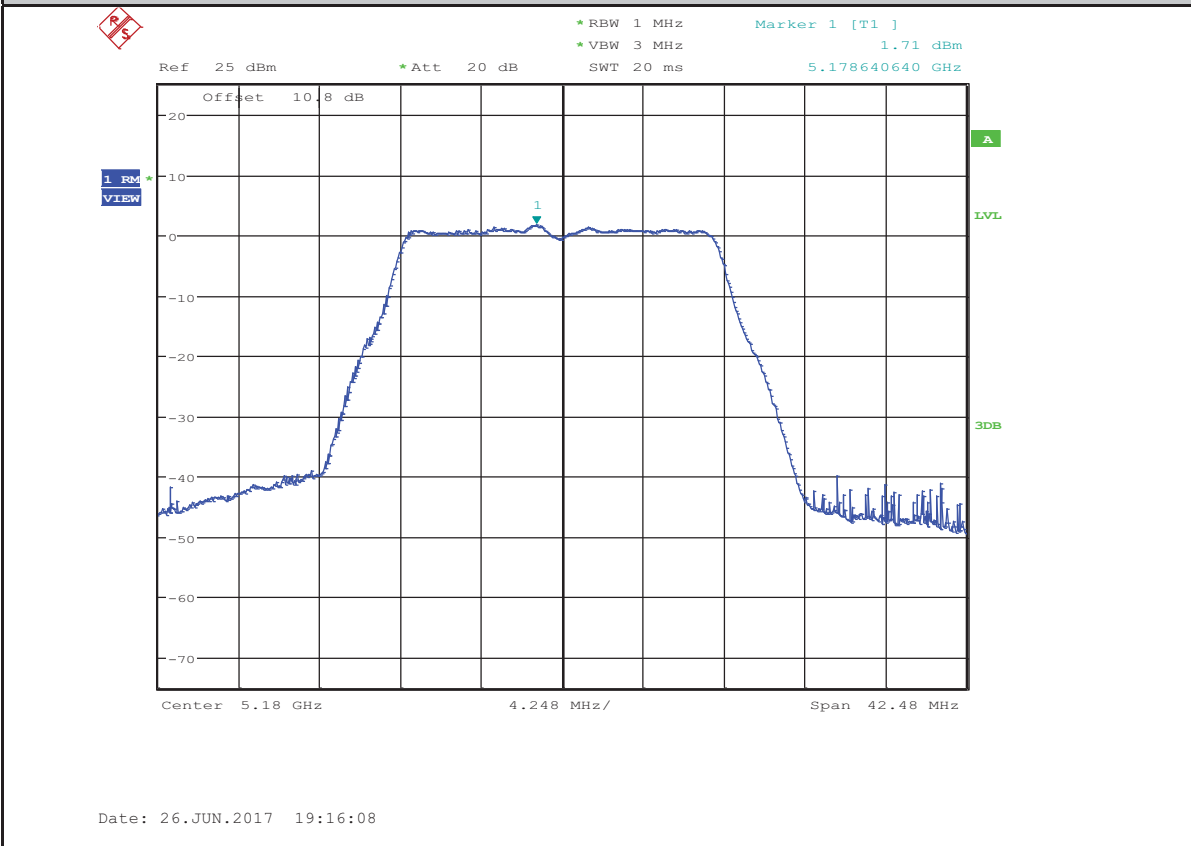

Maximum Power Spectral Density_TNVN_11AMIMO_5200_Ant1

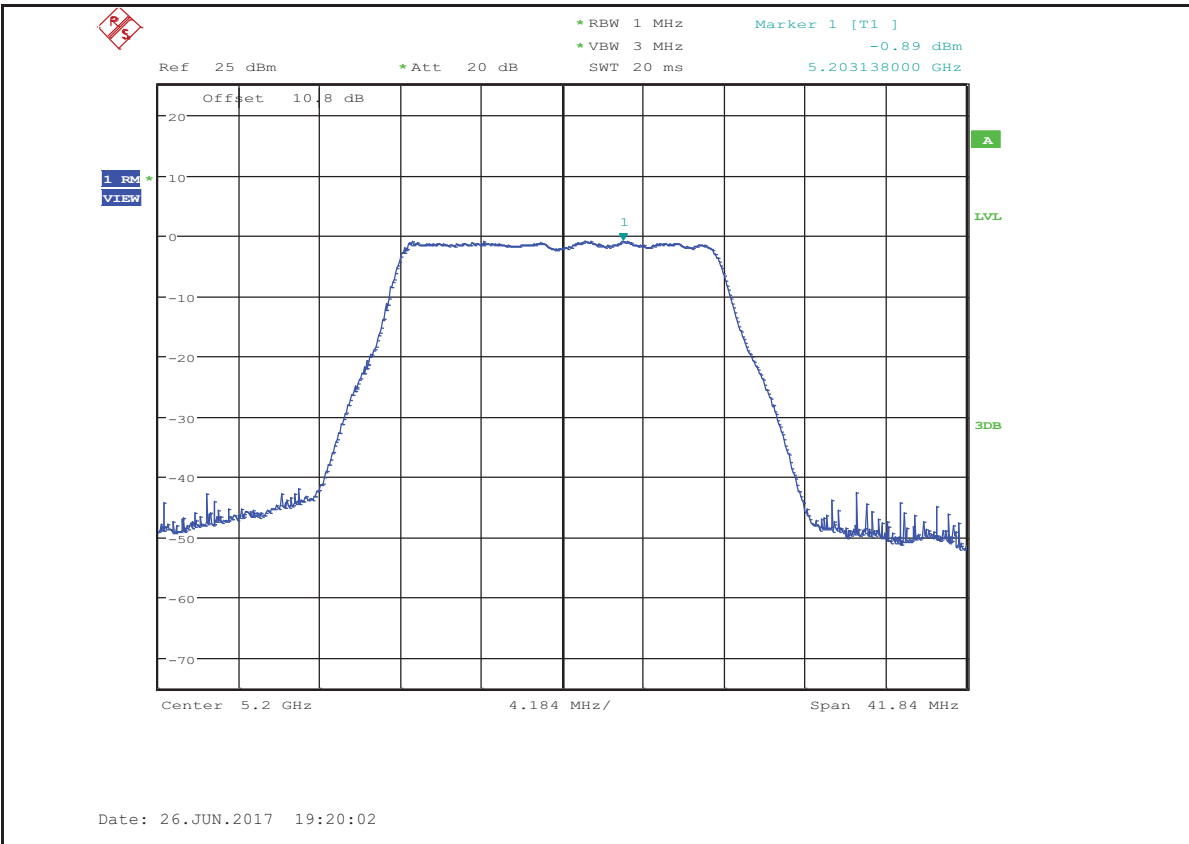

Maximum Power Spectral Density_TNVN_11AMIMO_5200_Ant2

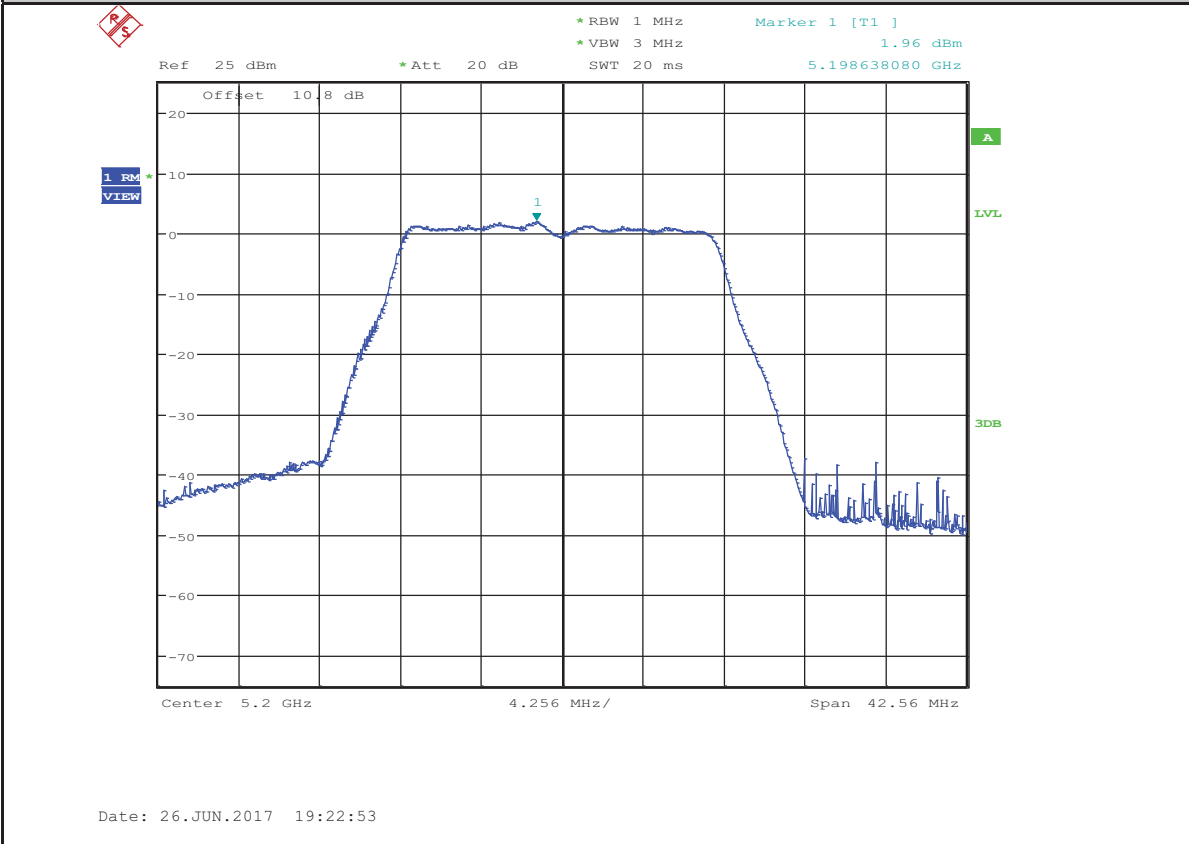

Maximum Power Spectral Density_TNVN_11AMIMO_5200_Ant1+Ant2

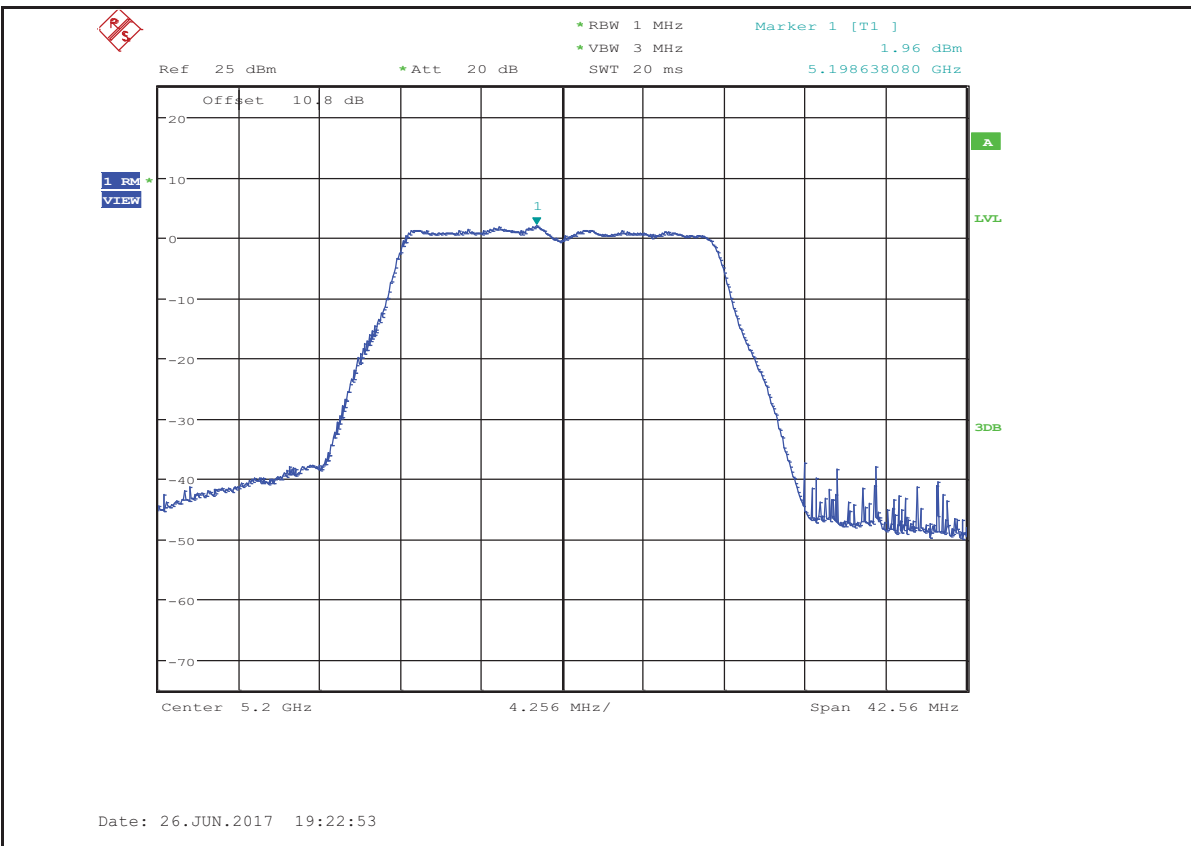

Maximum Power Spectral Density_TNVN_11AMIMO_5240_Ant1

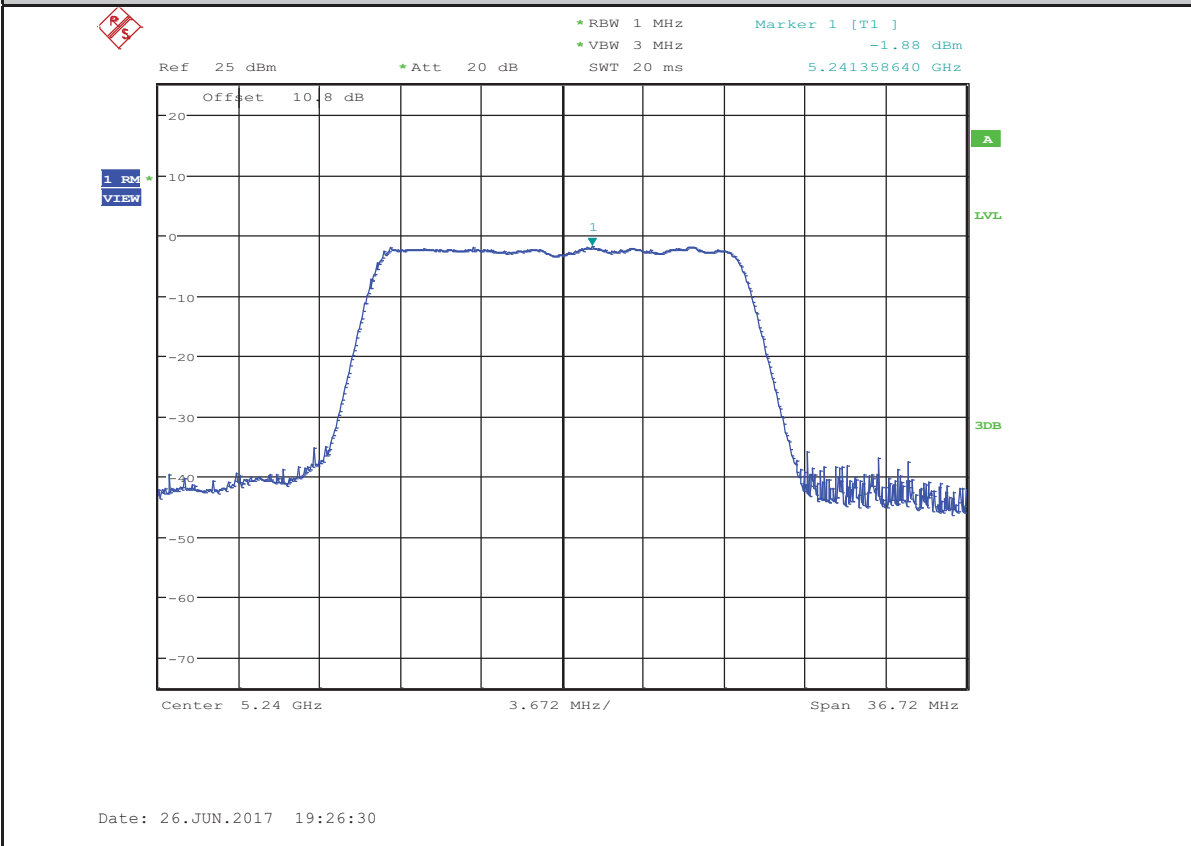

Maximum Power Spectral Density_TNVN_11AMIMO_5240_Ant2

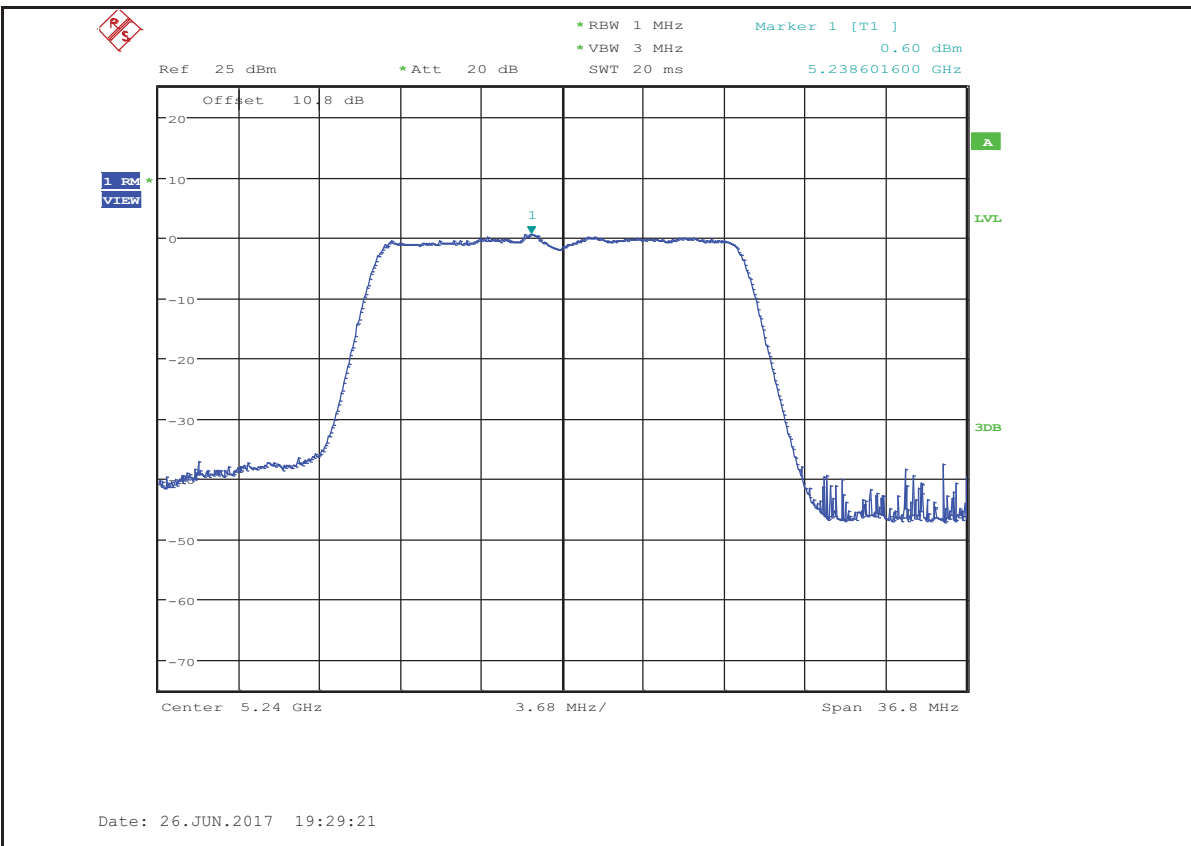

Maximum Power Spectral Density_TNVN_11AMIMO_5240_Ant1+Ant2

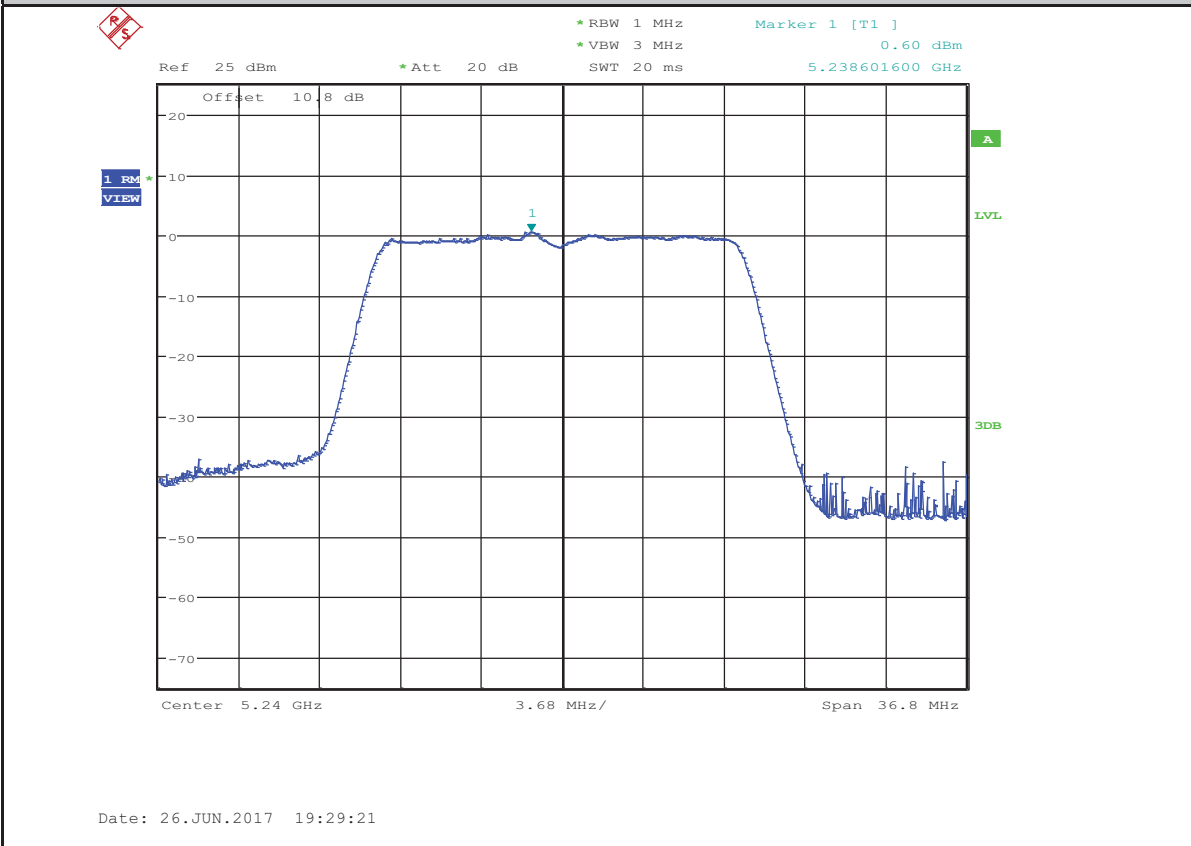

Maximum Power Spectral Density_TNVN_11AMIMO_5260_Ant1

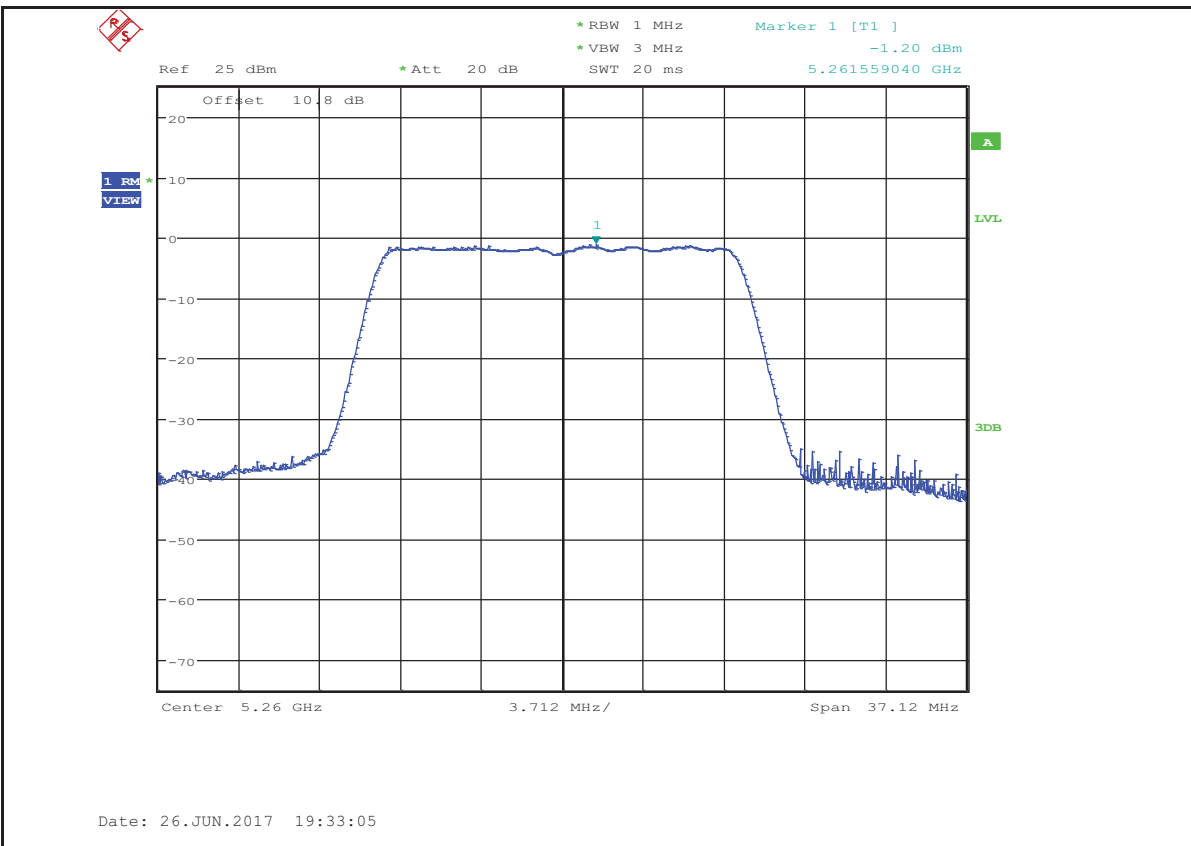

Maximum Power Spectral Density_TNVN_11AMIMO_5260_Ant2

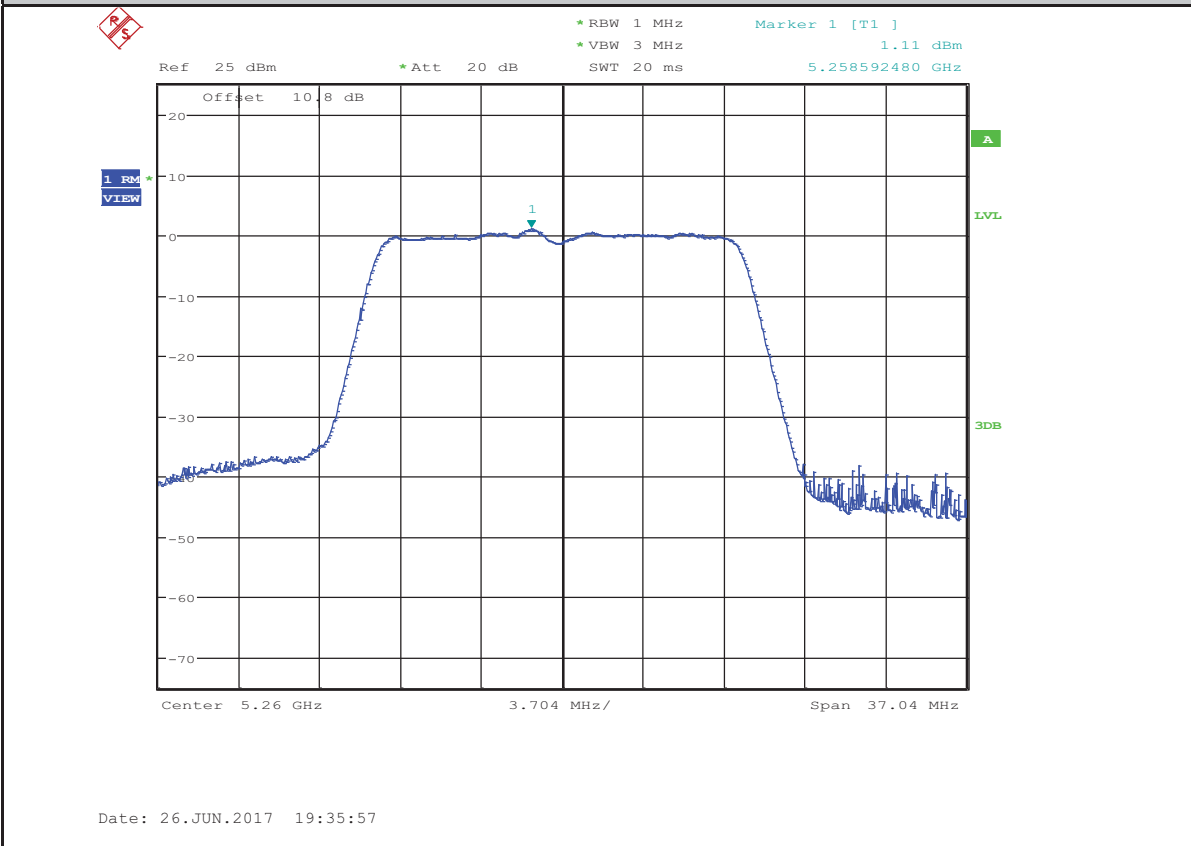

Maximum Power Spectral Density_TNVN_11AMIMO_5260_Ant1+Ant2

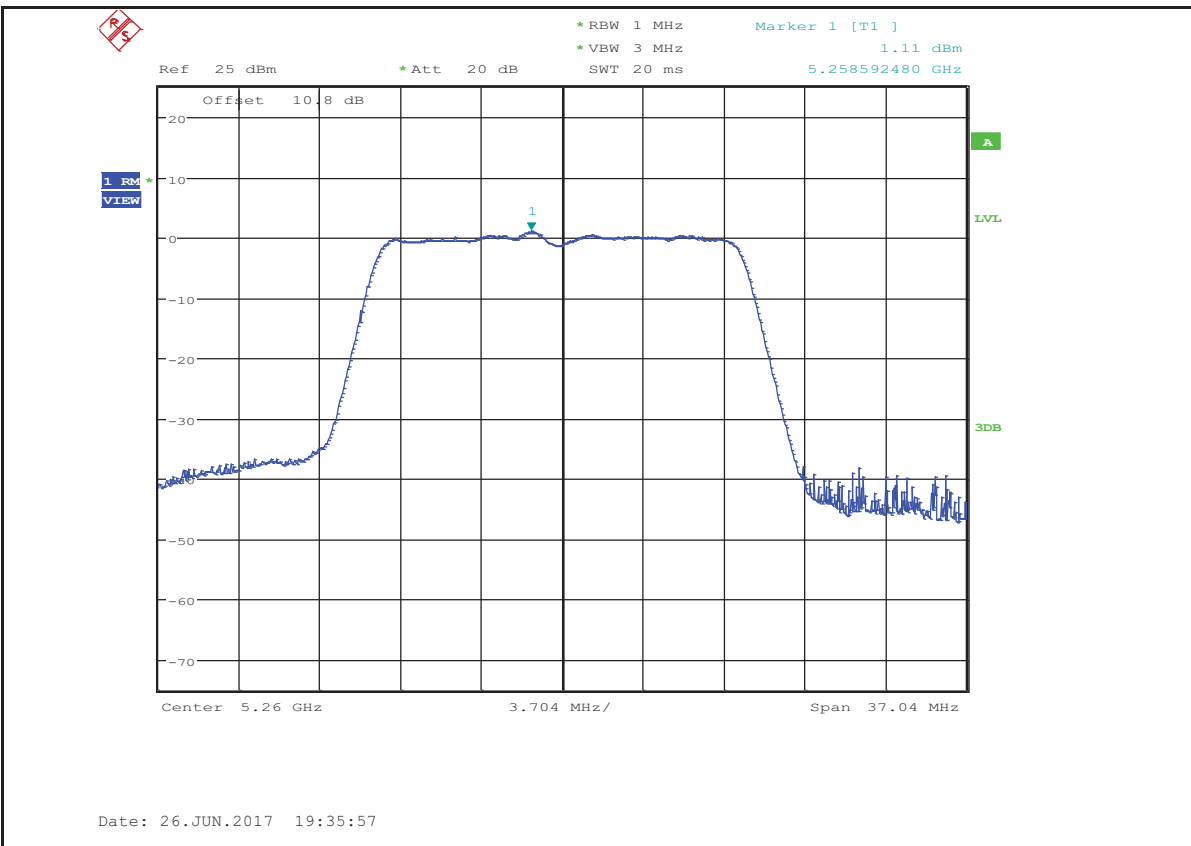

Maximum Power Spectral Density_TNVN_11AMIMO_5280_Ant1

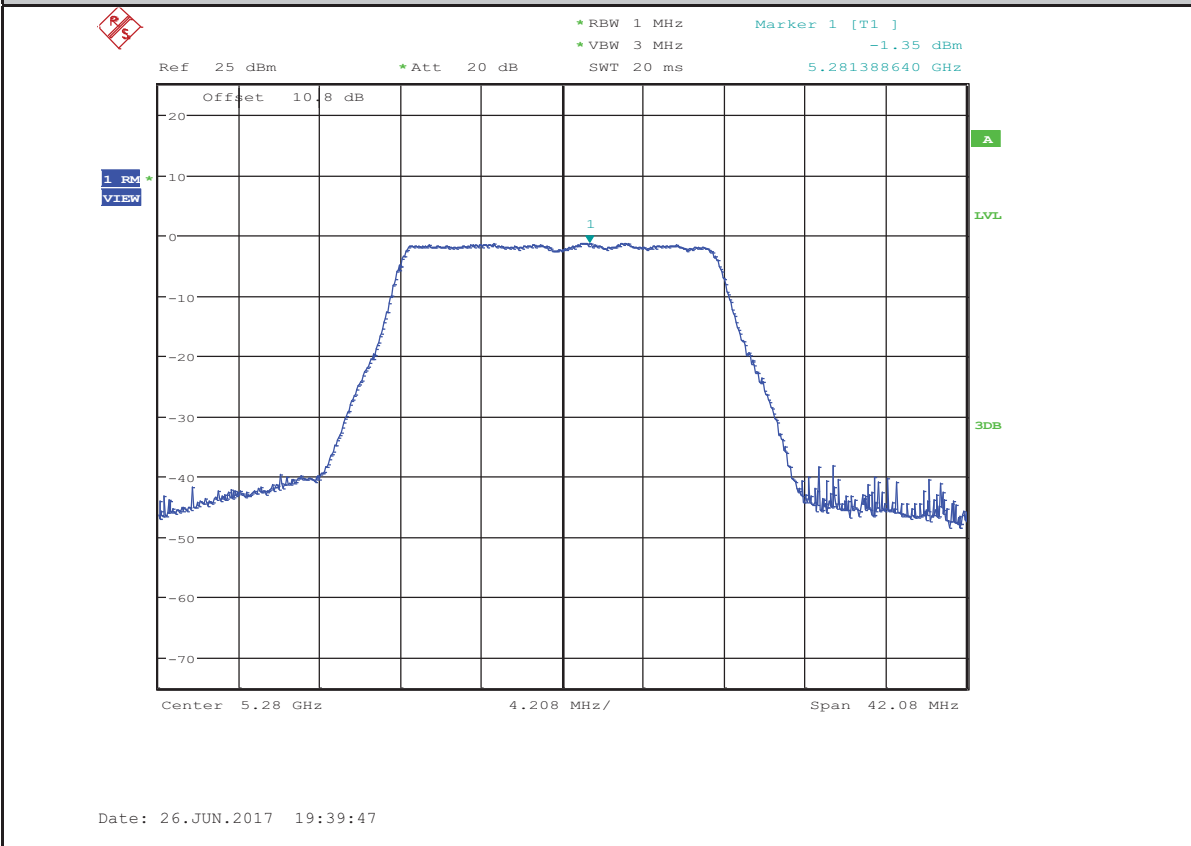

Maximum Power Spectral Density_TNVN_11AMIMO_5280_Ant2

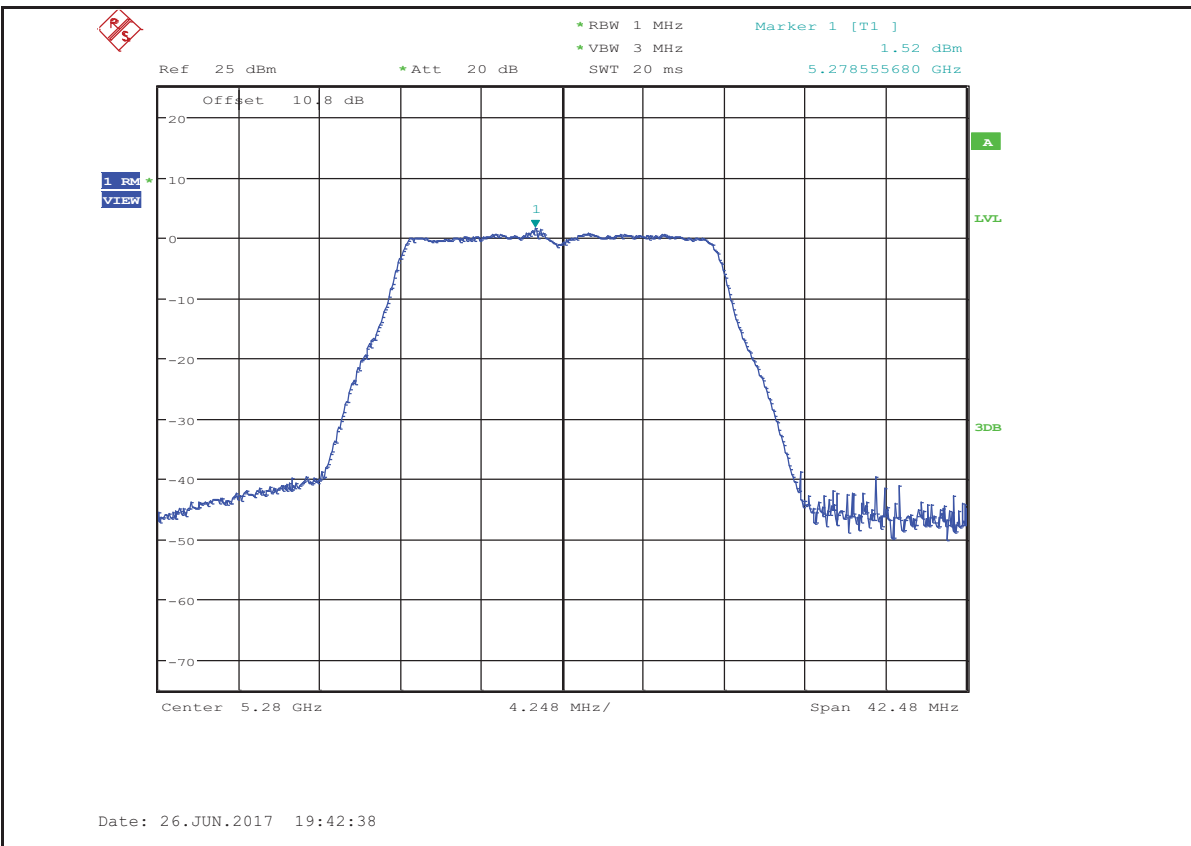

Maximum Power Spectral Density_TNVN_11AMIMO_5280_Ant1+Ant2

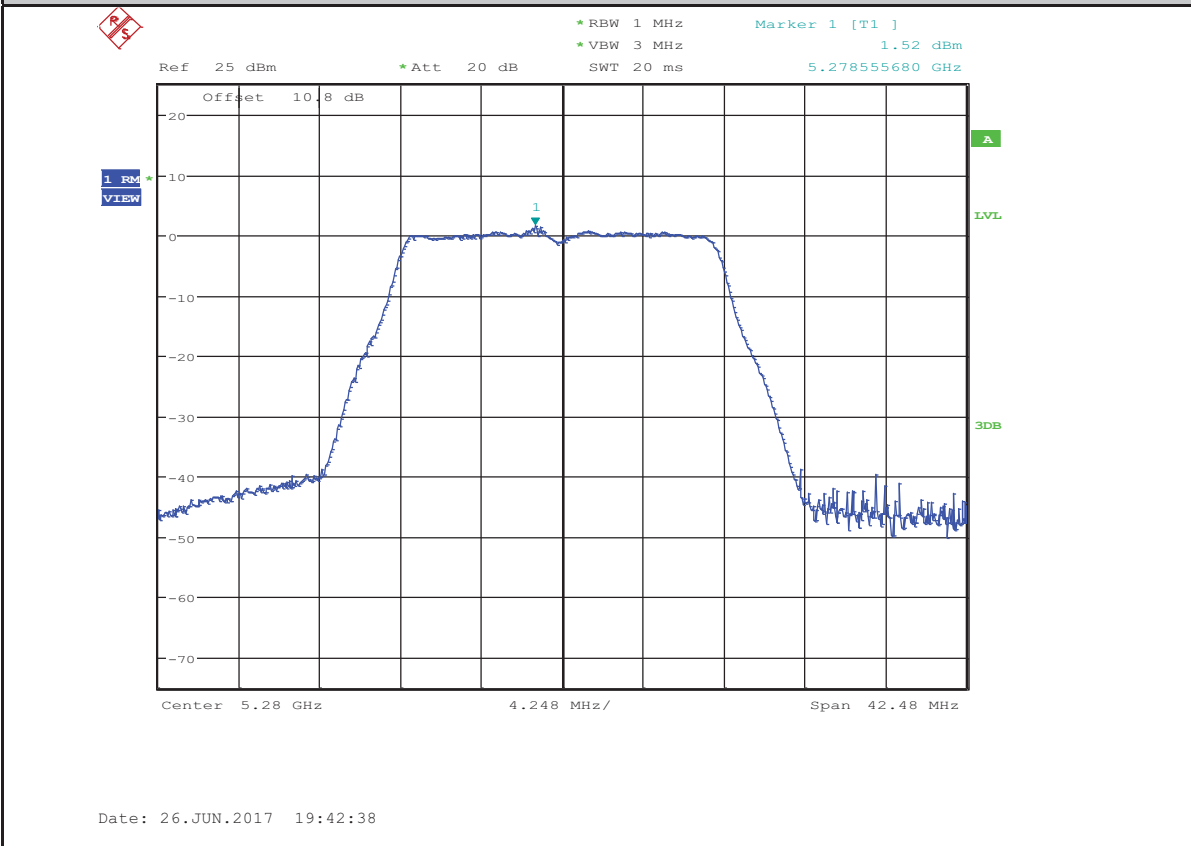

Maximum Power Spectral Density_TNVN_11AMIMO_5320_Ant1

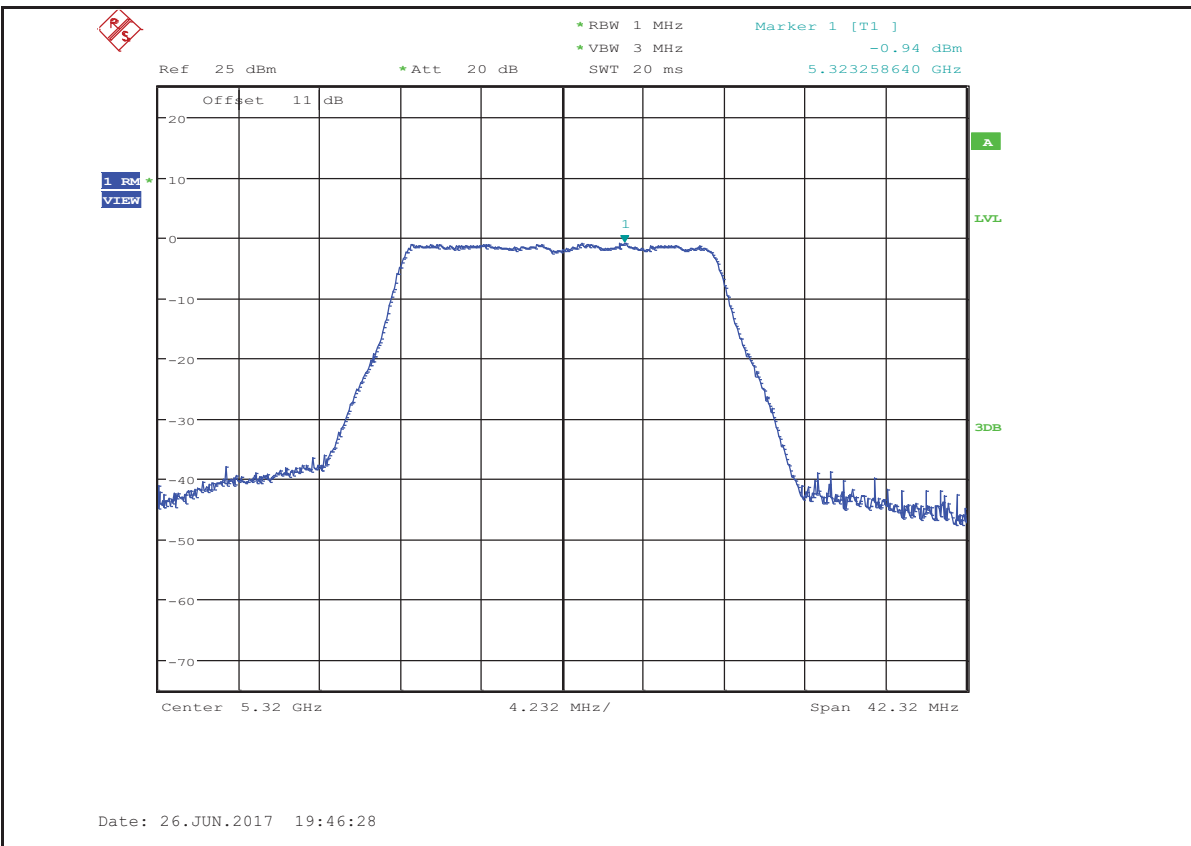

Maximum Power Spectral Density_TNVN_11AMIMO_5320_Ant2

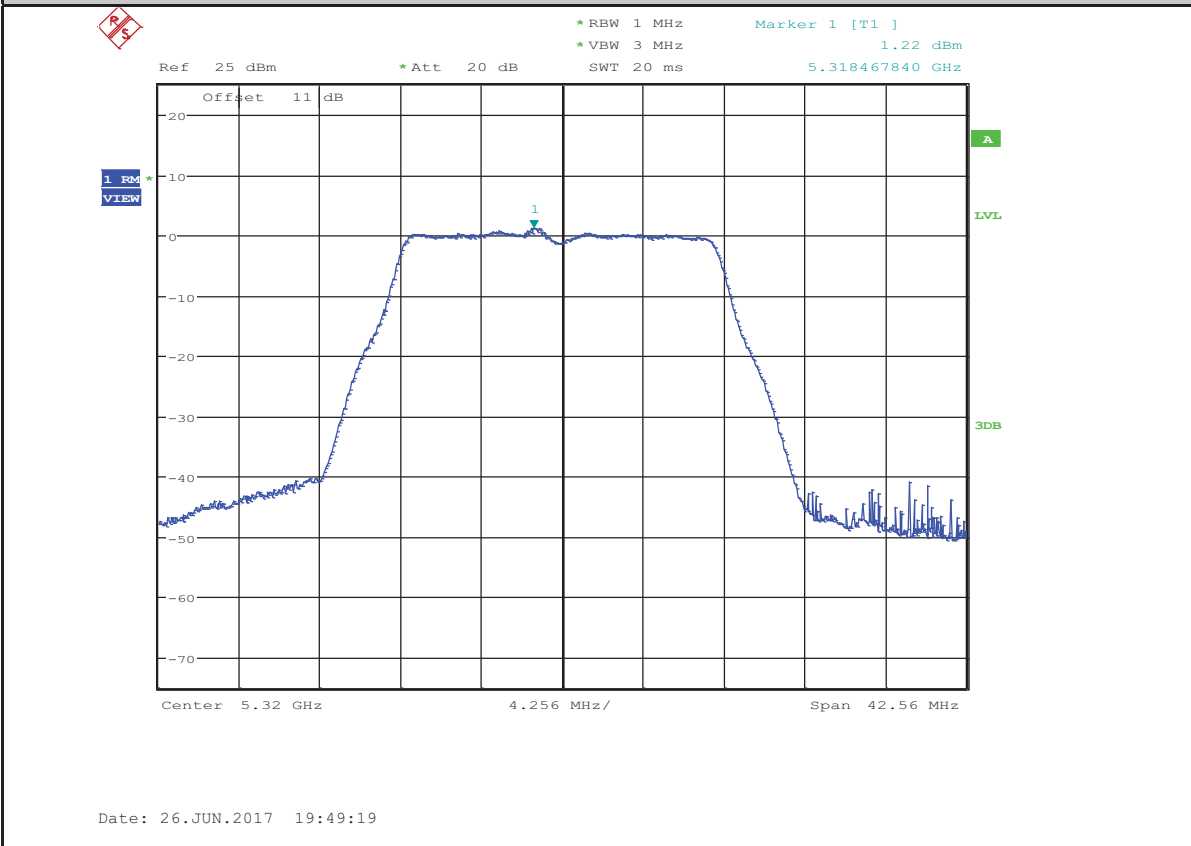

Maximum Power Spectral Density_TNVN_11AMIMO_5320_Ant1+Ant2

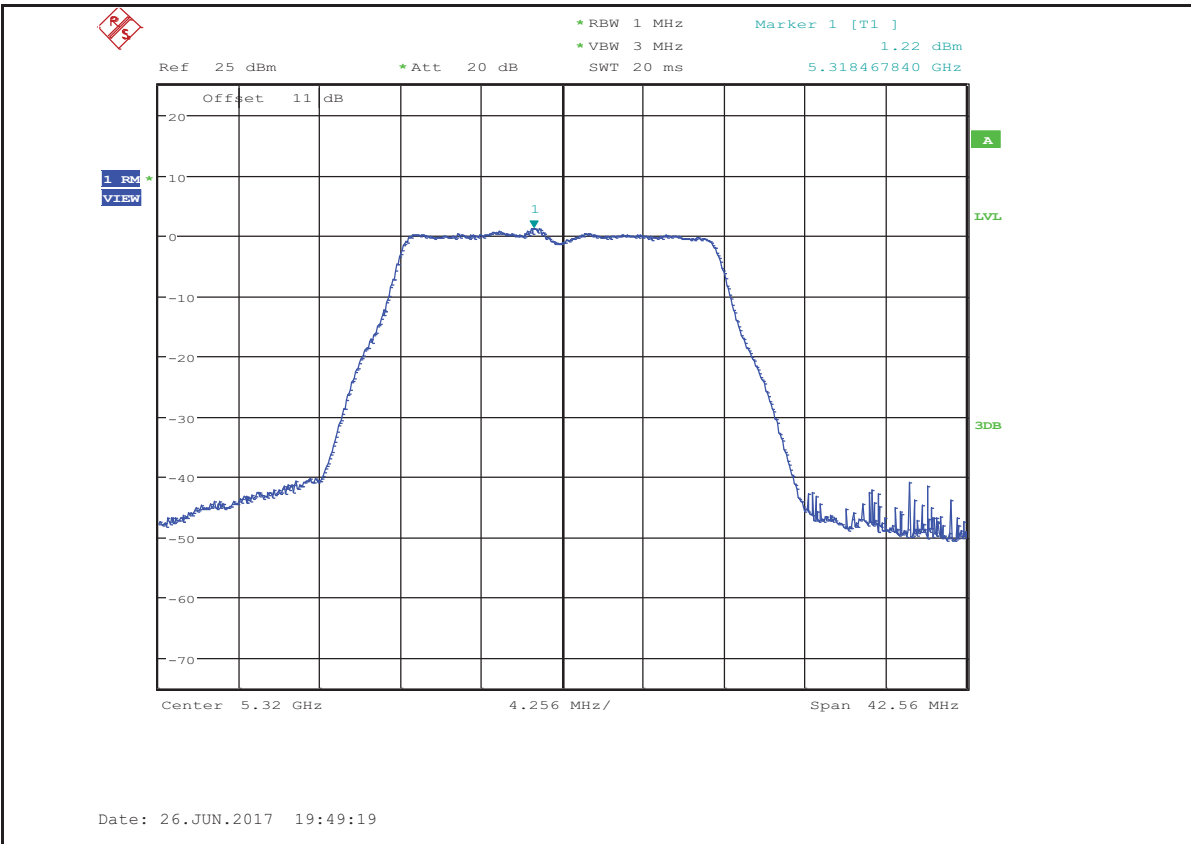

Maximum Power Spectral Density_TNVN_11AMIMO_5500_Ant1

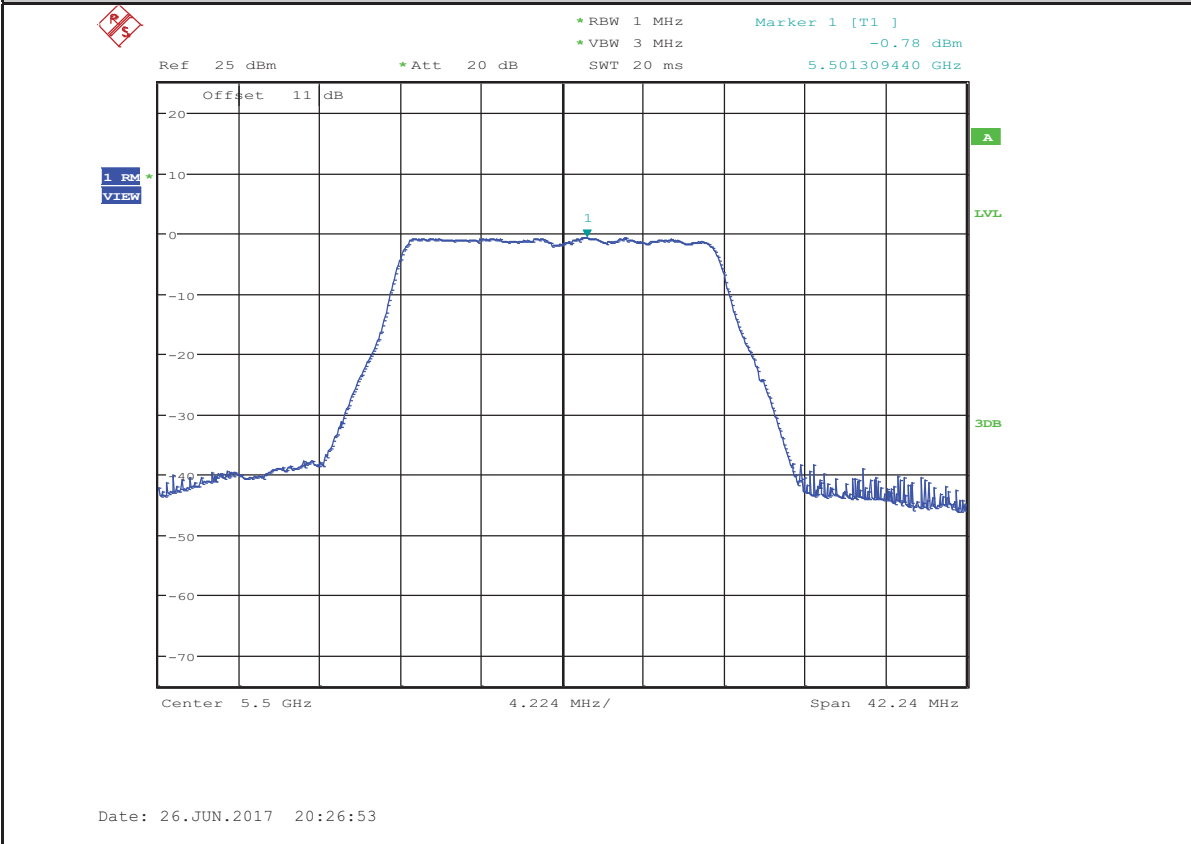

Maximum Power Spectral Density_TNVN_11AMIMO_5500_Ant2

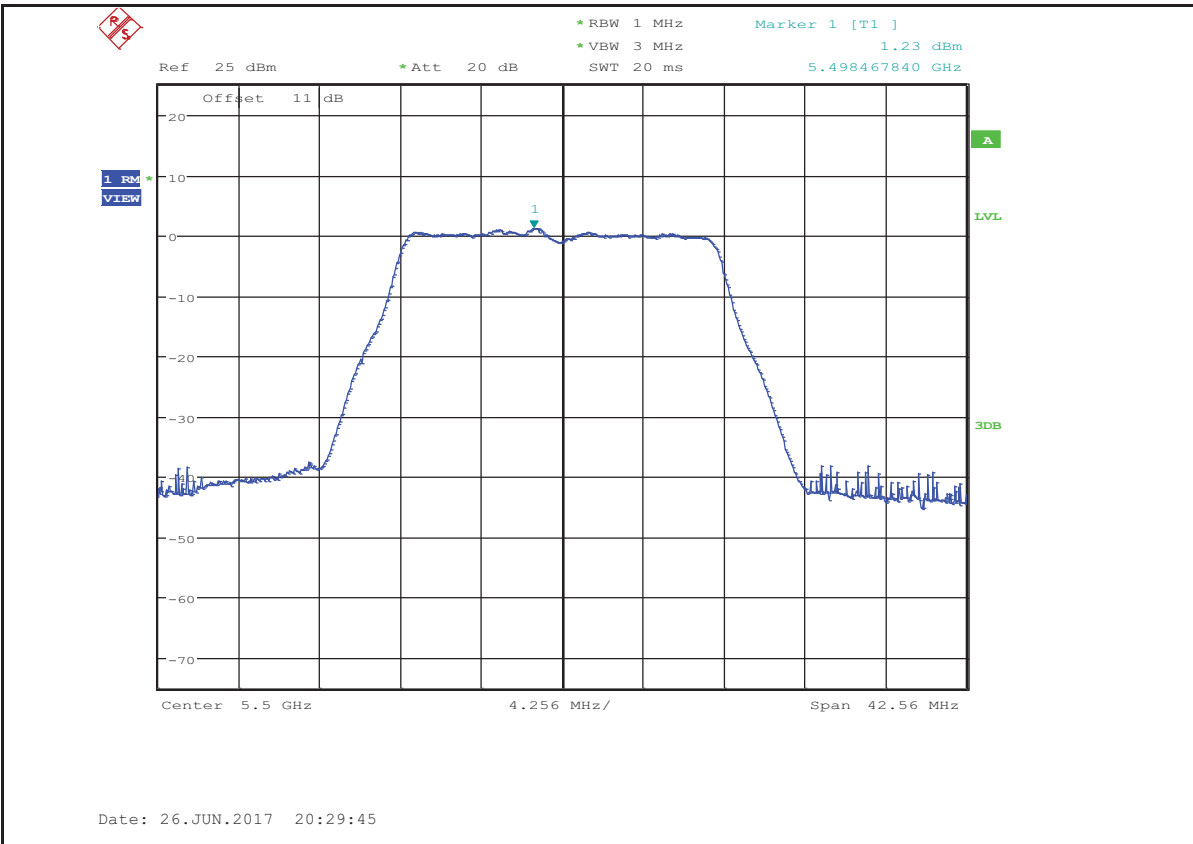

Maximum Power Spectral Density_TNVN_11AMIMO_5500_Ant1+Ant2

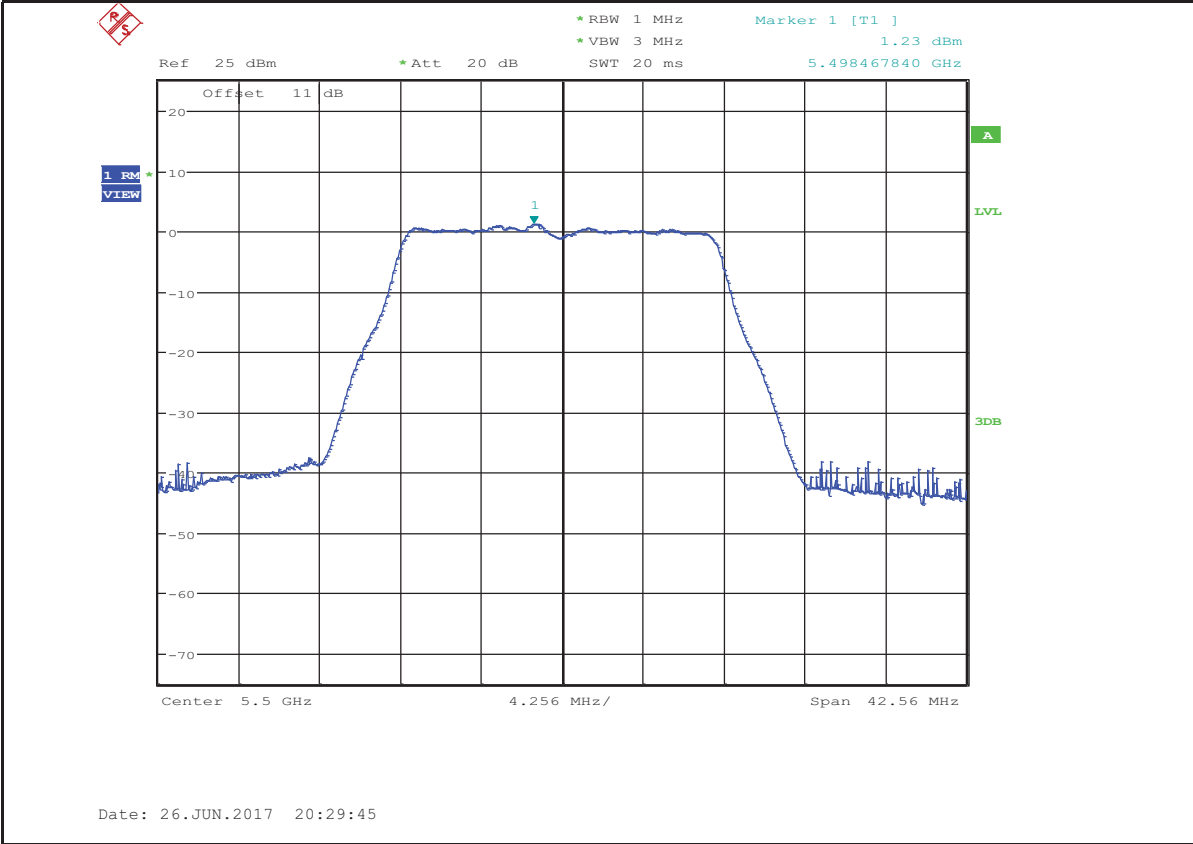

Maximum Power Spectral Density_TNVN_11AMIMO_5580_Ant1

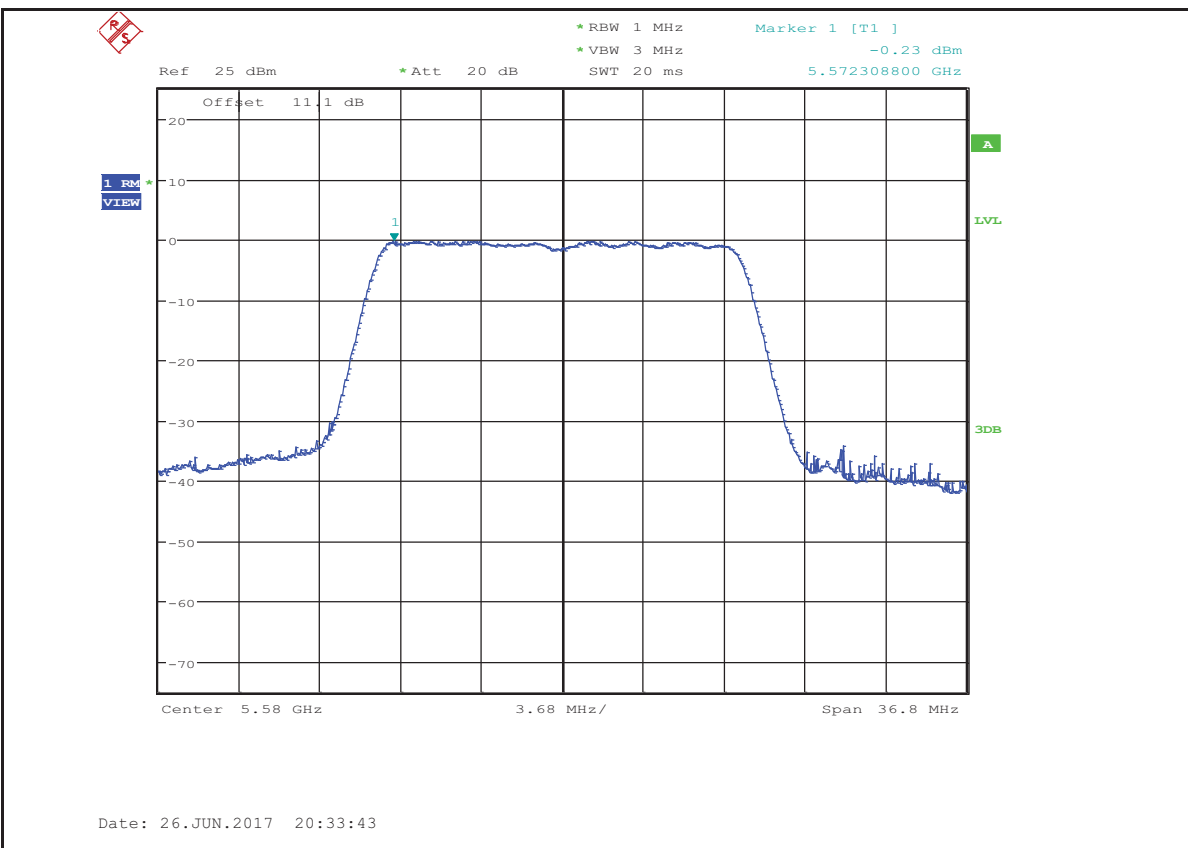

Maximum Power Spectral Density_TNVN_11AMIMO_5580_Ant2

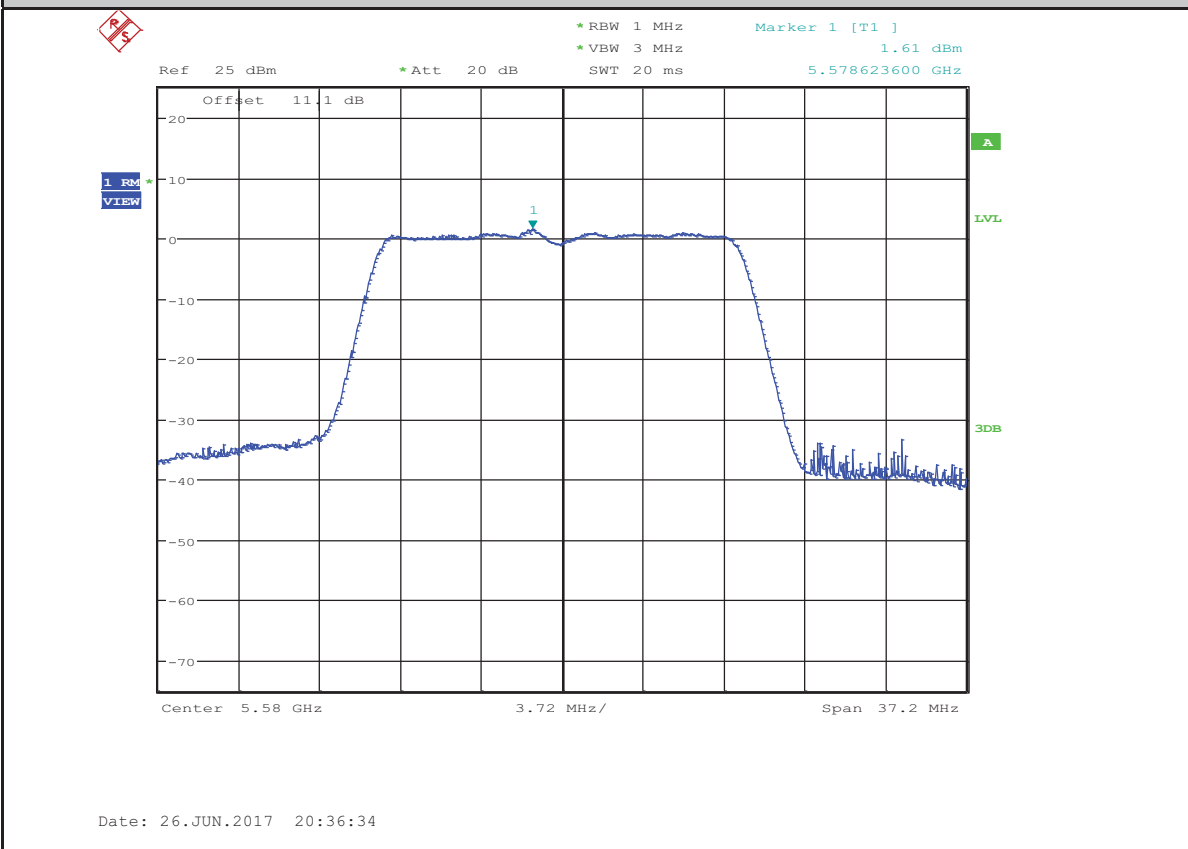

Maximum Power Spectral Density_TNVN_11AMIMO_5580_Ant1+Ant2

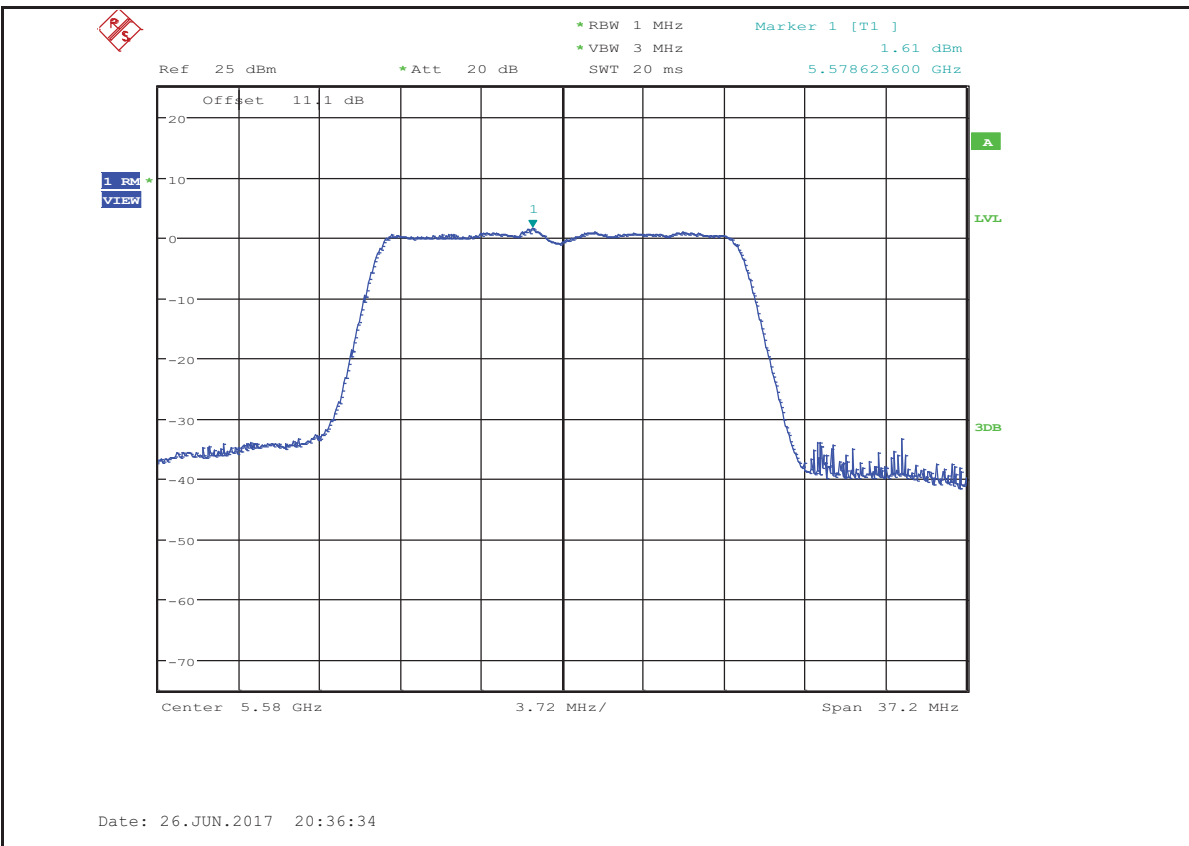

Maximum Power Spectral Density_TNVN_11AMIMO_5700_Ant1

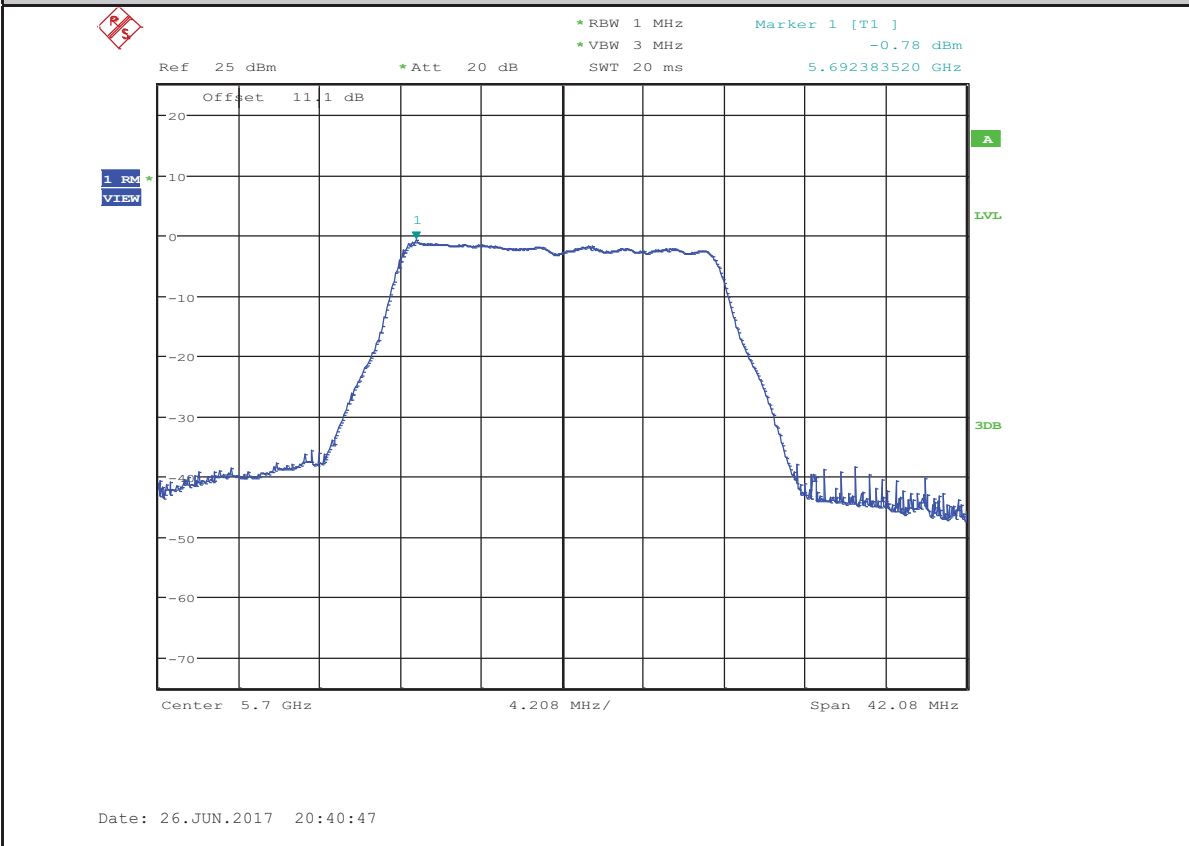

Maximum Power Spectral Density_TNVN_11AMIMO_5700_Ant2

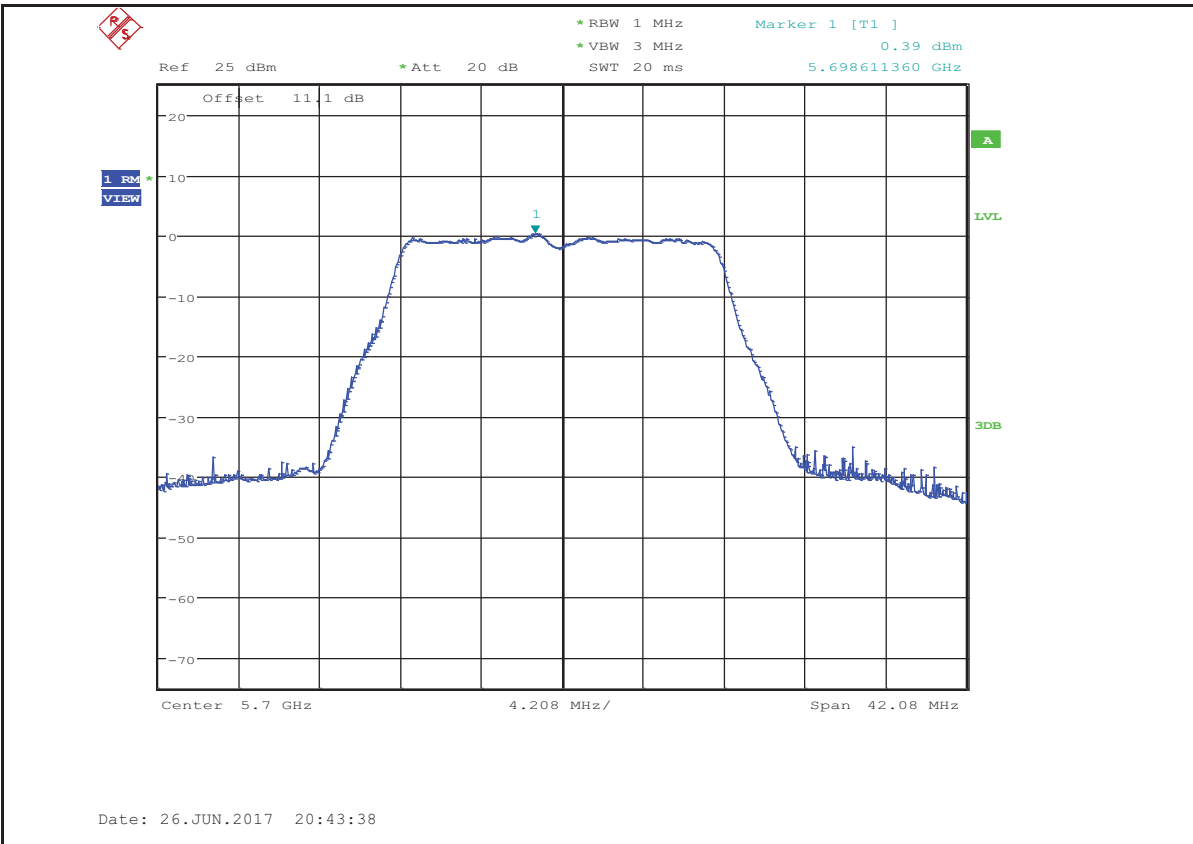

Maximum Power Spectral Density_TNVN_11AMIMO_5700_Ant1+Ant2

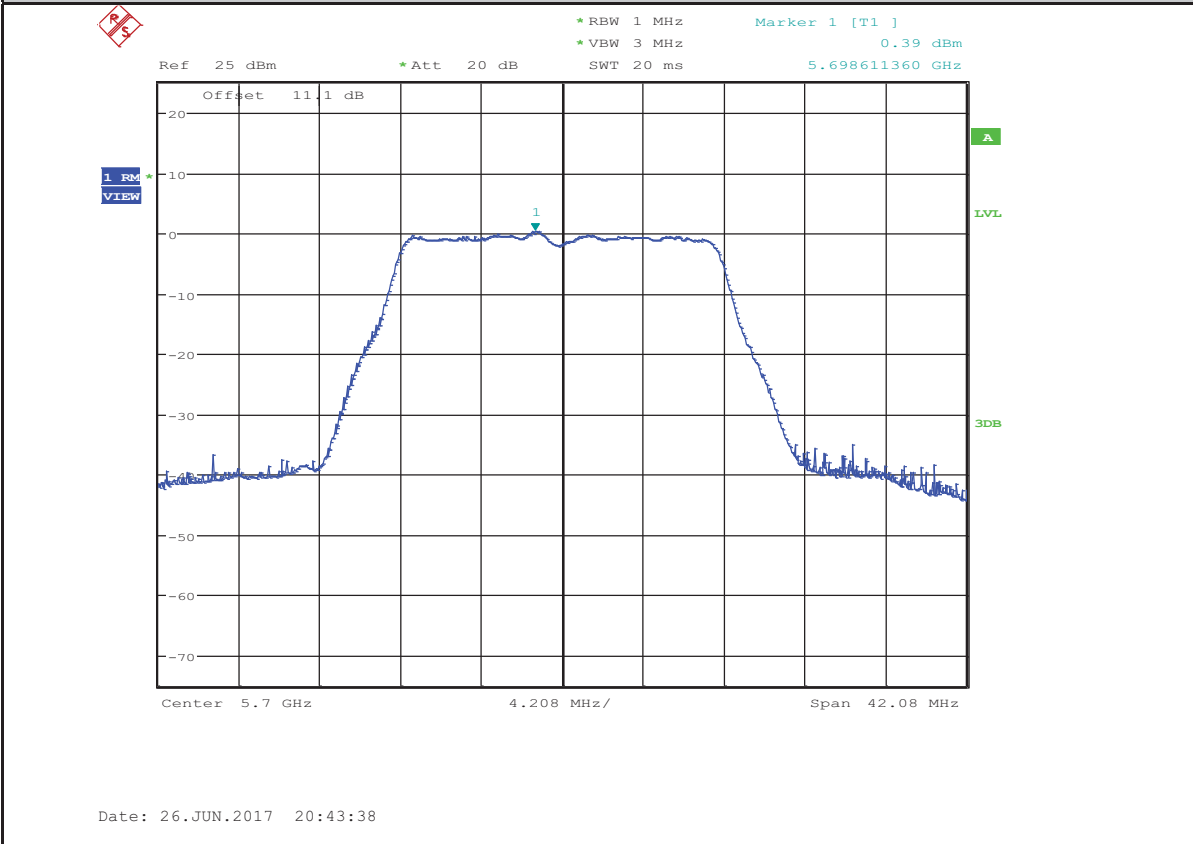

Maximum Power Spectral Density_TNVN_11AMIMO_5745_Ant1

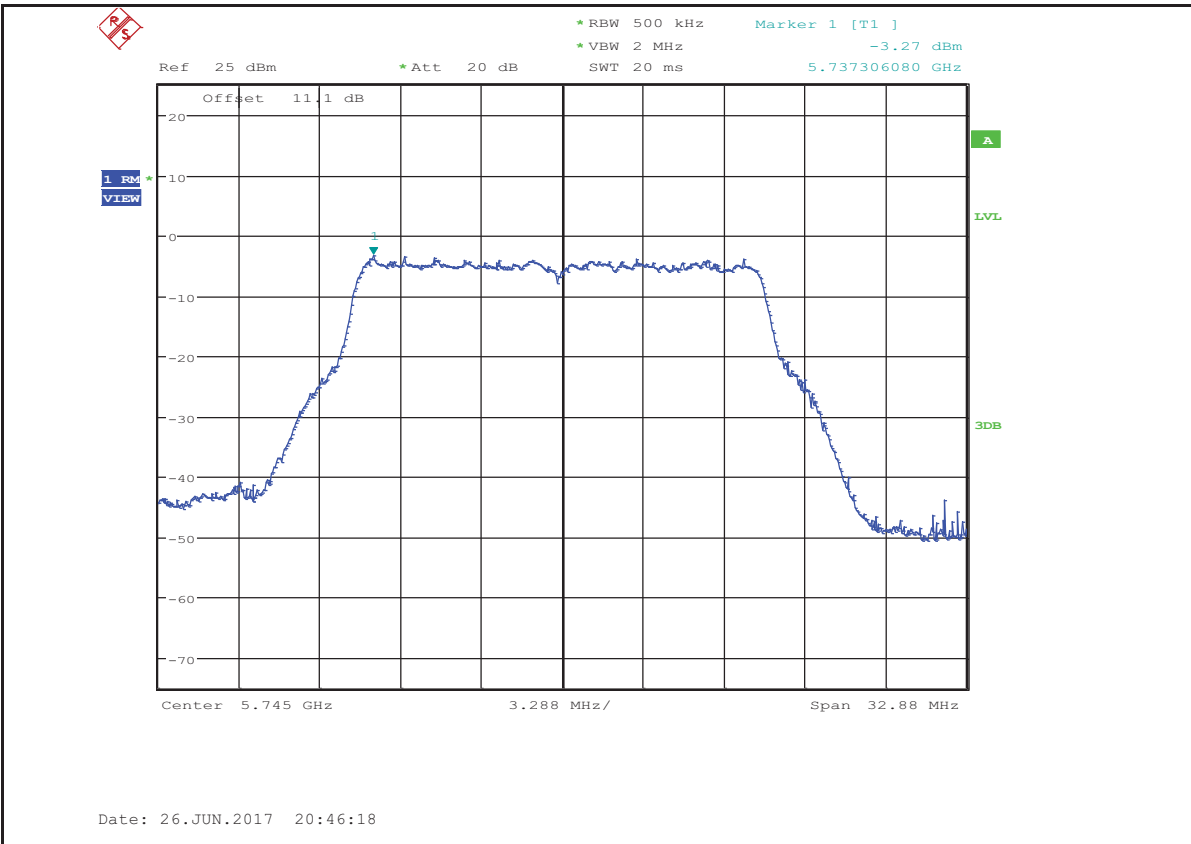

Maximum Power Spectral Density_TNVN_11AMIMO_5745_Ant2

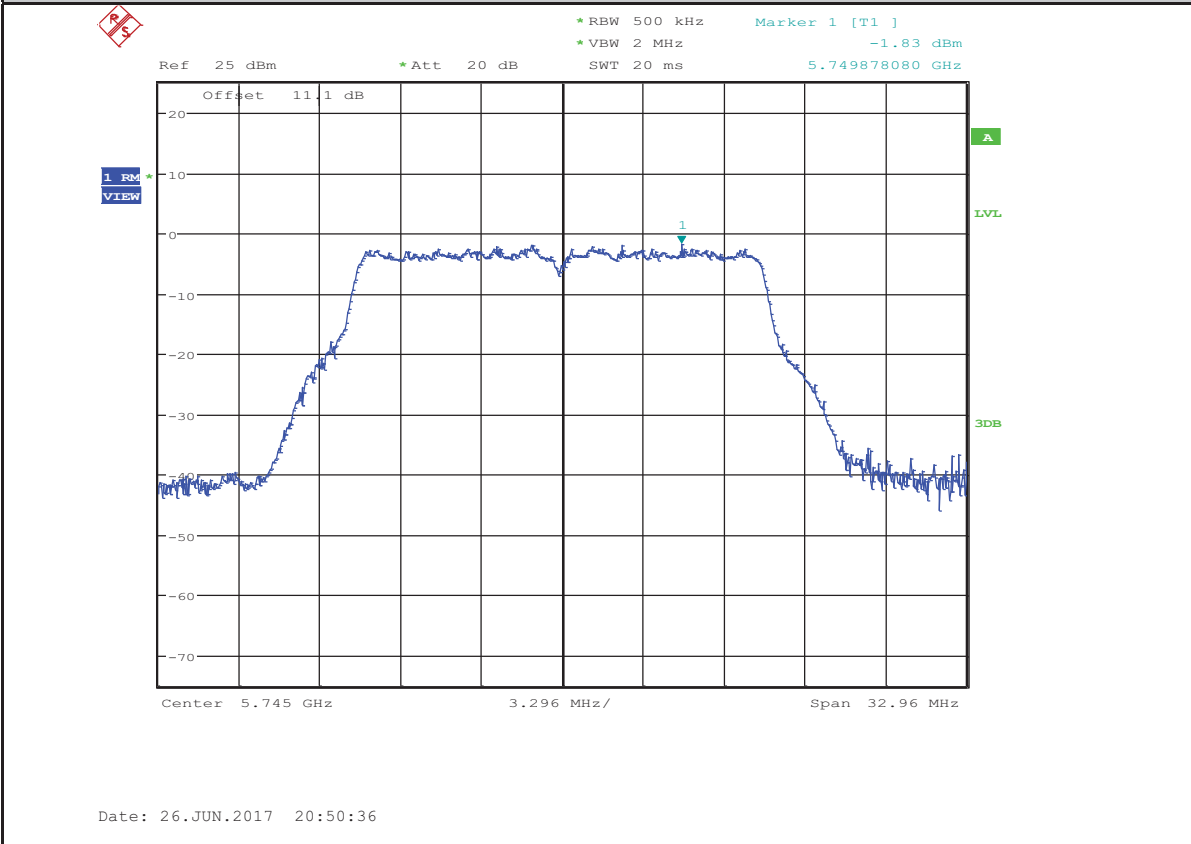

Maximum Power Spectral Density_TNVN_11AMIMO_5745_Ant1+Ant2

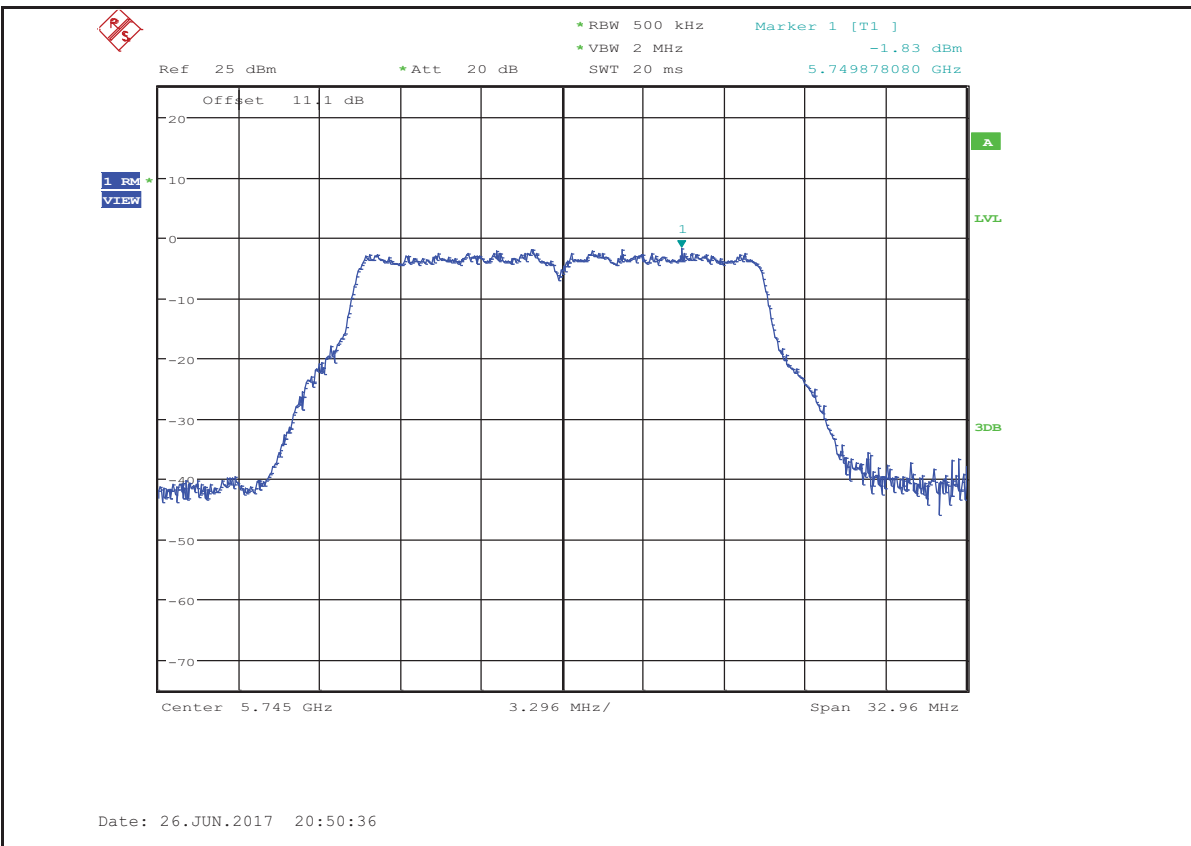

Maximum Power Spectral Density_TNVN_11AMIMO_5785_Ant1

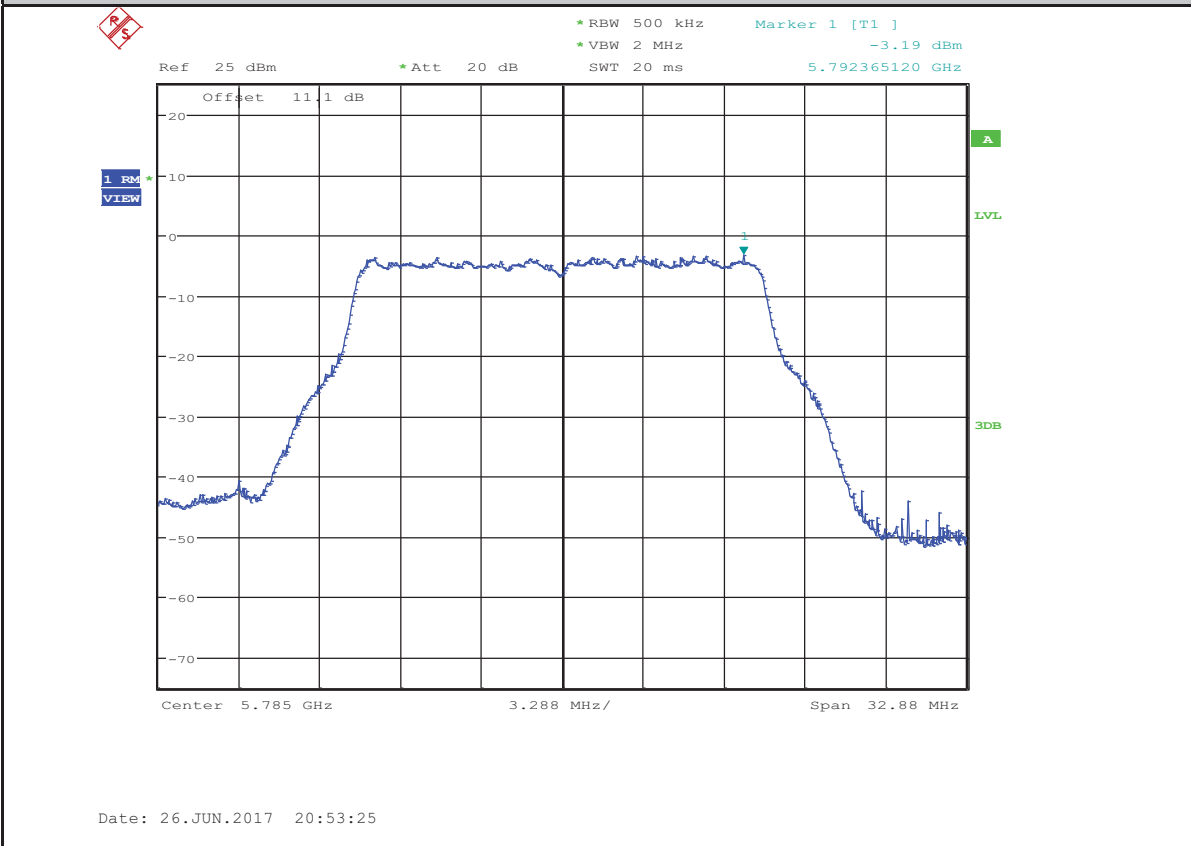

Maximum Power Spectral Density_TNVN_11AMIMO_5785_Ant2

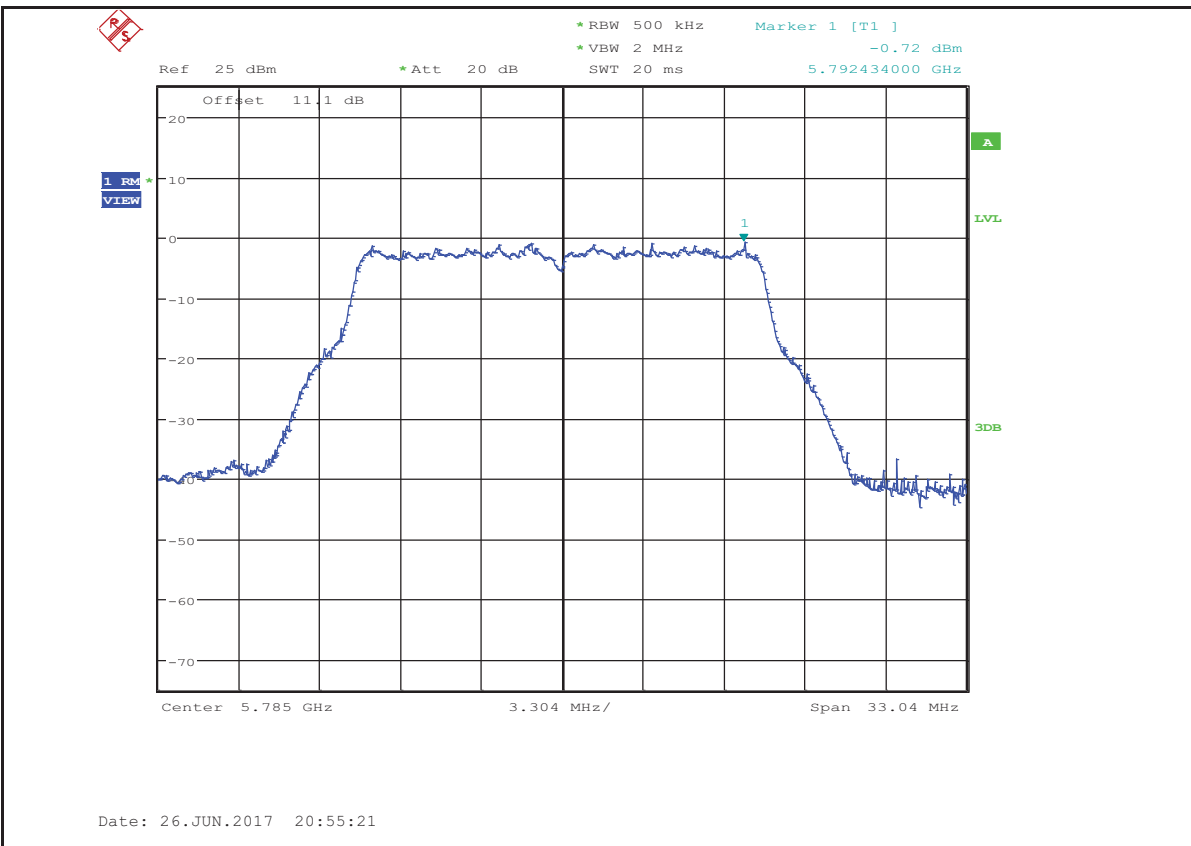

Maximum Power Spectral Density_TNVN_11AMIMO_5785_Ant1+Ant2



Maximum Power Spectral Density_TNVN_11AMIMO_5825_Ant1

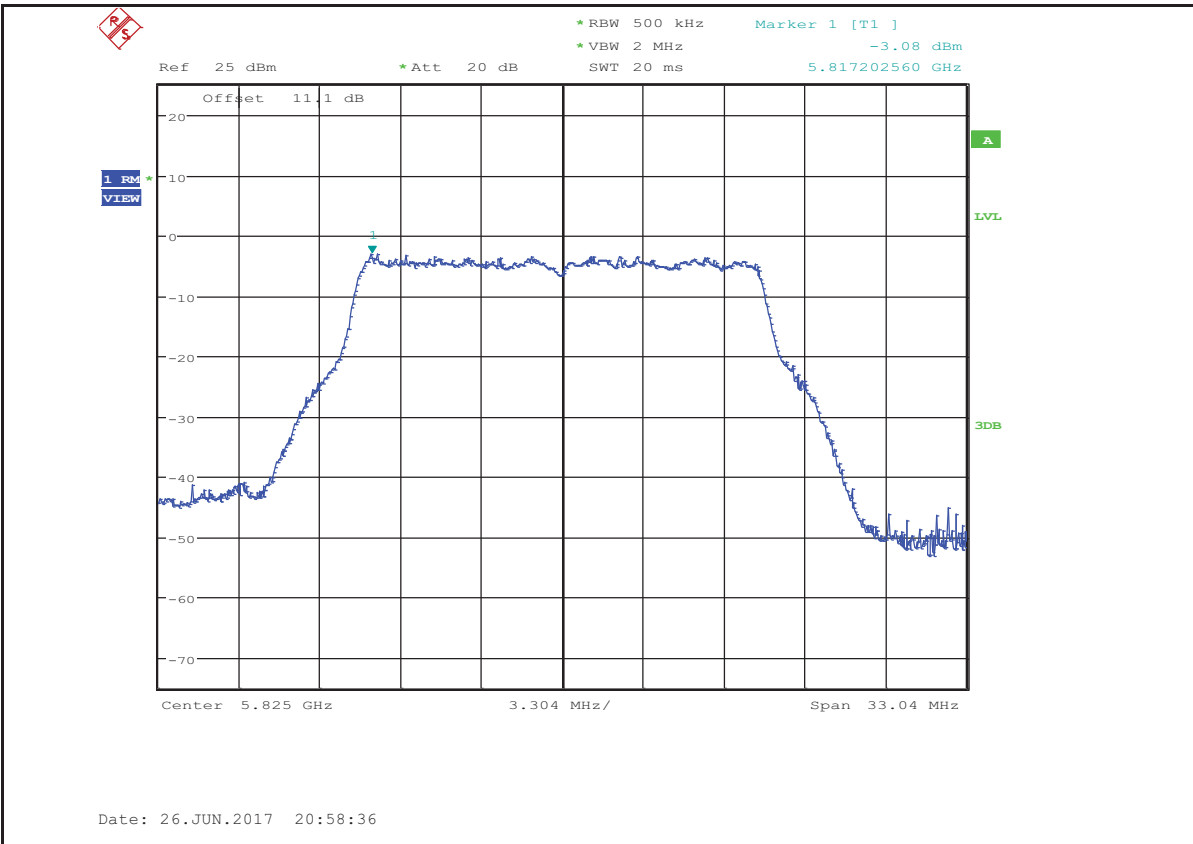

Maximum Power Spectral Density_TNVN_11AMIMO_5825_Ant2

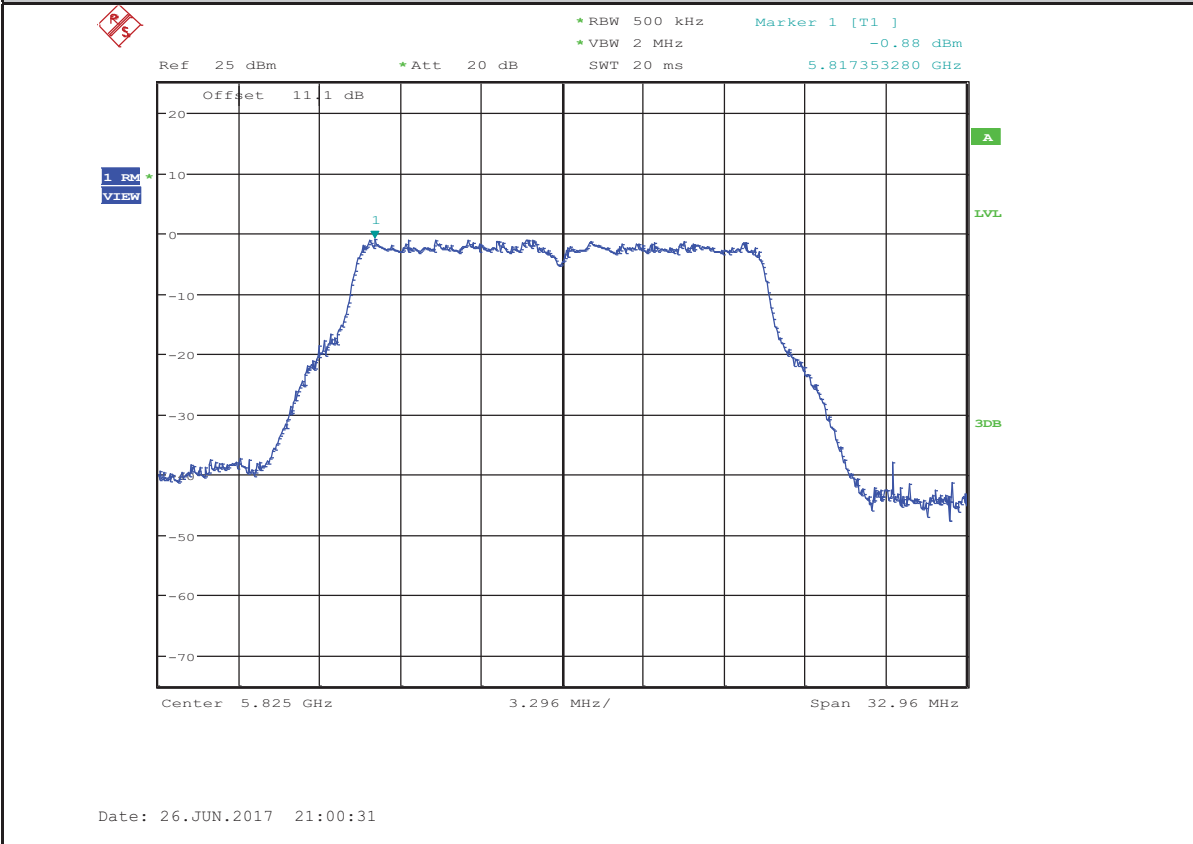

Maximum Power Spectral Density_TNVN_11AMIMO_5825_Ant1+Ant2

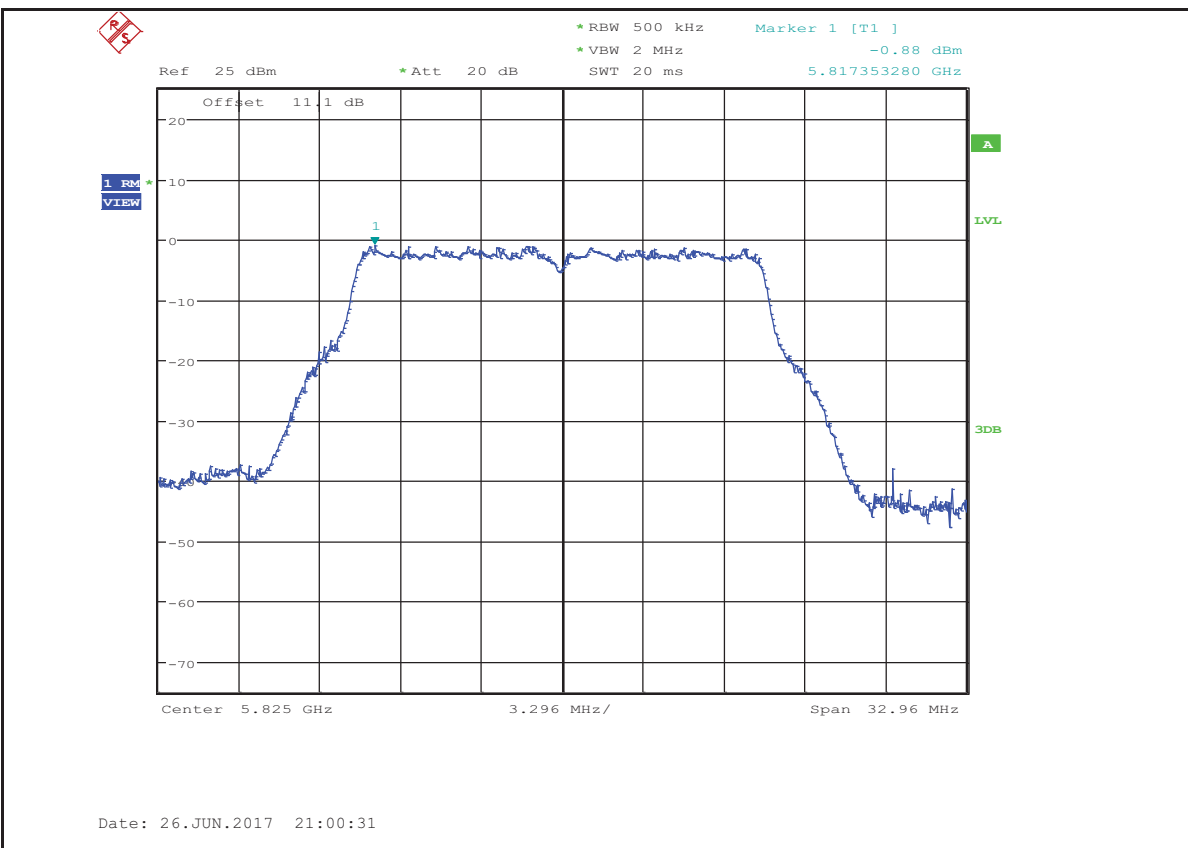

8. Frequency Stability Measurement

8.1. Limit of Frequency Stability

Manufacturers of U-NII devices are responsible for ensuring frequency stability such that an emission is maintained within the band of operation under all conditions of normal operation as specified in the user's manual.

8.2. Measuring Instruments

The measuring equipment is listed in the section 4 of this test report.

8.3. Test Procedures

- (1) To ensure emission at the band edge is maintained within the authorized band, those values shall be measured by radiation emissions at upper and lower frequency points, and finally compensated by frequency deviation as procedures below.
- (2) The EUT was operated at the maximum output power, and connected to the spectrum analyzer, which is set to maximum hold function and peak detector. The peak value of the power envelope was measured and noted. The upper and lower frequency points were respectively measured relatively 10dB lower than the measured peak value.
- (3) The frequency deviation was calculated by adding the upper frequency point and the lower frequency point divided by two. Those detailed values of frequency deviation are provided in table below.

8.4. Test Setup

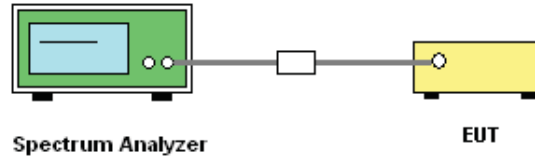

8.5. Test Result of Frequency Stability

Temperature vs. Frequency Stability								
Test Mode	Test Channel	Ant	Volt.	Temp.	Deviation [MHz]	Deviation [ppm]	Limit [ppm]	Verdict
11A	5180	Ant1+Ant2	VN	50	5179.95	-11.65844	20	PASS
11A	5180	Ant1+Ant2	VN	-30	5179.92	-14.45756	20	PASS
11A	5180	Ant1+Ant2	VN	40	5179.95	-8.2578	20	PASS
11A	5180	Ant1+Ant2	VN	30	5179.96	-11.58158	20	PASS
11A	5180	Ant1+Ant2	VN	20	5179.93	-14.28574	20	PASS
11A	5180	Ant1+Ant2	VN	10	5179.95	-11.36584	20	PASS
11A	5180	Ant1+Ant2	VN	0	5179.93	-14.45784	20	PASS
11A	5180	Ant1+Ant2	VN	-10	5179.92	-11.58547	20	PASS
11A	5180	Ant1+Ant2	VN	-20	5179.93	-17.45787	20	PASS

Note: All the modes had been tested, but only the worst data were recorded in the report.

9. Emissions in restricted frequency bands

9.1. Block diagram of test setup

In 3m Anechoic Chamber Test Setup Diagram for 9KHz-30MHz

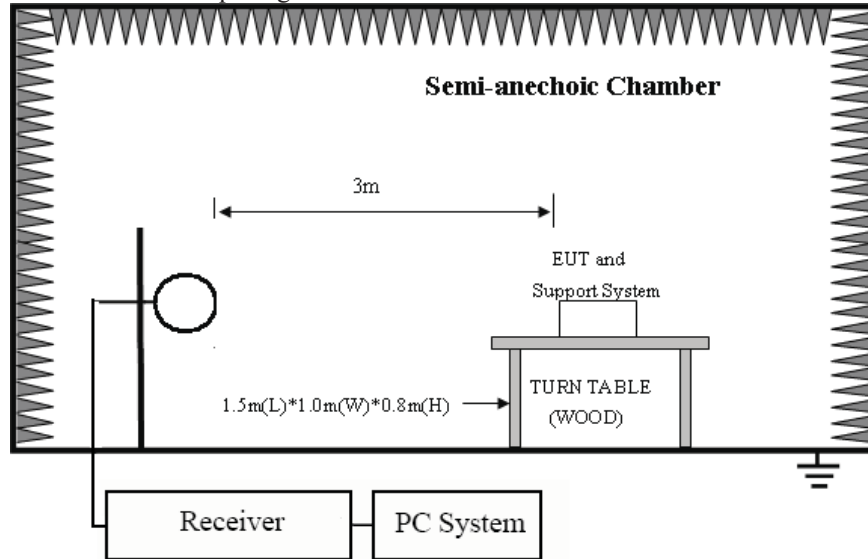

In 3m Anechoic Chamber Test Setup Diagram for 30MHz-1GHz

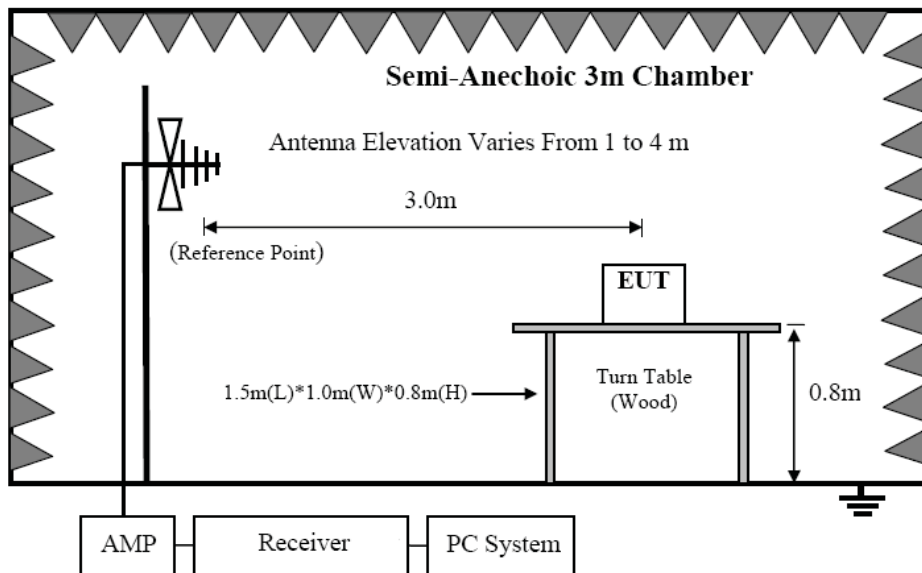

In 3m Anechoic Chamber Test Setup Diagram for frequency above 1GHz

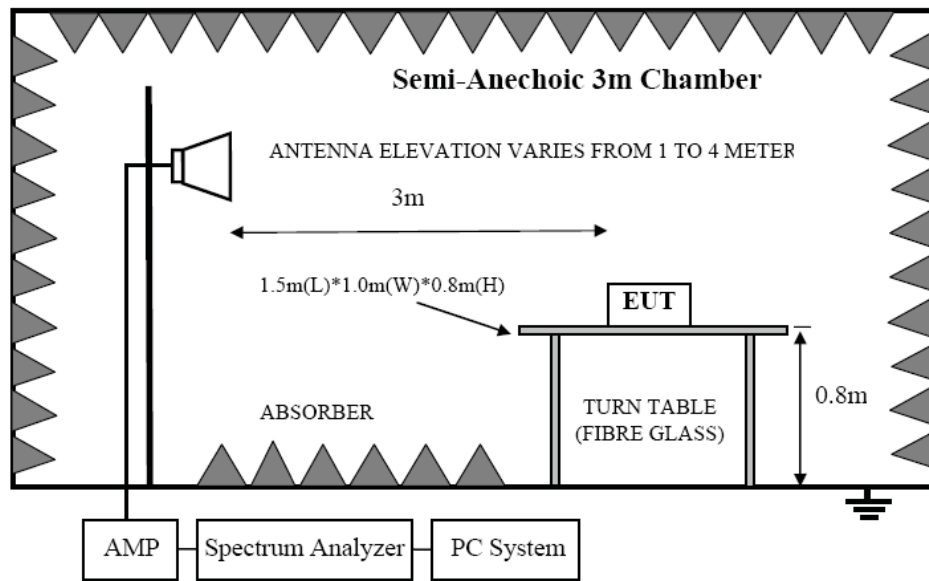

Note: For harmonic emissions test a appropriate high pass filter was inserted in the input port of AMP.

9.2. Limit

8.3.1 FCC 15.205 Restricted frequency band

MHz	MHz	MHz	GHz
0.090 - 0.110	16.42 - 16.423	399.9 - 410	4.5 - 5.15
¹ 0.495 - 0.505	16.69475 - 16.69525	608 - 614	5.35 - 5.46
2.1735 - 2.1905	16.80425 - 16.80475	960 - 1240	7.25 - 7.75
4.125 - 4.128	25.5 - 25.67	1300 - 1427	8.025 - 8.5
4.17725 - 4.17775	37.5 - 38.25	1435 - 1626.5	9.0 - 9.2
4.20725 - 4.20775	73 - 74.6	1645.5 - 1646.5	9.3 - 9.5
6.215 - 6.218	74.8 - 75.2	1660 - 1710	10.6 - 12.7
6.26775 - 6.26825	108 - 121.94	1718.8 - 1722.2	13.25 - 13.4
6.31175 - 6.31225	123 - 138	2200 - 2300	14.47 - 14.5
8.291 - 8.294	149.9 - 150.05	2310 - 2390	15.35 - 16.2
8.362 - 8.366	156.52475 - 156.52525	2483.5 - 2500	17.7 - 21.4
8.37625 - 8.38675	156.7 - 156.9	2690 - 2900	22.01 - 23.12
8.41425 - 8.41475	162.0125 - 167.17	3260 - 3267	23.6 - 24.0
12.29 - 12.293	167.72 - 173.2	3332 - 3339	31.2 - 31.8
12.51975 - 12.52025	240 - 285	3345.8 - 3358	36.43 - 36.5
12.57675 - 12.57725	322 - 335.4	3600 - 4400	(²)

8.3.2 FCC 15.209 Limit.

FREQUENCY MHz	DISTANCE Meters	FIELD STRENGTHS LIMIT	
		μV/m	dB(μV)/m
0.009 ~ 0.490	300	2400/F(KHz)	67.6-20log(F)
0.490 ~ 1.705	30	24000/F(KHz)	87.6-20log(F)
1.705 ~ 30.0	30	30	29.54
30 ~ 88	3	100	40.0
88 ~ 216	3	150	43.5
216 ~ 960	3	200	46.0
960 ~ 1000	3	500	54.0
Above 1000	3	74.0 dB(μV)/m (Peak) 54.0 dB(μV)/m (Average)	

Note: (1) The emission limits shown in the above table are based on measurements employing a CISPR QP detector except for the frequency bands 9-90KHz, 110-490KHz and above 1000MHz. Radiated emissions limits in these three bands are based on measurements employing an average detector.

(2) At frequencies below 30MHz, measurement may be performed at a distance closer than that specified, and the limit at closer measurement distance can be extrapolated by below formula:

$$\text{Limit}_{3m}(\text{dBuV/m}) = \text{Limit}_{30m}(\text{dBuV/m}) + 40\text{Log}(30m/3m)$$

8.3.3 Limit for this EUT

All the emissions appearing within 15.205 restricted frequency bands shall not exceed the limits shown in 15.209, all the other emissions shall be at least 20dB below the fundamental emissions, or comply with 15.209 limits.

9.3. Test Procedure

- (1) EUT height should be 0.8m for below 1GHz at a semi-anechoic chamber while EUT height should be 1.5m for above 1GHz at full chamber or semi-anechoic chamber ground with absorbers
- (2) Setup EUT and assistant system according clause 2.3 and 8.2
- (3) Test antenna was located 3m from the EUT on an adjustable mast, and the antenna used as below table.

Test frequency range	Test antenna used	Test distance
9KHz-30MHz	Active Loop antenna	3m
30MHz-1GHz	Trilog Broadband Antenna	3m
1GHz-18GHz	Double Ridged Horn Antenna(1GHz-18GHz)	3m
18GHz-40GHz	Horn Antenna(18GHz-40GHz)	1m

According ANSI C63.10:2013 clause 6.4.4.2 and 6.5.3, for measurements below 30 MHz, the loop antenna was positioned with its plane vertical from the EUT and rotated about its vertical axis for maximum response at each azimuth position around the EUT. And the loop antenna also be positioned with its plane horizontal at the specified distance from the EUT. The center of the loop is 1 m above the ground. for measurement above 30MHz, the Trilog Broadband Antenna or Horn Antenna was located 3m from EUT, Measurements were made with the antenna positioned in both the horizontal and vertical planes of

Polarization, and the measurement antenna was varied from 1 m to 4 m. in height above the reference ground plane to obtain the maximum signal strength.

(4) Below pre-scan procedure was first performed in order to find prominent frequency spectrum radiated emissions from 9KHz to 25GHz:

(a) Scanning the peak frequency spectrum with the antenna specified in step (3), and the EUT was rotated 360 degree, the antenna height was varied from 1m to 4m(Except loop antenna, it's fixed 1m above ground.)

(b) Change work frequency or channel of device if practicable.

(c) Change modulation type of device if practicable.

(d) Change power supply range from 85% to 115% of the rated supply voltage

(e) Rotated EUT though three orthogonal axes to determine the attitude of EUT arrangement produces highest emissions.

Spectrum frequency from 9KHz to 25GHz (tenth harmonic of fundamental frequency) was investigated, and no any obvious emission were detected from 9KHz to 30MHz and 18GHz to 25GHz, so below final test was

performed with frequency range from 30MHz to 18GHz.

- (5) For final emissions measurements at each frequency of interest, the EUT was rotated and the antenna height was varied between 1m and 4m in order to maximize the emission. Measurements in both horizontal and vertical polarities were made and the data was recorded. In order to find the maximum emission, the relative positions of equipments and all of the interface cables were changed according to ANSI C63.10 2013 on Radiated Emission test.
- (6) The emissions from 9KHz to 1GHz were measured based on CISPR QP detector except for the frequency bands 9-90KHz, 110-490KHz, for emissions from 9KHz-90KHz, 110KHz-490KHz and above 1GHz were measured based on average detector, for emissions above 1GHz, peak emissions also be measured and need comply with Peak limit.
- (7) The emissions from 9KHz to 1GHz, QP or average values were measured with EMI receiver with below RBW

Frequency band	RBW
9KHz-150KHz	200Hz
150KHz-30MHz	9KHz
30MHz-1GHz	120KHz

- (8) For emissions above 1GHz, both Peak and Average level were measured with Spectrum Analyzer, and the RBW is set at 1MHz, VBW is set at 3MHz ,Peak detector for Peak measure , RMS detector for AV value

9.4. Test result

PASS. (See below detailed test result)

All the emissions except fundamental emission from 9KHz to 40GHz were comply with 15.209 limit.

Note1: According exploratory test no any obvious emission were detected from 9KHz to 30MHz and 18GHz to 40GHz, so the final test was performed with frequency range from 30MHz to 18GHz and recorded in below.

Note2: For emissions below 1GHz, according exploratory explorer test, when change Tx mode and channel, have no distinct influence on emissions level, so for emissions below 1GHz, the final test was only performed with EUT working in 11a mode.

Note3: For below test data, when the limit tabular marked “/” means this frequency point is the fundamental emission and no need comply with this limit.

Radiated Emission test (below 1GHz)

TR-4-E-009 Radiated Emission Test Result

Test Site : DDT 3m Chamber 1# D:\2017 RE1# Report Data\17Q0626-5\RE.EM6
Test Date : 2017-07-10 **Tested By** : Aaron
EUT : Streaming wireless adaptor **Model Number** : ADAPT+
Power Supply : AC 120V/60Hz **Test Mode** : Tx mode
Condition : Temp:24.5°C,Humi:55%,
 Press:100.1kPa **Antenna/Distance** : 2016 VULB9163 1#/3m/HORIZONTAL
Memo :

Data: 33

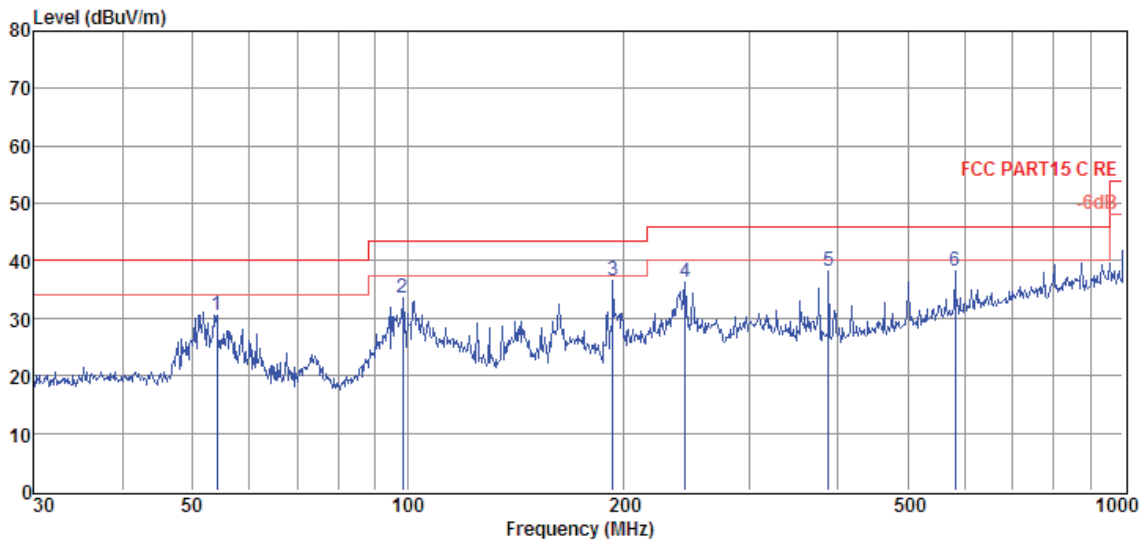

Item (Mark)	Freq. (MHz)	Read Level (dBμV)	Antenna Factor (dB/m)	Cable Loss dB	Result Level (dBμV/m)	Limit Line (dBμV/m)	Over Limit (dB)	Detector	Polarization
1	54.07	14.84	11.70	3.93	30.47	40.00	-9.53	QP	HORIZONTAL
2	98.49	17.26	11.88	4.28	33.42	43.50	-10.08	QP	HORIZONTAL
3	193.77	21.69	10.03	4.86	36.58	43.50	-6.92	QP	HORIZONTAL
4	244.23	18.83	12.24	5.11	36.18	46.00	-9.82	QP	HORIZONTAL
5	387.99	17.05	15.44	5.75	38.24	46.00	-7.76	QP	HORIZONTAL
6	582.74	12.54	19.10	6.45	38.09	46.00	-7.91	QP	HORIZONTAL

Note: 1. Result Level = Read Level + Antenna Factor + Cable loss.

2. If Peak Result complies with QP limit, QP Result is deemed to comply with QP limit.

3. Test setup: RBW: 120 kHz, VBW: 300 kHz, Sweep time: auto.

TR-4-E-009 Radiated Emission Test Result

Test Site : DDT 3m Chamber 1# D:\2017 RE1# Report Data\17Q0626-5\RE.EM6
Test Date : 2017-07-10 **Tested By** : Aaron
EUT : Streaming wireless adaptor **Model Number** : ADAPT+
Power Supply : AC 120V/60Hz **Test Mode** : Tx mode
Condition : Temp:24.5°C,Humi:55%,
 : Press:100.1kPa **Antenna/Distance** : 2016 VULB9163 1#/3m/VERTICAL
Memo :

Data: 34

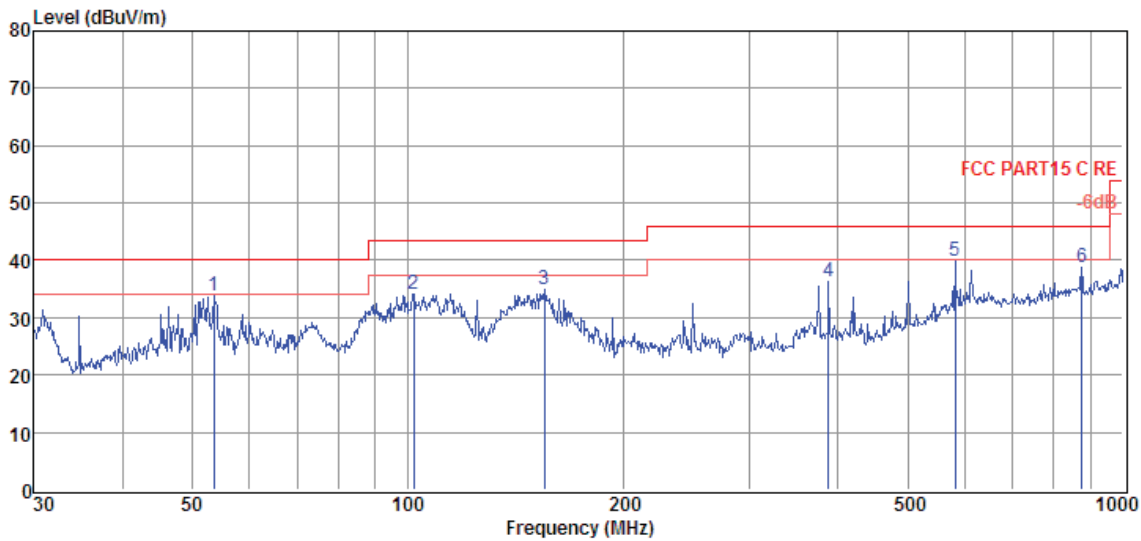

Item (Mark)	Freq. (MHz)	Read Level (dBμV)	Antenna Factor (dB/m)	Cable Loss (dB)	Result Level (dBμV/m)	Limit Line (dBμV/m)	Over Limit (dB)	Detector	Polarization
1	53.51	18.22	11.70	3.92	33.84	40.00	-6.16	QP	VERTICAL
2	102.00	17.95	11.84	4.31	34.10	43.50	-9.40	QP	VERTICAL
3	155.36	22.53	7.82	4.63	34.98	43.50	-8.52	QP	VERTICAL
4	387.99	15.18	15.44	5.75	36.37	46.00	-9.63	QP	VERTICAL
5	582.74	14.20	19.10	6.45	39.75	46.00	-6.25	QP	VERTICAL
6	875.25	9.26	22.05	7.35	38.66	46.00	-7.34	QP	VERTICAL

- Note: 1. Result Level = Read Level + Antenna Factor + Cable loss.
 2. If Peak Result complies with QP limit, QP Result is deemed to comply with QP limit.
 3. Test setup: RBW: 120 kHz, VBW: 300 kHz, Sweep time: auto.

Radiated Emission test (above 1GHz)

Freq (MHz)	Read level (dB μ V)	Antenna Factor (dB/m)	PRM Factor (dB)	Cable Loss (dB)	Result Level (dB μ V/m)	Limit (dB μ V/m)	Margin (dB)	Detector type	Polarization
11a CH36									
6576.00	36.31	35.86	29.97	10.01	52.21	74.00	-21.79	Peak	VERTICAL
7596.00	36.40	36.62	30.90	10.91	53.03	74.00	-20.97	Peak	VERTICAL
8769.00	36.93	36.50	32.15	11.73	53.01	74.00	-20.99	Peak	VERTICAL
12050.00	35.46	37.67	34.82	14.26	52.57	74.00	-21.43	Peak	VERTICAL
16640.00	16.18	44.47	36.28	17.74	42.11	54.00	-11.89	Average	VERTICAL
16640.00	37.18	44.47	36.28	17.74	63.11	74.00	-10.89	Peak	VERTICAL
6440.00	36.63	35.71	29.74	9.91	52.51	74.00	-21.49	Peak	HORIZONTAL
7324.00	36.08	36.46	30.59	10.71	52.66	74.00	-21.34	Peak	HORIZONTAL
8854.00	36.03	36.87	32.22	11.76	52.44	74.00	-21.56	Peak	HORIZONTAL
12679.00	35.43	38.48	35.48	14.65	53.08	74.00	-20.92	Peak	HORIZONTAL
16334.00	16.20	44.44	35.86	17.35	42.13	54.00	-11.87	Average	HORIZONTAL
16334.00	37.20	44.44	35.86	17.35	63.13	74.00	-10.87	Peak	HORIZONTAL
11a CH40									
7409.00	35.77	36.53	30.67	10.78	52.41	74.00	-21.59	Peak	VERTICAL
8939.00	36.08	37.24	32.26	11.79	52.85	74.00	-21.15	Peak	VERTICAL
10911.00	34.47	37.56	33.74	13.37	51.66	74.00	-22.34	Peak	VERTICAL
12934.00	35.91	38.74	35.67	14.67	53.65	74.00	-20.35	Peak	VERTICAL
16674.00	14.14	44.42	36.28	17.84	40.12	54.00	-13.88	Average	VERTICAL
16674.00	37.14	44.42	36.28	17.84	63.12	74.00	-10.88	Peak	VERTICAL
5981.00	36.36	34.99	29.19	9.66	51.82	74.00	-22.18	Peak	HORIZONTAL
7409.00	34.79	36.53	30.67	10.78	51.43	74.00	-22.57	Peak	HORIZONTAL
8956.00	35.02	37.31	32.28	11.79	51.84	74.00	-22.16	Peak	HORIZONTAL
12084.00	34.59	37.72	34.85	14.30	51.76	74.00	-22.24	Peak	HORIZONTAL
16589.00	16.42	44.56	36.21	17.64	42.41	54.00	-11.59	Average	HORIZONTAL
16589.00	37.42	44.56	36.21	17.64	63.41	74.00	-10.59	Peak	HORIZONTAL
11a CH48									
6950.00	35.48	36.16	30.34	10.39	51.69	74.00	-22.31	Peak	VERTICAL
8004.00	36.36	36.69	31.13	11.13	53.05	74.00	-20.95	Peak	VERTICAL
9874.00	36.06	36.78	32.87	12.42	52.39	74.00	-21.61	Peak	VERTICAL
10996.00	35.42	37.79	33.98	13.48	52.71	74.00	-21.29	Peak	VERTICAL
16555.00	17.25	44.61	36.14	17.61	43.33	54.00	-10.67	Average	VERTICAL
16555.00	37.25	44.61	36.14	17.61	63.33	74.00	-10.67	Peak	VERTICAL
7715.00	36.00	36.64	30.99	10.98	52.63	74.00	-21.37	Peak	HORIZONTAL
9109.00	35.76	37.26	32.36	11.95	52.61	74.00	-21.39	Peak	HORIZONTAL
10486.00	36.35	36.41	33.25	12.70	52.21	74.00	-21.79	Peak	HORIZONTAL
13546.00	35.40	39.35	35.12	14.81	54.44	74.00	-19.56	Peak	HORIZONTAL
16691.00	14.86	44.39	36.28	17.84	40.81	54.00	-13.19	Average	HORIZONTAL
16691.00	36.86	44.39	36.28	17.84	62.81	74.00	-11.19	Peak	HORIZONTAL
Conclusion: Pass									
Note: -27 dBm/MHz Limit= $95.2 + \text{EIRP}[\text{dBm}] = 95.2 - 27 = 68.2 \text{ dB}\mu\text{V/m}$ For transmitters operating in the 5150MHz-5250MHz, 5250MHz-5350MHz, 5470MHz-5725MHz, 5725MHz-5850MHz band: all emissions outside of the 5.15-5.35 GHz band shall not exceed an EIRP of -27 dBm/MHz .									

Note: 1. 30MHz~40GHz: (Scan with 11a, 11n HT20, 11n HT40, 11ac20, 11ac40 and 11ac80 the worst case is 11a Mode)

2. Result Level = Read Level + Antenna Factor + Cable loss - PRM Factor.

3. Test setup: RBW: 1 MHz, VBW: 3 MHz, Sweep time: auto.

Freq (MHz)	Read level (dBμV)	Antenna Factor (dB/m)	PRM Factor (dB)	Cable Loss (dB)	Result Level (dBμV/m)	Limit (dBμ V/m)	Margin (dB)	Detector type	Polarization
11a CH52									
6899.00	36.05	36.12	30.31	10.33	52.19	74.00	-21.81	Peak	VERTICAL
7800.00	36.01	36.66	31.04	11.02	52.65	74.00	-21.35	Peak	VERTICAL
8956.00	35.11	37.31	32.28	11.79	51.93	74.00	-22.07	Peak	VERTICAL
12220.00	34.64	37.91	34.95	14.41	52.01	74.00	-21.99	Peak	VERTICAL
16606.00	16.01	44.53	36.21	17.71	42.04	54.00	-11.96	Average	VERTICAL
16606.00	37.01	44.53	36.21	17.71	63.04	74.00	-10.96	Peak	VERTICAL
6406.00	35.95	35.65	29.66	9.88	51.82	74.00	-22.18	Peak	HORIZONTAL
6950.00	36.83	36.16	30.34	10.39	53.04	74.00	-20.96	Peak	HORIZONTAL
7545.00	36.72	36.61	30.84	10.88	53.37	74.00	-20.63	Peak	HORIZONTAL
10520.00	36.60	36.46	33.28	12.74	52.52	74.00	-21.48	Peak	HORIZONTAL
16555.00	16.65	44.61	36.14	17.61	42.73	54.00	-11.27	Average	HORIZONTAL
16555.00	37.65	44.61	36.14	17.61	63.73	74.00	-10.27	Peak	HORIZONTAL
11a CH56									
2411.00	43.11	29.86	29.46	6.03	49.54	74.00	-24.46	Peak	VERTICAL
7341.00	36.12	36.48	30.59	10.72	52.73	74.00	-21.27	Peak	VERTICAL
8905.00	35.59	37.09	32.24	11.77	52.21	74.00	-21.79	Peak	VERTICAL
12084.00	35.30	37.72	34.85	14.30	52.47	74.00	-21.53	Peak	VERTICAL
16640.00	15.32	44.47	36.28	17.74	41.25	54.00	-12.75	Average	VERTICAL
16640.00	38.32	44.47	36.28	17.74	64.25	74.00	-9.75	Peak	VERTICAL
6950.00	36.42	36.16	30.34	10.39	52.63	74.00	-21.37	Peak	HORIZONTAL
8055.00	36.02	36.54	31.18	11.18	52.56	74.00	-21.44	Peak	HORIZONTAL
9024.00	36.11	37.45	32.33	11.83	53.06	74.00	-20.94	Peak	HORIZONTAL
12101.00	35.82	37.74	34.87	14.30	52.99	74.00	-21.01	Peak	HORIZONTAL
16589.00	15.99	44.56	36.21	17.64	41.98	54.00	-12.02	Average	HORIZONTAL
16589.00	36.99	44.56	36.21	17.64	62.98	74.00	-11.02	Peak	HORIZONTAL
11a CH64									
6576.00	36.03	35.86	29.97	10.01	51.93	74.00	-22.07	Peak	VERTICAL
7936.00	36.15	36.69	31.11	11.10	52.83	74.00	-21.17	Peak	VERTICAL
8871.00	36.45	36.94	32.22	11.77	52.94	74.00	-21.06	Peak	VERTICAL
12016.00	35.69	37.62	34.80	14.24	52.75	74.00	-21.25	Peak	VERTICAL
16640.00	17.33	44.47	36.28	17.74	43.26	54.00	-10.74	Average	VERTICAL
16640.00	37.33	44.47	36.28	17.74	63.26	74.00	-10.74	Peak	VERTICAL
6049.00	35.48	35.08	29.23	9.71	51.04	74.00	-22.96	Peak	HORIZONTAL
7035.00	36.22	36.23	30.40	10.47	52.52	74.00	-21.48	Peak	HORIZONTAL
8854.00	35.79	36.87	32.22	11.76	52.20	74.00	-21.80	Peak	HORIZONTAL
12016.00	35.72	37.62	34.80	14.24	52.78	74.00	-21.22	Peak	HORIZONTAL
16334.00	16.05	44.44	35.86	17.35	41.98	54.00	-12.02	Average	HORIZONTAL
16334.00	37.05	44.44	35.86	17.35	62.98	74.00	-11.02	Peak	HORIZONTAL
Conclusion: Pass									
Note: $-27 \text{ dBm/MHz Limit} = 95.2 + \text{EIRP}[\text{dBm}] = 95.2 - 27 = 68.2 \text{ dB}\mu\text{V/m}$ For transmitters operating in the 5150MHz-5250MHz, 5250MHz-5350MHz, 5470MHz-5725MHz, 5725MHz-5850MHz band: all emissions outside of the 5.15-5.35 GHz band shall not exceed an EIRP of -27 dBm/MHz .									

Note: 1. 30MHz~40GHz: (Scan with 11a, 11n HT20, 11n HT40, 11ac20, 11ac40 and 11ac80 the worst case is 11a Mode)

2. Result Level = Read Level + Antenna Factor + Cable loss - PRM Factor.

3. Test setup: RBW: 1 MHz, VBW: 3 MHz, Sweep time: auto.

Freq (MHz)	Read level (dBμV)	Antenna Factor (dB/m)	PRM Factor (dB)	Cable Loss (dB)	Result Level (dBμV/m)	Limit (dBμ V/m)	Margin (dB)	Detector type	Polarization
11a CH100									
6389.00	36.02	35.63	29.60	9.88	51.93	74.00	-22.07	Peak	VERTICAL
7409.00	35.61	36.53	30.67	10.78	52.25	74.00	-21.75	Peak	VERTICAL
8174.00	36.25	36.20	31.29	11.31	52.47	74.00	-21.53	Peak	VERTICAL
12050.00	35.18	37.67	34.82	14.26	52.29	74.00	-21.71	Peak	VERTICAL
16691.00	16.30	44.39	36.28	17.84	42.25	54.00	-11.75	Average	VERTICAL
16691.00	37.30	44.39	36.28	17.84	63.25	74.00	-10.75	Peak	VERTICAL
6916.00	36.18	36.13	30.33	10.37	52.35	74.00	-21.65	Peak	HORIZONTAL
7800.00	36.35	36.66	31.04	11.02	52.99	74.00	-21.01	Peak	HORIZONTAL
8786.00	36.33	36.57	32.15	11.74	52.49	74.00	-21.51	Peak	HORIZONTAL
12645.00	35.17	38.45	35.45	14.65	52.82	74.00	-21.18	Peak	HORIZONTAL
16640.00	17.03	44.47	36.28	17.74	42.96	54.00	-11.04	Average	HORIZONTAL
16640.00	38.03	44.47	36.28	17.74	63.96	74.00	-10.04	Peak	HORIZONTAL
11a CH116									
6916.00	36.10	36.13	30.33	10.37	52.27	74.00	-21.73	Peak	VERTICAL
7766.00	36.49	36.65	31.02	11.01	53.13	74.00	-20.87	Peak	VERTICAL
9160.00	35.42	37.14	32.39	12.01	52.18	74.00	-21.82	Peak	VERTICAL
12050.00	35.71	37.67	34.82	14.26	52.82	74.00	-21.18	Peak	VERTICAL
16691.00	16.91	44.39	36.28	17.84	42.86	54.00	-11.14	Average	VERTICAL
16691.00	36.91	44.39	36.28	17.84	62.86	74.00	-11.14	Peak	VERTICAL
6321.00	36.45	35.52	29.51	9.85	52.31	74.00	-21.69	Peak	HORIZONTAL
7171.00	35.22	36.34	30.48	10.57	51.65	74.00	-22.35	Peak	HORIZONTAL
8820.00	35.98	36.72	32.18	11.75	52.27	74.00	-21.73	Peak	HORIZONTAL
11999.00	36.01	37.60	34.80	14.23	53.04	74.00	-20.96	Peak	HORIZONTAL
16674.00	16.04	44.42	36.28	17.84	42.02	54.00	-11.98	Average	HORIZONTAL
16674.00	37.04	44.42	36.28	17.84	63.02	74.00	-10.98	Peak	HORIZONTAL
11a CH140									
6950.00	36.08	36.16	30.34	10.39	52.29	74.00	-21.71	Peak	VERTICAL
7681.00	36.74	36.64	30.96	10.95	53.37	74.00	-20.63	Peak	VERTICAL
8990.00	35.34	37.46	32.32	11.81	52.29	74.00	-21.71	Peak	VERTICAL
12339.00	34.76	38.08	35.08	14.51	52.27	74.00	-21.73	Peak	VERTICAL
16674.00	16.34	44.42	36.28	17.84	42.32	54.00	-11.68	Average	VERTICAL
16674.00	37.34	44.42	36.28	17.84	63.32	74.00	-10.68	Peak	VERTICAL
6950.00	35.85	36.16	30.34	10.39	52.06	74.00	-21.94	Peak	HORIZONTAL
7596.00	36.31	36.62	30.90	10.91	52.94	74.00	-21.06	Peak	HORIZONTAL
9211.00	35.84	37.03	32.42	12.05	52.50	74.00	-21.50	Peak	HORIZONTAL
12339.00	34.62	38.08	35.08	14.51	52.13	74.00	-21.87	Peak	HORIZONTAL
16300.00	16.19	44.38	35.80	17.33	42.10	54.00	-11.90	Average	HORIZONTAL
16300.00	36.19	44.38	35.80	17.33	62.10	74.00	-11.90	Peak	HORIZONTAL
Conclusion: Pass									
Note: $-27 \text{ dBm/MHz Limit} = 95.2 + \text{EIRP}[\text{dBm}] = 95.2 - 27 = 68.2 \text{ dB}\mu\text{V/m}$ For transmitters operating in the 5150MHz-5250MHz, 5250MHz-5350MHz, 5470MHz-5725MHz, 5725MHz-5850MHz band: all emissions outside of the 5.15-5.35 GHz band shall not exceed an EIRP of -27 dBm/MHz.									

Note: 1.30MHz~40GHz: (Scan with 11a, 11n HT20, 11n HT40, 11ac20, 11ac40 and 11ac80 the worst case is 11a Mode)

2. Result Level = Read Level + Antenna Factor + Cable loss - PRM Factor.
3. Test setup: RBW: 1 MHz, VBW: 3 MHz, Sweep time: auto.

Freq (MHz)	Read level (dBμV)	Antenna Factor (dB/m)	PRM Factor (dB)	Cable Loss (dB)	Result Level (dBμV/m)	Limit (dBμ V/m)	Margin (dB)	Detector type	Polarization
11a CH149									
6916.00	35.87	36.13	30.33	10.37	52.04	74.00	-21.96	Peak	VERTICAL
8038.00	35.57	36.59	31.17	11.18	52.17	74.00	-21.83	Peak	VERTICAL
9075.00	36.08	37.33	32.35	11.89	52.95	74.00	-21.05	Peak	VERTICAL
12016.00	35.92	37.62	34.80	14.24	52.98	74.00	-21.02	Peak	VERTICAL
16691.00	16.15	44.39	36.28	17.84	42.10	54.00	-11.90	Average	VERTICAL
16691.00	37.15	44.39	36.28	17.84	63.10	74.00	-10.90	Peak	VERTICAL
7171.00	36.38	36.34	30.48	10.57	52.81	74.00	-21.19	Peak	HORIZONTAL
7936.00	36.02	36.69	31.11	11.10	52.70	74.00	-21.30	Peak	HORIZONTAL
8854.00	36.17	36.87	32.22	11.76	52.58	74.00	-21.42	Peak	HORIZONTAL
10350.00	35.74	36.55	33.15	12.62	51.76	74.00	-22.24	Peak	HORIZONTAL
16606.00	16.46	44.53	36.21	17.71	42.49	54.00	-11.51	Average	HORIZONTAL
16606.00	37.45	44.53	36.21	17.71	63.48	74.00	-10.52	Peak	HORIZONTAL
11a CH157									
6950.00	36.44	36.16	30.34	10.39	52.65	74.00	-21.35	Peak	VERTICAL
8004.00	36.30	36.69	31.13	11.13	52.99	74.00	-21.01	Peak	VERTICAL
9024.00	35.67	37.45	32.33	11.83	52.62	74.00	-21.38	Peak	VERTICAL
12339.00	34.59	38.08	35.08	14.51	52.10	74.00	-21.90	Peak	VERTICAL
16725.00	15.61	44.34	36.34	17.94	41.55	54.00	-12.45	Average	VERTICAL
16725.00	36.61	44.34	36.34	17.94	62.55	74.00	-11.45	Peak	VERTICAL
6950.00	36.29	36.16	30.34	10.39	52.50	74.00	-21.50	Peak	HORIZONTAL
7460.00	36.03	36.57	30.73	10.83	52.70	74.00	-21.30	Peak	HORIZONTAL
9041.00	35.45	37.41	32.34	11.87	52.39	74.00	-21.61	Peak	HORIZONTAL
11965.00	35.84	37.54	34.78	14.18	52.78	74.00	-21.22	Peak	HORIZONTAL
16351.00	15.85	44.46	35.86	17.38	41.83	54.00	-12.17	Average	HORIZONTAL
16351.00	36.85	44.46	35.86	17.38	62.83	74.00	-11.17	Peak	HORIZONTAL
11a CH165									
6984.00	36.51	36.19	30.38	10.40	52.72	74.00	-21.28	Peak	VERTICAL
8021.00	35.83	36.64	31.17	11.16	52.46	74.00	-21.54	Peak	VERTICAL
9160.00	35.64	37.14	32.39	12.01	52.40	74.00	-21.60	Peak	VERTICAL
12050.00	35.83	37.67	34.82	14.26	52.94	74.00	-21.06	Peak	VERTICAL
16470.00	16.53	44.65	35.99	17.46	42.65	54.00	-11.35	Average	VERTICAL
16470.00	37.53	44.65	35.99	17.46	63.65	74.00	-10.35	Peak	VERTICAL
6984.00	36.61	36.19	30.38	10.40	52.82	74.00	-21.18	Peak	HORIZONTAL
7885.00	35.91	36.68	31.09	11.08	52.58	74.00	-21.42	Peak	HORIZONTAL
9789.00	36.43	36.69	32.84	12.41	52.69	74.00	-21.31	Peak	HORIZONTAL
10996.00	35.08	37.79	33.98	13.48	52.37	74.00	-21.63	Peak	HORIZONTAL
16674.00	16.29	44.42	36.28	17.84	42.27	54.00	-11.73	Average	HORIZONTAL
16674.00	37.29	44.42	36.28	17.84	63.27	74.00	-10.73	Peak	HORIZONTAL
Conclusion: Pass									
Note: $-27 \text{ dBm/MHz Limit} = 95.2 + \text{EIRP}[\text{dBm}] = 95.2 - 27 = 68.2 \text{ dB}\mu\text{V/m}$ For transmitters operating in the 5150MHz-5250MHz, 5250MHz-5350MHz, 5470MHz-5725MHz, 5725MHz-5850MHz band: all emissions outside of the 5.15-5.35 GHz band shall not exceed an EIRP of -27 dBm/MHz .									

Note: 1. 30MHz~40GHz: (Scan with 11a, 11n HT20, 11n HT40, 11ac20, 11ac40 and 11ac80 the worst case is 11a Mode)

2. Result Level = Read Level + Antenna Factor + Cable loss - PRM Factor.

3. Test setup: RBW: 1 MHz, VBW: 3 MHz, Sweep time: auto.

10. Band Edge Compliance

10.1. Block diagram of test setup

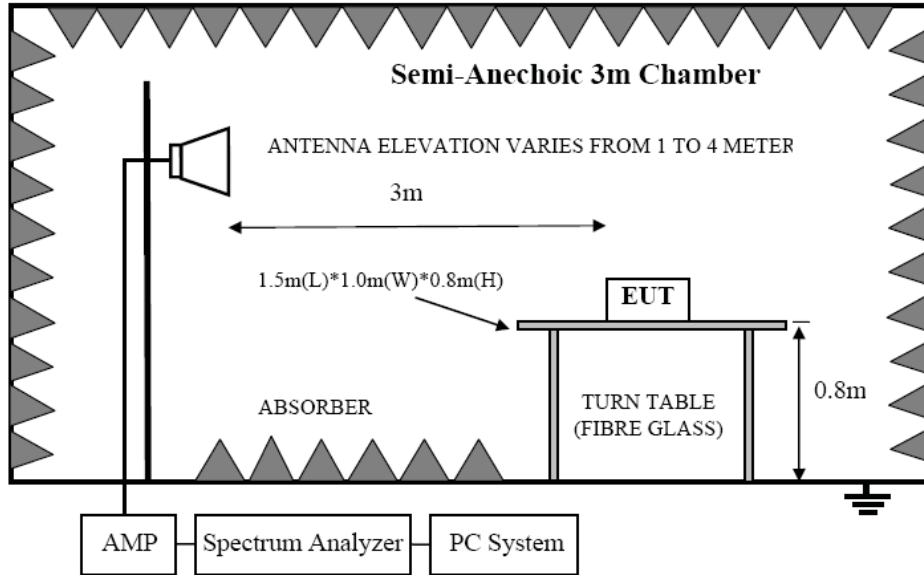

10.2. Limit

For transmitters operating in the 5.15-5.25 GHz and 5.725-5.85G band: all emissions outside of the 5.15-5.35 GHz band shall not exceed an EIRP of -27 dBm/MHz.

$$-27 \text{ dBm/MHz Limit} = 95.2 + \text{EIRP}[\text{dBm}] = 95.2 - 27 = 68.2 \text{ dB}\mu\text{V/m}$$

10.3. Test Procedure

Same with clause 8.3 except change investigated frequency range from 5.15-5.25 GHz, 5.725-5.85G.

Remark: All restriction band have been tested, and only the worse case is shown in report.

10.4. Test result

PASS. (See below detailed test result)

TR-4-E-009 Radiated Emission Test Result

Test Site	: DDT 3m Chamber 1#	D:\2017 RE1# Report Data\17Q0626-5\RF FCC 5 G WIFI 边带.EM6	
Test Date	: 2017-07-23	Tested By	: Jerry
EUT	: Streaming Wireless Adaptor	Model Number	: ADAPT+
Power Supply	: DC 5V from Adapter	Test Mode	: TX mode
Condition	: Temp:24.5°C,Humi:55%, Press:100.1kPa	Antenna/Distance	: 2016 HF907/3m/HORIZONTAL
Memo	: 11ac 20 5180MHz		

Data: 1

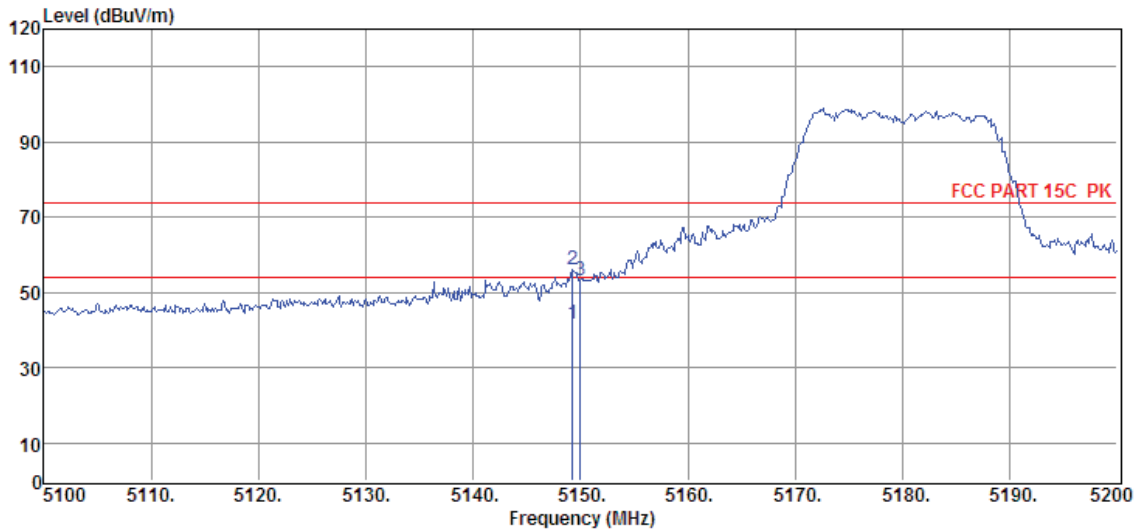

Item (Mark)	Freq. (MHz)	Read Level (dBμV)	Antenna Factor (dB/m)	PRM Factor dB	Cable Loss dB	Result Level (dBμV/m)	Limit Line (dBμV/m)	Over Limit (dB)	Detector	Polarization
1	5149.30	28.19	34.01	29.33	8.84	41.71	54.00	-12.29	Average	HORIZONTAL
2	5149.30	42.51	34.01	29.33	8.84	56.03	74.00	-17.97	Peak	HORIZONTAL
3	5150.00	39.75	34.01	29.33	8.84	53.27	74.00	-20.73	Peak	HORIZONTAL

- Note: 1. Result Level = Read Level + Antenna Factor + Cable loss - PRM Factor.
 2. If Peak Result complies with AV limit, AV Result is deemed to comply with AV limit.
 3. Test setup: RBW: 1 MHz, VBW: 3 MHz, Sweep time: auto.

TR-4-E-009 Radiated Emission Test Result

Test Site : DDT 3m Chamber 1#
Test Date : 2017-07-23
EUT : Streaming Wireless Adaptor
Power Supply : DC 5V from Adapter
Condition : Temp:24.5'C,Humi:55%,
 Press:100.1kPa
Memo : 11ac 20 5180MHz

D:\2017 RE1# Report Data\17Q0626-5\RF FCC 5 G WIFI 边带.EM6
Tested By : Jerry
Model Number : ADAPT+
Test Mode : TX mode
Antenna/Distance : 2016 HF907/3m/VERTICAL

Data: 2

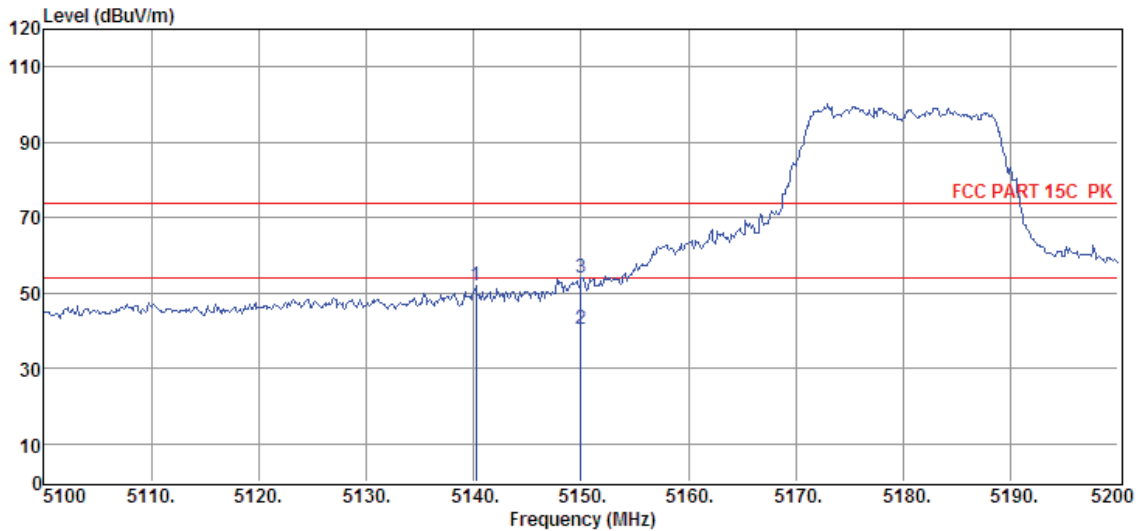

Item (Mark)	Freq. (MHz)	Read Level (dB μ V)	Antenna Factor (dB/m)	PRM Factor dB	Cable Loss dB	Result Level (dB μ V/m)	Limit Line (dB μ V/m)	Over Limit (dB)	Detector	Polarization
1	5140.20	38.46	33.99	29.33	8.84	51.96	74.00	-22.04	Peak	VERTICAL
2	5150.00	27.05	34.01	29.33	8.84	40.57	54.00	-13.43	Average	VERTICAL
3	5150.00	40.49	34.01	29.33	8.84	54.01	74.00	-19.99	Peak	VERTICAL

Note: 1. Result Level = Read Level + Antenna Factor + Cable loss - PRM Factor.

2. If Peak Result complies with AV limit, AV Result is deemed to comply with AV limit.

3. Test setup: RBW: 1 MHz, VBW: 3 MHz, Sweep time: auto.

TR-4-E-009 Radiated Emission Test Result

Test Site : DDT 3m Chamber 1# D:\2017 RE1# Report Data\17Q0626-5\RF FCC 5 G WIFI 边带.EM6
Test Date : 2017-07-23 **Tested By** : Jerry
EUT : Streaming Wireless Adaptor **Model Number** : ADAPT+
Power Supply : DC 5V from Adapter **Test Mode** : TX mode
Condition : Temp:24.5°C,Humi:55%,
 Press:100.1kPa **Antenna/Distance** : 2016 HF907/3m/VERTICAL
Memo : 11ac 20 5240MHz

Data: 3

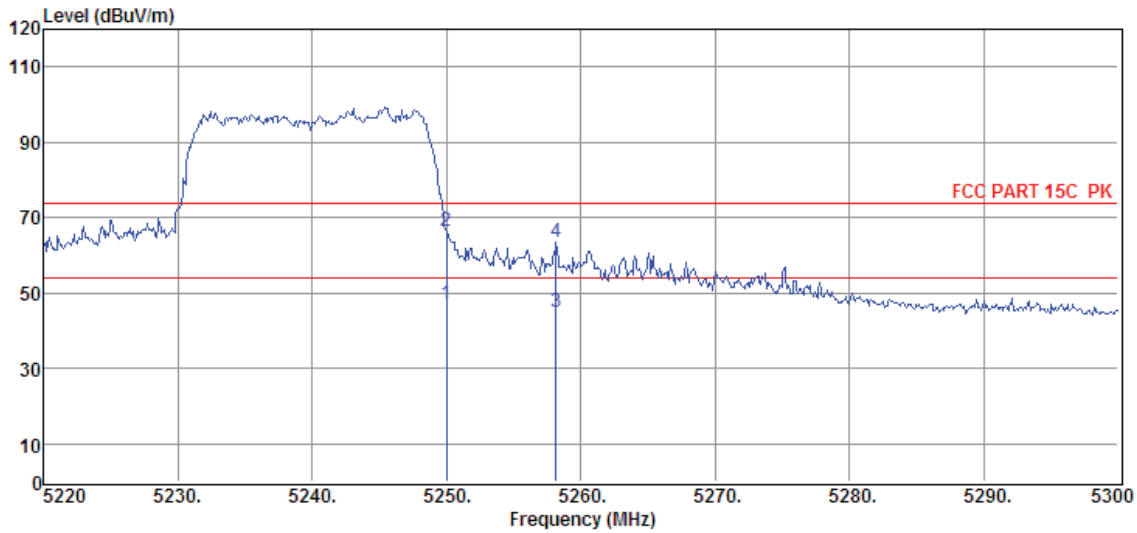

Item (Mark)	Freq. (MHz)	Read Level (dBμV)	Antenna Factor (dB/m)	PRM Factor dB	Cable Loss dB	Result Level (dBμV/m)	Limit Line (dBμV/m)	Over Limit (dB)	Detector	Polarization
1	5250.00	33.06	34.21	29.32	8.93	46.88	54.00	-7.12	Average	VERTICAL
2	5250.00	52.44	34.21	29.32	8.93	66.26	74.00	-7.74	Peak	VERTICAL
3	5258.16	31.09	34.23	29.32	8.93	44.93	54.00	-9.07	Average	VERTICAL
4	5258.16	49.57	34.23	29.32	8.93	63.41	74.00	-10.59	Peak	VERTICAL

- Note: 1. Result Level = Read Level + Antenna Factor + Cable loss - PRM Factor.
 2. If Peak Result complies with AV limit, AV Result is deemed to comply with AV limit.
 3. Test setup: RBW: 1 MHz, VBW: 3 MHz, Sweep time: auto.

TR-4-E-009 Radiated Emission Test Result

Test Site : DDT 3m Chamber 1#
Test Date : 2017-07-23
EUT : Streaming Wireless Adaptor
Power Supply : DC 5V from Adapter
Condition : Temp:24.5'C,Humi:55%,
 Press:100.1kPa
Memo : 11ac 20 5240MHz

D:\2017 RE1# Report Data\17Q0626-5\RF FCC 5 G WIFI 边
 带.EM6
Tested By : Jerry
Model Number : ADAPT+
Test Mode : TX mode
Antenna/Distance : 2016 HF907/3m/HORIZONTAL

Data: 4

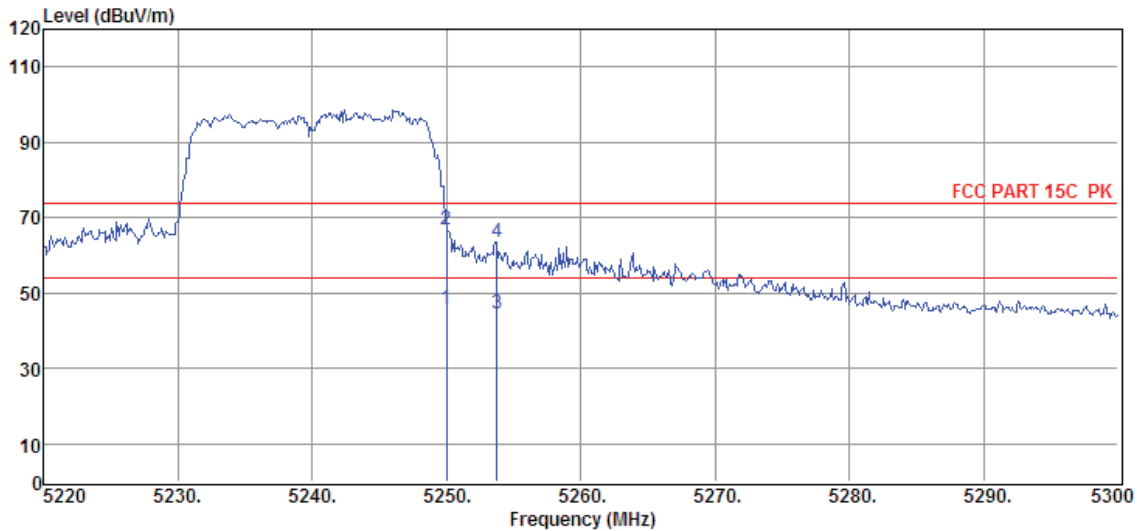

Item (Mark)	Freq. (MHz)	Read Level (dB μ V)	Antenna Factor (dB/m)	PRM Factor dB	Cable Loss dB	Result Level (dB μ V/m)	Limit Line (dB μ V/m)	Over Limit (dB)	Detector	Polarization
1	5250.00	32.08	34.21	29.32	8.93	45.90	54.00	-8.10	Average	HORIZONTAL
2	5250.00	52.80	34.21	29.32	8.93	66.62	74.00	-7.38	Peak	HORIZONTAL
3	5253.76	30.64	34.22	29.32	8.93	44.47	54.00	-9.53	Average	HORIZONTAL
4	5253.76	49.83	34.22	29.32	8.93	63.66	74.00	-10.34	Peak	HORIZONTAL

- Note: 1. Result Level = Read Level + Antenna Factor + Cable loss - PRM Factor.
 2. If Peak Result complies with AV limit, AV Result is deemed to comply with AV limit.
 3. Test setup: RBW: 1 MHz, VBW: 3 MHz, Sweep time: auto.

TR-4-E-009 Radiated Emission Test Result

Test Site : DDT 3m Chamber 1# D:\2017 RE1# Report Data\17Q0626-5\RF FCC 5 G WIFI 边带.EM6
Test Date : 2017-07-23 **Tested By** : Jerry
EUT : Streaming Wireless Adaptor **Model Number** : ADAPT+
Power Supply : DC 5V from Adapter **Test Mode** : TX mode
Condition : Temp:24.5'C,Humi:55%,
 Press:100.1kPa **Antenna/Distance** : 2016 HF907/3m/HORIZONTAL
Memo : 11ac 20 5260MHz

Data: 5

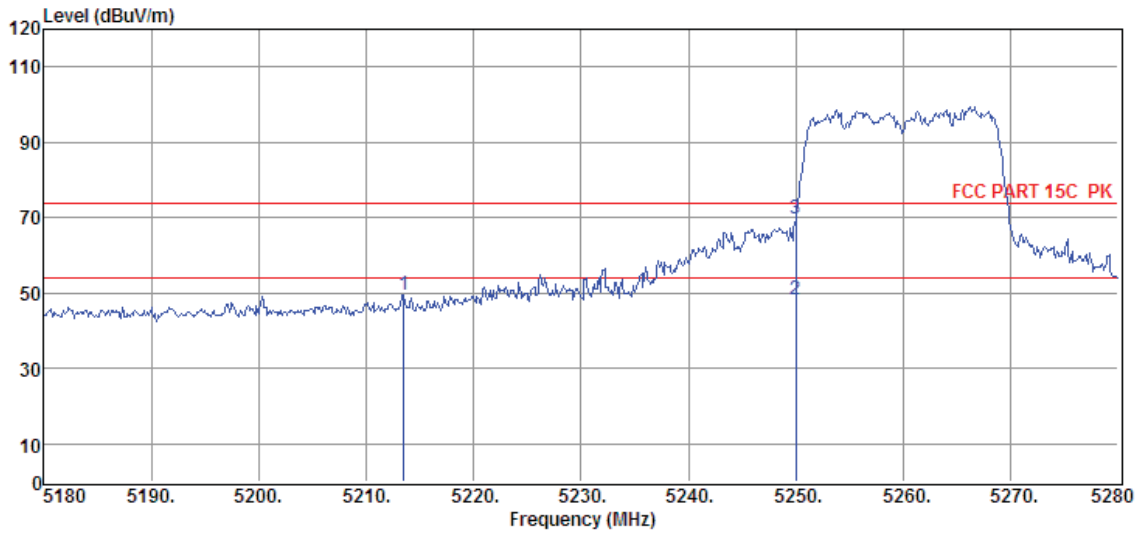

Item (Mark)	Freq. (MHz)	Read Level (dBμV)	Antenna Factor (dB/m)	PRM Factor dB	Cable Loss dB	Result Level (dBμV/m)	Limit Line (dBμV/m)	Over Limit (dB)	Detector	Polarization
1	5213.50	35.93	34.14	29.33	8.91	49.65	74.00	-24.35	Peak	HORIZONTAL
2	5250.00	34.60	34.21	29.32	8.93	48.42	54.00	-5.58	Average	HORIZONTAL
3	5250.00	55.75	34.21	29.32	8.93	69.57	74.00	-4.43	Peak	HORIZONTAL

- Note: 1. Result Level = Read Level + Antenna Factor + Cable loss - PRM Factor.
 2. If Peak Result complies with AV limit, AV Result is deemed to comply with AV limit.
 3. Test setup: RBW: 1 MHz, VBW: 3 MHz, Sweep time: auto.

TR-4-E-009 Radiated Emission Test Result

Test Site	: DDT 3m Chamber 1#	D:\2017 RE1# Report Data\17Q0626-5\RF FCC 5 G WIFI 边带.EM6
Test Date	: 2017-07-23	Tested By : Jerry
EUT	: Streaming Wireless Adaptor	Model Number : ADAPT+
Power Supply	: DC 5V from Adapter	Test Mode : TX mode
Condition	: Temp:24.5°C,Humi:55%, Press:100.1kPa	Antenna/Distance : 2016 HF907/3m/VERTICAL
Memo	: 11ac 20 5260MHz	

Data: 6

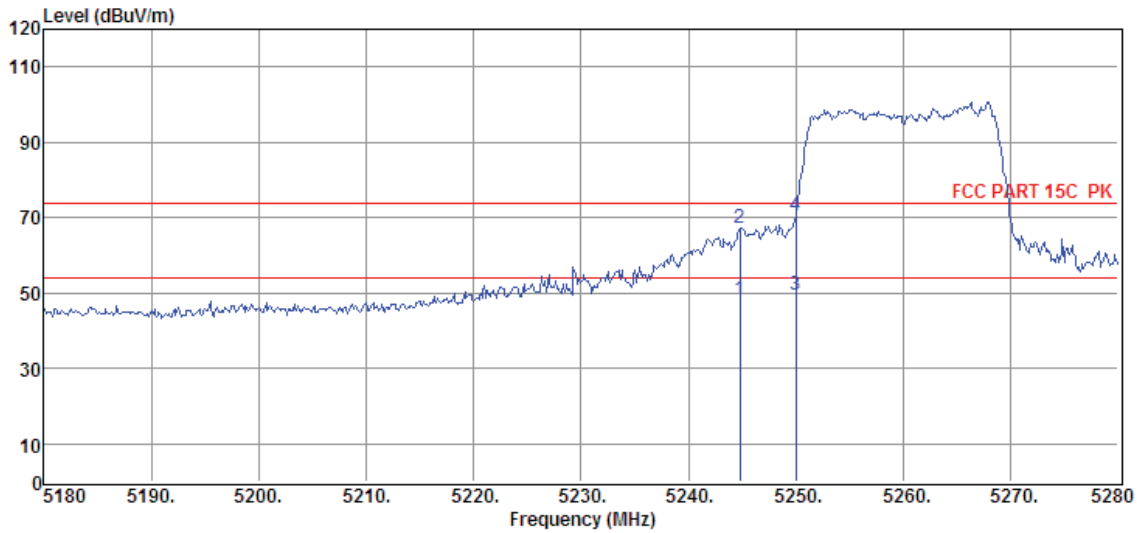

Item (Mark)	Freq. (MHz)	Read Level (dBμV)	Antenna Factor (dB/m)	PRM Factor dB	Cable Loss dB	Result Level (dBμV/m)	Limit Line (dBμV/m)	Over Limit (dB)	Detector	Polarization
1	5244.80	34.32	34.20	29.32	8.93	48.13	54.00	-5.87	Average	VERTICAL
2	5244.80	53.48	34.20	29.32	8.93	67.29	74.00	-6.71	Peak	VERTICAL
3	5250.00	35.71	34.21	29.32	8.93	49.53	54.00	-4.47	Average	VERTICAL
4	5250.00	56.84	34.21	29.32	8.93	70.66	74.00	-3.34	Peak	VERTICAL

Note: 1. Result Level = Read Level + Antenna Factor + Cable loss - PRM Factor.
 2. If Peak Result complies with AV limit, AV Result is deemed to comply with AV limit.
 3. Test setup: RBW: 1 MHz, VBW: 3 MHz, Sweep time: auto.

TR-4-E-009 Radiated Emission Test Result

Test Site : DDT 3m Chamber 1# D:\2017 RE1# Report Data\17Q0626-5\RF FCC 5 G WIFI 边带.EM6
Test Date : 2017-07-23 **Tested By** : Jerry
EUT : Streaming Wireless Adaptor **Model Number** : ADAPT+
Power Supply : DC 5V from Adapter **Test Mode** : TX mode
Condition : Temp:24.5'C,Humi:55%,
 Press:100.1kPa **Antenna/Distance** : 2016 HF907/3m/VERTICAL
Memo : 11ac 20 5320MHz

Data: 7

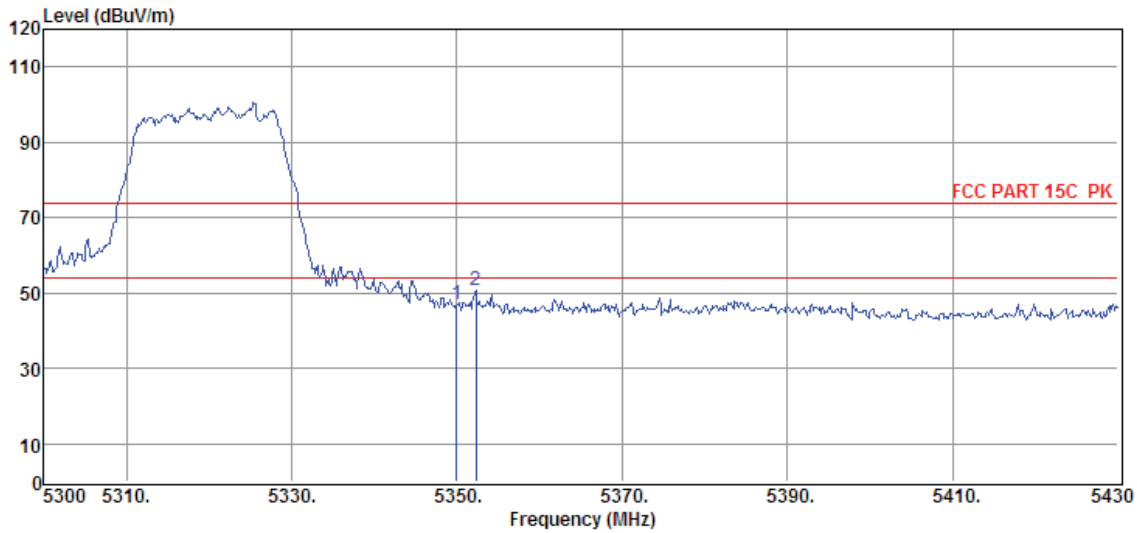

Item (Mark)	Freq. (MHz)	Read Level (dBμV)	Antenna Factor (dB/m)	PRM Factor dB	Cable Loss dB	Result Level (dBμV/m)	Limit Line (dBμV/m)	Over Limit (dB)	Detector	Polarization
1	5350.00	32.86	34.41	29.30	9.03	47.00	74.00	-27.00	Peak	VERTICAL
2	5352.26	36.78	34.41	29.30	9.03	50.92	74.00	-23.08	Peak	VERTICAL

- Note: 1. Result Level = Read Level + Antenna Factor + Cable loss - PRM Factor.
 2. If Peak Result complies with AV limit, AV Result is deemed to comply with AV limit.
 3. Test setup: RBW: 1 MHz, VBW: 3 MHz, Sweep time: auto.

TR-4-E-009 Radiated Emission Test Result

Test Site : DDT 3m Chamber 1# D:\2017 RE1# Report Data\17Q0626-5\RF FCC 5 G WIFI 边带.EM6
Test Date : 2017-07-23 **Tested By** : Jerry
EUT : Streaming Wireless Adaptor **Model Number** : ADAPT+
Power Supply : DC 5V from Adapter **Test Mode** : TX mode
Condition : Temp:24.5°C,Humi:55%,
 Press:100.1kPa **Antenna/Distance** : 2016 HF907/3m/HORIZONTAL
Memo : 11ac 20 5320MHz

Data: 8

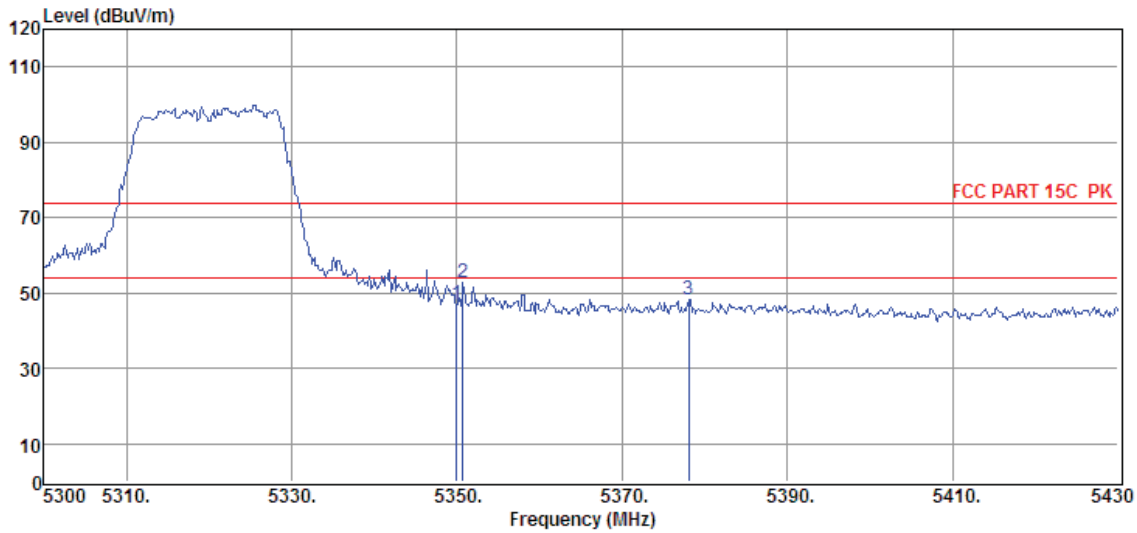

Item (Mark)	Freq. (MHz)	Read Level (dBμV)	Antenna Factor (dB/m)	PRM Factor dB	Cable Loss dB	Result Level (dBμV/m)	Limit Line (dBμV/m)	Over Limit (dB)	Detector	Polarization
1	5350.00	32.96	34.41	29.30	9.03	47.10	74.00	-26.90	Peak	HORIZONTAL
2	5350.70	38.75	34.41	29.30	9.03	52.89	74.00	-21.11	Peak	HORIZONTAL
3	5378.00	34.19	34.46	29.30	9.05	48.40	74.00	-25.60	Peak	HORIZONTAL

- Note: 1. Result Level = Read Level + Antenna Factor + Cable loss - PRM Factor.
 2. If Peak Result complies with AV limit, AV Result is deemed to comply with AV limit.
 3. Test setup: RBW: 1 MHz, VBW: 3 MHz, Sweep time: auto.

TR-4-E-009 Radiated Emission Test Result

Test Site : DDT 3m Chamber 1#
Test Date : 2017-07-23
EUT : Streaming Wireless Adaptor
Power Supply : DC 5V from Adapter
Condition : Temp:24.5'C,Humi:55%,
 Press:100.1kPa
Memo : 11ac 20 5500MHz

D:\2017 RE1# Report Data\17Q0626-5\RF FCC 5 G WIFI 边
 带.EM6
Tested By : Jerry
Model Number : ADAPT+
Test Mode : TX mode
Antenna/Distance : 2016 HF907/3m/HORIZONTAL

Data: 9

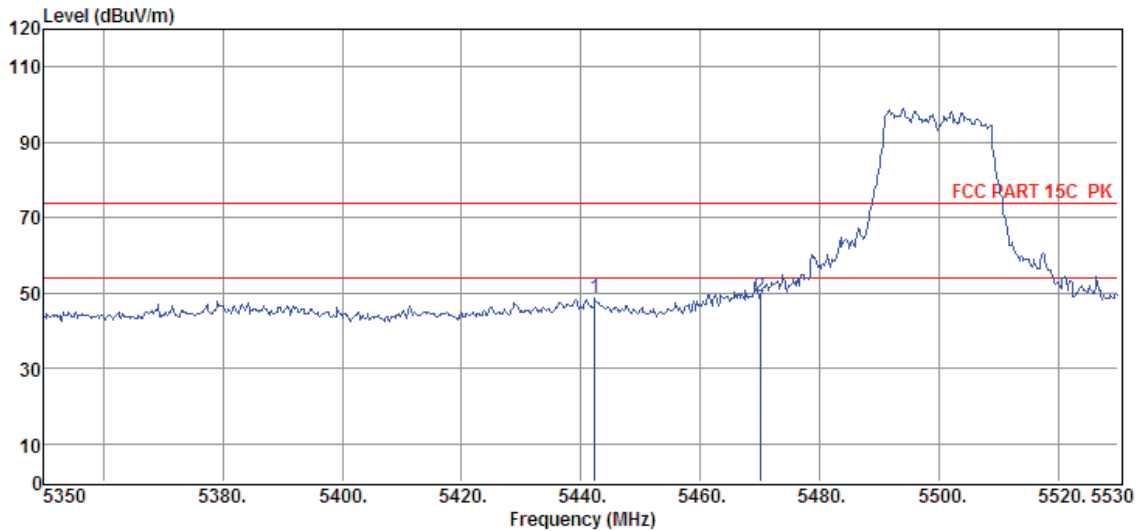

Item (Mark)	Freq. (MHz)	Read Level (dBμV)	Antenna Factor (dB/m)	PRM Factor dB	Cable Loss dB	Result Level (dBμV/m)	Limit Line (dBμV/m)	Over Limit (dB)	Detector	Polarization
1	5442.34	34.09	34.59	29.28	9.14	48.54	74.00	-25.46	Peak	HORIZONTAL
2	5470.00	34.54	34.64	29.27	9.16	49.07	74.00	-24.93	Peak	HORIZONTAL

- Note: 1. Result Level = Read Level + Antenna Factor + Cable loss - PRM Factor.
 2. If Peak Result complies with AV limit, AV Result is deemed to comply with AV limit.
 3. Test setup: RBW: 1 MHz, VBW: 3 MHz, Sweep time: auto.

TR-4-E-009 Radiated Emission Test Result

Test Site : DDT 3m Chamber 1# D:\2017 RE1# Report Data\17Q0626-5\RF FCC 5 G WIFI 边带.EM6
Test Date : 2017-07-23 **Tested By** : Jerry
EUT : Streaming Wireless Adaptor **Model Number** : ADAPT+
Power Supply : DC 5V from Adapter **Test Mode** : TX mode
Condition : Temp:24.5'C,Humi:55%,
 Press:100.1kPa **Antenna/Distance** : 2016 HF907/3m/VERTICAL
Memo : 11ac 20 5500MHz

Data: 10

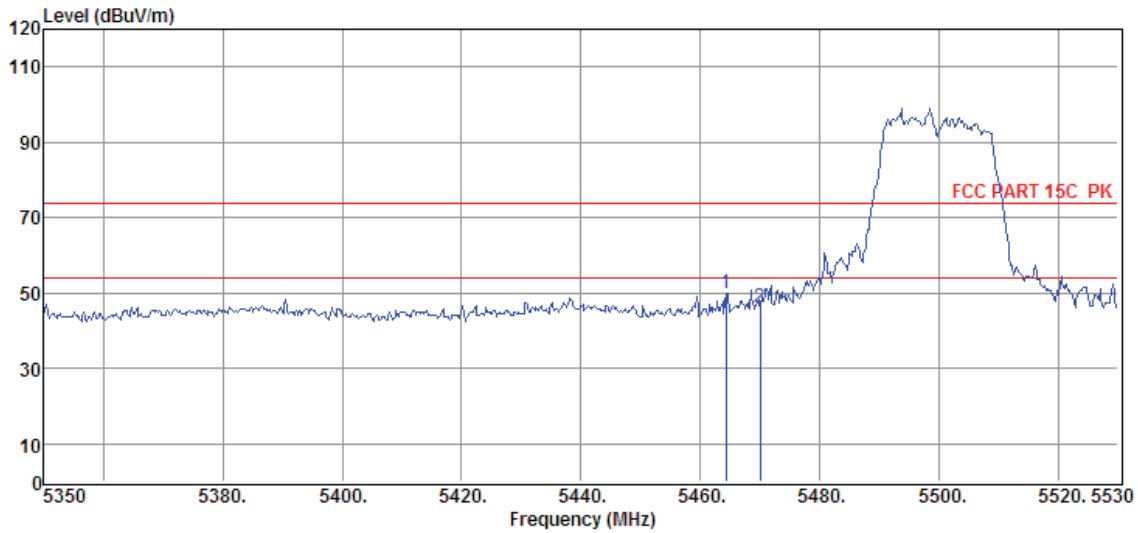

Item (Mark)	Freq. (MHz)	Read Level (dBμV)	Antenna Factor (dB/m)	PRM Factor dB	Cable Loss dB	Result Level (dBμV/m)	Limit Line (dBμV/m)	Over Limit (dB)	Detector	Polarization
1	5464.30	35.24	34.63	29.27	9.16	49.76	74.00	-24.24	Peak	VERTICAL
2	5470.00	31.74	34.64	29.27	9.16	46.27	74.00	-27.73	Peak	VERTICAL

- Note: 1. Result Level = Read Level + Antenna Factor + Cable loss - PRM Factor.
 2. If Peak Result complies with AV limit, AV Result is deemed to comply with AV limit.
 3. Test setup: RBW: 1 MHz, VBW: 3 MHz, Sweep time: auto.

TR-4-E-009 Radiated Emission Test Result

Test Site : DDT 3m Chamber 1# D:\2017 RE1# Report Data\17Q0626-5\RF FCC 5 G WIFI 边带.EM6
Test Date : 2017-07-23 **Tested By** : Jerry
EUT : Streaming Wireless Adaptor **Model Number** : ADAPT+
Power Supply : DC 5V from Adapter **Test Mode** : TX mode
Condition : Temp:24.5°C,Humi:55%,
 Press:100.1kPa **Antenna/Distance** : 2016 HF907/3m/VERTICAL
Memo : 11ac 20 5700MHz

Data: 11

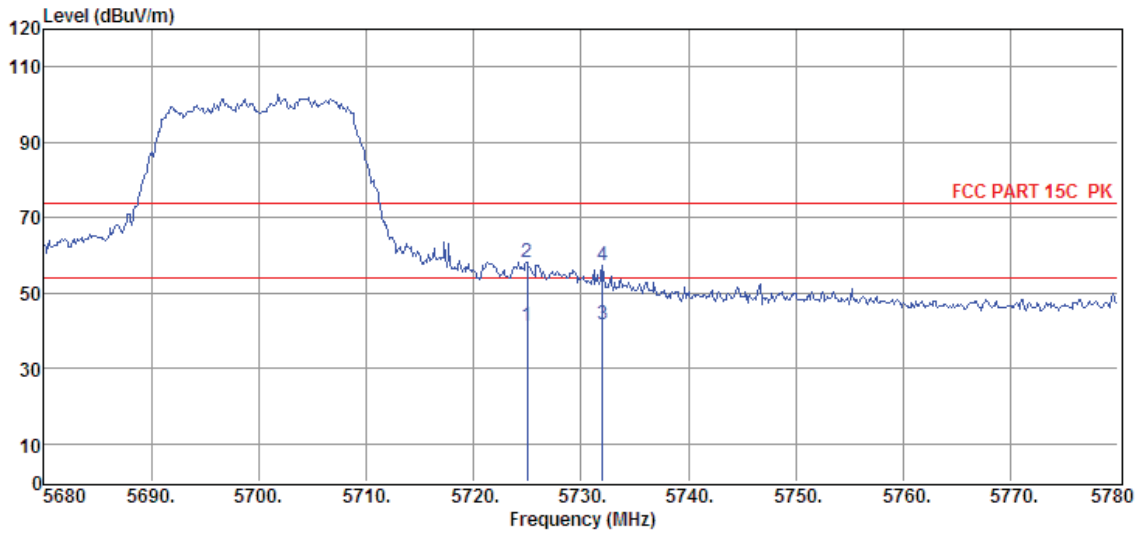

Item (Mark)	Freq. (MHz)	Read Level (dBμV)	Antenna Factor (dB/m)	PRM Factor dB	Cable Loss dB	Result Level (dBμV/m)	Limit Line (dBμV/m)	Over Limit (dB)	Detector	Polarization
1	5725.00	26.20	34.84	29.22	9.41	41.23	54.00	-12.77	Average	VERTICAL
2	5725.00	43.08	34.84	29.22	9.41	58.11	74.00	-15.89	Peak	VERTICAL
3	5732.00	26.52	34.84	29.22	9.41	41.55	54.00	-12.45	Average	VERTICAL
4	5732.00	42.42	34.84	29.22	9.41	57.45	74.00	-16.55	Peak	VERTICAL

- Note: 1. Result Level = Read Level + Antenna Factor + Cable loss - PRM Factor.
 2. If Peak Result complies with AV limit, AV Result is deemed to comply with AV limit.
 3. Test setup: RBW: 1 MHz, VBW: 3 MHz, Sweep time: auto.

TR-4-E-009 Radiated Emission Test Result

Test Site : DDT 3m Chamber 1# D:\2017 RE1# Report Data\17Q0626-5\RF FCC 5 G WIFI 边带.EM6
Test Date : 2017-07-23 **Tested By** : Jerry
EUT : Streaming Wireless Adaptor **Model Number** : ADAPT+
Power Supply : DC 5V from Adapter **Test Mode** : TX mode
Condition : Temp:24.5°C,Humi:55%,
 Press:100.1kPa **Antenna/Distance** : 2016 HF907/3m/HORIZONTAL
Memo : 11ac 20 5700MHz

Data: 12

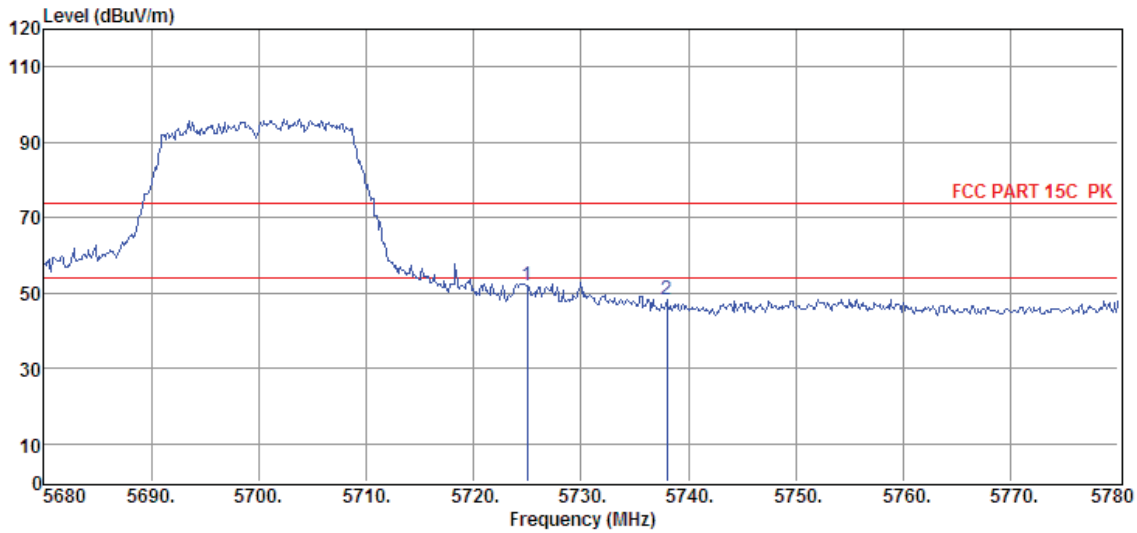

Item (Mark)	Freq. (MHz)	Read Level (dBμV)	Antenna Factor (dB/m)	PRM Factor dB	Cable Loss dB	Result Level (dBμV/m)	Limit Line (dBμV/m)	Over Limit (dB)	Detector	Polarization
1	5725.00	37.05	34.84	29.22	9.41	52.08	74.00	-21.92	Peak	HORIZONTAL
2	5738.00	33.05	34.85	29.21	9.43	48.12	74.00	-25.88	Peak	HORIZONTAL

- Note: 1. Result Level = Read Level + Antenna Factor + Cable loss - PRM Factor.
 2. If Peak Result complies with AV limit, AV Result is deemed to comply with AV limit.
 3. Test setup: RBW: 1 MHz, VBW: 3 MHz, Sweep time: auto.

TR-4-E-009 Radiated Emission Test Result

Test Site : DDT 3m Chamber 1# D:\2017 RE1# Report Data\17Q0626-5\RF FCC 5 G WIFI 边带.EM6
Test Date : 2017-07-23 **Tested By** : Jerry
EUT : Streaming Wireless Adaptor **Model Number** : ADAPT+
Power Supply : DC 5V from Adapter **Test Mode** : TX mode
Condition : Temp:24.5'C,Humi:55%,
 Press:100.1kPa **Antenna/Distance** : 2016 HF907/3m/HORIZONTAL
Memo : 11ac 20 5745MHz

Data: 13

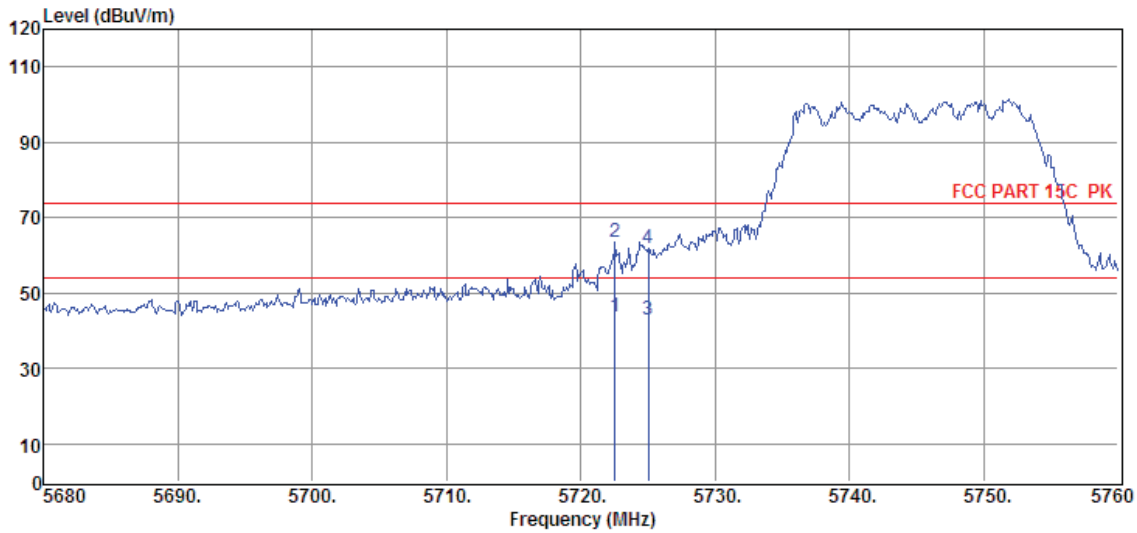

Item (Mark)	Freq. (MHz)	Read Level (dBμV)	Antenna Factor (dB/m)	PRM Factor dB	Cable Loss dB	Result Level (dBμV/m)	Limit Line (dBμV/m)	Over Limit (dB)	Detector	Polarization
1	5722.56	28.70	34.84	29.22	9.41	43.73	54.00	-10.27	Average	HORIZONTAL
2	5722.56	48.67	34.84	29.22	9.41	63.70	74.00	-10.30	Peak	HORIZONTAL
3	5725.00	27.75	34.84	29.22	9.41	42.78	54.00	-11.22	Average	HORIZONTAL
4	5725.00	46.80	34.84	29.22	9.41	61.83	74.00	-12.17	Peak	HORIZONTAL

Note: 1. Result Level = Read Level + Antenna Factor + Cable loss - PRM Factor.
 2. If Peak Result complies with AV limit, AV Result is deemed to comply with AV limit.
 3. Test setup: RBW: 1 MHz, VBW: 3 MHz, Sweep time: auto.

TR-4-E-009 Radiated Emission Test Result

Test Site : DDT 3m Chamber 1# D:\2017 RE1# Report Data\17Q0626-5\RF FCC 5 G WIFI 边带.EM6
Test Date : 2017-07-23 **Tested By** : Jerry
EUT : Streaming Wireless Adaptor **Model Number** : ADAPT+
Power Supply : DC 5V from Adapter **Test Mode** : TX mode
Condition : Temp:24.5'C,Humi:55%,
 Press:100.1kPa **Antenna/Distance** : 2016 HF907/3m/VERTICAL
Memo : 11ac 20 5745MHz

Data: 14

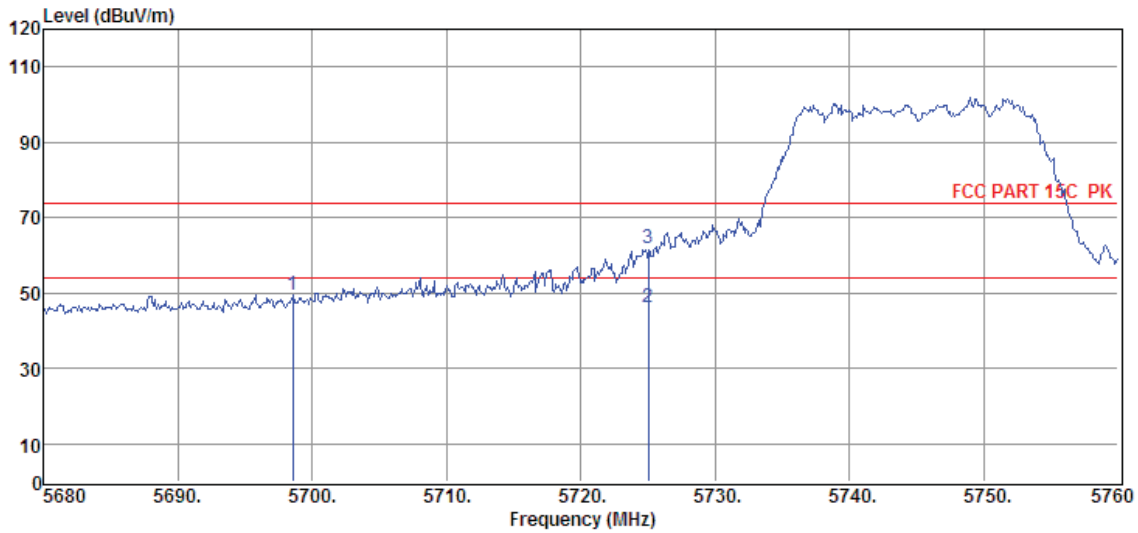

Item (Mark)	Freq. (MHz)	Read Level (dBμV)	Antenna Factor (dB/m)	PRM Factor dB	Cable Loss dB	Result Level (dBμV/m)	Limit Line (dBμV/m)	Over Limit (dB)	Detector	Polarization
1	5698.56	34.52	34.82	29.22	9.38	49.50	74.00	-24.50	Peak	VERTICAL
2	5725.00	31.36	34.84	29.22	9.41	46.39	54.00	-7.61	Average	VERTICAL
3	5725.00	46.71	34.84	29.22	9.41	61.74	74.00	-12.26	Peak	VERTICAL

- Note: 1. Result Level = Read Level + Antenna Factor + Cable loss - PRM Factor.
 2. If Peak Result complies with AV limit, AV Result is deemed to comply with AV limit.
 3. Test setup: RBW: 1 MHz, VBW: 3 MHz, Sweep time: auto.

TR-4-E-009 Radiated Emission Test Result

Test Site : DDT 3m Chamber 1#
Test Date : 2017-07-23
EUT : Streaming Wireless Adaptor
Power Supply : DC 5V from Adapter
Condition : Temp:24.5°C,Humi:55%,
 Press:100.1kPa
Memo : 11ac 20 5825MHz

D:\2017 RE1# Report Data\17Q0626-5\RF FCC 5 G WIFI 边
 带.EM6
Tested By : Jerry
Model Number : ADAPT+
Test Mode : TX mode
Antenna/Distance : 2016 HF907/3m/VERTICAL

Data: 15

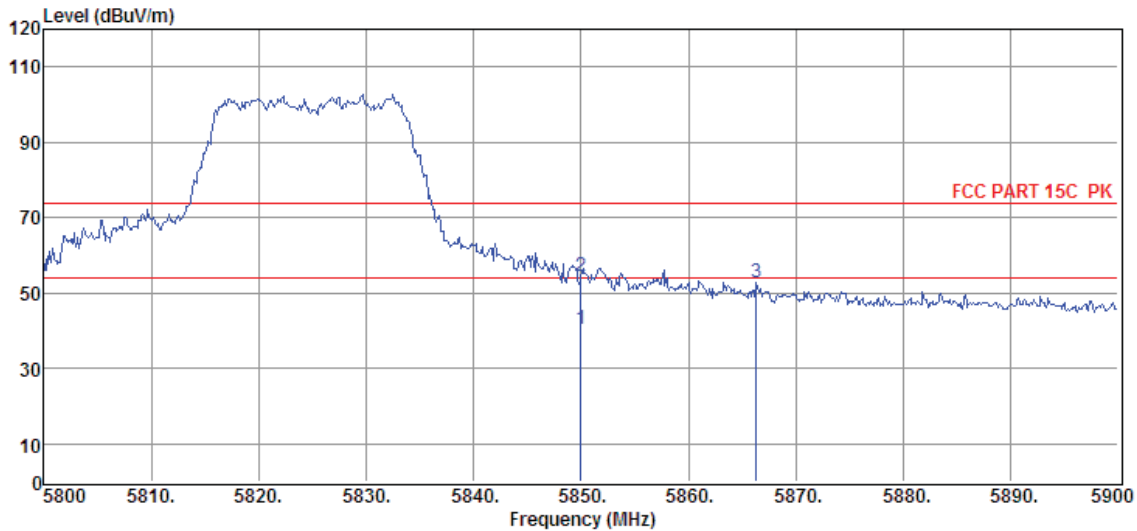

Item (Mark)	Freq. (MHz)	Read Level (dB μ V)	Antenna Factor (dB/m)	PRM Factor dB	Cable Loss dB	Result Level (dB μ V/m)	Limit Line (dB μ V/m)	Over Limit (dB)	Detector	Polarization
1	5850.00	25.22	34.91	29.20	9.54	40.47	54.00	-13.53	Average	VERTICAL
2	5850.00	39.10	34.91	29.20	9.54	54.35	74.00	-19.65	Peak	VERTICAL
3	5866.30	37.44	34.92	29.20	9.56	52.72	74.00	-21.28	Peak	VERTICAL

Note: 1. Result Level = Read Level + Antenna Factor + Cable loss - PRM Factor.

2. If Peak Result complies with AV limit, AV Result is deemed to comply with AV limit.

3. Test setup: RBW: 1 MHz, VBW: 3 MHz, Sweep time: auto.

TR-4-E-009 Radiated Emission Test Result

Test Site : DDT 3m Chamber 1#
Test Date : 2017-07-23
EUT : Streaming Wireless Adaptor
Power Supply : DC 5V from Adapter
Condition : Temp:24.5'C,Humi:55%,
 Press:100.1kPa
Memo : 11ac 20 5825MHz

D:\2017 RE1# Report Data\17Q0626-5\RF FCC 5 G WIFI 边带.EM6
Tested By : Jerry
Model Number : ADAPT+
Test Mode : TX mode
Antenna/Distance : 2016 HF907/3m/HORIZONTAL

Data: 16

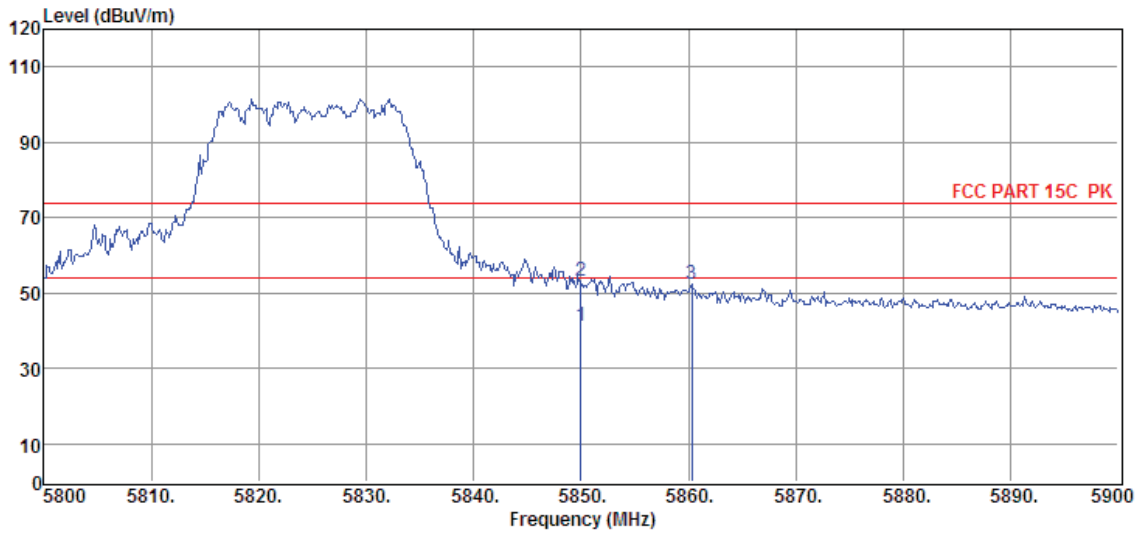

Item (Mark)	Freq. (MHz)	Read Level (dBμV)	Antenna Factor (dB/m)	PRM Factor (dB)	Cable Loss (dB)	Result Level (dBμV/m)	Limit Line (dBμV/m)	Over Limit (dB)	Detector	Polarization
1	5850.00	26.10	34.91	29.20	9.54	41.35	54.00	-12.65	Average	HORIZONTAL
2	5850.00	37.90	34.91	29.20	9.54	53.15	74.00	-20.85	Peak	HORIZONTAL
3	5860.30	37.19	34.92	29.20	9.54	52.45	74.00	-21.55	Peak	HORIZONTAL

Note: 1. Result Level = Read Level + Antenna Factor + Cable loss - PRM Factor.

2. If Peak Result complies with AV limit, AV Result is deemed to comply with AV limit.

3. Test setup: RBW: 1 MHz, VBW: 3 MHz, Sweep time: auto.

TR-4-E-009 Radiated Emission Test Result

Test Site : DDT 3m Chamber 1# D:\2017 RE1# Report Data\17Q0626-5\RF FCC 5 G WIFI 边带.EM6
Test Date : 2017-07-23 **Tested By** : Jerry
EUT : Streaming Wireless Adaptor **Model Number** : ADAPT+
Power Supply : DC 5V from Adapter **Test Mode** : TX mode
Condition : Temp:24.5'C,Humi:55%,
 Press:100.1kPa **Antenna/Distance** : 2016 HF907/3m/HORIZONTAL
Memo : 11ac 40 5190MHz

Data: 17

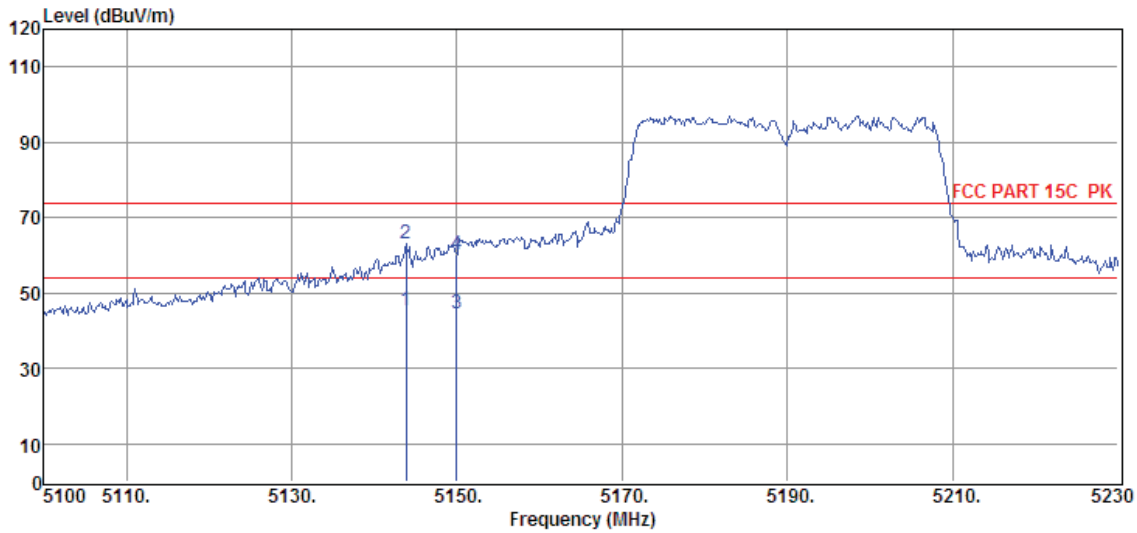

Item (Mark)	Freq. (MHz)	Read Level (dBμV)	Antenna Factor (dB/m)	PRM Factor dB	Cable Loss dB	Result Level (dBμV/m)	Limit Line (dBμV/m)	Over Limit (dB)	Detector	Polarization
1	5143.81	31.74	34.00	29.33	8.84	45.25	54.00	-8.75	Average	HORIZONTAL
2	5143.81	49.77	34.00	29.33	8.84	63.28	74.00	-10.72	Peak	HORIZONTAL
3	5150.00	31.22	34.01	29.33	8.84	44.74	54.00	-9.26	Average	HORIZONTAL
4	5150.00	46.85	34.01	29.33	8.84	60.37	74.00	-13.63	Peak	HORIZONTAL

Note: 1. Result Level = Read Level + Antenna Factor + Cable loss - PRM Factor.
 2. If Peak Result complies with AV limit, AV Result is deemed to comply with AV limit.
 3. Test setup: RBW: 1 MHz, VBW: 3 MHz, Sweep time: auto.

TR-4-E-009 Radiated Emission Test Result

Test Site : DDT 3m Chamber 1#
Test Date : 2017-07-23
EUT : Streaming Wireless Adaptor
Power Supply : DC 5V from Adapter
Condition : Temp:24.5'C,Humi:55%,
 Press:100.1kPa
Memo : 11ac 40 5190MHz

D:\2017 RE1# Report Data\17Q0626-5\RF FCC 5 G WIFI 边
 带.EM6
Tested By : Jerry
Model Number : ADAPT+
Test Mode : TX mode
Antenna/Distance : 2016 HF907/3m/VERTICAL

Data: 18

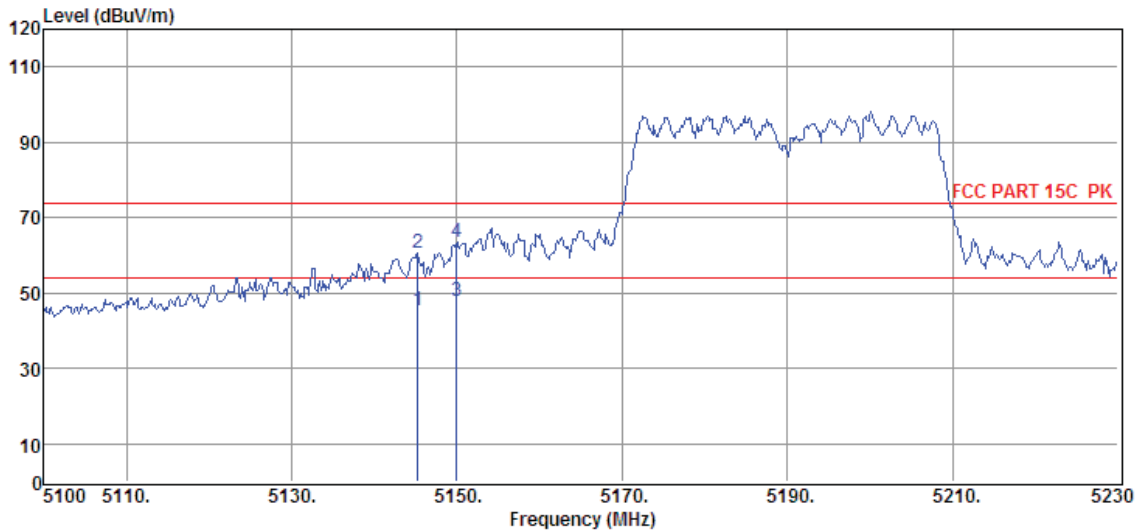

Item (Mark)	Freq. (MHz)	Read Level (dBμV)	Antenna Factor (dB/m)	PRM Factor dB	Cable Loss dB	Result Level (dBμV/m)	Limit Line (dBμV/m)	Over Limit (dB)	Detector	Polarization
1	5145.24	32.00	34.00	29.33	8.84	45.51	54.00	-8.49	Average	VERTICAL
2	5145.24	46.93	34.00	29.33	8.84	60.44	74.00	-13.56	Peak	VERTICAL
3	5150.00	34.20	34.01	29.33	8.84	47.72	54.00	-6.28	Average	VERTICAL
4	5150.00	50.11	34.01	29.33	8.84	63.63	74.00	-10.37	Peak	VERTICAL

- Note: 1. Result Level = Read Level + Antenna Factor + Cable loss - PRM Factor.
 2. If Peak Result complies with AV limit, AV Result is deemed to comply with AV limit.
 3. Test setup: RBW: 1 MHz, VBW: 3 MHz, Sweep time: auto.

TR-4-E-009 Radiated Emission Test Result

Test Site	: DDT 3m Chamber 1#	D:\2017 RE1# Report Data\17Q0626-5\RF FCC 5 G WIFI 边带.EM6
Test Date	: 2017-07-23	Tested By : Jerry
EUT	: Streaming Wireless Adaptor	Model Number : ADAPT+
Power Supply	: DC 5V from Adapter	Test Mode : TX mode
Condition	: Temp:24.5°C,Humi:55%, Press:100.1kPa	Antenna/Distance : 2016 HF907/3m/VERTICAL
Memo	: 11ac 40 5230MHz	

Data: 19

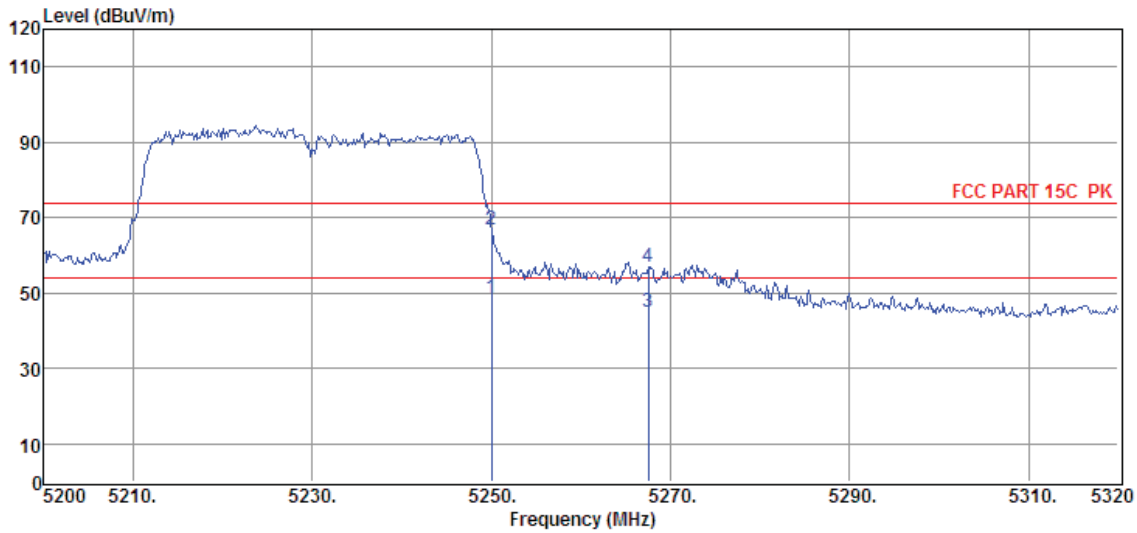

Item (Mark)	Freq. (MHz)	Read Level (dBμV)	Antenna Factor (dB/m)	PRM Factor dB	Cable Loss dB	Result Level (dBμV/m)	Limit Line (dBμV/m)	Over Limit (dB)	Detector	Polarization
1	5250.00	34.96	34.21	29.32	8.93	48.78	54.00	-5.22	Average	VERTICAL
2	5250.00	52.92	34.21	29.32	8.93	66.74	74.00	-7.26	Peak	VERTICAL
3	5267.56	31.23	34.25	29.32	8.96	45.12	54.00	-8.88	Average	VERTICAL
4	5267.56	43.18	34.25	29.32	8.96	57.07	74.00	-16.93	Peak	VERTICAL

- Note: 1. Result Level = Read Level + Antenna Factor + Cable loss - PRM Factor.
 2. If Peak Result complies with AV limit, AV Result is deemed to comply with AV limit.
 3. Test setup: RBW: 1 MHz, VBW: 3 MHz, Sweep time: auto.

TR-4-E-009 Radiated Emission Test Result

Test Site : DDT 3m Chamber 1# D:\2017 RE1# Report Data\17Q0626-5\RF FCC 5 G WIFI 边带.EM6
Test Date : 2017-07-23 **Tested By** : Jerry
EUT : Streaming Wireless Adaptor **Model Number** : ADAPT+
Power Supply : DC 5V from Adapter **Test Mode** : TX mode
Condition : Temp:24.5'C,Humi:55%,
 Press:100.1kPa **Antenna/Distance** : 2016 HF907/3m/HORIZONTAL
Memo : 11ac 40 5230MHz

Data: 20

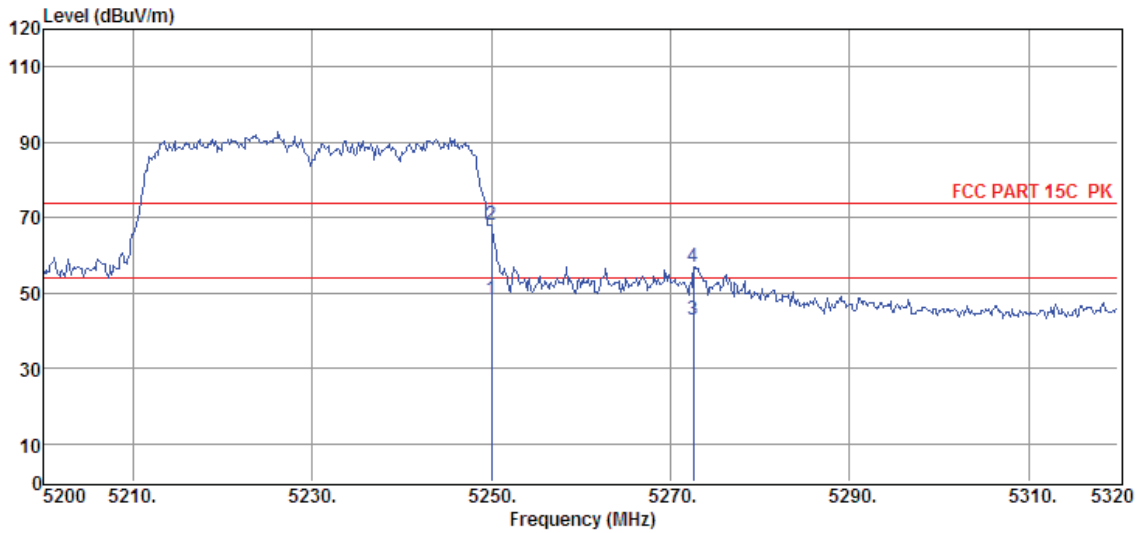

Item (Mark)	Freq. (MHz)	Read Level (dBμV)	Antenna Factor (dB/m)	PRM Factor dB	Cable Loss dB	Result Level (dBμV/m)	Limit Line (dBμV/m)	Over Limit (dB)	Detector	Polarization
1	5250.00	34.60	34.21	29.32	8.93	48.42	54.00	-5.58	Average	HORIZONTAL
2	5250.00	54.43	34.21	29.32	8.93	68.25	74.00	-5.75	Peak	HORIZONTAL
3	5272.60	28.79	34.26	29.32	8.96	42.69	54.00	-11.31	Average	HORIZONTAL
4	5272.60	42.85	34.26	29.32	8.96	56.75	74.00	-17.25	Peak	HORIZONTAL

Note: 1. Result Level = Read Level + Antenna Factor + Cable loss - PRM Factor.
 2. If Peak Result complies with AV limit, AV Result is deemed to comply with AV limit.
 3. Test setup: RBW: 1 MHz, VBW: 3 MHz, Sweep time: auto.

TR-4-E-009 Radiated Emission Test Result

Test Site : DDT 3m Chamber 1#
Test Date : 2017-07-23
EUT : Streaming Wireless Adaptor
Power Supply : DC 5V from Adapter
Condition : Temp:24.5'C,Humi:55%,
 Press:100.1kPa
Memo : 11ac 40 5270MHz

D:\2017 RE1# Report Data\17Q0626-5\RF FCC 5 G WIFI 边
 带.EM6
Tested By : Jerry
Model Number : ADAPT+
Test Mode : TX mode
Antenna/Distance : 2016 HF907/3m/HORIZONTAL

Data: 21

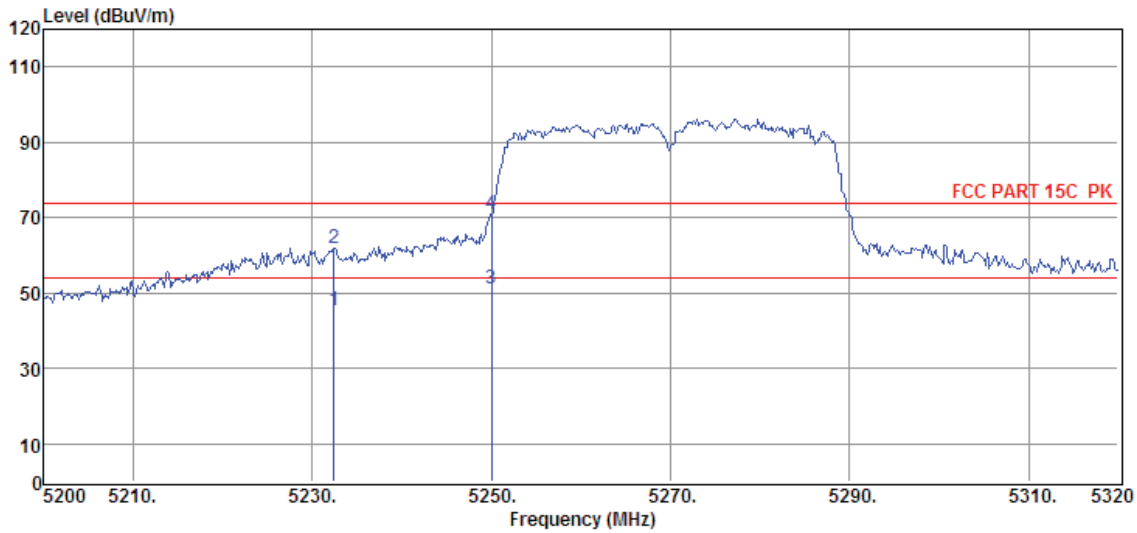

Item (Mark)	Freq. (MHz)	Read Level (dBμV)	Antenna Factor (dB/m)	PRM Factor dB	Cable Loss dB	Result Level (dBμV/m)	Limit Line (dBμV/m)	Over Limit (dB)	Detector	Polarization
1	5232.40	31.55	34.18	29.32	8.91	45.32	54.00	-8.68	Average	HORIZONTAL
2	5232.40	48.22	34.18	29.32	8.91	61.99	74.00	-12.01	Peak	HORIZONTAL
3	5250.00	37.12	34.21	29.32	8.93	50.94	54.00	-3.06	Average	HORIZONTAL
4	5250.00	56.93	34.21	29.32	8.93	70.75	74.00	-3.25	Peak	HORIZONTAL

Note: 1. Result Level = Read Level + Antenna Factor + Cable loss - PRM Factor.
 2. If Peak Result complies with AV limit, AV Result is deemed to comply with AV limit.
 3. Test setup: RBW: 1 MHz, VBW: 3 MHz, Sweep time: auto.

TR-4-E-009 Radiated Emission Test Result

Test Site : DDT 3m Chamber 1#
Test Date : 2017-07-23
EUT : Streaming Wireless Adaptor
Power Supply : DC 5V from Adapter
Condition : Temp:24.5'C,Humi:55%,
 Press:100.1kPa
Memo : 11ac 40 5270MHz

D:\2017 RE1# Report Data\17Q0626-5\RF FCC 5 G WIFI 边
 带.EM6
Tested By : Jerry
Model Number : ADAPT+
Test Mode : TX mode
Antenna/Distance : 2016 HF907/3m/VERTICAL

Data: 22

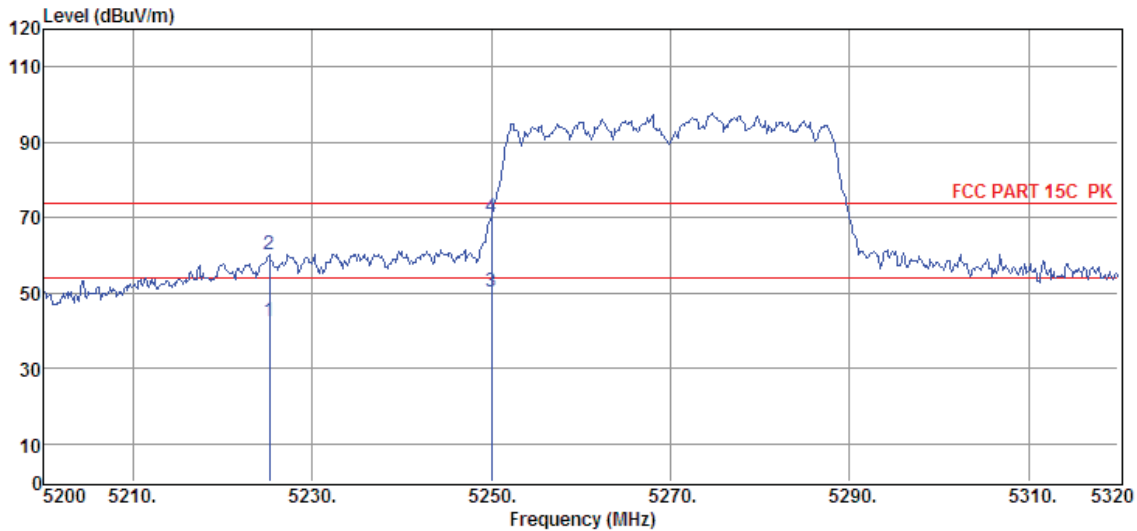

Item (Mark)	Freq. (MHz)	Read Level (dBμV)	Antenna Factor (dB/m)	PRM Factor dB	Cable Loss dB	Result Level (dBμV/m)	Limit Line (dBμV/m)	Over Limit (dB)	Detector	Polarization
1	5225.20	28.71	34.16	29.32	8.91	42.46	54.00	-11.54	Average	VERTICAL
2	5225.20	46.65	34.16	29.32	8.91	60.40	74.00	-13.60	Peak	VERTICAL
3	5250.00	36.52	34.21	29.32	8.93	50.34	54.00	-3.66	Average	VERTICAL
4	5250.00	56.47	34.21	29.32	8.93	70.29	74.00	-3.71	Peak	VERTICAL

- Note: 1. Result Level = Read Level + Antenna Factor + Cable loss - PRM Factor.
 2. If Peak Result complies with AV limit, AV Result is deemed to comply with AV limit.
 3. Test setup: RBW: 1 MHz, VBW: 3 MHz, Sweep time: auto.

TR-4-E-009 Radiated Emission Test Result

Test Site : DDT 3m Chamber 1#
Test Date : 2017-07-23
EUT : Streaming Wireless Adaptor
Power Supply : DC 5V from Adapter
Condition : Temp:24.5'C,Humi:55%,
 Press:100.1kPa
Memo : 11ac 40 5310MHz

D:\2017 RE1# Report Data\17Q0626-5\RF FCC 5 G WIFI 边
 带.EM6
Tested By : Jerry
Model Number : ADAPT+
Test Mode : TX mode
Antenna/Distance : 2016 HF907/3m/VERTICAL

Data: 23

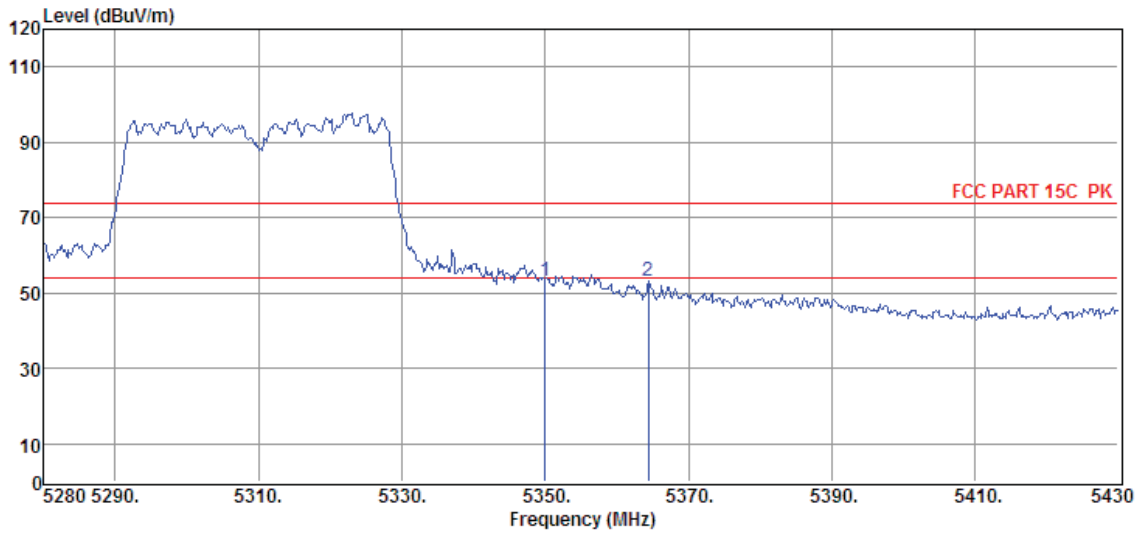

Item (Mark)	Freq. (MHz)	Read Level (dB μ V)	Antenna Factor (dB/m)	PRM Factor dB	Cable Loss dB	Result Level (dB μ V/m)	Limit Line (dB μ V/m)	Over Limit (dB)	Detector	Polarization
1	5350.05	38.89	34.41	29.30	9.03	53.03	74.00	-20.97	Peak	VERTICAL
2	5364.45	38.81	34.44	29.30	9.05	53.00	74.00	-21.00	Peak	VERTICAL

- Note: 1. Result Level = Read Level + Antenna Factor + Cable loss - PRM Factor.
 2. If Peak Result complies with AV limit, AV Result is deemed to comply with AV limit.
 3. Test setup: RBW: 1 MHz, VBW: 3 MHz, Sweep time: auto.

TR-4-E-009 Radiated Emission Test Result

Test Site : DDT 3m Chamber 1# D:\2017 RE1# Report Data\17Q0626-5\RF FCC 5 G WIFI 边带.EM6
Test Date : 2017-07-23 **Tested By** : Jerry
EUT : Streaming Wireless Adaptor **Model Number** : ADAPT+
Power Supply : DC 5V from Adapter **Test Mode** : TX mode
Condition : Temp:24.5°C,Humi:55%,
 Press:100.1kPa **Antenna/Distance** : 2016 HF907/3m/HORIZONTAL
Memo : 11ac 40 5310MHz

Data: 24

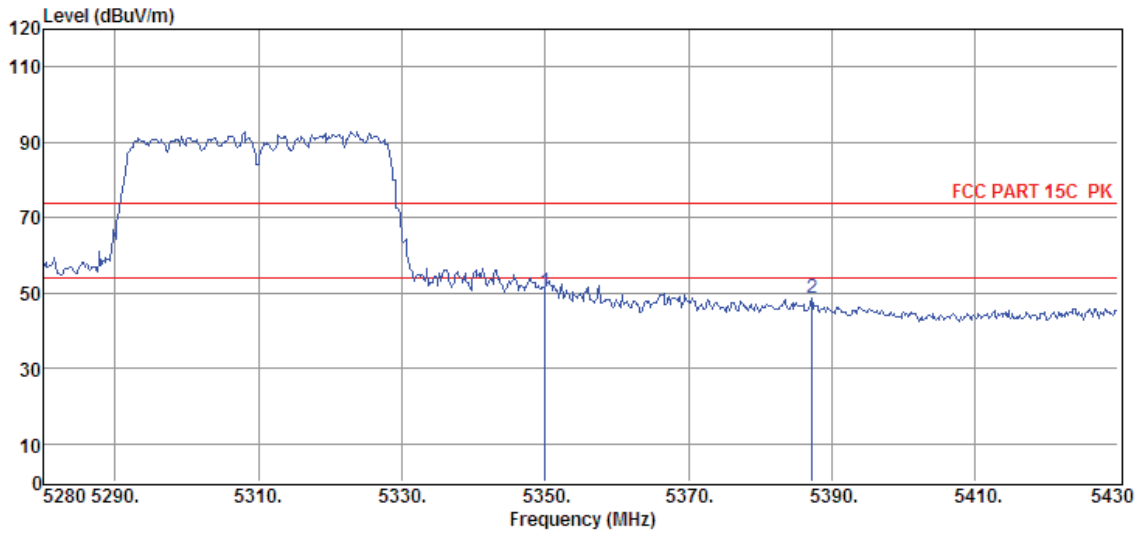

Item (Mark)	Freq. (MHz)	Read Level (dBμV)	Antenna Factor (dB/m)	PRM Factor (dB)	Cable Loss (dB)	Result Level (dBμV/m)	Limit Line (dBμV/m)	Over Limit (dB)	Detector	Polarization
1	5350.05	36.18	34.41	29.30	9.03	50.32	74.00	-23.68	Peak	HORIZONTAL
2	5387.25	34.37	34.48	29.30	9.09	48.64	74.00	-25.36	Peak	HORIZONTAL

- Note: 1. Result Level = Read Level + Antenna Factor + Cable loss - PRM Factor.
 2. If Peak Result complies with AV limit, AV Result is deemed to comply with AV limit.
 3. Test setup: RBW: 1 MHz, VBW: 3 MHz, Sweep time: auto.

TR-4-E-009 Radiated Emission Test Result

Test Site : DDT 3m Chamber 1# D:\2017 RE1# Report Data\17Q0626-5\RF FCC 5 G WIFI 边带.EM6
Test Date : 2017-07-23 **Tested By** : Jerry
EUT : Streaming Wireless Adaptor **Model Number** : ADAPT+
Power Supply : DC 5V from Adapter **Test Mode** : TX mode
Condition : Temp:24.5°C,Humi:55%,
 Press:100.1kPa **Antenna/Distance** : 2016 HF907/3m/HORIZONTAL
Memo : 11ac 40 5510MHz

Data: 25

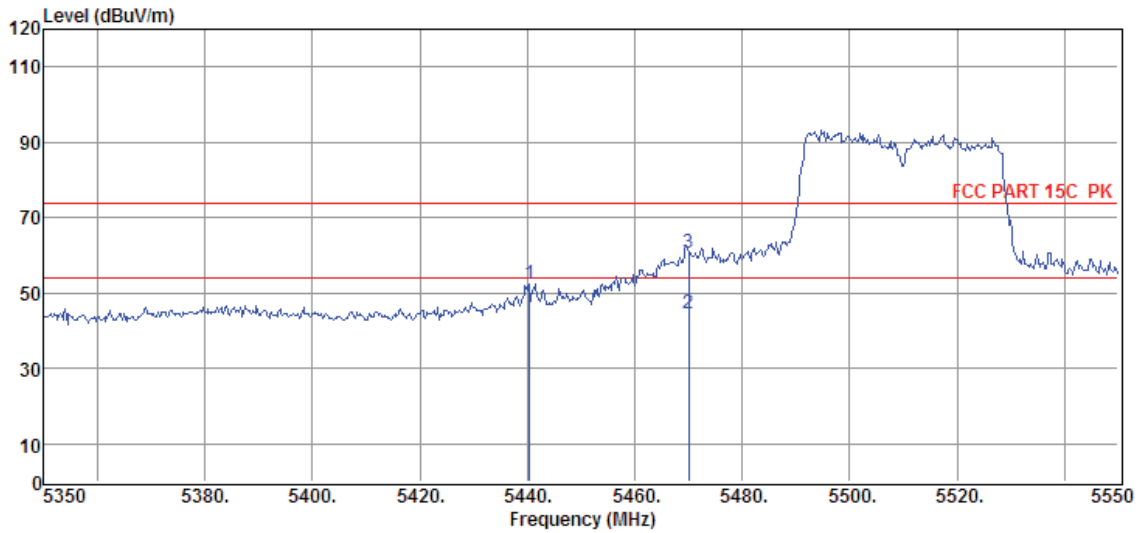

Item (Mark)	Freq. (MHz)	Read Level (dBμV)	Antenna Factor (dB/m)	PRM Factor (dB)	Cable Loss (dB)	Result Level (dBμV/m)	Limit Line (dBμV/m)	Over Limit (dB)	Detector	Polarization
1	5440.40	37.99	34.59	29.28	9.14	52.44	74.00	-21.56	Peak	HORIZONTAL
2	5470.00	30.13	34.64	29.27	9.16	44.66	54.00	-9.34	Average	HORIZONTAL
3	5470.00	46.09	34.64	29.27	9.16	60.62	74.00	-13.38	Peak	HORIZONTAL

- Note: 1. Result Level = Read Level + Antenna Factor + Cable loss - PRM Factor.
 2. If Peak Result complies with AV limit, AV Result is deemed to comply with AV limit.
 3. Test setup: RBW: 1 MHz, VBW: 3 MHz, Sweep time: auto.

TR-4-E-009 Radiated Emission Test Result

Test Site : DDT 3m Chamber 1#
Test Date : 2017-07-23
EUT : Streaming Wireless Adaptor
Power Supply : DC 5V from Adapter
Condition : Temp:24.5'C,Humi:55%,
 Press:100.1kPa
Memo : 11ac 40 5510MHz

D:\2017 RE1# Report Data\17Q0626-5\RF FCC 5 G WIFI 边
 带.EM6
Tested By : Jerry
Model Number : ADAPT+
Test Mode : TX mode
Antenna/Distance : 2016 HF907/3m/VERTICAL

Data: 26

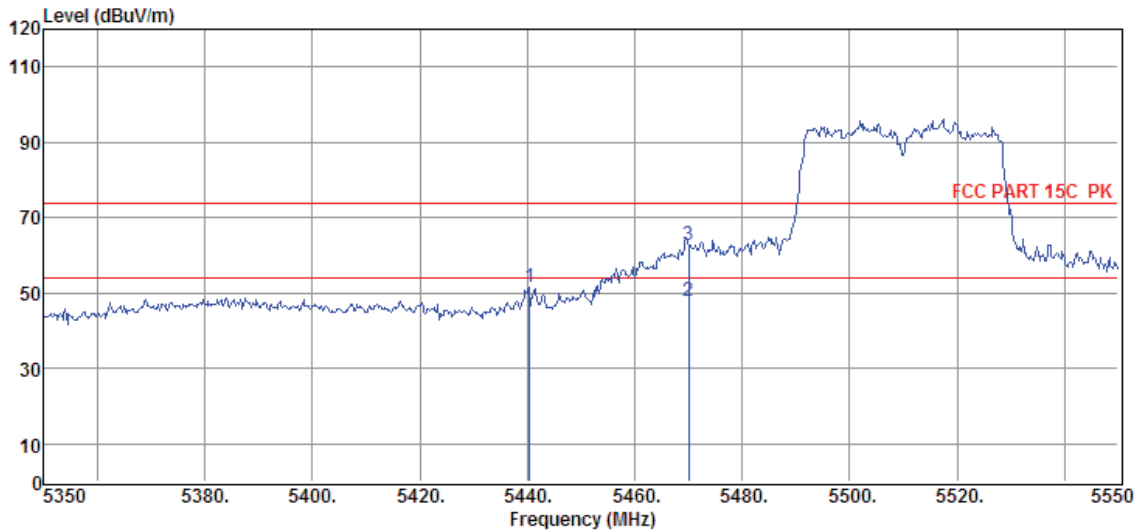

Item (Mark)	Freq. (MHz)	Read Level (dBμV)	Antenna Factor (dB/m)	PRM Factor dB	Cable Loss dB	Result Level (dBμV/m)	Limit Line (dBμV/m)	Over Limit (dB)	Detector	Polarization
1	5440.40	36.99	34.59	29.28	9.14	51.44	74.00	-22.56	Peak	VERTICAL
2	5470.00	33.15	34.64	29.27	9.16	47.68	54.00	-6.32	Average	VERTICAL
3	5470.00	48.09	34.64	29.27	9.16	62.62	74.00	-11.38	Peak	VERTICAL

- Note: 1. Result Level = Read Level + Antenna Factor + Cable loss - PRM Factor.
 2. If Peak Result complies with AV limit, AV Result is deemed to comply with AV limit.
 3. Test setup: RBW: 1 MHz, VBW: 3 MHz, Sweep time: auto.

TR-4-E-009 Radiated Emission Test Result

Test Site : DDT 3m Chamber 1# D:\2017 RE1# Report Data\17Q0626-5\RF FCC 5 G WIFI 边带.EM6
Test Date : 2017-07-23 **Tested By** : Jerry
EUT : Streaming Wireless Adaptor **Model Number** : ADAPT+
Power Supply : DC 5V from Adapter **Test Mode** : TX mode
Condition : Temp:24.5'C,Humi:55%,
 Press:100.1kPa **Antenna/Distance** : 2016 HF907/3m/VERTICAL
Memo : 11ac 40 5670MHz

Data: 27

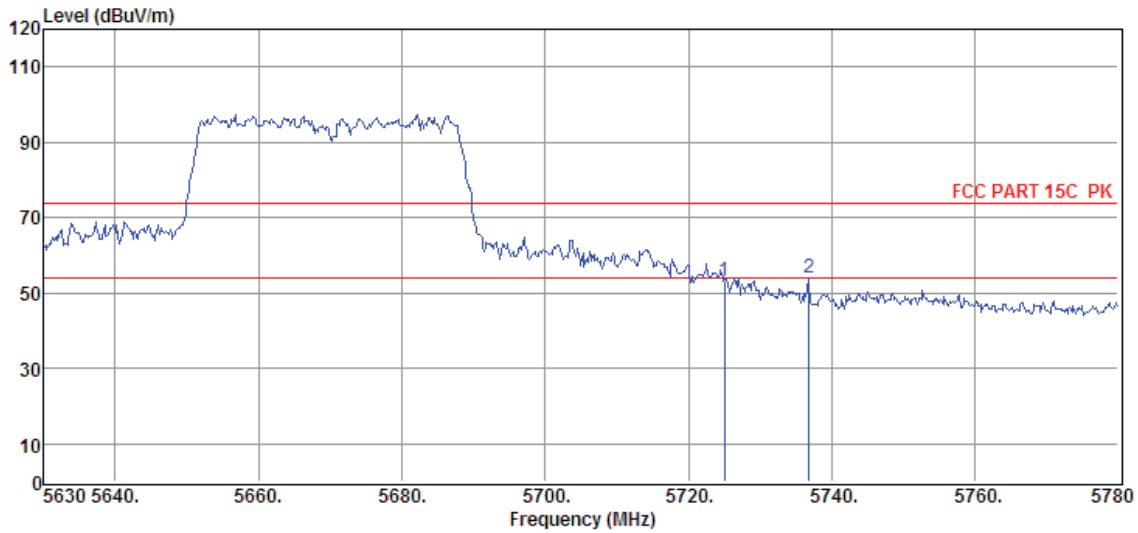

Item (Mark)	Freq. (MHz)	Read Level (dBμV)	Antenna Factor (dB/m)	PRM Factor (dB)	Cable Loss (dB)	Result Level (dBμV/m)	Limit Line (dBμV/m)	Over Limit (dB)	Detector	Polarization
1	5725.00	38.31	34.84	29.22	9.41	53.34	74.00	-20.66	Peak	VERTICAL
2	5736.80	38.80	34.85	29.21	9.43	53.87	74.00	-20.13	Peak	VERTICAL

- Note: 1. Result Level = Read Level + Antenna Factor + Cable loss - PRM Factor.
 2. If Peak Result complies with AV limit, AV Result is deemed to comply with AV limit.
 3. Test setup: RBW: 1 MHz, VBW: 3 MHz, Sweep time: auto.

TR-4-E-009 Radiated Emission Test Result

Test Site : DDT 3m Chamber 1# D:\2017 RE1# Report Data\17Q0626-5\RF FCC 5 G WIFI 边带.EM6
Test Date : 2017-07-23 **Tested By** : Jerry
EUT : Streaming Wireless Adaptor **Model Number** : ADAPT+
Power Supply : DC 5V from Adapter **Test Mode** : TX mode
Condition : Temp:24.5°C,Humi:55%,
 Press:100.1kPa **Antenna/Distance** : 2016 HF907/3m/HORIZONTAL
Memo : 11ac 40 5670MHz

Data: 28

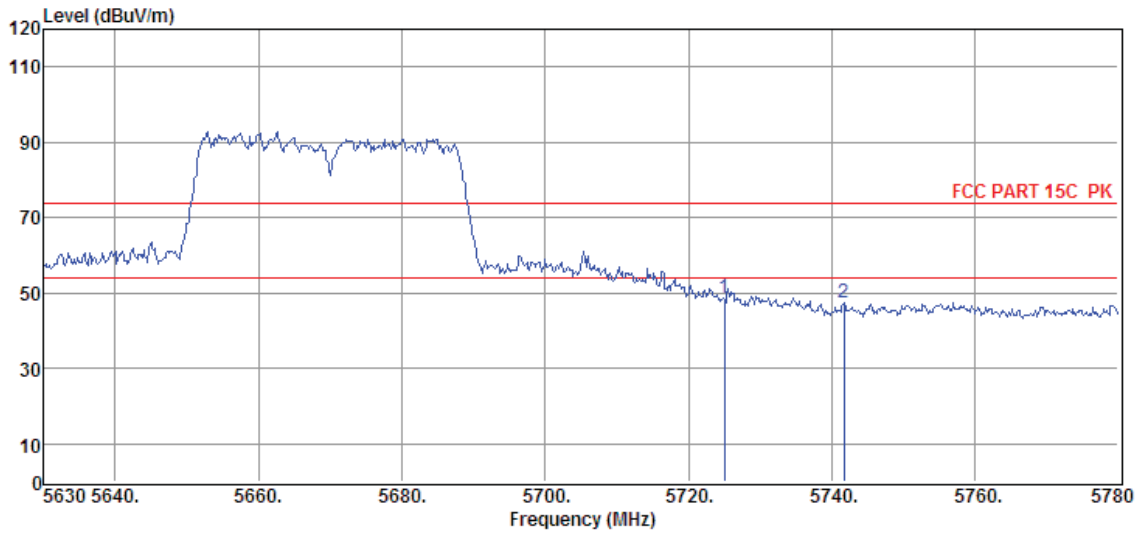

Item (Mark)	Freq. (MHz)	Read Level (dBμV)	Antenna Factor (dB/m)	PRM Factor (dB)	Cable Loss (dB)	Result Level (dBμV/m)	Limit Line (dBμV/m)	Over Limit (dB)	Detector	Polarization
1	5725.00	33.65	34.84	29.22	9.41	48.68	74.00	-25.32	Peak	HORIZONTAL
2	5741.75	32.31	34.85	29.21	9.43	47.38	74.00	-26.62	Peak	HORIZONTAL

- Note: 1. Result Level = Read Level + Antenna Factor + Cable loss - PRM Factor.
 2. If Peak Result complies with AV limit, AV Result is deemed to comply with AV limit.
 3. Test setup: RBW: 1 MHz, VBW: 3 MHz, Sweep time: auto.

TR-4-E-009 Radiated Emission Test Result

Test Site : DDT 3m Chamber 1# D:\2017 RE1# Report Data\17Q0626-5\RF FCC 5 G WIFI 边带.EM6
Test Date : 2017-07-23 **Tested By** : Jerry
EUT : Streaming Wireless Adaptor **Model Number** : ADAPT+
Power Supply : DC 5V from Adapter **Test Mode** : TX mode
Condition : Temp:24.5'C,Humi:55%,
 Press:100.1kPa **Antenna/Distance** : 2016 HF907/3m/HORIZONTAL
Memo : 11ac 40 5755MHz

Data: 29

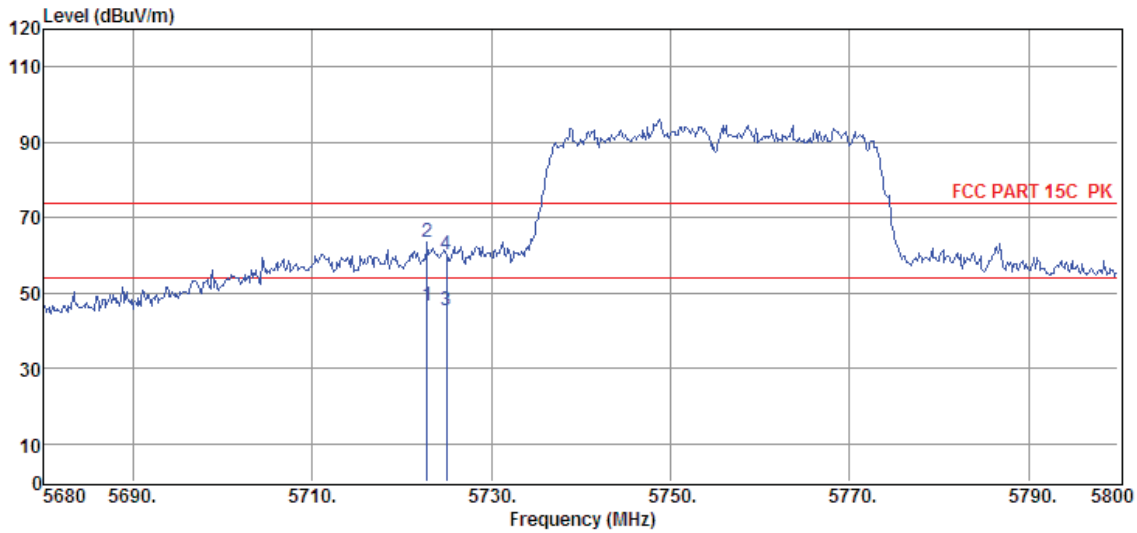

Item (Mark)	Freq. (MHz)	Read Level (dBμV)	Antenna Factor (dB/m)	PRM Factor dB	Cable Loss dB	Result Level (dBμV/m)	Limit Line (dBμV/m)	Over Limit (dB)	Detector	Polarization
1	5722.84	31.56	34.84	29.22	9.41	46.59	54.00	-7.41	Average	HORIZONTAL
2	5722.84	48.48	34.84	29.22	9.41	63.51	74.00	-10.49	Peak	HORIZONTAL
3	5725.00	30.51	34.84	29.22	9.41	45.54	54.00	-8.46	Average	HORIZONTAL
4	5725.00	45.31	34.84	29.22	9.41	60.34	74.00	-13.66	Peak	HORIZONTAL

Note: 1. Result Level = Read Level + Antenna Factor + Cable loss - PRM Factor.
 2. If Peak Result complies with AV limit, AV Result is deemed to comply with AV limit.
 3. Test setup: RBW: 1 MHz, VBW: 3 MHz, Sweep time: auto.

TR-4-E-009 Radiated Emission Test Result

Test Site : DDT 3m Chamber 1#
Test Date : 2017-07-23
EUT : Streaming Wireless Adaptor
Power Supply : DC 5V from Adapter
Condition : Temp:24.5'C,Humi:55%,
 Press:100.1kPa
Memo : 11ac 40 5755MHz

D:\2017 RE1# Report Data\17Q0626-5\RF FCC 5 G WIFI 边
 带.EM6
Tested By : Jerry
Model Number : ADAPT+
Test Mode : TX mode
Antenna/Distance : 2016 HF907/3m/VERTICAL

Data: 30

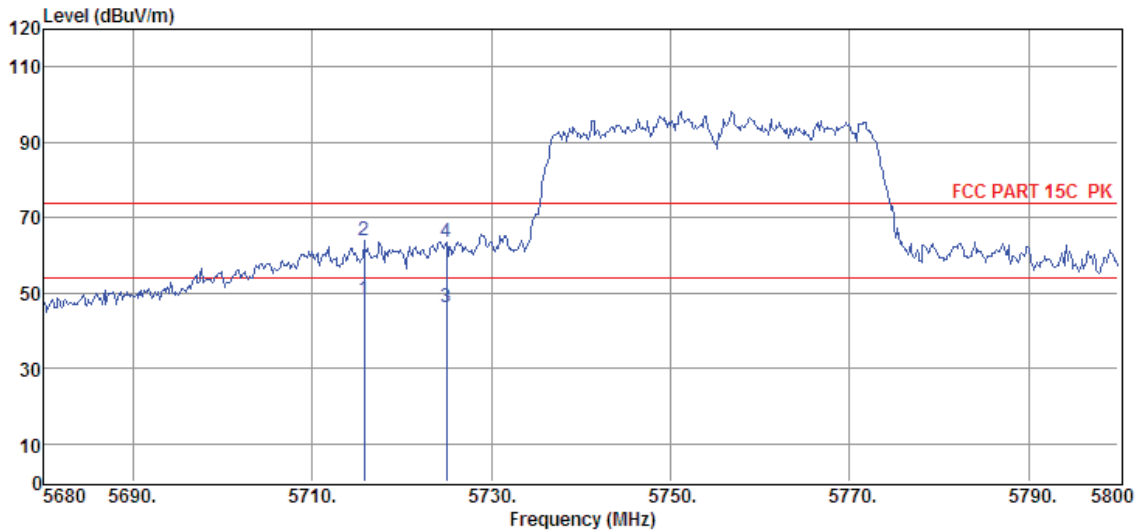

Item (Mark)	Freq. (MHz)	Read Level (dB μ V)	Antenna Factor (dB/m)	PRM Factor dB	Cable Loss dB	Result Level (dB μ V/m)	Limit Line (dB μ V/m)	Over Limit (dB)	Detector	Polarization
1	5715.76	33.03	34.83	29.22	9.41	48.05	54.00	-5.95	Average	VERTICAL
2	5715.76	48.95	34.83	29.22	9.41	63.97	74.00	-10.03	Peak	VERTICAL
3	5725.00	31.33	34.84	29.22	9.41	46.36	54.00	-7.64	Average	VERTICAL
4	5725.00	48.29	34.84	29.22	9.41	63.32	74.00	-10.68	Peak	VERTICAL

- Note: 1. Result Level = Read Level + Antenna Factor + Cable loss - PRM Factor.
 2. If Peak Result complies with AV limit, AV Result is deemed to comply with AV limit.
 3. Test setup: RBW: 1 MHz, VBW: 3 MHz, Sweep time: auto.

TR-4-E-009 Radiated Emission Test Result

Test Site : DDT 3m Chamber 1#
Test Date : 2017-07-23
EUT : Streaming Wireless Adaptor
Power Supply : DC 5V from Adapter
Condition : Temp:24.5'C,Humi:55%,
 Press:100.1kPa
Memo : 11ac 40 5795MHz

D:\2017 RE1# Report Data\17Q0626-5\RF FCC 5 G WIFI 边
 带.EM6
Tested By : Jerry
Model Number : ADAPT+
Test Mode : TX mode
Antenna/Distance : 2016 HF907/3m/VERTICAL

Data: 31

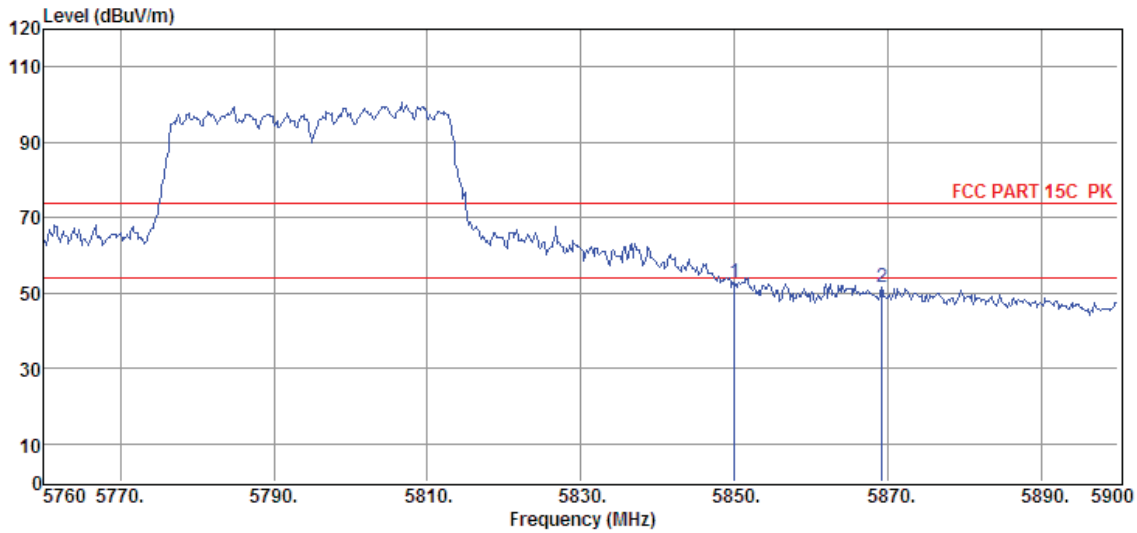

Item (Mark)	Freq. (MHz)	Read Level (dBμV)	Antenna Factor (dB/m)	PRM Factor dB	Cable Loss dB	Result Level (dBμV/m)	Limit Line (dBμV/m)	Over Limit (dB)	Detector	Polarization
1	5850.00	37.65	34.91	29.20	9.54	52.90	74.00	-21.10	Peak	VERTICAL
2	5869.20	36.27	34.92	29.20	9.56	51.55	74.00	-22.45	Peak	VERTICAL

- Note: 1. Result Level = Read Level + Antenna Factor + Cable loss - PRM Factor.
 2. If Peak Result complies with AV limit, AV Result is deemed to comply with AV limit.
 3. Test setup: RBW: 1 MHz, VBW: 3 MHz, Sweep time: auto.

TR-4-E-009 Radiated Emission Test Result

Test Site : DDT 3m Chamber 1# D:\2017 RE1# Report Data\17Q0626-5\RF FCC 5 G WIFI 边带.EM6
Test Date : 2017-07-23 **Tested By** : Jerry
EUT : Streaming Wireless Adaptor **Model Number** : ADAPT+
Power Supply : DC 5V from Adapter **Test Mode** : TX mode
Condition : Temp:24.5'C,Humi:55%,
 Press:100.1kPa **Antenna/Distance** : 2016 HF907/3m/HORIZONTAL
Memo : 11ac 40 5795MHz

Data: 32

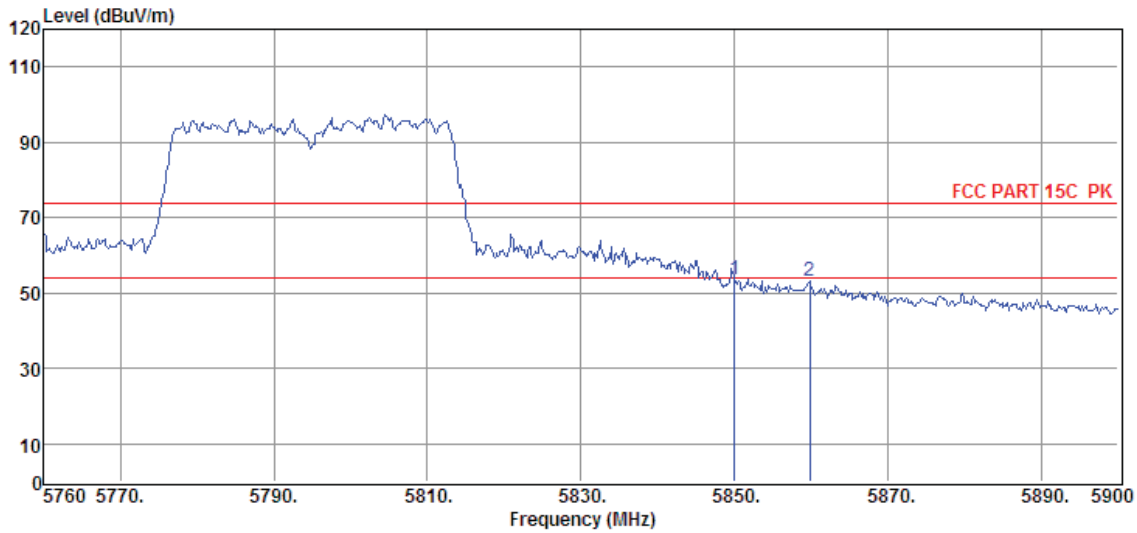

Item (Mark)	Freq. (MHz)	Read Level (dBμV)	Antenna Factor (dB/m)	PRM Factor dB	Cable Loss dB	Result Level (dBμV/m)	Limit Line (dBμV/m)	Over Limit (dB)	Detector	Polarization
1	5850.02	38.39	34.91	29.20	9.54	53.64	74.00	-20.36	Peak	HORIZONTAL
2	5859.82	37.86	34.92	29.20	9.54	53.12	74.00	-20.88	Peak	HORIZONTAL

- Note: 1. Result Level = Read Level + Antenna Factor + Cable loss - PRM Factor.
 2. If Peak Result complies with AV limit, AV Result is deemed to comply with AV limit.
 3. Test setup: RBW: 1 MHz, VBW: 3 MHz, Sweep time: auto.

TR-4-E-009 Radiated Emission Test Result

Test Site : DDT 3m Chamber 1#
Test Date : 2017-07-23
EUT : Streaming Wireless Adaptor
Power Supply : DC 5V from Adapter
Condition : Temp:24.5°C,Humi:55%,
 Press:100.1kPa
Memo : 11ac 80 5210MHz

D:\2017 RE1# Report Data\17Q0626-5\RF FCC 5 G WIFI 边
 带.EM6
Tested By : Jerry
Model Number : ADAPT+
Test Mode : TX mode
Antenna/Distance : 2016 HF907/3m/HORIZONTAL

Data: 33

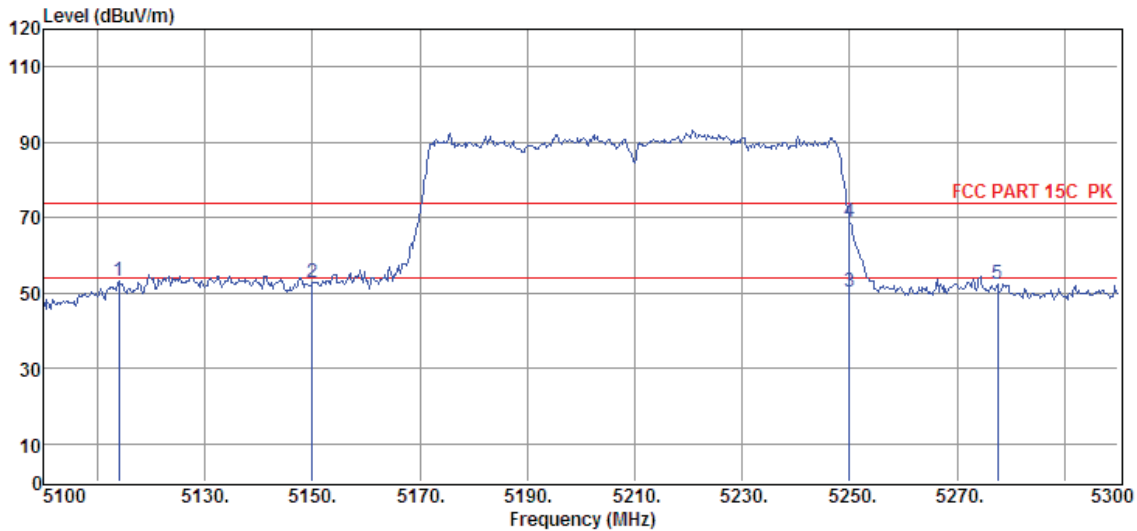

Item (Mark)	Freq. (MHz)	Read Level (dBμV)	Antenna Factor (dB/m)	PRM Factor (dB)	Cable Loss (dB)	Result Level (dBμV/m)	Limit Line (dBμV/m)	Over Limit (dB)	Detector	Polarization
1	5114.00	39.78	33.94	29.34	8.80	53.18	74.00	-20.82	Peak	HORIZONTAL
2	5150.00	39.45	34.01	29.33	8.84	52.97	74.00	-21.03	Peak	HORIZONTAL
3	5250.00	36.35	34.21	29.32	8.93	50.17	54.00	-3.83	Average	HORIZONTAL
4	5250.00	55.24	34.21	29.32	8.93	69.06	74.00	-4.94	Peak	HORIZONTAL
5	5277.60	38.43	34.27	29.31	8.96	52.35	74.00	-21.65	Peak	HORIZONTAL

- Note: 1. Result Level = Read Level + Antenna Factor + Cable loss - PRM Factor.
 2. If Peak Result complies with AV limit, AV Result is deemed to comply with AV limit.
 3. Test setup: RBW: 1 MHz, VBW: 3 MHz, Sweep time: auto.

TR-4-E-009 Radiated Emission Test Result

Test Site : DDT 3m Chamber 1#
Test Date : 2017-07-23
EUT : Streaming Wireless Adaptor
Power Supply : DC 5V from Adapter
Condition : Temp:24.5'C,Humi:55%,
 Press:100.1kPa
Memo : 11ac 80 5210MHz

D:\2017 RE1# Report Data\17Q0626-5\RF FCC 5 G WIFI 边带.EM6
Tested By : Jerry
Model Number : ADAPT+
Test Mode : TX mode
Antenna/Distance : 2016 HF907/3m/VERTICAL

Data: 34

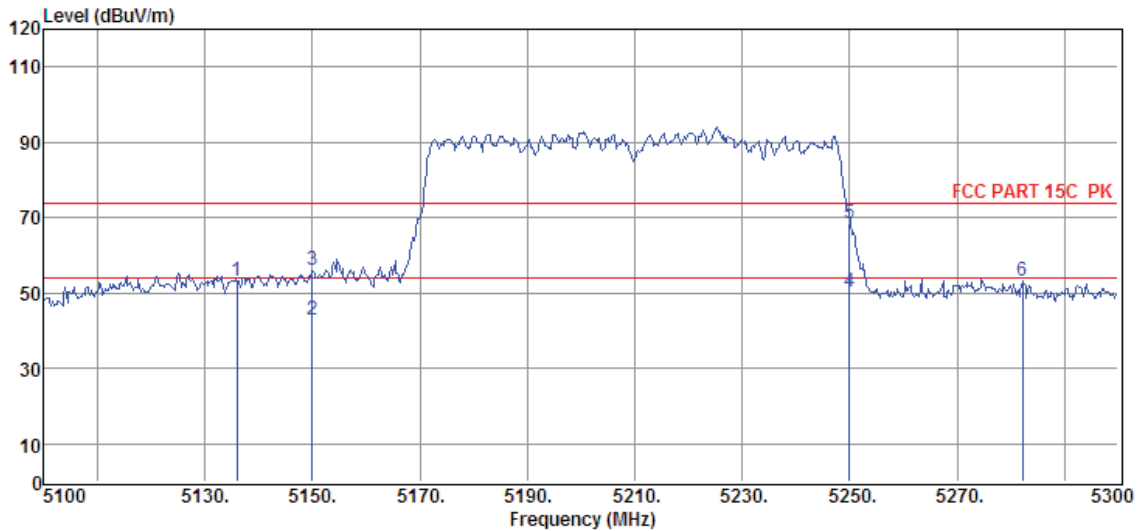

Item (Mark)	Freq. (MHz)	Read Level (dB μ V)	Antenna Factor (dB/m)	PRM Factor dB	Cable Loss dB	Result Level (dB μ V/m)	Limit Line (dB μ V/m)	Over Limit (dB)	Detector	Polarization
1	5136.00	39.69	33.98	29.34	8.80	53.13	74.00	-20.87	Peak	VERTICAL
2	5150.00	29.52	34.01	29.33	8.84	43.04	54.00	-10.96	Average	VERTICAL
3	5150.00	42.45	34.01	29.33	8.84	55.97	74.00	-18.03	Peak	VERTICAL
4	5250.00	36.50	34.21	29.32	8.93	50.32	54.00	-3.68	Average	VERTICAL
5	5250.00	54.83	34.21	29.32	8.93	68.65	74.00	-5.35	Peak	VERTICAL
6	5282.20	39.08	34.28	29.31	8.96	53.01	74.00	-20.99	Peak	VERTICAL

- Note: 1. Result Level = Read Level + Antenna Factor + Cable loss - PRM Factor.
 2. If Peak Result complies with AV limit, AV Result is deemed to comply with AV limit.
 3. Test setup: RBW: 1 MHz, VBW: 3 MHz, Sweep time: auto.

TR-4-E-009 Radiated Emission Test Result

Test Site : DDT 3m Chamber 1#
Test Date : 2017-07-23
EUT : Streaming Wireless Adaptor
Power Supply : DC 5V from Adapter
Condition : Temp:24.5'C,Humi:55%,
 Press:100.1kPa
Memo : 11ac 80 5290MHz

D:\2017 RE1# Report Data\17Q0626-5\RF FCC 5 G WIFI 边
 带.EM6
Tested By : Jerry
Model Number : ADAPT+
Test Mode : TX mode
Antenna/Distance : 2016 HF907/3m/VERTICAL

Data: 35

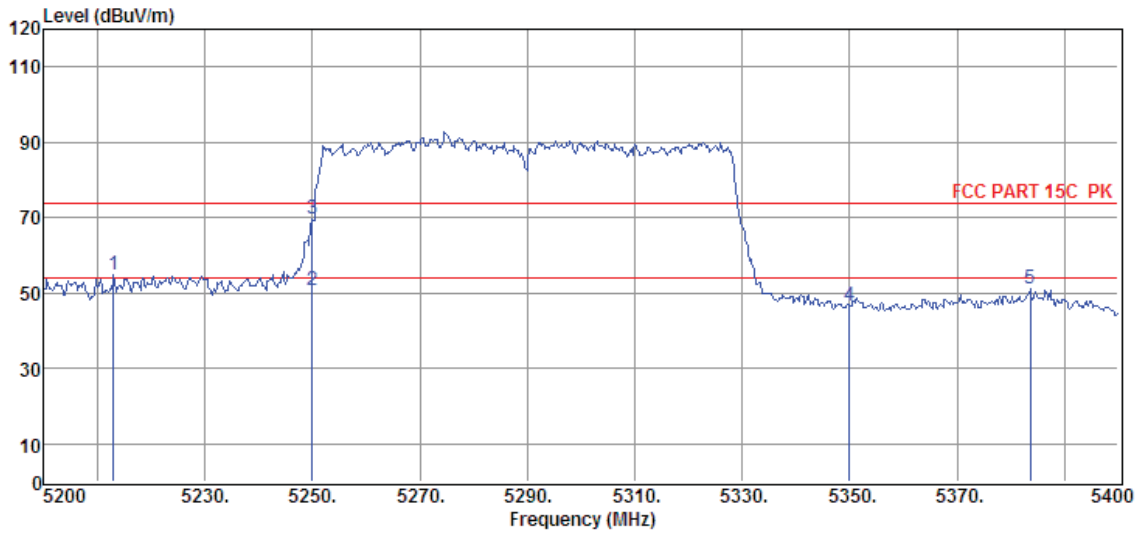

Item (Mark)	Freq. (MHz)	Read Level (dBμV)	Antenna Factor (dB/m)	PRM Factor dB	Cable Loss dB	Result Level (dBμV/m)	Limit Line (dBμV/m)	Over Limit (dB)	Detector	Polarization
2	5250.00	37.00	34.21	29.32	8.93	50.82	54.00	-3.18	Average	VERTICAL
3	5250.00	55.91	34.21	29.32	8.93	69.73	74.00	-4.27	Peak	VERTICAL
4	5350.00	32.60	34.41	29.30	9.03	46.74	74.00	-27.26	Peak	VERTICAL
5	5383.60	36.86	34.48	29.30	9.05	51.09	74.00	-22.91	Peak	VERTICAL

- Note: 1. Result Level = Read Level + Antenna Factor + Cable loss - PRM Factor.
 2. If Peak Result complies with AV limit, AV Result is deemed to comply with AV limit.
 3. Test setup: RBW: 1 MHz, VBW: 3 MHz, Sweep time: auto.

TR-4-E-009 Radiated Emission Test Result

Test Site : DDT 3m Chamber 1#
Test Date : 2017-07-23
EUT : Streaming Wireless Adaptor
Power Supply : DC 5V from Adapter
Condition : Temp:24.5'C,Humi:55%,
 Press:100.1kPa
Memo : 11ac 80 5290MHz

D:\2017 RE1# Report Data\17Q0626-5\RF FCC 5 G WIFI 边
 带.EM6
Tested By : Jerry
Model Number : ADAPT+
Test Mode : TX mode
Antenna/Distance : 2016 HF907/3m/HORIZONTAL

Data: 36

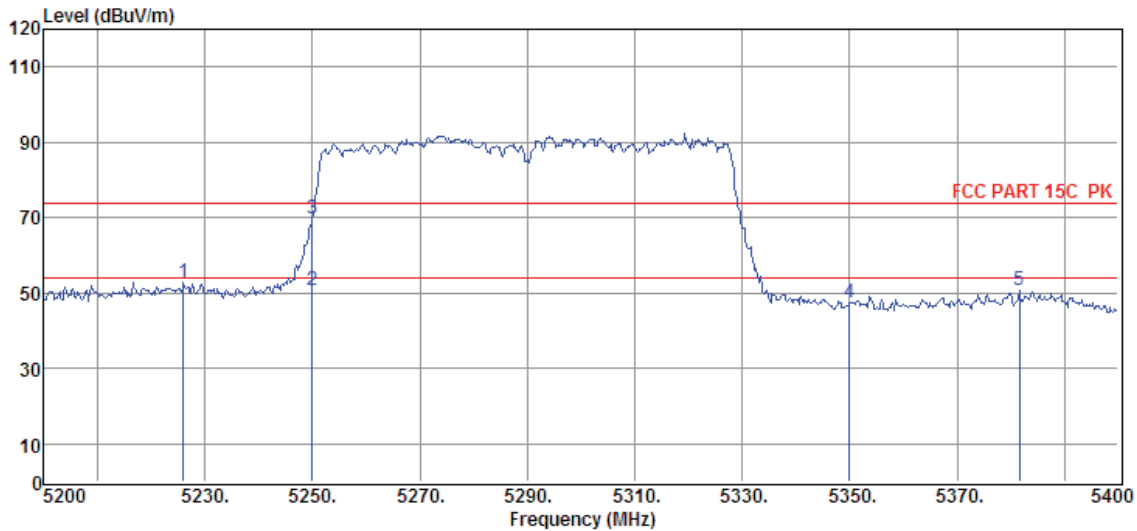

Item (Mark)	Freq. (MHz)	Read Level (dBμV)	Antenna Factor (dB/m)	PRM Factor dB	Cable Loss dB	Result Level (dBμV/m)	Limit Line (dBμV/m)	Over Limit (dB)	Detector	Polarization
1	5226.00	39.03	34.16	29.32	8.91	52.78	74.00	-21.22	Peak	HORIZONTAL
2	5250.00	36.87	34.21	29.32	8.93	50.69	54.00	-3.31	Average	HORIZONTAL
3	5250.00	55.85	34.21	29.32	8.93	69.67	74.00	-4.33	Peak	HORIZONTAL
4	5350.00	33.25	34.41	29.30	9.03	47.39	74.00	-26.61	Peak	HORIZONTAL
5	5381.60	36.66	34.47	29.30	9.05	50.88	74.00	-23.12	Peak	HORIZONTAL

- Note: 1. Result Level = Read Level + Antenna Factor + Cable loss - PRM Factor.
 2. If Peak Result complies with AV limit, AV Result is deemed to comply with AV limit.
 3. Test setup: RBW: 1 MHz, VBW: 3 MHz, Sweep time: auto.

TR-4-E-009 Radiated Emission Test Result

Test Site : DDT 3m Chamber 1# D:\2017 RE1# Report Data\17Q0626-5\RF FCC 5 G WIFI 边带.EM6
Test Date : 2017-07-23 **Tested By** : Jerry
EUT : Streaming Wireless Adaptor **Model Number** : ADAPT+
Power Supply : DC 5V from Adapter **Test Mode** : TX mode
Condition : Temp:24.5'C,Humi:55%,
 Press:100.1kPa **Antenna/Distance** : 2016 HF907/3m/HORIZONTAL
Memo : 11ac 80 5530MHz

Data: 37

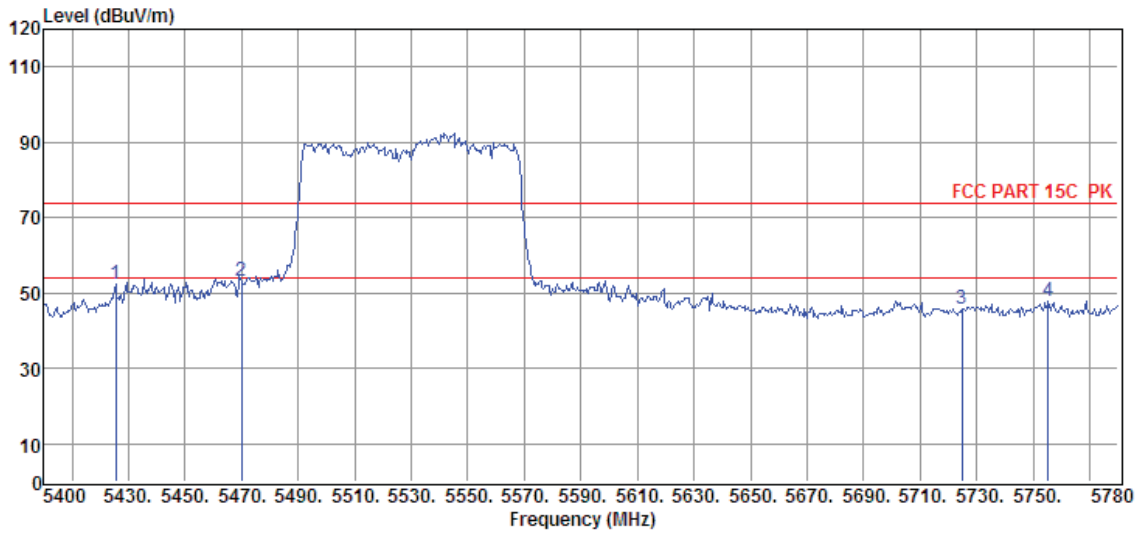

Item (Mark)	Freq. (MHz)	Read Level (dBμV)	Antenna Factor (dB/m)	PRM Factor (dB)	Cable Loss (dB)	Result Level (dBμV/m)	Limit Line (dBμV/m)	Over Limit (dB)	Detector	Polarization
1	5425.46	37.96	34.56	29.28	9.11	52.35	74.00	-21.65	Peak	HORIZONTAL
2	5469.92	38.66	34.64	29.27	9.16	53.19	74.00	-20.81	Peak	HORIZONTAL
3	5724.90	30.92	34.84	29.22	9.41	45.95	74.00	-28.05	Peak	HORIZONTAL
4	5755.30	32.86	34.86	29.21	9.43	47.94	74.00	-26.06	Peak	HORIZONTAL

Note: 1. Result Level = Read Level + Antenna Factor + Cable loss - PRM Factor.
 2. If Peak Result complies with AV limit, AV Result is deemed to comply with AV limit.
 3. Test setup: RBW: 1 MHz, VBW: 3 MHz, Sweep time: auto.

TR-4-E-009 Radiated Emission Test Result

Test Site : DDT 3m Chamber 1# D:\2017 RE1# Report Data\17Q0626-5\RF FCC 5 G WIFI 边带.EM6
Test Date : 2017-07-23 **Tested By** : Jerry
EUT : Streaming Wireless Adaptor **Model Number** : ADAPT+
Power Supply : DC 5V from Adapter **Test Mode** : TX mode
Condition : Temp:24.5'C,Humi:55%,
 Press:100.1kPa **Antenna/Distance** : 2016 HF907/3m/VERTICAL
Memo : 11ac 80 5530MHz

Data: 38

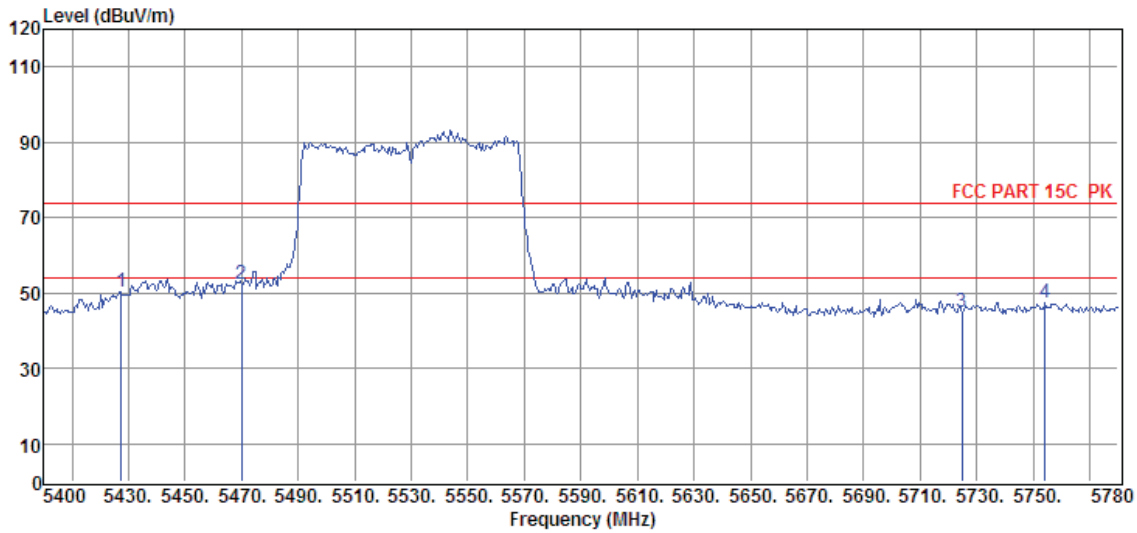

Item (Mark)	Freq. (MHz)	Read Level (dBμV)	Antenna Factor (dB/m)	PRM Factor dB	Cable Loss dB	Result Level (dBμV/m)	Limit Line (dBμV/m)	Over Limit (dB)	Detector	Polarization
1	5427.36	35.97	34.56	29.28	9.11	50.36	74.00	-23.64	Peak	VERTICAL
2	5469.92	37.97	34.64	29.27	9.16	52.50	74.00	-21.50	Peak	VERTICAL
3	5724.90	30.05	34.84	29.22	9.41	45.08	74.00	-28.92	Peak	VERTICAL
4	5754.16	32.36	34.86	29.21	9.43	47.44	74.00	-26.56	Peak	VERTICAL

Note: 1. Result Level = Read Level + Antenna Factor + Cable loss - PRM Factor.
 2. If Peak Result complies with AV limit, AV Result is deemed to comply with AV limit.
 3. Test setup: RBW: 1 MHz, VBW: 3 MHz, Sweep time: auto.

TR-4-E-009 Radiated Emission Test Result

Test Site : DDT 3m Chamber 1#
Test Date : 2017-07-23
EUT : Streaming Wireless Adaptor
Power Supply : DC 5V from Adapter
Condition : Temp:24.5'C,Humi:55%,
 Press:100.1kPa
Memo : 11ac 80 5775MHz

D:\2017 RE1# Report Data\17Q0626-5\RF FCC 5 G WIFI 边带.EM6
Tested By : Jerry
Model Number : ADAPT+
Test Mode : TX mode
Antenna/Distance : 2016 HF907/3m/VERTICAL

Data: 39

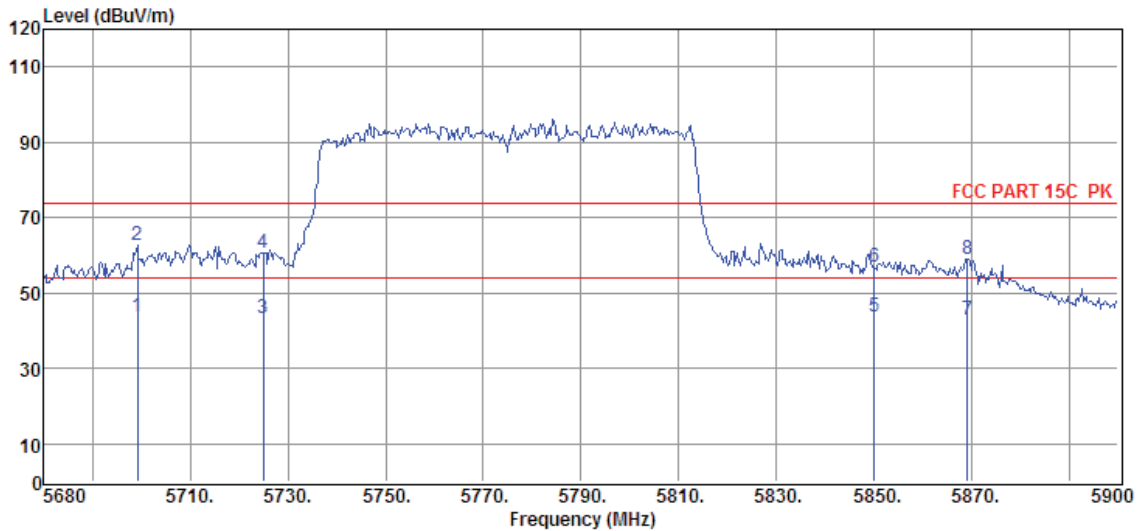

Item (Mark)	Freq. (MHz)	Read Level (dBμV)	Antenna Factor (dB/m)	PRM Factor dB	Cable Loss dB	Result Level (dBμV/m)	Limit Line (dBμV/m)	Over Limit (dB)	Detector	Polarization
1	5699.14	28.79	34.82	29.22	9.38	43.77	54.00	-10.23	Average	VERTICAL
2	5699.14	47.77	34.82	29.22	9.38	62.75	74.00	-11.25	Peak	VERTICAL
3	5725.00	28.36	34.84	29.22	9.41	43.39	54.00	-10.61	Average	VERTICAL
4	5725.00	45.52	34.84	29.22	9.41	60.55	74.00	-13.45	Peak	VERTICAL
5	5850.00	28.59	34.91	29.20	9.54	43.84	54.00	-10.16	Average	VERTICAL
6	5850.00	41.60	34.91	29.20	9.54	56.85	74.00	-17.15	Peak	VERTICAL
7	5869.20	27.75	34.92	29.20	9.56	43.03	54.00	-10.97	Average	VERTICAL
8	5869.20	43.62	34.92	29.20	9.56	58.90	74.00	-15.10	Peak	VERTICAL

Note: 1. Result Level = Read Level + Antenna Factor + Cable loss - PRM Factor.

2. If Peak Result complies with AV limit, AV Result is deemed to comply with AV limit.

3. Test setup: RBW: 1 MHz, VBW: 3 MHz, Sweep time: auto.

TR-4-E-009 Radiated Emission Test Result

Test Site : DDT 3m Chamber 1#
Test Date : 2017-07-23
EUT : Streaming Wireless Adaptor
Power Supply : DC 5V from Adapter
Condition : Temp:24.5'C,Humi:55%,
 Press:100.1kPa
Memo : 11ac 80 5775MHz

D:\2017 RE1# Report Data\17Q0626-5\RF FCC 5 G WIFI 边
 带.EM6
Tested By : Jerry
Model Number : ADAPT+
Test Mode : TX mode
Antenna/Distance : 2016 HF907/3m/HORIZONTAL

Data: 40

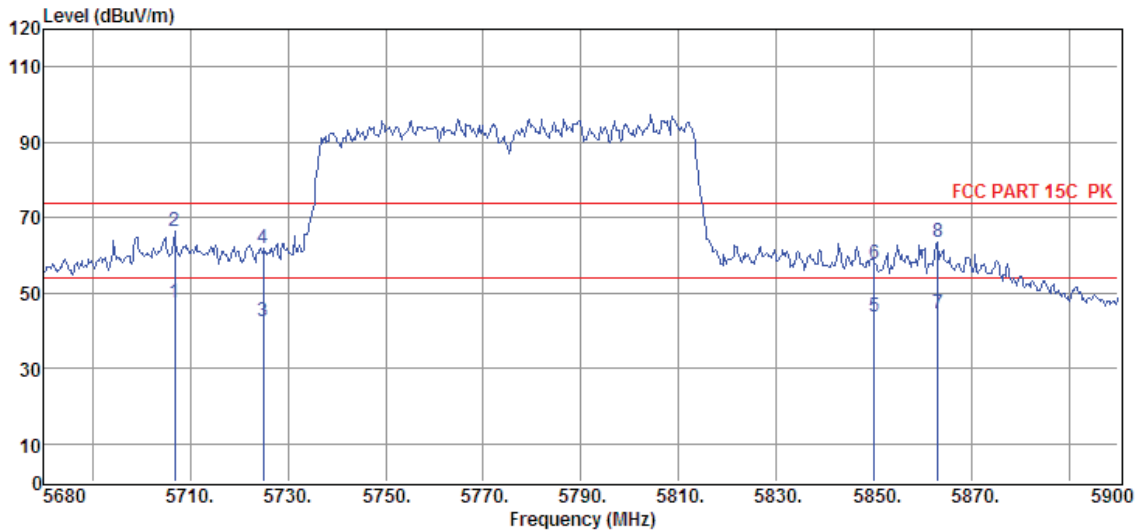

Item (Mark)	Freq. (MHz)	Read Level (dBμV)	Antenna Factor (dB/m)	PRM Factor dB	Cable Loss dB	Result Level (dBμV/m)	Limit Line (dBμV/m)	Over Limit (dB)	Detector	Polarization
1	5706.84	32.40	34.83	29.22	9.38	47.39	54.00	-6.61	Average	HORIZONTAL
2	5706.84	51.35	34.83	29.22	9.38	66.34	74.00	-7.66	Peak	HORIZONTAL
3	5725.00	27.30	34.84	29.22	9.41	42.33	54.00	-11.67	Average	HORIZONTAL
4	5725.00	47.01	34.84	29.22	9.41	62.04	74.00	-11.96	Peak	HORIZONTAL
5	5850.00	28.49	34.91	29.20	9.54	43.74	54.00	-10.26	Average	HORIZONTAL
6	5850.00	42.53	34.91	29.20	9.54	57.78	74.00	-16.22	Peak	HORIZONTAL
7	5863.04	29.22	34.92	29.20	9.56	44.50	54.00	-9.50	Average	HORIZONTAL
8	5863.04	48.06	34.92	29.20	9.56	63.34	74.00	-10.66	Peak	HORIZONTAL

Note: 1. Result Level = Read Level + Antenna Factor + Cable loss - PRM Factor.

2. If Peak Result complies with AV limit, AV Result is deemed to comply with AV limit.

3. Test setup: RBW: 1 MHz, VBW: 3 MHz, Sweep time: auto.

TR-4-E-009 Radiated Emission Test Result

Test Site : DDT 3m Chamber 1#
Test Date : 2017-07-29
EUT : Streaming Wireless Adaptor
Power Supply : DC 5V from Adapter
Condition : Temp:24.5°C,Humi:55%,
 Press:100.1kPa
Memo : 11a 20 5180MHz

D:\2017 RE1# Report Data\17Q0626-5\RF FCC 5 G WIFI 边带.EM6
Tested By : Jerry
Model Number : ADAPT+
Test Mode : TX mode
Antenna/Distance : 2016 HF907/3m/HORIZONTAL

Data: 41

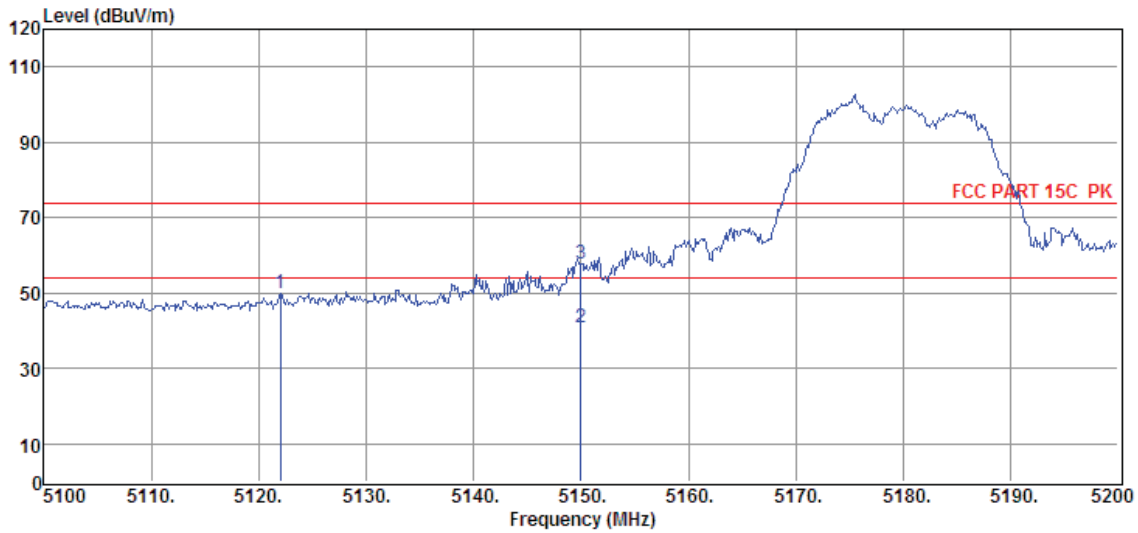

Item (Mark)	Freq. (MHz)	Read Level (dB μ V)	Antenna Factor (dB/m)	PRM Factor dB	Cable Loss dB	Result Level (dB μ V/m)	Limit Line (dB μ V/m)	Over Limit (dB)	Detector	Polarization
1	5122.00	36.62	33.95	29.34	8.80	50.03	74.00	-23.97	Peak	HORIZONTAL
2	5150.00	27.35	34.01	29.33	8.84	40.87	54.00	-13.13	Average	HORIZONTAL
3	5150.00	44.29	34.01	29.33	8.84	57.81	74.00	-16.19	Peak	HORIZONTAL

Note: 1. Result Level = Read Level + Antenna Factor + Cable loss - PRM Factor.

2. If Peak Result complies with AV limit, AV Result is deemed to comply with AV limit.

3. Test setup: RBW: 1 MHz, VBW: 3 MHz, Sweep time: auto.

TR-4-E-009 Radiated Emission Test Result

Test Site : DDT 3m Chamber 1#
Test Date : 2017-07-29
EUT : Streaming Wireless Adaptor
Power Supply : DC 5V from Adapter
Condition : Temp:24.5'C,Humi:55%,
 Press:100.1kPa
Memo : 11a 20 5180MHz

D:\2017 RE1# Report Data\17Q0626-5\RF FCC 5 G WIFI 边带.EM6
Tested By : Jerry
Model Number : ADAPT+
Test Mode : TX mode
Antenna/Distance : 2016 HF907/3m/VERTICAL

Data: 42

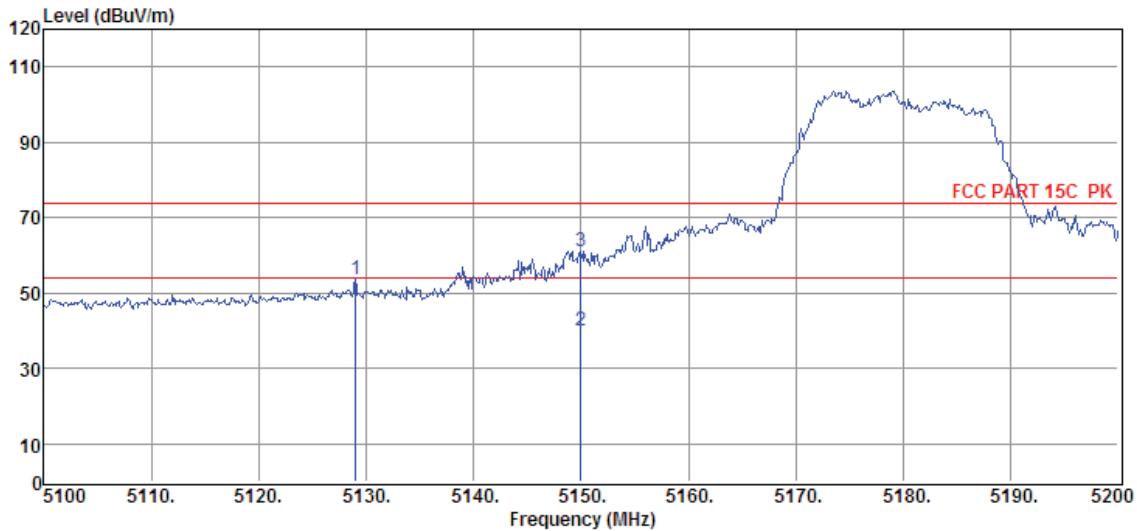

Item (Mark)	Freq. (MHz)	Read Level (dB μ V)	Antenna Factor (dB/m)	PRM Factor dB	Cable Loss dB	Result Level (dB μ V/m)	Limit Line (dB μ V/m)	Over Limit (dB)	Detector	Polarization
1	5129.00	40.15	33.97	29.34	8.80	53.58	74.00	-20.42	Peak	VERTICAL
2	5150.00	26.50	34.01	29.33	8.84	40.02	54.00	-13.98	Average	VERTICAL
3	5150.00	47.44	34.01	29.33	8.84	60.96	74.00	-13.04	Peak	VERTICAL

Note: 1. Result Level = Read Level + Antenna Factor + Cable loss - PRM Factor.

2. If Peak Result complies with AV limit, AV Result is deemed to comply with AV limit.

3. Test setup: RBW: 1 MHz, VBW: 3 MHz, Sweep time: auto.

TR-4-E-009 Radiated Emission Test Result

Test Site : DDT 3m Chamber 1# D:\2017 RE1# Report Data\17Q0626-5\RF FCC 5 G WIFI 边带.EM6
Test Date : 2017-07-29 **Tested By** : Jerry
EUT : Streaming Wireless Adaptor **Model Number** : ADAPT+
Power Supply : DC 5V from Adapter **Test Mode** : TX mode
Condition : Temp:24.5°C,Humi:55%,
 Press:100.1kPa **Antenna/Distance** : 2016 HF907/3m/VERTICAL
Memo : 11a 20 5240MHz

Data: 43

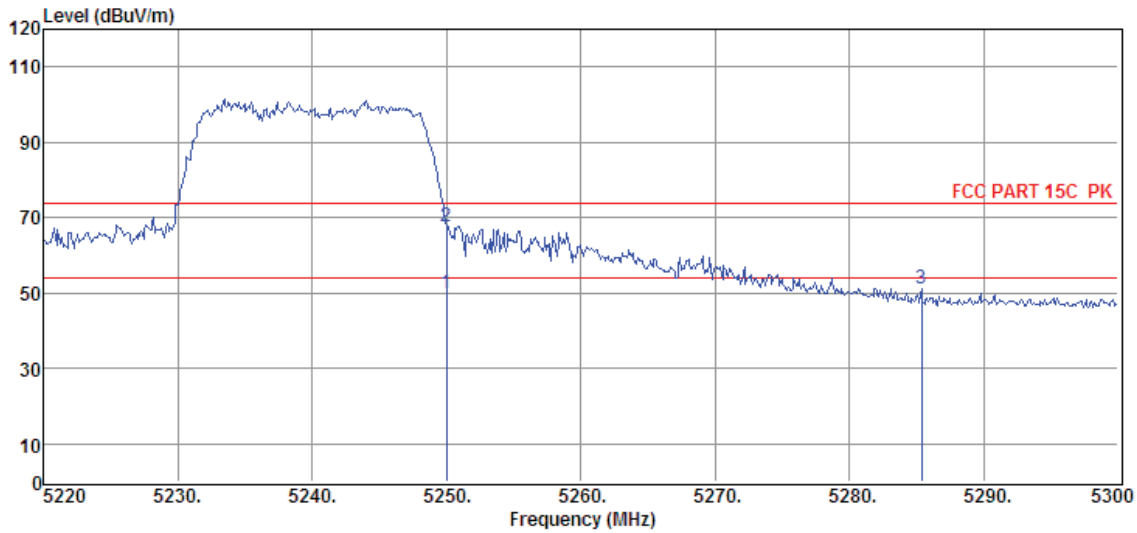

Item (Mark)	Freq. (MHz)	Read Level (dBμV)	Antenna Factor (dB/m)	PRM Factor dB	Cable Loss dB	Result Level (dBμV/m)	Limit Line (dBμV/m)	Over Limit (dB)	Detector	Polarization
1	5250.00	36.02	34.21	29.32	8.93	49.84	54.00	-4.16	Average	VERTICAL
2	5250.00	53.99	34.21	29.32	8.93	67.81	74.00	-6.19	Peak	VERTICAL
3	5285.36	37.32	34.28	29.31	8.96	51.25	74.00	-22.75	Peak	VERTICAL

- Note: 1. Result Level = Read Level + Antenna Factor + Cable loss - PRM Factor.
 2. If Peak Result complies with AV limit, AV Result is deemed to comply with AV limit.
 3. Test setup: RBW: 1 MHz, VBW: 3 MHz, Sweep time: auto.

TR-4-E-009 Radiated Emission Test Result

Test Site : DDT 3m Chamber 1# D:\2017 RE1# Report Data\17Q0626-5\RF FCC 5 G WIFI 边带.EM6
Test Date : 2017-07-29 **Tested By** : Jerry
EUT : Streaming Wireless Adaptor **Model Number** : ADAPT+
Power Supply : DC 5V from Adapter **Test Mode** : TX mode
Condition : Temp:24.5'C,Humi:55%,
 Press:100.1kPa **Antenna/Distance** : 2016 HF907/3m/HORIZONTAL
Memo : 11a 20 5240MHz

Data: 44

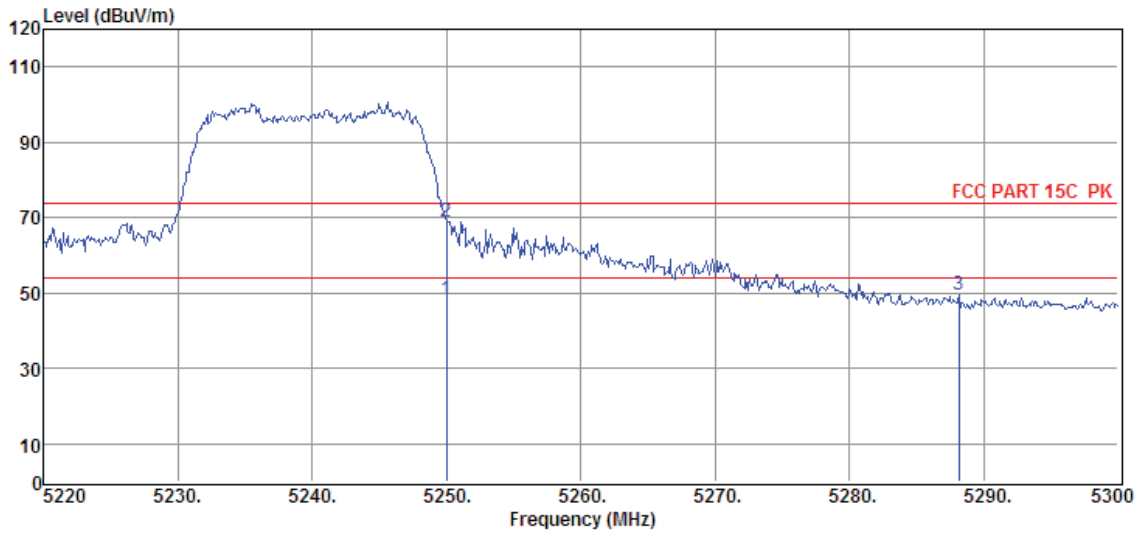

Item (Mark)	Freq. (MHz)	Read Level (dB μ V)	Antenna Factor (dB/m)	PRM Factor dB	Cable Loss dB	Result Level (dB μ V/m)	Limit Line (dB μ V/m)	Over Limit (dB)	Detector	Polarization
1	5250.00	34.32	34.21	29.32	8.93	48.14	54.00	-5.86	Average	VERTICAL
2	5250.00	55.12	34.21	29.32	8.93	68.94	74.00	-5.06	Peak	HORIZONTAL
3	5288.16	35.50	34.29	29.31	8.98	49.46	74.00	-24.54	Peak	HORIZONTAL

Note: 1. Result Level = Read Level + Antenna Factor + Cable loss - PRM Factor.

2. If Peak Result complies with AV limit, AV Result is deemed to comply with AV limit.

3. Test setup: RBW: 1 MHz, VBW: 3 MHz, Sweep time: auto.

TR-4-E-009 Radiated Emission Test Result

Test Site : DDT 3m Chamber 1#
Test Date : 2017-07-29
EUT : Streaming Wireless Adaptor
Power Supply : DC 5V from Adapter
Condition : Temp:24.5'C,Humi:55%,
 Press:100.1kPa
Memo : 11a 20 5260MHz

D:\2017 RE1# Report Data\17Q0626-5\RF FCC 5 G WIFI 边
 带.EM6
Tested By : Jerry
Model Number : ADAPT+
Test Mode : TX mode
Antenna/Distance : 2016 HF907/3m/VERTICAL

Data: 45

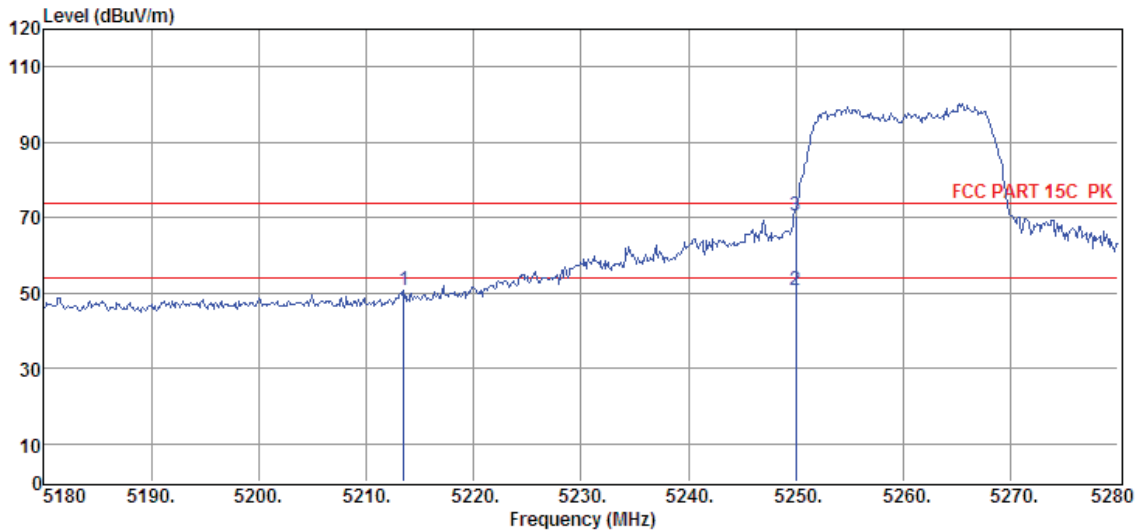

Item (Mark)	Freq. (MHz)	Read Level (dBμV)	Antenna Factor (dB/m)	PRM Factor dB	Cable Loss dB	Result Level (dBμV/m)	Limit Line (dBμV/m)	Over Limit (dB)	Detector	Polarization
1	5213.50	37.00	34.14	29.33	8.91	50.72	74.00	-23.28	Peak	VERTICAL
2	5250.00	36.72	34.21	29.32	8.93	50.54	54.00	-3.46	Average	VERTICAL
3	5250.00	56.60	34.21	29.32	8.93	70.42	74.00	-3.58	Peak	VERTICAL

- Note: 1. Result Level = Read Level + Antenna Factor + Cable loss - PRM Factor.
 2. If Peak Result complies with AV limit, AV Result is deemed to comply with AV limit.
 3. Test setup: RBW: 1 MHz, VBW: 3 MHz, Sweep time: auto.

TR-4-E-009 Radiated Emission Test Result

Test Site : DDT 3m Chamber 1#
Test Date : 2017-07-29
EUT : Streaming Wireless Adaptor
Power Supply : DC 5V from Adapter
Condition : Temp:24.5'C,Humi:55%,
 Press:100.1kPa
Memo : 11a 20 5260MHz

D:\2017 RE1# Report Data\17Q0626-5\RF FCC 5 G WIFI 边
 带.EM6
Tested By : Jerry
Model Number : ADAPT+
Test Mode : TX mode
Antenna/Distance : 2016 HF907/3m/HORIZONTAL

Data: 46

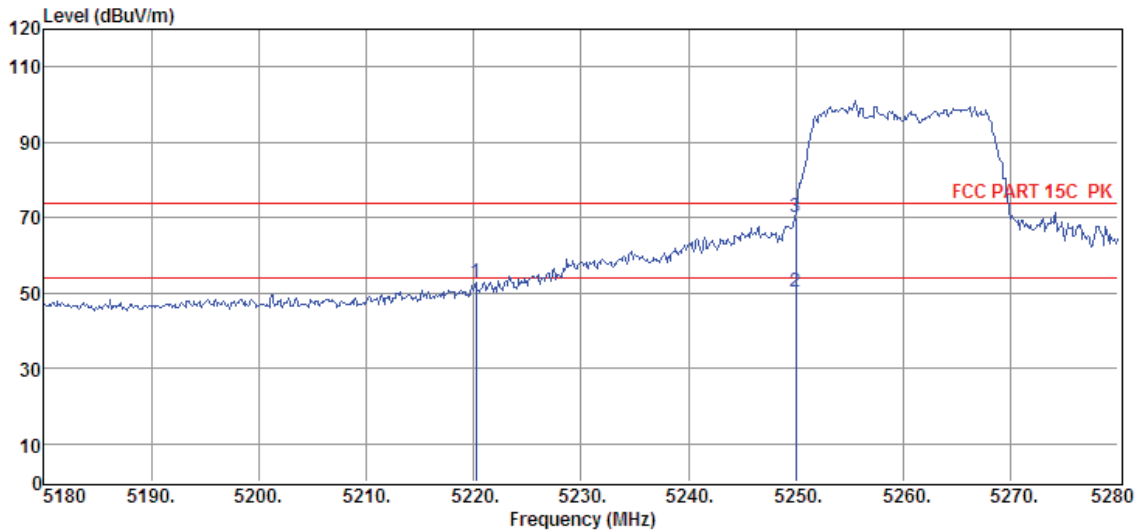

Item (Mark)	Freq. (MHz)	Read Level (dBμV)	Antenna Factor (dB/m)	PRM Factor dB	Cable Loss dB	Result Level (dBμV/m)	Limit Line (dBμV/m)	Over Limit (dB)	Detector	Polarization
1	5220.20	39.03	34.15	29.33	8.91	52.76	74.00	-21.24	Peak	HORIZONTAL
2	5250.00	36.52	34.21	29.32	8.93	50.34	54.00	-3.66	Average	HORIZONTAL
3	5250.00	56.41	34.21	29.32	8.93	70.23	74.00	-3.77	Peak	HORIZONTAL

Note: 1. Result Level = Read Level + Antenna Factor + Cable loss - PRM Factor.

2. If Peak Result complies with AV limit, AV Result is deemed to comply with AV limit.

3. Test setup: RBW: 1 MHz, VBW: 3 MHz, Sweep time: auto.

TR-4-E-009 Radiated Emission Test Result

Test Site : DDT 3m Chamber 1# D:\2017 RE1# Report Data\17Q0626-5\RF FCC 5 G WIFI 边带.EM6
Test Date : 2017-07-29 **Tested By** : Jerry
EUT : Streaming Wireless Adaptor **Model Number** : ADAPT+
Power Supply : DC 5V from Adapter **Test Mode** : TX mode
Condition : Temp:24.5'C,Humi:55%,
 Press:100.1kPa **Antenna/Distance** : 2016 HF907/3m/VERTICAL
Memo : 11a 20 5320MHz

Data: 47

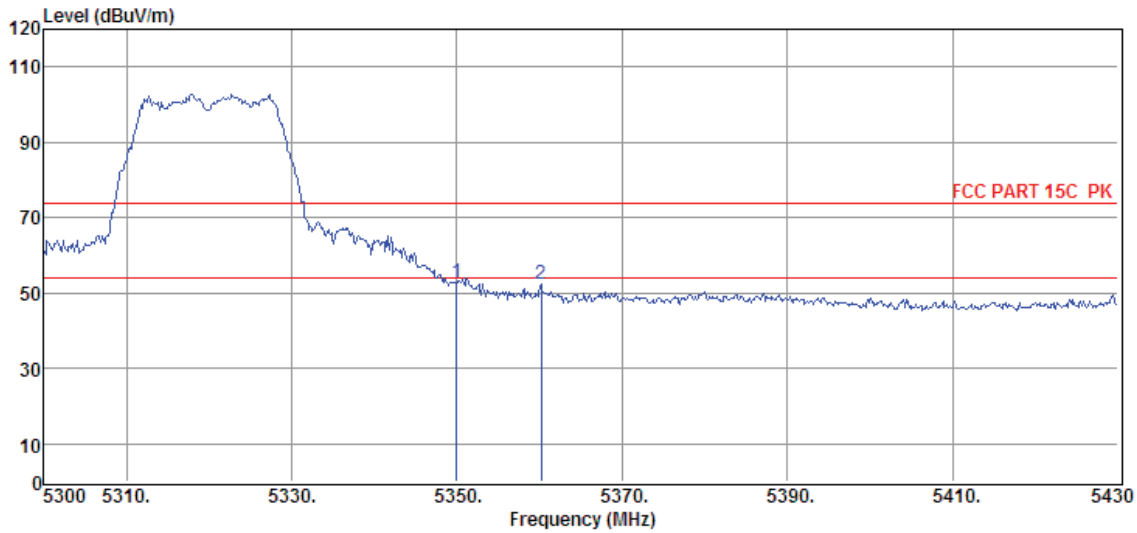

Item (Mark)	Freq. (MHz)	Read Level (dBμV)	Antenna Factor (dB/m)	PRM Factor (dB)	Cable Loss (dB)	Result Level (dBμV/m)	Limit Line (dBμV/m)	Over Limit (dB)	Detector	Polarization
1	5350.00	38.82	34.41	29.30	9.03	52.96	74.00	-21.04	Peak	VERTICAL
2	5360.19	38.39	34.43	29.30	9.03	52.55	74.00	-21.45	Peak	VERTICAL

- Note: 1. Result Level = Read Level + Antenna Factor + Cable loss - PRM Factor.
 2. If Peak Result complies with AV limit, AV Result is deemed to comply with AV limit.
 3. Test setup: RBW: 1 MHz, VBW: 3 MHz, Sweep time: auto.

TR-4-E-009 Radiated Emission Test Result

Test Site : DDT 3m Chamber 1# D:\2017 RE1# Report Data\17Q0626-5\RF FCC 5 G WIFI 边带.EM6
Test Date : 2017-07-29 **Tested By** : Jerry
EUT : Streaming Wireless Adaptor **Model Number** : ADAPT+
Power Supply : DC 5V from Adapter **Test Mode** : TX mode
Condition : Temp:24.5'C,Humi:55%,
 Press:100.1kPa **Antenna/Distance** : 2016 HF907/3m/HORIZONTAL
Memo : 11a 20 5320MHz

Data: 48

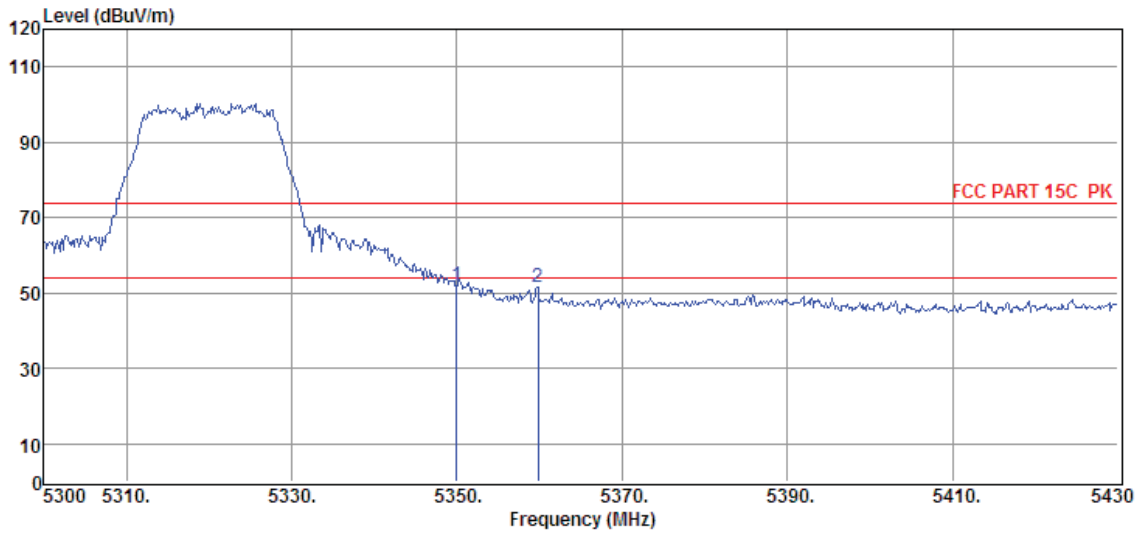

Item (Mark)	Freq. (MHz)	Read Level (dBμV)	Antenna Factor (dB/m)	PRM Factor dB	Cable Loss dB	Result Level (dBμV/m)	Limit Line (dBμV/m)	Over Limit (dB)	Detector	Polarization
1	5350.00	37.88	34.41	29.30	9.03	52.02	74.00	-21.98	Peak	HORIZONTAL
2	5359.80	37.34	34.43	29.30	9.03	51.50	74.00	-22.50	Peak	HORIZONTAL

- Note: 1. Result Level = Read Level + Antenna Factor + Cable loss - PRM Factor.
 2. If Peak Result complies with AV limit, AV Result is deemed to comply with AV limit.
 3. Test setup: RBW: 1 MHz, VBW: 3 MHz, Sweep time: auto.

TR-4-E-009 Radiated Emission Test Result

Test Site : DDT 3m Chamber 1# D:\2017 RE1# Report Data\17Q0626-5\RF FCC 5 G WIFI 边带.EM6
Test Date : 2017-07-29 **Tested By** : Jerry
EUT : Streaming Wireless Adaptor **Model Number** : ADAPT+
Power Supply : DC 5V from Adapter **Test Mode** : TX mode
Condition : Temp:24.5'C,Humi:55%,
 Press:100.1kPa **Antenna/Distance** : 2016 HF907/3m/HORIZONTAL
Memo : 11a 20 5500MHz

Data: 49

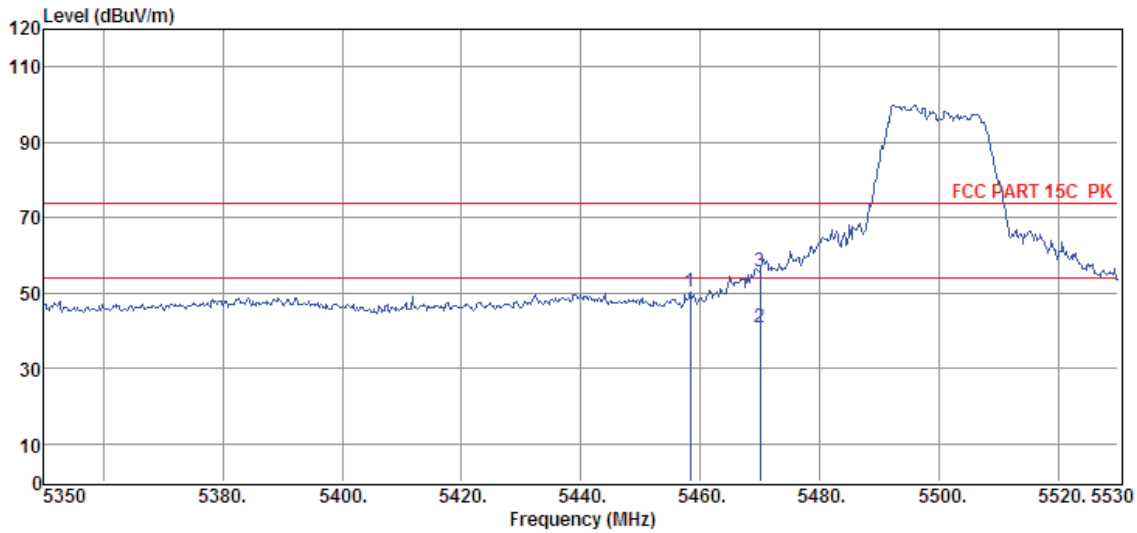

Item (Mark)	Freq. (MHz)	Read Level (dBμV)	Antenna Factor (dB/m)	PRM Factor (dB)	Cable Loss (dB)	Result Level (dBμV/m)	Limit Line (dBμV/m)	Over Limit (dB)	Detector	Polarization
1	5458.36	35.77	34.62	29.28	9.14	50.25	74.00	-23.75	Peak	HORIZONTAL
2	5470.00	26.10	34.64	29.27	9.16	40.63	54.00	-13.37	Average	HORIZONTAL
3	5470.00	40.94	34.64	29.27	9.16	55.47	74.00	-18.53	Peak	HORIZONTAL

Note: 1. Result Level = Read Level + Antenna Factor + Cable loss - PRM Factor.
 2. If Peak Result complies with AV limit, AV Result is deemed to comply with AV limit.
 3. Test setup: RBW: 1 MHz, VBW: 3 MHz, Sweep time: auto.

TR-4-E-009 Radiated Emission Test Result

Test Site : DDT 3m Chamber 1# D:\2017 RE1# Report Data\17Q0626-5\RF FCC 5 G WIFI 边带.EM6
Test Date : 2017-07-29 **Tested By** : Jerry
EUT : Streaming Wireless Adaptor **Model Number** : ADAPT+
Power Supply : DC 5V from Adapter **Test Mode** : TX mode
Condition : Temp:24.5'C,Humi:55%,
 Press:100.1kPa **Antenna/Distance** : 2016 HF907/3m/VERTICAL
Memo : 11a 20 5500MHz

Data: 50

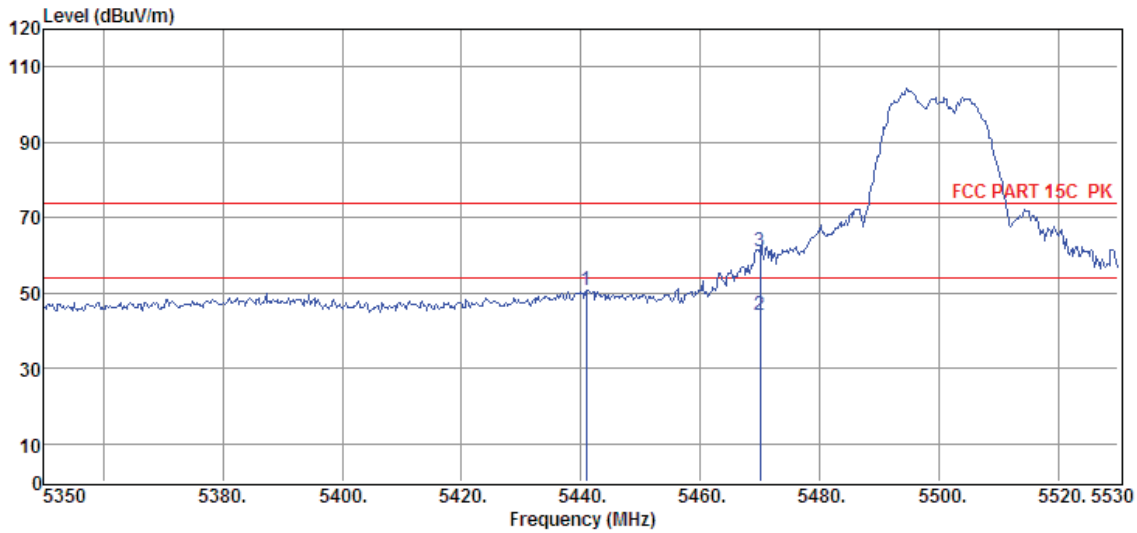

Item (Mark)	Freq. (MHz)	Read Level (dBμV)	Antenna Factor (dB/m)	PRM Factor dB	Cable Loss dB	Result Level (dBμV/m)	Limit Line (dBμV/m)	Over Limit (dB)	Detector	Polarization
1	5440.90	36.25	34.59	29.28	9.14	50.70	74.00	-23.30	Peak	VERTICAL
2	5470.00	29.52	34.64	29.27	9.16	44.05	54.00	-9.95	Average	VERTICAL
3	5470.00	46.36	34.64	29.27	9.16	60.89	74.00	-13.11	Peak	VERTICAL

- Note: 1. Result Level = Read Level + Antenna Factor + Cable loss - PRM Factor.
 2. If Peak Result complies with AV limit, AV Result is deemed to comply with AV limit.
 3. Test setup: RBW: 1 MHz, VBW: 3 MHz, Sweep time: auto.

TR-4-E-009 Radiated Emission Test Result

Test Site : DDT 3m Chamber 1#
Test Date : 2017-07-29
EUT : Streaming Wireless Adaptor
Power Supply : DC 5V from Adapter
Condition : Temp:24.5'C,Humi:55%,
 Press:100.1kPa
Memo : 11a 20 5700MHz

D:\2017 RE1# Report Data\17Q0626-5\RF FCC 5 G WIFI 边
 带.EM6
Tested By : Jerry
Model Number : ADAPT+
Test Mode : TX mode
Antenna/Distance : 2016 HF907/3m/HORIZONTAL

Data: 51

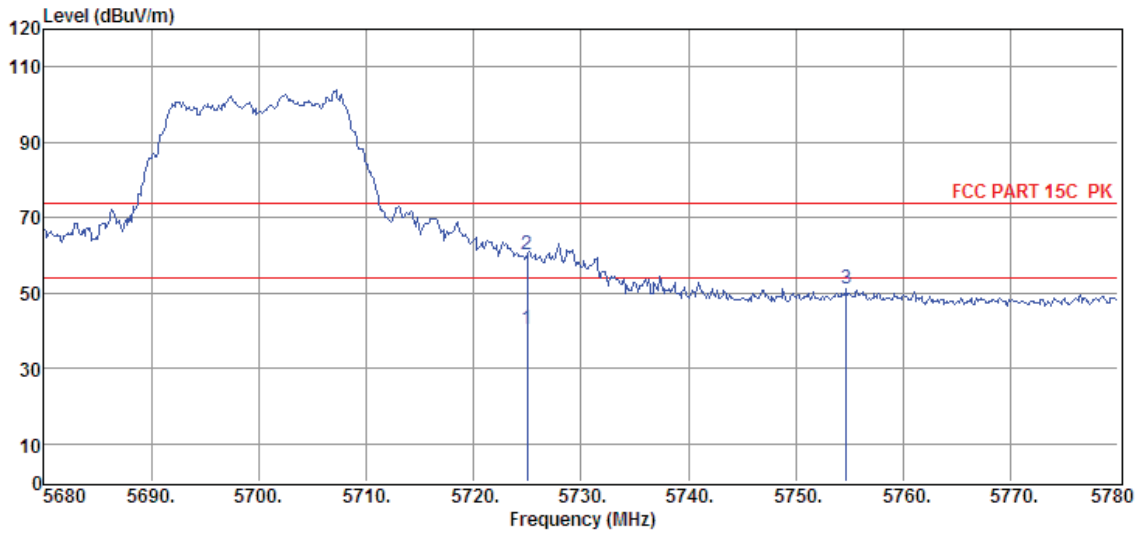

Item (Mark)	Freq. (MHz)	Read Level (dB μ V)	Antenna Factor (dB/m)	PRM Factor dB	Cable Loss dB	Result Level (dB μ V/m)	Limit Line (dB μ V/m)	Over Limit (dB)	Detector	Polarization
1	5725.00	25.32	34.84	29.22	9.41	40.35	54.00	-13.65	Average	HORIZONTAL
2	5725.00	45.21	34.84	29.22	9.41	60.24	74.00	-13.76	Peak	HORIZONTAL
3	5754.70	36.07	34.86	29.21	9.43	51.15	74.00	-22.85	Peak	HORIZONTAL

Note: 1. Result Level = Read Level + Antenna Factor + Cable loss - PRM Factor.

2. If Peak Result complies with AV limit, AV Result is deemed to comply with AV limit.

3. Test setup: RBW: 1 MHz, VBW: 3 MHz, Sweep time: auto.

TR-4-E-009 Radiated Emission Test Result

Test Site	: DDT 3m Chamber 1#	D:\2017 RE1# Report Data\17Q0626-5\RF FCC 5 G WIFI 边带.EM6
Test Date	: 2017-07-29	Tested By : Jerry
EUT	: Streaming Wireless Adaptor	Model Number : ADAPT+
Power Supply	: DC 5V from Adapter	Test Mode : TX mode
Condition	: Temp:24.5'C,Humi:55%, Press:100.1kPa	Antenna/Distance : 2016 HF907/3m/VERTICAL
Memo	: 11a 20 5700MHz	

Data: 52

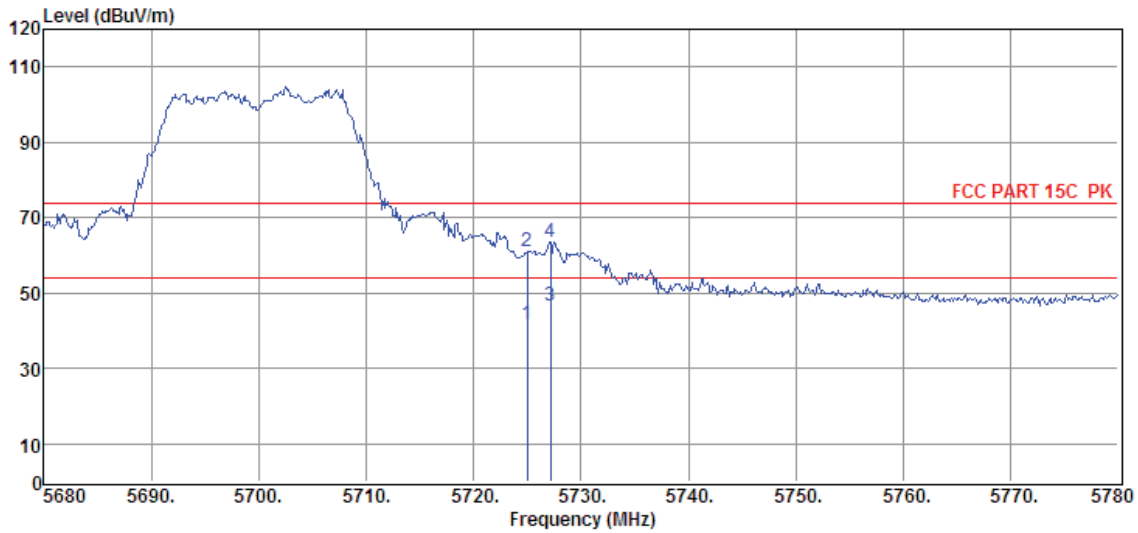

Item (Mark)	Freq. (MHz)	Read Level (dBμV)	Antenna Factor (dB/m)	PRM Factor dB	Cable Loss dB	Result Level (dBμV/m)	Limit Line (dBμV/m)	Over Limit (dB)	Detector	Polarization
1	5725.00	26.75	34.84	29.22	9.41	41.78	54.00	-12.22	Average	VERTICAL
2	5725.00	45.83	34.84	29.22	9.41	60.86	74.00	-13.14	Peak	VERTICAL
3	5727.20	31.63	34.84	29.22	9.41	46.66	54.00	-7.34	Average	VERTICAL
4	5727.20	48.60	34.84	29.22	9.41	63.63	74.00	-10.37	Peak	VERTICAL

- Note: 1. Result Level = Read Level + Antenna Factor + Cable loss - PRM Factor.
 2. If Peak Result complies with AV limit, AV Result is deemed to comply with AV limit.
 3. Test setup: RBW: 1 MHz, VBW: 3 MHz, Sweep time: auto.

TR-4-E-009 Radiated Emission Test Result

Test Site : DDT 3m Chamber 1# D:\2017 RE1# Report Data\17Q0626-5\RF FCC 5 G WIFI 边带.EM6
Test Date : 2017-07-29 **Tested By** : Jerry
EUT : Streaming Wireless Adaptor **Model Number** : ADAPT+
Power Supply : DC 5V from Adapter **Test Mode** : TX mode
Condition : Temp:24.5'C,Humi:55%,
 Press:100.1kPa **Antenna/Distance** : 2016 HF907/3m/HORIZONTAL
Memo : 11a 20 5745MHz

Data: 53

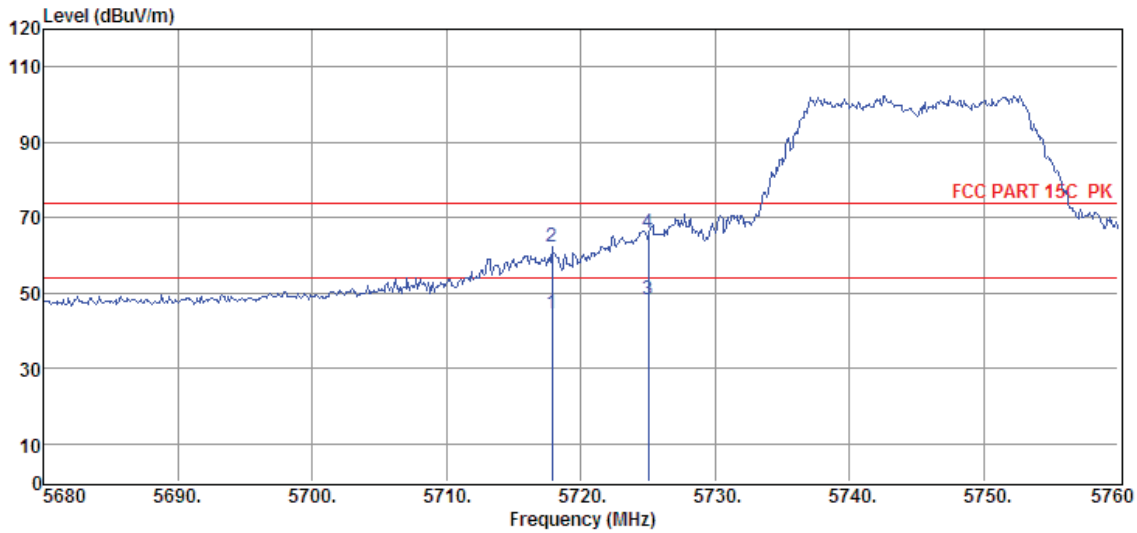

Item (Mark)	Freq. (MHz)	Read Level (dBμV)	Antenna Factor (dB/m)	PRM Factor dB	Cable Loss dB	Result Level (dBμV/m)	Limit Line (dBμV/m)	Over Limit (dB)	Detector	Polarization
1	5717.84	29.36	34.83	29.22	9.41	44.38	54.00	-9.62	Average	HORIZONTAL
2	5717.84	47.11	34.83	29.22	9.41	62.13	74.00	-11.87	Peak	HORIZONTAL
3	5725.00	33.25	34.84	29.22	9.41	48.28	54.00	-5.72	Average	HORIZONTAL
4	5725.00	51.15	34.84	29.22	9.41	66.18	74.00	-7.82	Peak	HORIZONTAL

Note: 1. Result Level = Read Level + Antenna Factor + Cable loss - PRM Factor.
 2. If Peak Result complies with AV limit, AV Result is deemed to comply with AV limit.
 3. Test setup: RBW: 1 MHz, VBW: 3 MHz, Sweep time: auto.

TR-4-E-009 Radiated Emission Test Result

Test Site : DDT 3m Chamber 1# D:\2017 RE1# Report Data\17Q0626-5\RF FCC 5 G WIFI 边带.EM6
Test Date : 2017-07-29 **Tested By** : Jerry
EUT : Streaming Wireless Adaptor **Model Number** : ADAPT+
Power Supply : DC 5V from Adapter **Test Mode** : TX mode
Condition : Temp:24.5'C,Humi:55%,
 Press:100.1kPa **Antenna/Distance** : 2016 HF907/3m/VERTICAL
Memo : 11a 20 5745MHz

Data: 54

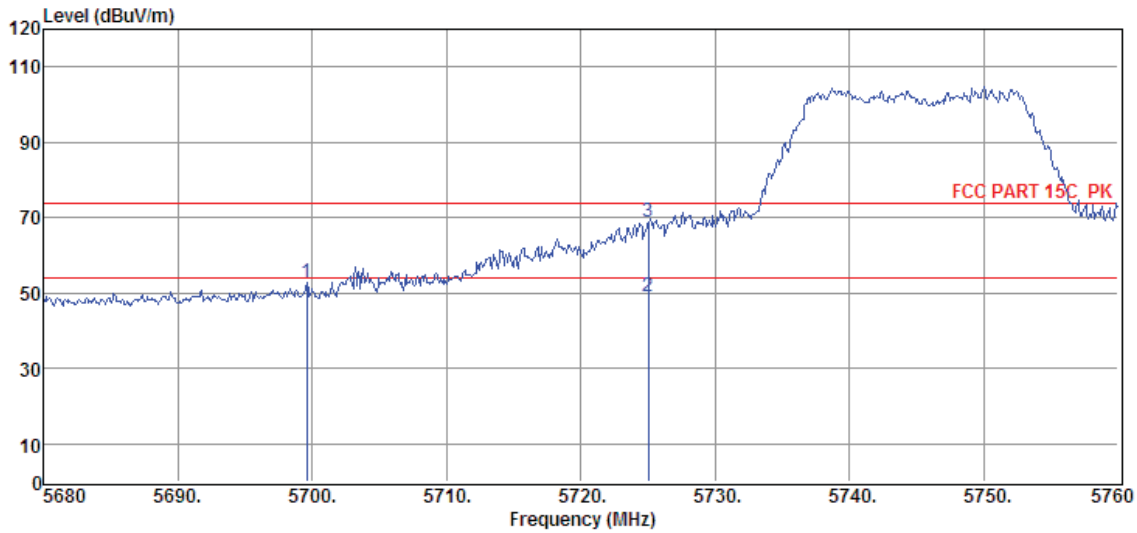

Item (Mark)	Freq. (MHz)	Read Level (dBμV)	Antenna Factor (dB/m)	PRM Factor dB	Cable Loss dB	Result Level (dBμV/m)	Limit Line (dBμV/m)	Over Limit (dB)	Detector	Polarization
1	5699.60	37.69	34.82	29.22	9.38	52.67	74.00	-21.33	Peak	VERTICAL
2	5725.00	34.05	34.84	29.22	9.41	49.08	54.00	-4.92	Average	VERTICAL
3	5725.00	53.99	34.84	29.22	9.41	69.02	74.00	-4.98	Peak	VERTICAL

- Note: 1. Result Level = Read Level + Antenna Factor + Cable loss - PRM Factor.
 2. If Peak Result complies with AV limit, AV Result is deemed to comply with AV limit.
 3. Test setup: RBW: 1 MHz, VBW: 3 MHz, Sweep time: auto.

TR-4-E-009 Radiated Emission Test Result

Test Site : DDT 3m Chamber 1#
Test Date : 2017-07-29
EUT : Streaming Wireless Adaptor
Power Supply : DC 5V from Adapter
Condition : Temp:24.5'C,Humi:55%,
 Press:100.1kPa
Memo : 11a 20 5825MHz

D:\2017 RE1# Report Data\17Q0626-5\RF FCC 5 G WIFI 边
 带.EM6
Tested By : Jerry
Model Number : ADAPT+
Test Mode : TX mode
Antenna/Distance : 2016 HF907/3m/VERTICAL

Data: 55

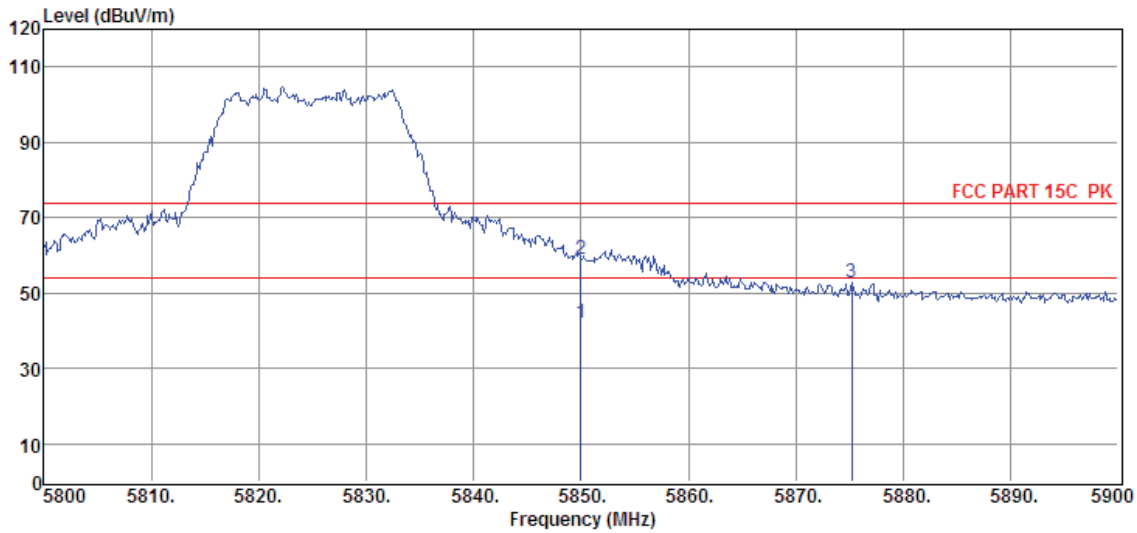

Item (Mark)	Freq. (MHz)	Read Level (dB μ V)	Antenna Factor (dB/m)	PRM Factor dB	Cable Loss dB	Result Level (dB μ V/m)	Limit Line (dB μ V/m)	Over Limit (dB)	Detector	Polarization
1	5850.00	26.79	34.91	29.20	9.54	42.04	54.00	-11.96	Average	VERTICAL
2	5850.00	43.83	34.91	29.20	9.54	59.08	74.00	-14.92	Peak	VERTICAL
3	5875.20	37.31	34.93	29.20	9.56	52.60	74.00	-21.40	Peak	VERTICAL

Note: 1. Result Level = Read Level + Antenna Factor + Cable loss - PRM Factor.

2. If Peak Result complies with AV limit, AV Result is deemed to comply with AV limit.

3. Test setup: RBW: 1 MHz, VBW: 3 MHz, Sweep time: auto.

TR-4-E-009 Radiated Emission Test Result

Test Site : DDT 3m Chamber 1# D:\2017 RE1# Report Data\17Q0626-5\RF FCC 5 G WIFI 边带.EM6
Test Date : 2017-07-29 **Tested By** : Jerry
EUT : Streaming Wireless Adaptor **Model Number** : ADAPT+
Power Supply : DC 5V from Adapter **Test Mode** : TX mode
Condition : Temp:24.5°C,Humi:55%,
 Press:100.1kPa **Antenna/Distance** : 2016 HF907/3m/HORIZONTAL
Memo : 11a 20 5825MHz

Data: 56

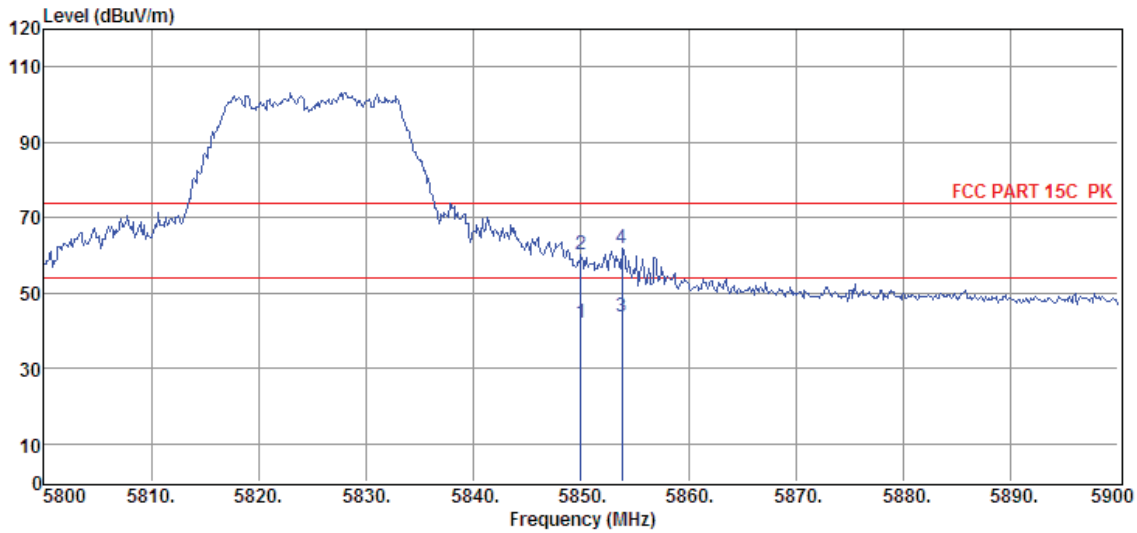

Item (Mark)	Freq. (MHz)	Read Level (dBμV)	Antenna Factor (dB/m)	PRM Factor dB	Cable Loss dB	Result Level (dBμV/m)	Limit Line (dBμV/m)	Over Limit (dB)	Detector	Polarization
1	5850.00	26.79	34.91	29.20	9.54	42.04	54.00	-11.96	Average	HORIZONTAL
2	5850.00	44.83	34.91	29.20	9.54	60.08	74.00	-13.92	Peak	HORIZONTAL
3	5853.80	28.61	34.91	29.20	9.54	43.86	54.00	-10.14	Average	HORIZONTAL
4	5853.80	46.48	34.91	29.20	9.54	61.73	74.00	-12.27	Peak	HORIZONTAL

Note: 1. Result Level = Read Level + Antenna Factor + Cable loss - PRM Factor.
 2. If Peak Result complies with AV limit, AV Result is deemed to comply with AV limit.
 3. Test setup: RBW: 1 MHz, VBW: 3 MHz, Sweep time: auto.

TR-4-E-009 Radiated Emission Test Result

Test Site : DDT 3m Chamber 1#
Test Date : 2017-07-29
EUT : Streaming Wireless Adaptor
Power Supply : DC 5V from Adapter
Condition : Temp:24.5'C,Humi:55%,
 Press:100.1kPa
Memo : 11n 20 5180MHz

D:\2017 RE1# Report Data\17Q0626-5\RF FCC 5 G WIFI 边带.EM6
Tested By : Jerry
Model Number : ADAPT+
Test Mode : TX mode
Antenna/Distance : 2016 HF907/3m/HORIZONTAL

Data: 57

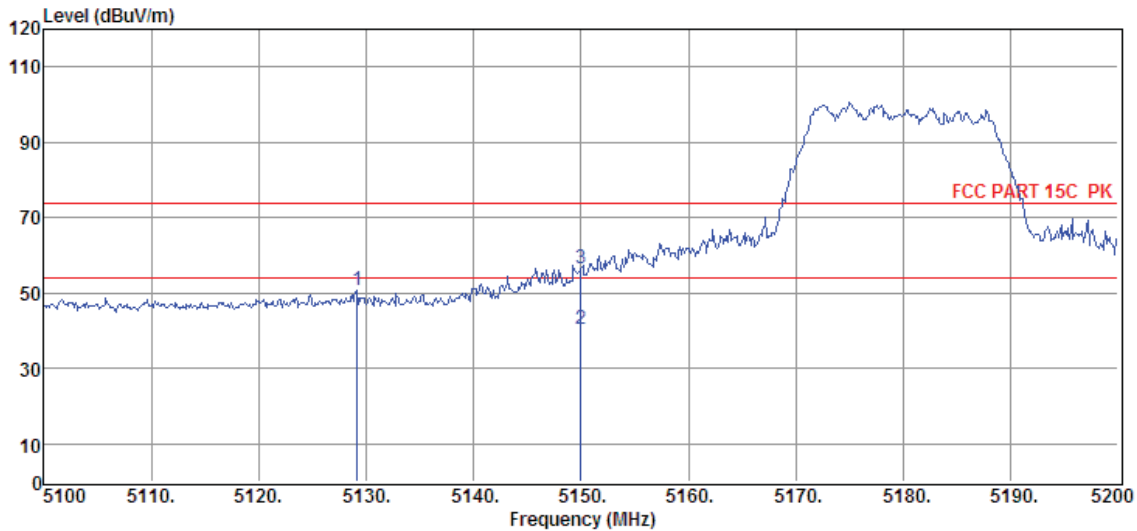

Item (Mark)	Freq. (MHz)	Read Level (dB μ V)	Antenna Factor (dB/m)	PRM Factor dB	Cable Loss dB	Result Level (dB μ V/m)	Limit Line (dB μ V/m)	Over Limit (dB)	Detector	Polarization
1	5129.20	37.23	33.97	29.34	8.80	50.66	74.00	-23.34	Peak	HORIZONTAL
2	5150.00	27.01	34.01	29.33	8.84	40.53	54.00	-13.47	Average	HORIZONTAL
3	5150.00	42.89	34.01	29.33	8.84	56.41	74.00	-17.59	Peak	HORIZONTAL

Note: 1. Result Level = Read Level + Antenna Factor + Cable loss - PRM Factor.

2. If Peak Result complies with AV limit, AV Result is deemed to comply with AV limit.

3. Test setup: RBW: 1 MHz, VBW: 3 MHz, Sweep time: auto.

TR-4-E-009 Radiated Emission Test Result

Test Site : DDT 3m Chamber 1#
Test Date : 2017-07-29
EUT : Streaming Wireless Adaptor
Power Supply : DC 5V from Adapter
Condition : Temp:24.5'C,Humi:55%,
 Press:100.1kPa
Memo : 11n 20 5180MHz

D:\2017 RE1# Report Data\17Q0626-5\RF FCC 5 G WIFI 边带.EM6
Tested By : Jerry
Model Number : ADAPT+
Test Mode : TX mode
Antenna/Distance : 2016 HF907/3m/VERTICAL

Data: 58

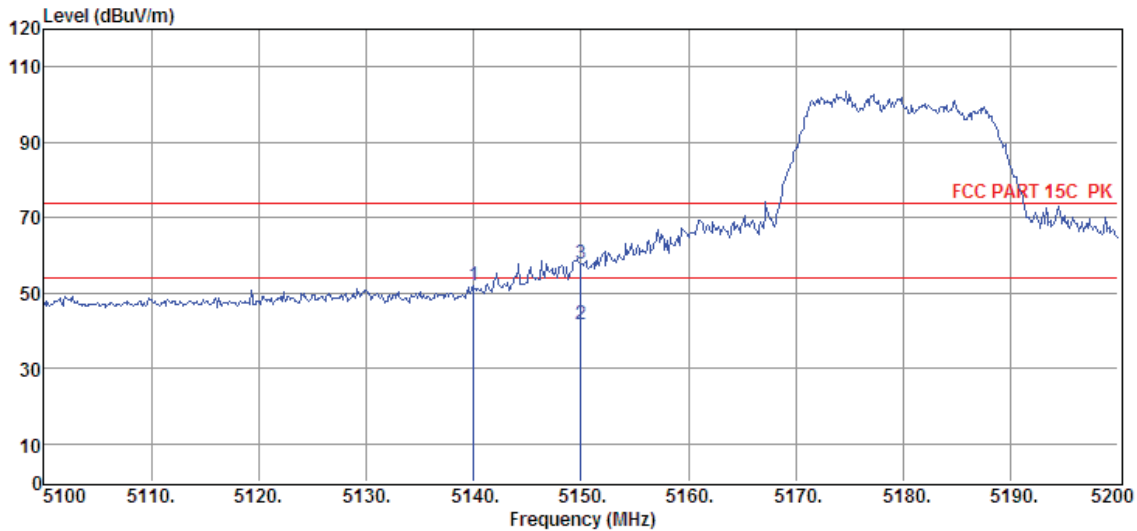

Item (Mark)	Freq. (MHz)	Read Level (dBμV)	Antenna Factor (dB/m)	PRM Factor dB	Cable Loss dB	Result Level (dBμV/m)	Limit Line (dBμV/m)	Over Limit (dB)	Detector	Polarization
1	5140.00	38.52	33.99	29.33	8.84	52.02	74.00	-21.98	Peak	VERTICAL
2	5150.00	28.32	34.01	29.33	8.84	41.84	54.00	-12.16	Average	VERTICAL
3	5150.00	44.29	34.01	29.33	8.84	57.81	74.00	-16.19	Peak	VERTICAL

Note: 1. Result Level = Read Level + Antenna Factor + Cable loss - PRM Factor.

2. If Peak Result complies with AV limit, AV Result is deemed to comply with AV limit.

3. Test setup: RBW: 1 MHz, VBW: 3 MHz, Sweep time: auto.

TR-4-E-009 Radiated Emission Test Result

Test Site : DDT 3m Chamber 1#
Test Date : 2017-07-29
EUT : Streaming Wireless Adaptor
Power Supply : DC 5V from Adapter
Condition : Temp:24.5°C,Humi:55%,
 Press:100.1kPa
Memo : 11n 20 5240MHz

D:\2017 RE1# Report Data\17Q0626-5\RF FCC 5 G WIFI 边
 带.EM6
Tested By : Jerry
Model Number : ADAPT+
Test Mode : TX mode
Antenna/Distance : 2016 HF907/3m/VERTICAL

Data: 59

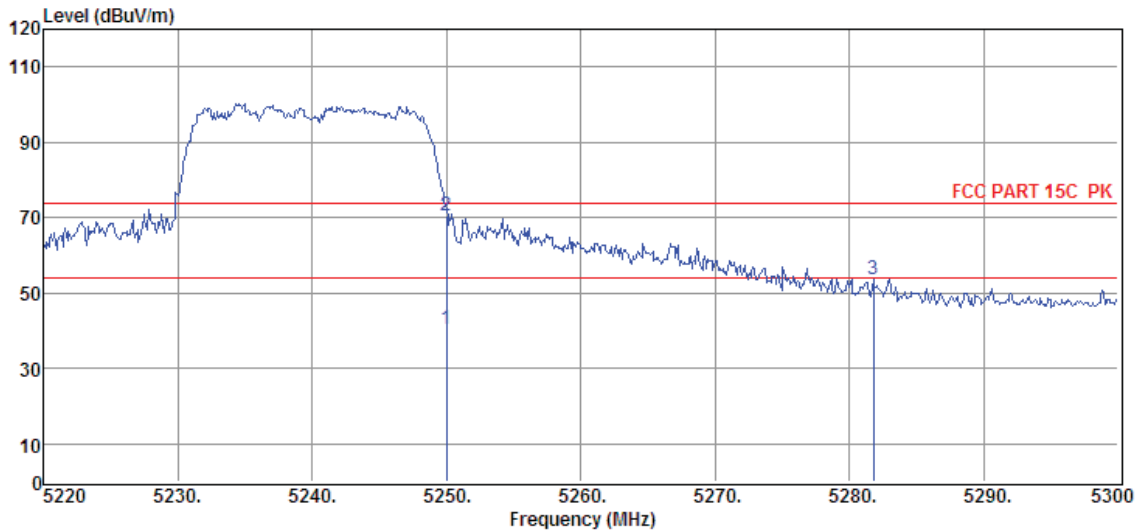

Item (Mark)	Freq. (MHz)	Read Level (dBμV)	Antenna Factor (dB/m)	PRM Factor dB	Cable Loss dB	Result Level (dBμV/m)	Limit Line (dBμV/m)	Over Limit (dB)	Detector	Polarization
1	5250.00	26.69	34.21	29.32	8.93	40.51	54.00	-13.49	Average	VERTICAL
2	5250.00	56.58	34.21	29.32	8.93	70.40	74.00	-3.60	Peak	VERTICAL
3	5281.76	39.55	34.28	29.31	8.96	53.48	74.00	-20.52	Peak	VERTICAL

Note: 1. Result Level = Read Level + Antenna Factor + Cable loss - PRM Factor.

2. If Peak Result complies with AV limit, AV Result is deemed to comply with AV limit.

3. Test setup: RBW: 1 MHz, VBW: 3 MHz, Sweep time: auto.

TR-4-E-009 Radiated Emission Test Result

Test Site : DDT 3m Chamber 1#
Test Date : 2017-07-29
EUT : Streaming Wireless Adaptor
Power Supply : DC 5V from Adapter
Condition : Temp:24.5'C,Humi:55%,
 Press:100.1kPa
Memo : 11n 20 5240MHz

D:\2017 RE1# Report Data\17Q0626-5\RF FCC 5 G WIFI 边
 带.EM6
Tested By : Jerry
Model Number : ADAPT+
Test Mode : TX mode
Antenna/Distance : 2016 HF907/3m/HORIZONTAL

Data: 60

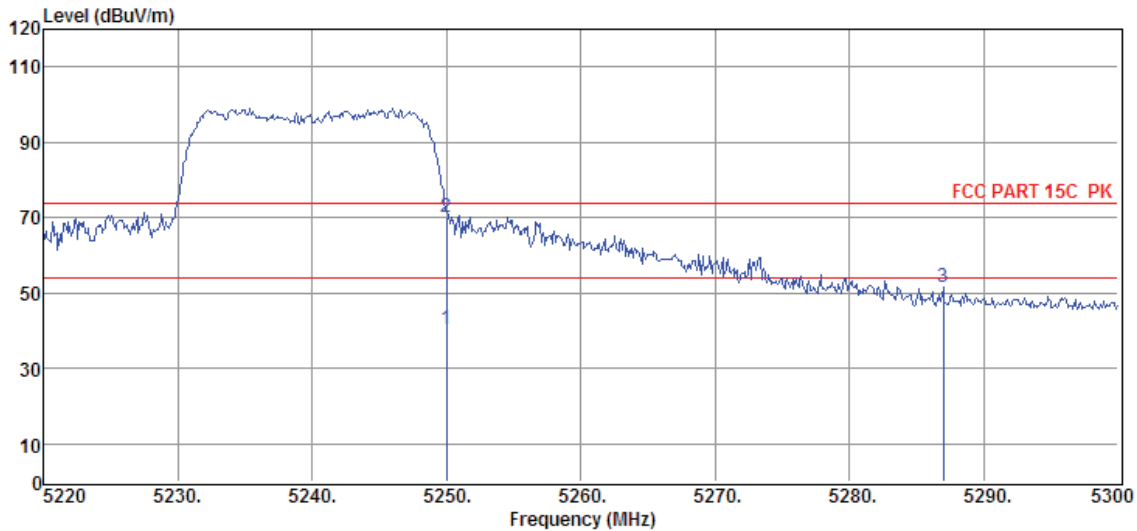

Item (Mark)	Freq. (MHz)	Read Level (dBμV)	Antenna Factor (dB/m)	PRM Factor dB	Cable Loss dB	Result Level (dBμV/m)	Limit Line (dBμV/m)	Over Limit (dB)	Detector	Polarization
1	5250.00	26.41	34.21	29.32	8.93	40.23	54.00	-13.77	Average	HORIZONTAL
2	5250.00	56.33	34.21	29.32	8.93	70.15	74.00	-3.85	Peak	HORIZONTAL
3	5286.96	37.44	34.29	29.31	8.98	51.40	74.00	-22.60	Peak	HORIZONTAL

Note: 1. Result Level = Read Level + Antenna Factor + Cable loss - PRM Factor.

2. If Peak Result complies with AV limit, AV Result is deemed to comply with AV limit.

3. Test setup: RBW: 1 MHz, VBW: 3 MHz, Sweep time: auto.

TR-4-E-009 Radiated Emission Test Result

Test Site : DDT 3m Chamber 1# D:\2017 RE1# Report Data\17Q0626-5\RF FCC 5 G WIFI 边带.EM6
Test Date : 2017-07-29 **Tested By** : Jerry
EUT : Streaming Wireless Adaptor **Model Number** : ADAPT+
Power Supply : DC 5V from Adapter **Test Mode** : TX mode
Condition : Temp:24.5'C,Humi:55%,
 Press:100.1kPa **Antenna/Distance** : 2016 HF907/3m/HORIZONTAL
Memo : 11n 20 5260MHz

Data: 61

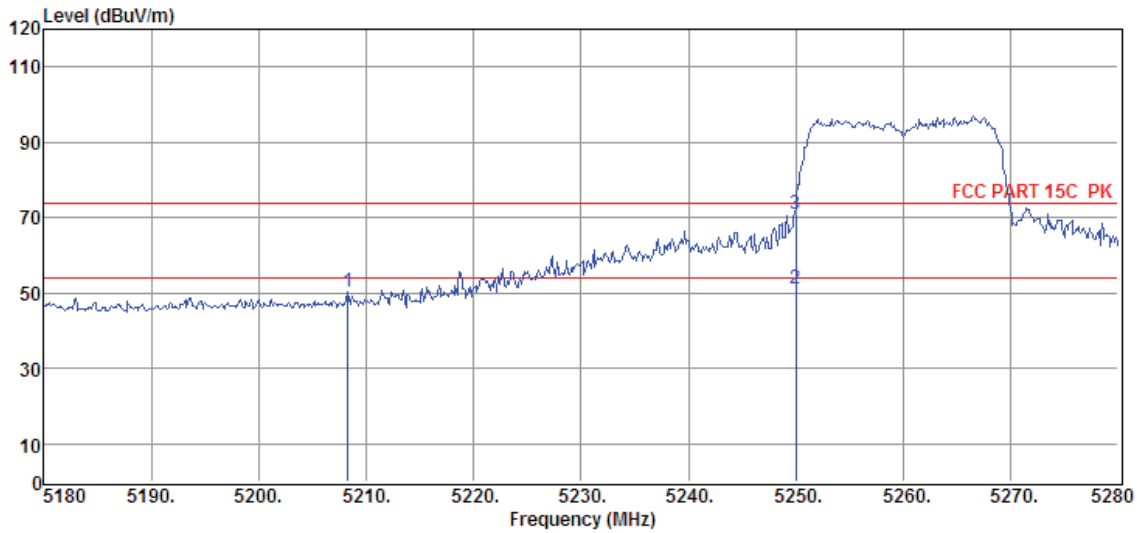

Item (Mark)	Freq. (MHz)	Read Level (dBμV)	Antenna Factor (dB/m)	PRM Factor dB	Cable Loss dB	Result Level (dBμV/m)	Limit Line (dBμV/m)	Over Limit (dB)	Detector	Polarization
1	5208.30	36.44	34.13	29.33	8.89	50.13	74.00	-23.87	Peak	HORIZONTAL
2	5250.00	37.25	34.21	29.32	8.93	51.07	54.00	-2.93	Average	HORIZONTAL
3	5250.00	57.18	34.21	29.32	8.93	71.00	74.00	-3.00	Peak	HORIZONTAL

- Note: 1. Result Level = Read Level + Antenna Factor + Cable loss - PRM Factor.
 2. If Peak Result complies with AV limit, AV Result is deemed to comply with AV limit.
 3. Test setup: RBW: 1 MHz, VBW: 3 MHz, Sweep time: auto.

TR-4-E-009 Radiated Emission Test Result

Test Site : DDT 3m Chamber 1# D:\2017 RE1# Report Data\17Q0626-5\RF FCC 5 G WIFI 边带.EM6
Test Date : 2017-07-29 **Tested By** : Jerry
EUT : Streaming Wireless Adaptor **Model Number** : ADAPT+
Power Supply : DC 5V from Adapter **Test Mode** : TX mode
Condition : Temp:24.5'C,Humi:55%,
 Press:100.1kPa **Antenna/Distance** : 2016 HF907/3m/VERTICAL
Memo : 11n 20 5260MHz

Data: 62

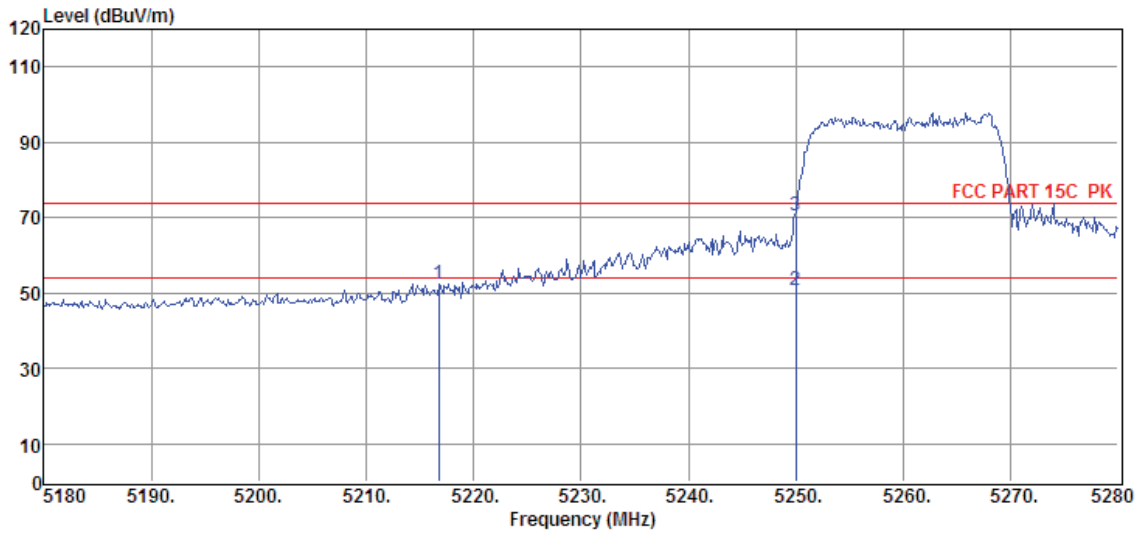

Item (Mark)	Freq. (MHz)	Read Level (dBμV)	Antenna Factor (dB/m)	PRM Factor dB	Cable Loss dB	Result Level (dBμV/m)	Limit Line (dBμV/m)	Over Limit (dB)	Detector	Polarization
1	5216.80	38.81	34.15	29.33	8.91	52.54	74.00	-21.46	Peak	VERTICAL
2	5250.00	37.00	34.21	29.32	8.93	50.82	54.00	-3.18	Average	VERTICAL
3	5250.00	56.81	34.21	29.32	8.93	70.63	74.00	-3.37	Peak	VERTICAL

- Note: 1. Result Level = Read Level + Antenna Factor + Cable loss - PRM Factor.
 2. If Peak Result complies with AV limit, AV Result is deemed to comply with AV limit.
 3. Test setup: RBW: 1 MHz, VBW: 3 MHz, Sweep time: auto.

TR-4-E-009 Radiated Emission Test Result

Test Site : DDT 3m Chamber 1# D:\2017 RE1# Report Data\17Q0626-5\RF FCC 5 G WIFI 边带.EM6
Test Date : 2017-07-29 **Tested By** : Jerry
EUT : Streaming Wireless Adaptor **Model Number** : ADAPT+
Power Supply : DC 5V from Adapter **Test Mode** : TX mode
Condition : Temp:24.5°C,Humi:55%,
 Press:100.1kPa **Antenna/Distance** : 2016 HF907/3m/VERTICAL
Memo : 11n 20 5320MHz

Data: 63

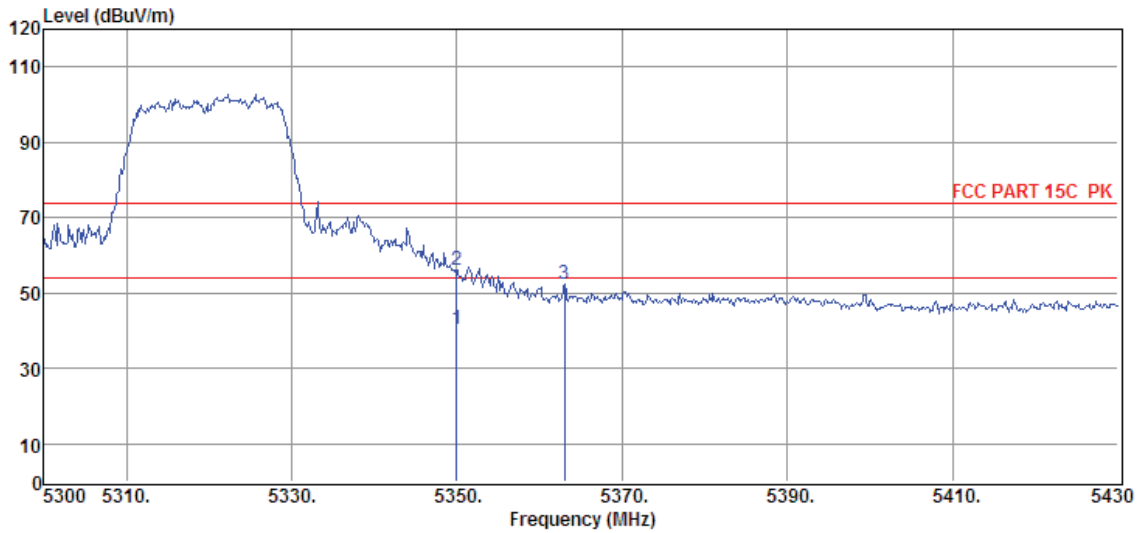

Item (Mark)	Freq. (MHz)	Read Level (dBμV)	Antenna Factor (dB/m)	PRM Factor dB	Cable Loss dB	Result Level (dBμV/m)	Limit Line (dBμV/m)	Over Limit (dB)	Detector	Polarization
1	5350.00	26.13	34.41	29.30	9.03	40.27	54.00	-13.73	Average	VERTICAL
2	5350.00	42.03	34.41	29.30	9.03	56.17	74.00	-17.83	Peak	VERTICAL
3	5363.05	38.10	34.44	29.30	9.05	52.29	74.00	-21.71	Peak	VERTICAL

Note: 1. Result Level = Read Level + Antenna Factor + Cable loss - PRM Factor.
 2. If Peak Result complies with AV limit, AV Result is deemed to comply with AV limit.
 3. Test setup: RBW: 1 MHz, VBW: 3 MHz, Sweep time: auto.

TR-4-E-009 Radiated Emission Test Result

Test Site : DDT 3m Chamber 1# D:\2017 RE1# Report Data\17Q0626-5\RF FCC 5 G WIFI 边带.EM6
Test Date : 2017-07-29 **Tested By** : Jerry
EUT : Streaming Wireless Adaptor **Model Number** : ADAPT+
Power Supply : DC 5V from Adapter **Test Mode** : TX mode
Condition : Temp:24.5'C,Humi:55%,
 Press:100.1kPa **Antenna/Distance** : 2016 HF907/3m/HORIZONTAL
Memo : 11n 20 5320MHz

Data: 64

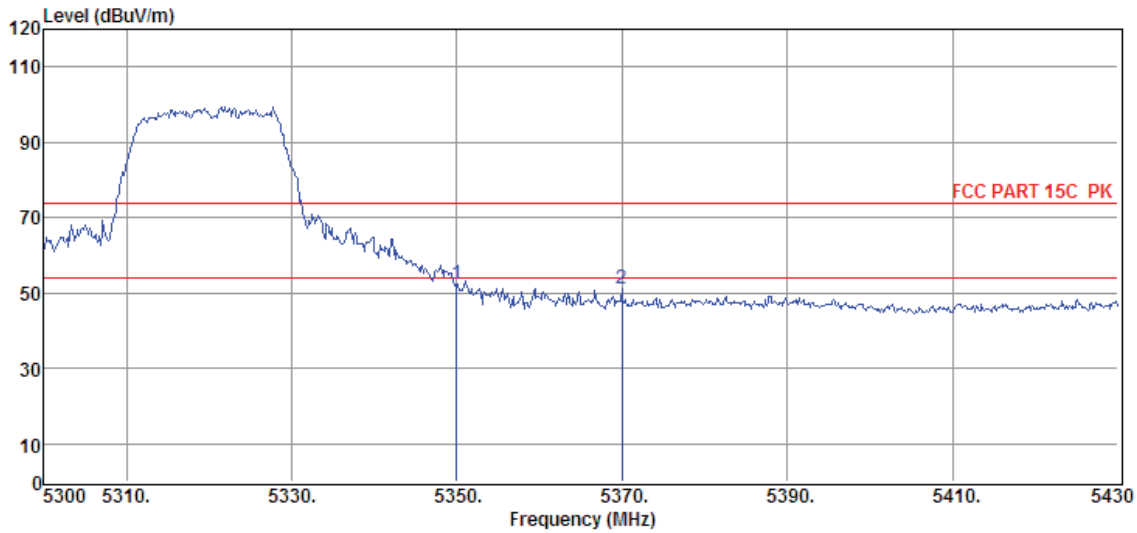

Item (Mark)	Freq. (MHz)	Read Level (dBμV)	Antenna Factor (dB/m)	PRM Factor dB	Cable Loss dB	Result Level (dBμV/m)	Limit Line (dBμV/m)	Over Limit (dB)	Detector	Polarization
1	5350.00	38.35	34.41	29.30	9.03	52.49	74.00	-21.51	Peak	HORIZONTAL
2	5369.94	36.84	34.45	29.30	9.05	51.04	74.00	-22.96	Peak	HORIZONTAL

- Note: 1. Result Level = Read Level + Antenna Factor + Cable loss - PRM Factor.
 2. If Peak Result complies with AV limit, AV Result is deemed to comply with AV limit.
 3. Test setup: RBW: 1 MHz, VBW: 3 MHz, Sweep time: auto.

TR-4-E-009 Radiated Emission Test Result

Test Site	: DDT 3m Chamber 1#	D:\2017 RE1# Report Data\17Q0626-5\RF FCC 5 G WIFI 边带.EM6
Test Date	: 2017-07-29	Tested By : Jerry
EUT	: Streaming Wireless Adaptor	Model Number : ADAPT+
Power Supply	: DC 5V from Adapter	Test Mode : TX mode
Condition	: Temp:24.5°C,Humi:55%, Press:100.1kPa	Antenna/Distance : 2016 HF907/3m/HORIZONTAL
Memo	: 11n 20 5500MHz	

Data: 65

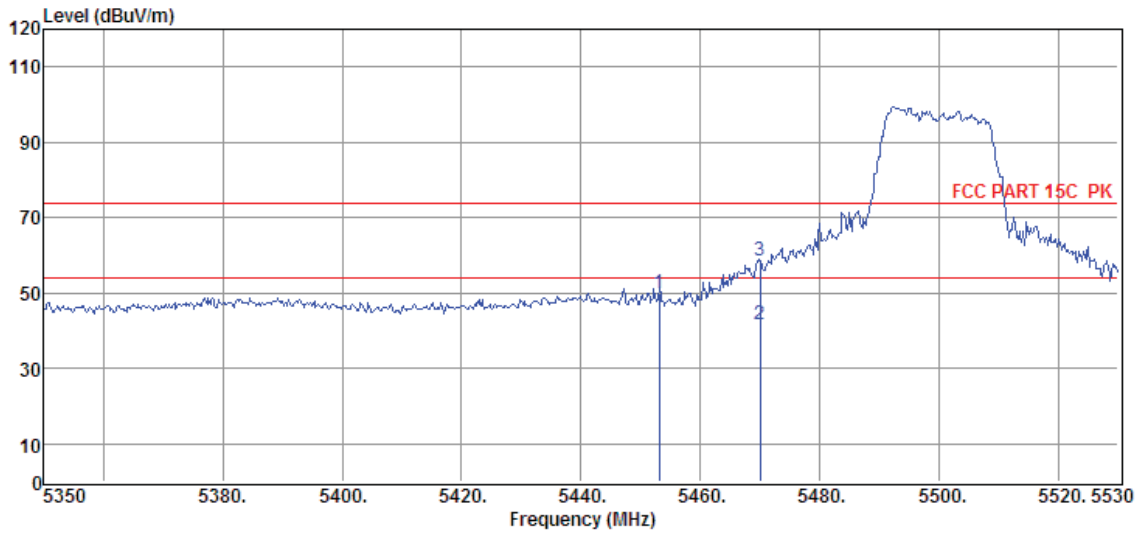

Item (Mark)	Freq. (MHz)	Read Level (dBμV)	Antenna Factor (dB/m)	PRM Factor dB	Cable Loss dB	Result Level (dBμV/m)	Limit Line (dBμV/m)	Over Limit (dB)	Detector	Polarization
1	5453.14	35.23	34.61	29.28	9.14	49.70	74.00	-24.30	Peak	HORIZONTAL
2	5470.00	27.26	34.64	29.27	9.16	41.79	54.00	-12.21	Average	HORIZONTAL
3	5470.00	44.14	34.64	29.27	9.16	58.67	74.00	-15.33	Peak	HORIZONTAL

Note: 1. Result Level = Read Level + Antenna Factor + Cable loss - PRM Factor.
 2. If Peak Result complies with AV limit, AV Result is deemed to comply with AV limit.
 3. Test setup: RBW: 1 MHz, VBW: 3 MHz, Sweep time: auto.

TR-4-E-009 Radiated Emission Test Result

Test Site : DDT 3m Chamber 1# D:\2017 RE1# Report Data\17Q0626-5\RF FCC 5 G WIFI 边带.EM6
Test Date : 2017-07-29 **Tested By** : Jerry
EUT : Streaming Wireless Adaptor **Model Number** : ADAPT+
Power Supply : DC 5V from Adapter **Test Mode** : TX mode
Condition : Temp:24.5'C,Humi:55%,
 Press:100.1kPa **Antenna/Distance** : 2016 HF907/3m/VERTICAL
Memo : 11n 20 5500MHz

Data: 66

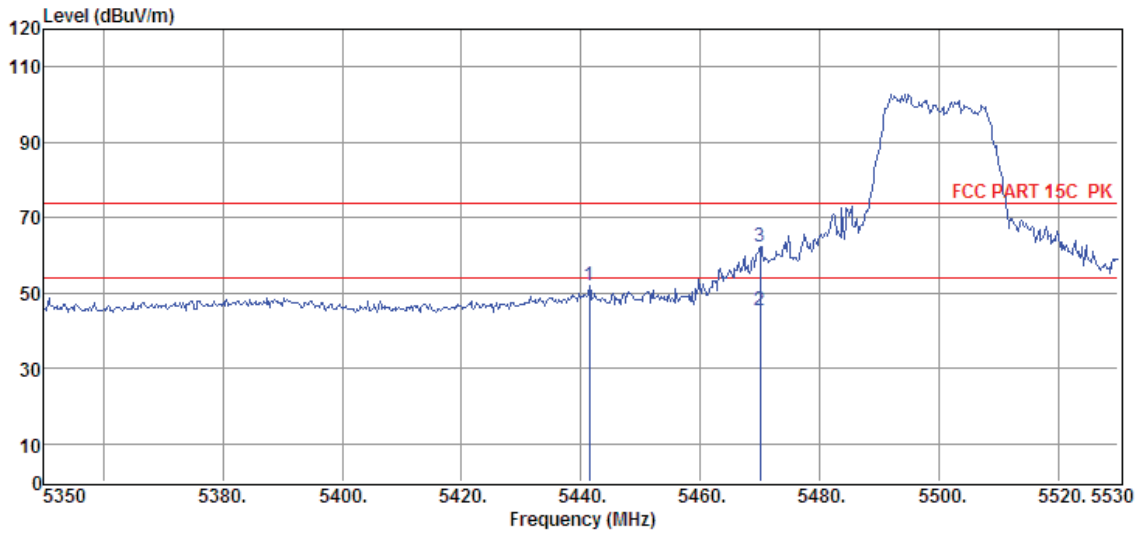

Item (Mark)	Freq. (MHz)	Read Level (dBμV)	Antenna Factor (dB/m)	PRM Factor dB	Cable Loss dB	Result Level (dBμV/m)	Limit Line (dBμV/m)	Over Limit (dB)	Detector	Polarization
1	5441.44	37.61	34.59	29.28	9.14	52.06	74.00	-21.94	Peak	VERTICAL
2	5470.00	30.96	34.64	29.27	9.16	45.49	54.00	-8.51	Average	VERTICAL
3	5470.00	47.87	34.64	29.27	9.16	62.40	74.00	-11.60	Peak	VERTICAL

- Note: 1. Result Level = Read Level + Antenna Factor + Cable loss - PRM Factor.
 2. If Peak Result complies with AV limit, AV Result is deemed to comply with AV limit.
 3. Test setup: RBW: 1 MHz, VBW: 3 MHz, Sweep time: auto.

TR-4-E-009 Radiated Emission Test Result

Test Site : DDT 3m Chamber 1# D:\2017 RE1# Report Data\17Q0626-5\RF FCC 5 G WIFI 边带.EM6
Test Date : 2017-07-29 **Tested By** : Jerry
EUT : Streaming Wireless Adaptor **Model Number** : ADAPT+
Power Supply : DC 5V from Adapter **Test Mode** : TX mode
Condition : Temp:24.5'C,Humi:55%,
 Press:100.1kPa **Antenna/Distance** : 2016 HF907/3m/HORIZONTAL
Memo : 11n 20 5700MHz

Data: 67

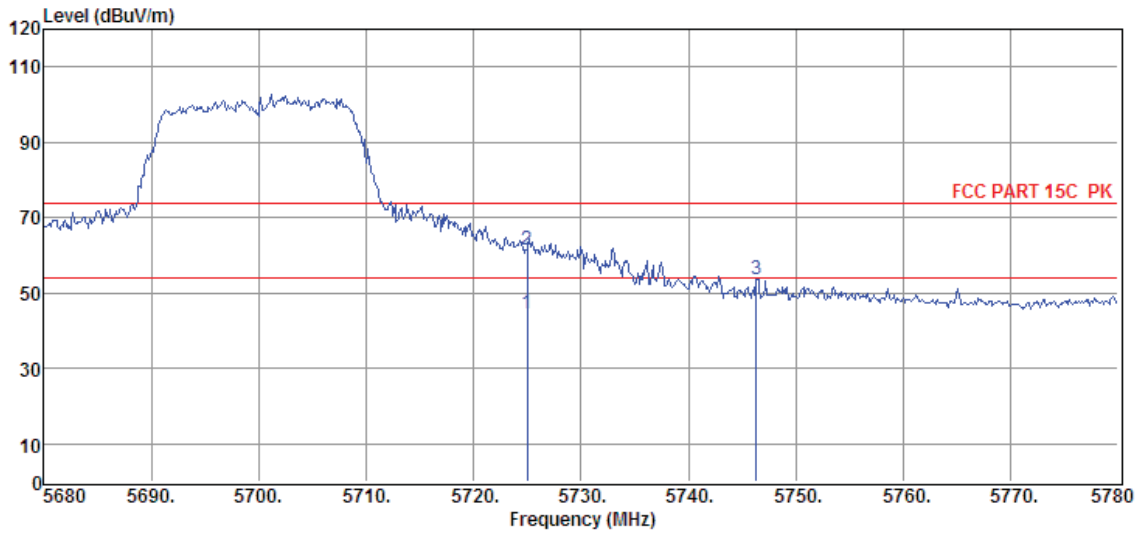

Item (Mark)	Freq. (MHz)	Read Level (dBμV)	Antenna Factor (dB/m)	PRM Factor dB	Cable Loss dB	Result Level (dBμV/m)	Limit Line (dBμV/m)	Over Limit (dB)	Detector	Polarization
1	5725.00	29.51	34.84	29.22	9.41	44.54	54.00	-9.46	Average	HORIZONTAL
2	5725.00	46.48	34.84	29.22	9.41	61.51	74.00	-12.49	Peak	HORIZONTAL
3	5746.30	38.54	34.85	29.21	9.43	53.61	74.00	-20.39	Peak	HORIZONTAL

- Note: 1. Result Level = Read Level + Antenna Factor + Cable loss - PRM Factor.
 2. If Peak Result complies with AV limit, AV Result is deemed to comply with AV limit.
 3. Test setup: RBW: 1 MHz, VBW: 3 MHz, Sweep time: auto.

TR-4-E-009 Radiated Emission Test Result

Test Site : DDT 3m Chamber 1# D:\2017 RE1# Report Data\17Q0626-5\RF FCC 5 G WIFI 边带.EM6
Test Date : 2017-07-29 **Tested By** : Jerry
EUT : Streaming Wireless Adaptor **Model Number** : ADAPT+
Power Supply : DC 5V from Adapter **Test Mode** : TX mode
Condition : Temp:24.5'C,Humi:55%,
 Press:100.1kPa **Antenna/Distance** : 2016 HF907/3m/VERTICAL
Memo : 11n 20 5700MHz

Data: 68

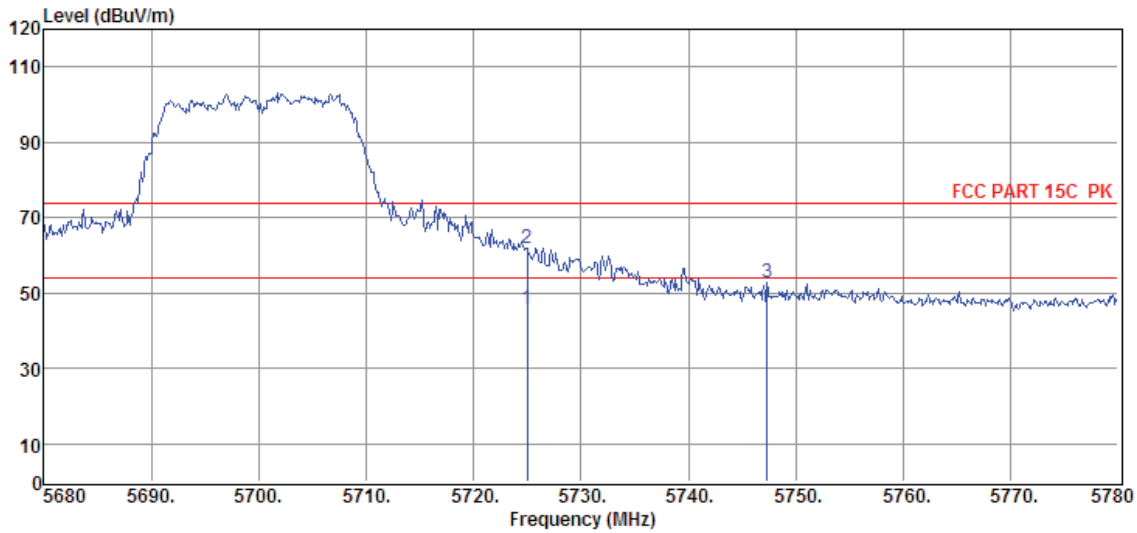

Item (Mark)	Freq. (MHz)	Read Level (dBμV)	Antenna Factor (dB/m)	PRM Factor dB	Cable Loss dB	Result Level (dBμV/m)	Limit Line (dBμV/m)	Over Limit (dB)	Detector	Polarization
1	5725.00	30.91	34.84	29.22	9.41	45.94	54.00	-8.06	Average	VERTICAL
2	5725.00	46.83	34.84	29.22	9.41	61.86	74.00	-12.14	Peak	VERTICAL
3	5747.30	37.82	34.85	29.21	9.43	52.89	74.00	-21.11	Peak	VERTICAL

Note: 1. Result Level = Read Level + Antenna Factor + Cable loss - PRM Factor.
 2. If Peak Result complies with AV limit, AV Result is deemed to comply with AV limit.
 3. Test setup: RBW: 1 MHz, VBW: 3 MHz, Sweep time: auto.

TR-4-E-009 Radiated Emission Test Result

Test Site : DDT 3m Chamber 1#
Test Date : 2017-07-29
EUT : Streaming Wireless Adaptor
Power Supply : DC 5V from Adapter
Condition : Temp:24.5'C,Humi:55%,
 Press:100.1kPa
Memo : 11n 20 5745MHz

D:\2017 RE1# Report Data\17Q0626-5\RF FCC 5 G WIFI 边
 带.EM6
Tested By : Jerry
Model Number : ADAPT+
Test Mode : TX mode
Antenna/Distance : 2016 HF907/3m/VERTICAL

Data: 69

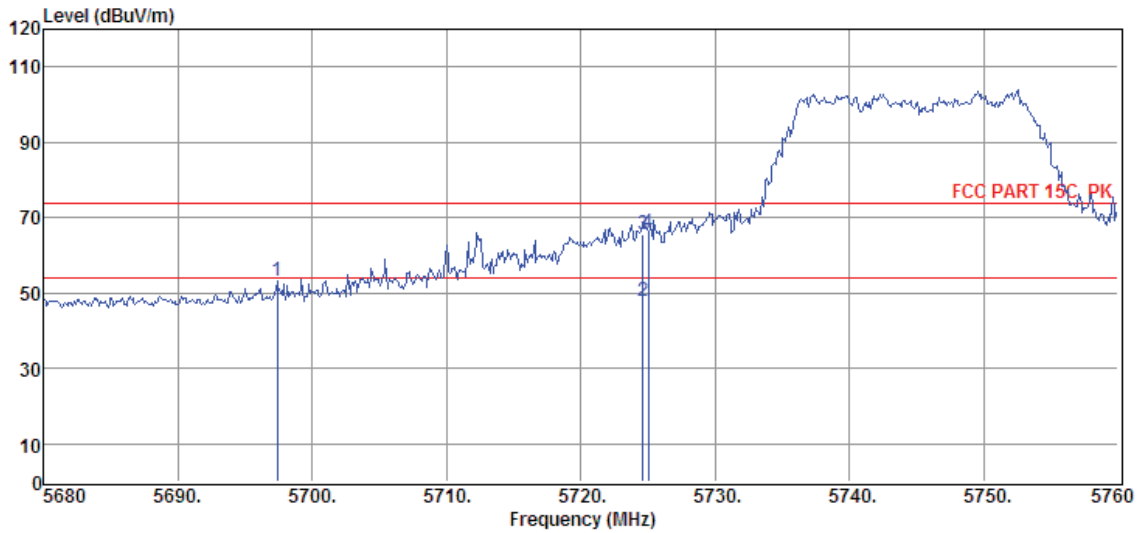

Item (Mark)	Freq. (MHz)	Read Level (dBμV)	Antenna Factor (dB/m)	PRM Factor dB	Cable Loss dB	Result Level (dBμV/m)	Limit Line (dBμV/m)	Over Limit (dB)	Detector	Polarization
1	5697.36	38.24	34.82	29.22	9.38	53.22	74.00	-20.78	Peak	VERTICAL
2	5725.00	32.85	34.84	29.22	9.41	47.88	54.00	-6.12	Average	VERTICAL
3	5725.00	50.57	34.84	29.22	9.41	65.60	74.00	-8.40	Peak	VERTICAL

- Note: 1. Result Level = Read Level + Antenna Factor + Cable loss - PRM Factor.
 2. If Peak Result complies with AV limit, AV Result is deemed to comply with AV limit.
 3. Test setup: RBW: 1 MHz, VBW: 3 MHz, Sweep time: auto.

TR-4-E-009 Radiated Emission Test Result

Test Site : DDT 3m Chamber 1# D:\2017 RE1# Report Data\17Q0626-5\RF FCC 5 G WIFI 边带.EM6
Test Date : 2017-07-29 **Tested By** : Jerry
EUT : Streaming Wireless Adaptor **Model Number** : ADAPT+
Power Supply : DC 5V from Adapter **Test Mode** : TX mode
Condition : Temp:24.5'C,Humi:55%,
 Press:100.1kPa **Antenna/Distance** : 2016 HF907/3m/HORIZONTAL
Memo : 11n 20 5745MHz

Data: 70

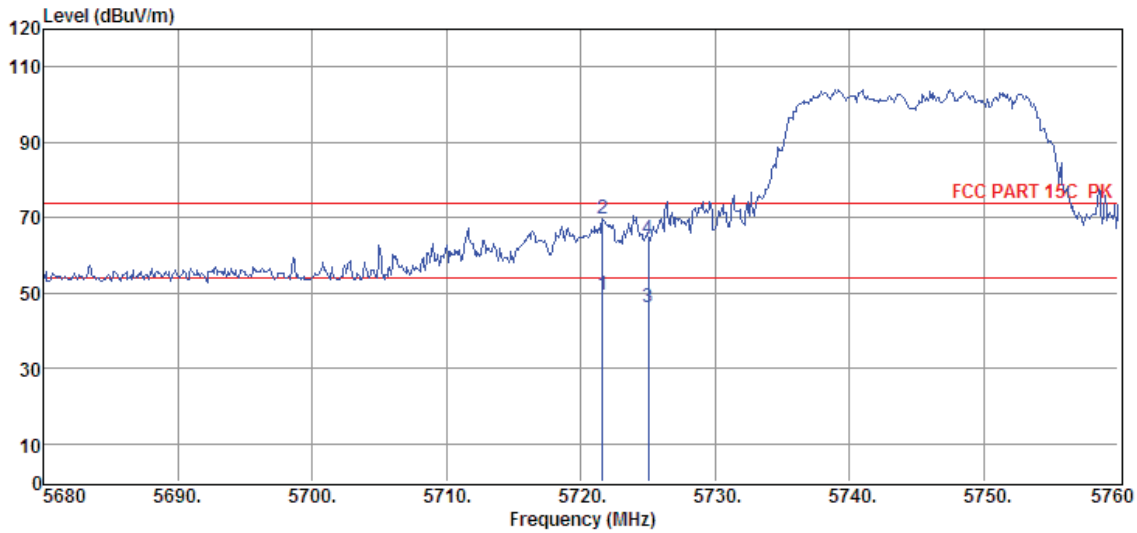

Item (Mark)	Freq. (MHz)	Read Level (dBμV)	Antenna Factor (dB/m)	PRM Factor dB	Cable Loss dB	Result Level (dBμV/m)	Limit Line (dBμV/m)	Over Limit (dB)	Detector	Polarization
1	5721.60	34.61	34.84	29.22	9.41	49.64	54.00	-4.36	Average	HORIZONTAL
2	5721.60	54.51	34.84	29.22	9.41	69.54	74.00	-4.46	Peak	HORIZONTAL
3	5725.00	31.35	34.84	29.22	9.41	46.38	54.00	-7.62	Average	HORIZONTAL
4	5725.00	49.25	34.84	29.22	9.41	64.28	74.00	-9.72	Peak	HORIZONTAL

Note: 1. Result Level = Read Level + Antenna Factor + Cable loss - PRM Factor.
 2. If Peak Result complies with AV limit, AV Result is deemed to comply with AV limit.
 3. Test setup: RBW: 1 MHz, VBW: 3 MHz, Sweep time: auto.

TR-4-E-009 Radiated Emission Test Result

Test Site : DDT 3m Chamber 1#
Test Date : 2017-07-29
EUT : Streaming Wireless Adaptor
Power Supply : DC 5V from Adapter
Condition : Temp:24.5°C,Humi:55%,
 Press:100.1kPa
Memo : 11n 20 5825MHz

D:\2017 RE1# Report Data\17Q0626-5\RF FCC 5 G WIFI 边
 带.EM6
Tested By : Jerry
Model Number : ADAPT+
Test Mode : TX mode
Antenna/Distance : 2016 HF907/3m/HORIZONTAL

Data: 71

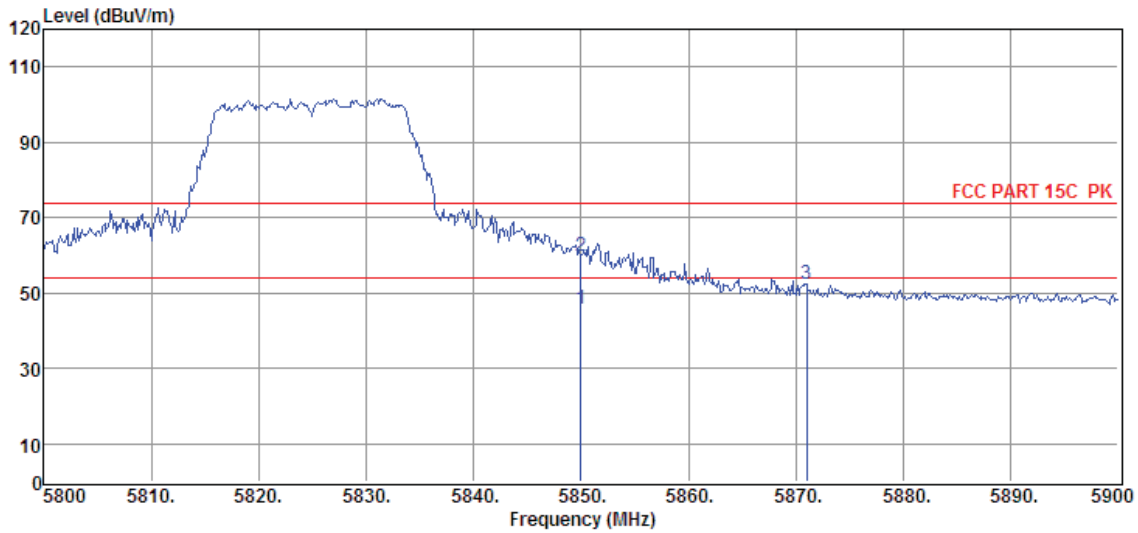

Item (Mark)	Freq. (MHz)	Read Level (dBμV)	Antenna Factor (dB/m)	PRM Factor dB	Cable Loss dB	Result Level (dBμV/m)	Limit Line (dBμV/m)	Over Limit (dB)	Detector	Polarization
1	5850.00	30.72	34.91	29.20	9.54	45.97	54.00	-8.03	Average	HORIZONTAL
2	5850.00	44.62	34.91	29.20	9.54	59.87	74.00	-14.13	Peak	HORIZONTAL
3	5871.00	37.07	34.93	29.20	9.56	52.36	74.00	-21.64	Peak	HORIZONTAL

Note: 1. Result Level = Read Level + Antenna Factor + Cable loss - PRM Factor.

2. If Peak Result complies with AV limit, AV Result is deemed to comply with AV limit.

3. Test setup: RBW: 1 MHz, VBW: 3 MHz, Sweep time: auto.

TR-4-E-009 Radiated Emission Test Result

Test Site : DDT 3m Chamber 1#
Test Date : 2017-07-29
EUT : Streaming Wireless Adaptor
Power Supply : DC 5V from Adapter
Condition : Temp:24.5°C,Humi:55%,
 Press:100.1kPa
Memo : 11n 20 5825MHz

D:\2017 RE1# Report Data\17Q0626-5\RF FCC 5 G WIFI 边
 带.EM6
Tested By : Jerry
Model Number : ADAPT+
Test Mode : TX mode
Antenna/Distance : 2016 HF907/3m/VERTICAL

Data: 72

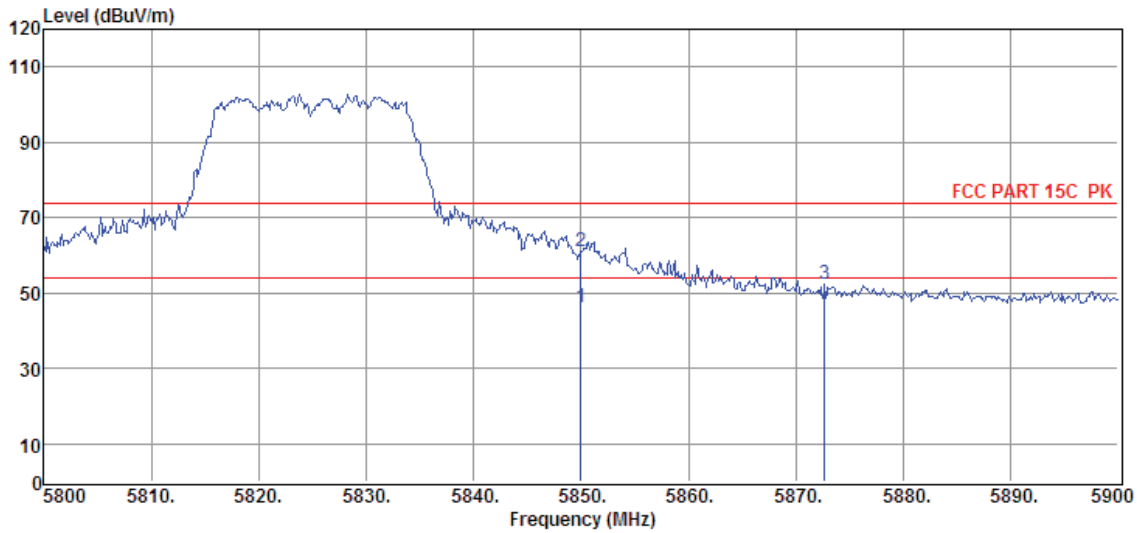

Item (Mark)	Freq. (MHz)	Read Level (dB μ V)	Antenna Factor (dB/m)	PRM Factor dB	Cable Loss dB	Result Level (dB μ V/m)	Limit Line (dB μ V/m)	Over Limit (dB)	Detector	Polarization
1	5850.00	30.91	34.91	29.20	9.54	46.16	54.00	-7.84	Average	VERTICAL
2	5850.00	45.80	34.91	29.20	9.54	61.05	74.00	-12.95	Peak	VERTICAL
3	5872.70	36.98	34.93	29.20	9.56	52.27	74.00	-21.73	Peak	VERTICAL

Note: 1. Result Level = Read Level + Antenna Factor + Cable loss - PRM Factor.

2. If Peak Result complies with AV limit, AV Result is deemed to comply with AV limit.

3. Test setup: RBW: 1 MHz, VBW: 3 MHz, Sweep time: auto.

TR-4-E-009 Radiated Emission Test Result

Test Site : DDT 3m Chamber 1# D:\2017 RE1# Report Data\17Q0626-5\RF FCC 5 G WIFI 边带.EM6
Test Date : 2017-07-29 **Tested By** : Jerry
EUT : Streaming Wireless Adaptor **Model Number** : ADAPT+
Power Supply : DC 5V from Adapter **Test Mode** : TX mode
Condition : Temp:24.5°C,Humi:55%,
 Press:100.1kPa **Antenna/Distance** : 2016 HF907/3m/VERTICAL
Memo : 11n 40 5190MHz

Data: 73

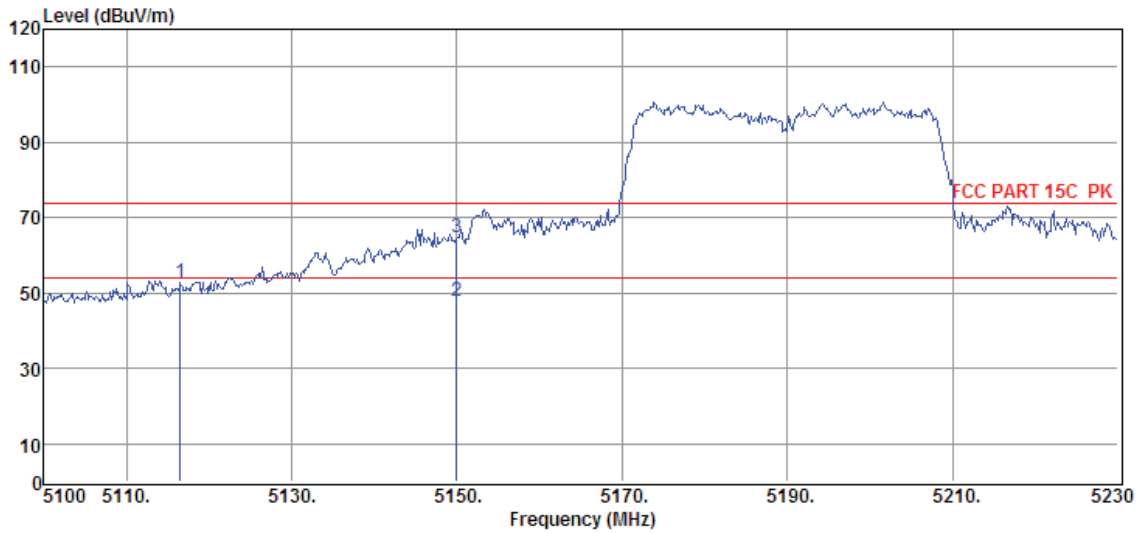

Item (Mark)	Freq. (MHz)	Read Level (dBμV)	Antenna Factor (dB/m)	PRM Factor dB	Cable Loss dB	Result Level (dBμV/m)	Limit Line (dBμV/m)	Over Limit (dB)	Detector	Polarization
1	5116.51	39.47	33.94	29.34	8.80	52.87	74.00	-21.13	Peak	VERTICAL
2	5150.00	34.40	34.01	29.33	8.84	47.92	54.00	-6.08	Average	VERTICAL
3	5150.00	51.30	34.01	29.33	8.84	64.82	74.00	-9.18	Peak	VERTICAL

- Note: 1. Result Level = Read Level + Antenna Factor + Cable loss - PRM Factor.
 2. If Peak Result complies with AV limit, AV Result is deemed to comply with AV limit.
 3. Test setup: RBW: 1 MHz, VBW: 3 MHz, Sweep time: auto.

TR-4-E-009 Radiated Emission Test Result

Test Site : DDT 3m Chamber 1# D:\2017 RE1# Report Data\17Q0626-5\RF FCC 5 G WIFI 边带.EM6
Test Date : 2017-07-29 **Tested By** : Jerry
EUT : Streaming Wireless Adaptor **Model Number** : ADAPT+
Power Supply : DC 5V from Adapter **Test Mode** : TX mode
Condition : Temp:24.5°C,Humi:55%,
 Press:100.1kPa **Antenna/Distance** : 2016 HF907/3m/HORIZONTAL
Memo : 11n 40 5190MHz

Data: 74

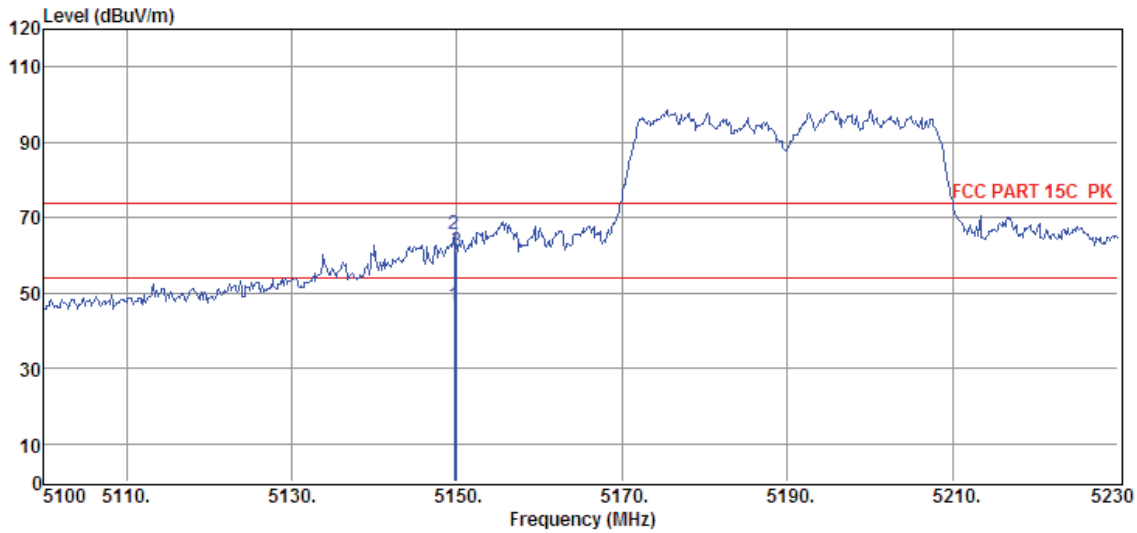

Item (Mark)	Freq. (MHz)	Read Level (dBμV)	Antenna Factor (dB/m)	PRM Factor dB	Cable Loss dB	Result Level (dBμV/m)	Limit Line (dBμV/m)	Over Limit (dB)	Detector	Polarization
1	5149.66	32.92	34.01	29.33	8.84	46.44	54.00	-7.56	Average	HORIZONTAL
2	5149.66	51.88	34.01	29.33	8.84	65.40	74.00	-8.60	Peak	HORIZONTAL
3	5150.00	47.64	34.01	29.33	8.84	61.16	74.00	-12.84	Peak	HORIZONTAL

- Note: 1. Result Level = Read Level + Antenna Factor + Cable loss - PRM Factor.
 2. If Peak Result complies with AV limit, AV Result is deemed to comply with AV limit.
 3. Test setup: RBW: 1 MHz, VBW: 3 MHz, Sweep time: auto.

TR-4-E-009 Radiated Emission Test Result

Test Site : DDT 3m Chamber 1# D:\2017 RE1# Report Data\17Q0626-5\RF FCC 5 G WIFI 边带.EM6
Test Date : 2017-07-29 **Tested By** : Jerry
EUT : Streaming Wireless Adaptor **Model Number** : ADAPT+
Power Supply : DC 5V from Adapter **Test Mode** : TX mode
Condition : Temp:24.5°C,Humi:55%,
 Press:100.1kPa **Antenna/Distance** : 2016 HF907/3m/VERTICAL
Memo : 11n 40 5230MHz

Data: 75

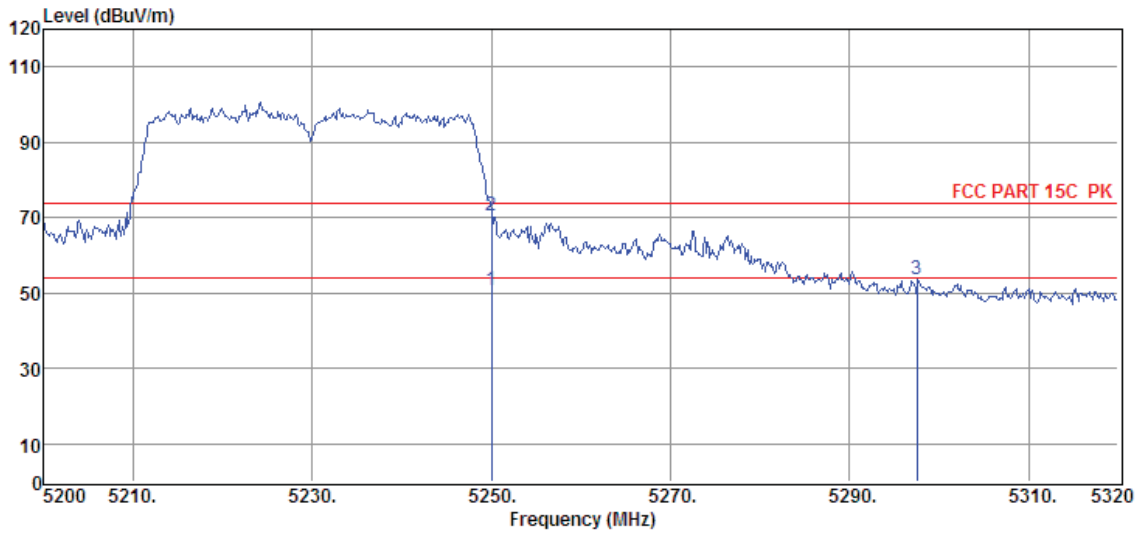

Item (Mark)	Freq. (MHz)	Read Level (dBμV)	Antenna Factor (dB/m)	PRM Factor dB	Cable Loss dB	Result Level (dBμV/m)	Limit Line (dBμV/m)	Over Limit (dB)	Detector	Polarization
1	5250.00	36.81	34.21	29.32	8.93	50.63	54.00	-3.37	Average	VERTICAL
2	5250.00	56.76	34.21	29.32	8.93	70.58	74.00	-3.42	Peak	VERTICAL
3	5297.56	39.52	34.31	29.31	8.98	53.50	74.00	-20.50	Peak	VERTICAL

- Note: 1. Result Level = Read Level + Antenna Factor + Cable loss - PRM Factor.
 2. If Peak Result complies with AV limit, AV Result is deemed to comply with AV limit.
 3. Test setup: RBW: 1 MHz, VBW: 3 MHz, Sweep time: auto.

TR-4-E-009 Radiated Emission Test Result

Test Site : DDT 3m Chamber 1#
Test Date : 2017-07-29
EUT : Streaming Wireless Adaptor
Power Supply : DC 5V from Adapter
Condition : Temp:24.5°C,Humi:55%,
 Press:100.1kPa
Memo : 11n 40 5230MHz

D:\2017 RE1# Report Data\17Q0626-5\RF FCC 5 G WIFI 边
 带.EM6
Tested By : Jerry
Model Number : ADAPT+
Test Mode : TX mode
Antenna/Distance : 2016 HF907/3m/HORIZONTAL

Data: 76

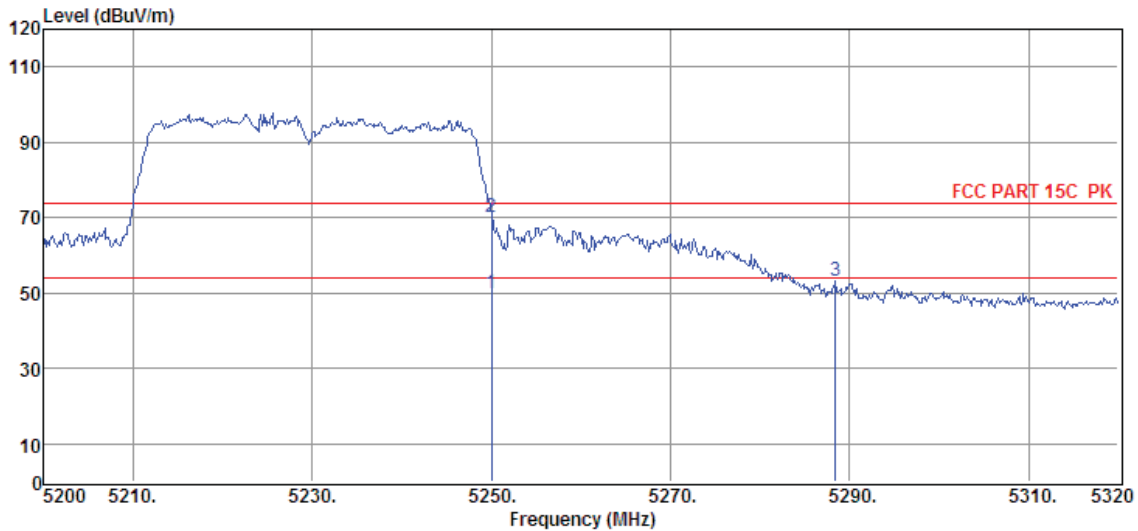

Item (Mark)	Freq. (MHz)	Read Level (dBμV)	Antenna Factor (dB/m)	PRM Factor dB	Cable Loss dB	Result Level (dBμV/m)	Limit Line (dBμV/m)	Over Limit (dB)	Detector	Polarization
1	5250.00	36.25	34.21	29.32	8.93	50.07	54.00	-3.93	Average	HORIZONTAL
2	5250.00	56.19	34.21	29.32	8.93	70.01	74.00	-3.99	Peak	HORIZONTAL
3	5288.44	39.23	34.29	29.31	8.98	53.19	74.00	-20.81	Peak	HORIZONTAL

Note: 1. Result Level = Read Level + Antenna Factor + Cable loss - PRM Factor.

2. If Peak Result complies with AV limit, AV Result is deemed to comply with AV limit.

3. Test setup: RBW: 1 MHz, VBW: 3 MHz, Sweep time: auto.

TR-4-E-009 Radiated Emission Test Result

Test Site : DDT 3m Chamber 1# D:\2017 RE1# Report Data\17Q0626-5\RF FCC 5 G WIFI 边带.EM6
Test Date : 2017-07-29 **Tested By** : Jerry
EUT : Streaming Wireless Adaptor **Model Number** : ADAPT+
Power Supply : DC 5V from Adapter **Test Mode** : TX mode
Condition : Temp:24.5'C,Humi:55%,
 Press:100.1kPa **Antenna/Distance** : 2016 HF907/3m/HORIZONTAL
Memo : 11n 40 5270MHz

Data: 77

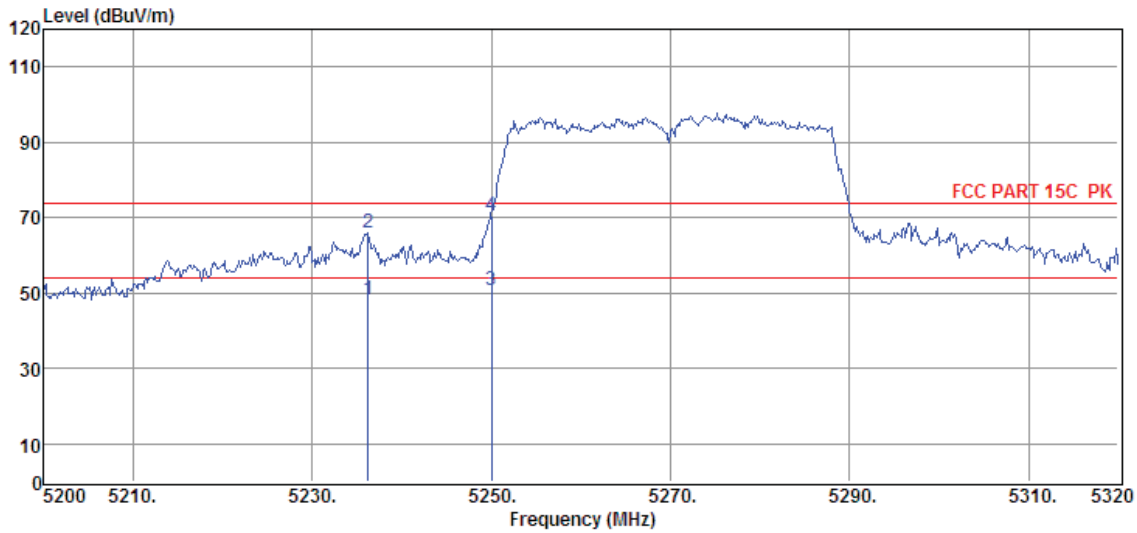

Item (Mark)	Freq. (MHz)	Read Level (dBμV)	Antenna Factor (dB/m)	PRM Factor dB	Cable Loss dB	Result Level (dBμV/m)	Limit Line (dBμV/m)	Over Limit (dB)	Detector	Polarization
1	5236.24	34.33	34.18	29.32	8.91	48.10	54.00	-5.90	Average	HORIZONTAL
2	5236.24	52.27	34.18	29.32	8.91	66.04	74.00	-7.96	Peak	HORIZONTAL
3	5250.00	36.93	34.21	29.32	8.93	50.75	54.00	-3.25	Average	HORIZONTAL
4	5250.00	56.87	34.21	29.32	8.93	70.69	74.00	-3.31	Peak	HORIZONTAL

Note: 1. Result Level = Read Level + Antenna Factor + Cable loss - PRM Factor.
 2. If Peak Result complies with AV limit, AV Result is deemed to comply with AV limit.
 3. Test setup: RBW: 1 MHz, VBW: 3 MHz, Sweep time: auto.

TR-4-E-009 Radiated Emission Test Result

Test Site : DDT 3m Chamber 1# D:\2017 RE1# Report Data\17Q0626-5\RF FCC 5 G WIFI 边带.EM6
Test Date : 2017-07-29 **Tested By** : Jerry
EUT : Streaming Wireless Adaptor **Model Number** : ADAPT+
Power Supply : DC 5V from Adapter **Test Mode** : TX mode
Condition : Temp:24.5'C,Humi:55%,
 Press:100.1kPa **Antenna/Distance** : 2016 HF907/3m/VERTICAL
Memo : 11n 40 5270MHz

Data: 78

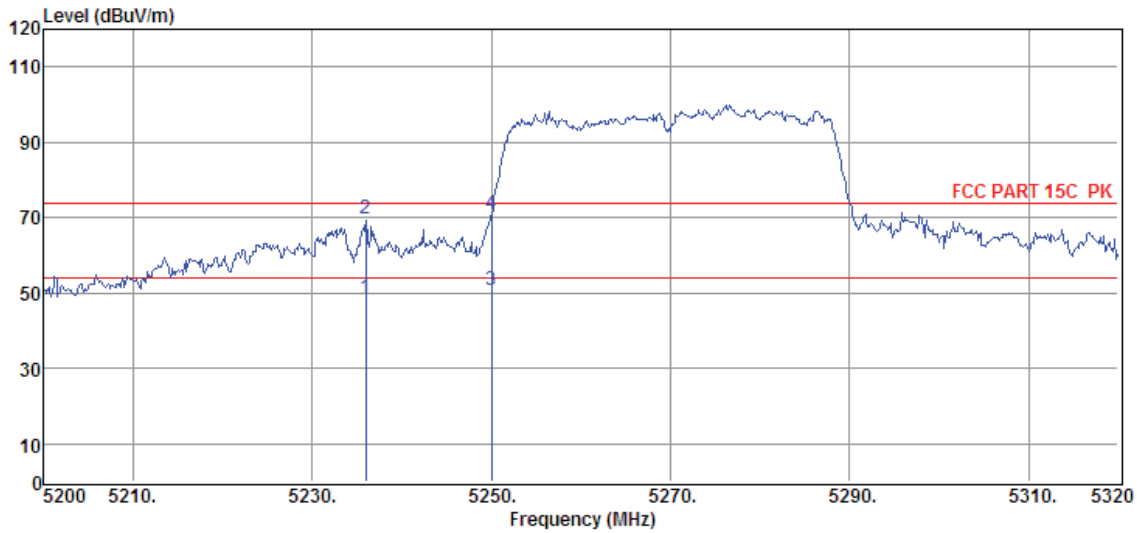

Item (Mark)	Freq. (MHz)	Read Level (dBμV)	Antenna Factor (dB/m)	PRM Factor dB	Cable Loss dB	Result Level (dBμV/m)	Limit Line (dBμV/m)	Over Limit (dB)	Detector	Polarization
1	5236.00	34.97	34.18	29.32	8.91	48.74	54.00	-5.26	Average	VERTICAL
2	5236.00	55.82	34.18	29.32	8.91	69.59	74.00	-4.41	Peak	VERTICAL
3	5250.00	37.02	34.21	29.32	8.93	50.84	54.00	-3.16	Average	VERTICAL
4	5250.00	56.93	34.21	29.32	8.93	70.75	74.00	-3.25	Peak	VERTICAL

- Note: 1. Result Level = Read Level + Antenna Factor + Cable loss - PRM Factor.
 2. If Peak Result complies with AV limit, AV Result is deemed to comply with AV limit.
 3. Test setup: RBW: 1 MHz, VBW: 3 MHz, Sweep time: auto.

TR-4-E-009 Radiated Emission Test Result

Test Site : DDT 3m Chamber 1#
Test Date : 2017-07-29
EUT : Streaming Wireless Adaptor
Power Supply : DC 5V from Adapter
Condition : Temp:24.5'C,Humi:55%,
 Press:100.1kPa
Memo : 11n 40 5310MHz

D:\2017 RE1# Report Data\17Q0626-5\RF FCC 5 G WIFI 边
 带.EM6
Tested By : Jerry
Model Number : ADAPT+
Test Mode : TX mode
Antenna/Distance : 2016 HF907/3m/VERTICAL

Data: 79

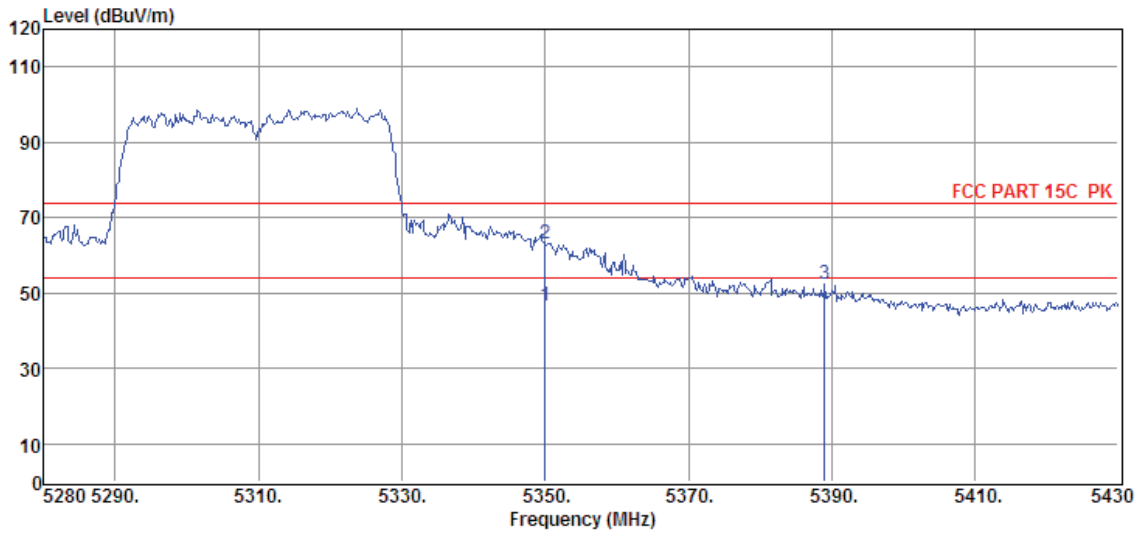

Item (Mark)	Freq. (MHz)	Read Level (dB μ V)	Antenna Factor (dB/m)	PRM Factor dB	Cable Loss dB	Result Level (dB μ V/m)	Limit Line (dB μ V/m)	Over Limit (dB)	Detector	Polarization
1	5350.00	32.26	34.41	29.30	9.03	46.40	54.00	-7.60	Average	VERTICAL
2	5350.00	49.15	34.41	29.30	9.03	63.29	74.00	-10.71	Peak	VERTICAL
3	5389.05	37.94	34.49	29.30	9.09	52.22	74.00	-21.78	Peak	VERTICAL

Note: 1. Result Level = Read Level + Antenna Factor + Cable loss - PRM Factor.

2. If Peak Result complies with AV limit, AV Result is deemed to comply with AV limit.

3. Test setup: RBW: 1 MHz, VBW: 3 MHz, Sweep time: auto.

TR-4-E-009 Radiated Emission Test Result

Test Site : DDT 3m Chamber 1#
Test Date : 2017-07-29
EUT : Streaming Wireless Adaptor
Power Supply : DC 5V from Adapter
Condition : Temp:24.5'C,Humi:55%,
 Press:100.1kPa
Memo : 11n 40 5310MHz

D:\2017 RE1# Report Data\17Q0626-5\RF FCC 5 G WIFI 边
 带.EM6
Tested By : Jerry
Model Number : ADAPT+
Test Mode : TX mode
Antenna/Distance : 2016 HF907/3m/HORIZONTAL

Data: 80

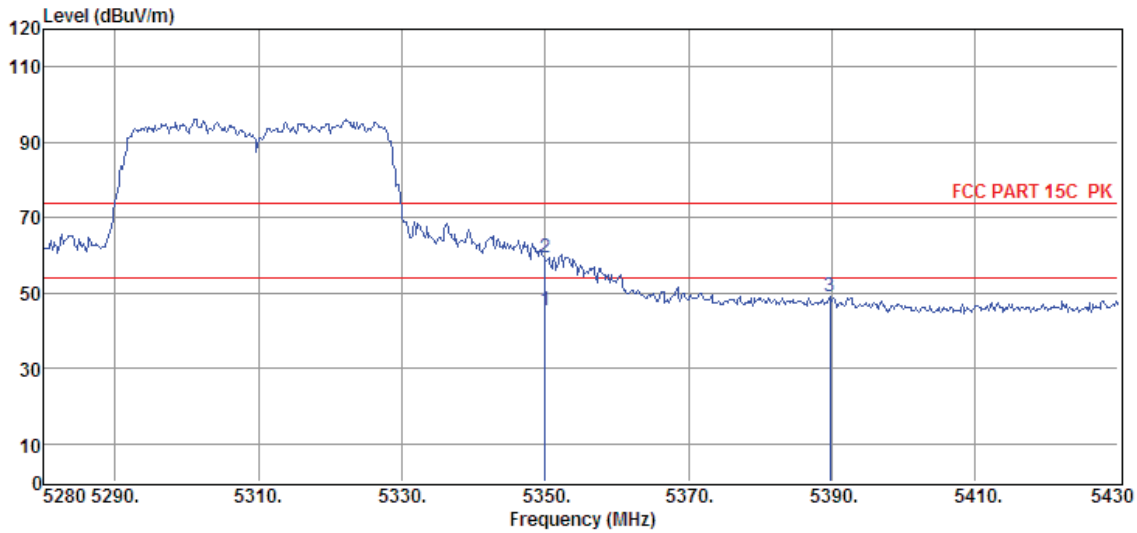

Item (Mark)	Freq. (MHz)	Read Level (dBμV)	Antenna Factor (dB/m)	PRM Factor dB	Cable Loss dB	Result Level (dBμV/m)	Limit Line (dBμV/m)	Over Limit (dB)	Detector	Polarization
1	5350.00	31.34	34.41	29.30	9.03	45.48	54.00	-8.52	Average	HORIZONTAL
2	5350.00	45.25	34.41	29.30	9.03	59.39	74.00	-14.61	Peak	HORIZONTAL
3	5389.80	34.99	34.49	29.30	9.09	49.27	74.00	-24.73	Peak	HORIZONTAL

Note: 1. Result Level = Read Level + Antenna Factor + Cable loss - PRM Factor.

2. If Peak Result complies with AV limit, AV Result is deemed to comply with AV limit.

3. Test setup: RBW: 1 MHz, VBW: 3 MHz, Sweep time: auto.

TR-4-E-009 Radiated Emission Test Result

Test Site : DDT 3m Chamber 1#
Test Date : 2017-07-29
EUT : Streaming Wireless Adaptor
Power Supply : DC 5V from Adapter
Condition : Temp:24.5°C,Humi:55%,
 Press:100.1kPa
Memo : 11n 40 5510MHz

D:\2017 RE1# Report Data\17Q0626-5\RF FCC 5 G WIFI 边
 带.EM6
Tested By : Jerry
Model Number : ADAPT+
Test Mode : TX mode
Antenna/Distance : 2016 HF907/3m/HORIZONTAL

Data: 81

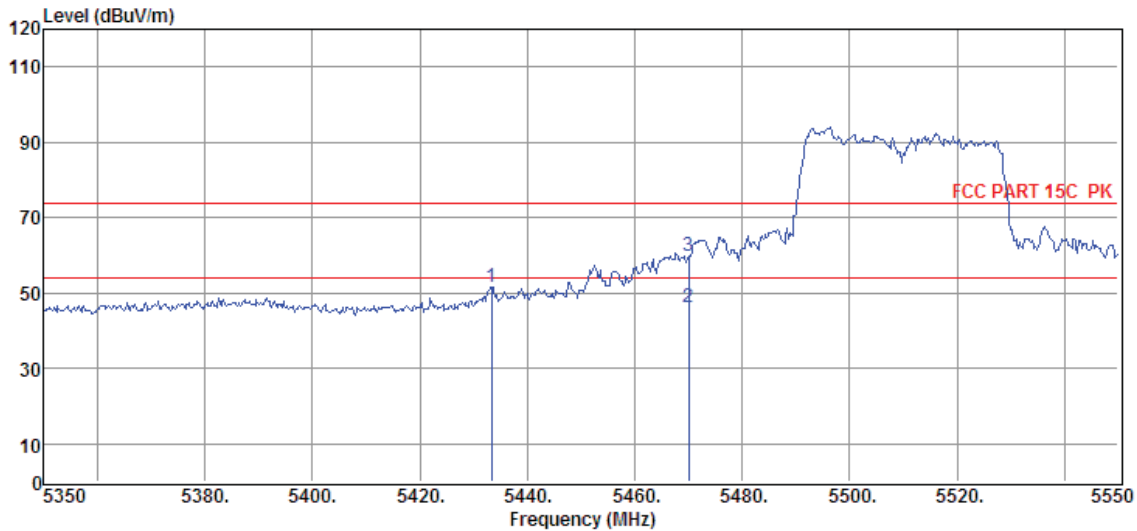

Item (Mark)	Freq. (MHz)	Read Level (dBμV)	Antenna Factor (dB/m)	PRM Factor dB	Cable Loss dB	Result Level (dBμV/m)	Limit Line (dBμV/m)	Over Limit (dB)	Detector	Polarization
1	5433.40	37.30	34.57	29.28	9.11	51.70	74.00	-22.30	Peak	HORIZONTAL
2	5470.00	31.57	34.64	29.27	9.16	46.10	54.00	-7.90	Average	HORIZONTAL
3	5470.00	45.45	34.64	29.27	9.16	59.98	74.00	-14.02	Peak	HORIZONTAL

Note: 1. Result Level = Read Level + Antenna Factor + Cable loss - PRM Factor.

2. If Peak Result complies with AV limit, AV Result is deemed to comply with AV limit.

3. Test setup: RBW: 1 MHz, VBW: 3 MHz, Sweep time: auto.

TR-4-E-009 Radiated Emission Test Result

Test Site : DDT 3m Chamber 1#
Test Date : 2017-07-29
EUT : Streaming Wireless Adaptor
Power Supply : DC 5V from Adapter
Condition : Temp:24.5'C,Humi:55%,
 Press:100.1kPa
Memo : 11n 40 5510MHz

D:\2017 RE1# Report Data\17Q0626-5\RF FCC 5 G WIFI 边
 带.EM6
Tested By : Jerry
Model Number : ADAPT+
Test Mode : TX mode
Antenna/Distance : 2016 HF907/3m/VERTICAL

Data: 82

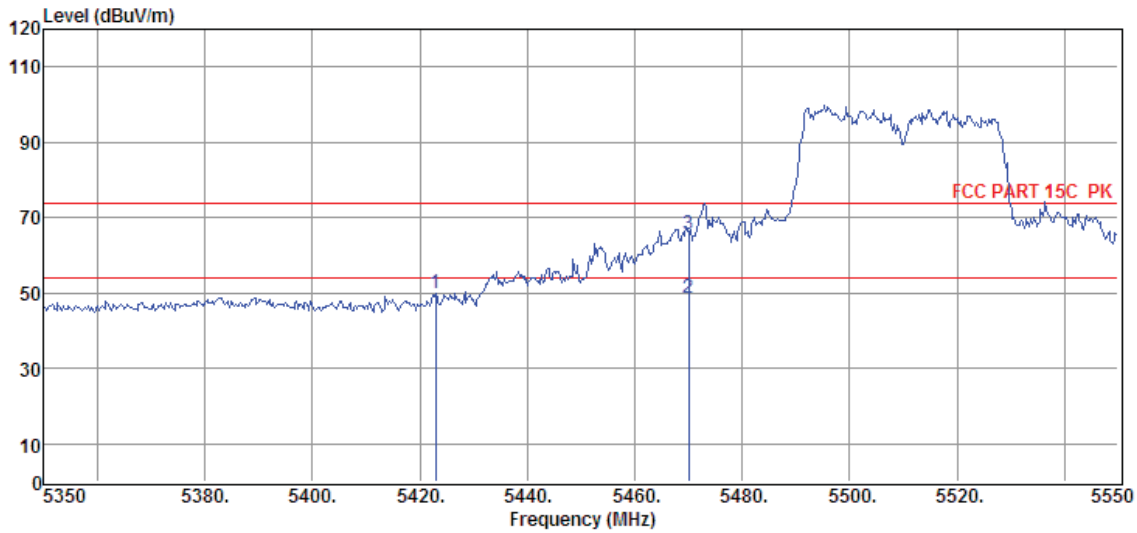

Item (Mark)	Freq. (MHz)	Read Level (dBμV)	Antenna Factor (dB/m)	PRM Factor dB	Cable Loss dB	Result Level (dBμV/m)	Limit Line (dBμV/m)	Over Limit (dB)	Detector	Polarization
1	5423.00	35.50	34.55	29.28	9.11	49.88	74.00	-24.12	Peak	VERTICAL
2	5470.00	34.15	34.64	29.27	9.16	48.68	54.00	-5.32	Average	VERTICAL
3	5470.00	51.05	34.64	29.27	9.16	65.58	74.00	-8.42	Peak	VERTICAL

- Note: 1. Result Level = Read Level + Antenna Factor + Cable loss - PRM Factor.
 2. If Peak Result complies with AV limit, AV Result is deemed to comply with AV limit.
 3. Test setup: RBW: 1 MHz, VBW: 3 MHz, Sweep time: auto.

TR-4-E-009 Radiated Emission Test Result

Test Site : DDT 3m Chamber 1#
Test Date : 2017-07-29
EUT : Streaming Wireless Adaptor
Power Supply : DC 5V from Adapter
Condition : Temp:24.5'C,Humi:55%,
 Press:100.1kPa
Memo : 11n 40 5670MHz

D:\2017 RE1# Report Data\17Q0626-5\RF FCC 5 G WIFI 边
 带.EM6
Tested By : Jerry
Model Number : ADAPT+
Test Mode : TX mode
Antenna/Distance : 2016 HF907/3m/HORIZONTAL

Data: 83

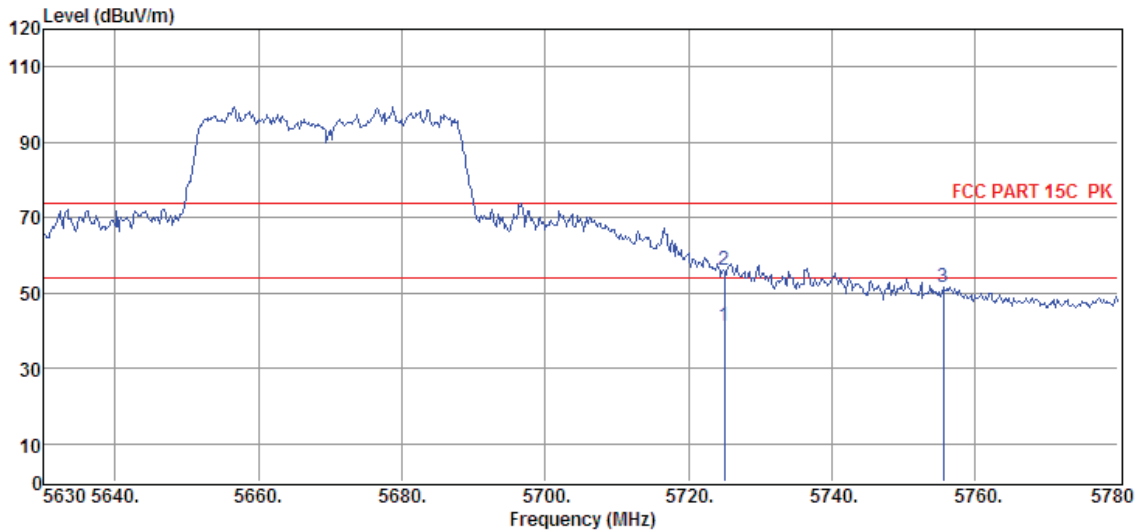

Item (Mark)	Freq. (MHz)	Read Level (dB μ V)	Antenna Factor (dB/m)	PRM Factor dB	Cable Loss dB	Result Level (dB μ V/m)	Limit Line (dB μ V/m)	Over Limit (dB)	Detector	Polarization
1	5725.00	26.34	34.84	29.22	9.41	41.37	54.00	-12.63	Average	HORIZONTAL
2	5725.00	41.25	34.84	29.22	9.41	56.28	74.00	-17.72	Peak	HORIZONTAL
3	5755.55	36.55	34.86	29.21	9.43	51.63	74.00	-22.37	Peak	HORIZONTAL

Note: 1. Result Level = Read Level + Antenna Factor + Cable loss - PRM Factor.

2. If Peak Result complies with AV limit, AV Result is deemed to comply with AV limit.

3. Test setup: RBW: 1 MHz, VBW: 3 MHz, Sweep time: auto.

TR-4-E-009 Radiated Emission Test Result

Test Site : DDT 3m Chamber 1#
Test Date : 2017-07-29
EUT : Streaming Wireless Adaptor
Power Supply : DC 5V from Adapter
Condition : Temp:24.5'C,Humi:55%,
 Press:100.1kPa
Memo : 11n 40 5670MHz

D:\2017 RE1# Report Data\17Q0626-5\RF FCC 5 G WIFI 边
 带.EM6
Tested By : Jerry
Model Number : ADAPT+
Test Mode : TX mode
Antenna/Distance : 2016 HF907/3m/VERTICAL

Data: 84

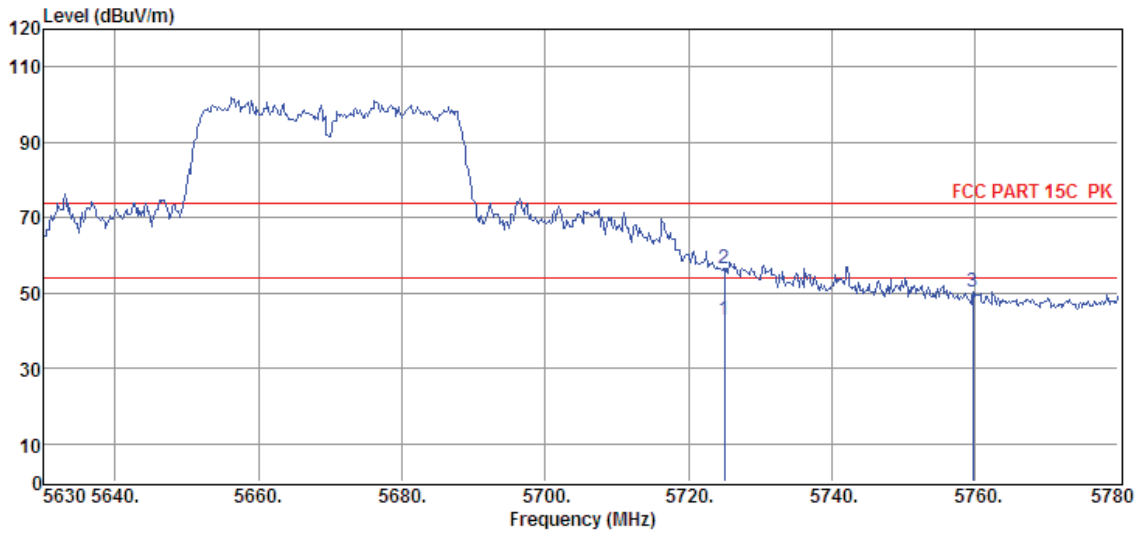

Item (Mark)	Freq. (MHz)	Read Level (dBμV)	Antenna Factor (dB/m)	PRM Factor dB	Cable Loss dB	Result Level (dBμV/m)	Limit Line (dBμV/m)	Over Limit (dB)	Detector	Polarization
1	5725.00	27.71	34.84	29.22	9.41	42.74	54.00	-11.26	Average	VERTICAL
2	5725.00	41.60	34.84	29.22	9.41	56.63	74.00	-17.37	Peak	VERTICAL
3	5759.75	35.15	34.86	29.21	9.43	50.23	74.00	-23.77	Peak	VERTICAL

Note: 1. Result Level = Read Level + Antenna Factor + Cable loss - PRM Factor.

2. If Peak Result complies with AV limit, AV Result is deemed to comply with AV limit.

3. Test setup: RBW: 1 MHz, VBW: 3 MHz, Sweep time: auto.

TR-4-E-009 Radiated Emission Test Result

Test Site : DDT 3m Chamber 1# D:\2017 RE1# Report Data\17Q0626-5\RF FCC 5 G WIFI 边带.EM6
Test Date : 2017-07-29 **Tested By** : Jerry
EUT : Streaming Wireless Adaptor **Model Number** : ADAPT+
Power Supply : DC 5V from Adapter **Test Mode** : TX mode
Condition : Temp:24.5'C,Humi:55%,
 Press:100.1kPa **Antenna/Distance** : 2016 HF907/3m/VERTICAL
Memo : 11n 40 5755MHz

Data: 85

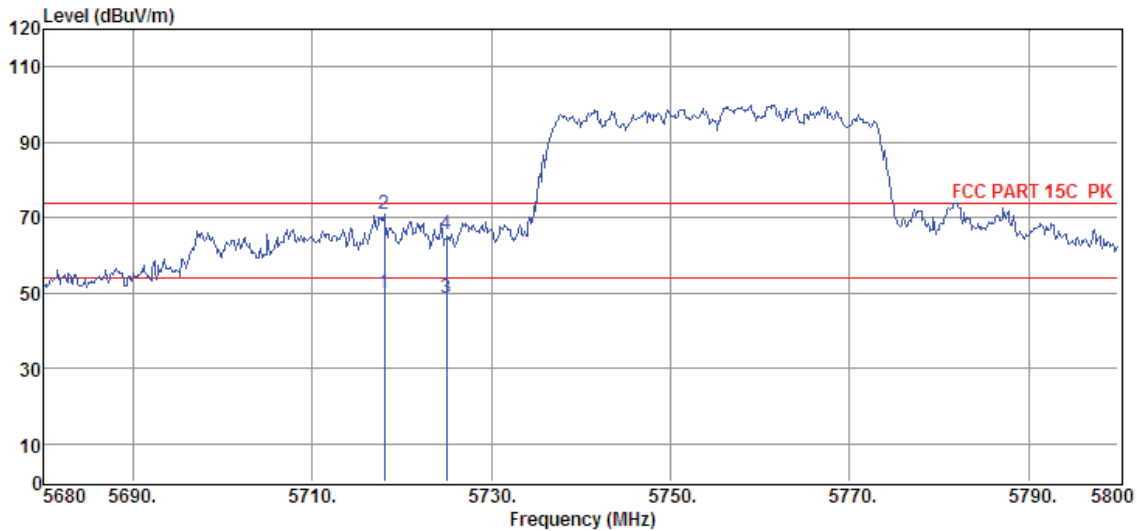

Item (Mark)	Freq. (MHz)	Read Level (dB μ V)	Antenna Factor (dB/m)	PRM Factor dB	Cable Loss dB	Result Level (dB μ V/m)	Limit Line (dB μ V/m)	Over Limit (dB)	Detector	Polarization
1	5718.04	34.82	34.83	29.22	9.41	49.84	54.00	-4.16	Average	VERTICAL
2	5718.04	55.73	34.83	29.22	9.41	70.75	74.00	-3.25	Peak	VERTICAL
3	5725.00	33.72	34.84	29.22	9.41	48.75	54.00	-5.25	Average	VERTICAL
4	5725.00	50.63	34.84	29.22	9.41	65.66	74.00	-8.34	Peak	VERTICAL

- Note: 1. Result Level = Read Level + Antenna Factor + Cable loss - PRM Factor.
 2. If Peak Result complies with AV limit, AV Result is deemed to comply with AV limit.
 3. Test setup: RBW: 1 MHz, VBW: 3 MHz, Sweep time: auto.

TR-4-E-009 Radiated Emission Test Result

Test Site : DDT 3m Chamber 1#
Test Date : 2017-07-29
EUT : Streaming Wireless Adaptor
Power Supply : DC 5V from Adapter
Condition : Temp:24.5'C,Humi:55%,
 Press:100.1kPa
Memo : 11n 40 5755MHz

D:\2017 RE1# Report Data\17Q0626-5\RF FCC 5 G WIFI 边
 带.EM6
Tested By : Jerry
Model Number : ADAPT+
Test Mode : TX mode
Antenna/Distance : 2016 HF907/3m/VERTICAL

Data: 86

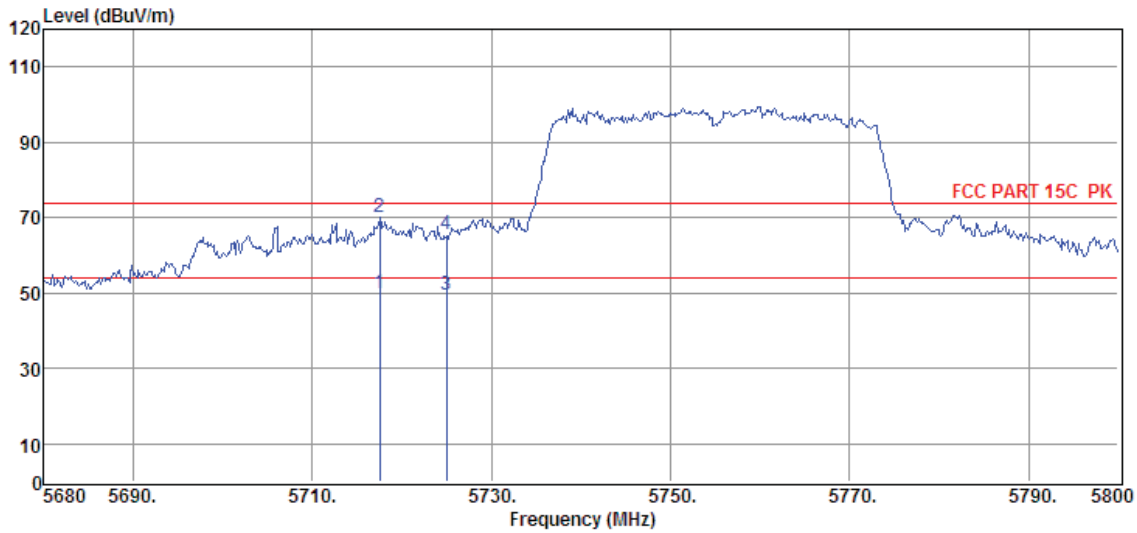

Item (Mark)	Freq. (MHz)	Read Level (dBμV)	Antenna Factor (dB/m)	PRM Factor dB	Cable Loss dB	Result Level (dBμV/m)	Limit Line (dBμV/m)	Over Limit (dB)	Detector	Polarization
1	5717.56	34.94	34.83	29.22	9.41	49.96	54.00	-4.04	Average	VERTICAL
2	5717.56	54.90	34.83	29.22	9.41	69.92	74.00	-4.08	Peak	VERTICAL
3	5725.00	34.61	34.84	29.22	9.41	49.64	54.00	-4.36	Average	VERTICAL
4	5725.00	50.50	34.84	29.22	9.41	65.53	74.00	-8.47	Peak	VERTICAL

- Note: 1. Result Level = Read Level + Antenna Factor + Cable loss - PRM Factor.
 2. If Peak Result complies with AV limit, AV Result is deemed to comply with AV limit.
 3. Test setup: RBW: 1 MHz, VBW: 3 MHz, Sweep time: auto.

TR-4-E-009 Radiated Emission Test Result

Test Site : DDT 3m Chamber 1# D:\2017 RE1# Report Data\17Q0626-5\RF FCC 5 G WIFI 边带.EM6
Test Date : 2017-07-29 **Tested By** : Jerry
EUT : Streaming Wireless Adaptor **Model Number** : ADAPT+
Power Supply : DC 5V from Adapter **Test Mode** : TX mode
Condition : Temp:24.5'C,Humi:55%,
 Press:100.1kPa **Antenna/Distance** : 2016 HF907/3m/HORIZONTAL
Memo : 11n 40 5795MHz

Data: 87

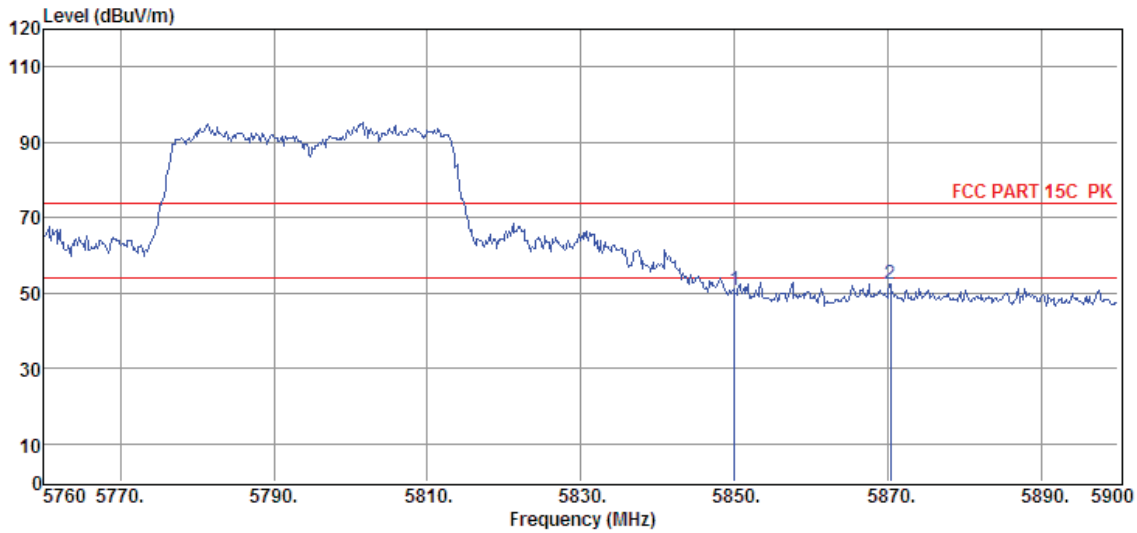

Item (Mark)	Freq. (MHz)	Read Level (dBμV)	Antenna Factor (dB/m)	PRM Factor dB	Cable Loss dB	Result Level (dBμV/m)	Limit Line (dBμV/m)	Over Limit (dB)	Detector	Polarization
1	5850.00	35.59	34.91	29.20	9.54	50.84	74.00	-23.16	Peak	HORIZONTAL
2	5870.32	36.93	34.92	29.20	9.56	52.21	74.00	-21.79	Peak	HORIZONTAL

Note: 1. Result Level = Read Level + Antenna Factor + Cable loss - PRM Factor.
 2. If Peak Result complies with AV limit, AV Result is deemed to comply with AV limit.
 3. Test setup: RBW: 1 MHz, VBW: 3 MHz, Sweep time: auto.

TR-4-E-009 Radiated Emission Test Result

Test Site : DDT 3m Chamber 1# D:\2017 RE1# Report Data\17Q0626-5\RF FCC 5 G WIFI 边带.EM6
Test Date : 2017-07-29 **Tested By** : Jerry
EUT : Streaming Wireless Adaptor **Model Number** : ADAPT+
Power Supply : DC 5V from Adapter **Test Mode** : TX mode
Condition : Temp:24.5'C,Humi:55%,
 Press:100.1kPa **Antenna/Distance** : 2016 HF907/3m/VERTICAL
Memo : 11n 40 5795MHz

Data: 88

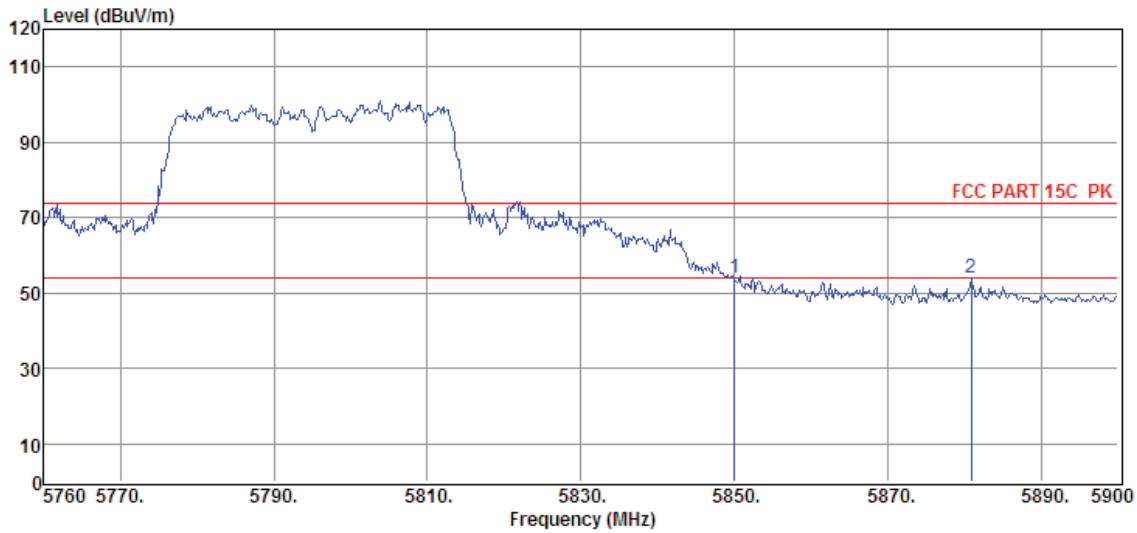

Item (Mark)	Freq. (MHz)	Read Level (dBμV)	Antenna Factor (dB/m)	PRM Factor dB	Cable Loss dB	Result Level (dBμV/m)	Limit Line (dBμV/m)	Over Limit (dB)	Detector	Polarization
1	5850.00	38.57	34.91	29.20	9.54	53.82	74.00	-20.18	Peak	VERTICAL
2	5880.82	38.58	34.93	29.20	9.56	53.87	74.00	-20.13	Peak	VERTICAL

- Note: 1. Result Level = Read Level + Antenna Factor + Cable loss - PRM Factor.
 2. If Peak Result complies with AV limit, AV Result is deemed to comply with AV limit.
 3. Test setup: RBW: 1 MHz, VBW: 3 MHz, Sweep time: auto.

11. Power Line Conducted Emission

11.1. Block diagram of test setup

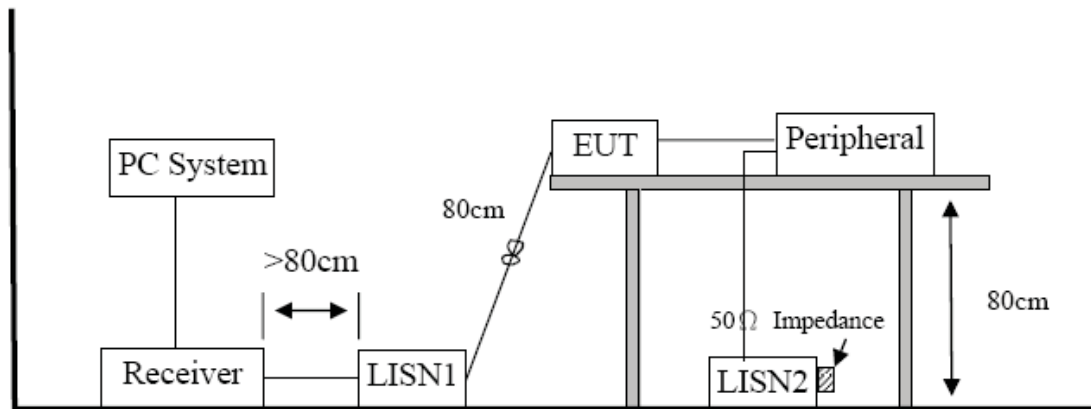

11.2. Power Line Conducted Emission Limits(Class B)

Frequency	Quasi-Peak Level dB(μ V)	Average Level dB(μ V)
150kHz ~ 500kHz	66 ~ 56*	56 ~ 46*
500kHz ~ 5MHz	56	46
5MHz ~ 30MHz	60	50

Note 1: * Decreasing linearly with logarithm of frequency.

Note 2: The lower limit shall apply at the transition frequencies.

11.3. Test Procedure

The EUT and Support equipment, if needed, were put placed on a non-metallic table, 80cm above the ground plane.

Configuration EUT to simulate typical usage as described in clause 2.3 and test equipment as described in clause 10.2 of this report.

All I/O cables were positioned to simulate typical actual usage as per ANSI C63.4.

All support equipment power received from a second LISN.

Emissions were measured on each current carrying line of the EUT using an EMI Test Receiver connected to the LISN powering the EUT.

The Receiver scanned from 150 kHz to 30MHz for emissions in each of the test modes.

During the above scans, the emissions were maximized by cable manipulation.

The test mode(s) described in clause 2.3 were scanned during the preliminary test.

After the preliminary scan, we found the test mode producing the highest emission level.

The EUT configuration and worse cable configuration of the above highest emission levels were recorded for reference of the final test.

EUT and support equipment were set up on the test bench as per the configuration with highest emission level in the preliminary test.

A scan was taken on both power lines, Neutral and Line, recording at least the six highest emissions.

Emission frequency and amplitude were recorded into a computer in which correction factors were used to calculate the emission level and compare reading to the applicable limit.

The test data of the worst-case condition(s) was recorded.

The bandwidth of test receiver is set at 9 KHz.

11.4. Test Result

PASS. (See below detailed test result)

Note1: All emissions not reported below are too low against the prescribed limits.

Note2: “----” means peak detection; “-----” means average detection

Note3: Pre-test AC conducted emission at both voltage AC 120V/60Hz and AC 240V/50Hz, recorded worst case (AC 120V/60Hz).

TR-4-E-010 Conducted Emission Test Result

Test Site : DDT 1# Shield Room E:\2017 CE report data\17Q0626-5\CE.EM6
Test Date : 2017-08-24 **Tested By** : Sunny
EUT : Streaming wireless adaptor **Model Number** : ADAPT+
Power Supply : AC 110V/60Hz **Test Mode** : Tx mode
Condition : Temp:24.5°C,Humi:55%,
LISN : 2016 ENV216/NEUTRAL
 Press:100.1kPa
Memo :

Data: 52

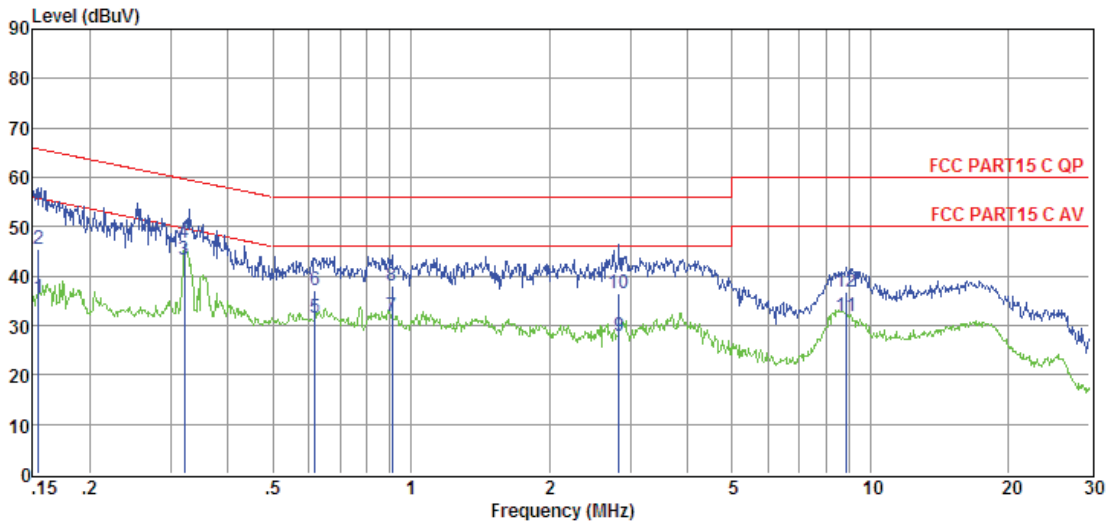

Item	Freq.	Read Level	LISN Factor	Cable Loss	Pulse Limiter Factor	Result Level	Limit Line	Over Limit	Detector	Phase
(Mark)	(MHz)	(dBμV)	(dB)	(dB)	(dB)	(dBμV)	(dBμV)	(dB)		
1	0.15	15.97	9.61	0.02	9.86	35.46	55.74	-20.28	Average	NEUTRAL
2	0.15	26.01	9.61	0.02	9.86	45.50	65.74	-20.24	QP	NEUTRAL
3	0.32	23.70	9.61	0.02	9.86	43.19	49.69	-6.50	Average	NEUTRAL
4	0.32	27.21	9.61	0.02	9.86	46.70	59.69	-12.99	QP	NEUTRAL
5	0.62	12.19	9.61	0.03	9.86	31.69	46.00	-14.31	Average	NEUTRAL
6	0.62	17.76	9.61	0.03	9.86	37.26	56.00	-18.74	QP	NEUTRAL
7	0.91	12.42	9.61	0.03	9.86	31.92	46.00	-14.08	Average	NEUTRAL
8	0.91	18.64	9.61	0.03	9.86	38.14	56.00	-17.86	QP	NEUTRAL
9	2.84	8.17	9.64	0.05	9.87	27.73	46.00	-18.27	Average	NEUTRAL
10	2.84	16.80	9.64	0.05	9.87	36.36	56.00	-19.64	QP	NEUTRAL
11	8.87	12.13	9.72	0.10	9.90	31.85	50.00	-18.15	Average	NEUTRAL
12	8.87	16.99	9.72	0.10	9.90	36.71	60.00	-23.29	QP	NEUTRAL

- Note: 1. Result Level = Read Level +LISN Factor + Pulse Limiter Factor + Cable loss.
 2. If QP Result complies with AV limit, AV Result is deemed to comply with AV limit.
 3. Test setup: RBW: 200 Hz (9 kHz—150 kHz), 9 kHz (150 kHz—30 MHz).
 4. Step size: 80Hz (0.009MHz-0.15MHz), 4 kHz (0.15MHz-30MHz), Scan time: auto.

TR-4-E-010 Conducted Emission Test Result

Test Site : DDT 1# Shield Room E:\2017 CE report data\17Q0626-5\CE.EM6
Test Date : 2017-08-24 **Tested By** : Sunny
EUT : Streaming wireless adaptor **Model Number** : ADAPT+
Power Supply : AC 110V/60Hz **Test Mode** : Tx mode
Condition : Temp:24.5°C,Humi:55%,
LISN : 2016 ENV216/LINE
 Press:100.1kPa
Memo :

Data: 54

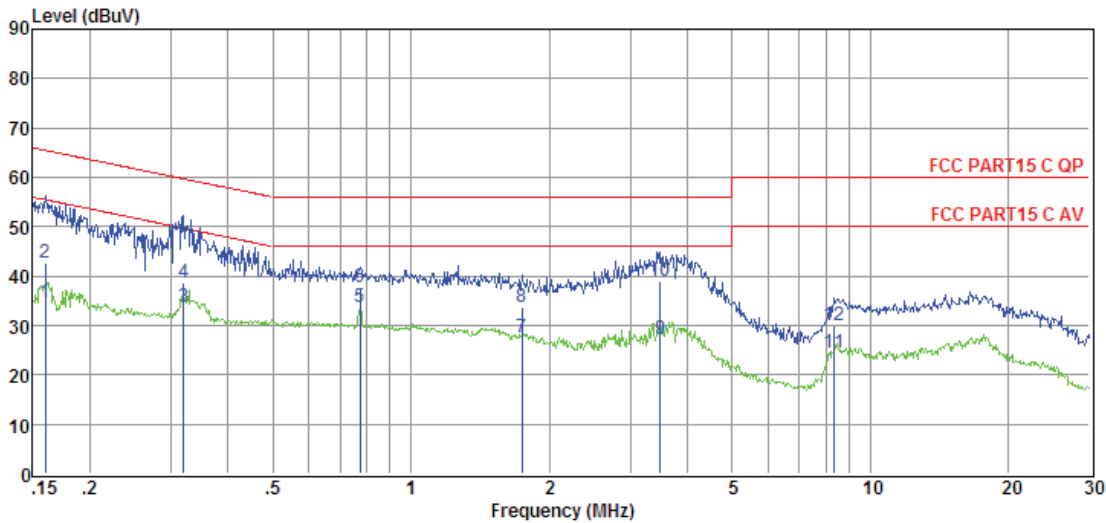

Item	Freq.	Read Level	LISN Factor	Cable Loss	Pulse Limiter Factor	Result Level	Limit Line	Over Limit	Detector	Phase
(Mark)	(MHz)	(dBμV)	(dB)	(dB)	(dB)	(dBμV)	(dBμV)	(dB)		
1	0.16	15.02	9.61	0.02	9.86	34.51	55.47	-20.96	Average	LINE
2	0.16	23.30	9.61	0.02	9.86	42.79	65.47	-22.68	QP	LINE
3	0.32	14.20	9.61	0.02	9.86	33.69	49.71	-16.02	Average	LINE
4	0.32	19.28	9.61	0.02	9.86	38.77	59.71	-20.94	QP	LINE
5	0.78	14.36	9.61	0.03	9.86	33.86	46.00	-12.14	Average	LINE
6	0.78	18.35	9.61	0.03	9.86	37.85	56.00	-18.15	QP	LINE
7	1.74	8.08	9.63	0.04	9.87	27.62	46.00	-18.38	Average	LINE
8	1.74	14.05	9.63	0.04	9.87	33.59	56.00	-22.41	QP	LINE
9	3.49	7.67	9.65	0.05	9.87	27.24	46.00	-18.76	Average	LINE
10	3.49	19.38	9.65	0.05	9.87	38.95	56.00	-17.05	QP	LINE
11	8.32	4.80	9.71	0.09	9.89	24.49	50.00	-25.51	Average	LINE
12	8.32	10.31	9.71	0.09	9.89	30.00	60.00	-30.00	QP	LINE

- Note: 1. Result Level = Read Level +LISN Factor + Pulse Limiter Factor + Cable loss.
 2. If QP Result complies with AV limit, AV Result is deemed to comply with AV limit.
 3. Test setup: RBW: 200 Hz (9 kHz—150 kHz), 9 kHz (150 kHz—30 MHz).
 4. Step size: 80Hz (0.009MHz-0.15MHz), 4 kHz (0.15MHz-30MHz), Scan time: auto..

12. Antenna Requirements

12.1. Limit

For intentional device, according to FCC 47 CFR Section 15.203, an intentional radiator shall be designed to ensure that no antenna other than that furnished by the responsible party shall be used with the device. And according to FCC 47 CFR Section 15.247 (b), if transmitting antennas of directional gain greater than 6dBi are used, the power shall be reduced by the amount in dB that the directional gain of the antenna exceeds 6dBi.

12.2. Result

The antennas used for this product are integrated antenna and other than that furnished by the responsible party shall be used with the device, the maximum peak gain of the transmit antenna is only 6dBi.

13. Dynamic Frequency Selection

13.1. Applicability of DFS requirements

Table 1: Applicability of DFS Requirements Prior to Use of a Channel

Requirement	Operational Mode		
	<input type="checkbox"/> Master	<input checked="" type="checkbox"/> Client Without Radar Detection	<input type="checkbox"/> Client With Radar Detection
Non-Occupancy Period	Yes	Not required	Yes
DFS Detection Threshold	Yes	Not required	Yes
Channel Availability Check Time	Yes	Not required	Not required
U-NII Detection Bandwidth	Yes	Not required	Yes

Table 2: Applicability of DFS requirements during normal operation

Requirement	Operational Mode	
	<input type="checkbox"/> Master Device or Client with Radar Detection	<input checked="" type="checkbox"/> Client Without Radar Detection
DFS Detection Threshold	Yes	Not required
Channel Closing Transmission Time	Yes	Yes
Channel Move Time	Yes	Yes
U-NII Detection Bandwidth	Yes	Not required

Additional requirements for devices with multiple bandwidth modes	<input type="checkbox"/> Master Device or Client with Radar Detection	<input checked="" type="checkbox"/> Client Without Radar Detection
U-NII Detection Bandwidth and Statistical Performance Check	All BW modes must be tested	Not required
Channel Move Time and Channel Closing Transmission Time	Test using widest BW mode available	Test using the widest BW mode available for the link
All other tests	Any single BW mode	Not required

Note: Frequencies selected for statistical performance check should include several frequencies within the radar detection bandwidth and frequencies near the edge of the radar detection bandwidth. For 802.11 devices it is suggested to select frequencies in each of the bonded 20 MHz channels and the channel center frequency.

13.2. Limit

(1) DFS Detection Thresholds

Table 3: DFS Detection Thresholds for Master Devices and Client Devices With Radar Detection

Maximum Transmit Power	Value (See Notes 1, 2, and 3)
EIRP \geq 200 milliwatt	-64 dBm
EIRP < 200 milliwatt and power spectral density < 10 dBm/MHz	-62 dBm
EIRP < 200 milliwatt that do not meet the power spectral density requirement	-64 dBm

Note 1: This is the level at the input of the receiver assuming a 0 dBi receive antenna.
 Note 2: Throughout these test procedures an additional 1 dB has been added to the amplitude of the test transmission waveforms to account for variations in measurement equipment. This will ensure that the test signal is at or above the detection threshold level to trigger a DFS response.
 Note3: EIRP is based on the highest antenna gain. For MIMO devices refer to KDB Publication 662911 D01.

(2) DFS Response Requirements

Table 4: DFS Response Requirement Values

Parameter	Value
Non-occupancy period	Minimum 30 minutes
Channel Availability Check Time	60 seconds
Channel Move Time	10 seconds See Note 1.
Channel Closing Transmission Time	200 milliseconds + an aggregate of 60 milliseconds over remaining 10 second period. See Notes 1 and 2.
U-NII Detection Bandwidth	Minimum 100% of the U-NII 99% transmission power bandwidth. See Note 3.

Note 1: Channel Move Time and the Channel Closing Transmission Time should be performed with Radar Type 0. The measurement timing begins at the end of the Radar Type 0 burst.
 Note 2: The Channel Closing Transmission Time is comprised of 200 milliseconds starting at the beginning of the Channel Move Time plus any additional intermittent control signals required facilitating a Channel move (an aggregate of 60 milliseconds) during the remainder of the 10 second period. The aggregate duration of control signals will not count quiet periods in between transmissions.
 Note 3: During the U-NII Detection Bandwidth detection test, radar type 0 should be used. For each frequency step the minimum percentage of detection is 90 percent. Measurements are performed with no data traffic.

13.3. Parameters of radar test waveforms

This section provides the parameters for required test waveforms, minimum percentage of successful detections, and the minimum number of trials that must be used for determining DFS conformance. Step intervals of 0.1 microsecond for Pulse Width, 1 microsecond for PRI, 1 MHz for chirp width and 1 for the number of pulses will be utilized for the random determination of specific test waveforms.

Table 5 Short Pulse Radar Test Waveforms

Radar Type	Pulse Width (μsec)	PRI (μsec)	Number of Pulses	Minimum Percentage of Successful Detection	Minimum Number of Trials
0	1	1428	18	See Note 1	See Note 1
1	1	Test A	Roundup $\left\{ \left(\frac{1}{360} \right) \cdot \left(\frac{19 \cdot 10^6}{\text{PRI}_{\mu\text{sec}}} \right) \right\}$	60%	30
		Test B			
2	1-5	150-230	23-29	60%	30
3	6-10	200-500	16-18	60%	30
4	11-20	200-500	12-16	60%	30
Aggregate (Radar Types 1-4)				80%	120
<p>Note 1: Short Pulse Radar Type 0 should be used for the detection bandwidth test, channel move time, and channel closing time tests.</p> <p>Test A: 15 unique PRI values randomly selected from the list of 23 PRI values in Table 5a</p> <p>Test B: 15 unique PRI values randomly selected within the range of 518-3066 μsec, with a minimum increment of 1 μsec, excluding PRI values selected in Test A</p>					

A minimum of 30 unique waveforms are required for each of the Short Pulse Radar Types 2 through 4. If more than 30 waveforms are used for Short Pulse Radar Types 2 through 4, then each additional waveform must also be unique and not repeated from the previous waveforms. If more than 30 waveforms are used for Short Pulse Radar Type 1, then each additional waveform is generated with Test B and must also be unique and not repeated from the previous waveforms in Tests A or B. Test aggregate is average of the percentage of successful detections of short pulse radar types 1-4

13.4. Calibration of radar waveform

Radar Waveform Calibration Procedure:

- (1) A 50 ohm load is connected in place of the spectrum analyzer, and the spectrum analyzer is connected to place of the master
- (2) The interference Radar Detection Threshold Level is $-62\text{dBm} + 0\text{dBi} + 1\text{dB} = -61\text{dBm}$ that had been taken into account the output power range and antenna gain.
- (3) The following equipment setup was used to calibrate the conducted radar waveform. A vector signal generator was utilized to establish the test signal level for radar type 0. During this process there were no transmissions by either the master or client device. The spectrum analyzer was switched to the zero spans (time domain) at the frequency of the radar waveform generator. Peak detection was used. The spectrum analyzer resolution bandwidth (RBW) and video bandwidth (VBW) were set to 3 MHz. The spectrum analyzer had offset -1.0dB to compensate RF cable loss 1.0dB.
- (4) The vector signal generator amplitude was set so that the power level measured at the spectrum analyzer was $-62\text{dBm} + 0\text{dBi} + 1\text{dB} = -61\text{dBm}$. Capture the spectrum analyzer plots on short pulse radar waveform.

Conducted Calibration Setup:

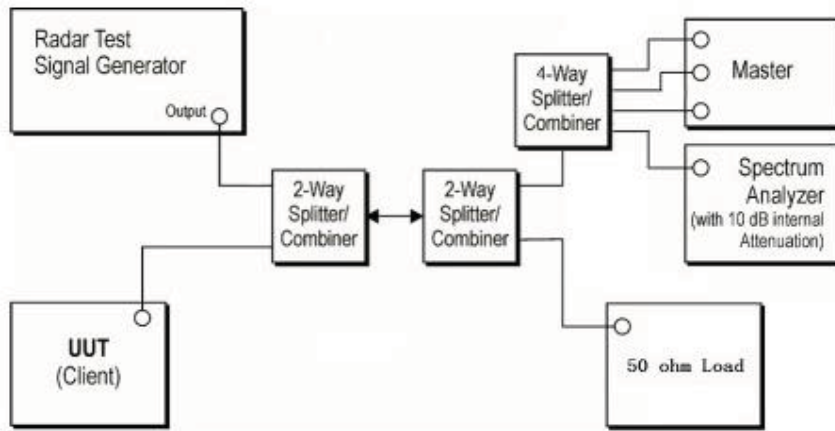

Radar Waveform Calibration Result:

Radar Type 0

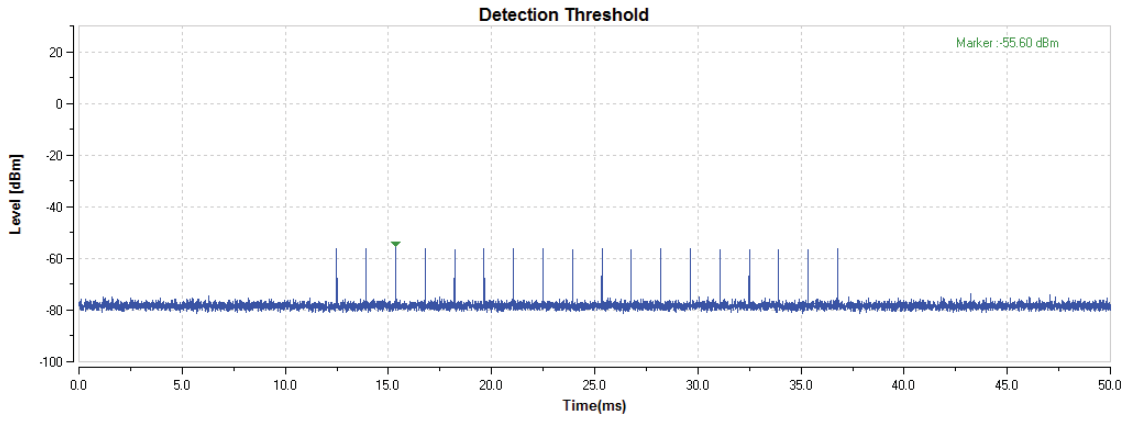

Trial List Table - FCC-13-22

Save Load ↑ Trigger ↓ Download All

Sample Rate

Trial List

	Trial Id	Radar Type	Pulse Width (us)	PRI (us)	Number of Pulses	Waveform Length (us)
Download	0	Type 0	1.0	1428.0	18	25704.0
Download	1	Type 0	1.0	1428.0	18	25704.0
Download	2	Type 0	1.0	1428.0	18	25704.0
Download	3	Type 0	1.0	1428.0	18	25704.0
Download	4	Type 0	1.0	1428.0	18	25704.0
Download	5	Type 0	1.0	1428.0	18	25704.0
Download	6	Type 0	1.0	1428.0	18	25704.0
Download	7	Type 0	1.0	1428.0	18	25704.0
Download	8	Type 0	1.0	1428.0	18	25704.0
Download	9	Type 0	1.0	1428.0	18	25704.0
Download	10	Type 0	1.0	1428.0	18	25704.0
Download	11	Type 0	1.0	1428.0	18	25704.0
Download	12	Type 0	1.0	1428.0	18	25704.0
Download	13	Type 0	1.0	1428.0	18	25704.0
Download	14	Type 0	1.0	1428.0	18	25704.0
Download	15	Type 0	1.0	1428.0	18	25704.0
Download	16	Type 0	1.0	1428.0	18	25704.0
Download	17	Type 0	1.0	1428.0	18	25704.0
Download	18	Type 0	1.0	1428.0	18	25704.0
Download	19	Type 0	1.0	1428.0	18	25704.0
Download	20	Type 0	1.0	1428.0	18	25704.0
Download	21	Type 0	1.0	1428.0	18	25704.0
Download	22	Type 0	1.0	1428.0	18	25704.0
Download	23	Type 0	1.0	1428.0	18	25704.0
Download	24	Type 0	1.0	1428.0	18	25704.0
Download	25	Type 0	1.0	1428.0	18	25704.0
Download	26	Type 0	1.0	1428.0	18	25704.0
Download	27	Type 0	1.0	1428.0	18	25704.0
Download	28	Type 0	1.0	1428.0	18	25704.0

Radar Type 2

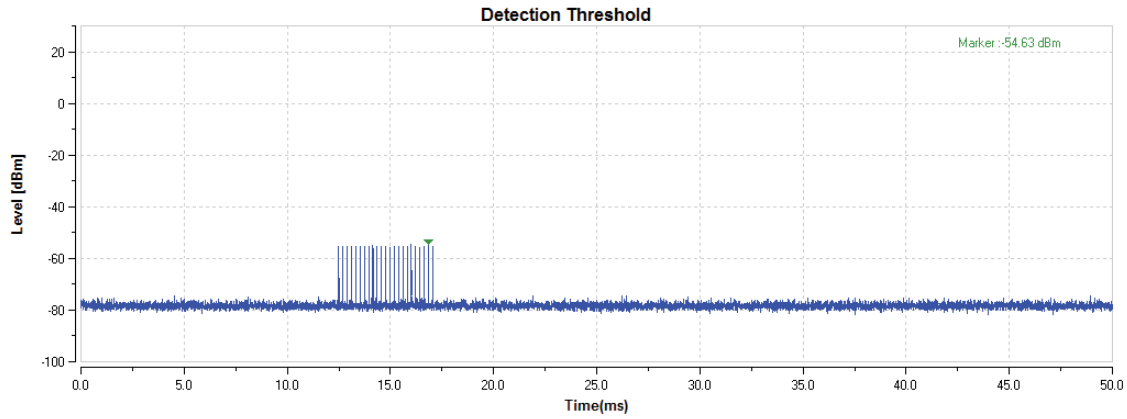

Trial List Table - FCC-13-22

Save Load Trigger Download All

Sample Rate 10 MHz

	Trial Id	Radar Type	Pulse Width (us)	PRI (us)	Number of Pulses	Waveform Length (us)
Download	0	Type 2	3.2	179.0	26	4654.0
Download	1	Type 2	1.1	207.0	23	4761.0
Download	2	Type 2	2.1	230.0	24	5520.0
Download	3	Type 2	4.8	200.0	29	5800.0
Download	4	Type 2	3.9	214.0	28	5992.0
Download	5	Type 2	2.9	222.0	26	5772.0
Download	6	Type 2	3.2	204.0	26	5304.0
Download	7	Type 2	2.5	192.0	25	4800.0
Download	8	Type 2	3.1	164.0	26	4264.0
Download	9	Type 2	1.2	156.0	23	3588.0
Download	10	Type 2	3.9	210.0	27	5670.0
Download	11	Type 2	4.6	201.0	29	5829.0
Download	12	Type 2	3.2	162.0	26	4212.0
Download	13	Type 2	2.2	197.0	25	4925.0
Download	14	Type 2	4.5	163.0	29	4727.0
Download	15	Type 2	3.0	203.0	26	5278.0
Download	16	Type 2	5.0	168.0	29	4872.0
Download	17	Type 2	2.4	217.0	25	5425.0
Download	18	Type 2	2.9	191.0	26	4966.0
Download	19	Type 2	2.3	166.0	25	4150.0
Download	20	Type 2	3.7	150.0	27	4050.0
Download	21	Type 2	2.2	176.0	25	4400.0
Download	22	Type 2	4.9	195.0	29	5655.0
Download	23	Type 2	2.9	202.0	26	5252.0
Download	24	Type 2	2.5	178.0	25	4450.0
Download	25	Type 2	1.1	206.0	23	4738.0
Download	26	Type 2	3.8	155.0	27	4185.0
Download	27	Type 2	4.7	157.0	29	4553.0
Download	28	Type 2	2.4	224.0	25	5600.0

Radar Type 3

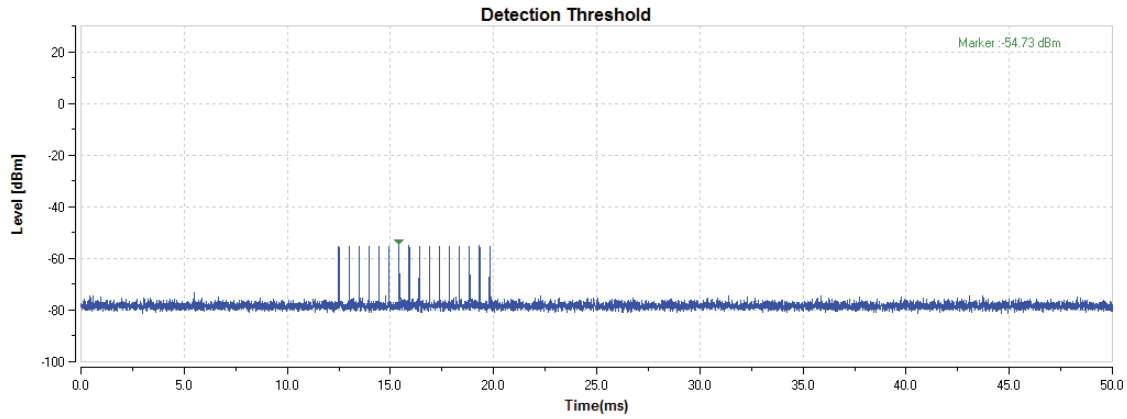

Trial List Table - FCC-13-22

Save Load Trigger Download All

Sample Rate 10 MHz

	Trial Id	Radar Type	Pulse Width (us)	PRI (us)	Number of Pulses	Waveform Length (us)
Download	0	Type 3	8.2	355.0	17	6035.0
Download	1	Type 3	6.1	487.0	16	7792.0
Download	2	Type 3	7.1	344.0	16	5504.0
Download	3	Type 3	9.8	288.0	18	5184.0
Download	4	Type 3	8.9	230.0	18	4140.0
Download	5	Type 3	7.9	432.0	17	7344.0
Download	6	Type 3	8.2	207.0	17	3519.0
Download	7	Type 3	7.5	443.0	17	7531.0
Download	8	Type 3	8.1	439.0	17	7463.0
Download	9	Type 3	6.2	223.0	16	3568.0
Download	10	Type 3	8.9	208.0	18	3744.0
Download	11	Type 3	9.6	463.0	18	8334.0
Download	12	Type 3	8.2	441.0	17	7497.0
Download	13	Type 3	7.2	323.0	16	5168.0
Download	14	Type 3	9.5	297.0	18	5346.0
Download	15	Type 3	8.0	412.0	17	7004.0
Download	16	Type 3	10.0	324.0	18	5832.0
Download	17	Type 3	7.4	271.0	17	4607.0
Download	18	Type 3	7.9	349.0	17	5933.0
Download	19	Type 3	7.3	409.0	16	6544.0
Download	20	Type 3	8.7	373.0	18	6714.0
Download	21	Type 3	7.2	254.0	16	4064.0
Download	22	Type 3	9.9	274.0	18	4932.0
Download	23	Type 3	7.9	278.0	17	4726.0
Download	24	Type 3	7.5	317.0	17	5389.0
Download	25	Type 3	6.1	260.0	16	4160.0
Download	26	Type 3	8.8	211.0	18	3798.0
Download	27	Type 3	9.7	272.0	18	4896.0
Download	28	Type 3	7.4	264.0	17	4488.0

Radar Type 4

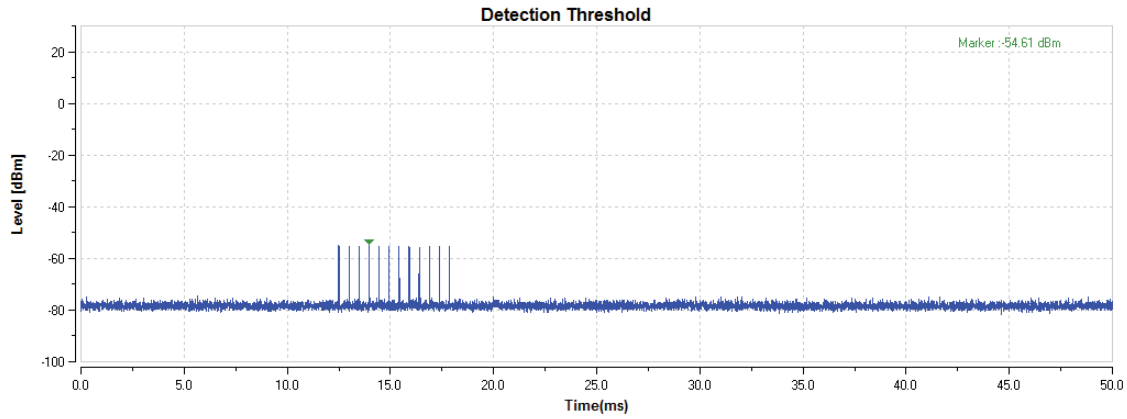

Trial List Table - FCC-13-22

Save Load ↑ Trigger ↓ Download All

Sample Rate 10 MHz

	Trial Id	Radar Type	Pulse Width (us)	PRI (us)	Number of Pulses	Waveform Length (us)
Download	0	Type 4	16.0	355.0	14	4970.0
Download	1	Type 4	11.3	487.0	12	5844.0
Download	2	Type 4	13.5	344.0	13	4472.0
Download	3	Type 4	19.4	288.0	16	4608.0
Download	4	Type 4	17.5	230.0	15	3450.0
Download	5	Type 4	15.3	432.0	14	6048.0
Download	6	Type 4	15.9	207.0	14	2898.0
Download	7	Type 4	14.3	443.0	13	5759.0
Download	8	Type 4	15.8	439.0	14	6146.0
Download	9	Type 4	11.5	223.0	12	2676.0
Download	10	Type 4	17.4	208.0	15	3120.0
Download	11	Type 4	19.0	463.0	16	7408.0
Download	12	Type 4	16.0	441.0	14	6174.0
Download	13	Type 4	13.8	323.0	13	4199.0
Download	14	Type 4	18.9	297.0	16	4752.0
Download	15	Type 4	15.5	412.0	14	5768.0
Download	16	Type 4	19.9	324.0	16	5184.0
Download	17	Type 4	14.1	271.0	13	3523.0
Download	18	Type 4	15.2	349.0	14	4886.0
Download	19	Type 4	13.8	409.0	13	5317.0
Download	20	Type 4	17.1	373.0	15	5595.0
Download	21	Type 4	13.8	254.0	13	3302.0
Download	22	Type 4	19.8	274.0	16	4384.0
Download	23	Type 4	15.3	278.0	14	3692.0
Download	24	Type 4	14.5	317.0	13	4121.0
Download	25	Type 4	11.3	260.0	12	3120.0
Download	26	Type 4	17.3	211.0	15	3165.0
Download	27	Type 4	19.2	272.0	16	4352.0
Download	28	Type 4	14.2	264.0	13	3432.0

Radar Type 5

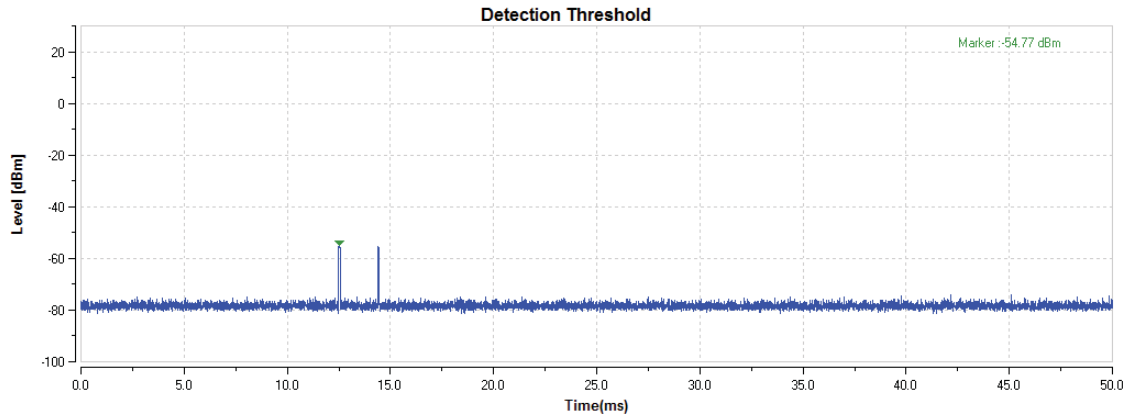

Trial List Table - FCC-13-22

Save Load Trigger Download All

Sample Rate: 100 MHz UUT Channel Center Frequency: 5.5 GHz Radar Detection Bandwidth: 5 MHz

Trial List								
		Trial Id	Radar Type	Number of Bursts	Burst Period (s)	Waveform Length (s)	Center Frequency (GHz)	
+	Download	0	Type 5	15	0.8000000	12.0000000	5.500000000	
+	Download	1	Type 5	8	1.5000000	12.0000000	5.500000000	
+	Download	2	Type 5	11	1.0909091	12.0000000	5.500000000	
+	Download	3	Type 5	20	0.6000000	12.0000000	5.500000000	
+	Download	4	Type 5	17	0.7058824	12.0000000	5.500000000	
+	Download	5	Type 5	14	0.8571429	12.0000000	5.500000000	
+	Download	6	Type 5	15	0.8000000	12.0000000	5.500000000	
+	Download	7	Type 5	12	1.0000000	12.0000000	5.500000000	
+	Download	8	Type 5	14	0.8571429	12.0000000	5.500000000	
+	Download	9	Type 5	8	1.5000000	12.0000000	5.500000000	
+	Download	10	Type 5	17	0.7058824	12.0000000	5.503900000	
+	Download	11	Type 5	19	0.6315789	12.0000000	5.505100000	
+	Download	12	Type 5	15	0.8000000	12.0000000	5.502700000	
+	Download	13	Type 5	12	1.0000000	12.0000000	5.501500000	
+	Download	14	Type 5	19	0.6315789	12.0000000	5.504700000	
+	Download	15	Type 5	14	0.8571429	12.0000000	5.502300000	
+	Download	16	Type 5	20	0.6000000	12.0000000	5.505500000	
+	Download	17	Type 5	12	1.0000000	12.0000000	5.501500000	
+	Download	18	Type 5	14	0.8571429	12.0000000	5.502300000	
+	Download	19	Type 5	12	1.0000000	12.0000000	5.501500000	
+	Download	20	Type 5	16	0.7500000	12.0000000	5.498500000	
+	Download	21	Type 5	12	1.0000000	12.0000000	5.498900000	
+	Download	22	Type 5	20	0.6000000	12.0000000	5.494500000	
+	Download	23	Type 5	14	0.8571429	12.0000000	5.497700000	
+	Download	24	Type 5	13	0.9230769	12.0000000	5.498100000	
+	Download	25	Type 5	8	1.5000000	12.0000000	5.500500000	
+	Download	26	Type 5	17	0.7058824	12.0000000	5.496100000	
+	Download	27	Type 5	19	0.6315789	12.0000000	5.494900000	
+	Download	28	Type 5	12	1.0000000	12.0000000	5.498500000	

Radar Type 6

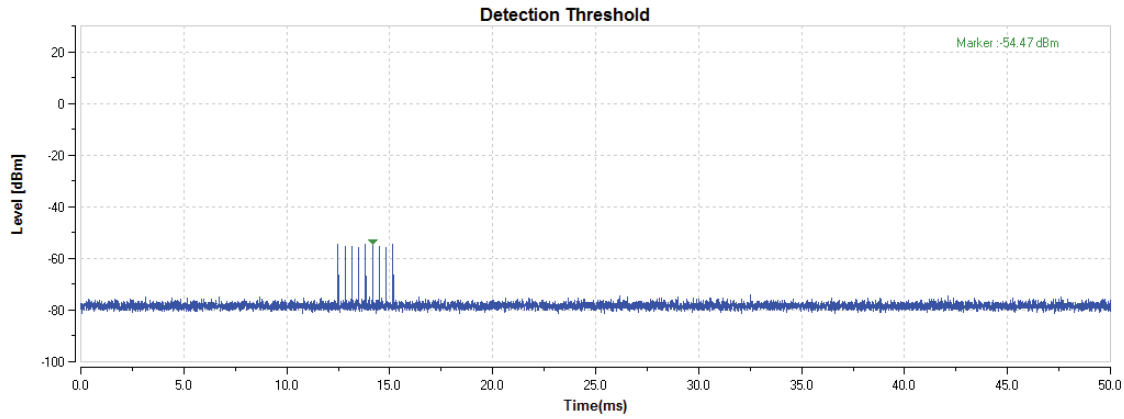

Trial List Table - FCC-13-22

Save Load ↑ Trigger ↓ Download All

Sample Rate 200 MHz Center Frequency 5500 MHz Channel Bandwidth 160 MHz

Trial List									
		Trial Id	Radar Type	Pulse Width (us)	PRI (us)	Pulses per Hop	Hopping Rate (kHz)	Hopping Sequence Length (ms)	Visible Frequency Number
+	Download	0	Type 6	1.0	333.3	9	0.3333	300.0000000	32
+	Download	1	Type 6	1.0	333.3	9	0.3333	300.0000000	27
+	Download	2	Type 6	1.0	333.3	9	0.3333	300.0000000	25
+	Download	3	Type 6	1.0	333.3	9	0.3333	300.0000000	33
+	Download	4	Type 6	1.0	333.3	9	0.3333	300.0000000	37
+	Download	5	Type 6	1.0	333.3	9	0.3333	300.0000000	30
+	Download	6	Type 6	1.0	333.3	9	0.3333	300.0000000	33
+	Download	7	Type 6	1.0	333.3	9	0.3333	300.0000000	27
+	Download	8	Type 6	1.0	333.3	9	0.3333	300.0000000	33
+	Download	9	Type 6	1.0	333.3	9	0.3333	300.0000000	30
+	Download	10	Type 6	1.0	333.3	9	0.3333	300.0000000	37
+	Download	11	Type 6	1.0	333.3	9	0.3333	300.0000000	36
+	Download	12	Type 6	1.0	333.3	9	0.3333	300.0000000	38
+	Download	13	Type 6	1.0	333.3	9	0.3333	300.0000000	35
+	Download	14	Type 6	1.0	333.3	9	0.3333	300.0000000	28
+	Download	15	Type 6	1.0	333.3	9	0.3333	300.0000000	37
+	Download	16	Type 6	1.0	333.3	9	0.3333	300.0000000	35
+	Download	17	Type 6	1.0	333.3	9	0.3333	300.0000000	37
+	Download	18	Type 6	1.0	333.3	9	0.3333	300.0000000	27
+	Download	19	Type 6	1.0	333.3	9	0.3333	300.0000000	34
+	Download	20	Type 6	1.0	333.3	9	0.3333	300.0000000	35
+	Download	21	Type 6	1.0	333.3	9	0.3333	300.0000000	37
+	Download	22	Type 6	1.0	333.3	9	0.3333	300.0000000	41
+	Download	23	Type 6	1.0	333.3	9	0.3333	300.0000000	36
+	Download	24	Type 6	1.0	333.3	9	0.3333	300.0000000	29
+	Download	25	Type 6	1.0	333.3	9	0.3333	300.0000000	32
+	Download	26	Type 6	1.0	333.3	9	0.3333	300.0000000	30
+	Download	27	Type 6	1.0	333.3	9	0.3333	300.0000000	31

13.5. Channel closing transmission time, channel move time and non-occupancy period

Block diagram of test setup Test Procedure:

- (1) The radar pulse generator is setup to provide a pulse at frequency that the master and client are operating. A type 0 radar pulse with a 1us pulse width and a 1428us PRI is used for the testing.
- (2) The vector signal generator is adjusted to provide the radar burst (18 pulses) at the level of approximately -61dBm at the antenna port of the master device.
- (3) A trigger is provided from the pulse generator to the DFS monitoring system in order to capture the traffic and the occurrence of the radar pulse.
- (4) EUT will associate with the master at channel. The file "iperf.exe" specified by the FCC is streamed from the PC 2 through the master and the client device to the PC 1 and played in full motion video using Test Software in order to properly load the network for the entire period of the test.
- (5) When radar burst with a level equal to the DFS Detection Threshold +1dB is generated on the operating channel of the U-NII device. At time T0 the radar waveform generator sends a burst of pulse of the radar waveform at Detection Threshold +1dB.
- (6) Observe the transmissions of the EUT at the end of the radar Burst on the Operating Channel. Measure and record the transmissions from the UUT during the observation time (Channel Move Time). One 15 seconds plot is reported for the Short Pulse Radar Type 0. The plot for the Short Pulse Radar Types start at the end of the radar burst. The Channel Move Time will be calculated based on the zoom in 600ms plot of the Short Pulse Radar Type.
- (7) Measurement of the aggregate duration of the Channel Closed Transmission Time method. With the
- (8) spectrum analyzer set to zero span tuned to the center frequency of the EUT operating channel at the radar simulated frequency, peak detection, and max hold, the dwell time per bin is given by: $Dwell (0.3ms) = S (12000ms) / B (4000)$; where Dwell is the dwell time per spectrum analyzer sampling bin, S is sweep time and B is the number of spectrum analyzer sampling bins. An upper bound of the aggregate duration of the intermittent control signals of Channel Closing Transmission Time is calculated by: $C (ms) = N \times Dwell (0.3ms)$; where C is the Closing Time, N is the number of spectrum analyzer sampling bins (intermittent control signals) showing a U-NII transmission and Dwell is the dwell time per bin.

Measurement the EUT for more than 30 minutes following the channel move time to verify that no transmission or beacons occur on this channel.

13.6. Test setup

Setup for Client with injection at the Master

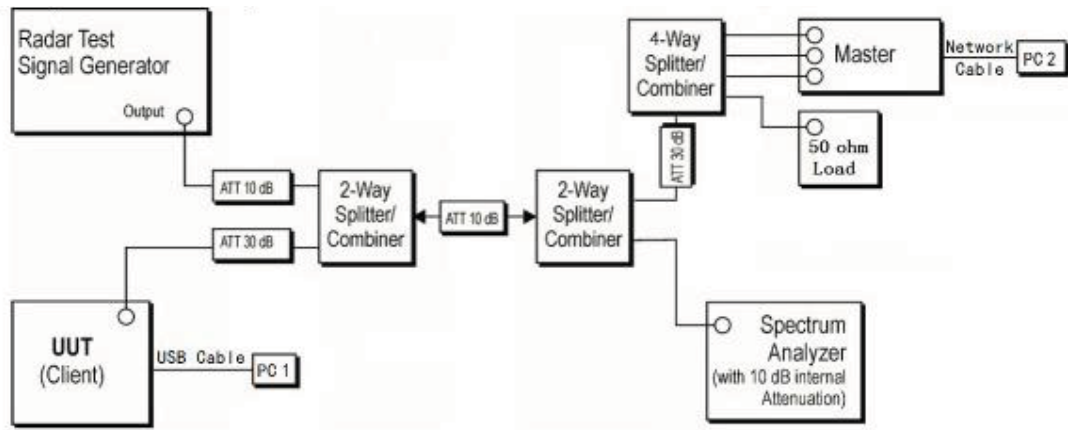

13.7. Test result

BW/Channel	Test Item	Test Result	Limit	Results
80M/5530MHz	Channel Move Time	0.597s	< 10 s	pass
	Channel Closing Transmission Time	0.001s	< 1s	pass

Test plots as follows:

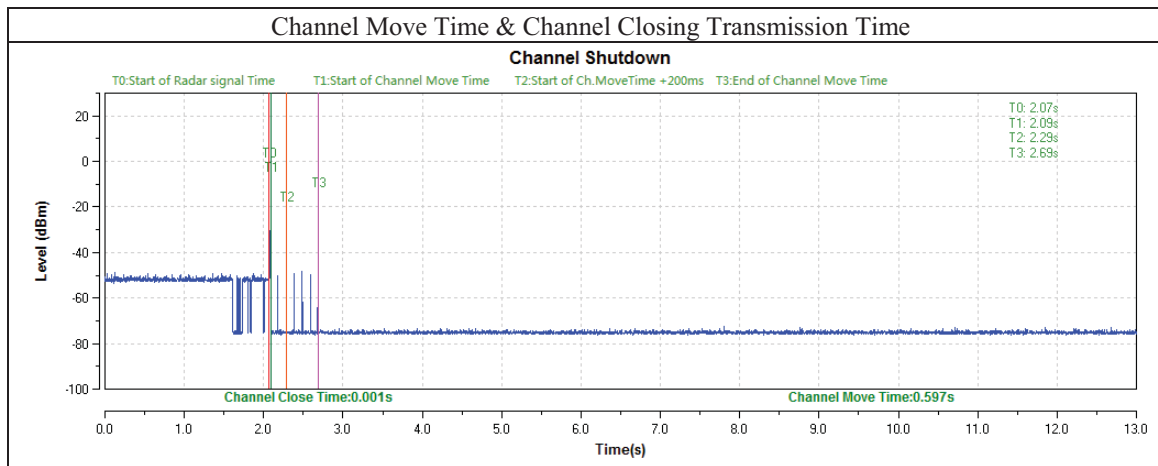

BW/Channel	Test Item	Test Result	Limit	Results
80M/5530MHz	Non-Occupancy Period	>30min	30min	pass

Non-Occupancy Period

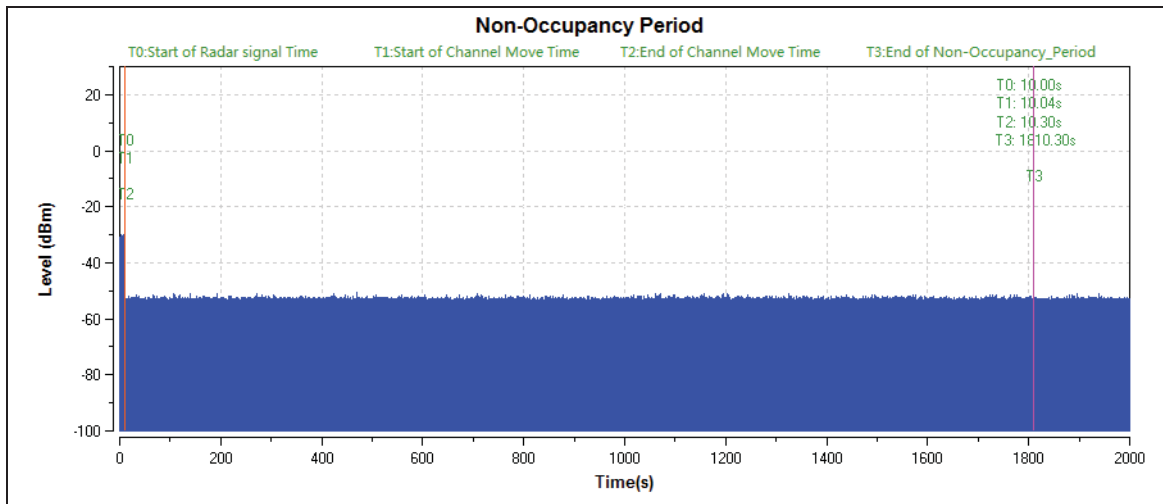

END OF REPORT