

FCC TEST REPORT

for

Harman International Industries, Incorporated.

Portable 2-way full range loudspeakers with powered mixer

Model Number: EON208P

FCC ID:APIEON208P
IC:6132A-EON208P

Prepared for : Harman International Industries, Incorporated.
Address : 8500 Balboa Blvd, Northridge, CA 91329, United States
Prepared by : Keyway Testing Technology Co., Ltd.
Address : Building 1, Baishun Industrial Zone, Zhangmutou Town,
Dongguan, Guangdong, China



Tel: 86-769-8718 2258
Fax: 86-769-8718 1058

Report No. : 16KWE013453F
Date of Test : Jan. 6~Jan. 13, 2016
Date of Report : Jan.14, 2016

TABLE OF CONTENTS

	Page
Test Report Declaration	Page
1. TEST SUMMARY	4
2. GENERAL PRODUCT INFORMATION	5
2.1. Product Function.....	5
2.2. Description of Device (EUT)	5
2.3. Independent Operation Modes	6
2.4. Product Version	6
2.5. TEST SITES.....	7
2.6. List of Test and Measurement Instruments	8
3. TEST SET-UP AND OPERATION MODES.....	9
3.1. Principle of Configuration Selection.....	9
3.2. Block Diagram of Test Set-up.....	9
3.3. Test Operation Mode and Test Software.....	9
3.4. Special Accessories and Auxiliary Equipment.....	9
3.5. Countermeasures to Achieve EMC Compliance	9
4. EMISSION TEST RESULTS.....	10
4.1. Conducted Emission at the Mains Terminals Test.....	10
4.2. Radiated Emission Test.....	13
5. BAND EDGE COMPLIANCE TEST	25
5.1. Limits	25
5.2. Test setup	25
5.3. TEST Procedure.....	26
6. 6DB OCCUPY BANDWIDTH	29
6.1. Limits	29
6.2. TEST PROCEDURE.....	29
7. OUTPUT POWER TEST	32
7.1. Limits	32
7.2. Test setup.....	32
7.3. Test result.....	32
8. POWER SPECTRAL DENSITY TEST.....	33
8.1. Limits	33
8.2. Test setup	33
8.3. Test result.....	33
9. ANTENNA REQUIREMENTS	35
9.1. Limits	35
9.2. Result	35
10.PHOTOGRAPHS OF TEST SET-UP	36
11. PHOTOGRAPHS OF THE EUT	38

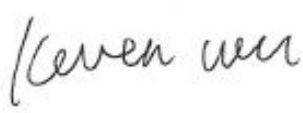
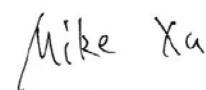
Keyway Testing Technology Co., Ltd.

Applicant:	Harman International Industries, Incorporated.		
Address:	8500 Balboa Blvd, Northridge, CA 91329, United States		
Manufacturer:	Harman International Industries, Incorporated.		
Address:	8500 Balboa Blvd, Northridge, CA 91329, United States		
E.U.T:	Portable 2-way full range loudspeakers with powered mixer		
Model Number:	EON208P		
Trade Name:	JBL	Serial No.:	-----
Date of Receipt:	Jan. 5, 2016	Date of Test:	Jan.6~Jan. 13, 2016
Test Specification:	FCC Part 15, Subpart C Section 15.247: 2014 ANSI C63.10:2013 KDB558074 D01 DTS Meas Guidance v03r02 RSS-247 Issue 1 May 2015 RSS-Gen Issue 4 November 2014		
Test Result:	The equipment under test was found to be compliance with the requirements of the standards applied.		
		Issue Date: Jan. 14, 2016	
	Tested by:	Reviewed by:	Approved by:
	 <hr style="width: 100%;"/> Daisy Chen / Engineer	 <hr style="width: 100%;"/> Mike Xu / Supervisor	 <hr style="width: 100%;"/> Andy Gao / Supervisor
Other Aspects:	None.		
<i>Abbreviations: OK/P=passed fail/F=failed n.a/N=not applicable E.U.T=equipment under tested</i>			
<i>This test report is based on a single evaluation of one sample of above mentioned products. It is not permitted to be duplicated in extracts without written approval of Keyway Testing Technology Co., Ltd.</i>			

1.TEST SUMMARY

Test Items	Test Requirement	Result
Conducted Emissions	15.207 &RSS-Gen §8.8	PASS
Radiated Emissions	15.205(a)/15.209/15.247(d) &RSS-Gen §6.13	PASS
6dB&99% Bandwidth	15.247(a)(2)& RSS-247 §5.2(1) &RSS-Gen§6.6	PASS
Power density	15.247(e) &RSS-247 §5.2 (2)	PASS
Maximum Peak Output Power	15.247(b)(3)& RSS-247 §5.4&RSS-Gen§6.12	PASS
Emissions from out of band	15.247(d) & RSS-247 §5.5	PASS
Antenna Requirement	15.203&RSS-Gen§8.3	PASS

2.GENERAL PRODUCT INFORMATION

2.1. Product Function

Refer to Technical Construction Form and User Manual.

2.2. Description of Device (EUT)

Product Name:	Portable 2-way full range loudspeakers with powered mixer
Model No.:	EON208P
Operation Frequency:	BT: 2402MHz~2480MHz
Channel numbers:	BT: 40 Channels
Modulation technology:	BT: GFSK
Antenna Type:	FPCB
Antenna gain:	0.72dBi
Power supply:	AC 120V/60Hz
Adapter	N/A

2.3. Independent Operation Modes

The basic operation modes are:

2.3.1. EUT work BT mode, and Test Mode as below:

Final Test Mode	Description
Mode 1	CH00
Mode 2	CH19
Mode 3	CH39
Mode 4	Link Mode

Remark: According to ANSI C63.10 standards, the test results are both the “worst case” and “worst setup”

2.4. Product Version

Product SW version	A0
Product HW version	A0
Radio SW version	A04
Radio HW version	A04
Test SW Version	B2.4
RF power setting in TEST SW	3dBm

2.6. List of Test and Measurement Instruments

2.6.1. For conducted emission at the mains terminals test

Equipment	Manufacturer	Model No.	Serial No.	Last Cal.	Next Cal.
EMI Test Receiver	Rohde&Schwarz	ESCI	101156	Apr. 27,15	Apr. 27,16
Artificial Mains Network	Rohde&Schwarz	ENV216	101315	Apr. 27,15	Apr. 27,16
Artificial Mains Network (AUX)	Rohde&Schwarz	ENV216	101314	Apr. 27,15	Apr. 27,16
RF Cable	FUJIKURA	3D-2W	944 Cable	Apr. 27,15	Apr. 27,16

2.6.2. For radiated emission test

Equipment	Manufacturer	Model No.	Serial No.	Last Cal.	Next Cal.
EMI Test Receiver	Rohde&Schwarz	ESCI	101156	Apr. 27,15	Apr. 27,16
System Simulator	Agilent	E5515C	GB43130245	Apr. 27,15	Apr. 27,16
Power Splitter	Weinschel	1506A	NW425	Apr. 27,15	Apr. 27,16
Bilog Antenna	ETS-LINDGREEN	3142D	135452	Apr. 27,15	Apr. 27,16
Spectrum Analyzer	Agilent	E4411B	MY4511304	Apr. 27,15	Apr. 27,16
Spectrum Analyzer	R&S	FSV40	132.1.3008K39-100967	Apr. 27,15	Apr. 27,16
3m Semi-anechoic Chamber	ETS-LINDGREEN	966	KW01	Apr. 27,15	Apr. 27,16
Signal Amplifier	SONOMA	310	187016	Apr. 27,15	Apr. 27,16
Signal Amplifier	Agilent	8449B	3008A00251	Apr. 27,15	Apr. 27,16
RF Cable	IMRO	IMRO-400	966 Cable 1#	N/A	N/A
MULTI-DEVICE Controller	ETS-LINDGREEN	2090	126913	N/A	N/A
Horn Antenna	DAZE	ZN30701	11003	Apr. 27,15	Apr. 27,16
Horn Antenna	SCHWARZBECK	BBHA9170	9170-068	Apr. 27,15	Apr. 27,16
Spectrum Analyzer	Agilent	8593E	3911A04271	Apr. 27,15	Apr. 27,16
Spectrum Analyzer	Agilent	E4408B	MY44211125	Apr. 27,15	Apr. 27,16
Signal Amplifier	DAZE	ZN3380C	11001	Apr. 27,15	Apr. 27,16
High Pass filter	Micro	HPM50111	324216	Apr. 27,15	Apr. 27,16
Filter	COM-MW	ZBSF-C836.5-25-X	KW032	Apr. 27,15	Apr. 27,16
Filter	COM-MW	ZBSF-C1747.5-75-X2	KW035	Apr. 27,15	Apr. 27,16
Filter	COM-MW	ZBSF-C1880-60-X2	KW037	Apr. 27,15	Apr. 27,16
DC Power Supply	LongWei	PS-305D	010964729	Apr. 27,15	Apr. 27,16
Constant temperature and humidity box	GF	GTH-800-40-1P	MAA9906-005	Apr. 27,15	Apr. 27,16
Universal radio communication tester	Rohde&Schwarz	CMU200	3215420	Apr. 27,15	Apr. 27,16
Splitter	Agilent	11636B	0025164	Apr. 27,15	Apr. 27,16
Loop Antenna	ARA	PLA-1030/B	1029	Apr. 22,15	Apr. 22,16
Power Meter	R&S	NRVS	100696	Apr. 24,15	Apr. 24,16
Power Sensor	R&S	URV5-Z4	395.1619.05	Apr. 24,15	Apr. 24,16

3. TEST SET-UP AND OPERATION MODES

3.1. Principle of Configuration Selection

Emission: The equipment under test (EUT) was configured to measure its highest possible radiation level. The test modes were adapted accordingly in reference to the Operating Instructions.

3.2. Block Diagram of Test Set-up

System Diagram of Connections between EUT and Simulators

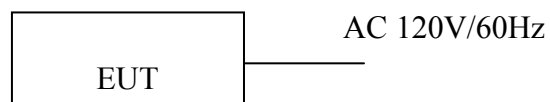

3.3. Test Operation Mode and Test Software

None.

3.4. Special Accessories and Auxiliary Equipment

None.

3.5. Countermeasures to Achieve EMC Compliance

None.

4. EMISSION TEST RESULTS

4.1. Conducted Emission at the Mains Terminals Test

4.1.1. Limit 15.207 limits

FREQUENCY OF EMISSION (MHz)	CONDUCTED LIMIT (dB μ V)	
	Quasi-peak	Average
0.15-0.5	66 to 56	56 to 46
0.5-5	56	46
5-30	60	50

4.1.2. Test Setup

The EUT was put on a wooden table which was 0.8 m high above the ground and connected to the AC mains through the Artificial Mains Network (AMN). Where the mains cable supplied by the manufacture was longer than 0.8 m, the excess was folded back and forth parallel to the cable at the centre so as to form a bundle no longer than 0.4 m.

The EUT was kept 0.4 m from any other earthed conducting surface. Both sides of AC line were checked to find out the maximum conducted emission levels according to the test procedure during the conducted emission test.

The frequency range from 150 kHz to 30 MHz was investigated.

The bandwidth of the test receiver was set at 9 kHz.

Pretest for all mode, The test data of the worst case condition(s) was reported on the following page.

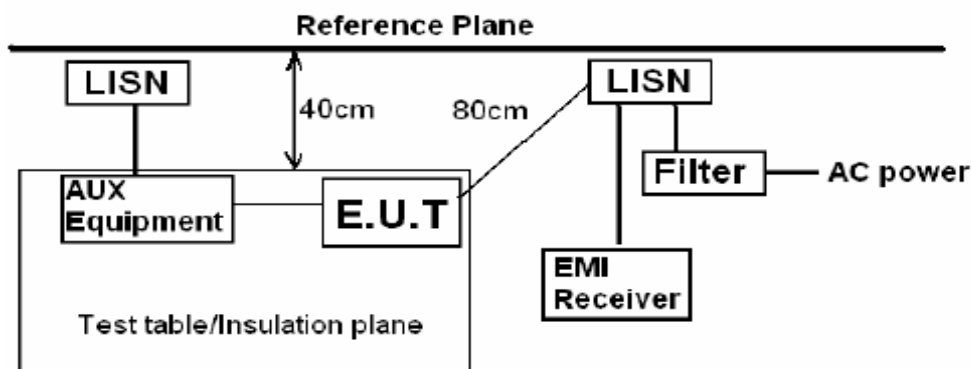

Remark:
E.U.T: Equipment Under Test
LISN: Line Impedance Stabilization Network
Test table height=0.8m

EUT :	Portable 2-way full range loudspeakers with powered mixer	Model Name :	EON208P
Temperature :	26 °C	Relative Humidity :	54%
Pressure :	1010hPa	Phase :	L
Test Voltage :	AC 120V/60Hz	Test Mode :	Mode 4

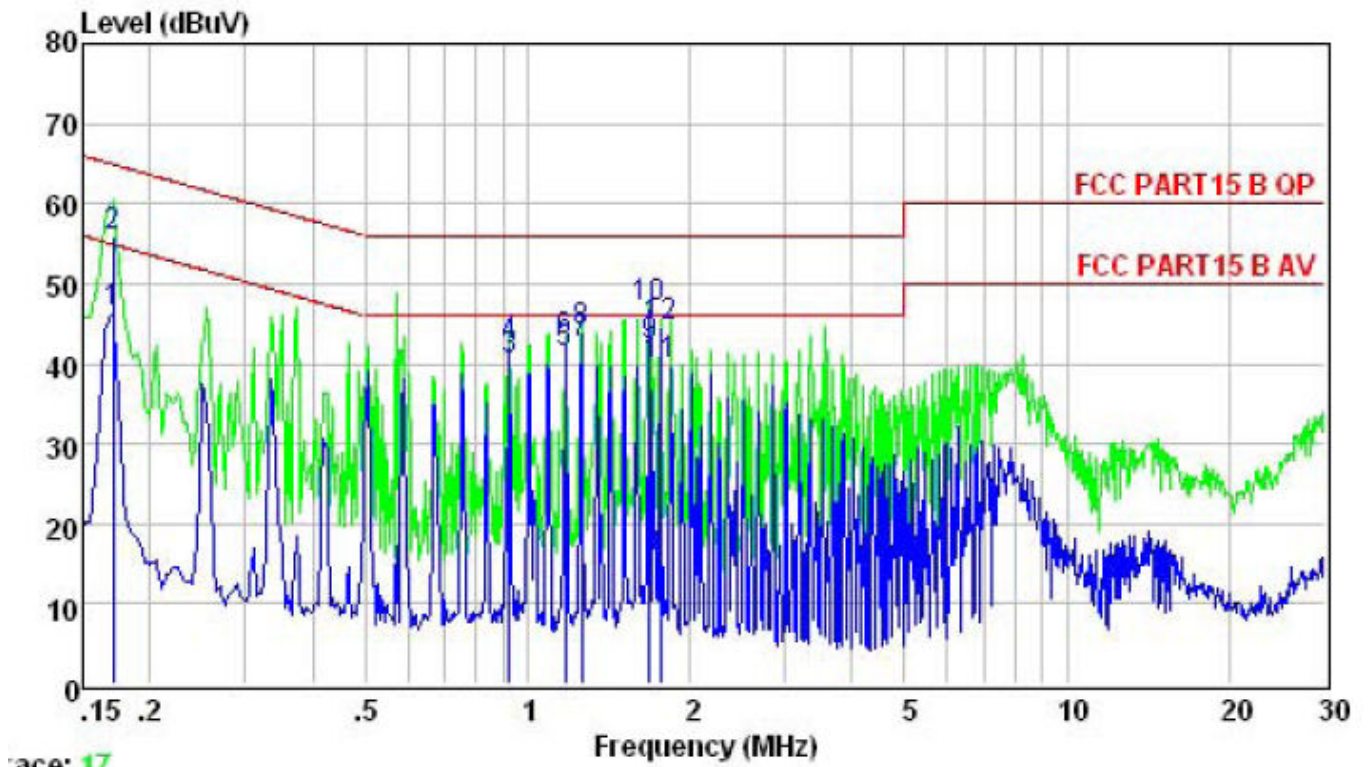

	Freq	Level	Limit	Over	Remark
	MHz	dBuV	dBuV	dB	
1	0.170	46.33	54.94	-8.61	Average
2	0.170	55.80	64.94	-9.14	QP
3	0.923	40.31	46.00	-5.69	Average
4	0.923	42.10	56.00	-13.90	QP
5	1.172	41.42	46.00	-4.58	Average
6	1.172	42.80	56.00	-13.20	QP
7	1.262	42.51	46.00	-3.49	Average
8	1.262	43.90	56.00	-12.10	QP
9	1.680	42.10	46.00	-3.90	Average
10	1.680	46.85	56.00	-9.15	QP
11	1.762	39.79	46.00	-6.21	Average
12	1.762	44.50	56.00	-11.50	QP

EUT :	Portable 2-way full range loudspeakers with powered mixer	Model Name :	EON208P
Temperature :	26 °C	Relative Humidity :	54%
Pressure :	1010hPa	Phase :	N
Test Voltage :	AC 120V/60Hz	Test Mode :	Mode 4

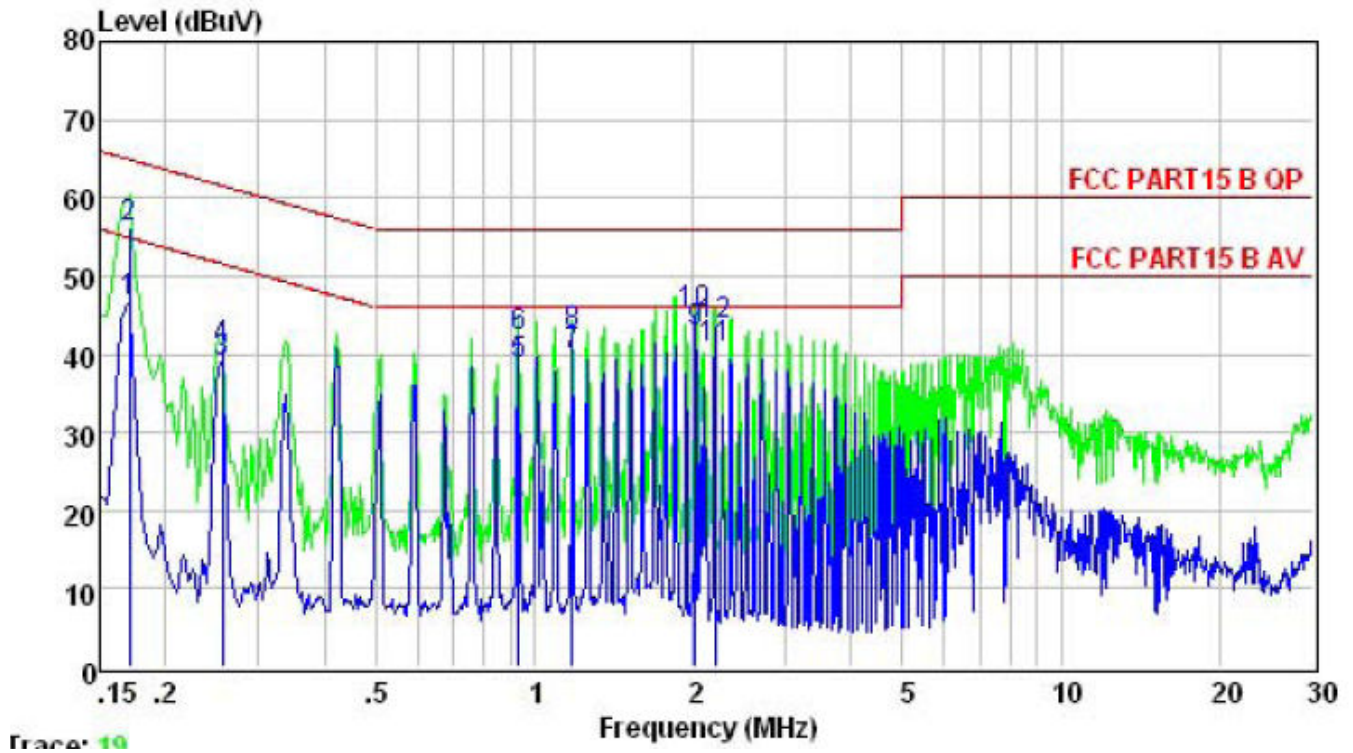

	Freq	Level	Limit	Over	Remark
	MHz	dBuV	dBuV	dB	
1	0.170	46.64	54.94	-8.30	Average
2	0.170	56.20	64.94	-8.74	QP
3	0.256	39.09	51.56	-12.47	Average
4	0.256	40.80	61.56	-20.76	QP
5	0.933	38.77	46.00	-7.23	Average
6	0.933	42.30	56.00	-13.70	QP
7	1.178	39.87	46.00	-6.13	Average
8	1.178	42.60	56.00	-13.40	QP
9	2.023	42.70	46.00	-3.30	Average
10	2.023	45.27	56.00	-10.73	QP
11	2.201	40.73	46.00	-5.27	Average
12	2.201	43.80	56.00	-12.20	QP

4.2. Radiated Emission Test

4.2.1. Limit 15.209 limits

FREQUENCY MHz	DISTANCE Meters	FIELD STRENGTHS LIMIT	
		$\mu\text{V}/\text{m}$	$\text{dB}(\mu\text{V})/\text{m}$
30 ~ 88	3	100	40.0
88 ~ 216	3	150	43.5
216 ~ 960	3	200	46.0
960 ~ 1000	3	500	54.0
Above 1000	3	74.0 $\text{dB}(\mu\text{V})/\text{m}$ (Peak) 54.0 $\text{dB}(\mu\text{V})/\text{m}$ (Average)	

4.2.2. Restricted bands of operation

MHz	MHz	MHz	GHz
0.090 - 0.110	16.42 - 16.423	399.9 - 410	4.5 - 5.15
¹ 0.495 - 0.505	16.69475 - 16.69525	608 - 614	5.35 - 5.46
2.1735 - 2.1905	16.80425 - 16.80475	960 - 1240	7.25 - 7.75
4.125 - 4.128	25.5 - 25.67	1300 - 1427	8.025 - 8.5
4.17725 - 4.17775	37.5 - 38.25	1435 - 1626.5	9.0 - 9.2
4.20725 - 4.20775	73 - 74.6	1645.5 - 1646.5	9.3 - 9.5
6.215 - 6.218	74.8 - 75.2	1660 - 1710	10.6 - 12.7
6.26775 - 6.26825	108 - 121.94	1718.8 - 1722.2	13.25 - 13.4
6.31175 - 6.31225	123 - 138	2200 - 2300	14.47 - 14.5
8.291 - 8.294	149.9 - 150.05	2310 - 2390	15.35 - 16.2
8.362 - 8.366	156.52475 - 156.52525	2483.5 - 2500	17.7 - 21.4
8.37625 - 8.38675	156.7 - 156.9	2690 - 2900	22.01 - 23.12
8.41425 - 8.41475	162.0125 - 167.17	3260 - 3267	23.6 - 24.0
12.29 - 12.293	167.72 - 173.2	3332 - 3339	31.2 - 31.8
12.51975 - 12.52025	240 - 285	3345.8 - 3358	36.43 - 36.5
12.57675 - 12.57725	322 - 335.4	3600 - 4400	(²)

All the emissions appearing within 15.205 restricted frequency bands shall not exceed the limits shown in 15.209, all the other emissions shall be at least 20dB below the fundamental emissions, or comply with 15.209 limits.

4.2.3. Test setup

The EUT was placed on a turn table which was 0.8 m (above 1GHz, the table was 1.5m) above the ground. The turn table can rotate 360 degrees to determine the position of the maximum emission level. The EUT was set 3 m away from the receiving antenna which was mounted on an antenna tower. The measuring antenna moved up and down to find out the maximum emission level. It moved from 1 m to 4 m for both horizontal and vertical polarizations.

The EUT was tested in the Chamber Site. It was pre-scanned with a Peak detector from the spectrum, and all the final readings from the test receiver were measured with the Quasi-Peak detector.

The bandwidth of the EMI test receiver is set at 120kHz for frequency range from 30MHz to 1000 MHz.

The bandwidth of the Spectrum's VBW is set at 3MHz and RBW is set at 1MHz for peak emissions measurement above 1GHz and 1MHz RBW, 10Hz VBW for average emissions measure above 1GHz, Both PK and AV measure, PK detector is used.

The frequency range from 30MHz to 10th harmonic (25GHz) are checked. and no any emissions were found from 18GHz to 25 GHz, So the radiated emissions from 18GHz to 25GHz were not record.

Notes: 1. Emission Level = Antenna Factor + Cable Loss + Meter Reading-Preamp Factor.

2. Measurement Uncertainty: ± 3.2 dB at a level of confidence of 95%.

3. For emissions above 1GHz, if peak level comply with average limit, then the average level is deemed to comply with average limit.

4. For emissions below 1GHz, pretest for all mode, The test data of the worst case condition(s) was reported on the following pages.

5. For Both PK and AV value above 1GHz, PK detector is used.

6. EUT Pre-scan X/Y/Z orientation, only worst case is presented in the report (Z orientation).

Radiated Emission Test-Up Frequency Below 30MHz

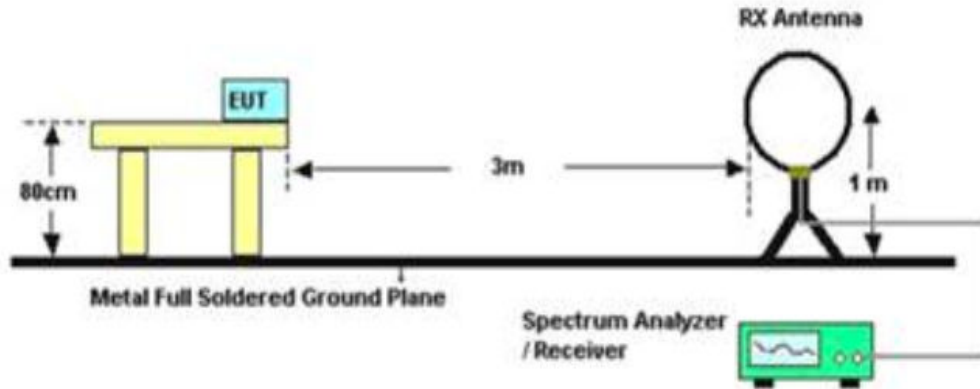

30MHz- 1GHz

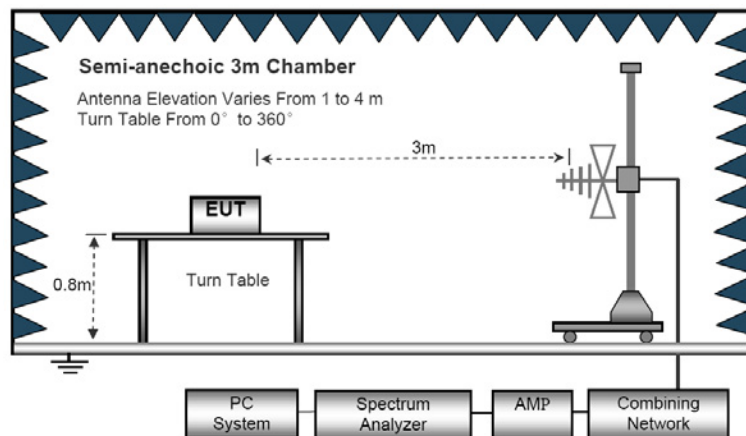

Above 1GHz

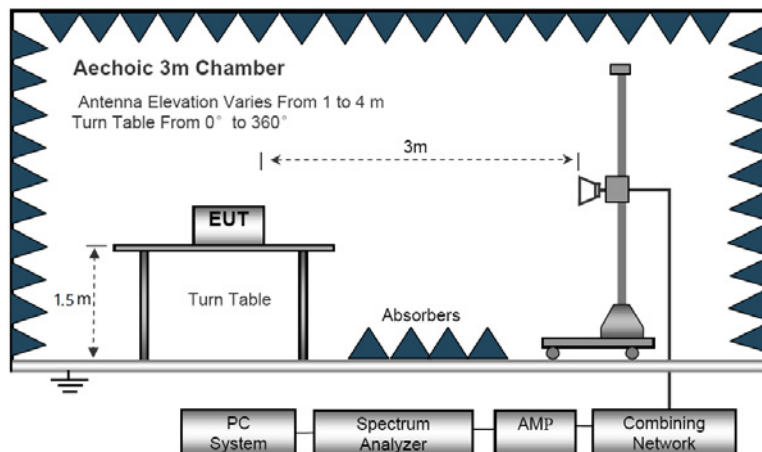

Below 30MHz

Freq.	Reading	Limit	Margin	State
(MHz)	(dBuV/m)	(dBuV/m)	(dB)	P/F
--	--	--	--	P
--	--	--	--	P

Note:

The amplitude of spurious emissions which are attenuated by more than 20dB below the permissible value has no need to be reported.

Distance extrapolation factor = $40 \log (\text{specific distance}/\text{test distance})$ (dB);

Limit line = specific limits(dBuv) + distance extrapolation factor.

EUT :	Portable 2-way full range loudspeakers with powered mixer	Model Name :	EON208P
Temperature :	20 °C	Relative Humidity :	48%
Pressure :	1010hPa	Test Mode :	TX
Test Voltage :	AC 120V/60Hz		

30- 1GHz
Horizontal

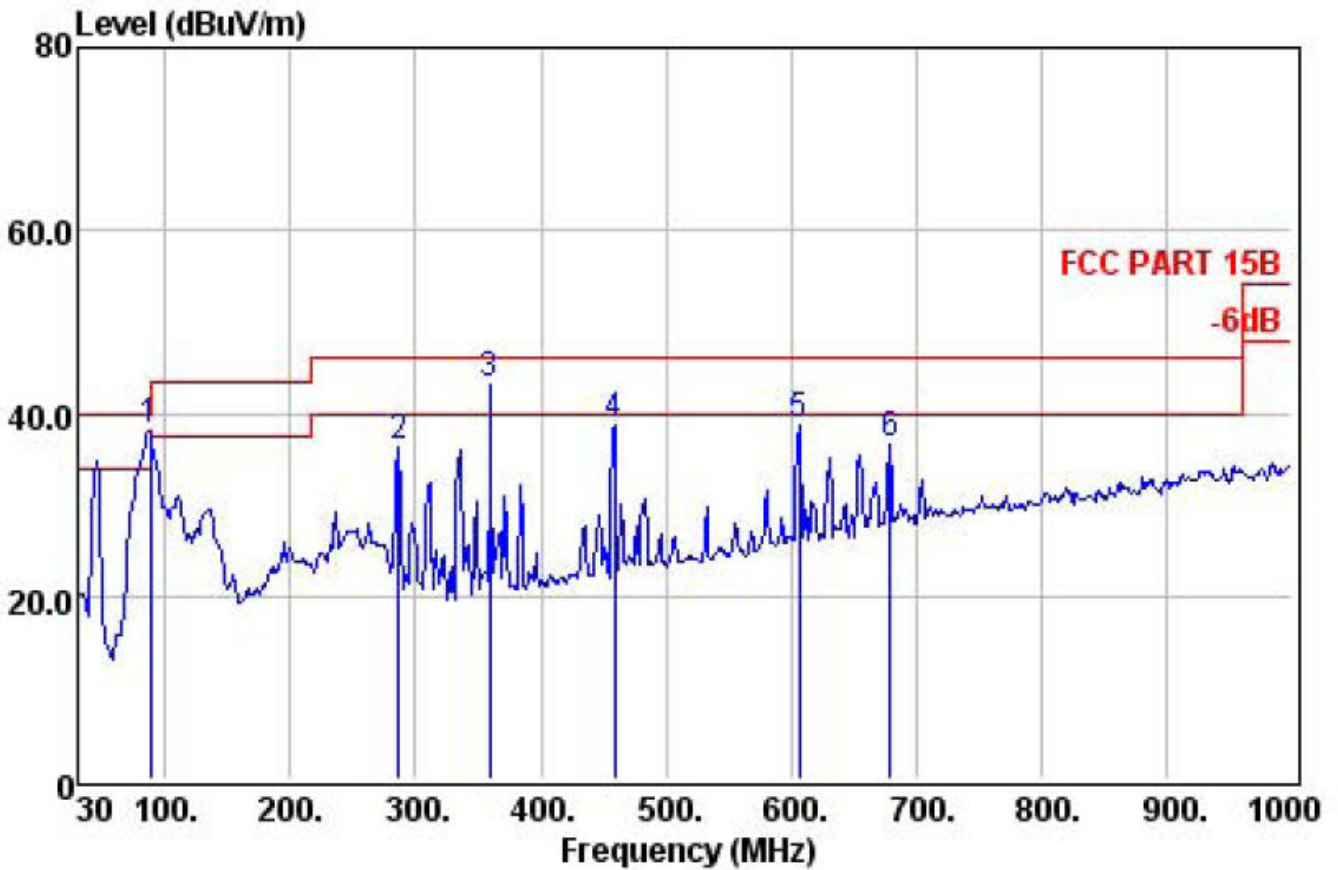

		Preamp	Read	Cable		Limit	Over	
	Freq	Factor	Level	Loss	Level	Line	Limit	Remark
	MHz	dB	dBuV	dB	dBuV/m	dBuV/m	dB	
1 !	88.20	31.35	59.61	0.94	38.10	43.50	-5.40	QP
2	287.05	30.94	52.01	1.87	36.33	46.00	-9.67	QP
3 !	359.80	30.62	55.38	2.18	43.05	46.00	-2.95	QP
4	458.74	30.61	48.69	2.62	38.54	46.00	-7.46	QP
5	607.15	30.59	44.95	3.38	38.54	46.00	-7.46	QP
6	679.90	30.75	41.60	3.80	36.63	46.00	-9.37	QP

Vertical

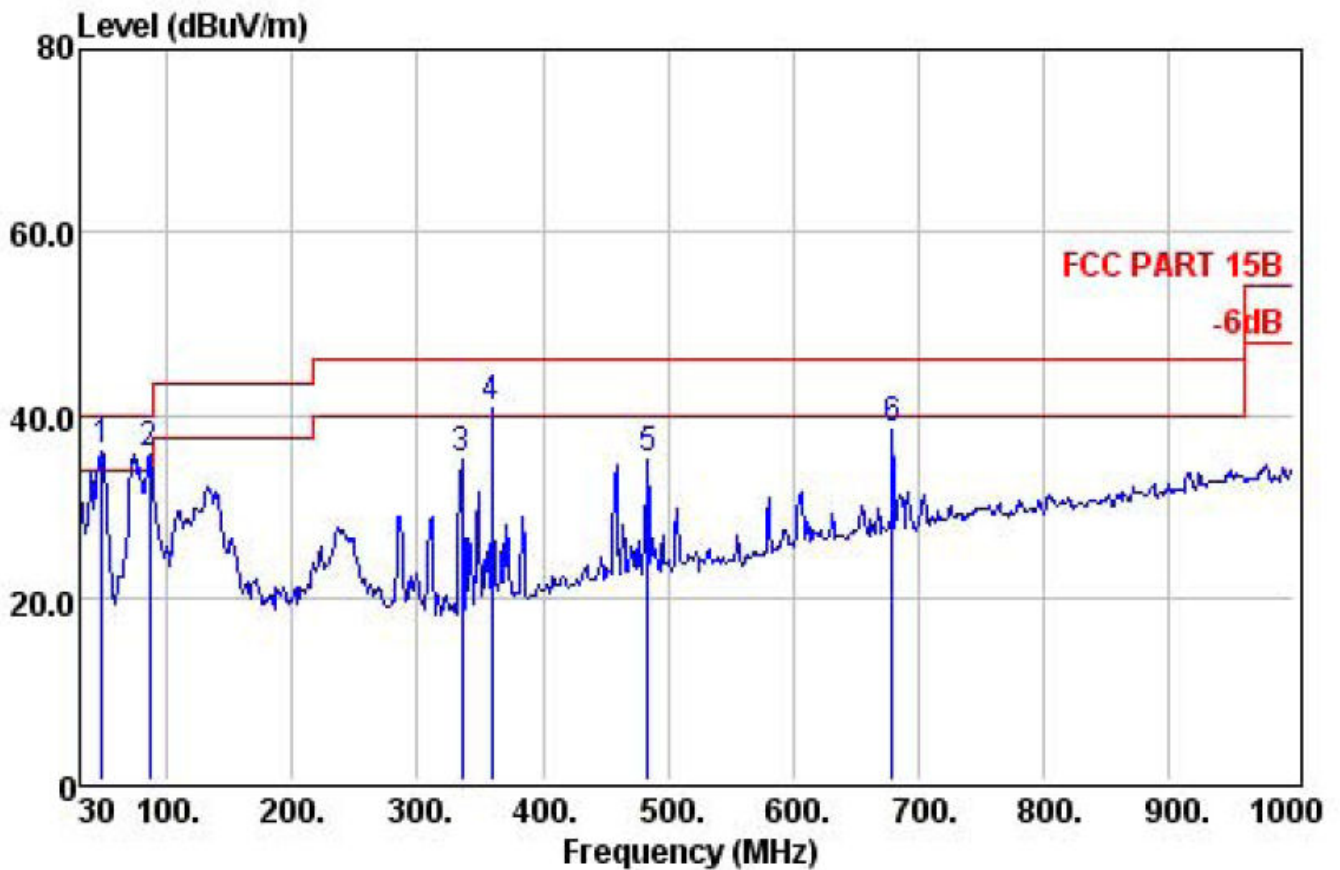

		Preamp	Read	Cable	Limit	Over	
	Freq	Factor	Level	Loss	Line	Limit	Remark
	MHz	dB	dBuV	dB	dBuV/m	dBuV/m	dB
1 !	47.46	31.39	56.76	0.75	35.96	40.00	-4.04 QP
2 !	86.26	31.35	57.41	0.94	35.69	40.00	-4.31 QP
3	335.55	30.74	48.68	2.10	34.96	46.00	-11.04 QP
4 !	359.80	30.62	53.19	2.18	40.86	46.00	-5.14 QP
5	483.96	30.59	44.33	2.77	34.95	46.00	-11.05 QP
6	679.90	30.75	43.33	3.80	38.36	46.00	-7.64 QP

NOTE:

Absolute Level= ReadingLevel+antenna Factor+cable loss-preamp factor,

Over Limit= Absolute Level – Limit

Mode 1 is the worst mode.

Above 1GHz

EUT :	Portable 2-way full range loudspeakers with powered mixer	Model Name :	EON208P
Temperature :	20 °C	Relative Humidity :	48%
Pressure :	1010hPa	Test Mode :	TX-2402
Test Voltage :	AC 120V/60Hz		

Vertical

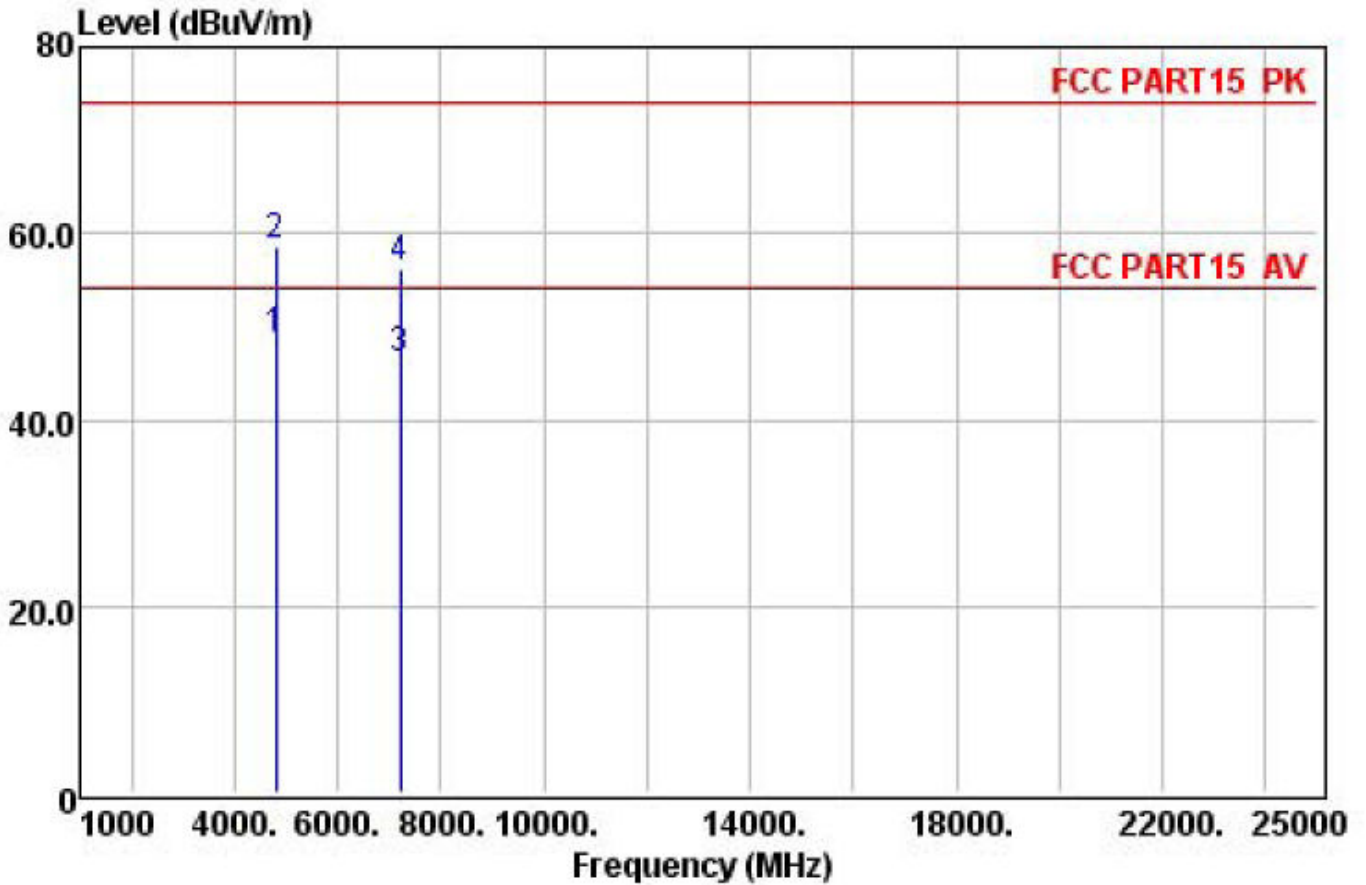

	Preamp Freq	Preamp Factor	Read Level	Cable Loss	Level	Limit Line	Over Limit	Remark
	MHz	dB	dBuV	dB	dBuV/m	dBuV/m	dB	
1	4804.00	27.49	31.13	11.96	48.54	54.00	-5.46	Average
2	4804.00	27.49	41.30	11.96	58.71	74.00	-15.29	Peak
3	7206.00	27.94	32.39	16.61	46.34	54.00	-7.66	Average
4	7206.00	27.94	42.39	16.61	56.34	74.00	-17.66	Peak

Horizontal

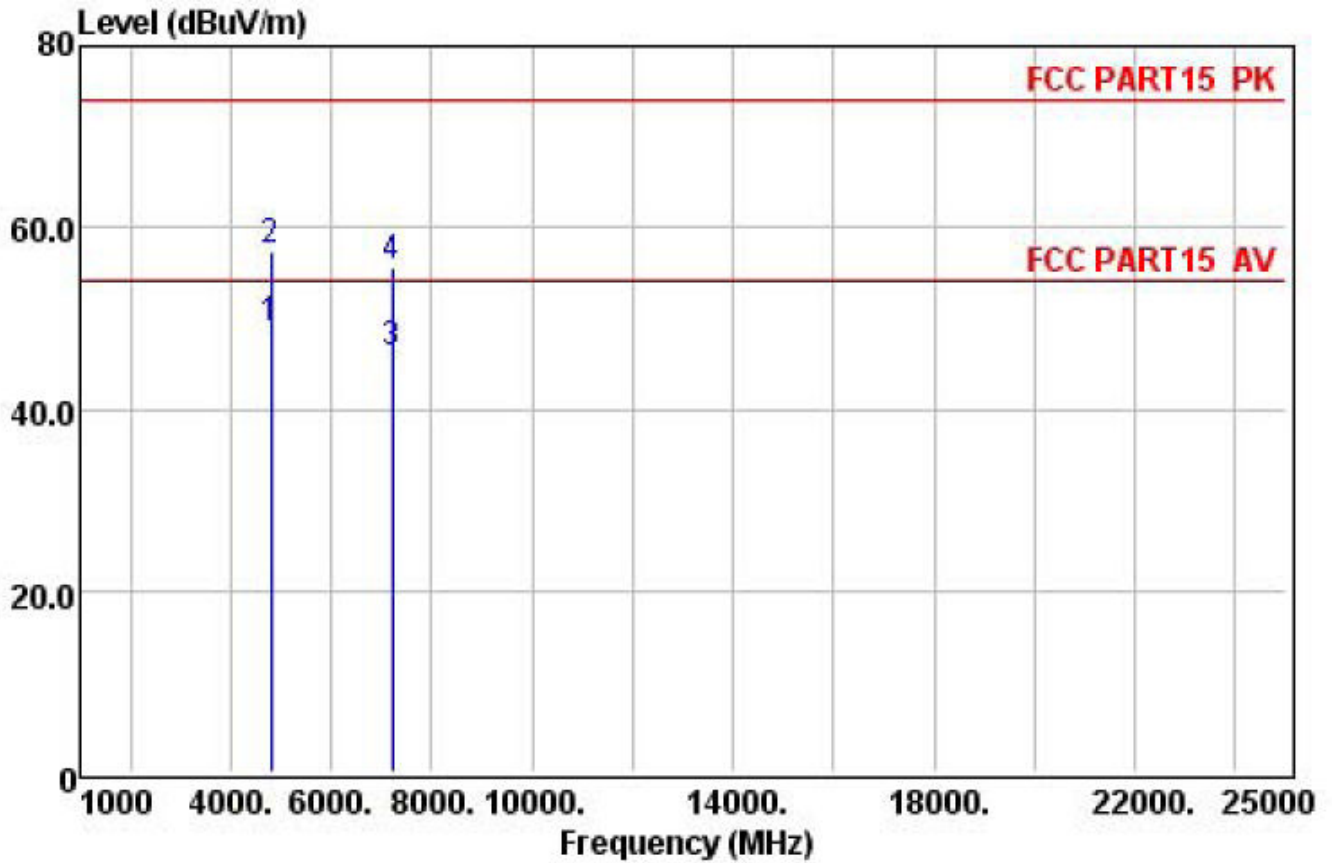

	Preamp	Read	Cable	Limit	Over			
Freq	Factor	Level	Loss	Line	Limit	Remark		
MHz	dB	dBuV	dB	dBuV/m	dBuV/m	dB		
1	4804.00	27.49	31.23	11.96	48.64	54.00	-5.36	Average
2	4804.00	27.49	40.00	11.96	57.41	74.00	-16.59	Peak
3	7206.00	27.94	32.11	16.61	46.06	54.00	-7.94	Average
4	7206.00	27.94	41.69	16.61	55.64	74.00	-18.36	Peak

EUT :	Portable 2-way full range loudspeakers with powered mixer	Model Name :	EON208P
Temperature :	20 °C	Relative Humidity :	48%
Pressure :	1010hPa	Test Mode :	TX-2440
Test Voltage :	AC 120V/60Hz		

Vertical

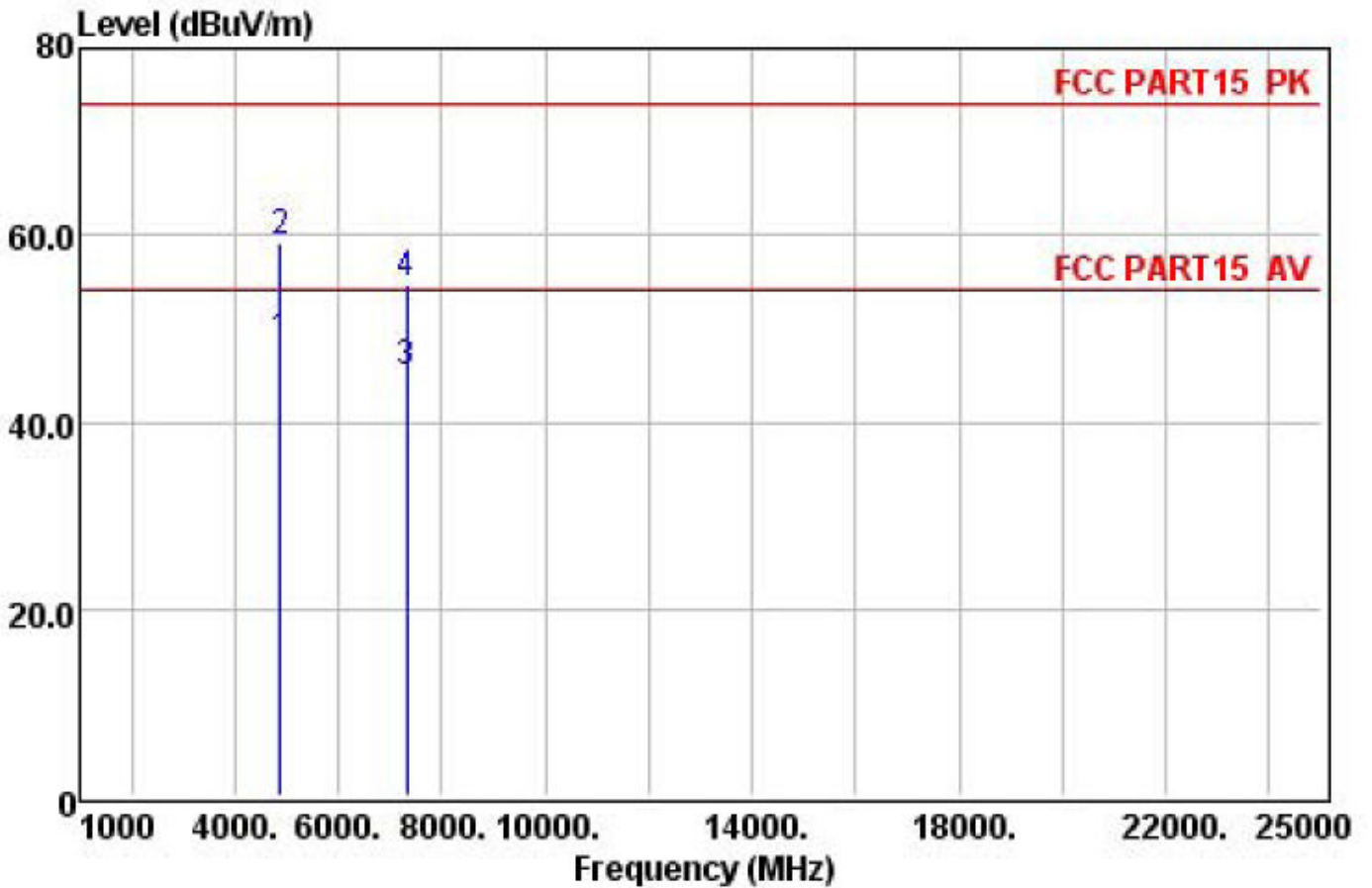

	Preamp	Read	Cable	Limit	Over		
Freq	Factor	Level	Loss	Line	Limit	Remark	
MHz	dB	dBuV	dB	dBuV/m	dBuV/m	dB	
1	4880.00	27.53	31.44	12.14	48.16	54.00	-5.84 Average
2	4880.00	27.53	42.37	12.14	59.09	74.00	-14.91 Peak
3	7320.00	27.96	32.08	16.62	45.07	54.00	-8.93 Average
4	7320.00	27.96	41.68	16.62	54.67	74.00	-19.33 Peak

Horizontal

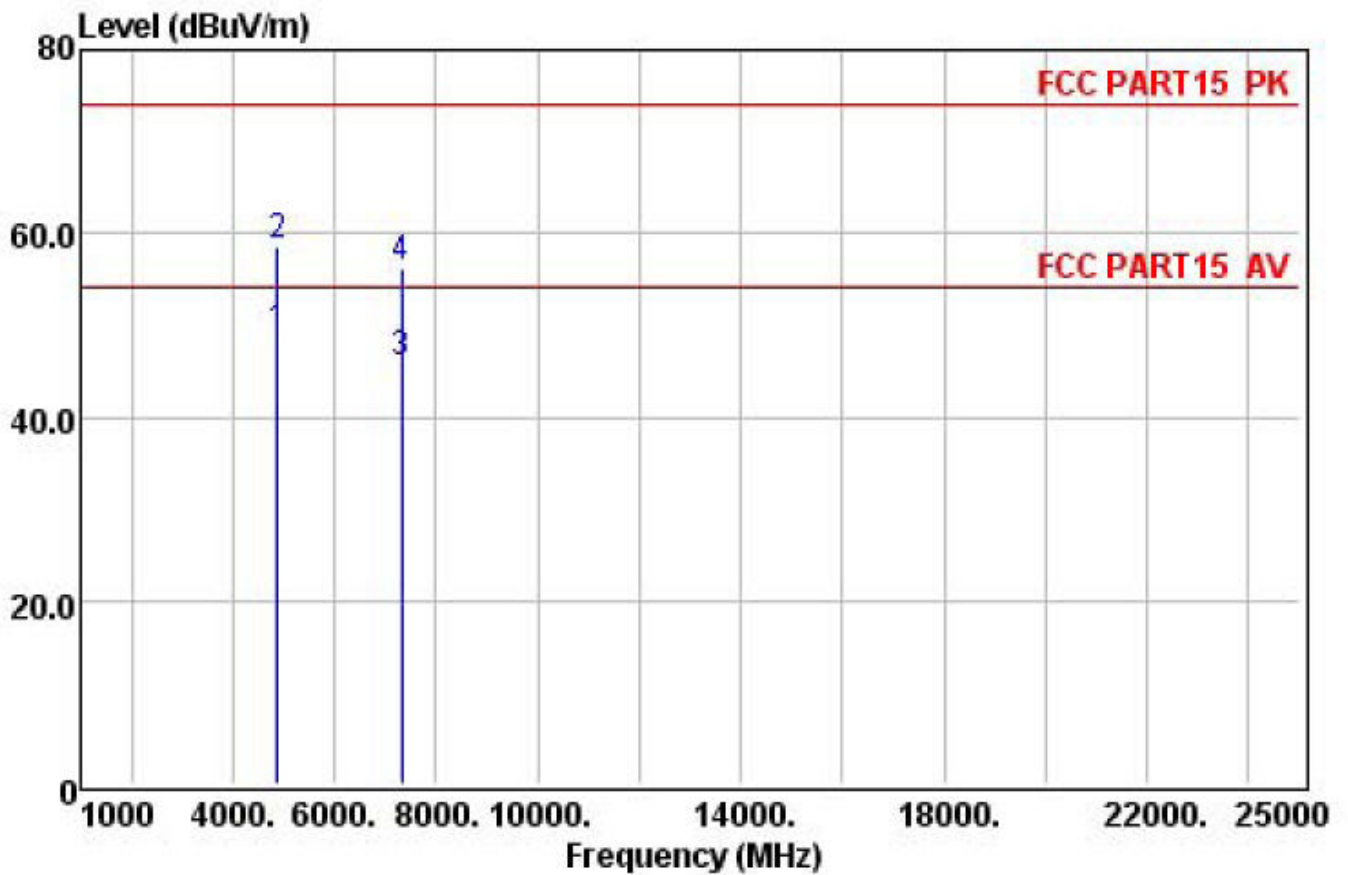

	Preamp Freq	Factor	Read Level	Cable Loss	Level	Limit Line	Over Limit	Remark
	MHz	dB	dBuV	dB	dBuV/m	dBuV/m	dB	
1	4880.00	27.53	32.16	12.14	48.88	54.00	-5.12	Average
2	4880.00	27.53	41.93	12.14	58.65	74.00	-15.35	Peak
3	7320.00	27.96	32.67	16.62	45.66	54.00	-8.34	Average
4	7320.00	27.96	43.25	16.62	56.24	74.00	-17.76	Peak

EUT :	Portable 2-way full range loudspeakers with powered mixer	Model Name :	EON208P
Temperature :	20 °C	Relative Humidity :	48%
Pressure :	1010hPa	Test Mode :	TX-2480
Test Voltage :	AC 120V/60Hz		

Vertical

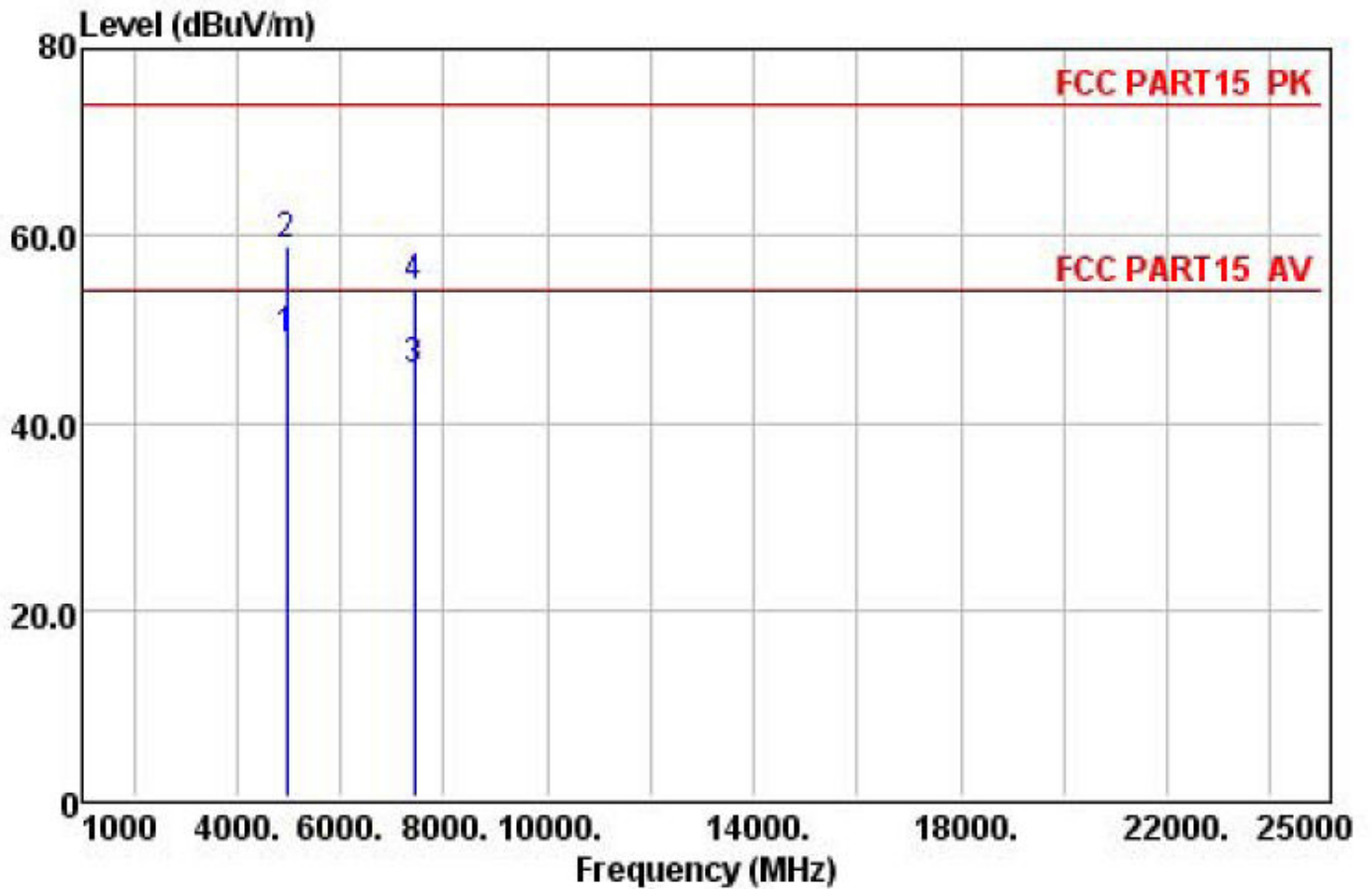

	Preamp Freq	Preamp Factor	Read Level	Cable Loss	Level	Limit Line	Over Limit	Remark
	MHz	dB	dBuV	dB	dBuV/m	dBuV/m	dB	
1	4960.00	27.58	32.69	12.36	48.79	54.00	-5.21	Average
2	4960.00	27.58	42.93	12.36	59.03	74.00	-14.97	Peak
3	7440.00	27.99	32.38	16.62	45.39	54.00	-8.61	Average
4	7440.00	27.99	41.53	16.62	54.54	74.00	-19.46	Peak

Horizontal

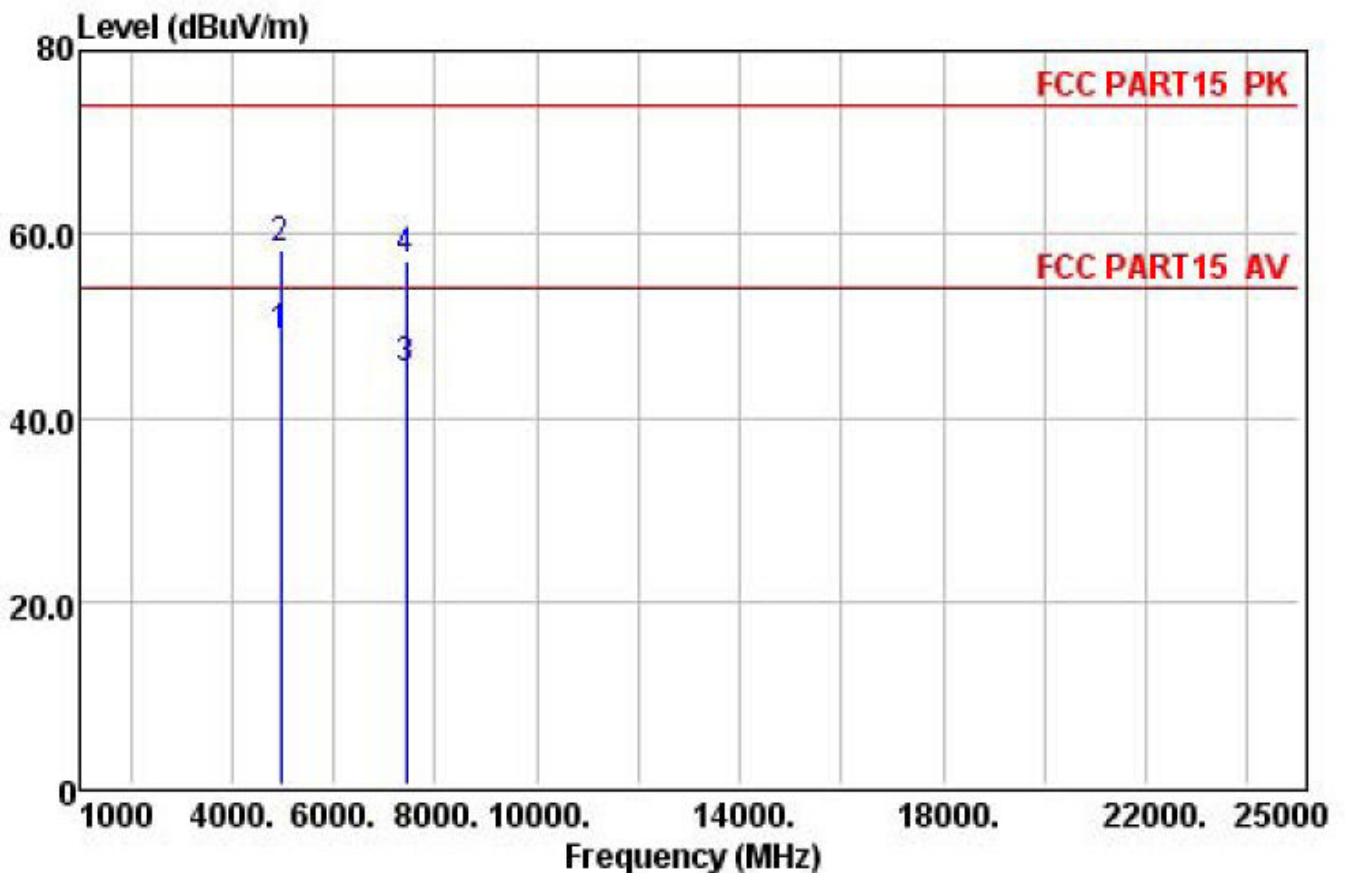

	Preamp Freq	Factor dB	Read Level dBuV	Cable Loss dB	Level dBuV/m	Limit Line dBuV/m	Over Limit dB	Remark
1	4960.00	27.58	32.68	12.36	48.78	54.00	-5.22	Average
2	4960.00	27.58	42.07	12.36	58.17	74.00	-15.83	Peak
3	7440.00	27.99	32.18	16.62	45.19	54.00	-8.81	Average
4	7440.00	27.99	44.19	16.62	57.20	74.00	-16.80	Peak

NOTE:

Absolute Level= ReadingLevel+antenna Factor+cable loss-preamp factor,

Over Limit= Absolute Level – Limit

The amplitude of spurious emissions which are attenuated by more than 20dB below the permissible value has not to be reported.

5. BAND EDGE COMPLIANCE TEST

5.1. Limits

All the lower and upper band-edges emissions appearing within 2310MHz to 2390MHz and 2483.5MHz to 2500MHz restricted frequency bands shall not exceed the limits shown in 15.209, all the other emissions outside operation frequency band 2400MHz to 2483.5MHz shall be at least 30dB below the fundamental emissions, or comply with 15.209 limits.

5.2. Test setup

For Conducted Test



For Radiated emission Test

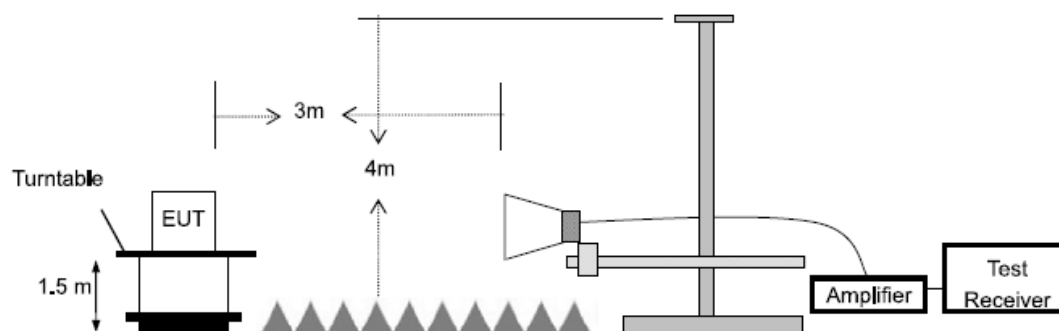

5.3. TEST Procedure

For Conducted Test

1. The transmitter output is connected to a spectrum analyzer. The resolution bandwidth is set to 100KHz. The video bandwidth is set to 300KHz.
2. The spectrum from 30MHz to 26 GHz is investigated with the transmitter set to the lowest, middle, and highest channels.

EMI Test Receiver	Setting
Attenuation	Auto
RBW	100KHz
VBW	300KHz
Detector	Peak
Trace	Max hold

For Radiated emission Test

The EUT was placed on a styrofoam table which is 1.5m above ground plane.

The measurement procedure at the band edges was simplified by performing the measurement in just one plot. Both, the in-band-emission and the unwanted emission were encompassed by the span. After trace stabilization, the maximum peak was determined by a peak detector and the value was marked by an appropriate limit line. The second limit line, which is 20dB below the first, marks the limit for the emissions in the unrestricted band. A maximum-peak-detector marks the highest emission in the unrestricted band next to the band edge.

The measurements were performed at the lower end of the 2.4GHz band.

Use the following spectrum analyzer settings:

For Restricted Band, When spectrum scanned above 1GHz setting resolution bandwidth 1MHz, video bandwidth 3MHz:

EMI Test Receiver	Setting
Attenuation	Auto
RBW	1MHz
VBW	3MHz
Detector	Peak
Trace	Max hold

For Non-Restricted Band, When spectrum scanned above 1GHz setting resolution bandwidth 100KHz, video bandwidth 300KHz:

EMI Test Receiver	Setting
Attenuation	Auto
RBW	100KHz
VBW	300KHz
Detector	Peak
Trace	Max hold

For radiated test as follows:

Frequency (MHz)	Meter Reading (dB μ V)	Factor (dB)	Emission Level (dB μ V/m)	Limits (dB μ V/m)	Margin (dB)	Detector Type	Comment
2390	38.97	13.06	52.03	74.00	-21.97	peak	Vertical
2390	38.64	13.06	51.7	74.00	-22.3	peak	Horizontal
2483.5	37.88	12.78	50.66	74.00	-23.34	peak	Vertical
2483.5	38.61	12.78	51.39	74.00	-22.61	peak	Horizontal

If the PK measured levels comply with average limit, then the average level were deemed to comply with average limit.

conduction band-edge

Frequency Band	Delta Peak to band emission (dBc)	>Limit (dBc)	Result
Left-band	46.57	20	Pass
Right-band	61.22	20	Pass

Left Side

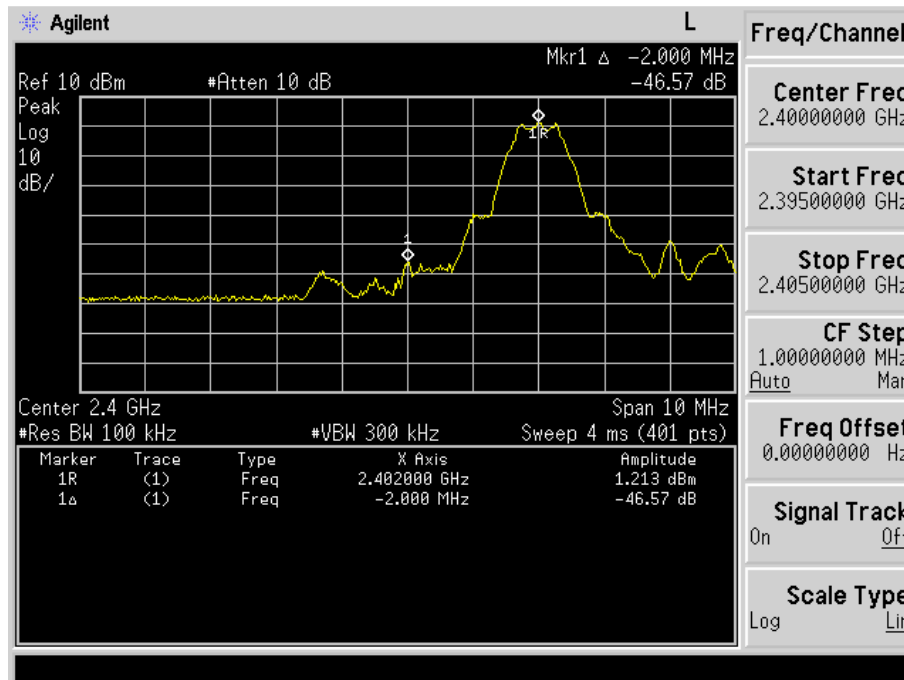

Right Side

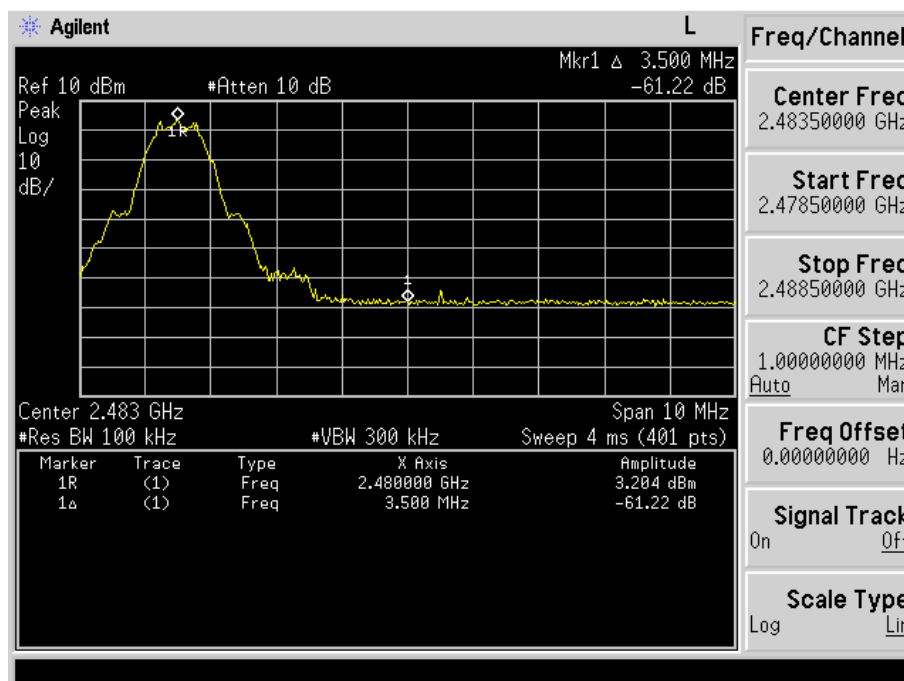

6. 6DB OCCUPY BANDWIDTH

6.1. Limits

For direct sequence systems, the minimum 6dB bandwidth shall be at least 500kHz

6.2. TEST PROCEDURE

1. Set RBW = 100 kHz.
2. Set the video bandwidth (VBW) $\geq 3 \times$ RBW.
3. Detector = Peak.
4. Trace mode = max hold.
5. Sweep = auto couple.
6. Allow the trace to stabilize.
7. Measure the maximum width of the emission that is constrained by the frequencies associated with the two outermost amplitude points (upper and lower) that are attenuated by 6 dB relative to the maximum level measured in the fundamental emission.

Test data:

Channel Frequency (MHz)	6dB Bandwidth (MHz)	99% Bandwidth (MHz)	Result
2402	0.727	1.056	Pass
2440	0.750	1.058	Pass
2480	0.733	1.058	Pass

Test plot as follows:

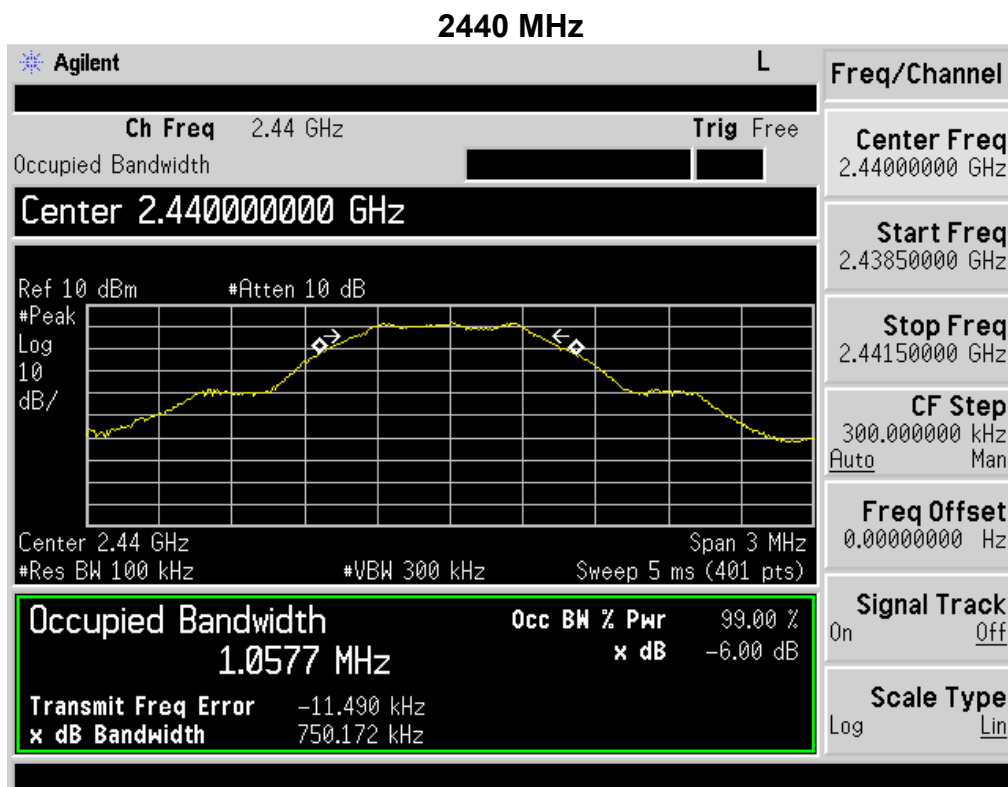
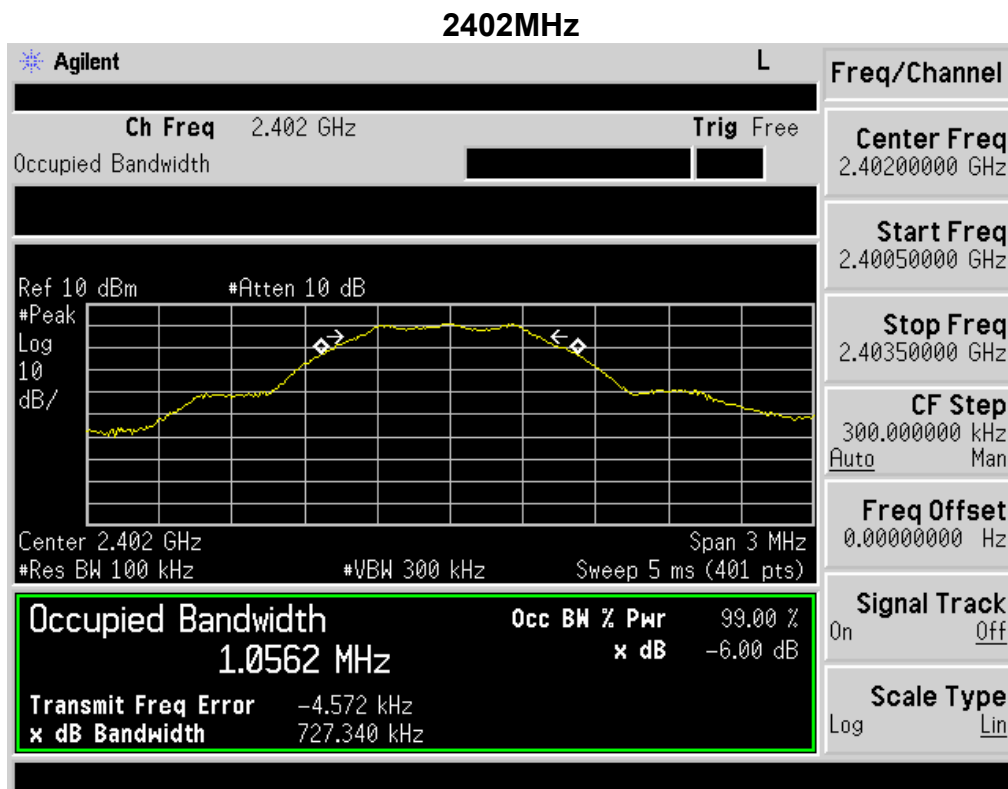

2480 MHz

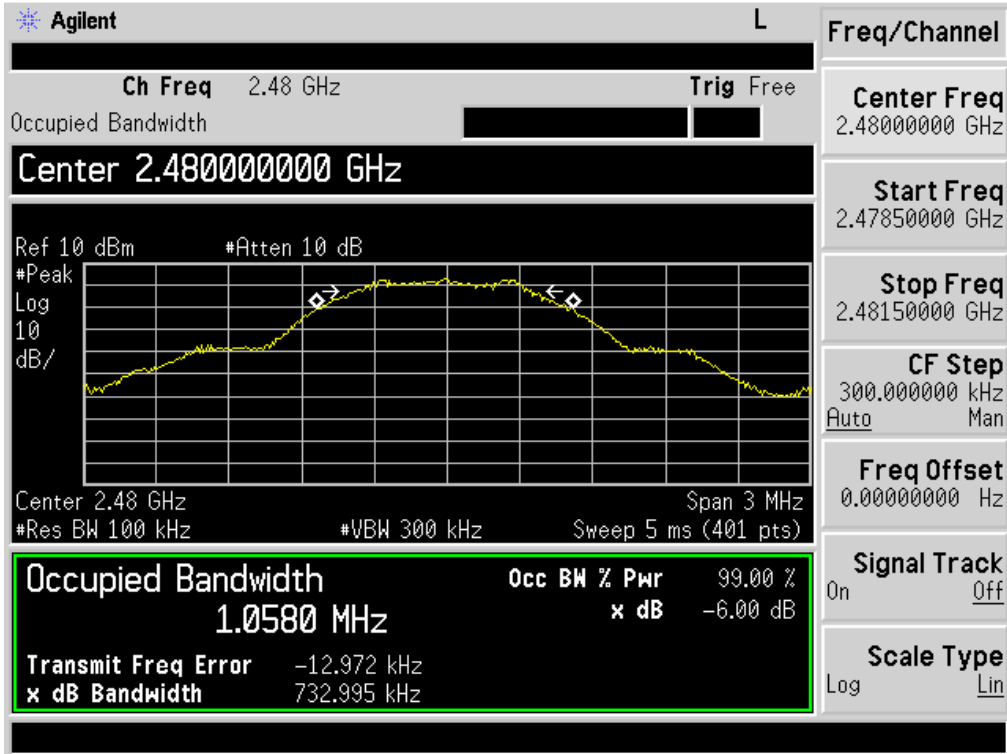

7. OUTPUT POWER TEST

7.1. Limits

For systems using digital modulation in the 2400~2483.5MHz, The out put Power shall not exceed 1W (30dBm)

7.2. Test setup

1. The Transmitter output (antenna port) was connected to the power meter.
2. Turn on the EUT and power meter and then record the power value.
3. Repeat above procedures on all channels needed to be tested.

Note: The cable loss and attenuator loss were offset into measure device as an amplitude offset.

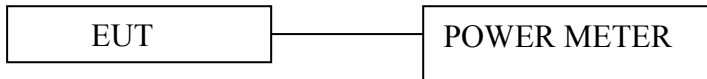

7.3. Test result

Frequency (MHz)	Maximum Conducted Output Power (dBm)	Limit (dBm)
2402	1.929	30
2440	2.506	30
2480	3.023	30

8. POWER SPECTRAL DENSITY TEST

8.1. Limits

For digitally modulated systems, the power spectral density conducted from the intentional radiator to the antenna shall not be greater than 8dBm in any 3kHz band during any time interval of continuous transmission.

8.2. Test setup

1. Set analyzer center frequency to DTS channel center frequency.
2. Set the span to 1.5 times the DTS bandwidth.
3. Set the RBW to: $3 \text{ kHz} \leq \text{RBW} \leq 100 \text{ kHz}$.
4. Set the VBW $\geq 3 \text{ RBW}$
5. Detector = peak.
6. Sweep time = auto couple.
7. Trace mode = max hold.
8. Allow trace to fully stabilize.
9. Use the peak marker function to determine the maximum amplitude level within the RBW.
10. If measured value exceeds limit, reduce RBW (no less than 3 kHz) and repeat.

8.3. Test result

Channel Frequency (MHz)	Power density (dBm/3kHz)	Limit (dBm/3kHz)	Result
2402	-13.65	8	Pass
2440	-12.47	8	Pass
2480	-11.44	8	Pass

TX CH00

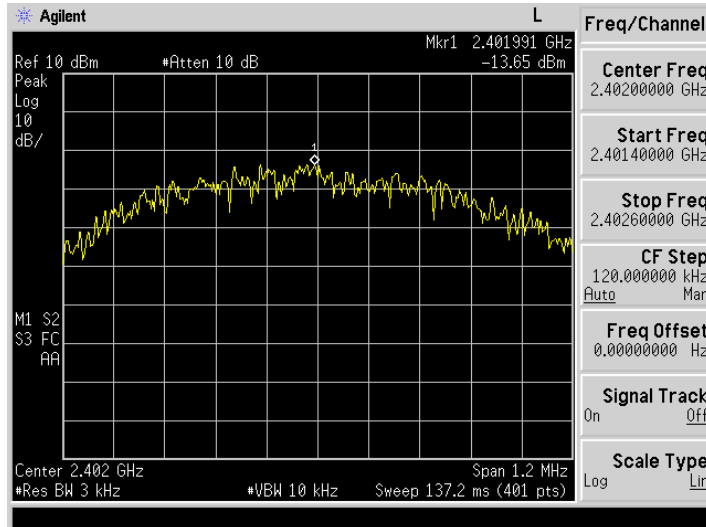

TX CH 19

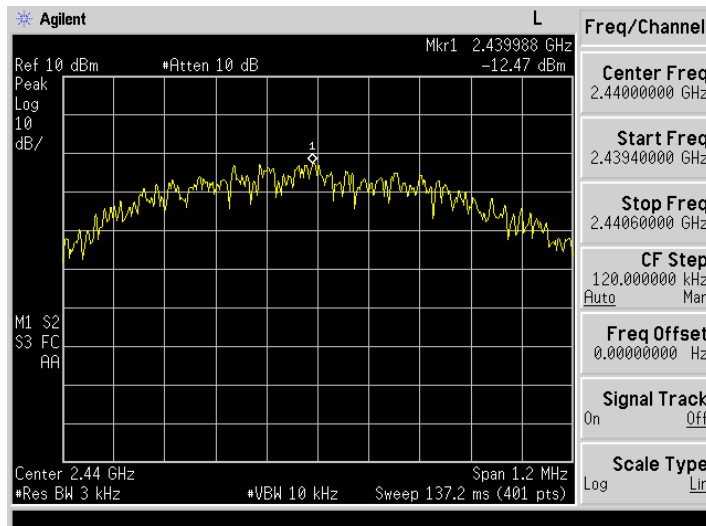

TX CH39

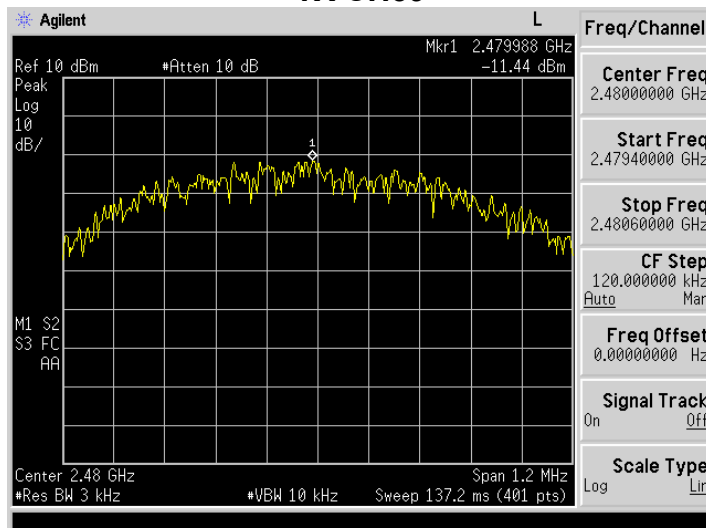

9. ANTENNA REQUIREMENTS

9.1. Limits

For intentional device, according to FCC 47 CFR Section 15.203, an intentional radiator shall be designed to ensure that no antenna other than that furnished by the responsible party shall be used with the device. And according to FCC 47 CFR Section 15.247 (b), if transmitting antennas of directional gain greater than 6dBi are used, the power shall be reduced by the amount in dB that the directional gain of the antenna exceeds 6dBi.

9.2. Result

The antennas used for this product are permanent attached antenna and that no antenna other than that furnished by the responsible party shall be used with the device, the maximum peak gain of the transmit antenna is only 0.72dBi.

10.PHOTOGRAPHS OF TEST SET-UP

Conducted Emission



Radiated Emission Test



11. PHOTOGRAPHS OF THE EUT









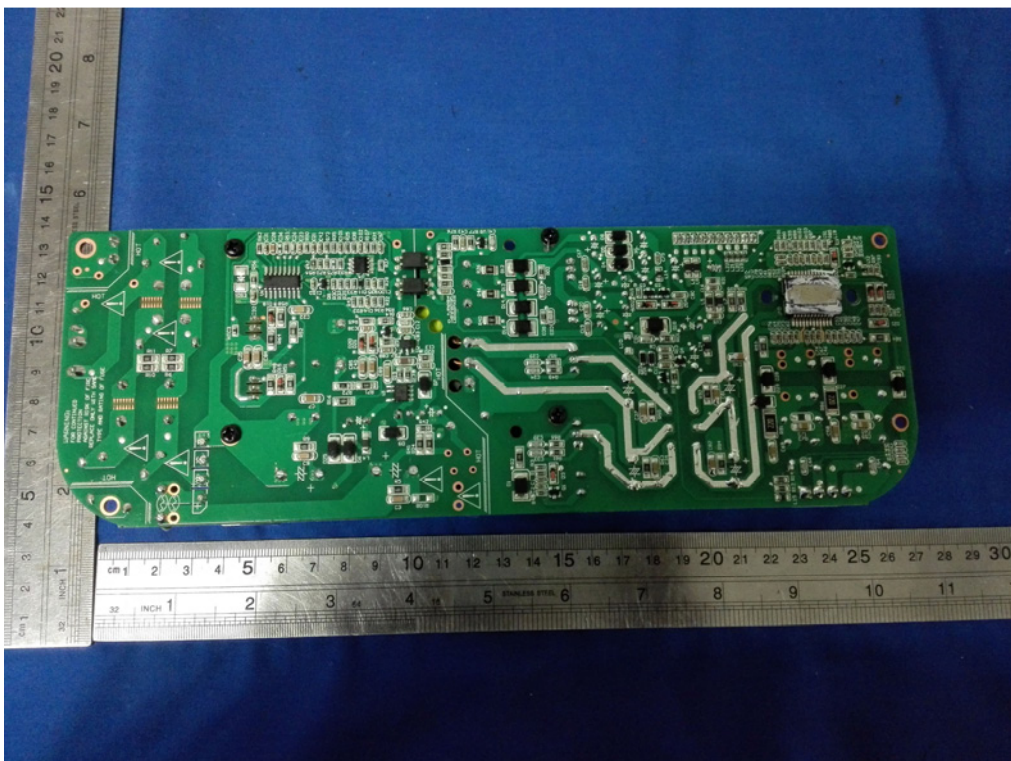
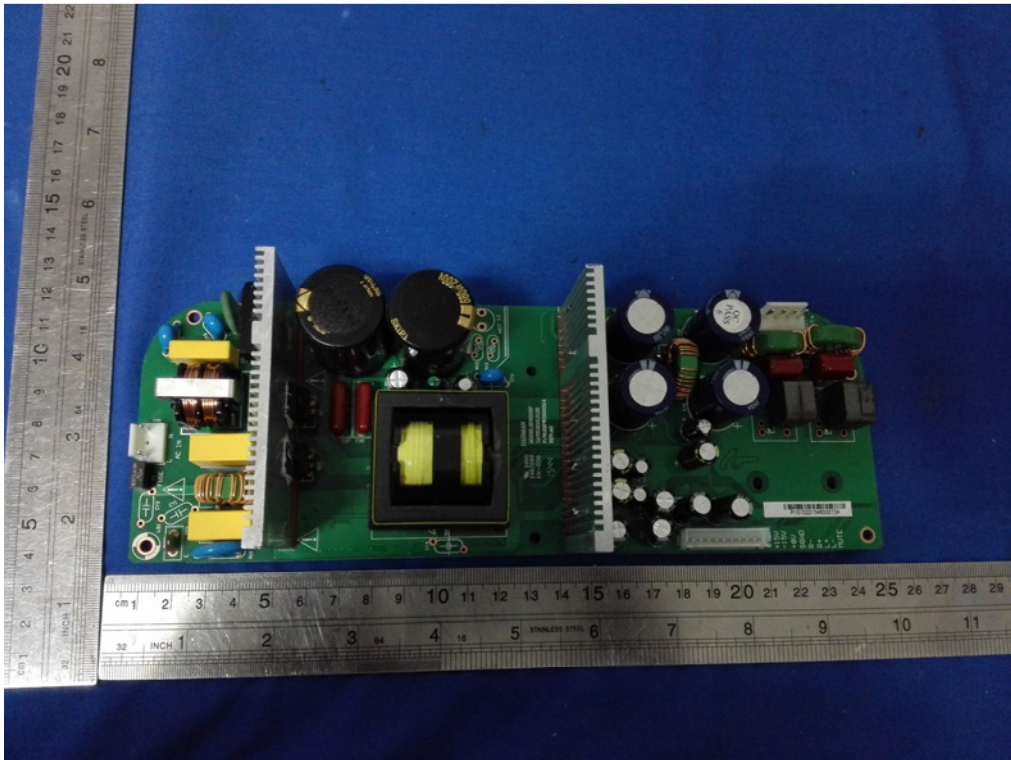

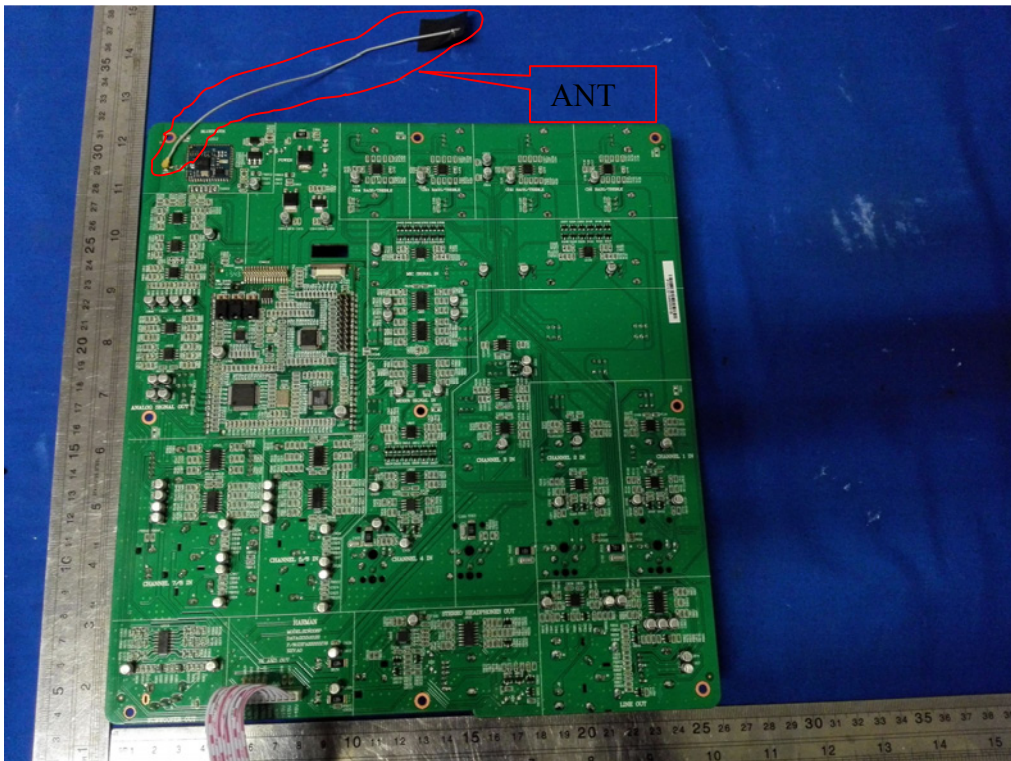

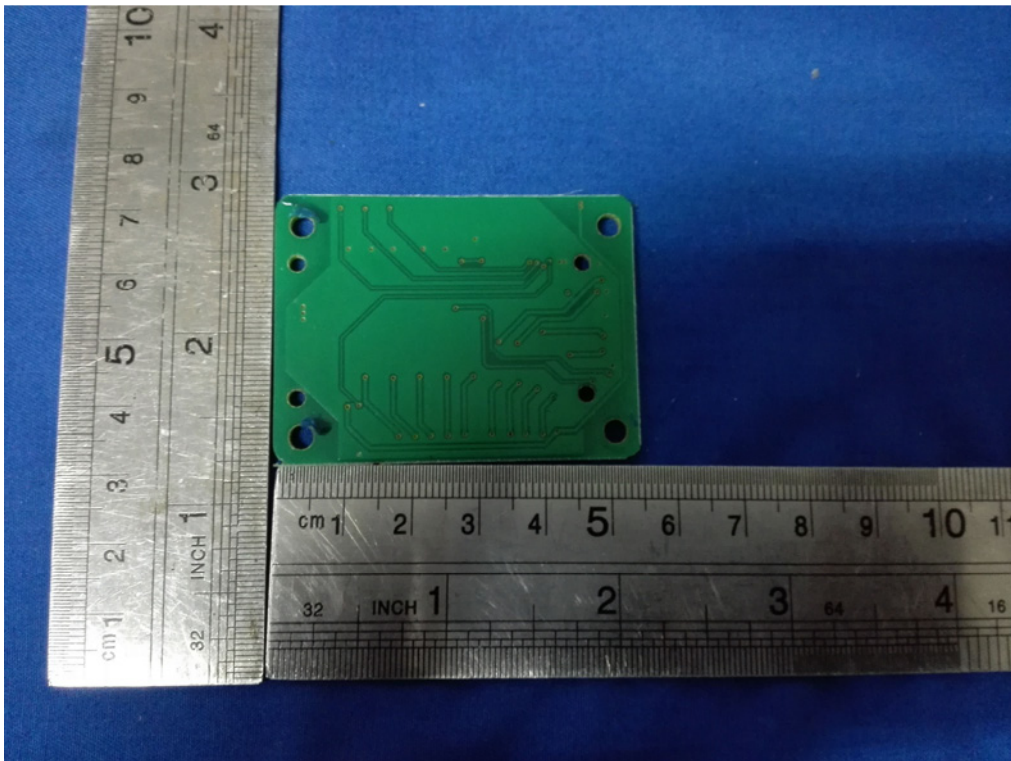
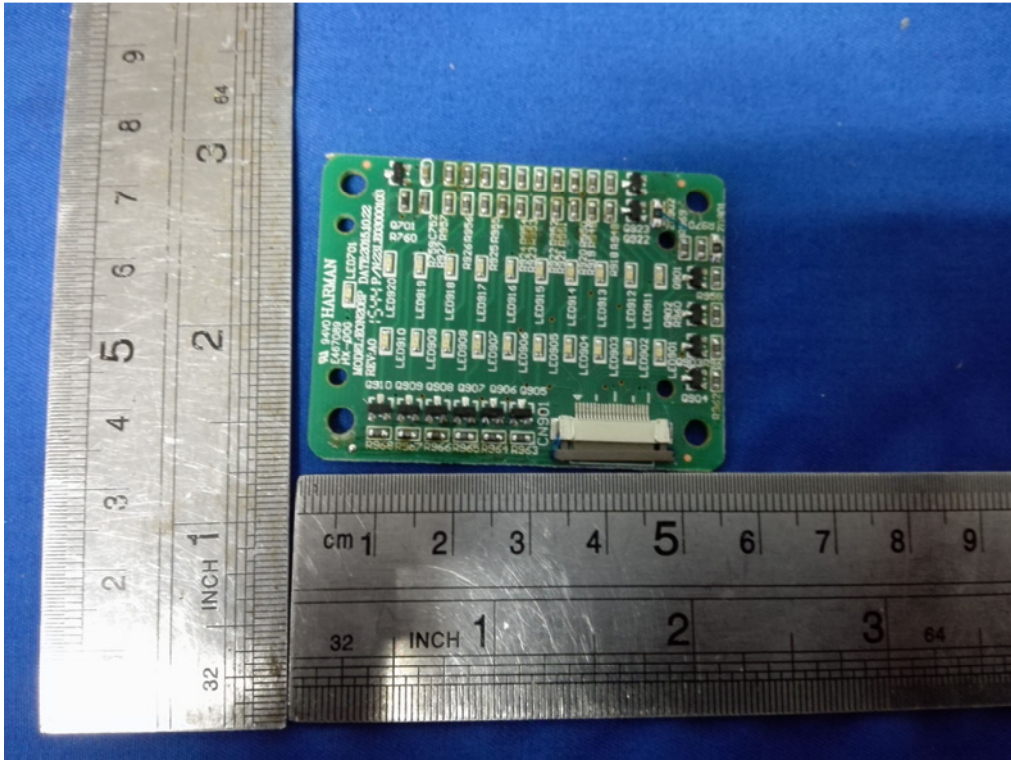

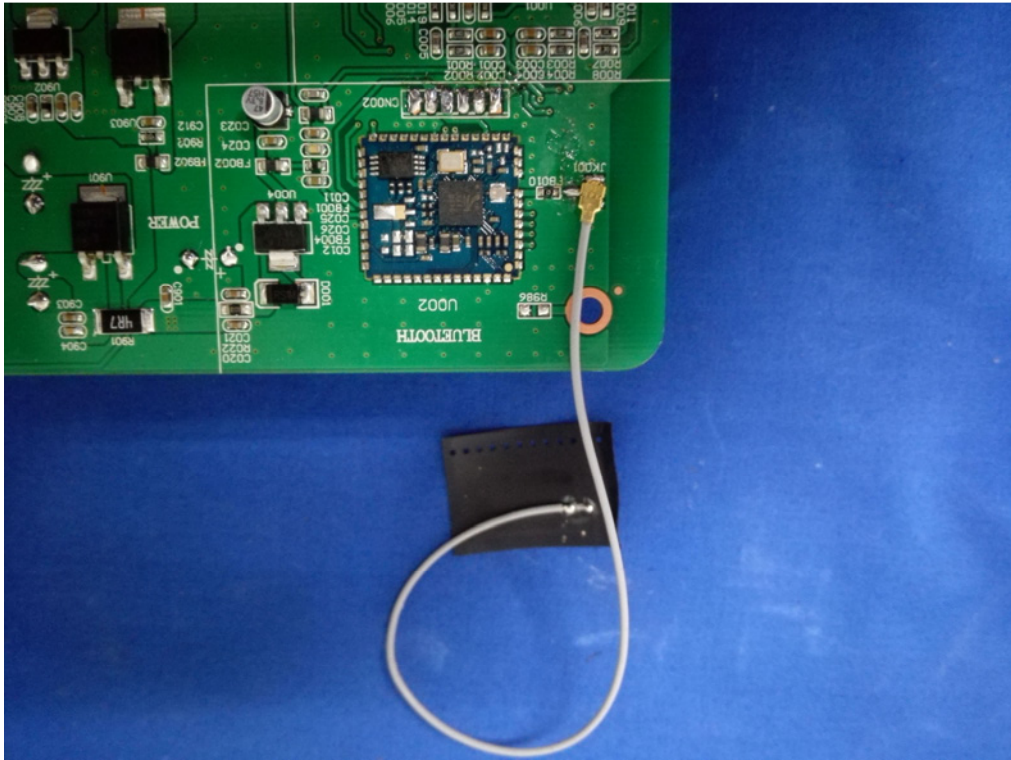

-----END-----