

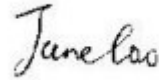
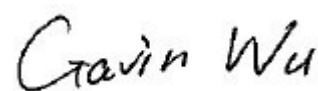

TEST REPORT

Report No.:	EM201200311-7	Application No.:	ZJ00016980
Client:	Harman International Industries, Incorporated		
Address:	8500 Balboa Blvd, Northridge, CA 91329, UNITED STATES		
Sample Description:	Blu-RAY DISC SYSTEM		
Model:	BDS 277		
Adding Model :			
Test Location:	Guangzhou GRG Metrology and Test Co., Ltd.		
Test Specification:	FCC Part 15,Subpart C:2010		
Test Date:	2012-06-21 to 2012-07-11		
Issue Date:	2012-07-12		
Test Result:	<i>Pass.</i>		
Prepared By:	Reviewed By:	Approved By:	
Eddy Zong/ Test Engineer	Jane Cao / Technical Support	Gavin Wu / Manager	
			
Date:2012-07-12	Date:2012-07-12	Date:2012-07-12	
Other Aspects:			
/			
Abbreviations: ok / P = passed; fail / F = failed; n.a. / N = not applicable			
The test result in this test report refers exclusively to the presented test sample. This report shall not be reproduced except in full, without the written approval of GRGT.			

DIRECTIONS OF TEST

1. This station carries out test task according to the national regulation of verifications which can be traced to National Primary Standards and BIPM.
2. The test report merely corresponds to the test sample. It is not permitted to copy extracts of these test result without the written permission of the test laboratory.
3. If there is any objection concerning the test, the client should inform the laboratory within 15 days from the date of receiving the test report.

Table of Contents

- 1. TEST RESULT SUMMARY 5**
- 2. GENERAL DESCRIPTION OF EUT..... 6**
 - 2.1 APPLICANT 6
 - 2.2 MANUFACTURER 6
 - 2.3 BASIC DESCRIPTION OF EQUIPMENT UNDER TEST 6
 - 2.4 DESCRIPTION OF SUPPORT UNITS 6
- 3. LABORATORY AND ACCREDITATIONS..... 7**
 - 3.1 LABORATORY..... 7
 - 3.2 ACCREDITATIONS 7
 - 3.3 MEASUREMENT UNCERTAINTY..... 7
 - 3.4 LIST OF USED TEST EQUIPMENT AT GRGT..... 8
- 4. TEST RESULTS 9**
 - 4.1 E.U.T. TEST CONDITIONS 9
 - 4.2 ANTENNA REQUIREMENT 11
 - 4.3 OCCUPIED BANDWIDTH..... 12
 - 4.3.1 LIMITS..... 12
 - 4.3.2 TEST PROCEDURES..... 12
 - 4.3.3 TEST SETUP 12
 - 4.3.4 TEST RESULTS..... 12
 - 4.4 CARRIER FREQUENCIES SEPARATED 16
 - 4.4.1 LIMITS..... 16
 - 4.4.2 TEST PROCEDURES..... 16
 - 4.4.3 TEST SETUP 16
 - 4.4.4 TEST RESULTS..... 16
 - 4.5 HOPPING CHANNEL NUMBER 20
 - 4.5.1 LIMITS..... 20
 - 4.5.2 TEST PROCEDURES..... 20
 - 4.5.3 TEST SETUP 20
 - 4.5.4 TEST RESULTS..... 20
 - 4.6 DWELL TIME..... 21
 - 4.6.1 LIMITS..... 21
 - 4.6.2 TEST PROCEDURES..... 21
 - 4.6.3 TEST SETUP 21
 - 4.6.4 TEST RESULTS..... 21
 - 4.7 CONDUCTED EMISSION MEASUREMENT 36
 - 4.7.1 LIMITS..... 36
 - 4.7.2 TEST PROCEDURES..... 36
 - 4.7.3 TEST SETUP 37
 - 4.7.4 TEST RESULTS..... 38
 - 4.8 MAXIMUM PEAK OUTPUT POWER 40
 - 4.8.1 LIMITS..... 40
 - 4.8.2 TEST PROCEDURES..... 40
 - 4.8.3 TEST SETUP 40
 - 4.8.4 TEST RESULTS..... 40
 - 4.9 CONDUCTED SPURIOUS EMISSIONS..... 45
 - 4.9.1 LIMITS..... 45
 - 4.9.2 TEST PROCEDURES..... 45
 - 4.9.3 TEST SETUP 45
 - 4.9.4 TEST RESULTS..... 45
 - 4.10 RADIATED SPURIOUS EMISSIONS..... 55
 - 4.10.1 LIMITS..... 55
 - 4.10.2 TEST PROCEDURES..... 55
 - 4.10.3 TEST SETUP 56
 - 4.10.4 TEST RESULTS..... 58
 - 4.11 BAND EDGES REQUIREMENT 62
 - 4.11.1 LIMITS..... 62

4.11.2 TEST PROCEDURES..... 62
4.11.3 TEST SETUP 62
4.11.4 TEST RESULTS..... 63

1. TEST RESULT SUMMARY

Section B of FCC Part 15.247:2009			
Standard	Item	Limit / Severity	Result
FCC Part 15,Subpart C (15.247)	Antenna Requirement	Section 15.247 (c)	PASS
	Occupied Bandwidth	Section 15.247 (a1)	PASS
	Carrier Frequencies Separated	Section 15.247(a)(1)	PASS
	Hopping Channel Number	Section 15.247(a)(1)(iii)	PASS
	Dwell Time	Section 15.247(a)(1)(iii)	PASS
	Maximum Peak Output Power	Section 15.247(b)(1)	PASS
	Conducted Emission	Section 15.207	PASS
	Conducted Spurious Emission (30MHz to 25GHz)	Section 15.209 &15.247(d)	PASS
	Radiated Spurious Emission (30MHz to 25GHz)	Section 15.209 &15.247(d)	PASS
	Band Edges Measurement	Section 15.247 (d) &15.205	PASS

2. GENERAL DESCRIPTION OF EUT

2.1 APPLICANT

Name: Harman International Industries, Incorporated
Address: 8500 Balboa Blvd, Northridge, CA 91329, UNITED STATES

2.2 MANUFACTURER

Name: TCL TECHNOLOGY ELECTRONICS (HUIZHOU) CO., LTD
Address: Section 19, Zhongkai High-tech Development Zone, Huizhou City, Guang Dong Province, China.

2.3 BASIC DESCRIPTION OF EQUIPMENT UNDER TEST

Equipment: Blu-RAY DISC SYSTEM
Model No.: BDS 277
Trade Name: harman/kardon
Power supply: 100-240V~ 50/60Hz
Frequency Range 2402MHz~2480MHz
Type of Modulation GFSK, 8DPSK, Pi/4 QPSK
Channels: Channels with 1MHz step
Duty cycle 100%
Antenna Type Integral

2.4 DESCRIPTION OF SUPPORT UNITS

Name of Equipment	Manufacturer	Model	Serial Number
iphone	APPLE	A1303	/
ipad	APPLE	Ipad 2	/
PC	Lenovo	E40	0578DTC

3. LABORATORY AND ACCREDITATIONS

3.1 LABORATORY

The tests and measurements refer to this report were performed by Guangzhou GRG Metrology and Test CO., LTD.

Add. : 163 Pingyun Rd, West of Huangpu Ave, Guangzhou, 510656, P. R. China

Telephone: +86-20-38699959, 38699960, 38699961

Fax : +86-20-38695185

3.2 ACCREDITATIONS

Our laboratories are accredited and approved by the following approval agencies according to ISO/IEC 17025.

USA	FCC Listed Lab (No. 688188)
China	CNAS (No.L0446)
China	DILAC (No.DL175)
Canada	Registration No.:8355A-1

3.3 MEASUREMENT UNCERTAINTY

Where relevant, the following measurement uncertainty levels have been estimated for tests performed on the EUT as specified in CISPR 16-4-2:

Measurement		Frequency	Uncertainty
Radiated Emission	Horizontal	30MHz ~ 1000MHz	4.2dB
		1GHz ~ 26.5GHz	4.2dB
	Vertical	30MHz ~ 1000MHz	4.4dB
		1GHz ~ 26.5GHz	4.4dB
Conducted Emission		9kHz ~ 30MHz	3.1 dB

This uncertainty represents an expanded uncertainty factor of $k=2$.

3.4 LIST OF USED TEST EQUIPMENT AT GRGT

Name of Equipment	Manufacturer	Model	Serial Number	Calibration Due
Conducted Emissions				
EMI Receiver	R&S	ESU40	100529	2013-02-04
L.I.S.N	SCHWARZBECK	NSLK 8127	8127450	2012-08-21
Spurious Emissions at Antenna Port				
Receiver	R&S	ESU40	100106	2013-02-04
Restricted Bands				
Receiver	R&S	ESU40	100106	2013-02-04
Spurious Emissions				
Receiver	R&S	ESU40	100106	2013-02-04
Signal Generator	R&S	SML03	103002	2012-11-14
Biconical Log-periodic Antenna	ETS.LINDGREN	3142C	00075971	2014-05-26
Horn antenna	SCHWARZBECK	BBHA9120D	D752	2013-10-14
6 dB Bandwidth				
Receiver	R&S	ESU40	100106	2013-02-04
Maximum Peak Output Power				
Receiver	R&S	ESU40	100106	2013-02-04
100kHz Bandwidth of Frequency Band Edge				
Receiver	R&S	ESU40	100106	2013-02-04
Power Spectral Density				
Receiver	R&S	ESU40	100106	2013-02-04

NOTE: The calibration interval of the above test instruments is 12 months.

4. TEST RESULTS

4.1 E.U.T. TEST CONDITIONS

Type of antenna: Integral

Temperature: 21.0 °C

Humidity: 51 % RH

Atmospheric Pressure: 1011 mbar

Test frequencies: According to the 15.31(m) Measurements on intentional radiators or receivers, other than TV broadcast receivers, shall be performed and, if required, reported for each band in which the device can be operated with the device operating at the number of frequencies in each band specified in the following table:

Frequency range over which device operates	Number of frequencies	Location in the range of operation
1 MHz or less	1	Middle
1 to 10 MHz	2	1 near top and 1 near bottom
More than 10 MHz	3	1 near top, 1 near middle and 1 near bottom

EUT channels and frequencies list:

Channel	Frequency (MHz)	Channel	Frequency (MHz)	Channel	Frequency (MHz)
0	2402	14	2416	28	2430
1	2403	15	2417	29	2431
2	2404	16	2418	30	2432
3	2405	17	2419	31	2433
4	2406	18	2420	32	2434
5	2407	19	2421	33	2435
6	2408	20	2422	34	2436
7	2409	21	2423	35	2437
8	2410	22	2424	36	2438
9	2411	23	2425	37	2439
10	2412	24	2426	38	2440
11	2413	25	2427	39	2441
12	2414	26	2428	40	2442
13	2415	27	2429	41	2443

Channel	Frequency (MHz)	Channel	Frequency (MHz)	Channel	Frequency (MHz)
42	2444	55	2457	68	2470
43	2445	56	2458	69	2471
44	2446	57	2459	70	2472
45	2447	58	2460	71	2473
46	2448	59	2461	72	2474
47	2449	60	2462	73	2475
48	2450	61	2463	74	2476
49	2451	62	2464	75	2477
50	2452	63	2465	76	2478
51	2453	64	2466	77	2479
52	2454	65	2467	78	2480
53	2455	66	2468		
54	2456	67	2469		

Test frequency is the lowest channel: 0 channel(2402MHz), middle channel: 39 channel(2441MHz) and highest channel: 78 channel(2480MHz)

4.2 ANTENNA REQUIREMENT

The EUT antenna is PCB Printed antenna. Antenna gain is 0dBi .which accordance 15.203.is considered sufficient to comply with the provisions of this section

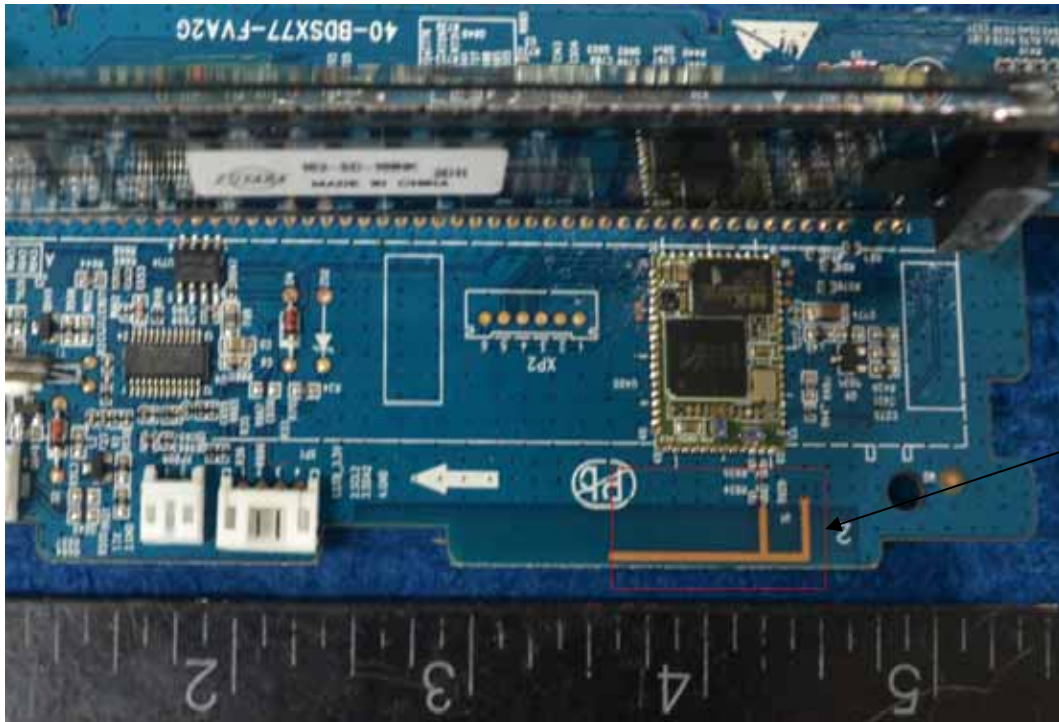

Antenna

4.3 OCCUPIED BANDWIDTH

4.3.1 LIMITS

Frequency hopping systems operating in the 2400-2483.5 MHz band may have hopping channel carrier frequencies that are separated by 25 kHz or two-thirds of the 20 dB bandwidth of the hopping channel, whichever is greater, provided the systems operate with an output power no greater than 125 mW.

4.3.2 TEST PROCEDURES

Test procedures follow ANSI C63.4

1. Remove the antenna from the EUT and then connect a low RF cable from the antenna port to the spectrum;
2. Set the spectrum analyzer: Span = approximately 2 to 3 times the 20dB bandwidth, centered on a hopping channel;
3. Set the spectrum analyzer: RBW \geq 1% of the 20dB bandwidth (set 10kHz). VBW \geq RBW. Sweep = auto; Detector Function = Peak. Trace = Max Hold.
4. Mark the peak frequency and -20dB points or 99% bandwidth.
5. bandwidth value is OBW value.

Remark:

Pre-test the 3 modulation to find GFSK and 8DPSK is worse case, so only record GFSK and 8DPSK test data.

4.3.3 TEST SETUP

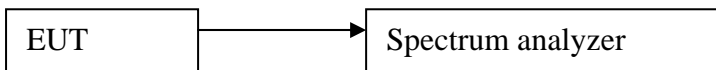

4.3.4 TEST RESULTS

For GFSK

Frequency (GHz)	Test Channel	bandwidth
2.402	Lowest	1.150MHz
2.441	Middle	1.130MHz
2.480	Highest	1.130MHz

For 8DPSK

Frequency (GHz)	Test Channel	bandwidth
2.402	Lowest	1.320MHz
2.441	Middle	1.340MHz
2.480	Highest	1.330MHz

Result plot as follows:

GFSK Lowest Channel :

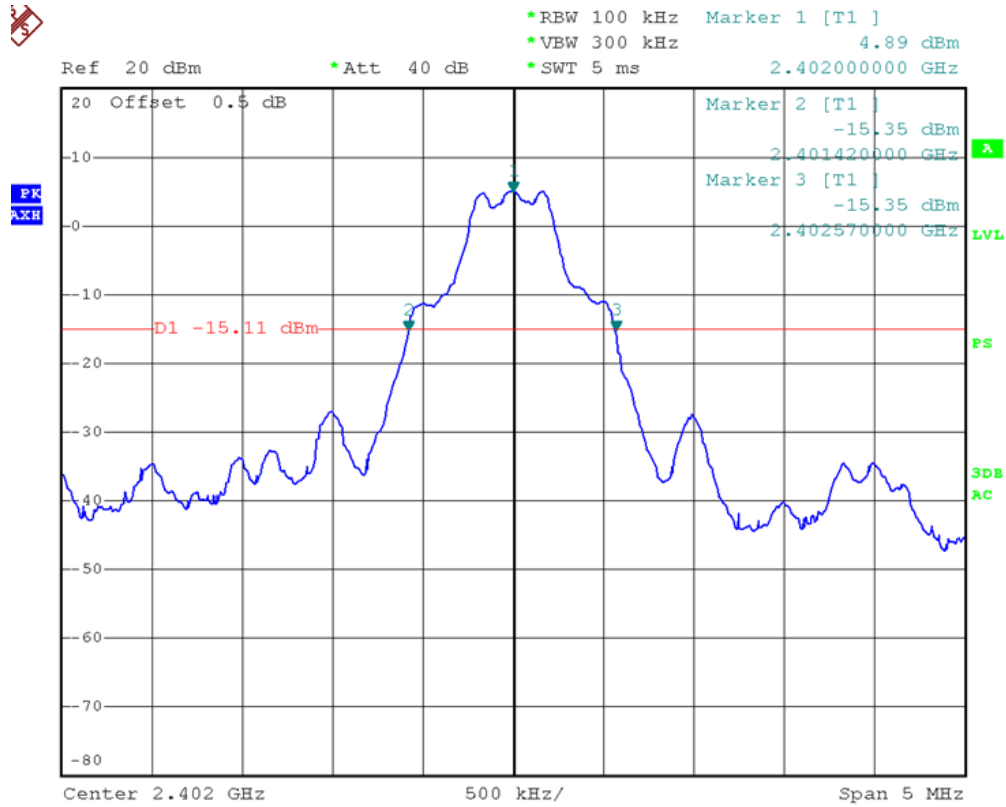

GFSK Middle Channel :

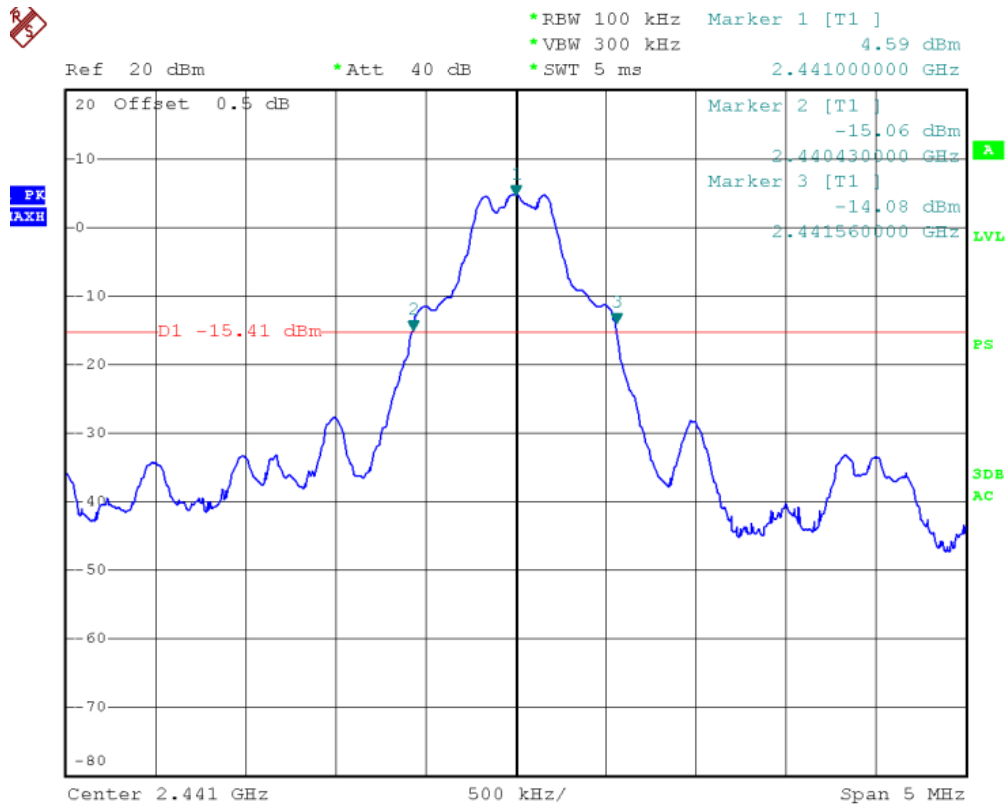

GFSK Highest Channel :

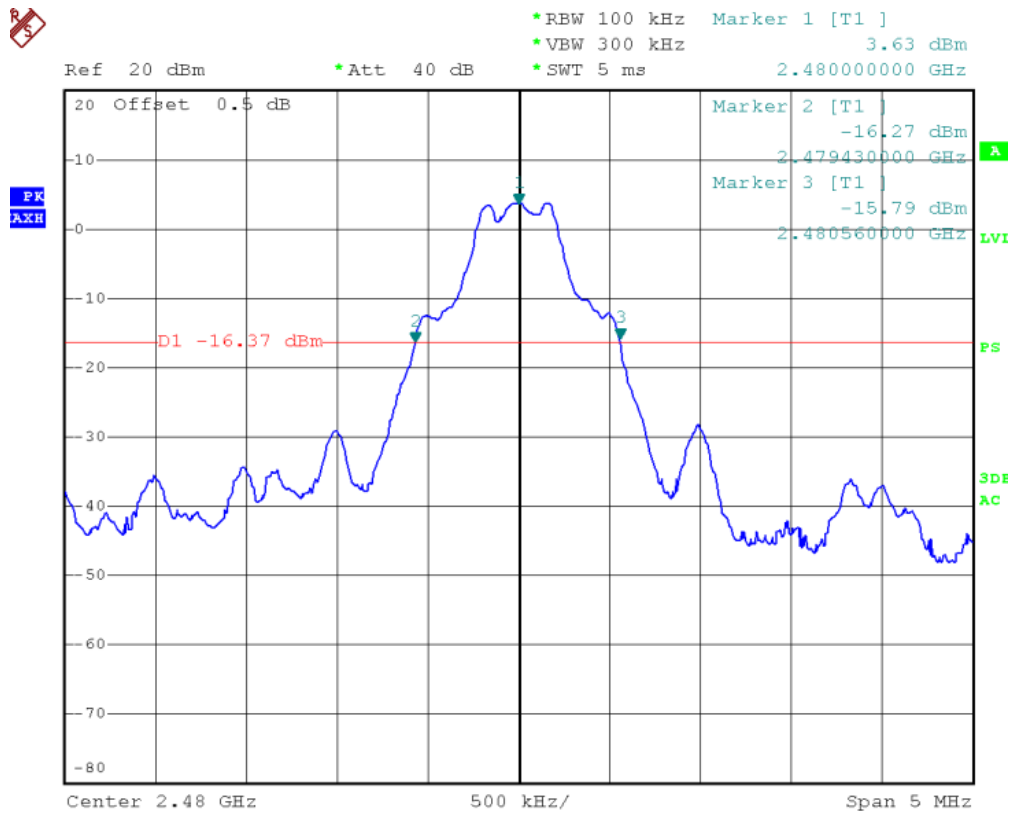

8DPSK Lowest Channel :

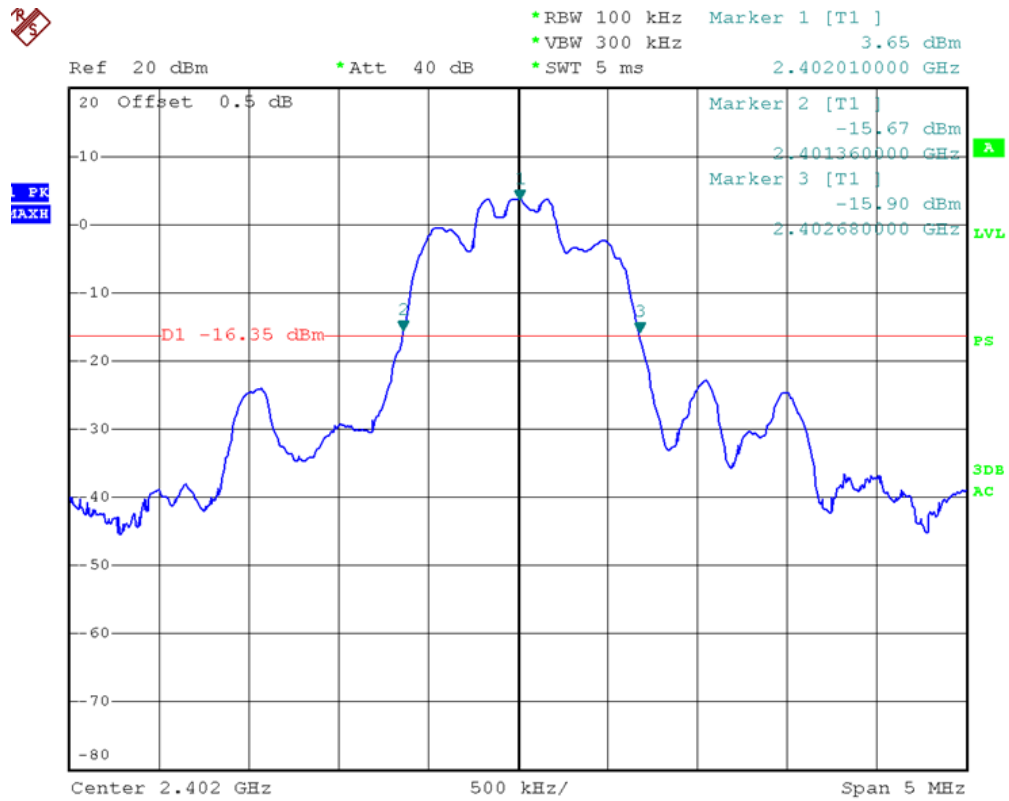

8DPSK Middle Channel :

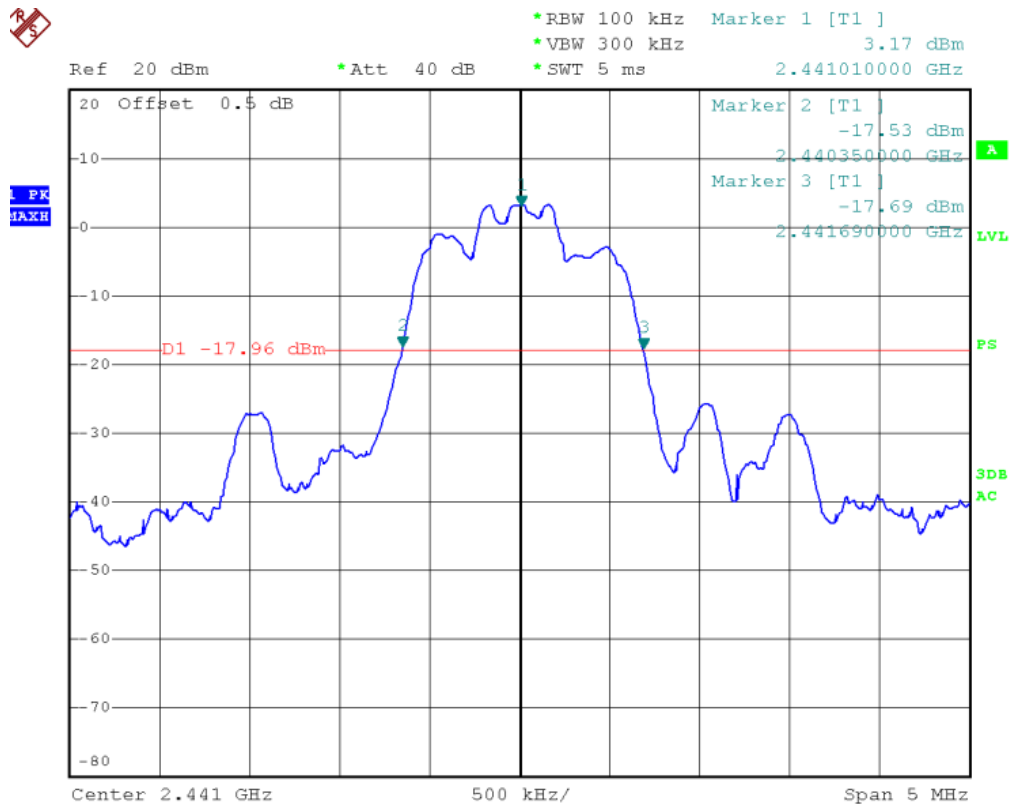

8DPSK Highest Channel :

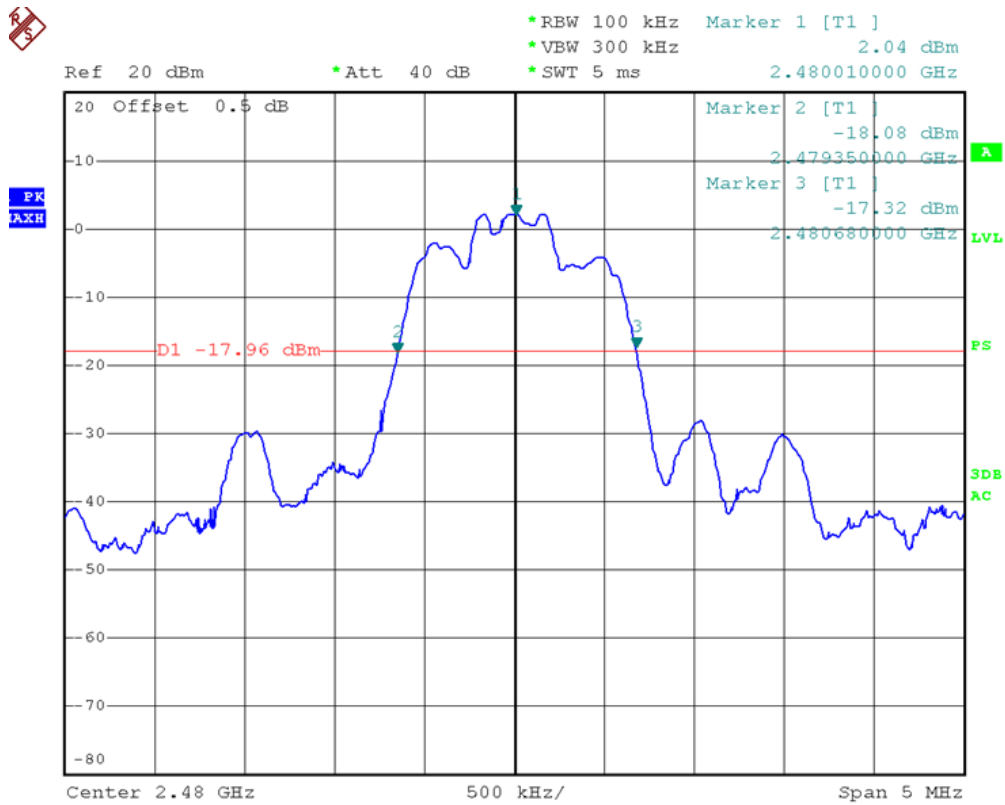

4.4 CARRIER FREQUENCIES SEPARATED

4.4.1 LIMITS

Frequency hopping systems operating in the 2400-2483.5 MHz band may have hopping channel carrier frequencies that are separated by 25 kHz or two-thirds of the 20 dB bandwidth of the hopping channel, whichever is greater, provided the systems operate with an output power no greater than 125 mW.

4.4.2 TEST PROCEDURES

Test procedures follow ANSI C63.4

1. Remove the antenna from the EUT and then connect a low RF cable from the antenna port to the spectrum.
2. Set the spectrum analyzer: RBW >= 1% of the span (set 100 kHz). VBW >= RBW , Span = 6MHz. Sweep = auto; Detector Function = Peak. Trace = Max,hold.
3. Allow the trace to stabilize. Use the marker-delta function to determine the separation between the peaks of the adjacent channels. The limit is specified in one of the subparagraphs of this Section. Submit this plot.

Remark :

Pre-test the 3 modulation to find GFSK and 8DPSK is worse case, so only record GFSK and 8DPSK test data.

4.4.3 TEST SETUP

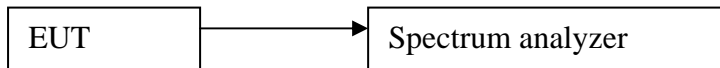

4.4.4 TEST RESULTS

Mode	Test Channel	Carrier Frequencies Separated	PASS/FAIL
GFSK	Lower Channels (channel 0 and channel 1)	1.014MHz	Pass
	Middle Channels (channel 39 and channel 40)	1.014MHz	Pass
	Upper Channels (channel 77 and channel 78)	1.050MHz	Pass
8DPSK	Lower Channels (channel 0 and channel 1)	1.008MHz	Pass
	Middle Channels (channel 39 and channel 40)	1.008MHz	Pass
	Upper Channels (channel 77 and channel 78)	1.032MHz	Pass

For GFSK

Lowest Channels:

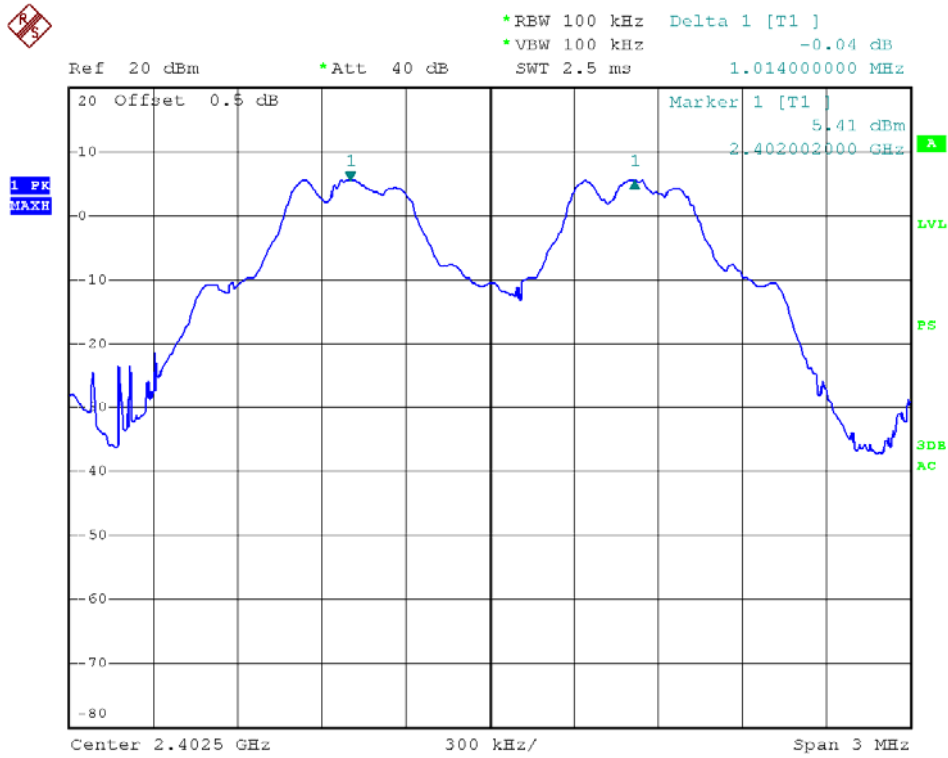

Middle Channels:

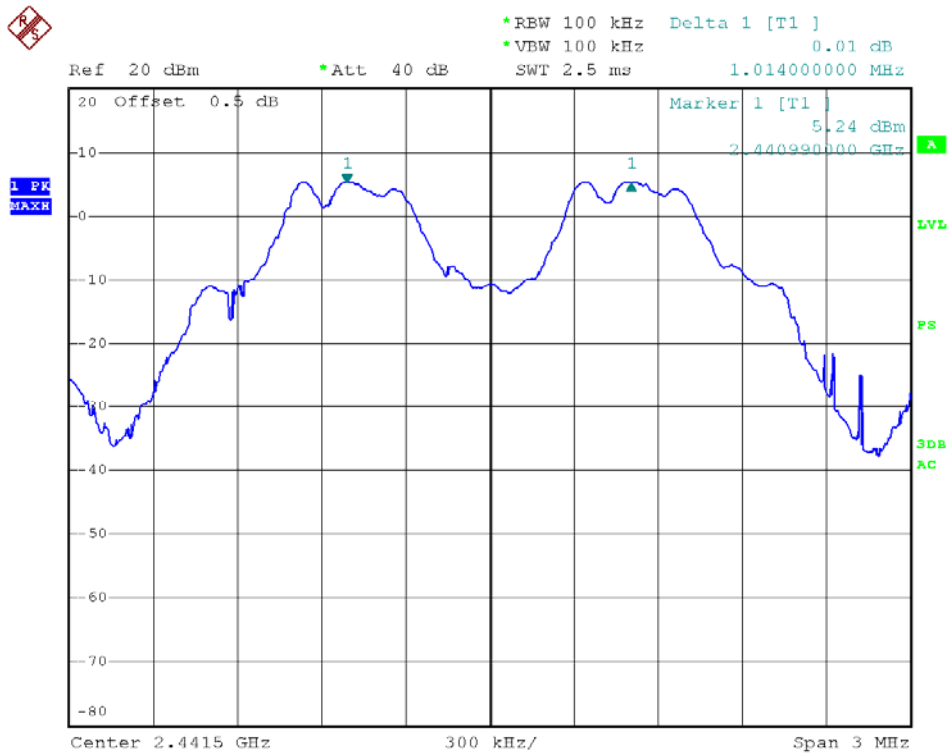

Highest Channels:

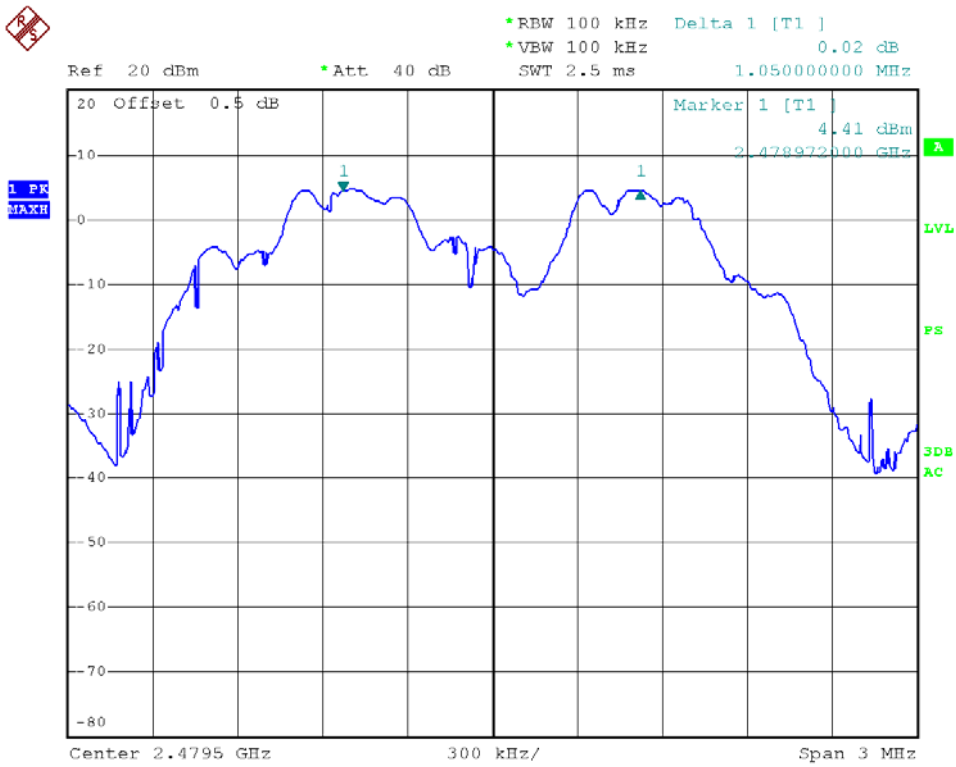

For 8DPSK

Lowest Channels:

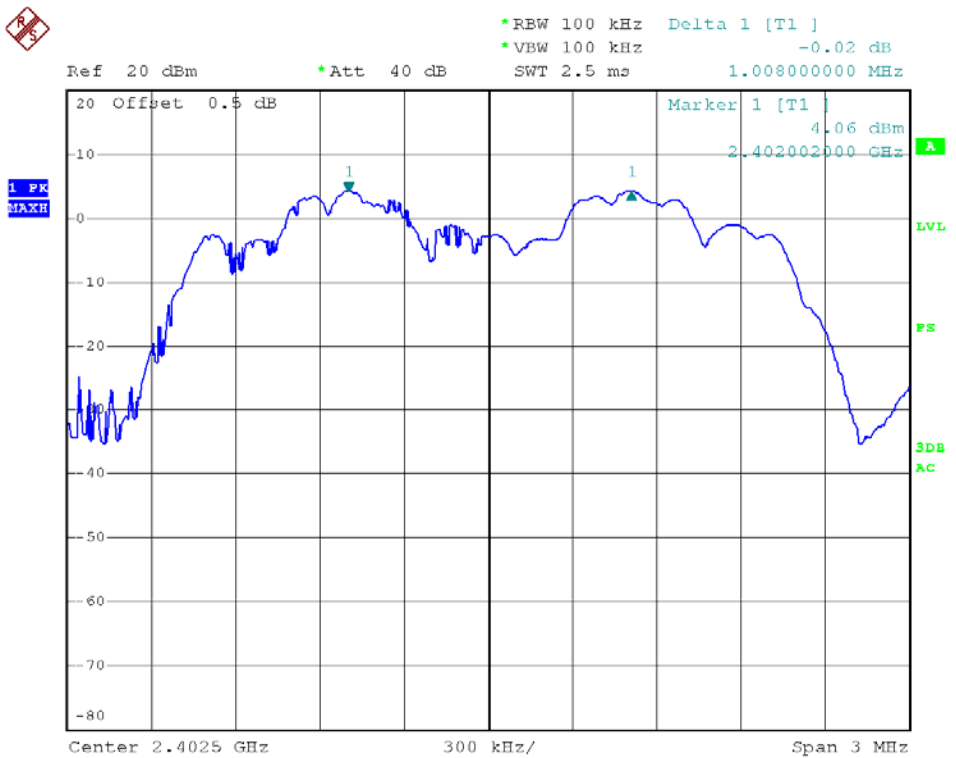

Middle Channels:

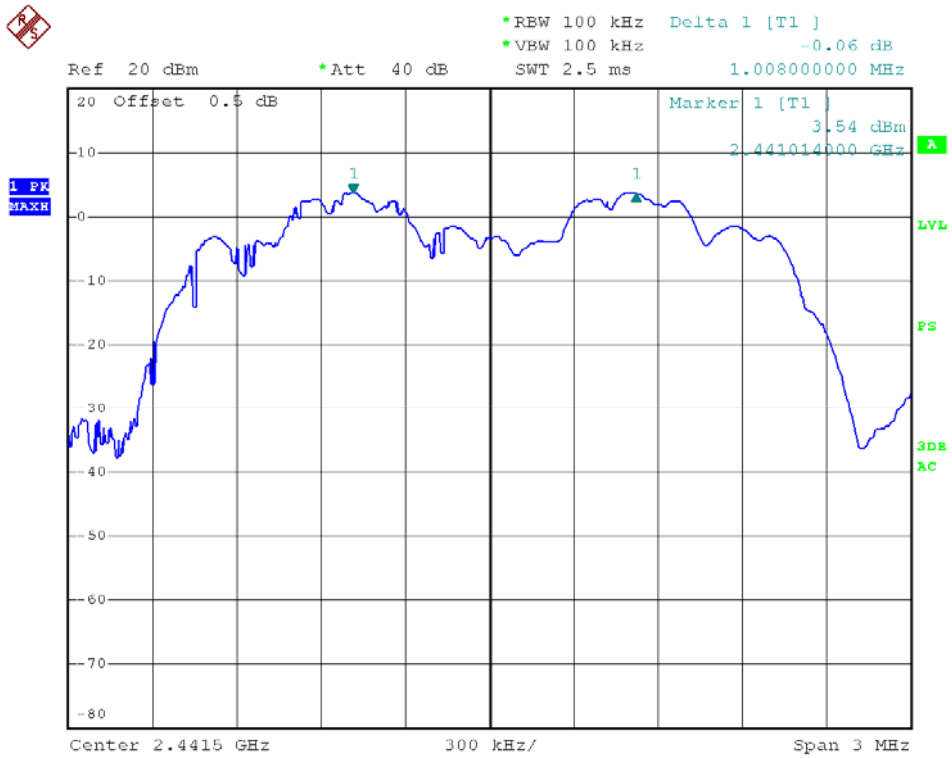

Highest Channels:



Test result: The unit does meet the FCC requirements.

4.5 HOPPING CHANNEL NUMBER

4.5.1 LIMITS

Regulation 15.247 (a) (1)(iii) Frequency hopping systems in the 2400-2483.5 MHz band shall use at least 15 channels.

4.5.2 TEST PROCEDURES

Test procedures follow ANSI C63.4

1. Remove the antenna from the EUT and then connect a low RF cable from the antenna port to the spectrum analyzer.
2. Set the spectrum analyzer: RBW = 100 kHz. VBW = 300 kHz. Sweep = auto; Detector Function = Peak. Trace = Max hold.
3. Allow the trace to stabilize. It may prove necessary to break the span up to sections. in order to clearly show all of the hopping frequencies. The limit is specified in one of the subparagraphs of this Section.
4. Set the spectrum analyzer: start frequency = 2400MHz. stop frequency = 2483.5MHz. Submit the test result graph.

4.5.3 TEST SETUP

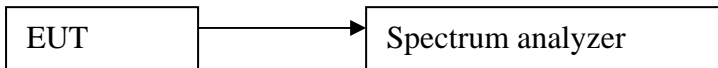

4.5.4 TEST RESULTS

Test result: Total channels are 79 channels.

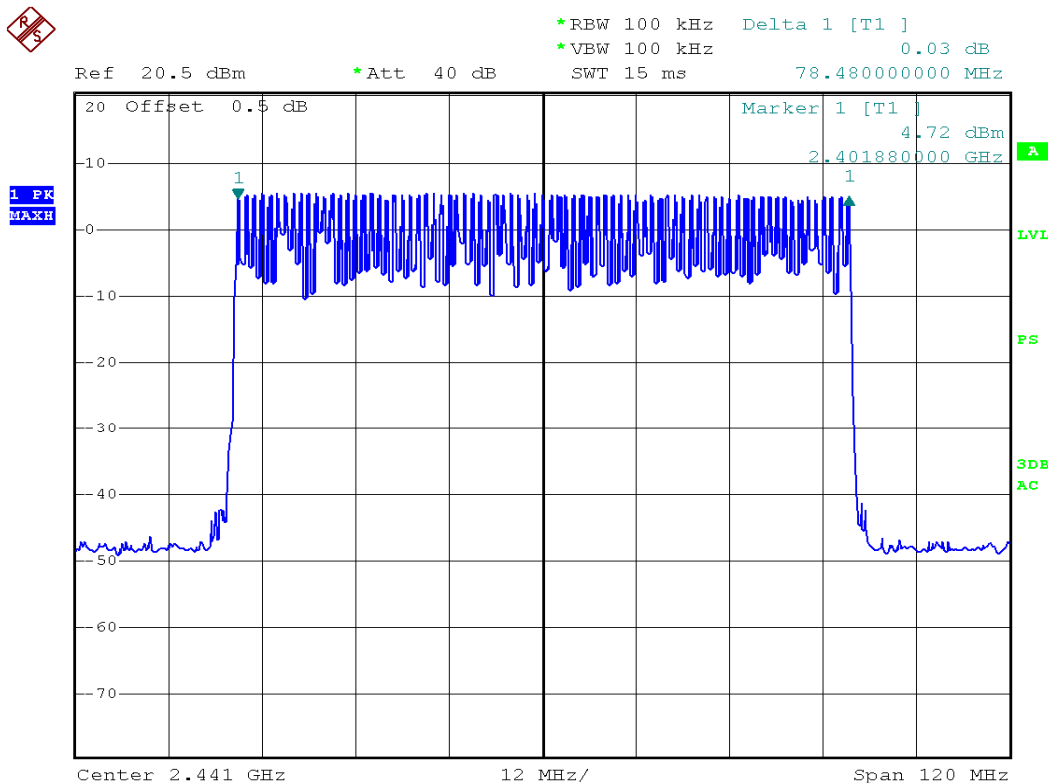

Test result: The unit does meet the FCC requirements.

4.6 DWELL TIME

4.6.1 LIMITS

Regulation 15.247(a)(1)(iii) Frequency hopping systems in the 2400-2483.5 MHz band shall use at least 15 channels. The average time of occupancy on any channel shall not be greater than 0.4 seconds within a period of 0.4 seconds multiplied by the number of hopping channels employed. Frequency hopping systems may avoid or suppress transmissions on a particular hopping frequency provided that a minimum of 15 channels are used.

4.6.2 TEST PROCEDURES

Test procedures follow ANSI C63.4

1. Remove the antenna from the EUT and then connect a low RF cable from the antenna port to the spectrum.
2. Set spectrum analyzer span = 0. centered on a hopping channel;
3. Set RBW = 1MHz and VBW = 3MHz. Sweep = as necessary to capture the entire dwell time per hopping channel. Detector Function = Peak. Trace = Max hold;
4. Use the marker-delta function to determine the dwell time. If this value varies with different modes of operation (e.g.. data rate. modulation format. etc.). repeat this test for each variation. The limit is specified in one of the subparagraphs of this Section. Submit this plot(s). An oscilloscope may be used instead of a spectrum analyzer.

4.6.3 TEST SETUP

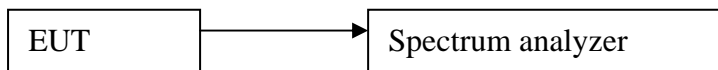

4.6.4 TEST RESULTS

The test period: $T = 0.4 \text{ Second/Channel} \times 79 \text{ Channel} = 31.6 \text{ s}$

1. Channel 0: 2.402GHz

DH1 time slot = $0.387 \text{ (ms)} \times (1600/(2*79)) \times 31.6 = 123.840 \text{ ms}$

DH3 time slot = $1.664 \text{ (ms)} \times (1600/(4*79)) \times 31.6 = 266.240 \text{ ms}$

DH5 time slot = $2.880 \text{ (ms)} \times (1600/(6*79)) \times 31.6 = 307.200 \text{ ms}$

2DH1 time slot = $0.403 \text{ (ms)} \times (1600/(2*79)) \times 31.6 = 128.960 \text{ ms}$

2DH3 time slot = $1.635 \text{ (ms)} \times (1600/(4*79)) \times 31.6 = 261.600 \text{ ms}$

2DH5 time slot = $2.688 \text{ (ms)} \times (1600/(6*79)) \times 31.6 = 286.720 \text{ ms}$

3DH1 time slot = $0.405 \text{ (ms)} \times (1600/(2*79)) \times 31.6 = 129.600 \text{ ms}$

3DH3 time slot = $1.647 \text{ (ms)} \times (1600/(4*79)) \times 31.6 = 263.520 \text{ ms}$

3DH5 time slot = $2.911 \text{ (ms)} \times (1600/(6*79)) \times 31.6 = 310.506 \text{ ms}$

2. Channel 39: 2.441GHz

DH1 time slot = $0.387 \text{ (ms)} \times (1600/(2*79)) \times 31.6 = 123.840 \text{ ms}$

DH3 time slot = $1.648 \text{ (ms)} \times (1600/(4*79)) \times 31.6 = 263.680 \text{ ms}$

DH5 time slot = $2.896 \text{ (ms)} \times (1600/(6*79)) \times 31.6 = 308.906 \text{ ms}$

2DH1 time slot = $0.396 \text{ (ms)} \times (1600/(2*79)) \times 31.6 = 126.720 \text{ ms}$

2DH3 time slot = $1.644 \text{ (ms)} \times (1600/(4*79)) \times 31.6 = 263.040 \text{ ms}$

2DH5 time slot = 1.708 (ms) * (1600/(6*79)) * 31.6 = 182.186ms

3DH1 time slot = 0.394(ms) * (1600/(2*79)) * 31.6 = 126.080ms

3DH3 time slot = 1.657(ms) * (1600/(4*79)) * 31.6 = 265.120ms

3DH5 time slot = 2.903 (ms) * (1600/(6*79)) * 31.6 = 309.653 ms

3. Channel 78: 2.480GHz

DH1 time slot = 0.397(ms) * (1600/(2*79)) * 31.6 = 127.040ms

DH3 time slot = 1.669 (ms) * (1600/(4*79)) * 31.6 = 271.840 ms

DH5 time slot = 2.886 (ms) * (1600/(6*79)) * 31.6 = 307.840 ms

2DH1 time slot = 0.396(ms) * (1600/(2*79)) * 31.6 = 126.72 0ms

2DH3 time slot = 1.644 (ms) * (1600/(4*79)) * 31.6 = 263.040ms

2DH5 time slot = 1.708 (ms) * (1600/(6*79)) * 31.6 = 182.186 ms

3DH1 time slot = 0.403(ms) * (1600/(2*79)) * 31.6 = 128.960 ms

3DH3 time slot = 1.651(ms) * (1600/(4*79)) * 31.6 = 264.160ms

3DH5 time slot = 2.915 (ms) * (1600/(6*79)) * 31.6 = 310.933 ms

The results are not greater than 0.4 seconds.

The unit does meet the requirements.

Please refer the graph as below:

1. Lowest channel (2.402 GHz):

DH1

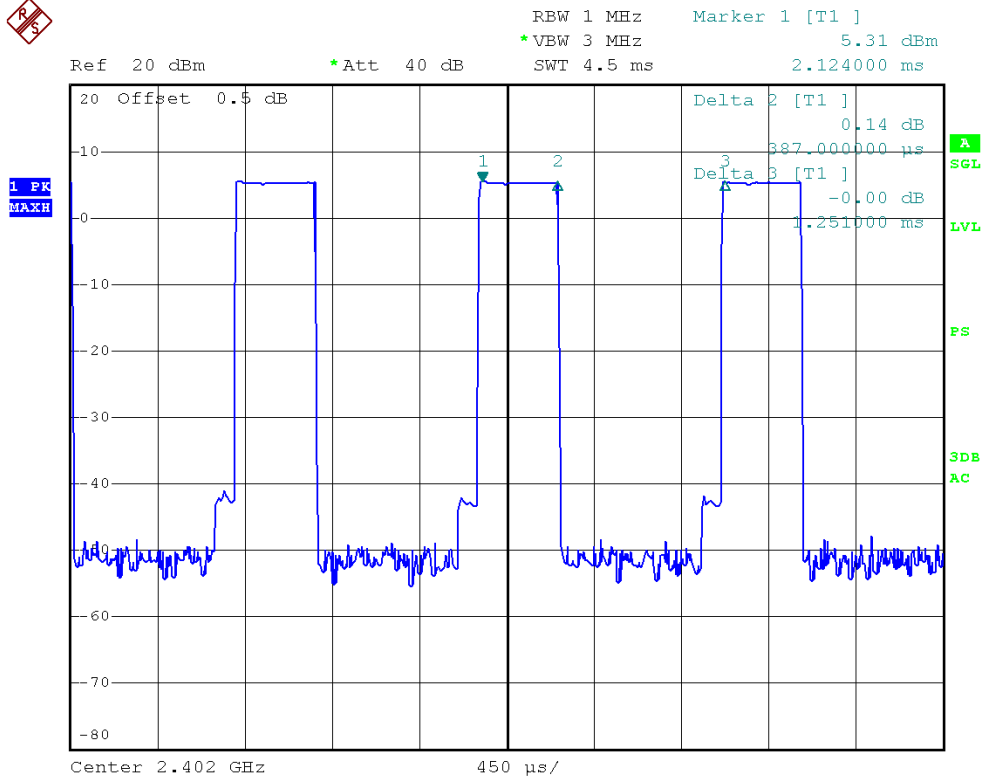

DH3:

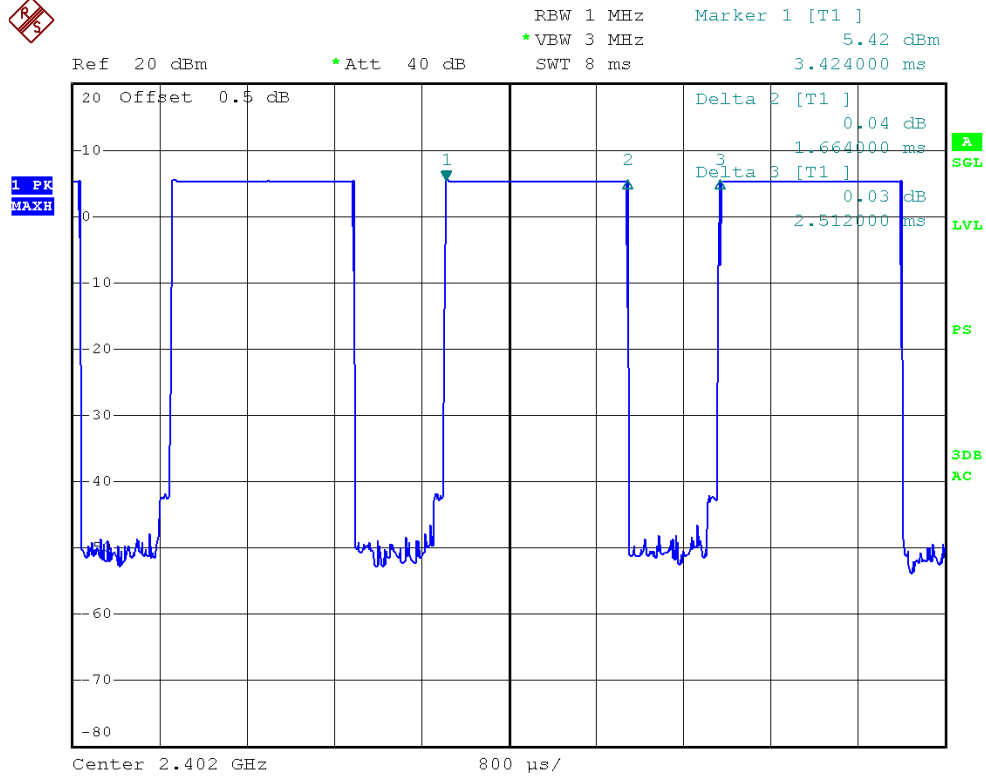

DH5:

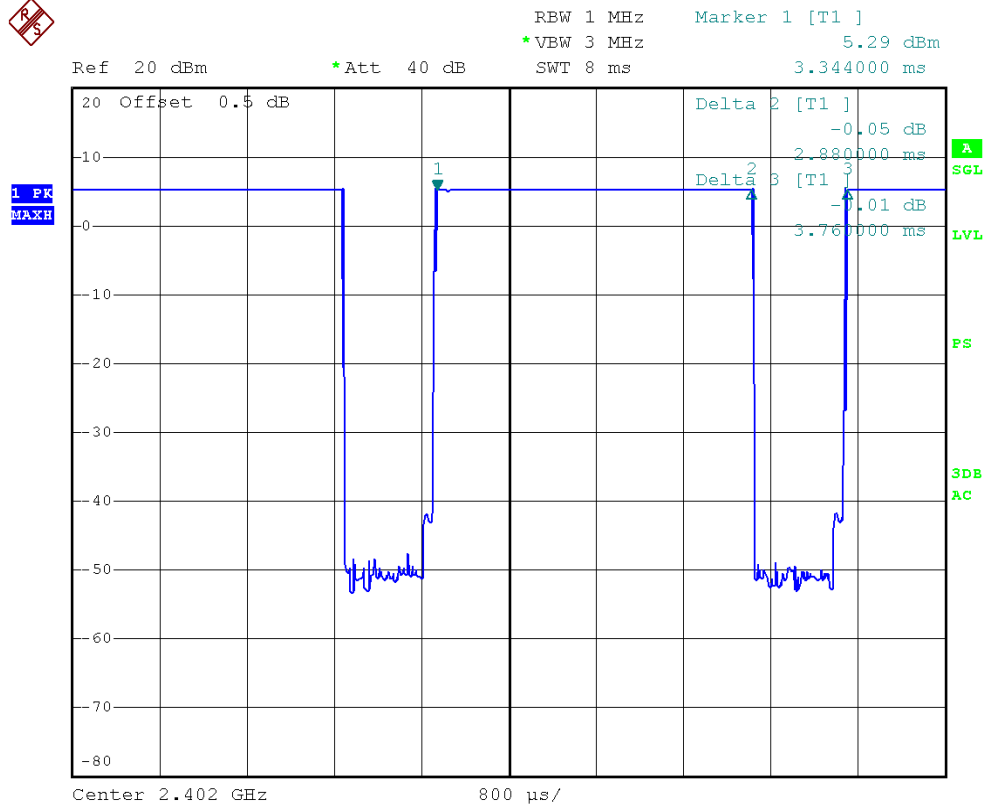

2DH1

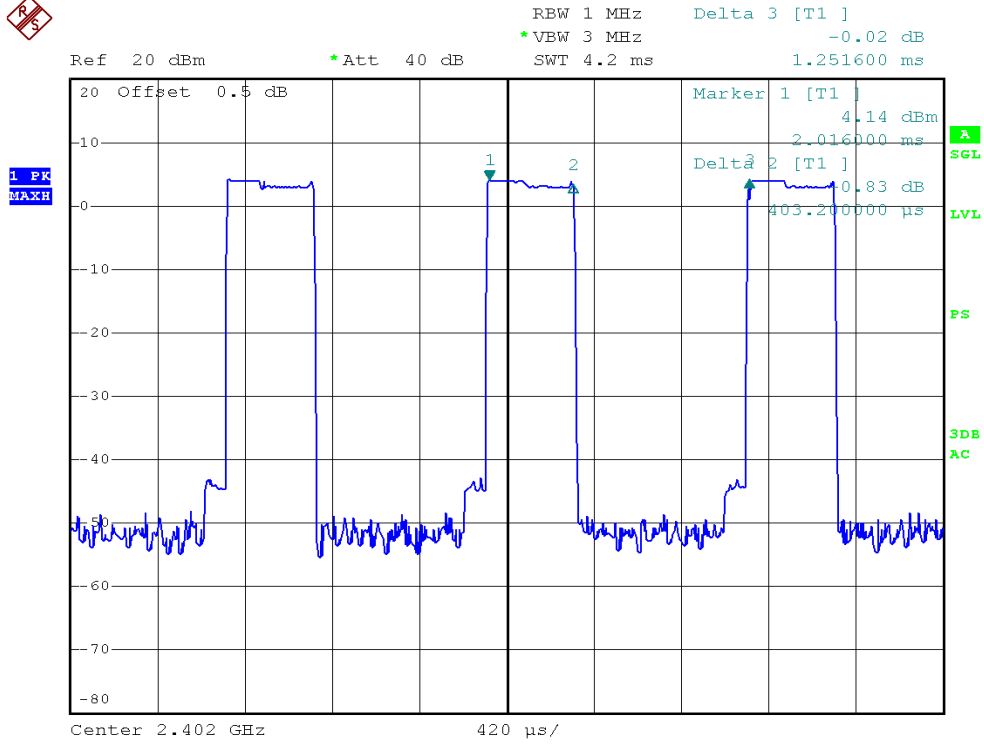

2DH3

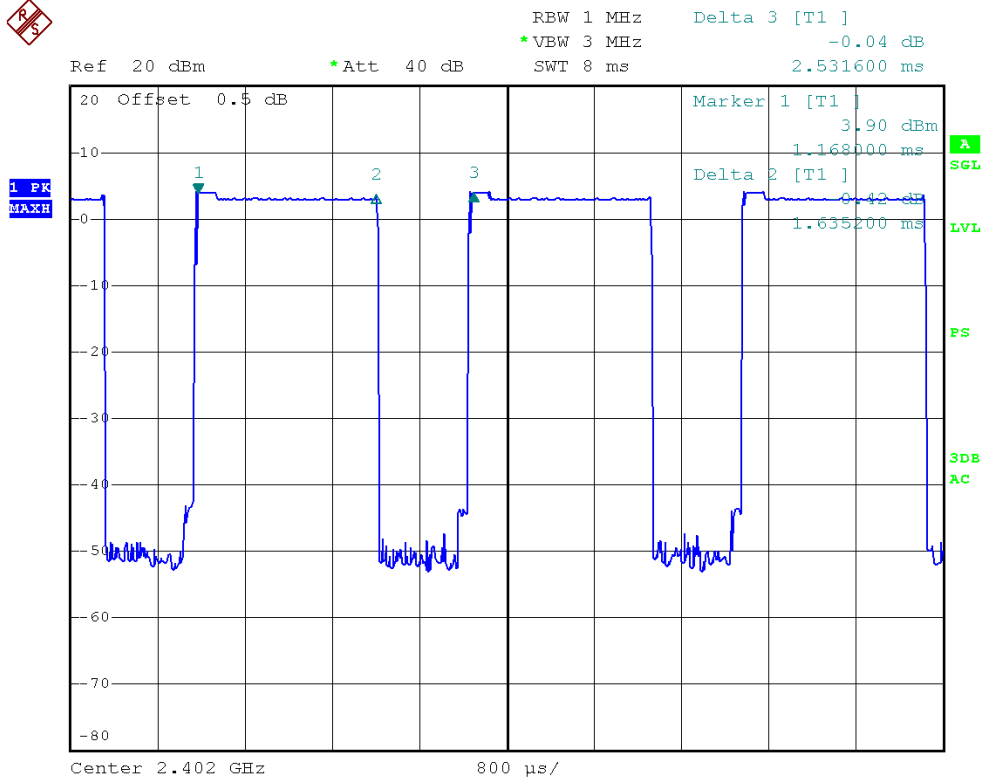

2DH5

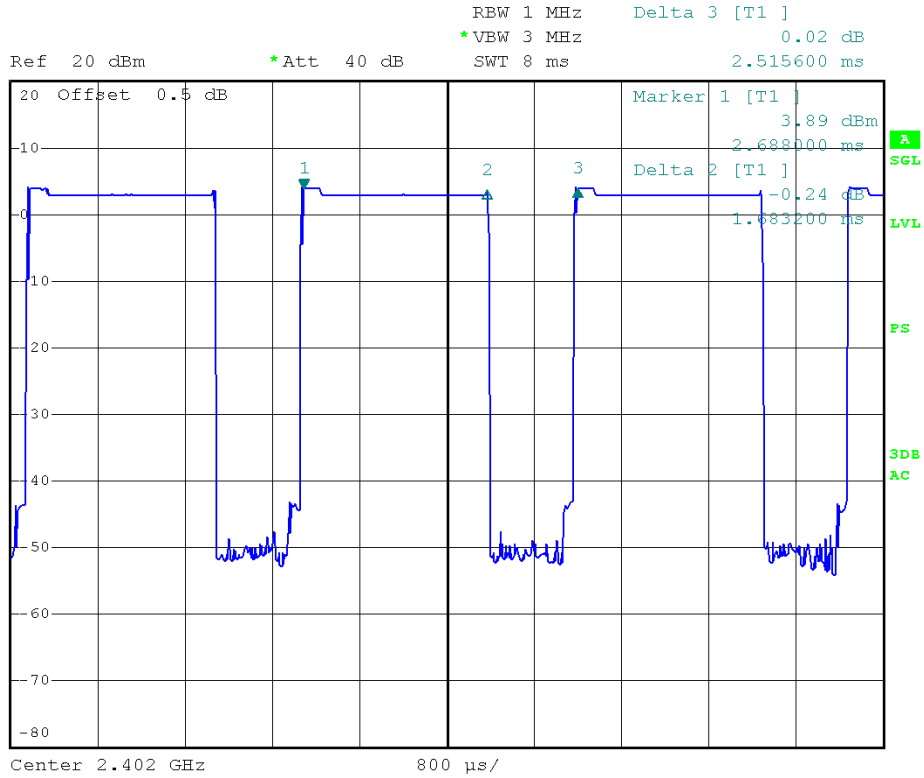

3DH1

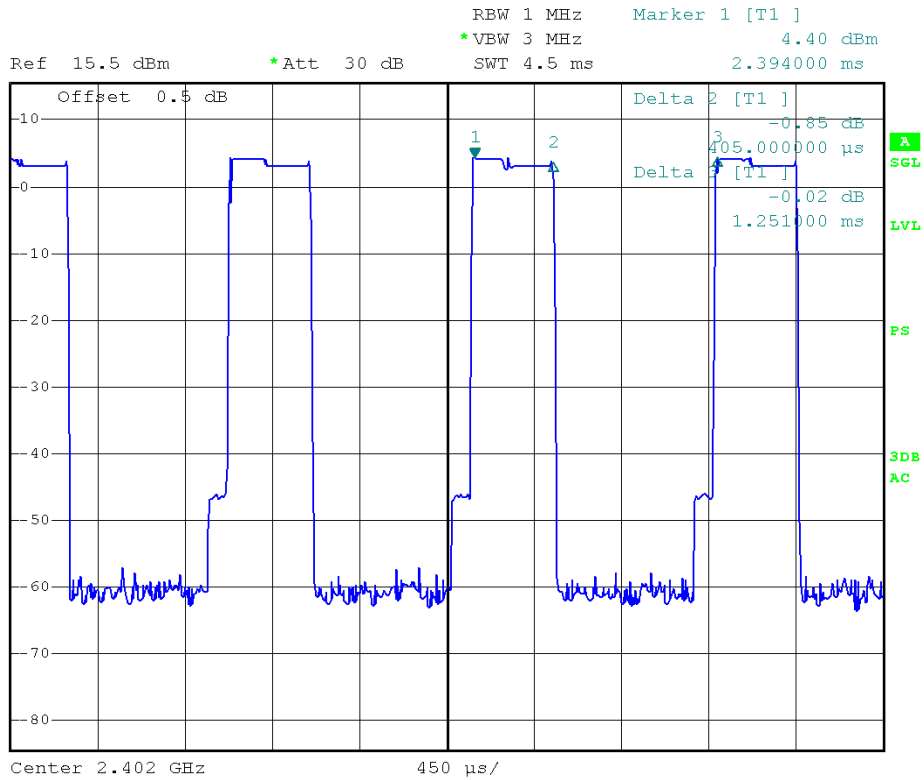

3DH3

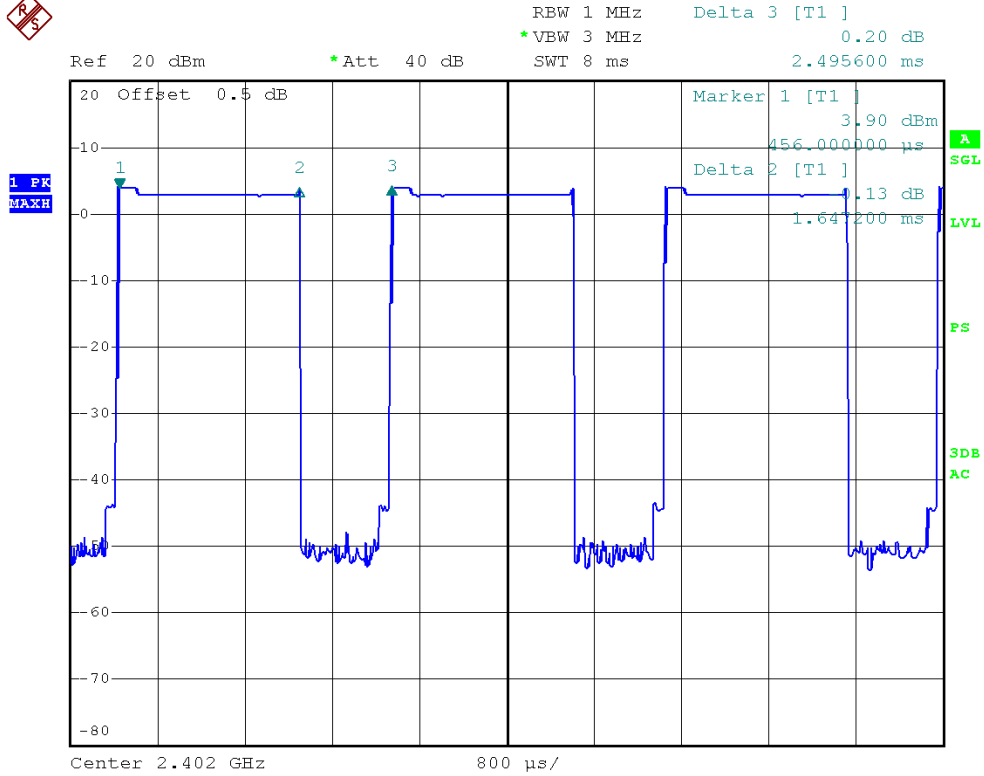

3DH5

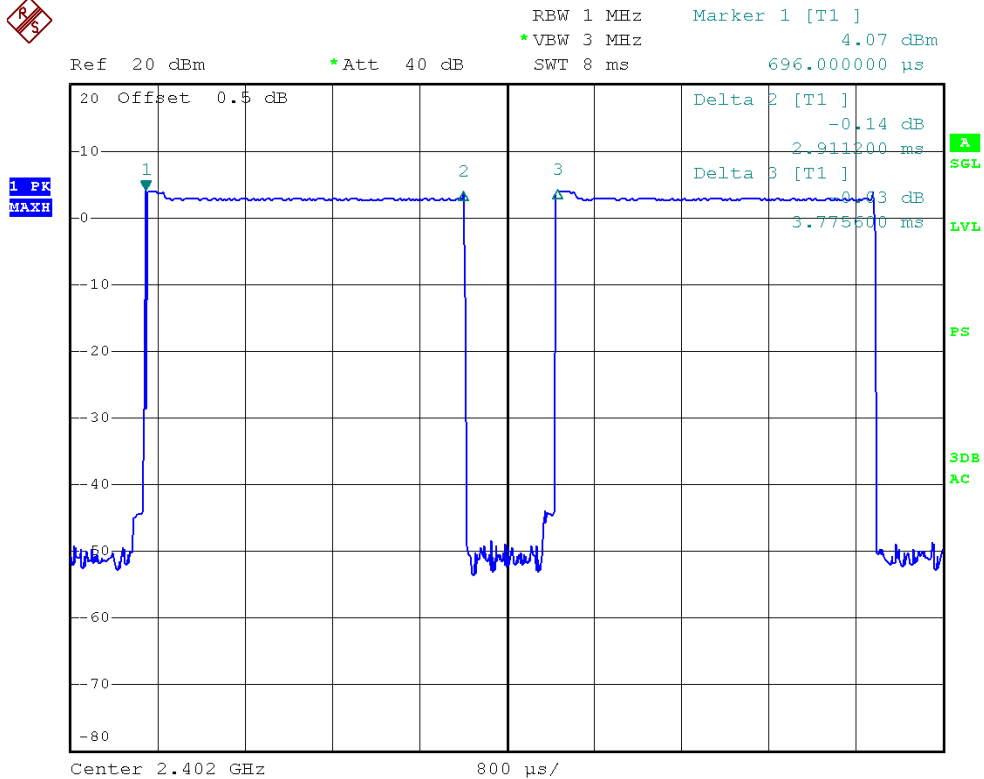

2. Middle Channel (2.441GHz)

DH1

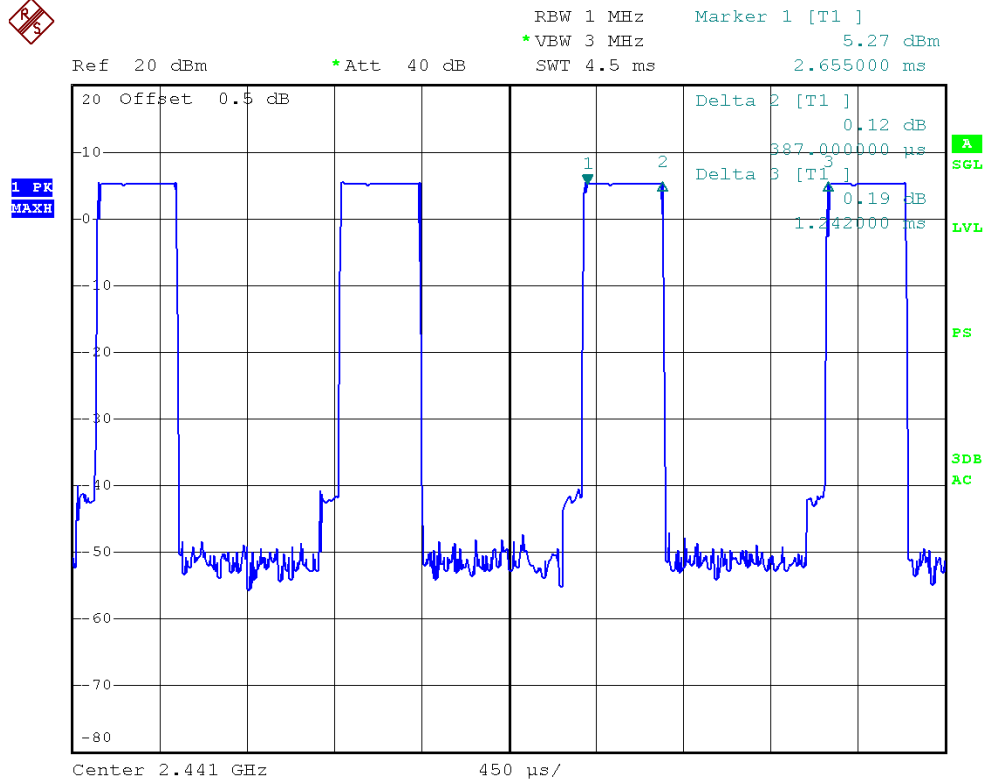

DH3

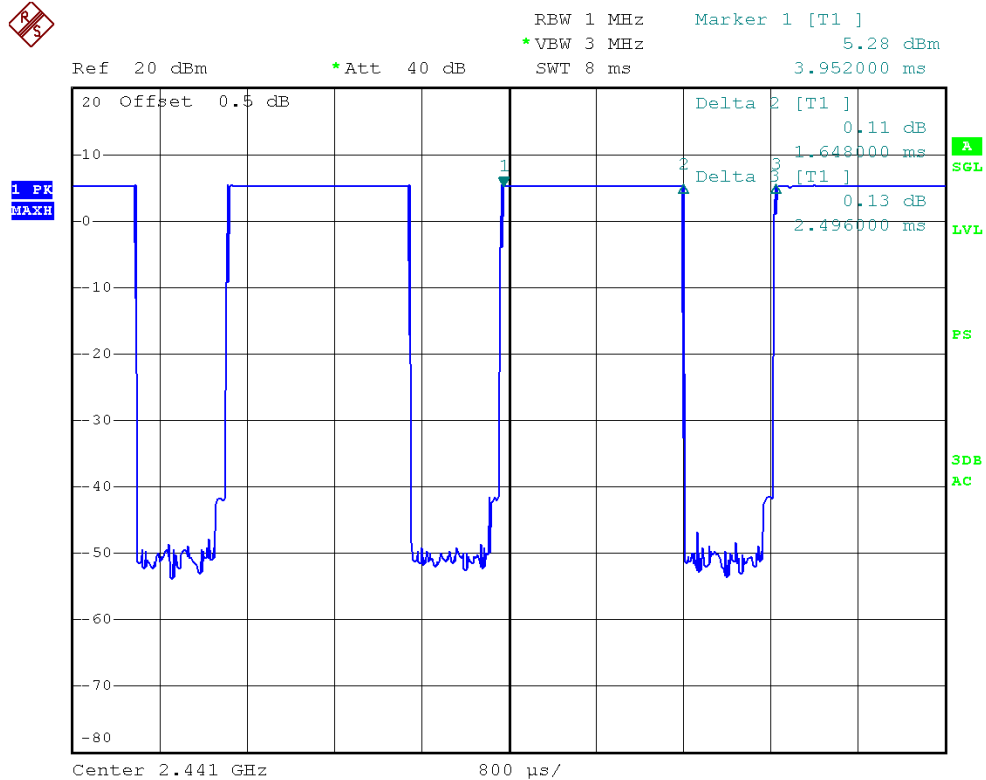

DH5

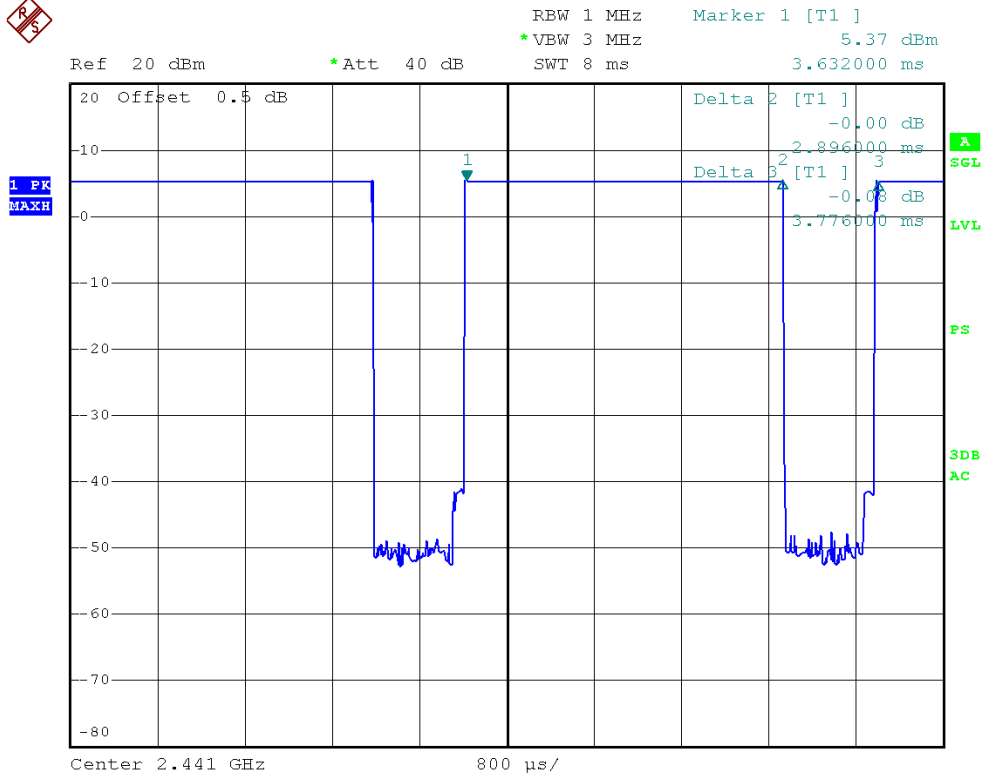

2DH1

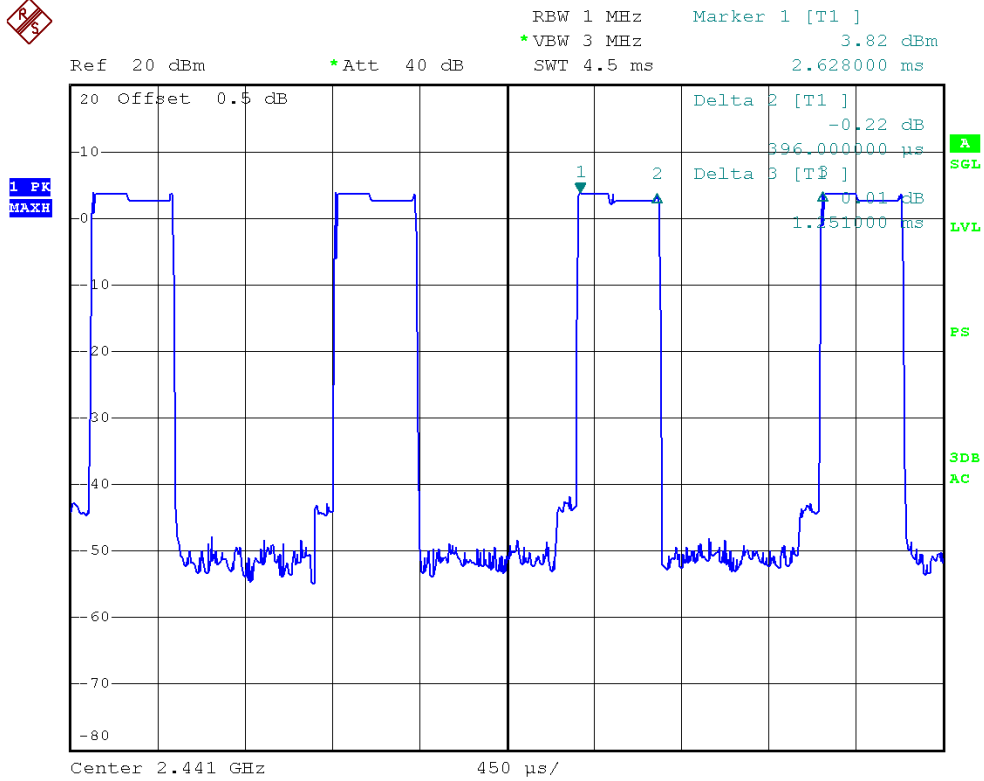

2DH3

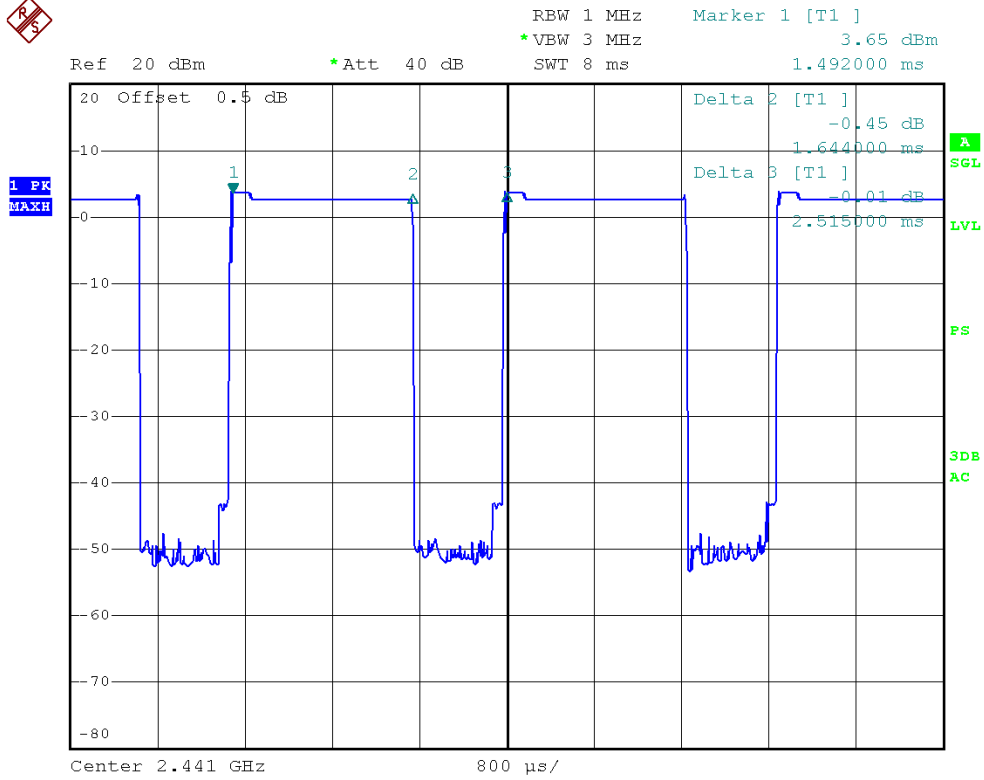

2DH5

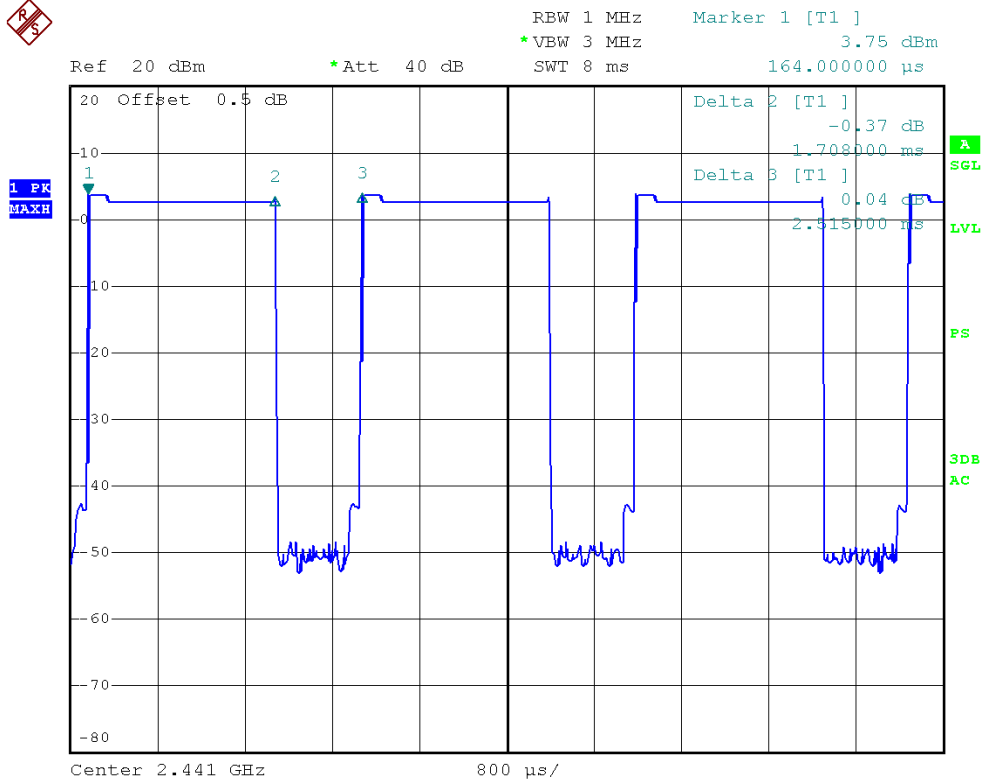

3DH1

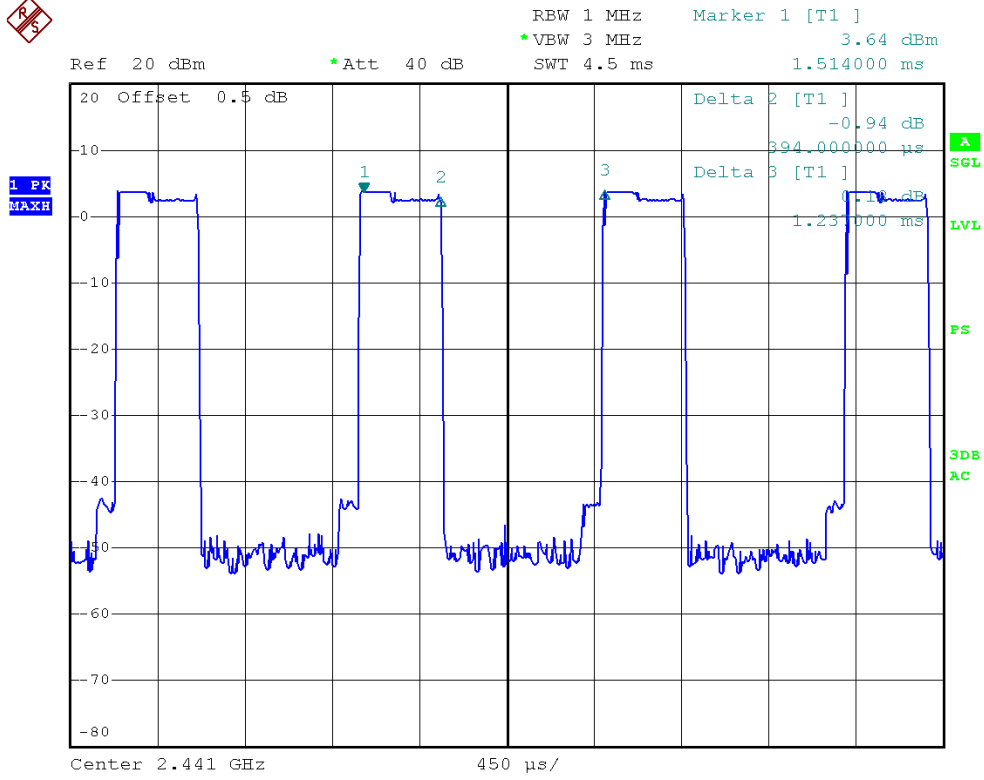

3DH3

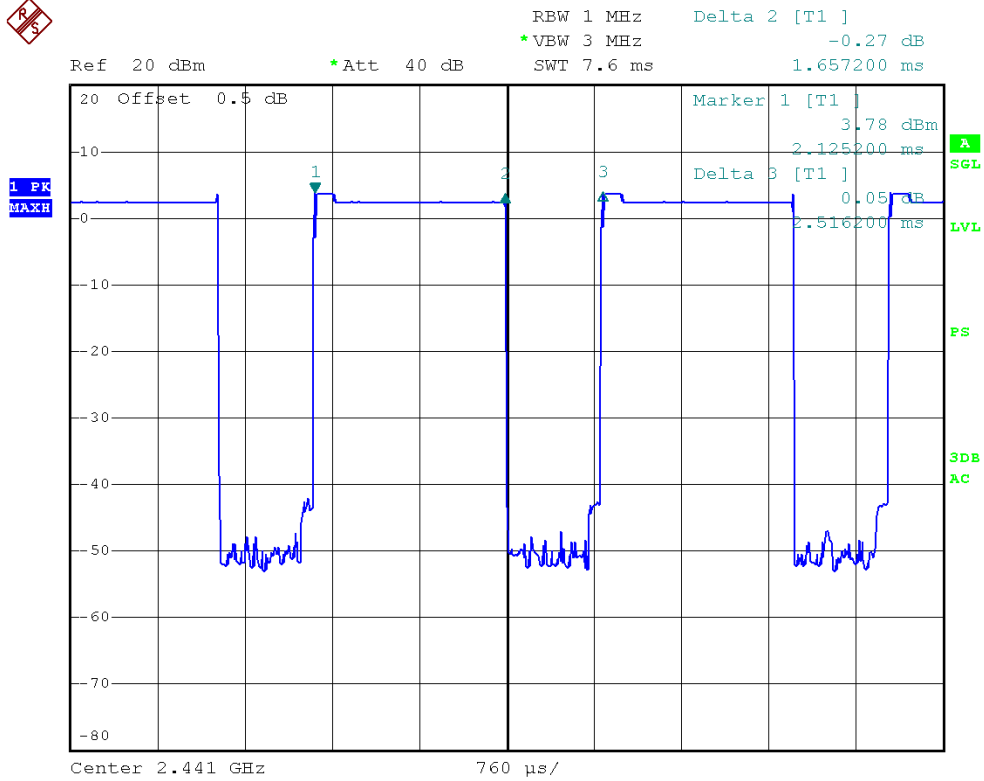

3DH5

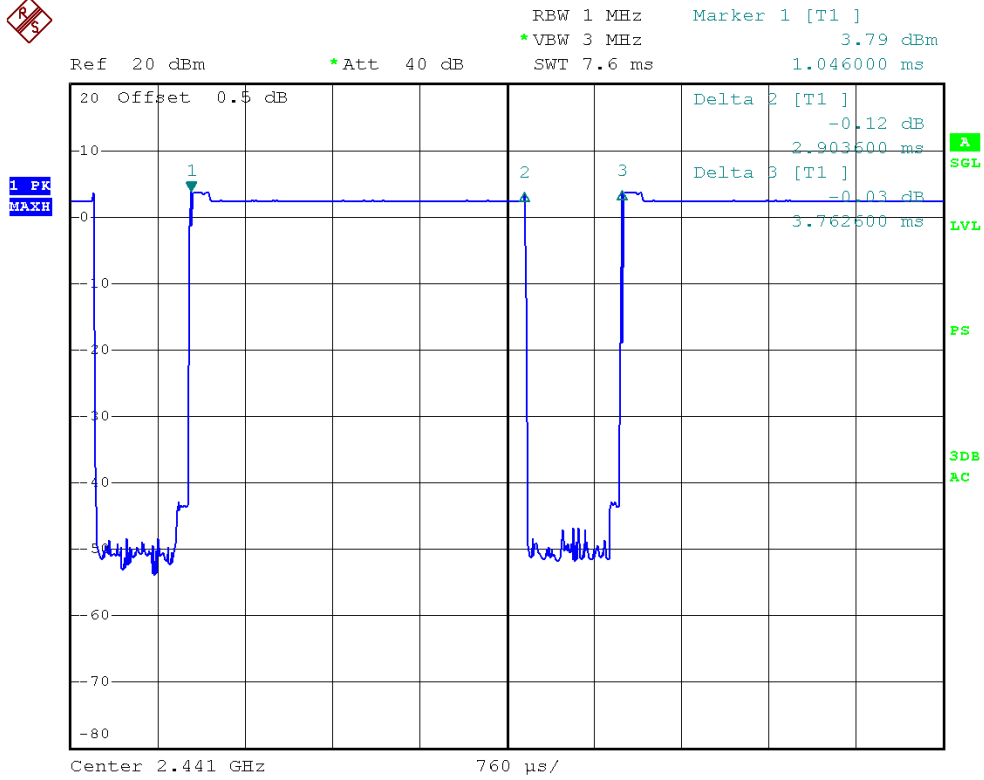

3. Highest channel (2.480GHz)

DH1

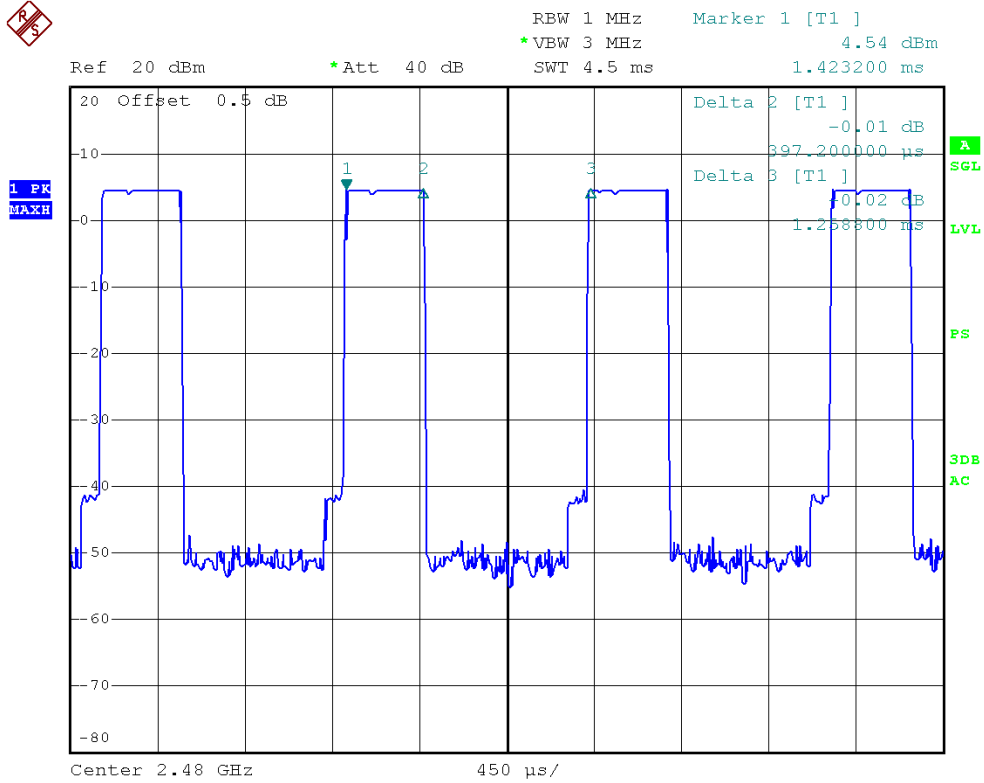

DH3

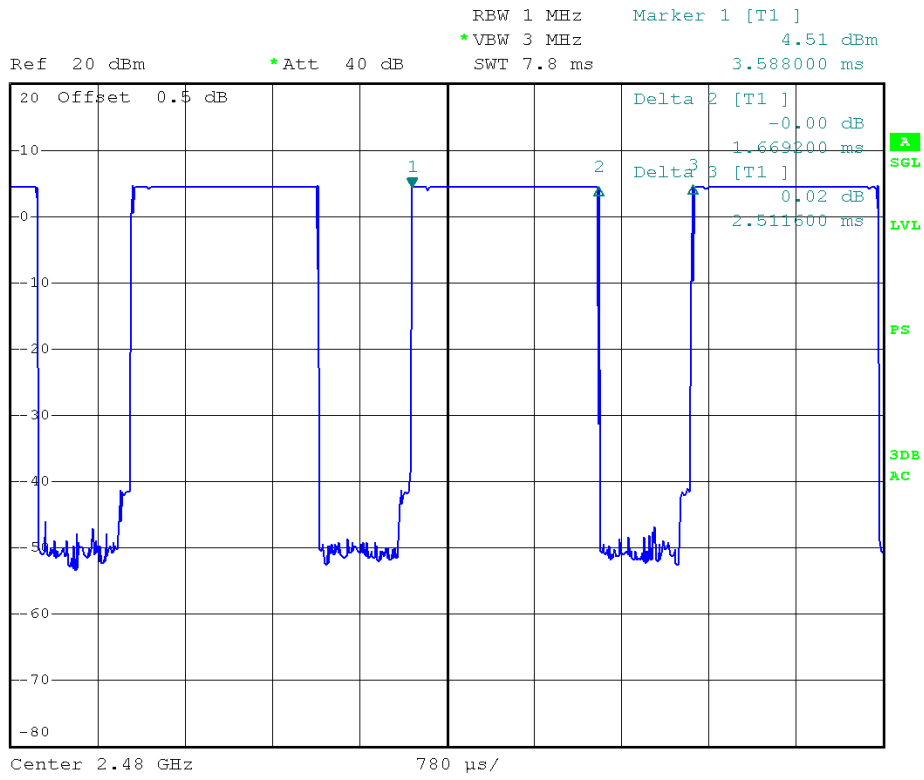

DH5

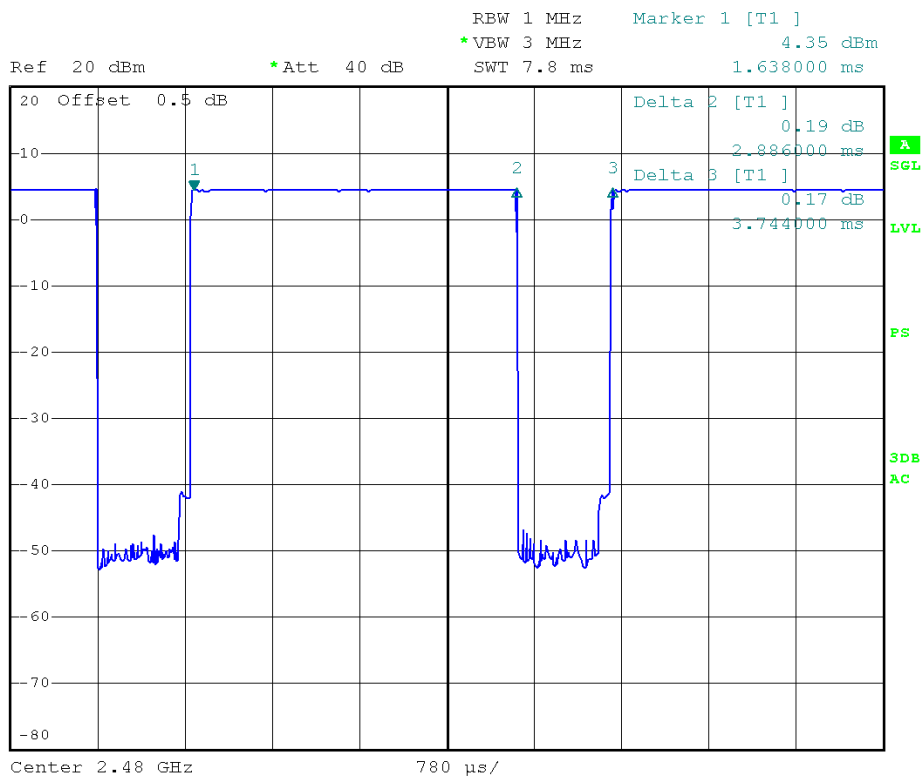

2DH1

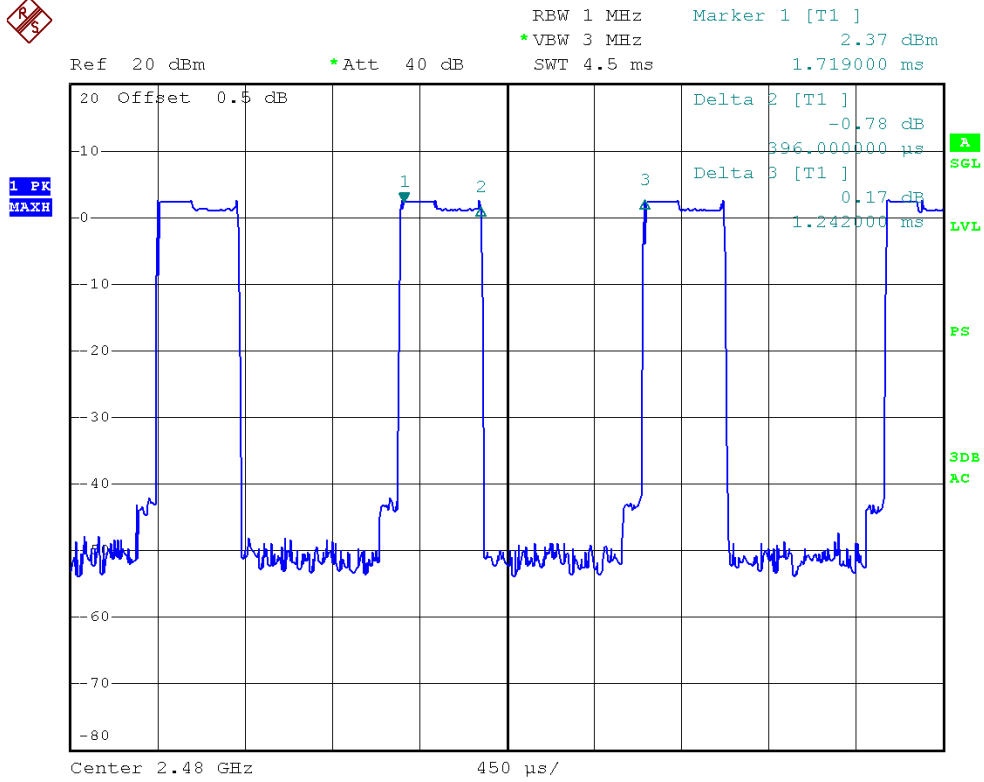

2DH3

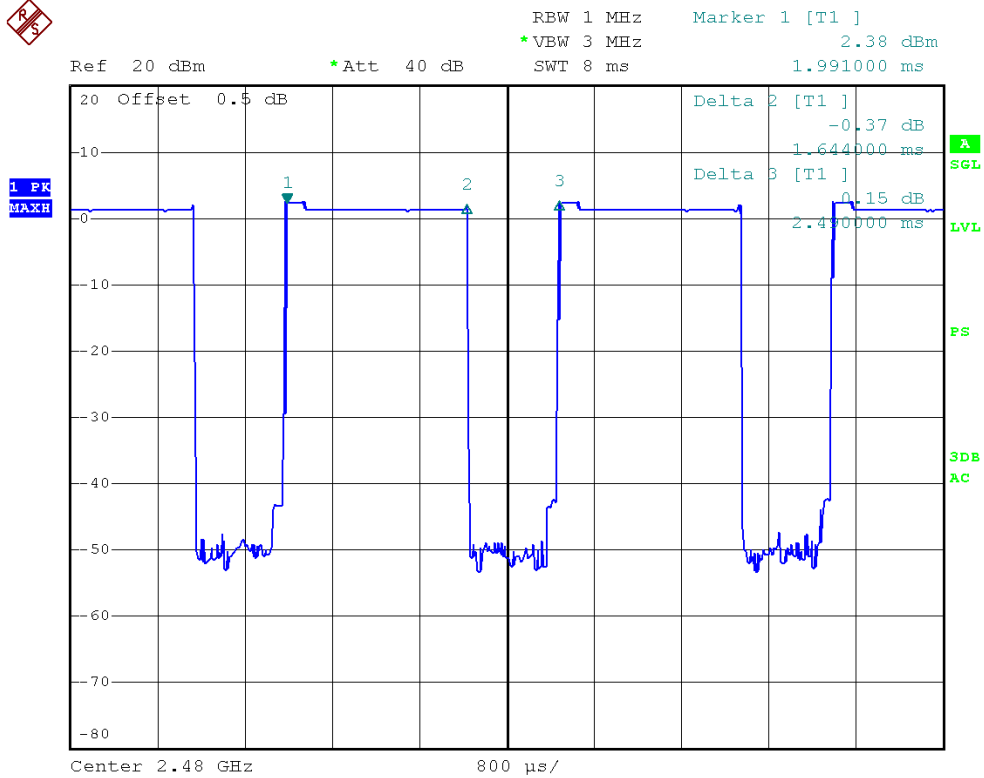

2DH5

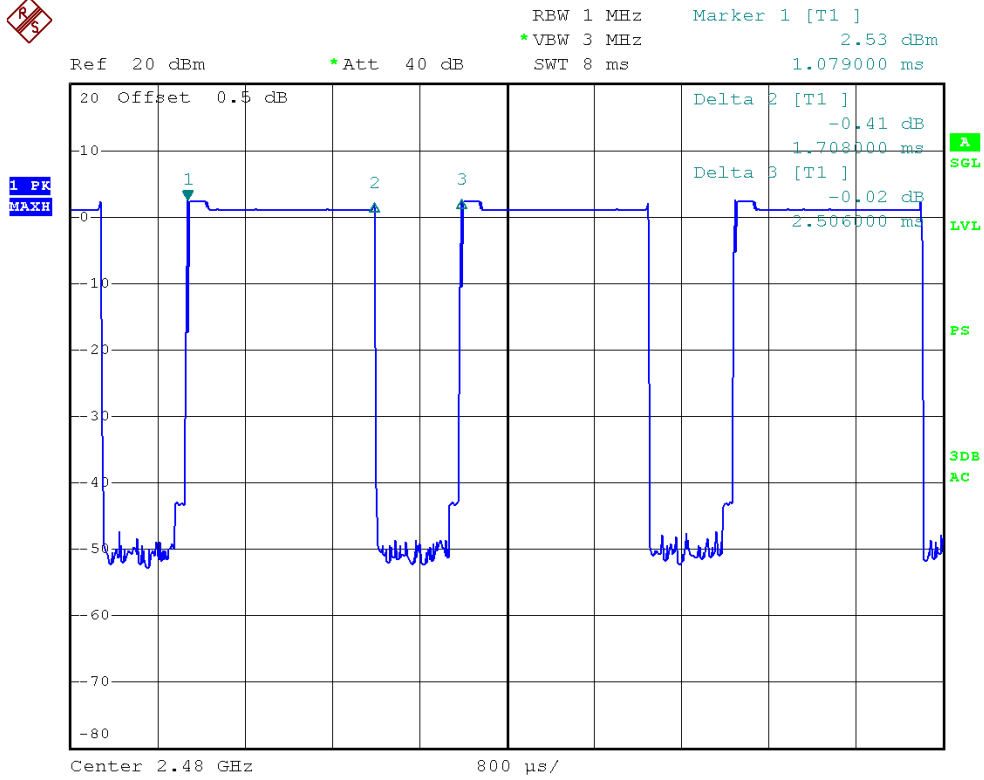

3DH1

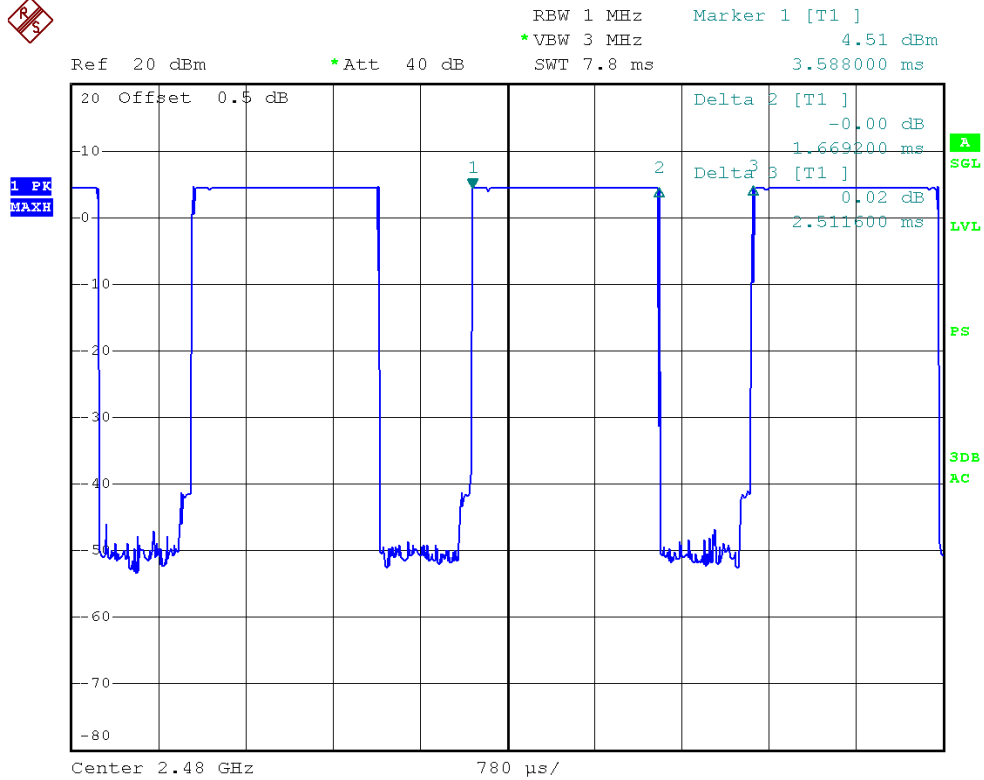

3DH3

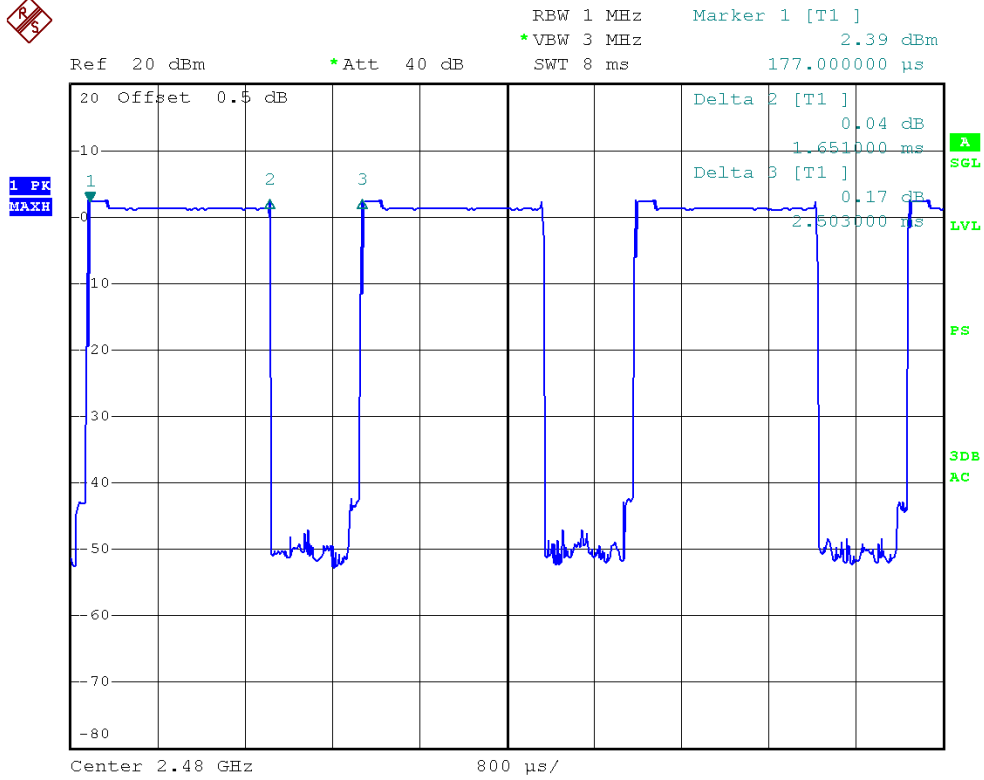

3DH5

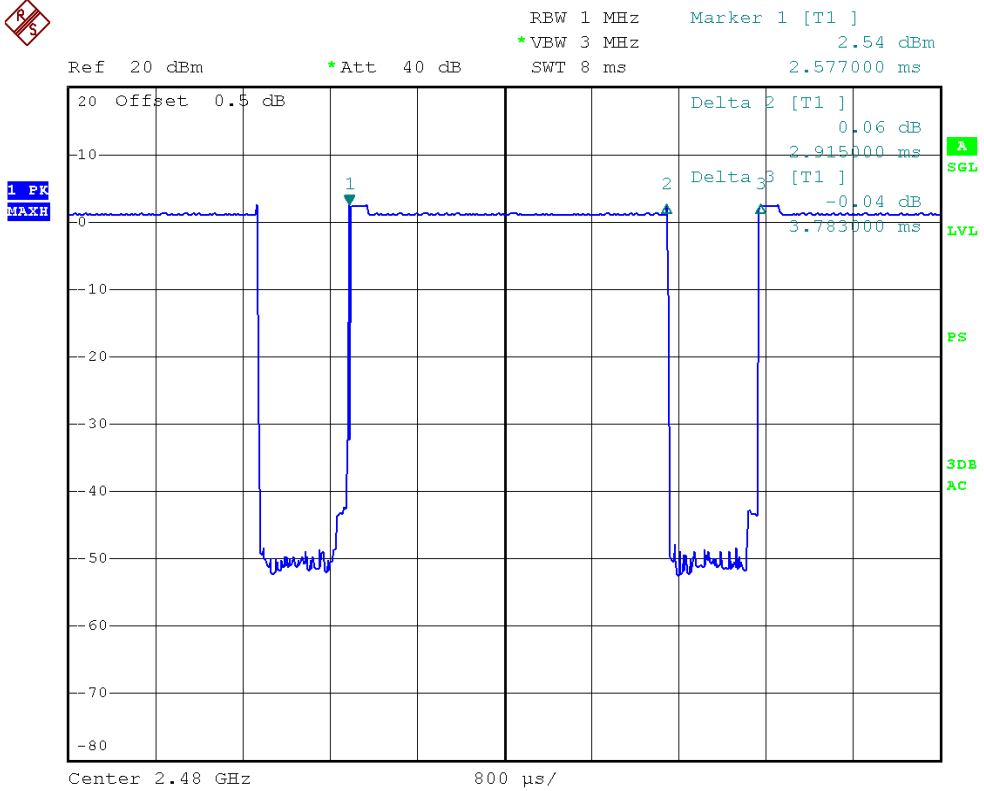

4.7 CONDUCTED EMISSION MEASUREMENT

4.7.1 LIMITS

Frequency range	Limits (dB μ V)	
	Quasi-peak	Average
150kHz ~ 0.5MHz	66 ~ 56	56 ~ 46
0.5 MHz ~ 5 MHz	56	46
5 MHz ~ 30 MHz	60	50

4.7.2 TEST PROCEDURES

Test procedures follow ANSI C63.4

Procedure of Preliminary Test

For measurement of the disturbance voltage the equipment under test (EUT) is connected to the power supply mains and any other extended network via one or more artificial network(s). An EUT, whether intended to be grounded or not, and which is to be used on a table is configured as follows:

- Either the bottom or the rear of the EUT shall be at a controlled distance of 40 cm from a reference ground plane. This ground plane is normally the wall or floor of a shielded room. It may also be a grounded metal plane of at least 2 m by 2 m. This is physically accomplished as follows:
 - 1) place the EUT on a table of non-conducting material which is at least 80 cm high. Place the EUT so that it is 40 cm from the wall of the shielded room, or
 - 2) place the EUT on a table of non-conducting material which is 40 cm high so that the bottom of the EUT is 40 cm above the ground plane;
- All other conductive surfaces of the EUT shall be at least 80 cm from the reference ground plane;
- The EUT are placed on the floor that one side of the housings is 40 cm from the vertical reference ground plane and other metallic parts;
- Interconnecting cables that hang closer than 40 cm to the ground plane shall be folded back and forth forming a bundle 30 cm to 40 cm long, hanging approximately in the middle between the ground plane and the table.
- I/O cables that are connected to a peripheral shall be bundled in the centre. The end of the cable may be terminated if required using correct terminating impedance. The total length shall not exceed 1 m.

The test mode(s) described in Item 2.4 were scanned during the preliminary test. After the preliminary scan, we found the test mode described in Item 2.4 producing the highest emission level. The EUT configuration and cable configuration of the above highest emission levels were recorded for reference of the final test.

Procedure of Final Test

EUT and support equipment were set up on the test bench as per the configuration with highest emission level in the preliminary test. A scan was taken on both power lines, recording at least the six highest emissions. Emission frequency and amplitude were recorded into a computer in which correction factors were used to calculate the emission level and compare reading to the applicable limit. The test data of the worst-case condition(s) was recorded.

4.7.3 TEST SETUP

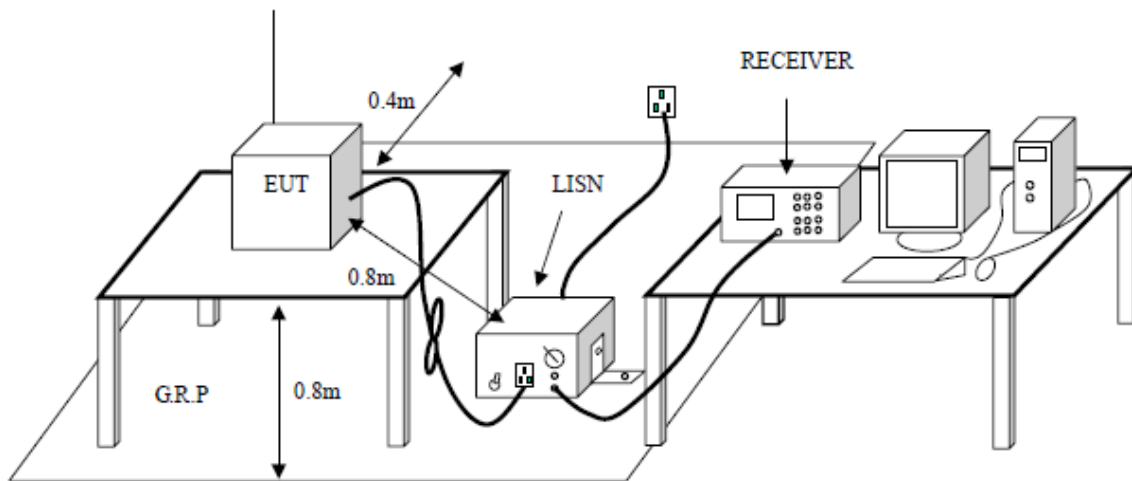

4.7.4 TEST RESULTS

Test Result:	Pass	Probe:	L
Standard:	(CE)FCC PART 15 class B _QP	Power Source:	AC 120V/60Hz
Test item:	Conduction Test	Date:	2012-7-3
Temp./Hum.(%RH):	22/49%RH	Time:	14:15:54
EUT:	Blu-RAY DISC SYSTEM	Model:	BDS 277
Note:	Transmitting		

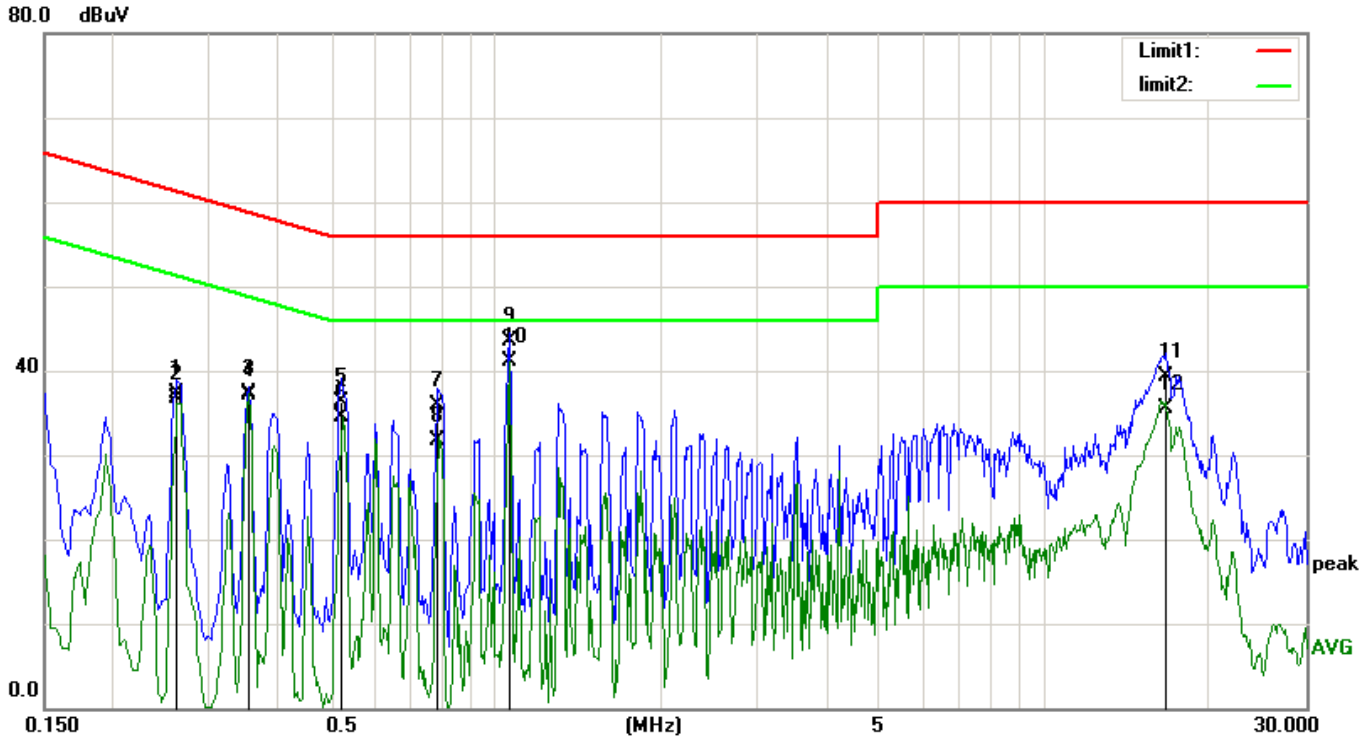

No.	Frequency (MHz)	Reading (dBuV)	Correct Factor(dB)	Result (dBuV)	Limit (dBuV)	Margin (dB)	Remark
1	0.2620	36.32	0.98	37.30	61.36	-24.06	QP
2	0.2620	35.72	0.98	36.70	51.36	-14.66	AVG
3	0.3540	36.49	0.81	37.30	58.87	-21.57	QP
4	0.3540	36.29	0.81	37.10	48.87	-11.77	AVG
5	0.5220	35.77	0.53	36.30	56.00	-19.70	QP
6	0.5220	33.97	0.53	34.50	46.00	-11.50	AVG
7	0.7820	35.59	0.41	36.00	56.00	-20.00	QP
8	0.7820	31.29	0.41	31.70	46.00	-14.30	AVG
9	1.0580	43.05	0.45	43.50	56.00	-12.50	QP
10	1.0580	40.75	0.45	41.20	46.00	-4.80	AVG
11	16.6699	38.47	0.93	39.40	60.00	-20.60	QP
12	16.6699	34.67	0.93	35.60	50.00	-14.40	AVG

Test Result:	Pass	Probe:	N
Standard:	(CE)FCC PART 15 class B _QP	Power Source:	AC 120V/60Hz
Test item:	Conduction Test	Date:	2012-7-3
Temp./Hum.(%RH):	22/49%RH	Time:	14:23:59
EUT:	Blu-RAY DISC SYSTEM	Model:	BDS 277
Note:	Transmitting		

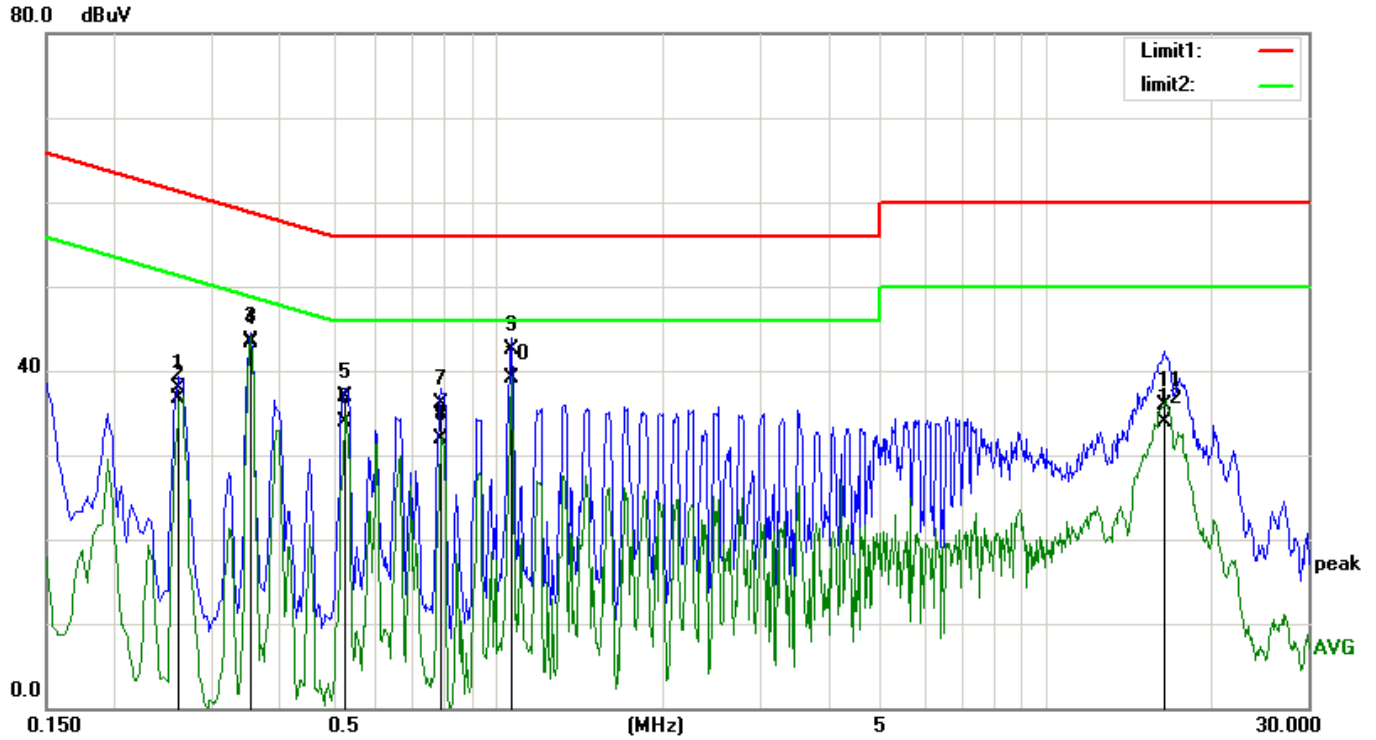

No.	Frequency (MHz)	Reading (dBuV)	Correct Factor(dB)	Result (dBuV)	Limit (dBuV)	Margin (dB)	Remark
1	0.2620	36.92	0.98	37.90	61.36	-23.46	QP
2	0.2620	35.82	0.98	36.80	51.36	-14.56	AVG
3	0.3540	42.79	0.81	43.60	58.87	-15.27	QP
4	0.3540	42.59	0.81	43.40	48.87	-5.47	AVG
5	0.5260	36.37	0.53	36.90	56.00	-19.10	QP
6	0.5260	33.37	0.53	33.90	46.00	-12.10	AVG
7	0.7860	35.69	0.41	36.10	56.00	-19.90	QP
8	0.7860	31.59	0.41	32.00	46.00	-14.00	AVG
9	1.0580	42.15	0.45	42.60	56.00	-13.40	QP
10	1.0580	38.75	0.45	39.20	46.00	-6.80	AVG
11	16.4380	34.97	0.93	35.90	60.00	-24.10	QP
12	16.4380	33.07	0.93	34.00	50.00	-16.00	AVG

4.8 MAXIMUM PEAK OUTPUT POWER

4.8.1 LIMITS

Regulation 15.247 (b)(1) For frequency hopping systems operating in the 2400-2483.5 MHz band employing at least 75 non-overlapping hopping channels, and all frequency hopping systems in the 5725-5850 MHz band: 1 watt. For all other frequency hopping systems in the 2400-2483.5 MHz band: 0.125 watts. Refer to the result "Hopping channel number" of this document. The 1 watt (30.0dBm) limit applies.

4.8.2 TEST PROCEDURES

Test procedures follow ANSI C63.4

- 1 . Remove the antenna from the EUT and then connect a low RF cable from the antenna port to the spectrum.
- 2 . Set the spectrum analyzer: RBW = 1 MHz. VBW = 3 MHz. Sweep = auto; Detector Function = Peak.
- 3 . Keep the EUT in transmitting at lowest, medium and highest channel individually. Record the max value.

Remark:

1. Pre-test the 3 modulation to find GFSK and 8DPSK is worse case, so only record GFSK and 8DPSK test data.
2. Cable loss = 0.5dB , the receiver offset loss 0.5dB

4.8.3 TEST SETUP

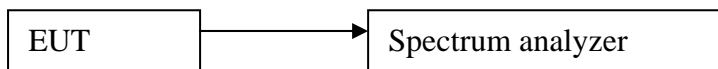

4.8.4 TEST RESULTS

For GFSK:

Test Channel	Fundamental Frequency (GHz)	Max Output Power (dBm)	Gain (dBi)	Limit (dBm)	Margin (dB)
Lowest	2.402	4.83	0	30.0	25.17
Middle	2.441	4.58	0	30.0	25.42
Highest	2.480	3.64	0	30.0	26.36

For 8DPSK:

Test Channel	Fundamental Frequency (GHz)	Max Output Power (dBm)	Gain (dBi)	Limit (dBm)	Margin (dB)
Lowest	2.402	3.91	0	30.0	26.09
Middle	2.441	3.54	0	30.0	26.46
Highest	2.480	2.43	0	30.0	27.57

Test result: The unit does meet the FCC requirements.

Test result plot as follows:

GFSK Lowest Channel:

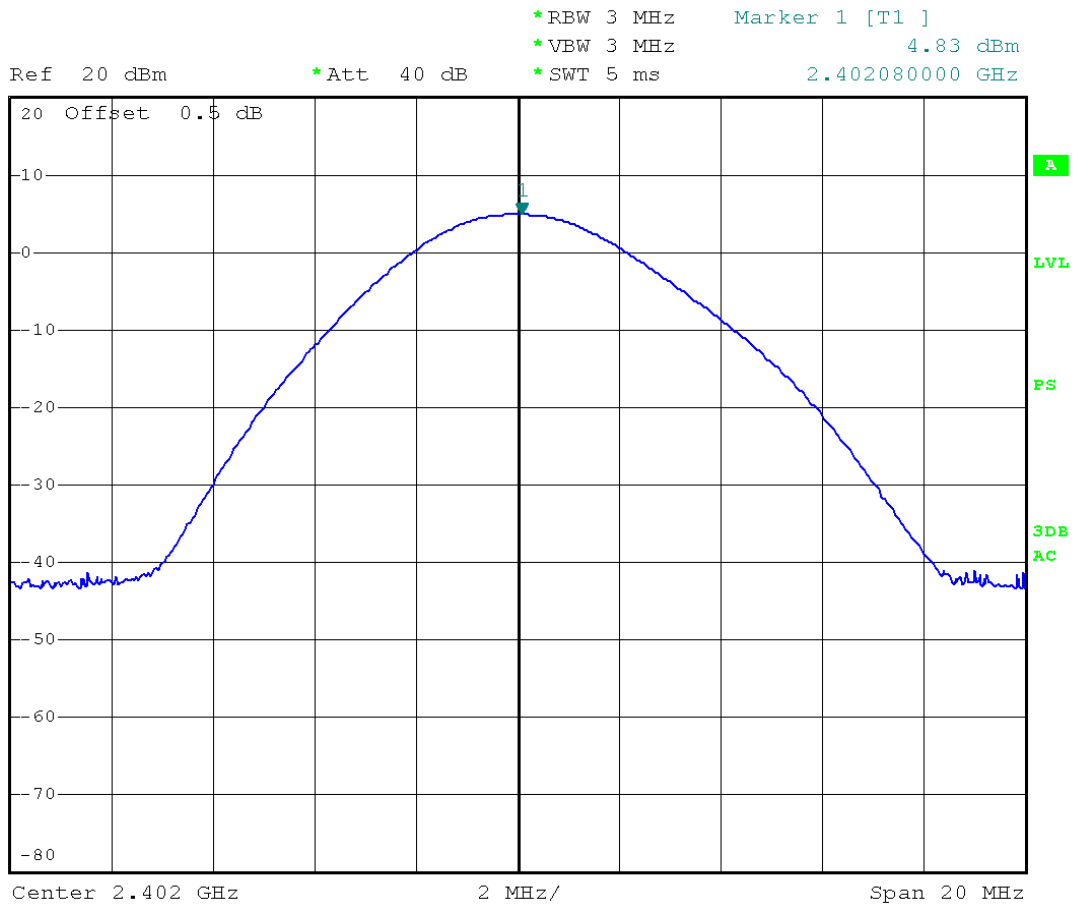

GFSK Middle Channel:

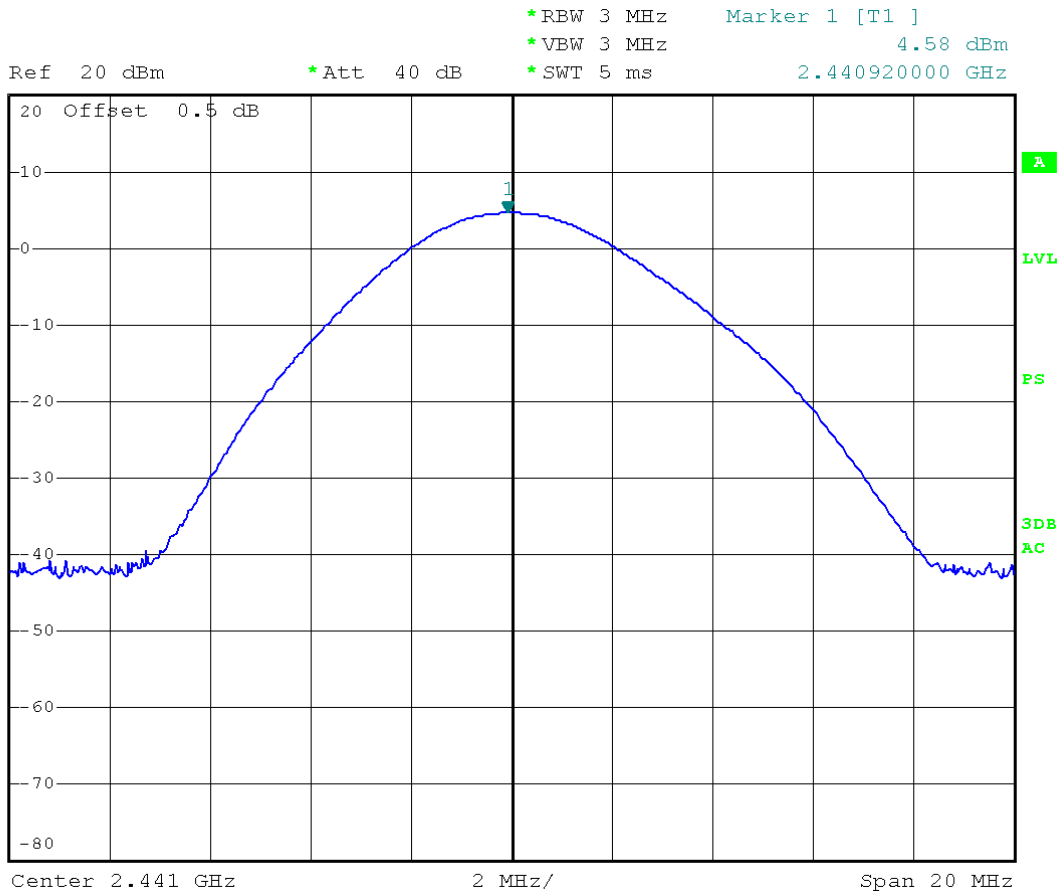

GFSK Highest Channel:

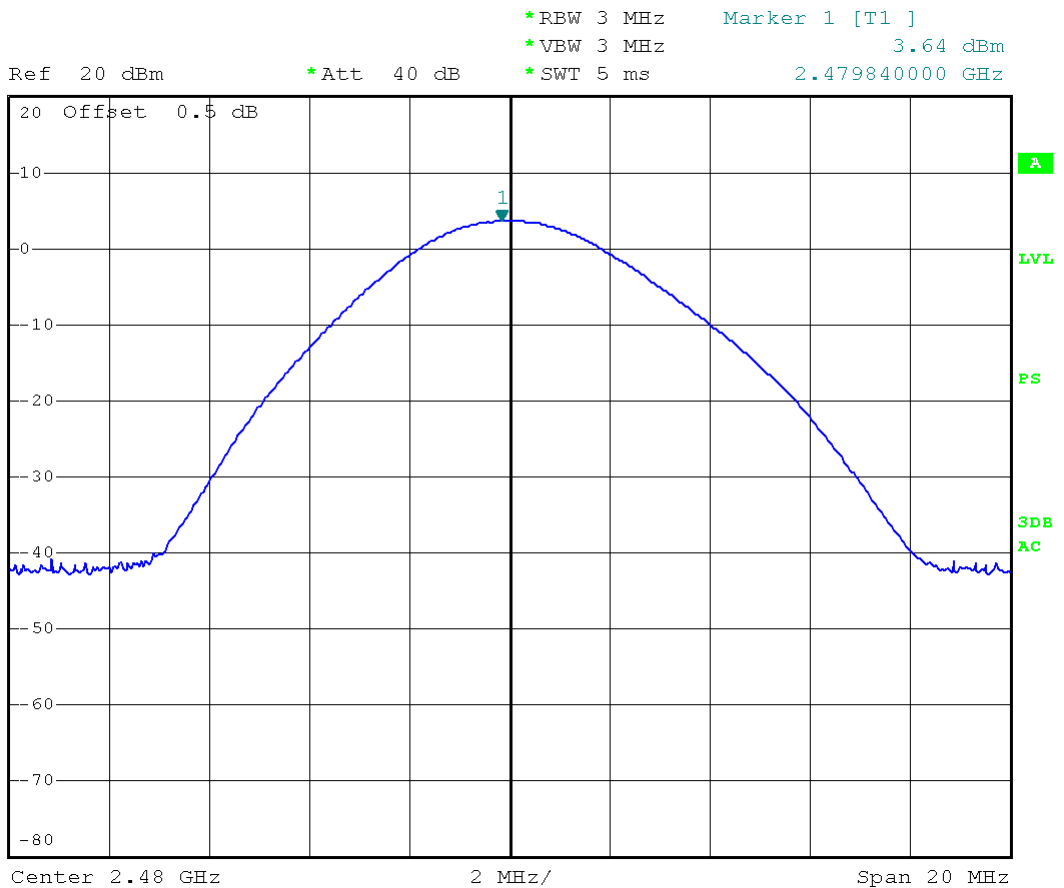

8DPSK Lowest Channel:

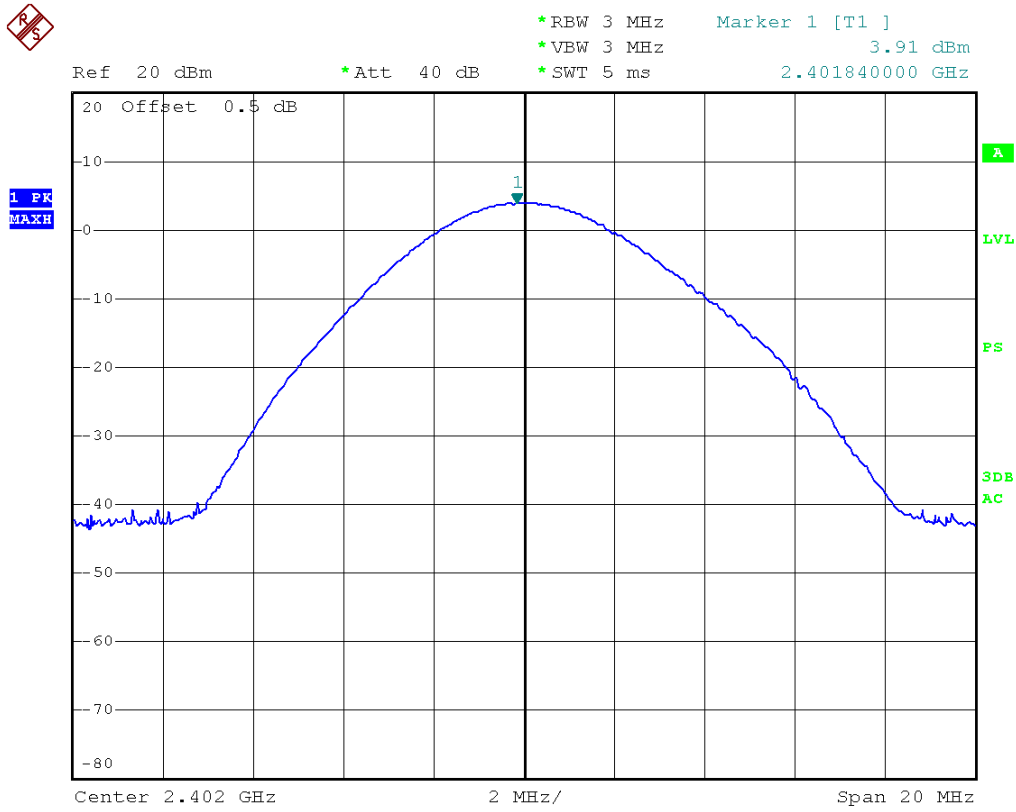

8DPSK Middle Channel:

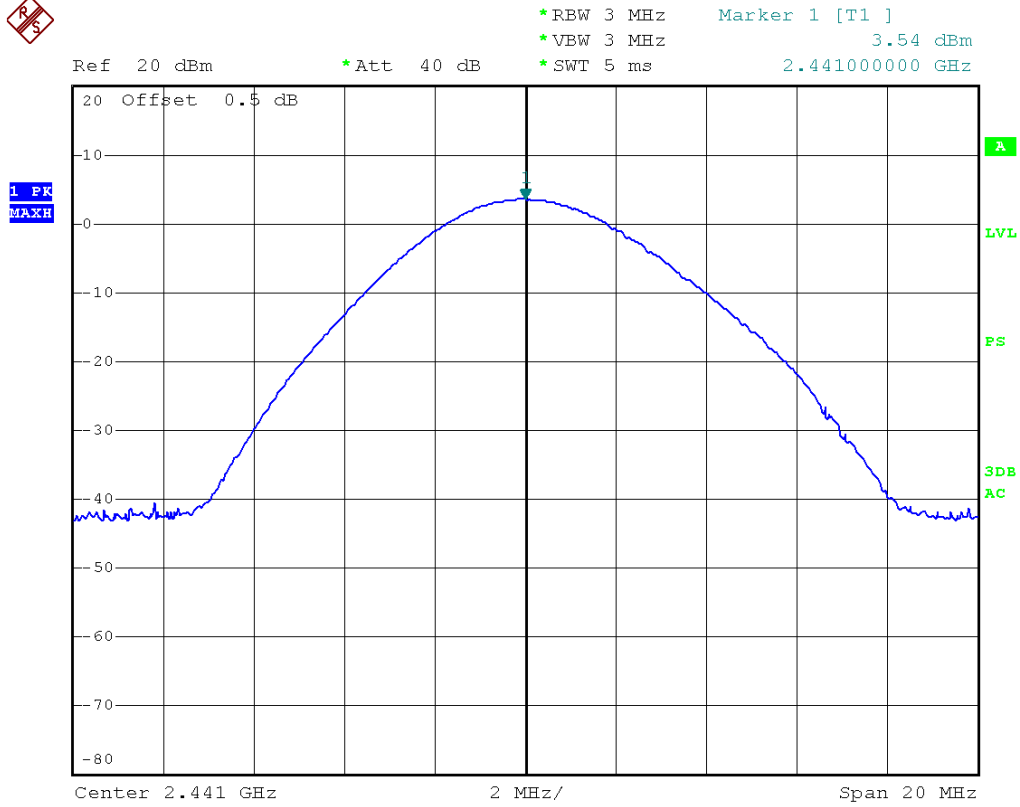

8DPSK Highest Channel:

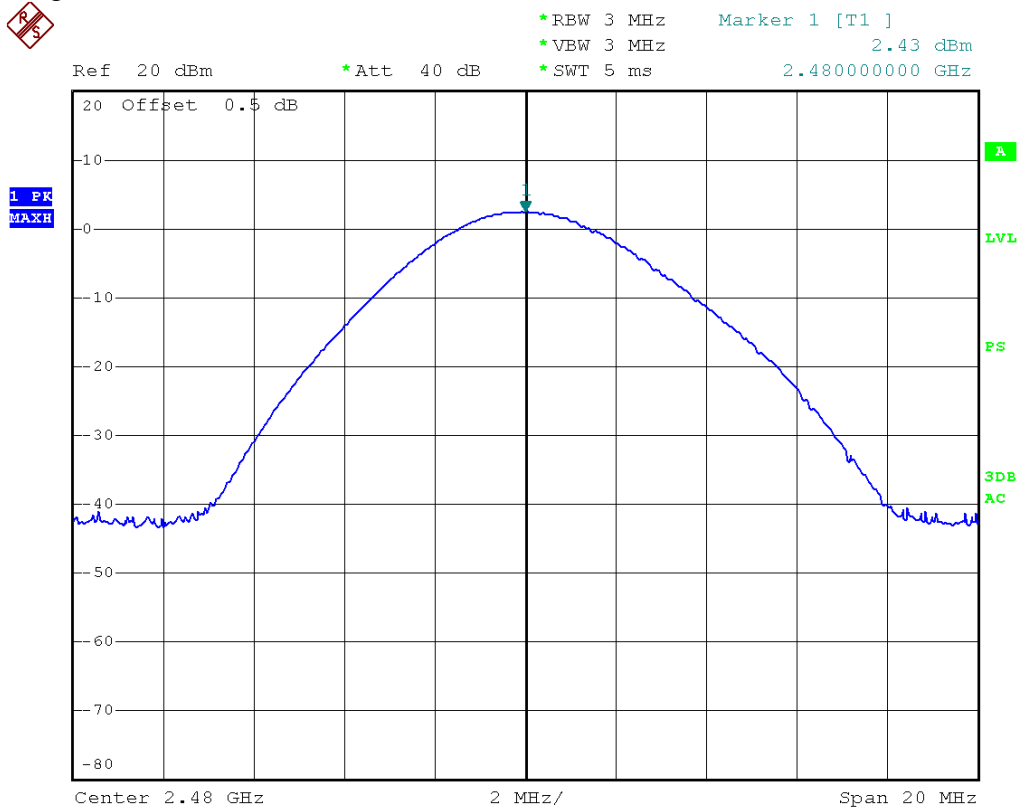

4.9 CONDUCTED SPURIOUS EMISSIONS

4.9.1 LIMITS

(d) In any 100 kHz bandwidth outside the frequency band in which the spread spectrum or digitally modulated intentional radiator is operating, the radio frequency power that is produced by the intentional radiator shall be at least 20 dB below that in the 100 kHz bandwidth within the band that contains the highest level of the desired power, based on either an RF conducted or a radiated measurement, provided the transmitter demonstrates compliance with the peak conducted power limits.

4.9.2 TEST PROCEDURES

Test procedures follow ANSI C63.4

Remove the antenna from the EUT and then connect a low attenuation cable from the antenna port to the spectrum.

Below 1GHz Set the spectrum analyzer: RBW =100KHz VBW \geq RBW , Span = enough to catch the trace. Sweep = auto; Detector Function = Peak. Trace = Max,hold.

Above 1GHz Set the spectrum analyzer: RBW =1MHz VBW \geq RBW , Span = enough to catch the trace. Sweep = auto; Detector Function = Peak. Trace = Max,hold.

4.9.3 TEST SETUP

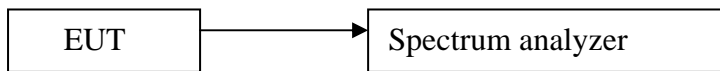

4.9.4 TEST RESULTS

Test result plot as follows:

For GFSK

Lowest Channel:

30M to 1GHz

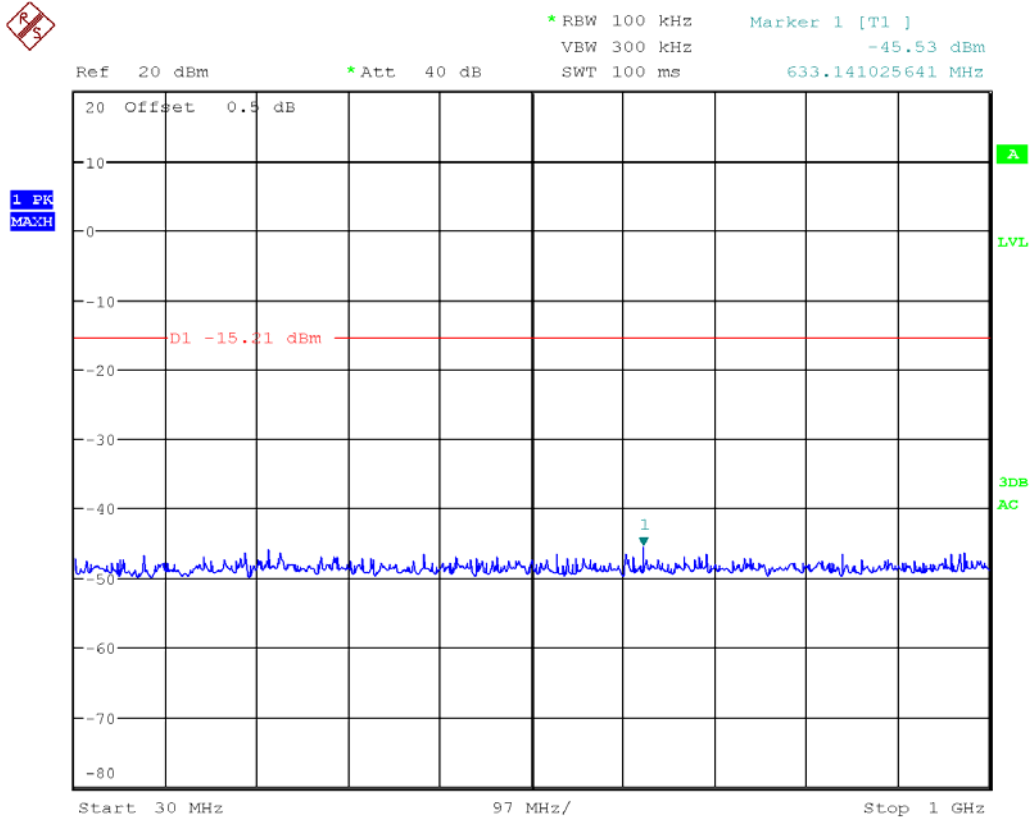

1G to 10GHz

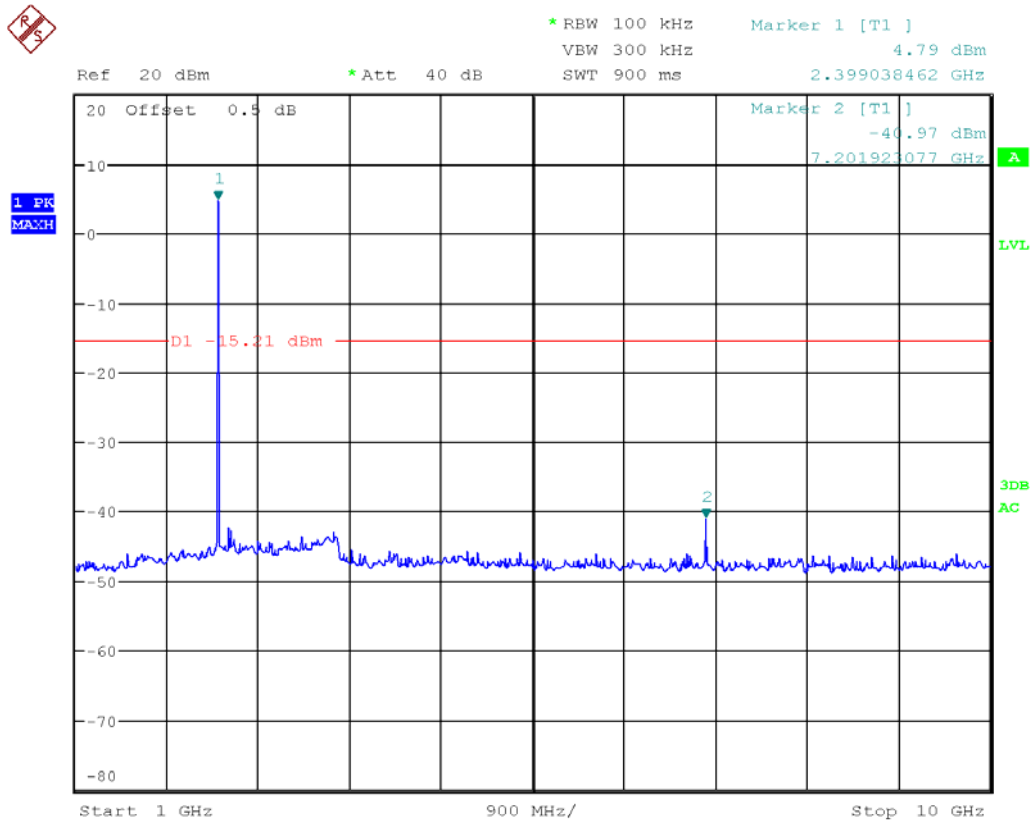

10G to 25GHz

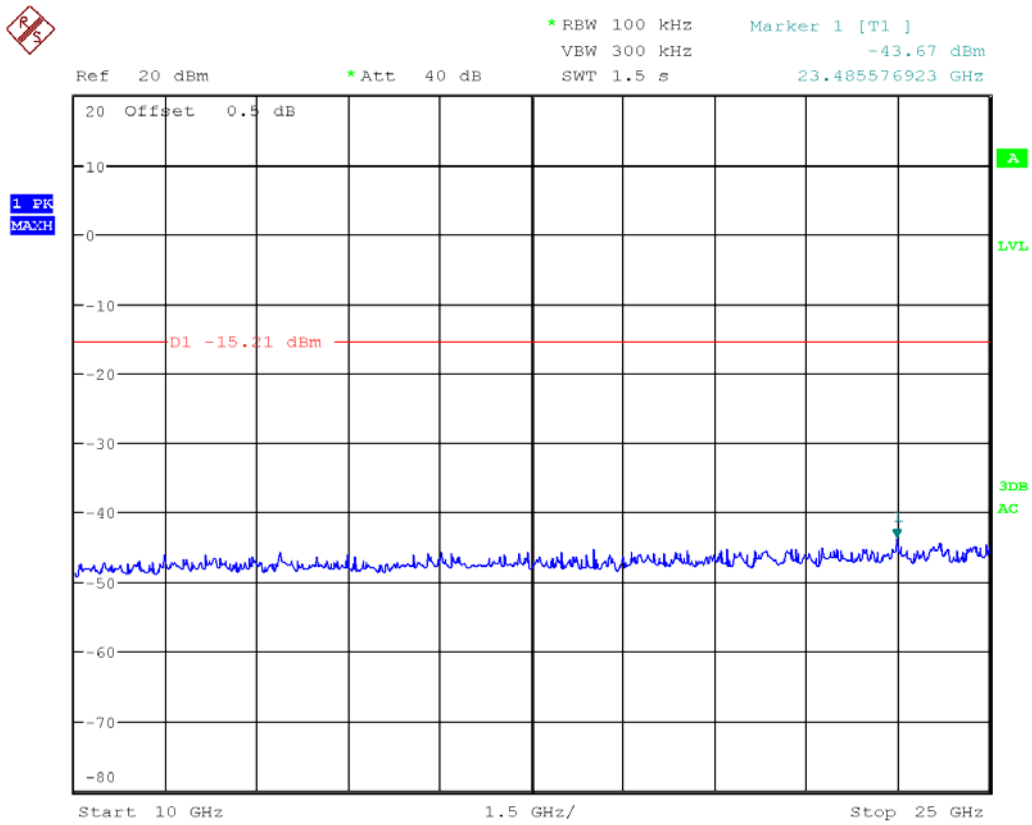

Middle Channel:

30M to 1GHz

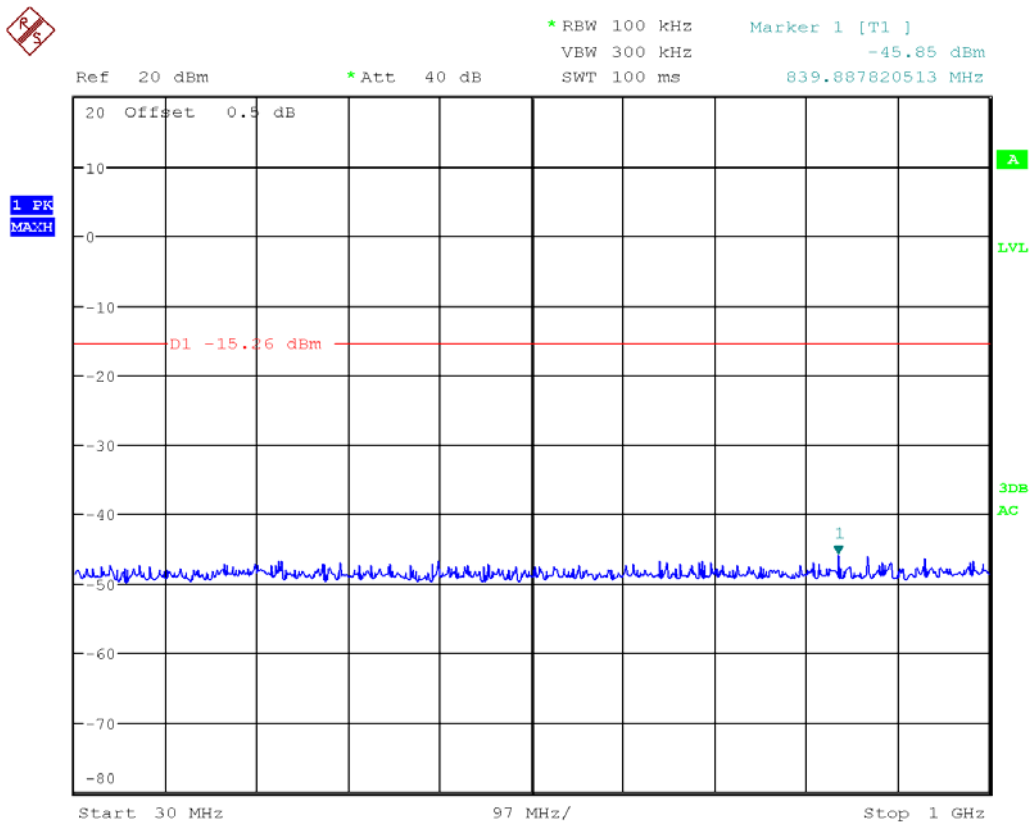

1G to 10GHz

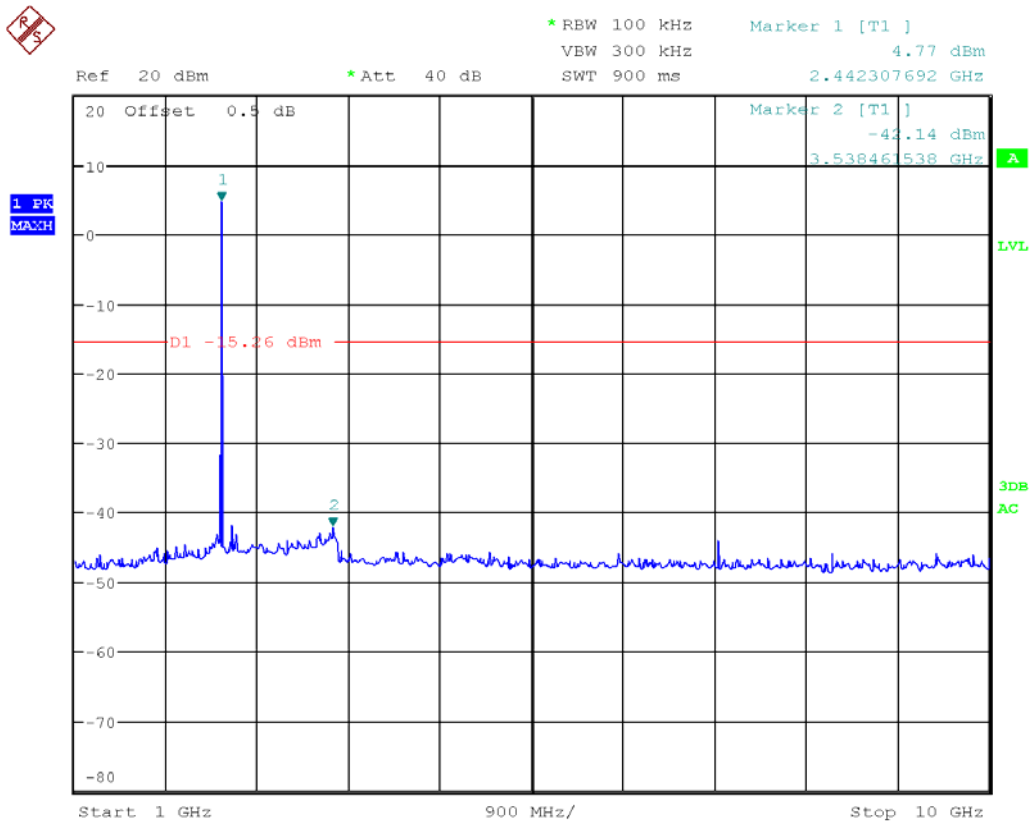

10G to 25GHz

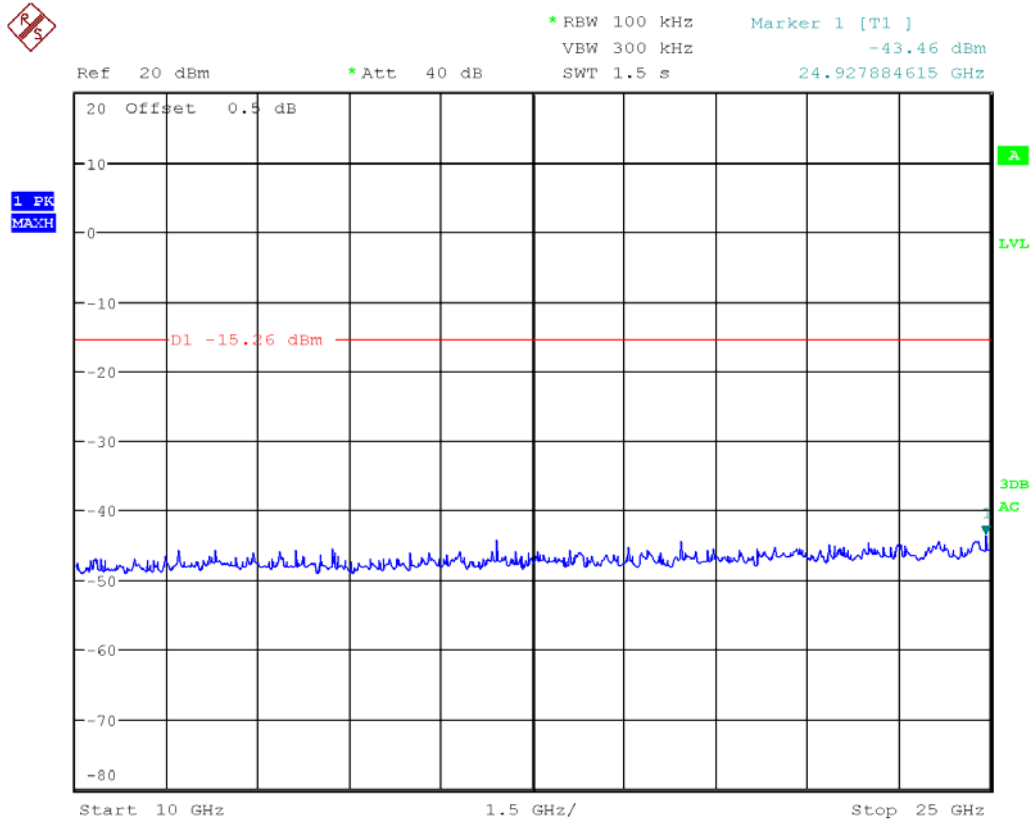

Highest Channel

30M to 1GHz

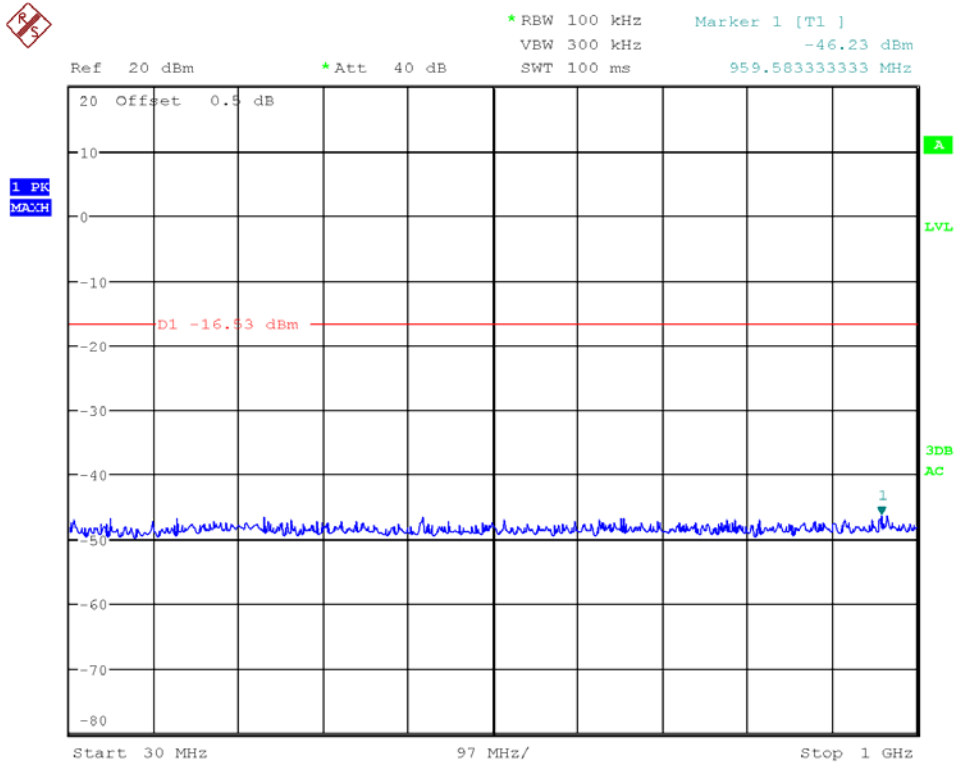

1G to 10GHz

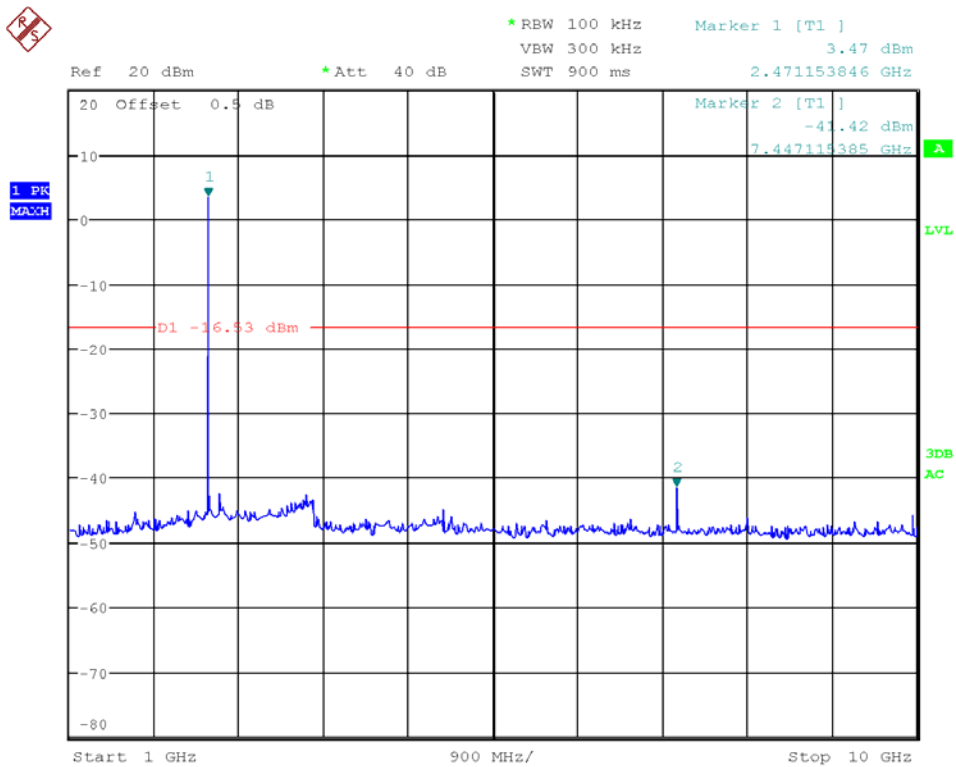

10G to 25GHz

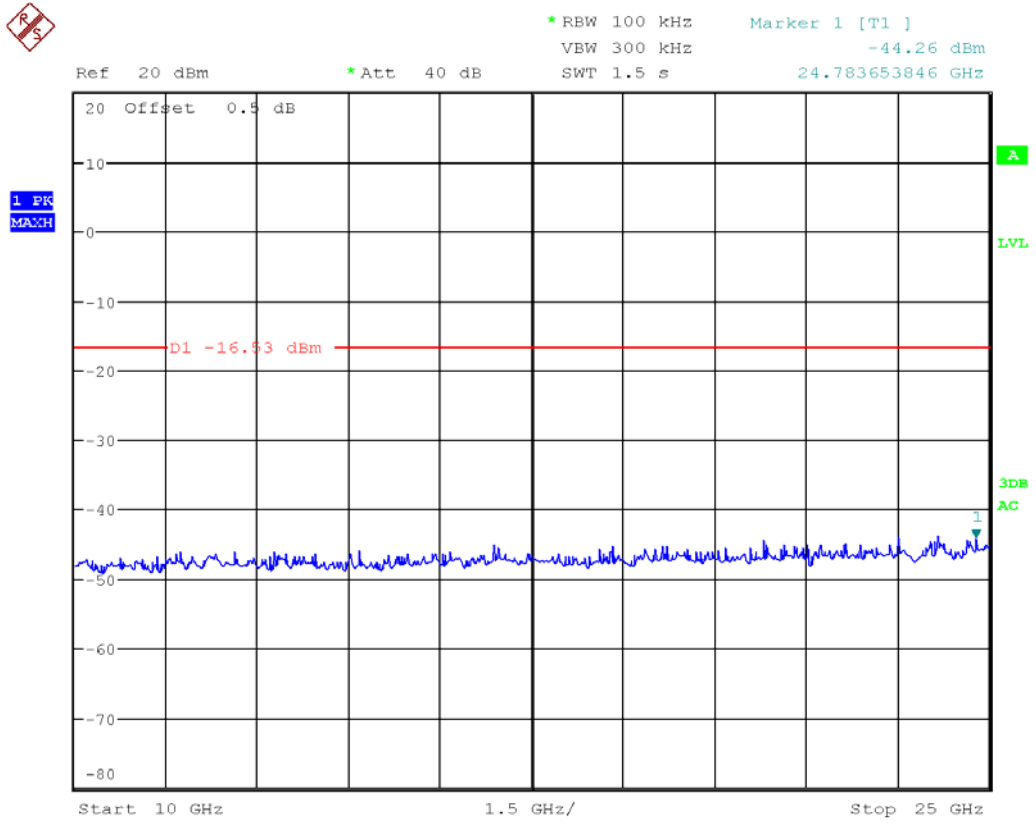

8DPSK

Lowest Channel:

30M to 1GHz

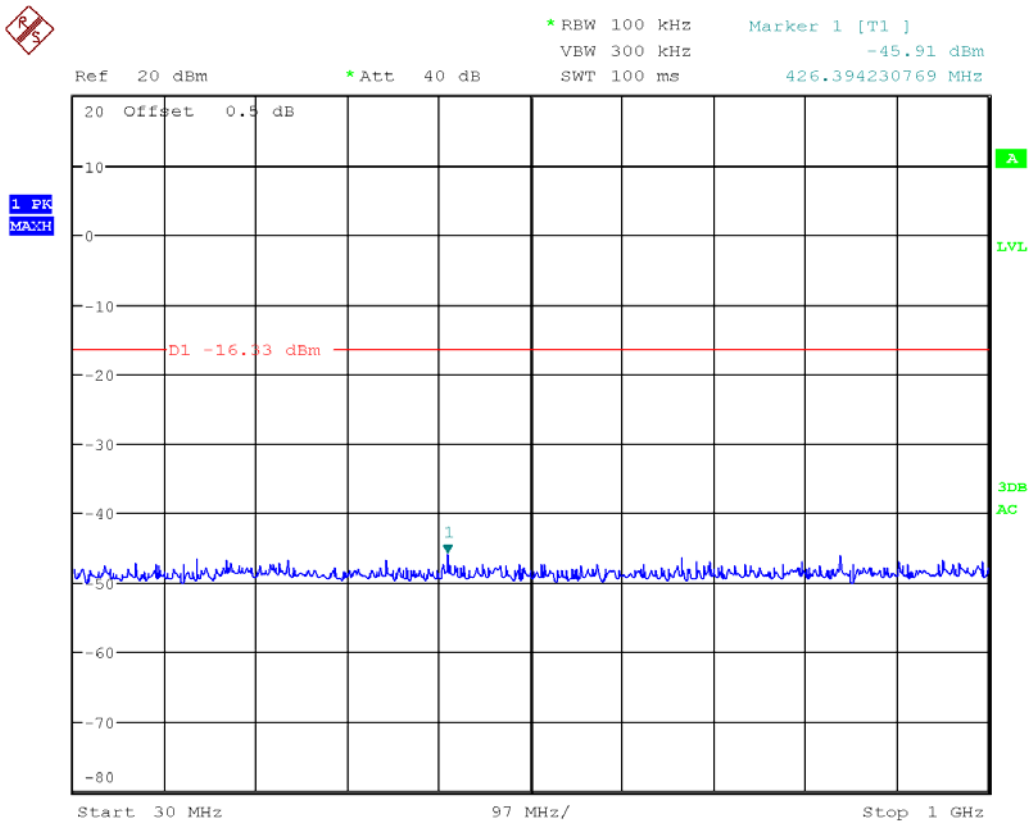

1G to 10GHz

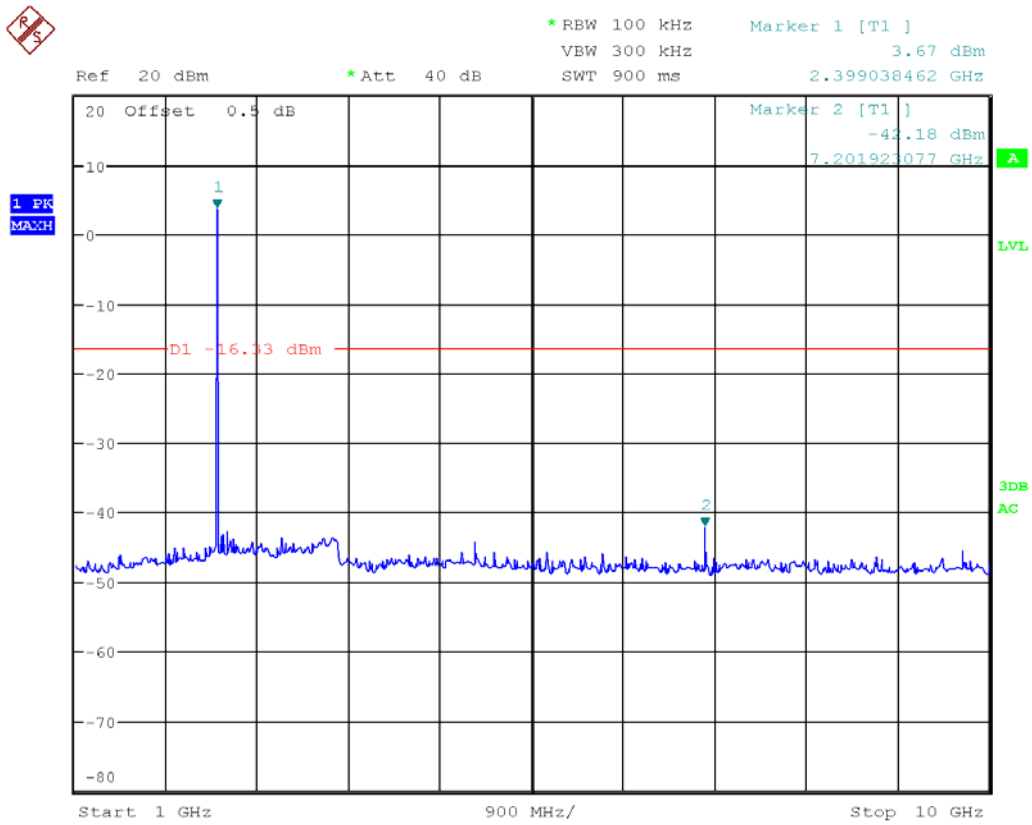

10G to 25GHz

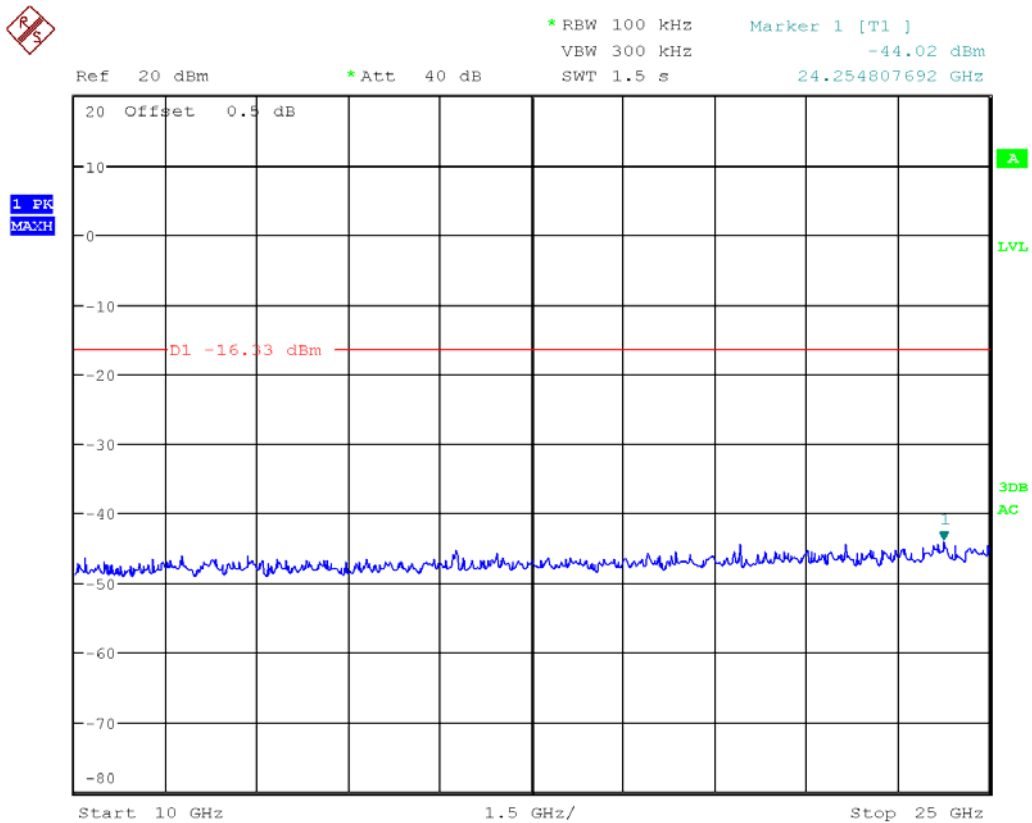

Middle Channel:

30M to 1GHz

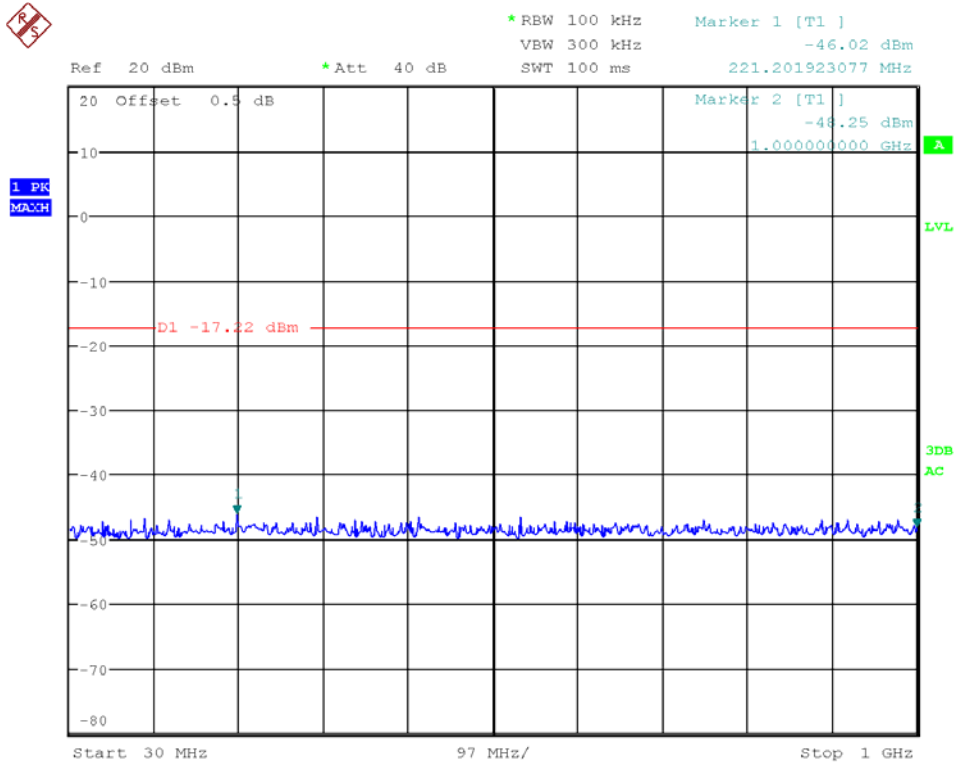

1G to 10GHz

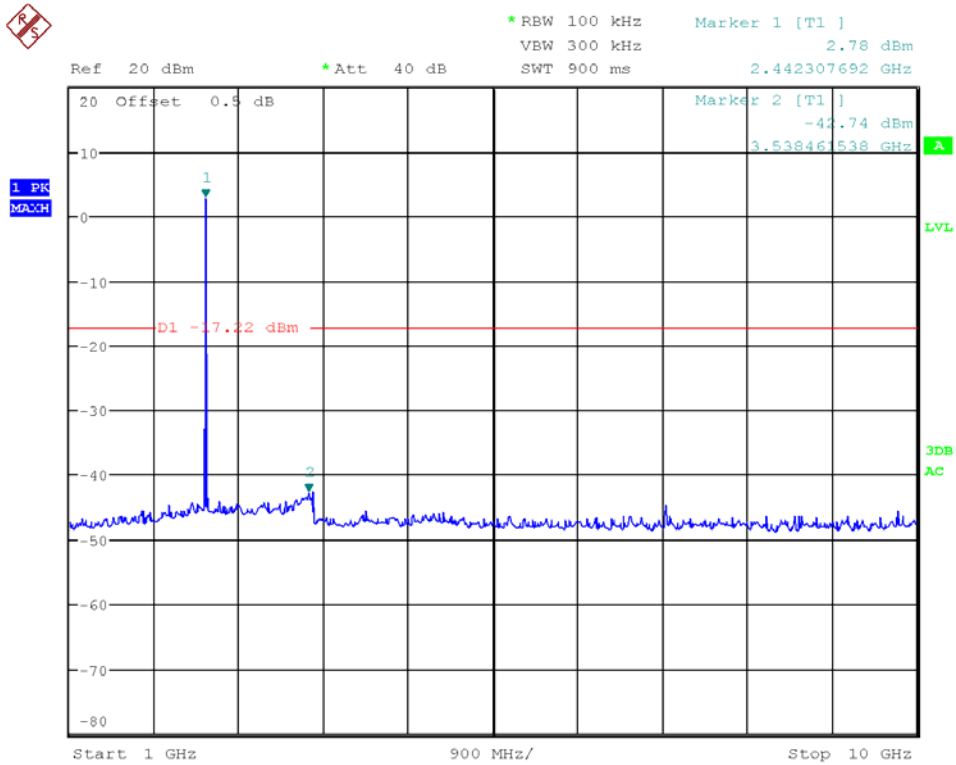

10G to 25GHz

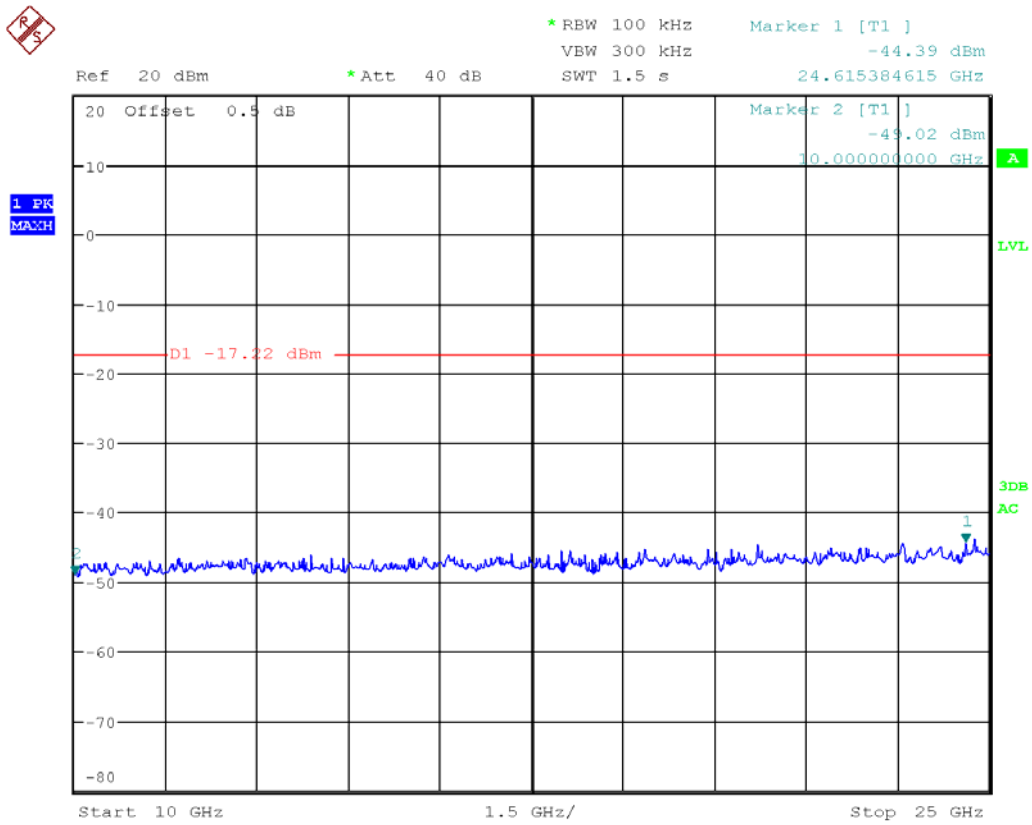

Highest Channel

30M to 1GHz

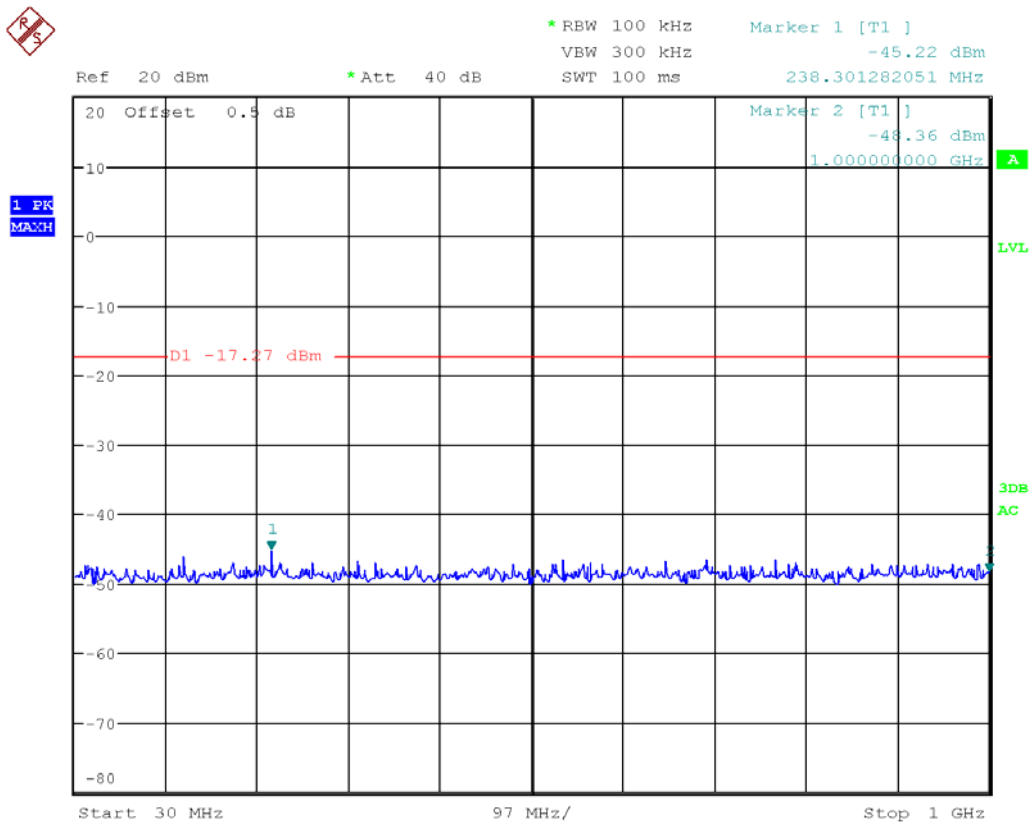

1G to 10GHz

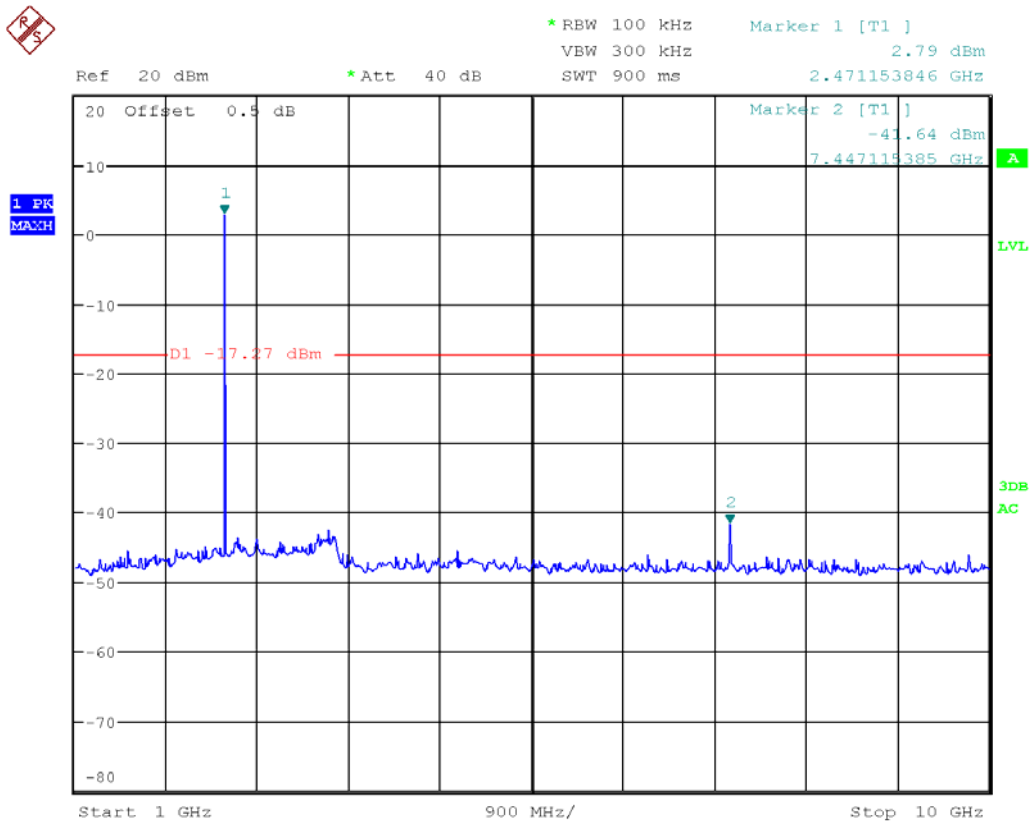

10G to 25GHz

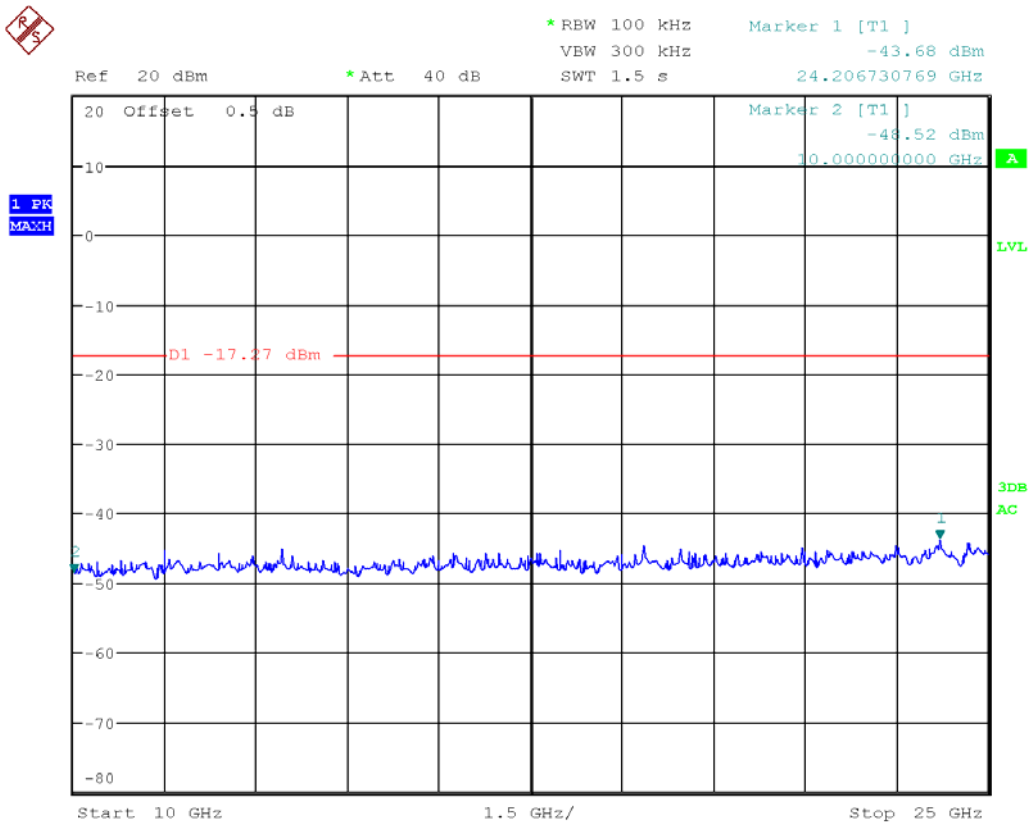

4.10 RADIATED SPURIOUS EMISSIONS

4.10.1 LIMITS

Frequency (MHz)	Quasi-peak(dBµV/m)
30 ~ 88	40
88~216	43.5
216 ~ 960	46
Above 960	54

NOTE: (1) The lower limit shall apply at the transition frequencies.

Frequency (GHz)	Quasi-peak(dBµV/m)
1 ~ 26.5	74
1~ 26.5	54

4.10.2 TEST PROCEDURES

Test procedures follow ANSI C63.4

Procedure of Preliminary Test

Radiated emission tests shall be made with the receive or transmit antenna located at a horizontal distance of 3 m plus half of the maximum width of the EUT being tested, measured from the centre of the EUT. The tests shall be performed with the equipment configured as closely as possible to its typical, practical operation. Unless stated otherwise, cables and wiring shall be as specified by the manufacturer and the equipment shall be in its housing (or cabinet) with all covers and access panels in place. Any deviation from normal EUT operating conditions shall be included in the test report.

The EUT (on a non-conductive support structure, where applicable) shall be placed on a remotely operated turntable, to allow the EUT to be rotated. The height of the EUT above the ground plane shall be according to the following requirements.

- Table-top equipment is placed on a non-conductive set-up table with height $0,8\text{ m} \pm 0,01\text{ m}$, ANSI C63.4 specifies the method to determine the impact of the non-conductive set-up table on test results.
- Floor-standing equipment is placed on a non-conductive support, as specified in the applicable product standard. If there are no EUT height placement requirements in the product standard, the EUT shall be placed on a non-conductive support at a height of 5 cm to 15 cm above the ground plane.

Interface cables, loads, and devices should be connected to at least one of each type of the interface ports of the EUT and, where practical, each cable shall be terminated in a device typical for its actual use. Where there are multiple interface ports of the same type, a typical number of these devices shall be connected to devices or loads. It is sufficient to connect only one of the loads, provided that it can be shown, for example by preliminary testing, that the connection of further ports would not significantly increase the level of disturbance (that is, more than 2 dB) or significantly degrade the immunity level.

The test mode(s) described in Item 2.4 were scanned during the preliminary test. After the preliminary scan, we found the test mode described in Item 2.4 producing the highest emission level. The EUT and cable configuration, antenna position, polarization and turntable position of the above highest emission level were recorded for the final test.

Procedure of Final Test

EUT and support equipment were set up on the turntable as per the configuration with highest emission level in the preliminary test. The Analyzer / Receiver scanned from 30MHz to 1000MHz. Emissions were scanned and measured rotating the EUT to 360 degrees, varying cable placement and positioning the antenna 1 to 4 meters above the ground plane, in both the vertical and the horizontal polarization, to maximize the emission reading level. Record at least six highest emissions. Emission frequency, amplitude, antenna position, polarization and turntable position were recorded into a computer in which correction factors were used to calculate the emission level and compare reading to the applicable limit and only QP reading is presented. The test data of the worst-case condition(s) was recorded.

Procedure of Final Test

EUT and support equipment were set up on the test bench as per the configuration with highest emission level in the preliminary test. A scan was taken on both power lines, recording at least the six highest emissions. Emission frequency and amplitude were recorded into a computer in which correction factors were used to calculate the emission level and compare reading to the applicable limit. The test data of the worst-case condition(s) was recorded.

Below 1GHz Set the spectrum analyzer: RBW =100KHz VBW \geq RBW , Span = enough to catch the trace. Sweep = auto; Detector Function = Peak. Trace = Max,hold.

Above 1GHz Set the spectrum analyzer: RBW =1MHz VBW \geq RBW , Span = enough to catch the trace. Sweep = auto; Detector Function = Peak. Trace = Max,hold.

Pre-test for normal mode and EDR mode, to find the EDR is the worst case.

The worst case emissions were reported.

4.10.3 TEST SETUP

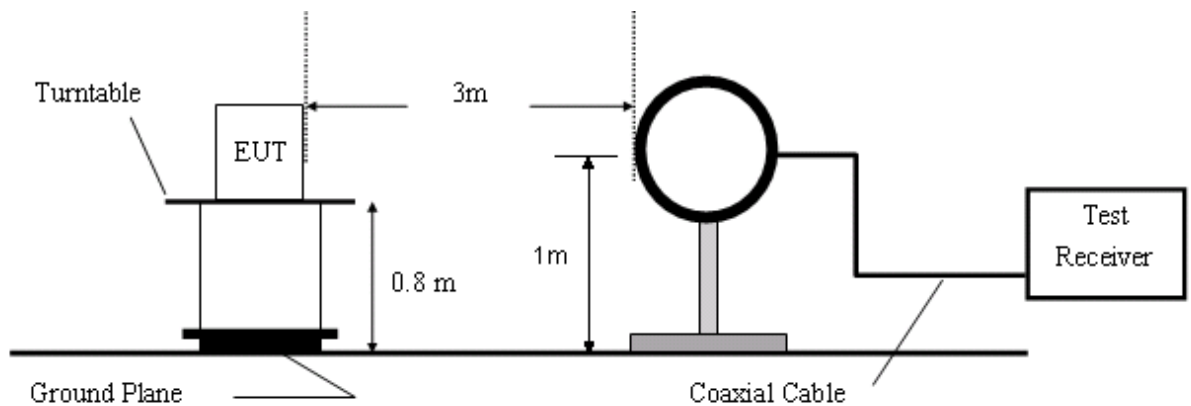

Figure 1. 9KHz to 30MHz radiated emissions test configuration

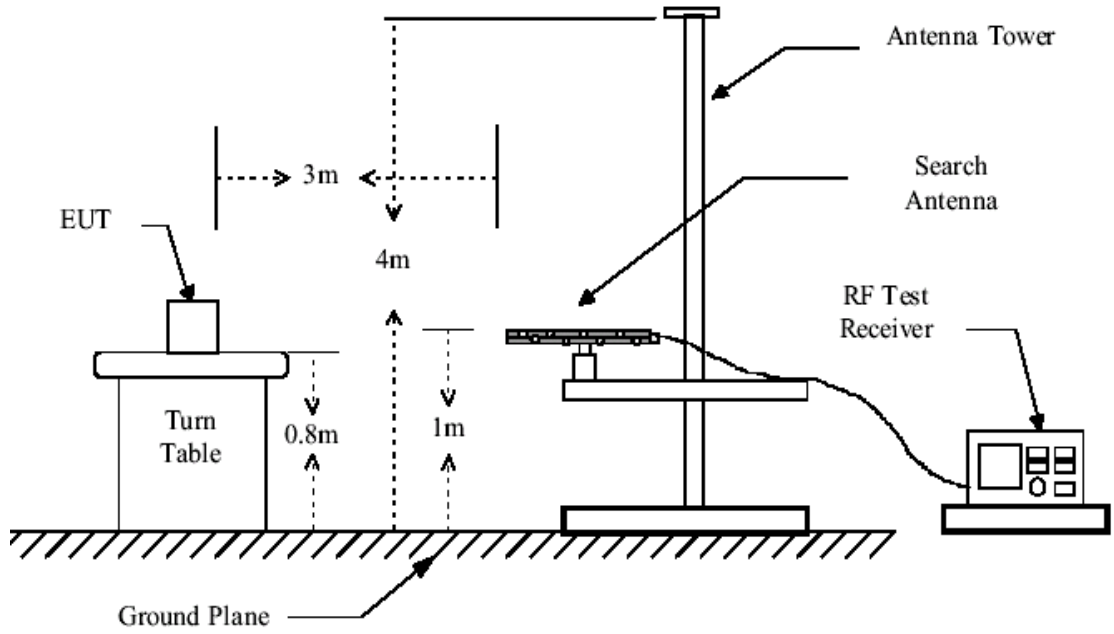

Figure 2. 30MHz to 1GHz radiated emissions test configuration

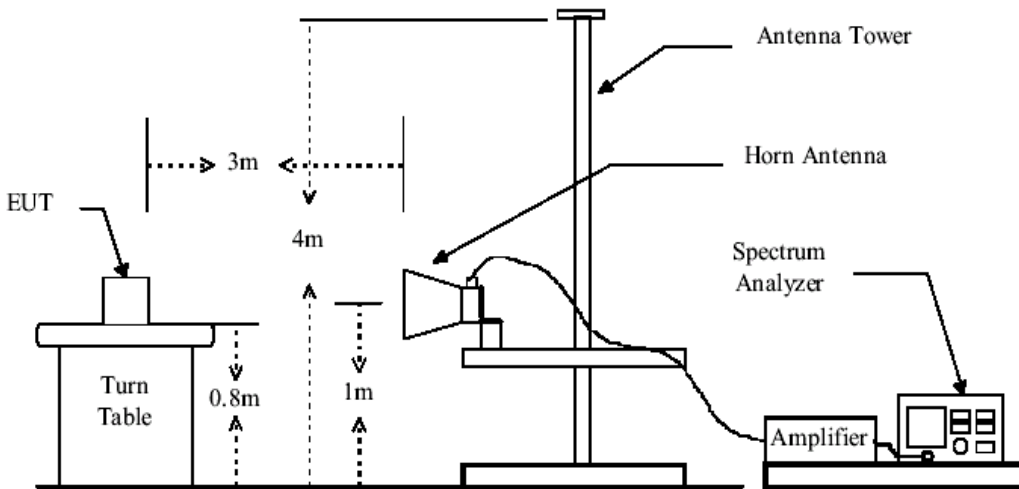

Figure 3. Above 1GHz radiated emissions test configuration

4.10.4 TEST RESULTS

1. Low Frequency 2402MHz

30MHz~1GHz Spurious Emissions .Quasi-Peak Measurement

No.	Frequency (MHz)	Reading (dBuV/m)	Correct Factor(dB/m)	Result (dBuV/m)	Limit (dBuV/m)	Over Limit (dB)	Antenna polarization
1	32.4555	16.48	17.92	34.40	40.00	-5.60	Vertical
2	35.5088	18.73	16.07	34.80	40.00	-5.20	Vertical
3	37.1416	17.44	15.06	32.50	40.00	-7.50	Vertical
4	61.5895	27.03	7.97	35.00	40.00	-5.00	Vertical
5	78.8659	23.44	8.46	31.90	40.00	-8.10	Vertical
6	780.9397	11.88	24.72	36.60	46.00	-9.40	Vertical
7	36.1125	9.51	15.69	25.20	40.00	-14.80	Horizontal
8	60.9012	17.11	7.99	25.10	40.00	-14.90	Horizontal
9	200.4536	28.80	11.40	40.20	43.50	-3.30	Horizontal
10	208.4958	24.04	11.86	35.90	43.50	-7.60	Horizontal
11	671.0019	18.87	23.43	42.30	46.00	-3.70	Horizontal
12	780.9397	9.38	24.72	34.10	46.00	-11.90	Horizontal

1~25 GHz Harmonics & Spurious Emissions. Peak & Average Measurement

Peak Measurement:

No.	Frequency (MHz)	Reading (dBuV/m)	Correct Factor(dB/m)	Result (dBuV/m)	Limit (dBuV/m)	Over Limit (dB)	Antenna polarization
1	1602.941	41.62	2.49	44.11	74.00	-29.89	Horizontal
2	2403.142	46.40	5.52	51.92	74.00	-22.08	Horizontal
3	1602.941	38.98	2.49	41.47	74.00	-32.53	Vertical
4	2403.142	41.48	5.52	47.00	74.00	-27.00	Vertical

AV Measurement:

No.	Frequency (MHz)	Reading (dBuV/m)	Correct Factor(dB/m)	Result (dBuV/m)	Limit (dBuV/m)	Over Limit (dB)	Antenna polarization
1	1602.941	40.35	2.49	42.84	54.00	-11.16	Horizontal
2	2403.142	43.36	5.52	48.88	54.00	-5.12	Horizontal
3	1602.941	37.65	2.49	40.14	54.00	-13.86	Vertical
4	2403.142	38.40	5.52	43.92	54.00	-10.08	Vertical

The field strength is calculated by adding the Antenna Factor. Correct Factor.

The basic equation with a sample calculation is as follows:

Final Test Level =Receiver Reading + Correct Factor

2. Middle Frequency 2441MHz

30MHz~1GHz Spurious Emissions .Quasi-Peak Measurement

No.	Frequency (MHz)	Reading (dBuV/m)	Correct Factor(dB/m)	Result (dBuV/m)	Limit (dBuV/m)	Over Limit (dB)	Antenna polarization
1	34.3316	15.00	16.80	31.80	40.00	-8.20	Vertical
2	36.1125	18.21	15.69	33.90	40.00	-6.10	Vertical
3	37.9859	17.15	14.55	31.70	40.00	-8.30	Vertical
4	60.2205	26.69	8.01	34.70	40.00	-5.30	Vertical
5	620.2354	13.19	22.71	35.90	46.00	-10.10	Vertical
6	914.0119	12.28	26.12	38.40	46.00	-7.60	Vertical
7	36.3161	8.14	15.56	23.70	40.00	-16.30	Horizontal
8	60.2205	17.29	8.01	25.30	40.00	-14.70	Horizontal
9	181.1693	24.19	11.11	35.30	43.50	-8.20	Horizontal
10	200.4536	28.80	11.40	40.20	43.50	-3.30	Horizontal
11	288.8332	20.69	14.71	35.40	46.00	-10.60	Horizontal
12	620.2354	10.18	22.72	32.90	46.00	-13.10	Horizontal

1~25 GHz Harmonics & Spurious Emissions. Peak & Average Measurement

Peak Measurement:

No.	Frequency (MHz)	Reading (dBuV/m)	Correct Factor(dB/m)	Result (dBuV/m)	Limit (dBuV/m)	Over Limit (dB)	Antenna polarization
1	1628.542	42.05	2.57	44.62	74.00	-29.39	Horizontal
2	2441.524	44.27	5.71	49.98	74.00	-24.02	Horizontal
3	1628.542	40.02	2.57	42.59	74.00	-31.41	Vertical
4	2441.524	41.52	5.71	47.23	74.00	-26.77	Vertical

AV Measurement:

No.	Frequency (MHz)	Reading (dBuV/m)	Correct Factor(dB/m)	Result (dBuV/m)	Limit (dBuV/m)	Over Limit (dB)	Antenna polarization
1	1628.542	41.12	2.57	43.69	54.00	-10.31	Horizontal
2	2441.524	42.43	5.71	48.14	54.00	-5.86	Horizontal
3	1628.542	37.50	2.57	40.07	54.00	-13.93	Vertical
4	2441.524	38.87	5.71	44.58	54.00	-9.42	Vertical

The field strength is calculated by adding the Antenna Factor. Correct Factor.

The basic equation with a sample calculation is as follows:

Final Test Level =Receiver Reading + Correct Factor

3. High Frequency 2480MHz

30MHz~1GHz Spurious Emissions .Quasi-Peak Measurement

No.	Frequency (MHz)	Reading (dBuV/m)	Correct Factor(dB/m)	Result (dBuV/m)	Limit (dBuV/m)	Over Limit (dB)	Antenna polarization
1	31.9129	18.95	18.25	37.20	40.00	-2.80	Vertical
2	37.9859	21.35	14.55	35.90	40.00	-4.10	Vertical
3	60.2205	28.49	8.01	36.50	40.00	-3.50	Vertical
4	200.4536	20.90	11.40	32.30	43.50	-11.20	Vertical
5	671.0019	12.17	23.43	35.60	46.00	-10.40	Vertical
6	914.0119	10.58	26.12	36.70	46.00	-9.30	Vertical
7	33.0073	10.60	17.60	28.20	40.00	-11.80	Horizontal
8	76.6808	18.14	8.26	26.40	40.00	-13.60	Horizontal
9	132.2562	18.31	8.79	27.10	43.50	-16.40	Horizontal
10	288.8332	17.09	14.71	31.80	46.00	-14.20	Horizontal

1~25 GHz Harmonics & Spurious Emissions. Peak & Average Measurement

Peak Measurement:

No.	Frequency (MHz)	Reading (dBuV/m)	Correct Factor(dB/m)	Result (dBuV/m)	Limit (dBuV/m)	Over Limit (dB)	Antenna polarization
1	1654.553	41.76	2.66	44.42	74.00	-29.58	Horizontal
2	2480.519	43.19	5.88	49.07	74.00	-24.93	Horizontal
3	1654.553	39.64	2.66	42.30	74.00	-31.70	Vertical
4	2480.519	42.06	5.88	47.94	74.00	-26.06	Vertical

AV Measurement:

No.	Frequency (MHz)	Reading (dBuV/m)	Correct Factor(dB/m)	Result (dBuV/m)	Limit (dBuV/m)	Over Limit (dB)	Antenna polarization
1	1654.553	40.34	2.66	43.00	54.00	-11.00	Horizontal
2	2480.519	41.56	5.88	47.44	54.00	-6.56	Horizontal
3	1654.553	38.23	2.66	40.89	54.00	-13.11	Vertical
4	2480.519	40.21	5.88	46.09	54.00	-7.91	Vertical

The field strength is calculated by adding the Antenna Factor. Correct Factor.

The basic equation with a sample calculation is as follows:

Final Test Level =Receiver Reading + Correct Factor

Remark: No any other emissions level which are attenuated less than 20dB below the limit.

According to 15.31(o), The amplitude of spurious emissions from intentional radiators and emissions from unintentional radiators which are attenuated more than 20 dB below the permissible value need not be reported unless specifically required elsewhere in this Part.

Hence there no other emissions have been reported.

Remark:

- 1). N/A: For this intentional radiator operates below 25 GHz. The spectrum shall be investigated to the tenth harmonic of the highest fundamental frequency. And above the third harmonic of this intentional radiator, the disturbance is very low. So the test result only displays to 3rd

harmonic.

- 2). As shown in Section, for frequencies above 1000 MHz. the above field strength limits are based on average limits. However, the peak field strength of any emission shall not exceed the maximum permitted average limits specified above by more than 20 dB under any condition of modulation.
- 3). The test only perform the EUT in transmitting status since the test frequencies were over 1GHz only required transmitting status.

Test result: The unit does meet the requirements.

4.11 BAND EDGES REQUIREMENT

4.11.1 LIMITS

Section 15.247 (d) In any 100 kHz bandwidth outside the frequency band in which the spread spectrum or digitally modulated intentional radiator is operating, the radio frequency power that is produced by the intentional radiator shall be at least 20 dB below that in the 100 kHz bandwidth within the band that contains the highest level of the desired power, based on either an RF conducted or a radiated measurement, provided the transmitter demonstrates compliance with the peak conducted power limits. If the transmitter complies with the conducted power limits based on the use of RMS averaging over a time interval, as permitted under paragraph (b)(3) of this section, the attenuation required under this paragraph shall be 30 dB instead of 20 dB. Attenuation below the general limits specified in Section 15.209(a) is not required.

4.11.2 TEST PROCEDURES

Test procedures follow ANSI C63.4

Check the calibration of the measuring instrument using either an internal calibrator or a known signal from an external generator.

Position the EUT without connection to measurement instrument. Turn on the EUT and connect its antenna terminal to measurement instrument via a low loss cable. Then set it to any one measured frequency within its operating range, and make sure the instrument is operated in its linear range. Set RBW to 100 kHz and VBW of spectrum analyzer to 300 kHz with a convenient frequency span including 100 kHz bandwidth from band edge.

Note: For Restricted Band

RBW=100 kHz

VBW=300 kHz

Measure the highest amplitude appearing on spectral display and set it as a reference level. Plot the graph with marking the highest point and edge frequency.

Repeat above procedures until all measured frequencies were complete.

4.11.3 TEST SETUP

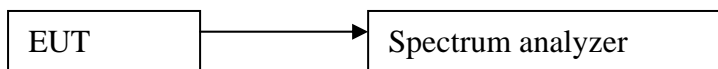

4.11.4 TEST RESULTS

For GFSK

Lowest Channel

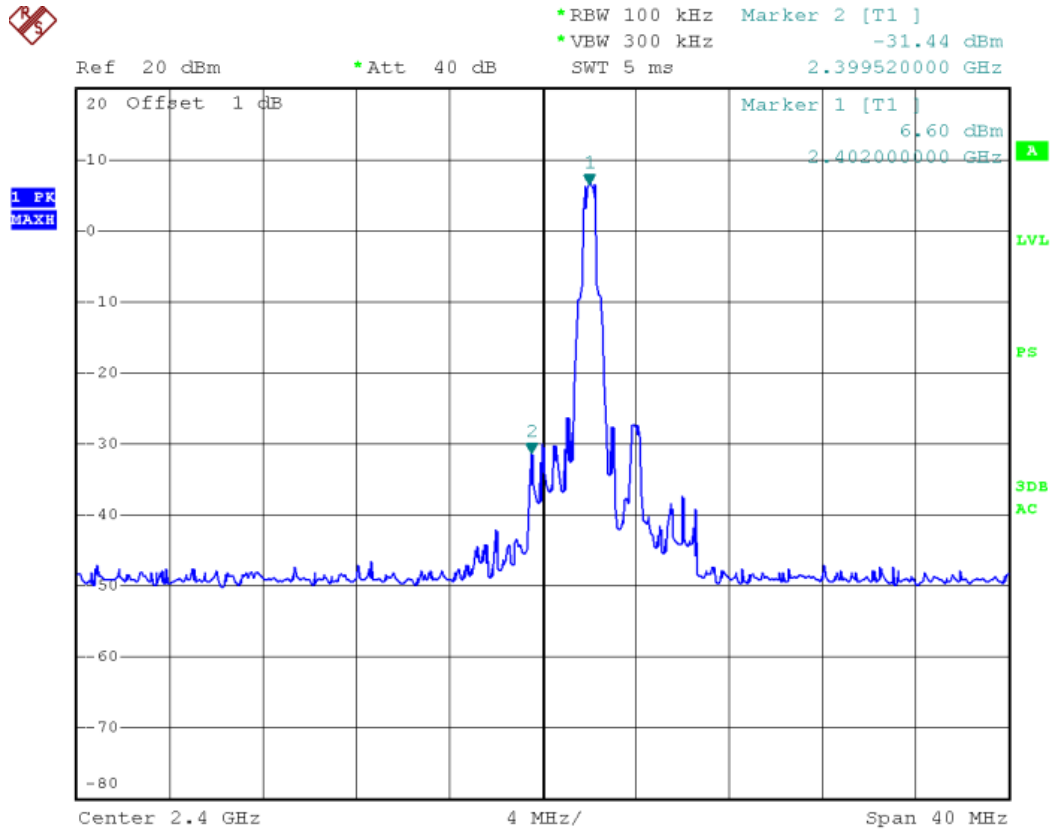

Highest Channel

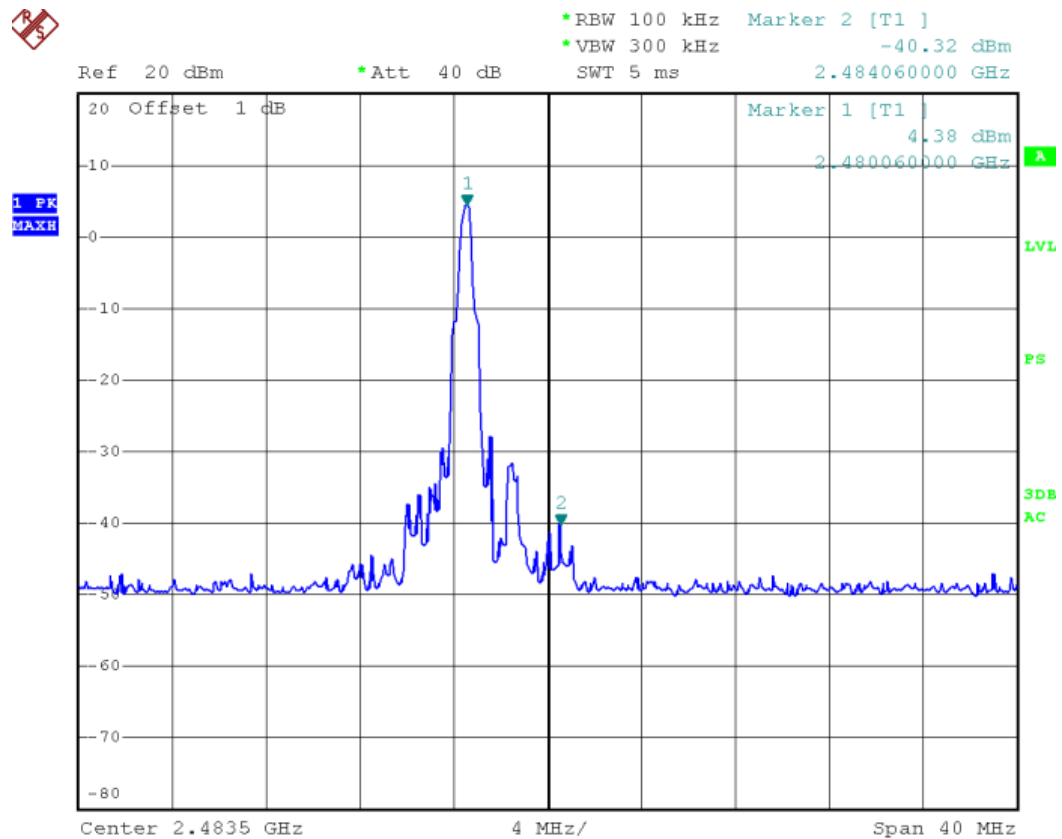

For 8DPSK

Lowest Channel

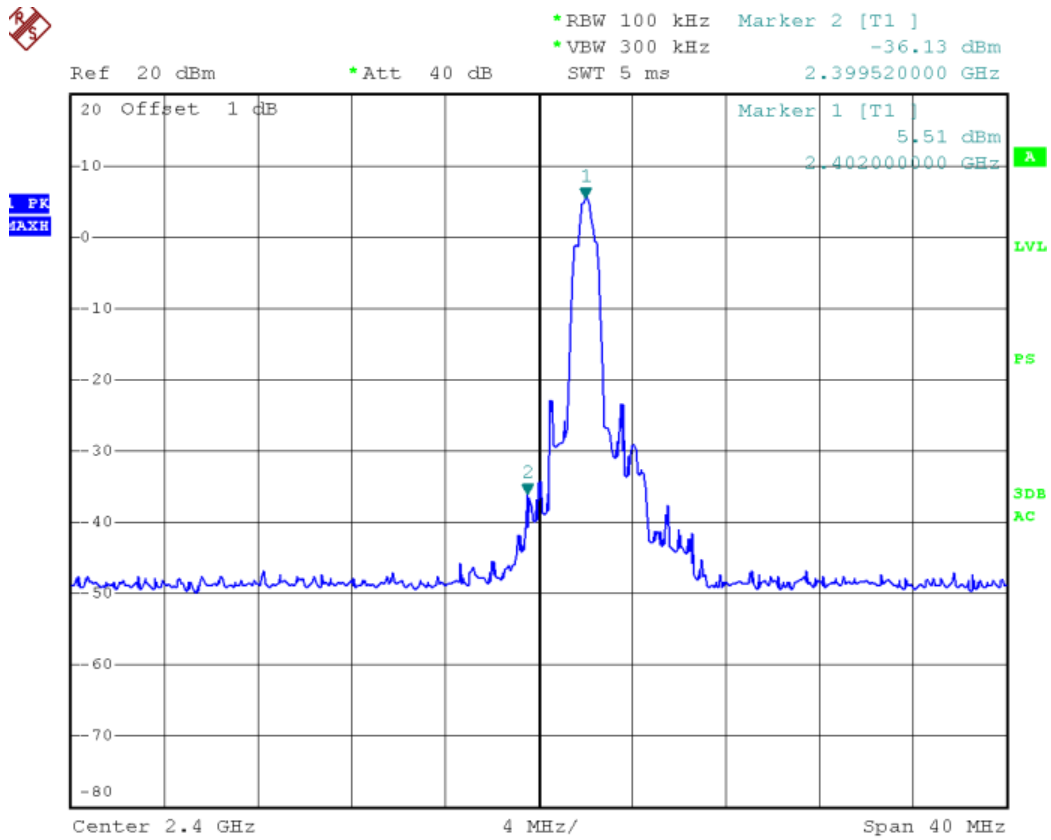

Highest Channel

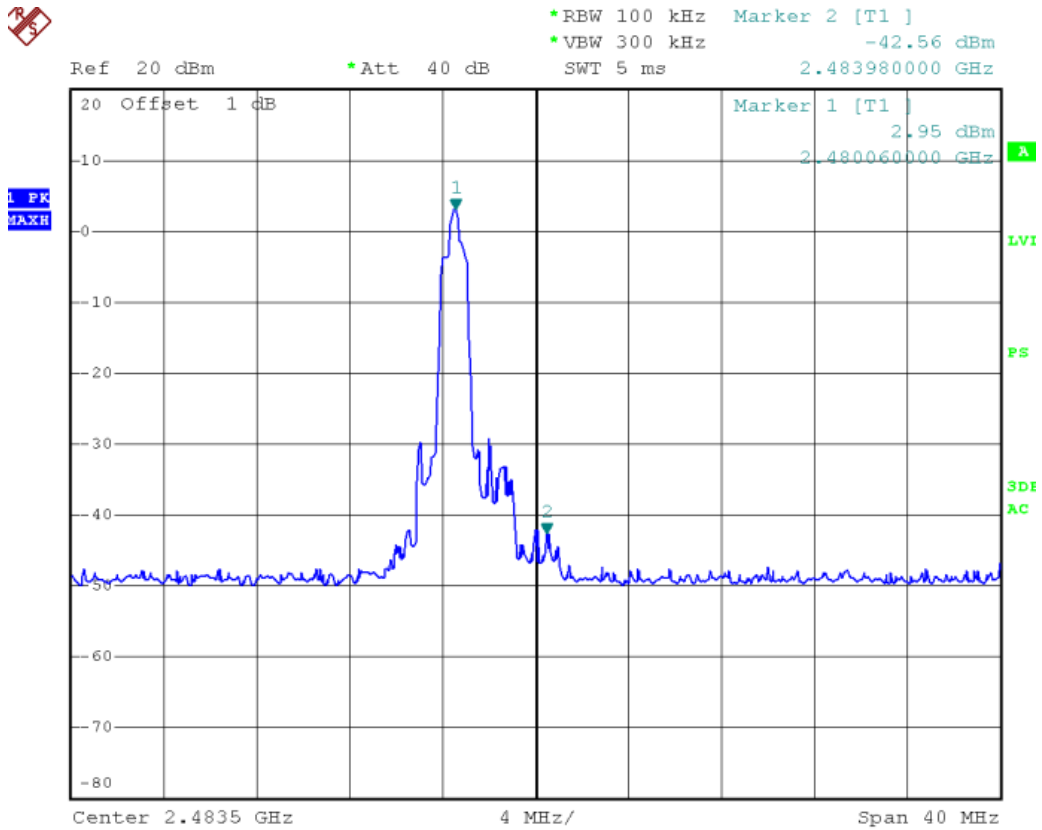

Radiated Emissions which fall in the restricted bands

Test Requirement: Section 15.247(d) In addition, radiated emissions which fall in the restricted bands, as defined in Section 15.205(a), must also comply with the radiated emission limits specified in Section 15.209(a) (see Section 15.205(c)).

Test Method: Base on ANSI 63.10

Test Date: 2012-07-9

Measurement Distance: 3m (Semi-Anechoic Chamber)

Limit: 40.0 dB μ V/m between 30MHz & 88MHz;
43.5 dB μ V/m between 88MHz & 216MHz;
46.0 dB μ V/m between 216MHz & 960MHz;
54.0 dB μ V/m above 960MHz.

Detector: Peak for pre-scan:
100kHz resolution bandwidth and 100kHz video bandwidth within 1GHz.
1MHz resolution bandwidth and 1MHz video bandwidth above 1GHz

Section 15.205 Restricted bands of operation.

(a) Except as shown in paragraph (d) of this section. only spurious emissions are permitted in any of the frequency bands listed below:

MHz	MHz	MHz	GHz
0.090 - 0.110	16.42 - 16.423	399.9 - 410	4.5 - 5.15
¹ 0.495 - 0.505	16.69475 -	608 - 614	5.35 - 5.46
2.1735 - 2.1905	16.69525	960 - 1240	7.25 - 7.75
4.125 - 4.128	16.80425 -	1300 - 1427	8.025 - 8.5
4.17725 - 4.17775	16.80475	1435 - 1626.5	9.0 - 9.2
4.20725 - 4.20775	25.5 - 25.67	1645.5 - 1646.5	9.3 - 9.5
6.215 - 6.218	37.5 - 38.25	1660 - 1710	10.6 - 12.7
6.26775 - 6.26825	73 - 74.6	1718.8 - 1722.2	13.25 - 13.4
6.31175 - 6.31225	74.8 - 75.2	2200 - 2300	14.47 - 14.5
8.291 - 8.294	108 - 121.94	2310 - 2390	15.35 - 16.2
8.362 - 8.366	123 - 138	2483.5 - 2500	17.7 - 21.4
8.37625 - 8.38675	149.9 - 150.05	2655 - 2900	22.01 - 23.12
8.41425 - 8.41475	156.52475 -	3260 - 3267	23.6 - 24.0
12.29 - 12.293	156.52525	3332 - 3339	31.2 - 31.8
12.51975 -	156.7 - 156.9	3345.8 - 3358	36.43 - 36.5
12.52025	162.0125 - 167.17	3600 - 4400	
12.57675 -	167.72 - 173.2		
12.57725	240 - 285		
13.36 - 13.41	322 - 335.4		

Test Result:

Pretest the Bluetooth normal mode and EDR mode , record EDR mode date

The field strength was measured with an EMI measuring receiver and 1 MHz RBW / VBW for peak and with 1MHz RBW / 10Hz VBW for average at a distance of 3m.

Max field strength in 3m distance:

Horizontal :

No.	Frequency	PK Reading	AV Reading	Correct	Peak	Average
	(MHz)	(dBuV/m)	(dBuV/m)	Factor(dB/m)	(dBuV/m)	(dBuV/m)
1	2390.000	37.68	35.05	5.88	43.56	40.93
2	2483.500	36.13	33.82	5.02	41.15	38.84

Vertical :

No.	Frequency	PK Reading	AV Reading	Correct	Peak	Average
	(MHz)	(dBuV/m)	(dBuV/m)	Factor(dB/m)	(dBuV/m)	(dBuV/m)
1	2390.000	39.96	37.26	5.88	45.84	43.14
2	2483.500	39.45	36.81	5.02	44.47	41.83

Remark: No any other emission which fall in restricted bands can be detected and be reported.

-----This is the last page of the report. -----