

Nemko Korea Co., Ltd.

155 & 159, Osan-Ro, Mohyeon-Myeon, Cheoin-Gu, Yongin-Si, Gyeonggi-Do, 449-852 KOREA, REPUBLIC OF

TEL:+82 31 330 1700 FAX:+82 31 330 2332

FCC and IC EVALUATION REPORT FOR CERTIFICATION

Applicant :

Harman International Industries, Incorporated.

8500 Balboa Blvd., Northridge, CA91329,

USA

Attn. : Mr. Fernando Reyes

Dates of Issue : January 2, 2013

Test Report No. : NK-12-R-206

Test Site : Nemko Korea Co., Ltd.

FCC ID
IC

Brand Name

Contact Person

**APIAVR1710AN
6132A-AVR1710AN**

Harman Kardon

**Harman International Industries, Incorporated.
8500 Balboa Blvd., Northridge, CA91329, USA****Mr. Fernando Reyes
Telephone No. : 818-895-8173**

Applied Standard: FCC 47 CFR Part 15C and IC RSS-210
Classification: FCC Part 15 Spread Spectrum Transmitter (DSS)
EUT Type: AV Receiver

The device bearing the brand name and model specified above has been shown to comply with the applicable technical standards as indicated in the measurement report and was tested in accordance with the measurement procedures specified in ANSI C63.4-2003, ANSI C63.10. The client should not use it to claim product endorsement by TAF or any government agencies. The test results in the report only apply to the tested sample.

I attest to the accuracy of data and all measurements reported herein were performed by me or were made under my supervision and are correct to the best of my knowledge and belief. I assume full responsibility for the completeness of these measurements and vouch for the qualifications of all persons taking them.

Jan. 2, 2013Tested By : Minchul, Shin
Engineer
Jan. 2, 2013Reviewed By : Deokha Ryu
Manager & Chief Engineer

TABLE OF CONTENTS

1.	Scope	4
2.	Introduction (Site Description)	5
	2.1 Test facility	5
	2.2 Accreditation and listing	6
3.	Test Conditions & EUT Information	7
	3.1 Operation During Test	7
	3.2 Support Equipment	7
	3.3 Port of the EUT	8
	3.3 Setup Drawing	8
	3.4 EUT Information	9
4.	Summary of Test Results	10
5.	Recommendation / Conclusion	11
6.	Antenna Requirements	11
7.	Description of Test	12
	7.1 Conducted Emissions	12
	7.2 Radiated Emissions	13
	7.3 20 dB Bandwidth and Carrier Frequency Separation	14
	7.4 Transmitter Average Time of Occupancy	14
	7.5 Number of Hopping Channels	15
	7.6 Maximum Peak Output Power	15
	7.7 Conducted Spurious Emissions	16
8.	Test Data	17
	8.1 Conducted Emissions	17
	8.2 Radiated Emissions	20
	8.3 20 dB Modulated Bandwidth	21

8.4 Carrier Frequency Separation	27
8.5 Transmitter Average Time of Occupancy	30
8.6 Number of Hopping Channels	31
8.7 Peak Power Output	33
8.8 Conducted Spurious Emissions	39
8.9 Radiated Spurious Emissions	55
8.10 Radiated Restricted Band Edge	58
9. Test Equipment	60
10 Accuracy of Measurement	61
Appendix A: Labeling Requirement	63
Appendix B: Photographs of Test Set-up	64
Appendix C: EUT Photographs	66
Appendix D: Maximum Permissible Exposure	76

1. SCOPE

Measurement and determination of electromagnetic emissions (EME) of radio frequency devices including intentional and/or unintentional radiators for compliance with the technical rules and regulations of the Federal Communications Commission under FCC part 15 and IC RSS-210 Issue 8.

Responsible Party :	Harman International Industries, Incorporated.
Contact Person :	Mr. Femando, Reyes
Manufacturer :	Harman International Industries, Incorporated 8500 Balboa Blvd., Northridge, CA 91329, USA

- FCC ID: APIAVR1710AN
- IC: 6132A-AVR1710AN
- Model: AVR1710
- Brand Name: Harman Kardon
- EUT Type: AV Receiver
- Classification: 15C Intentional Radiator
- Applied Standard: FCC 47 CFR Part 15 subpart C and IC RSS-210 Issue 8
- Test Procedure(s): ANSI C63.4-2003, ANSI C63.10 and FCC Public Notice DA 00-705 dated March 30, 2000 entitled "Filling and Measurement Guidelines for Frequency Hopping Spread Spectrum Systems"
- Dates of Test: November 12, 2012 ~ November 22, 2012
- Place of Tests: Nemko Korea Co., Ltd.

2. INTRODUCTION

2.1 Test facility

The measurement procedure described in American National Standard for Methods of Measurement of Radio-Noise Emissions from Low-Voltage Electrical and Electronic Equipment in the Range of 9 kHz to 40 GHz (ANSI C63.4-2003) was used in determining radiated and conducted emissions emanating from **Harman International Industries, Incorporated.**

FCC ID : **APIAVR1710AN** and IC : **6132A-AVR1710AN**

These measurement tests were conducted at **Nemko Korea Co., Ltd. EMC Laboratory.**

The site address is 155 & 159, Osan-Ro, Mohyeon-Myeon, Cheoin-Gu, Yongin-Si, Gyeonggi-Do, 449-852 KOREA, REPUBLIC OF.

The area of Nemko Korea Corporation Ltd. EMC Test Site is located in a mountain area at 80 kilo-meters (48 miles) southeast and Incheon International Airport (Incheon Airport), 30 kilometers (18 miles) south-southeast from central Seoul.

It is located in the valley surrounded by mountains in all directions where ambient radio signal conditions are quiet and a favorable area to measure the radio frequency interference on open field test site for the computing and ISM devices manufactures.

The detailed description of the measurement facility was found to be in compliance with the requirements of §2.948 according to ANSI C63.4 2003.







Nemko Korea Co., Ltd.
EMC Lab.

155 & 159, Osan-Ro, Mohyeon-Myeon, Cheoin-Gu, Yongin-Si, Gyeonggi-Do, 449-852 KOREA, REPUBLIC OF
Tel)+82-31-330-1700
Fax)+82-31-322-2332

Fig. 1. The map above shows the Seoul in Korea vicinity area.
The map also shows Nemko Korea Corporation Ltd. EMC Lab. and Incheon Airport.

2.2 Accreditation and listing

Accreditation type		Accreditation number
	FCC part 15/18 Filing site	Registration No. 97992
	CAB Accreditation for DOC	Designation No. KR0026
	KOLAS Accredited Lab. (Korea Laboratory Accreditation Scheme)	Registration No. 155
	Canada IC Registered site	Site No. 2040E
	VCCI registration site(RE/CE/Telecom CE)	Member No. 2118
	EMC CBTL	-
	KCC(RRL)Designated Lab.	Registration No. KR0026
	SASO registered Lab and Certification Body	Registration No. 2008-15

3. TEST CONDITIONS & EUT INFORMATION

3.1 Operation During Test

The Laptop and Test Jig were used to control the EUT to transmit the wanted TX channel by the Bluetest testing program which manufacturer supported. The Laptop and test jig were removed after controlling the EUT to transmit the wanted signal. The EUT was tested at the lowest channel, middle channel and the highest channel with the maximum output power in accordance with the manufacturer's specifications. The worst data were recorded in the report.

The EUT is programmed with the following setting during the testing:

Test frequency	2402 MHz	2441 MHz	2480 MHz
Ext. Power	255	255	255
Int. Power	30	30	30

3.2 Support Equipment

AV Receiver (EUT)	Harman International Industries, Incorporated. Model: AVR1710	FCC ID : APIAVR1710AN S/N: N/A
Laptop PC	Samsung Electronics Co., Ltd. Model : NT-R520 0.15 m UART to USB shielded conversion cable	FCC DOC S/N: ZK6V93FS800012Y
a.c.-d.c. Adaptor	Chicony Power Technology Co., Ltd. Model : AD-6019R 1.5 m unshielded power cable	FCC DOC S/N: CNBA440024ADON897I2602
Monitor	LG Electronic Nanjing Display Co., Ltd. Model : W2261VT	FCC DOC S/N: 002NDWE4W489
Headphone	PHILIPS Model : SHP2000	S/N: N/A
Load	RARA Model : IRF500S	S/N: N/A

3.3 Port of the EUT

Port	Quantity (ea.)
Headphone	1
USB	1
RJ-45	1
Analog In LR	2
Analog Out LR	1
Subwoofer	2
Coaxial	1
Optical	1
IR In	1
TRIGGER Out	1
Video In	2
Monitor Out	1
HDMI Out	2
HDMI In	6
Speaker	7
FM, AM Antenna	1

3.4 Setup Drawing

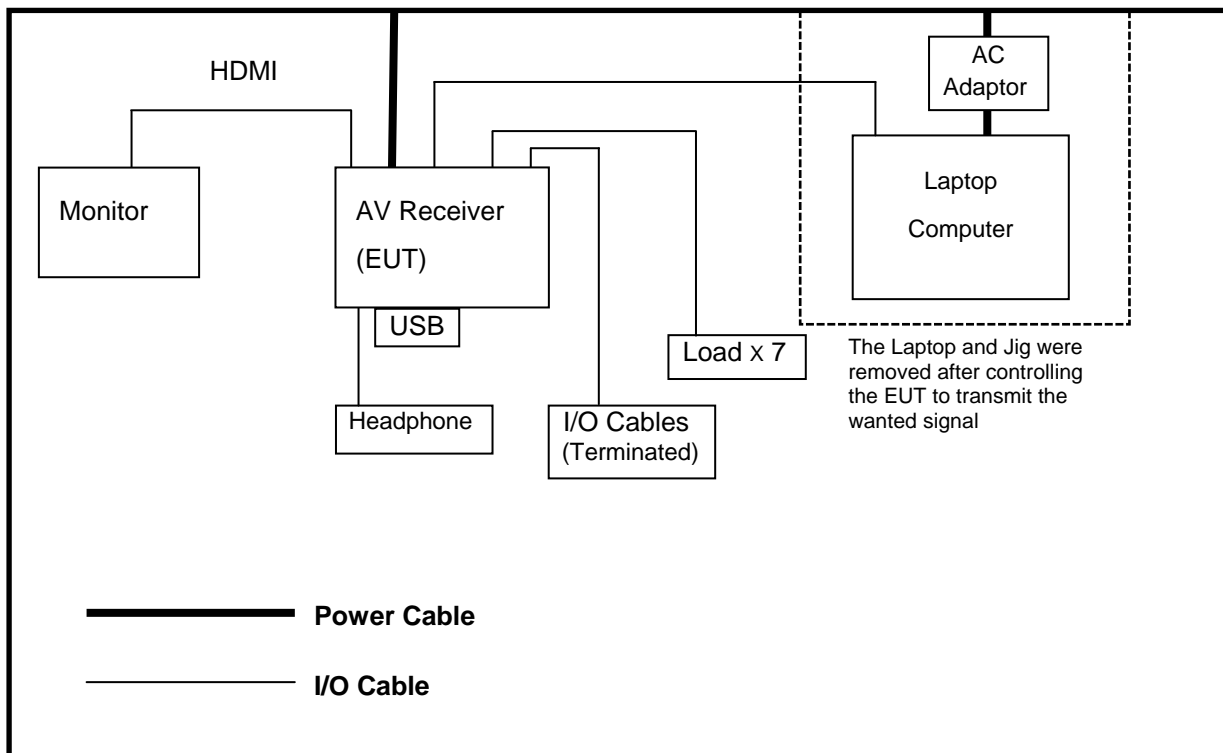

3.4 EUT Information

The EUT is the **Harman Kardon AV Receiver FCC ID: APIAVR1710AN, IC : 6132A-AVR1710AN**. This unit supports full qualified Bluetooth 2.1 with EDR standard system.

Specifications:

EUT Type	AV Receiver
Model Name	AVR1710
Brand Name	Harman Kardon
RF Frequency	2402 MHz ~ 2480 MHz
Peak Power Output (Conducted)	2.54 dBm
FCC Classification	FCC Part 15 Spread Spectrum Transmitter (DSS)
Method/System	Frequency Hopping Spread Spectrum (FHSS)
Channel Number	79
Modulation	GFSK, $\pi/4$ DQPSK, 8DPSK
Antenna Gain	0 dBi (Peak)
Power	a.c. 120 V
Size (W x D x H)	440 mm x 320 mm x 120 mm
Weight	5.10 kg

4. SUMMARY OF TEST RESULTS

The EUT has been tested according to the following specification:

Name of Test	FCC Paragraph No.	IC Paragraph No.	Result	Remark
Conducted Emission	15.207	RSS-GEN 7.2.4	Complies	
Radiated Emission	15.209	RSS-210 A8.5	Complies	
20dB Bandwidth and Carrier Frequency Separation	15.247(a)(1)(iii)	RSS-210 A8.1	Complies	
Carrier Frequency Separation	15.247(a)(1)	RSS-210 A8.1(2)	Complies	
Transmitter Average Time of Occupancy	15.247(a)(1)(iii)	RSS-210 A8.1(4)	Complies	
Peak Power Output	15.247(b)(1)	RSS-210 A8.4(2)	Complies	
Conducted Spurious Emission	15.247(d)	RSS-210 A8.5	Complies	
Radiated Spurious Emission	15.247(d)	RSS-210 A8.5	Complies	
Number of Hopping channels	15.247(a)(1)(iii)	RSS-210 A8.1(4)	Complies	

5. RECOMMENDATION/CONCLUSION

The data collected shows that the **Harman Kardon AV Receiver FCC ID: APIAVR1710AN, IC : 6132A-AVR1710AN** is in compliance with Part 15 Subpart C 15.247 of the FCC Rules and RSS-210 of the IC.

6. ANTENNA REQUIREMENTS

§15.203 of the FCC Rules part 15 Subpart C

: An intentional radiator shall be designed to ensure that no antenna other than that furnished by the responsible party shall be used with the device. The use of a permanently attached antenna or of an antenna that uses a unique coupling to the intentional radiator shall be considered sufficient to comply with the provisions of this section.

The antenna of the **Harman Kardon AV Receiver FCC ID: APIAVR1710AN, IC : 6132A-AVR1710AN** is **permanently attached** and there are no provisions for connection to an external antenna. It complies with the requirement of §15.203.

7. DESCRIPTION OF TESTS

7.1 Conducted Emissions

The Line conducted emission test facility is located inside a 4 x 7 x 2.5 meter shielded enclosure. It is manufactured by EM engineering. The shielding effectiveness of the shielded room is in accordance with MIL-STD-285 or NSA 65-6. A 1 m x 1.5 m wooden table 0.8 m height is placed 0.4 m away from the vertical wall and 1.5 m away from the side of wall of the shielded room. Rohde & Schwarz (ESH3-Z5) and (ESH2-Z5) of the 50 ohm/50 μ H Line Impedance Stabilization Network (LISN) are bonded to the shielded room. The EUT is powered from the Rohde & Schwarz LISN (ESH3-Z5) and the support equipment is powered from the Rohde & Schwarz LISN (ESH2-Z5). Power to the LISNs are filtered by high-current high insertion loss Power line filters. The purpose of filter is to attenuate ambient signal interference and this filter is also bonded to shielded enclosure. All electrical cables are shielded by tinned copper zipper tubing with inner diameter of 1 / 2 ". If DC power device, power will be derived from the source power supply it normally will be powered from and this supply lines will be connected to the LISNs, All interconnecting cables more than 1 meter were shortened by non inductive bundling (serpentine fashion) to a 1 meter length. Sufficient time for EUT, support equipment, and test equipment was allowed in order for them to warm up to their normal operating condition. The RF output of the LISN was connected to the spectrum analyzer to determine the frequency producing the maximum EME from the EUT. The spectrum was scanned from 150 kHz to 30 MHz with 200 msec sweep time. The frequency producing the maximum level was re-examined using the EMI test receiver. (Rohde & Schwarz ESCS30). The detector functions were set to CISPR quasi-peak mode & average mode. The bandwidth of receiver was set to 9 kHz. The EUT, support equipment, and interconnecting cables were arranged and manipulated to maximize each EME emission. Each emission was maximized by; switching power lines; varying the mode of operation or resolution; clock or data exchange speed; scrolling H pattern to the EUT and of support equipment, and powering the monitor from the floor mounted outlet box and computer aux AC outlet, if applicable; whichever determined the worst case emission. Each EME reported was calibrated using the R&S signal generator.

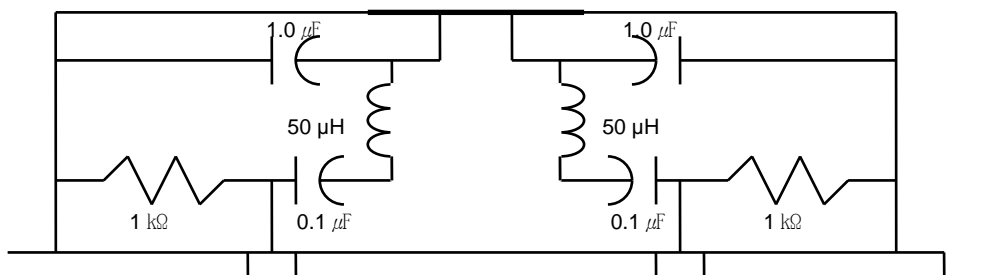

Fig. 2. LISN Schematic Diagram

7.2 Radiated Emissions

Test Procedure

The measurement was performed at the test site that is specified in accordance with ANSI C63.4-2003 and ANCI C63.10-2009.

The spurious emission was scanned from 9 kHz to 30 MHz using Loop Antenna and 30 to 1000 MHz using Bi-conical log Antenna. Above 1 GHz, Horn antenna was used.

The test equipment was placed on turntable with 0.8 m above ground. For the sufficient time the support equipment and test equipment were allowed in order for them to warm up to their normal operating condition. The equipment was rotated 360 ° and the antenna height has been varied between 1 m and 4 m. Measurements were taken at both horizontal and vertical antenna polarities. The receiver bandwidth was set to 120 kHz for measurements below 1 GHz. For the measurement above 1 GHz, Radiated Peak measurements were taken with RBW set to 1 MHz and VBW was set to 1 MHz with Peak detector. Average measurements were taken with RBW 1 MHz and VBW was set to 10 Hz with Peak detector.

Radiated emission limits

Frequency (MHz)	Field strength (microvolts/meter)	Measurement distance (meters)
0.009–0.490	2400/F(kHz)	300
0.490–1.705	24000/F(kHz)	30
1.705–30.0	30	30
30–88	100	3
88–216	150	3
216–960	200	3
Above 960	500	3

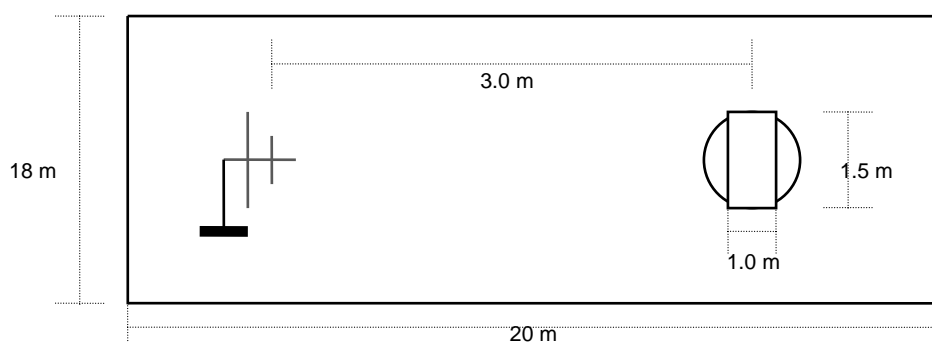
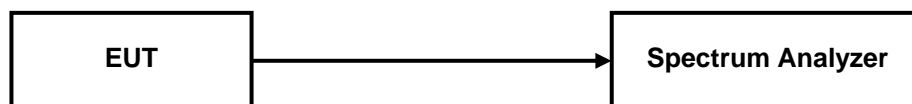

Fig. 3. Dimensions of Outdoor Test Site

7.3 20 dB Bandwidth and Carrier Frequency Separation

Test Setup



Test Procedure

The transmitter is set to the Low, Middle, High channels is connected to the spectrum analyzer.

Span = approximately 2 to 3 times the 20 dB bandwidth, centered on a hopping channel

RBW \geq 1% of the 20 dB bandwidth

VBW \geq RBW

Sweep = auto

Detector function = peak

Trace = max hold

7.4 Transmitter Average Time of Occupancy

Test Setup

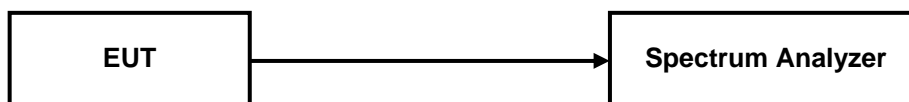

Test Procedure

The transmitter output is connected to a spectrum analyzer. The following spectrum analyzer setting is used.

Span = Zero span, centered on a hopping channel

RBW = 1 MHz, VBW \geq RBW

Sweep = as necessary to capture the entire dwell time per hopping channel

Detector function = Peak

Trace = Single sweep

Use the marker-delta function to determine the width of pulse

7.5 Number of Hopping Channels

Test Setup

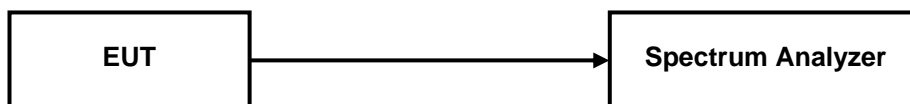

Test Procedure

The transmitter output is connected to a spectrum analyzer. The span is set to cover the entire authorized band, In either a single sweep or in multiple continuous sweeps. The RBW is set to 1 % of the span.

The spectrum analyzer is set to Max Hold.

7.6 Maximum Peak Output Power

Test Setup

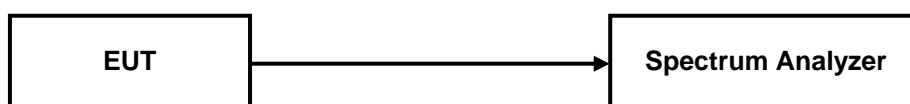

Test Procedure

The transmitter is set to the Low, Middle, High channels is connected to the spectrum analyzer. The RBW of spectrum analyzer is set to 3 MHz and VBW is set to the 3 MHz. The sweep time is coupled.

7.7 Conducted Spurious Emission

Test Setup

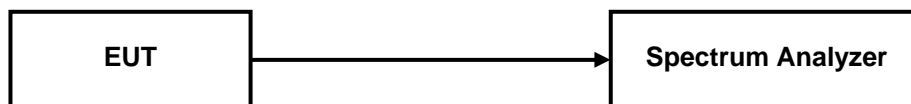

Test Procedure

The transmitter is connected to the spectrum analyzer.

The RBW of spectrum analyzer is set to 100 kHz and VBW is set to the 300 kHz.

Measurements are made over the 30 MHz to 25 GHz range with the transmitter set to the Lowest, middle and highest channels.

8. TEST DATA

8.1 Conducted Emissions

FCC §15.207, IC RSS-Gen 7.2.4

Frequency (MHz)	Level(dBμV)		*)Factor (dB)	**) Line	Limit(dBμV)		Margin(dB)	
	Q-Peak	Average			Q-Peak	Average	Q-Peak	Average
0.15	57.0	47.9	0.2	L	66.0	56.0	9.0	8.1
0.20	51.8	43.0	0.2	N	63.6	53.6	11.8	10.6
0.27	42.6	33.9	0.2	N	61.1	51.1	18.5	17.2
0.45	44.4	36.8	0.2	N	56.9	46.9	12.5	10.1
2.89	35.6	30.4	0.2	L	56.0	46.0	20.4	15.6
9.29	43.0	32.6	0.6	L	60.0	50.0	17.0	17.4

Line Conducted Emissions Tabulated Data

NOTES:

1. *Measurements using CISPR quasi-peak mode & average mode.*
2. *All modes of operation were investigated and the worst -case emission were reported. See attached Plots.*
3. **) Factor = LISN + Cable Loss*
4. ***) LINE : L = Line , N = Neutral*
5. *The limit is on the FCC Part section 15.207(a).*

PLOTS OF EMISSIONS

- Conducted Emission at the Mains port (Line)

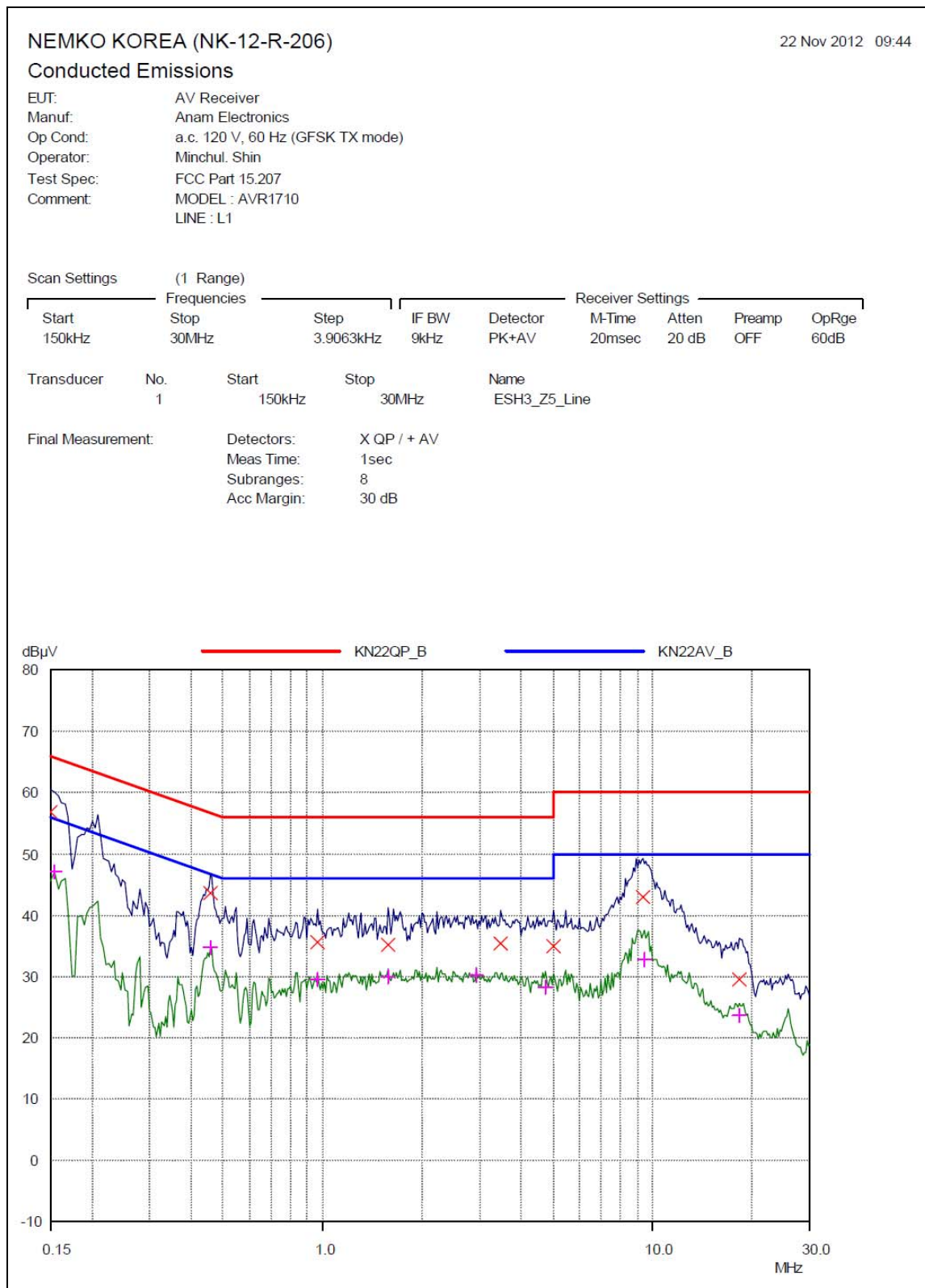

PLOTS OF EMISSIONS

- Conducted Emission at the Mains port (Neutral)

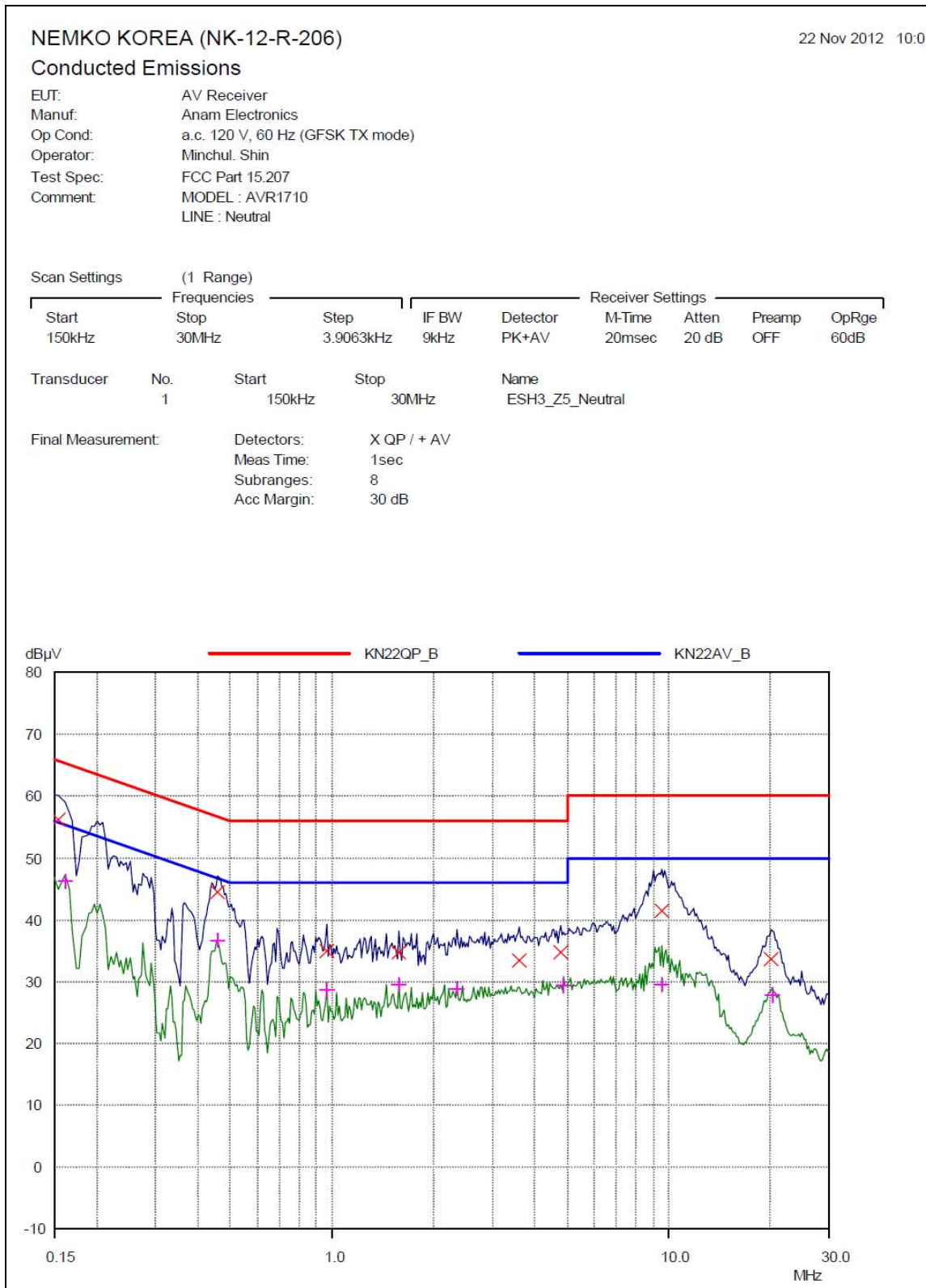

TEST DATA

8.2 Radiated Emissions

FCC §15.209, IC RSS-210 A8.5

Frequency (MHz)	Reading (dB μ V/m)	Pol* (H/V)	Antenna Heights (cm)	Turntable Angles (°)	AF+CL+Amp (dB)**	Result (dB μ V/m)	Limit (dB μ V/m)	Margin (dB)
34.66	54.53	H	281	344	-18.0	36.5	40.0	3.5
135.00	51.87	V	109	202	-17.1	34.8	43.5	8.7
196.61	49.01	H	172	79	-16.2	32.8	43.5	10.7
350.00	48.90	V	197	7	-13.6	35.3	46.0	10.7
400.01	51.50	H	100	19	-11.1	40.4	46.0	5.6
675.00	45.10	H	141	163	-6.5	38.6	46.0	7.4

Radiated Measurements at 3 meters

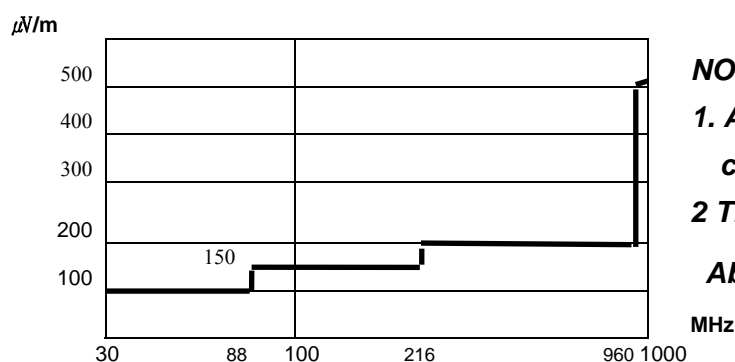

Fig. 4. Limits at 3 meters

NOTES:

1. All modes were measured and the worst-case emission was reported.
 - 2 The radiated limits are shown on Figure 4.
- Above 1GHz the limit is 500 μ V /m.

NOTES:

1. *Pol. H = Horizontal V = Vertical
2. **AF + CL + Amp. = Antenna Factor + Cable Loss + Amplifier.
3. Measurements using CISPR quasi-peak mode below 1 GHz.
4. The radiated emissions testing were made by rotating the receive antenna with horizontal, Vertical polarization. The worst date was recorded.
5. The limit is on the FCC Part section 15.209(a).

TEST DATA

8.3 20 dB Modulated Bandwidth

FCC §15.247(a)(1)(iii), IC RSS-210 A8.1

Test Mode : Set to Lowest channel, Middle channel and Highest channel

Result:

Modulation Mode	Frequency(MHz)	Result(kHz)	Limit(kHz)
GFSK	2402	931	Non specified
GFSK	2441	929	Non specified
GFSK	2480	928	Non specified
$\pi/4$ DQPSK	2402	1230	Non specified
$\pi/4$ DQPSK	2441	1236	Non specified
$\pi/4$ DQPSK	2480	1235	Non specified
8DPSK	2402	1257	Non specified
8DPSK	2441	1244	Non specified
8DPSK	2480	1245	Non specified

PLOTS OF EMISSIONS

20 dB Bandwidth, Lowest Channel (2402 MHz, GFSK Mode)

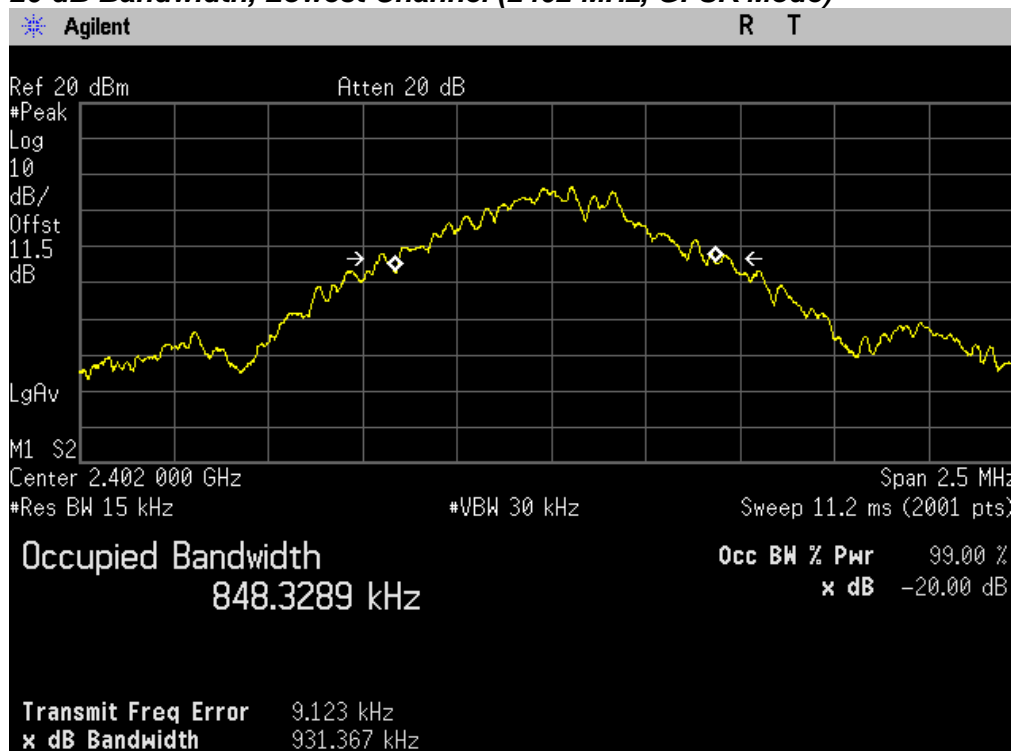

20 dB Bandwidth, Middle Channel (2441 MHz, GFSK Mode)

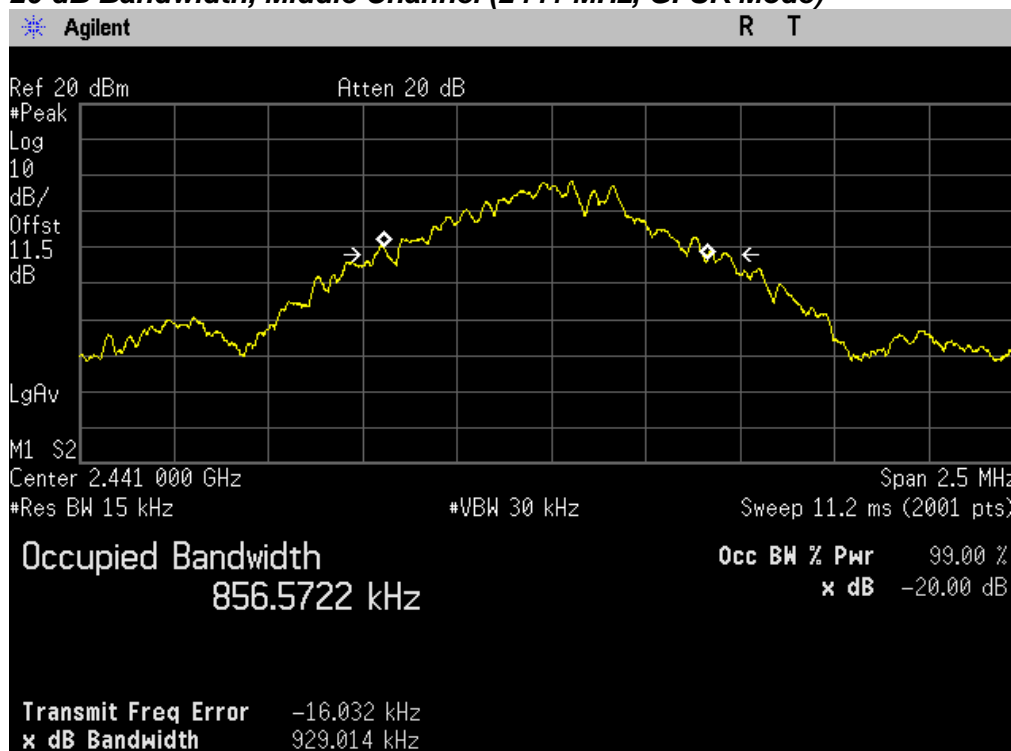

PLOTS OF EMISSIONS

20 dB Bandwidth, Highest Channel (2480 MHz, GFSK Mode)

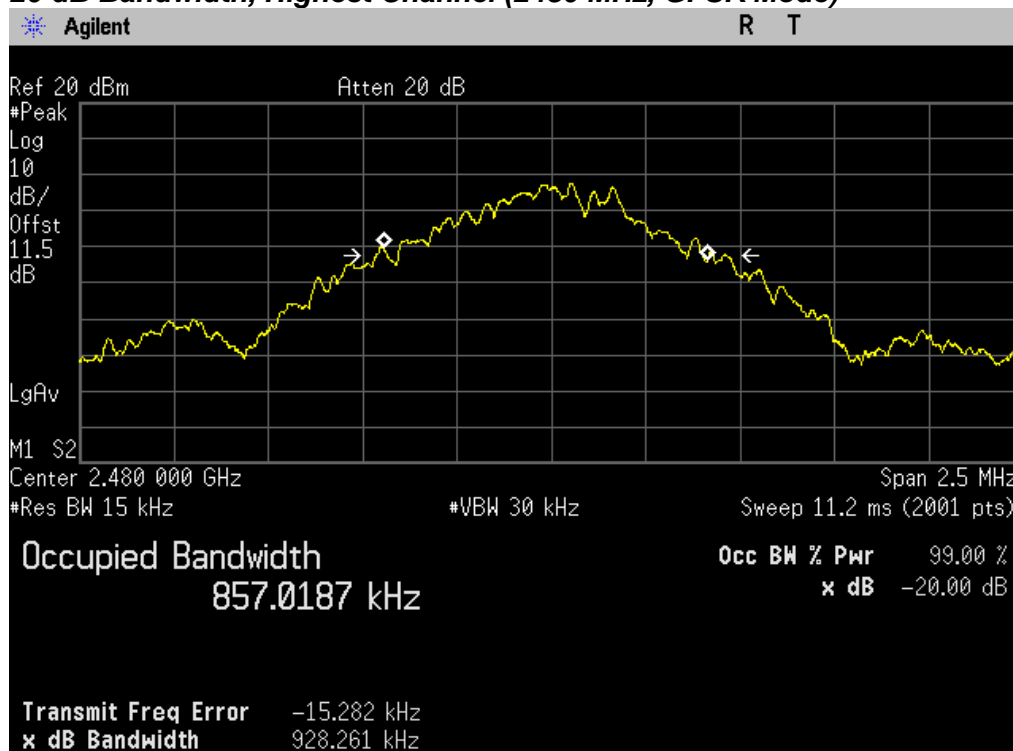

20 dB Bandwidth, Lowest Channel (2402 MHz, $\pi/4$ DQPSK Mode)

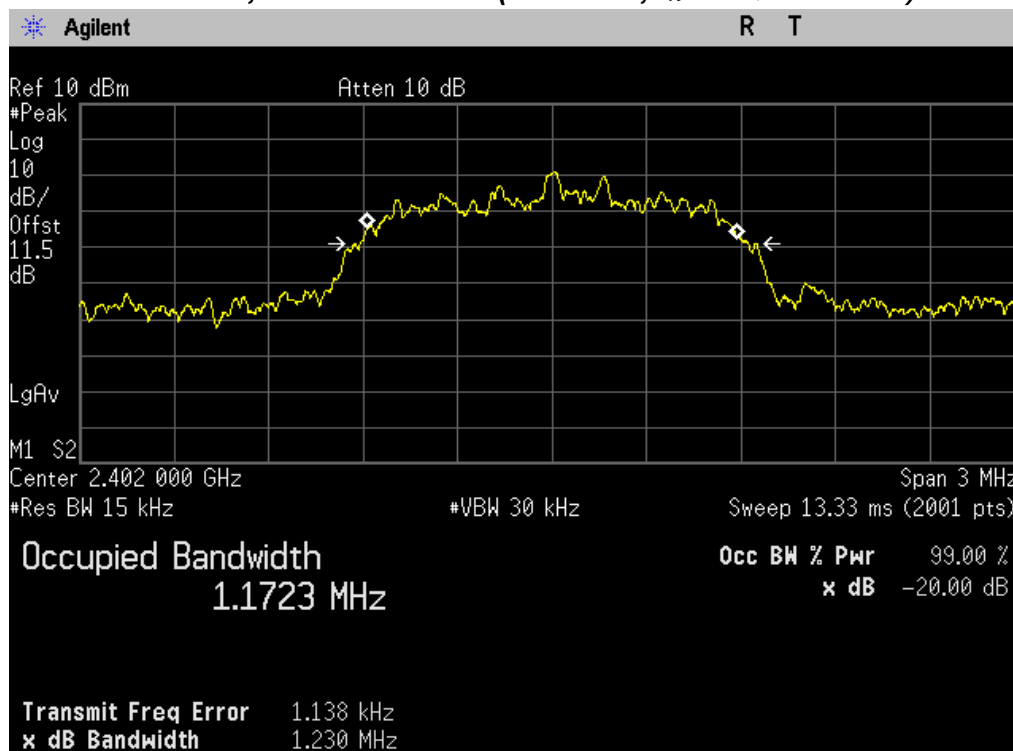

PLOTS OF EMISSIONS

20 dB Bandwidth, Middle Channel (2441 MHz, $\pi/4$ DQPSK Mode)

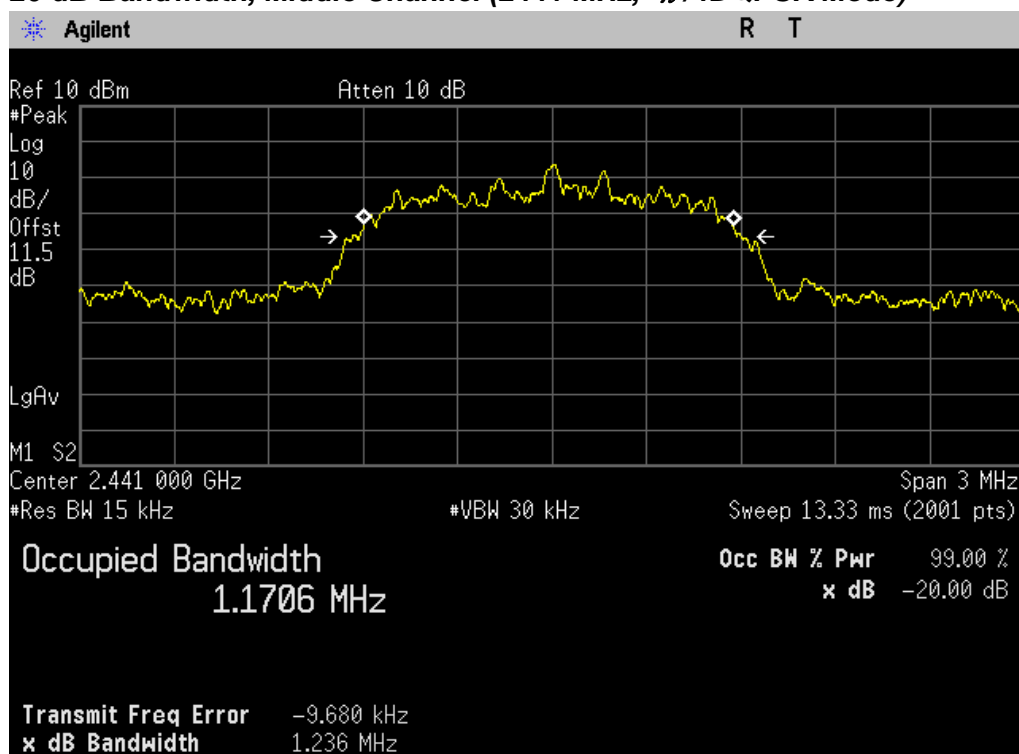

20 dB Bandwidth, Highest Channel (2480 MHz, $\pi/4$ DQPSK Mode)



PLOTS OF EMISSIONS

20 dB Bandwidth, Lowest Channel (2402 MHz, 8DPSK Mode)



20 dB Bandwidth, Middle Channel (2441 MHz, 8DPSK Mode)

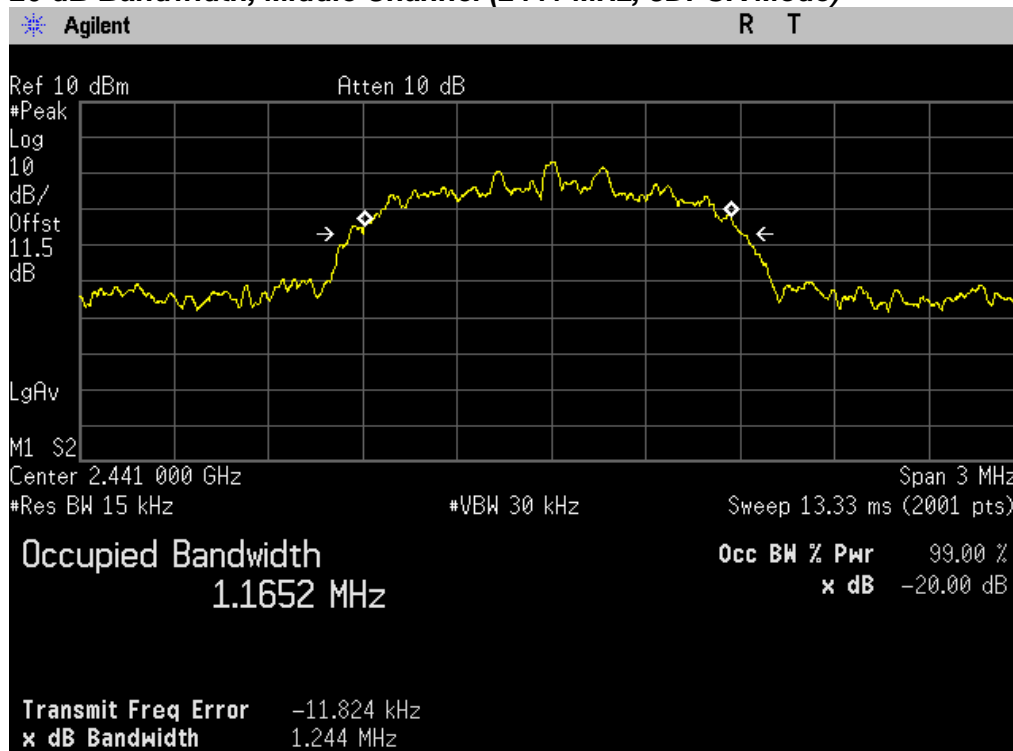

PLOTS OF EMISSIONS

20 dB Bandwidth, Highest Channel (2480 MHz, 8DPSK Mode)

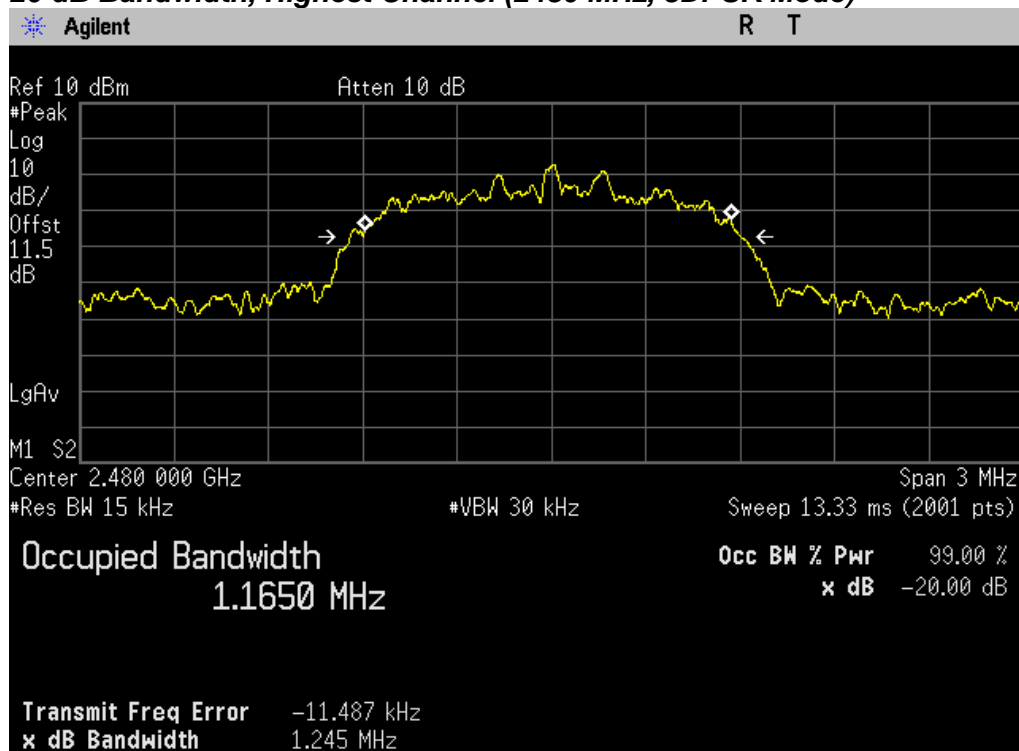

TEST DATA

8.4 Carrier Frequency Separation

FCC §15.247(a)(1), IC RSS-210 A8.1(2)

Test Mode : Set to Hopping mode

Result:

Modulation Mode	Carrier Frequency Separation (kHz)	Limit (2 / 3 of 20dB Bandwidth) (kHz)	Margin (kHz)
GFSK	1000	620.9	379.1
$\pi/4$ DQPSK	1000	824.0	176.0
8DPSK	1000	838.0	162.0

PLOTS OF EMISSIONS

Carrier Frequency Separation (GFSK Mode)

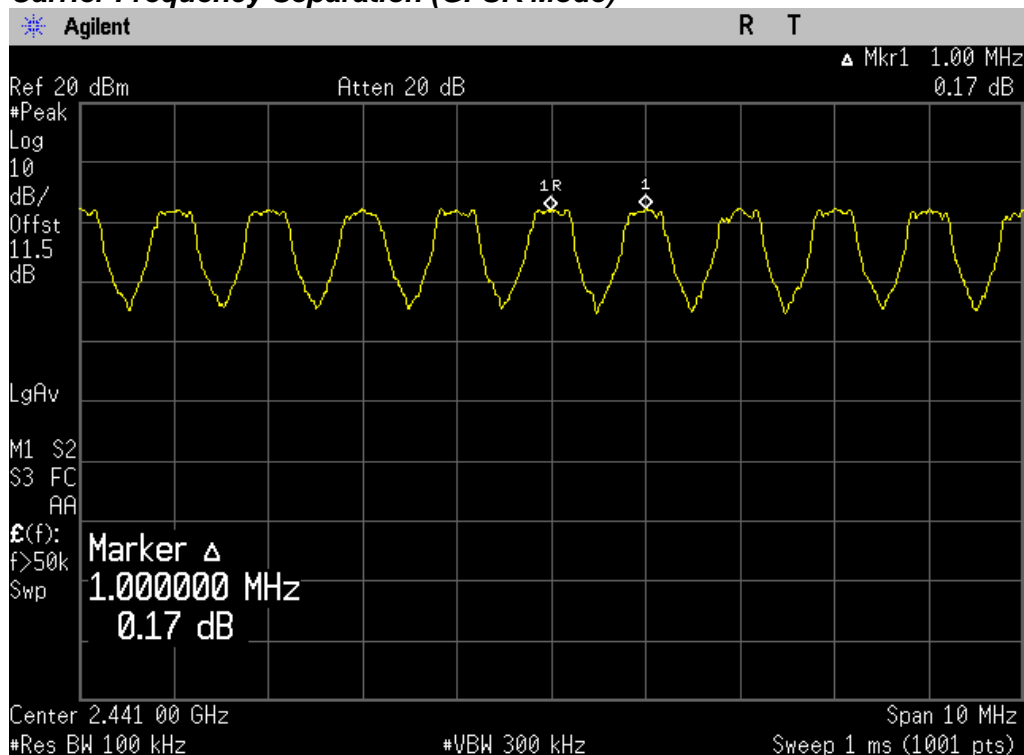

Carrier Frequency Separation ($\pi/4$ DQPSK Mode)

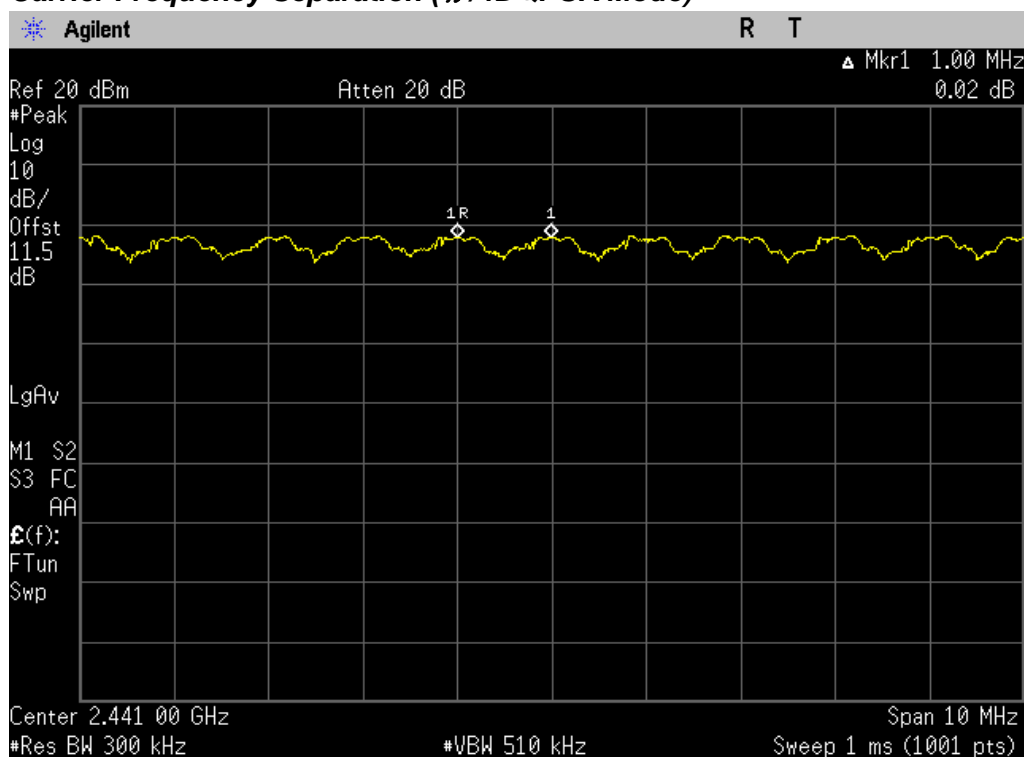

PLOTS OF EMISSIONS

Carrier Frequency Separation (8DPSK Mode)

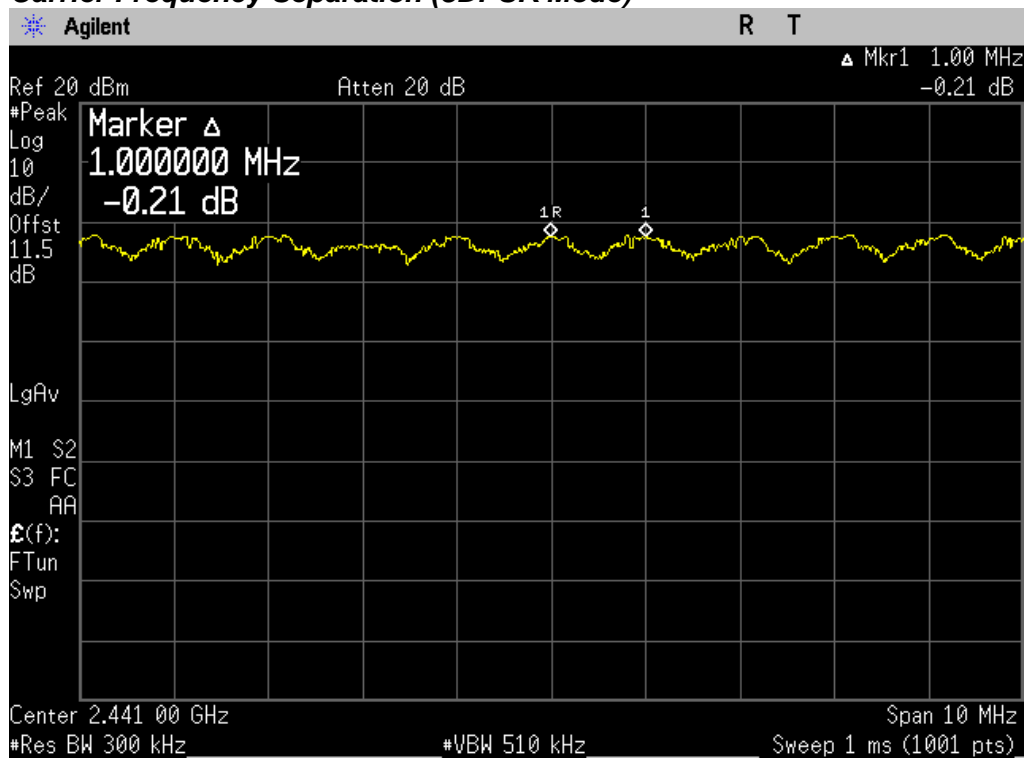

TEST DATA

8.5 Transmitter Average Time of Occupancy

FCC §15.247(a)(1)(iii), IC RSS-210 A8.1(4)

Test mode : Set to Hopping mode

Result:

The average time of occupancy in the specified 31.6 second period (79 channels x 0.4 s) is equal to pulse width x (1600 / 6) / 79 x 31.6 second.

Pulse width (ms)	^{*)} Numbers of slots in 31.6 sec	^{**)} Average time of Occupancy(ms)	Limit (ms)	Margin (ms)
2.89	106.7	308.36	≤ 400	91.64

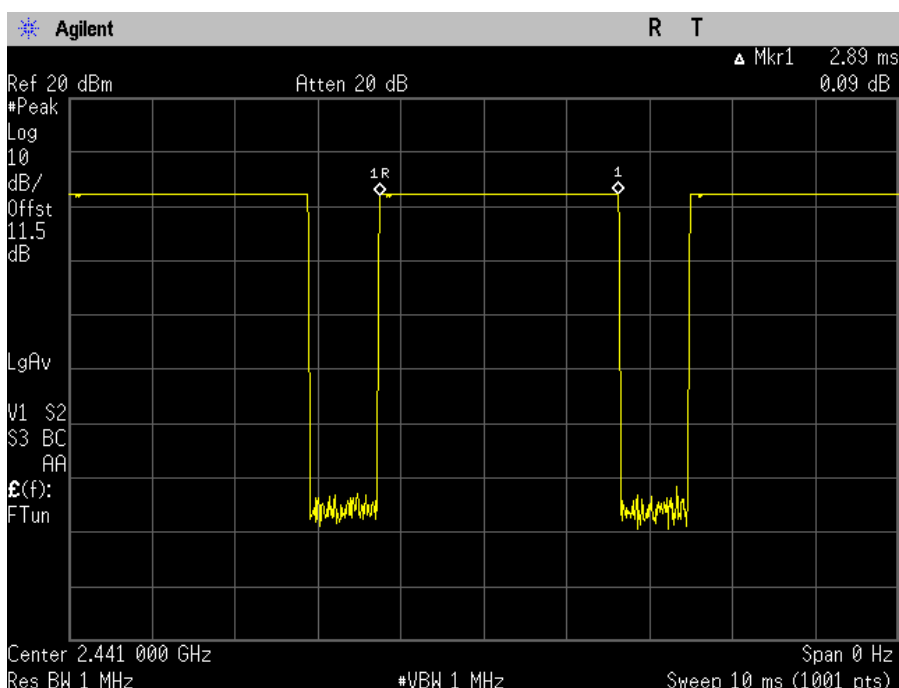

Notes:

The result was measured at DH5 mode in GFSK modulation, which has longest time in one transmission burst.

^{*)}Numbers of slots in 31.6 sec = $(1600 / 6) / 79 \times 31.6$

^{**)}Average time of Occupancy = pulse width x Numbers of slots in 31.6 sec

TEST DATA

8.6 Number of Hopping Channels

FCC §15.247(a)(1)(iii), IC RSS-210 A8.1(4)

Test mode : Set to Hopping mode

Result:

Total Hopping Channels = 40 + 39 = 79

The EUT meets the specifications of Section 15.247(a)(1)(iii) for Number of Hopping Channels.

PLOT OF TEST DATA

Top half of Authorized band

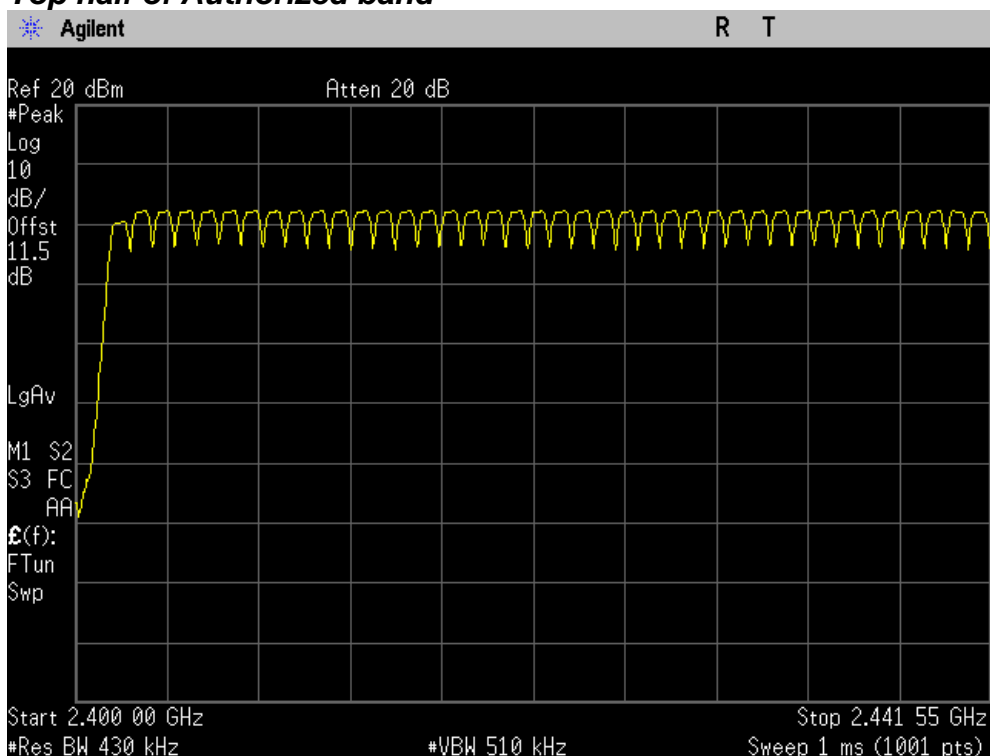

Bottom half of Authorized band

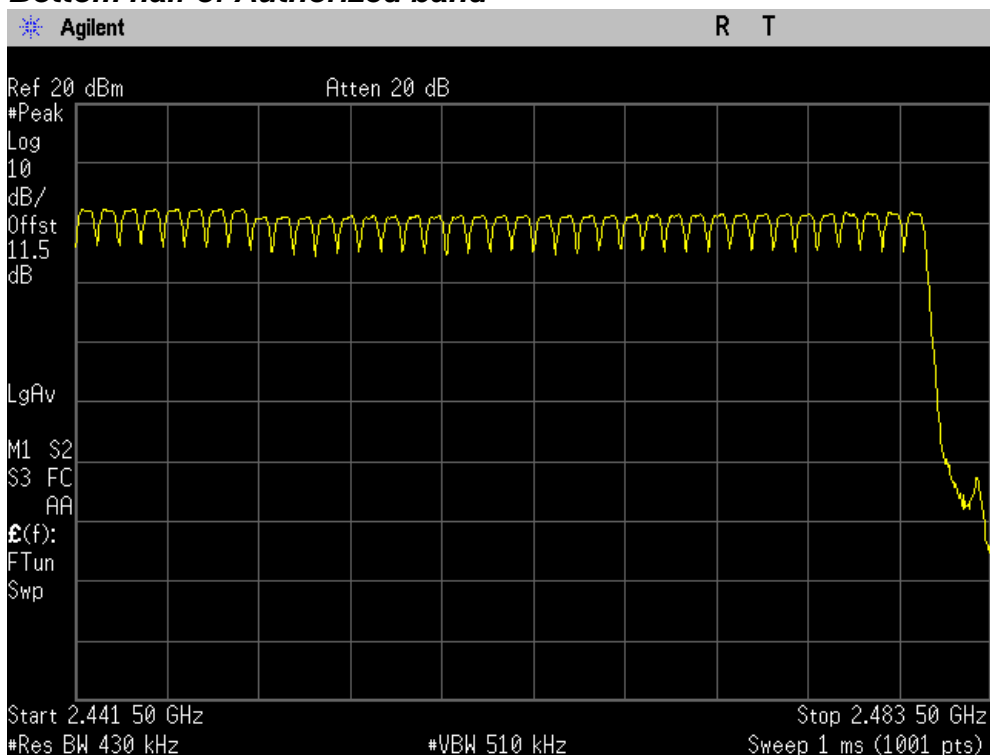

TEST DATA

8.7 Peak Power Output

FCC §15.247(b)(1), IC RSS-210 A8.4(2)

Test Mode : Set to Lowest channel, Middle channel and Highest channel

Result:

Modulation	Frequency (MHz)	Peak Power (dBm)	Limit (dBm)	Margin (dB)
GFSK	2402	0.81	30.00	29.19
GFSK	2441	2.54	30.00	27.46
GFSK	2480	1.94	30.00	28.06
$\pi/4$ DQPSK	2402	-2.16	30.00	32.16
$\pi/4$ DQPSK	2441	0.01	30.00	29.99
$\pi/4$ DQPSK	2480	-0.56	30.00	30.56
8DPSK	2402	-1.66	30.00	31.66
8DPSK	2441	0.45	30.00	29.55
8DPSK	2480	-0.22	30.00	30.22

Note:

The following formular was used for spectrum offset:

Spectrum offset (dB) = Attenuator (dB) + Cable Loss (dB) + SMA Type Connector Loss (dB)

PLOT OF TEST DATA

Maximum Peak Output Power, Lowest channel (2402 MHz, GFSK mode)

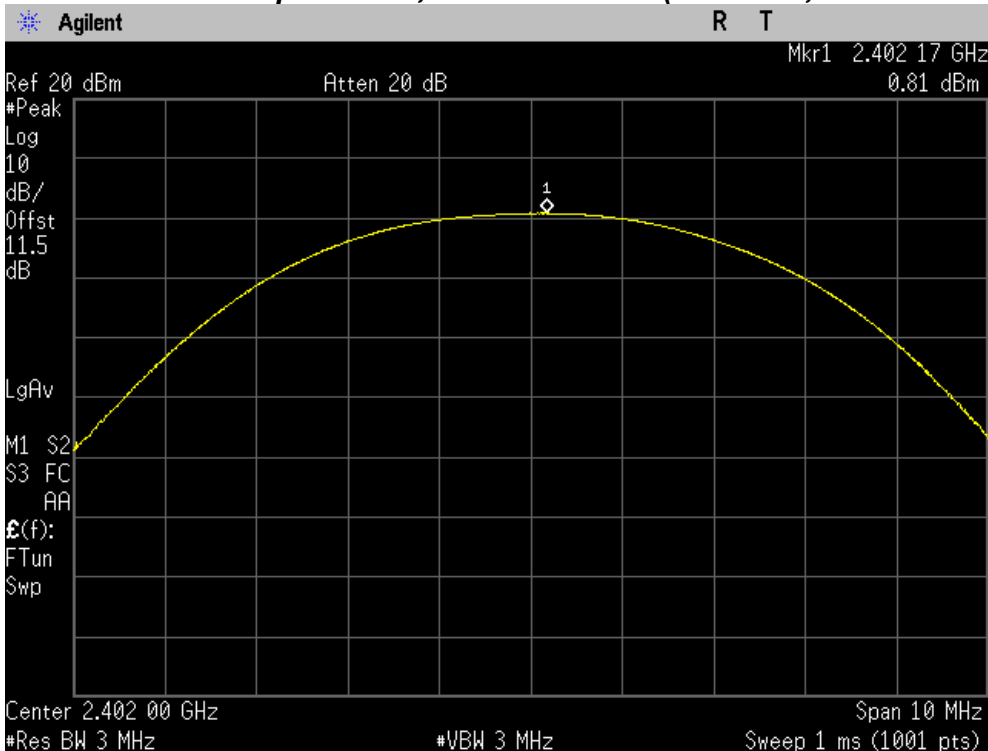

Maximum Peak Output Power, Middle channel (2441 MHz, GFSK mode)

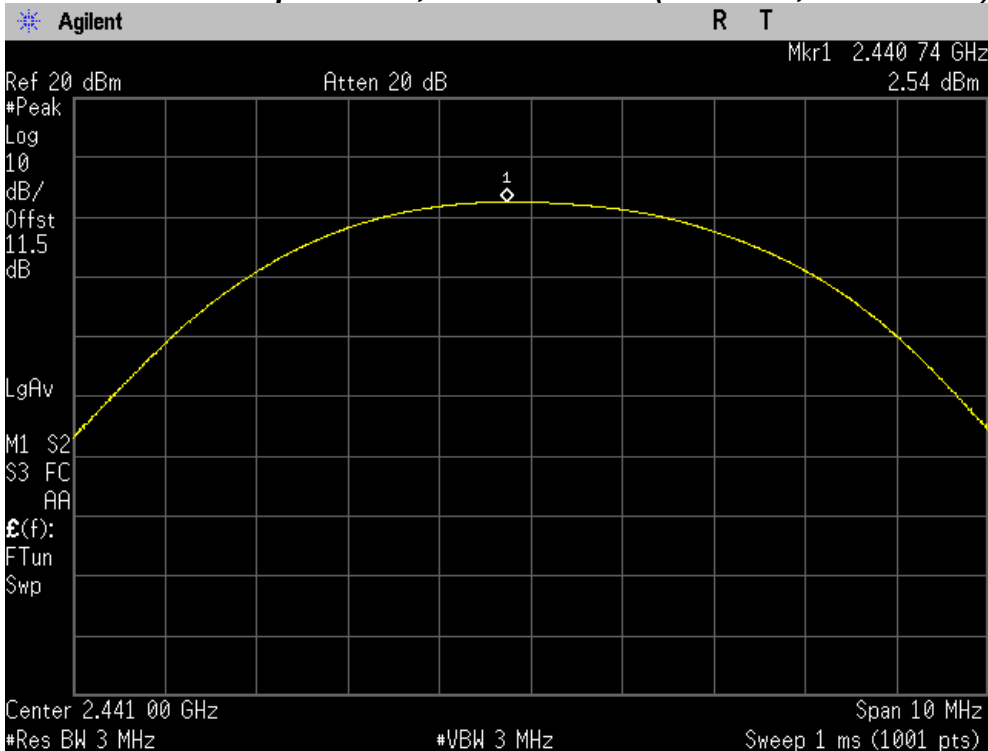

PLOT OF TEST DATA

Maximum Peak Output Power, Highest channel (2480 MHz, GFSK mode)

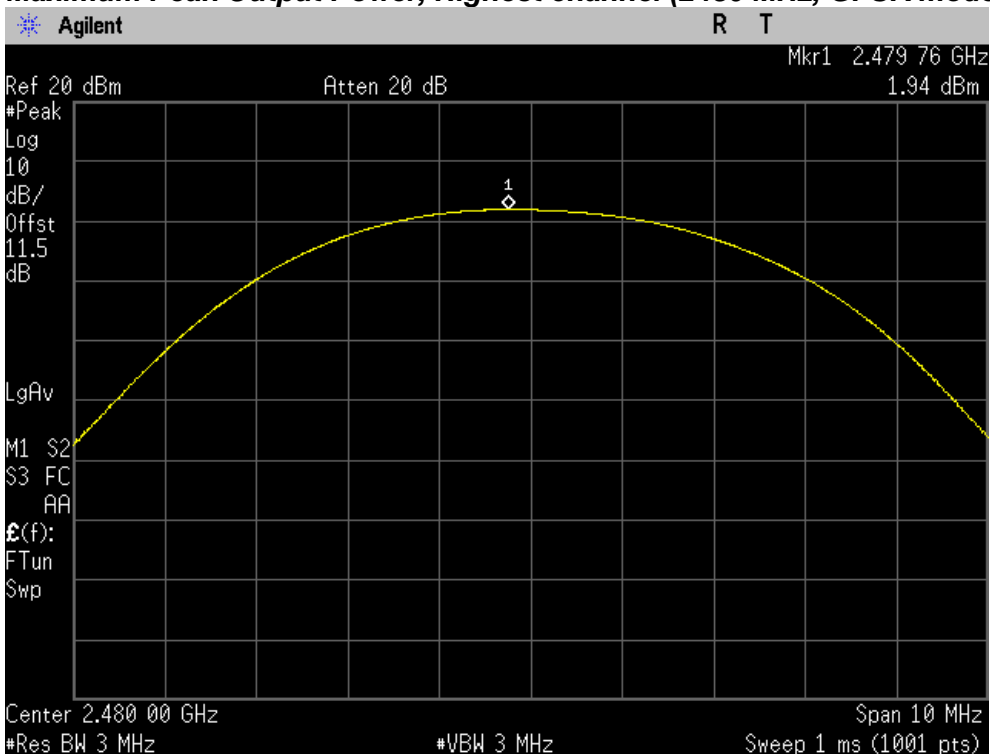

Maximum Peak Output Power, Lowest channel (2402 MHz, $\pi/4$ DQPSK)

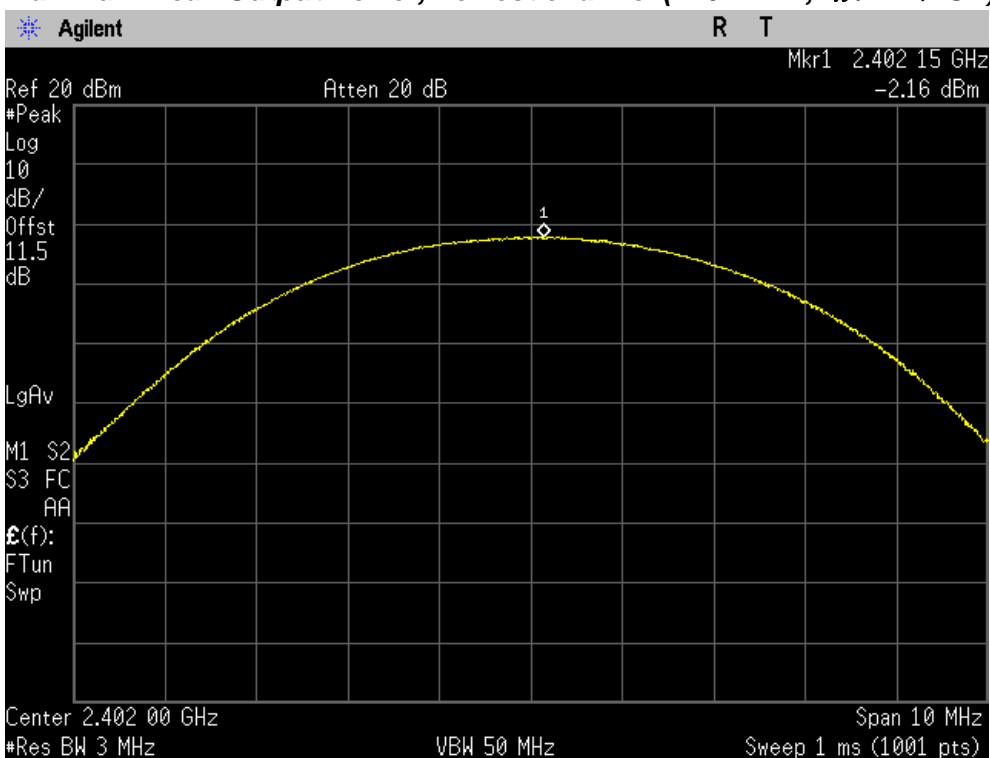

PLOT OF TEST DATA

Maximum Peak Output Power, Middle channel (2441 MHz, $\pi/4$ DQPSK)

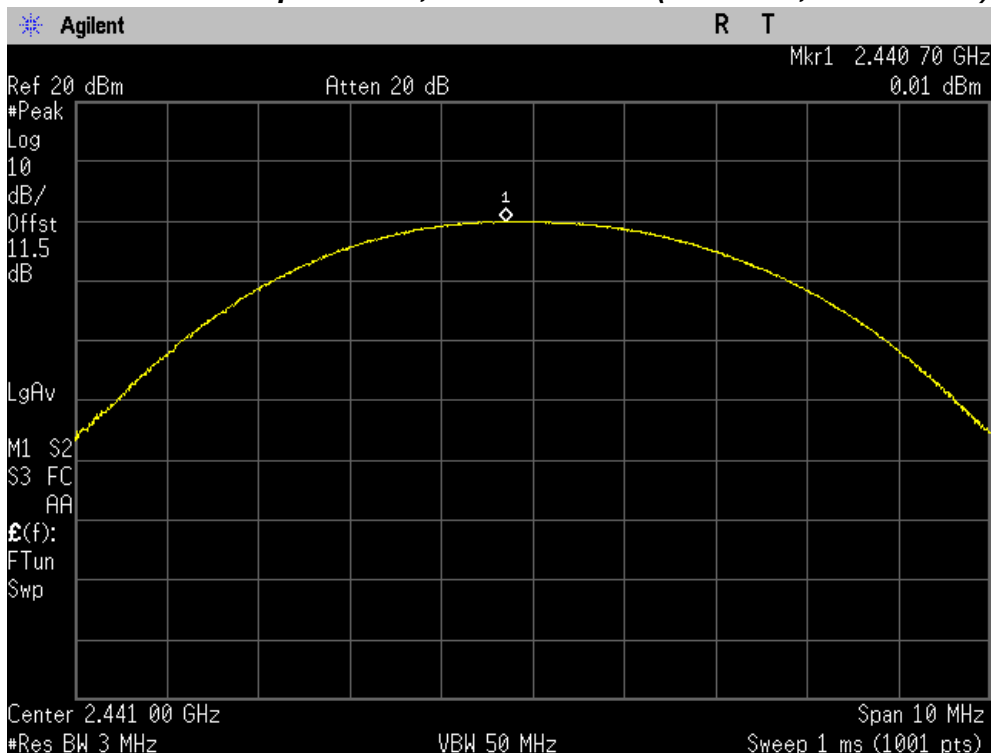

Maximum Peak Output Power, Highest channel (2480 MHz, $\pi/4$ DQPSK)

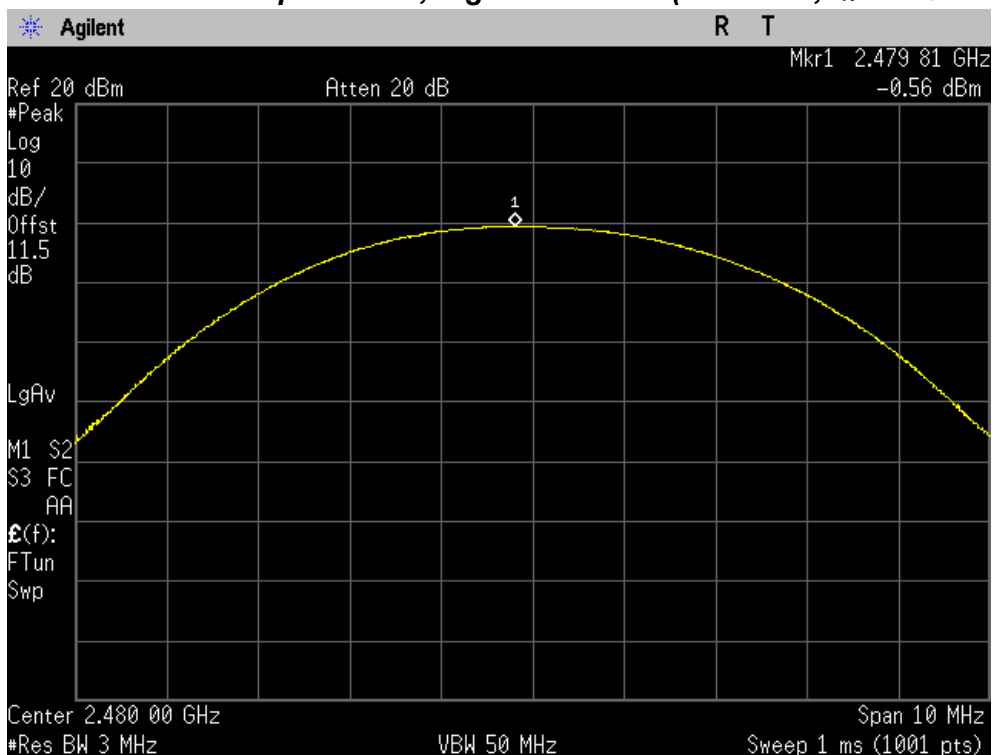

PLOT OF TEST DATA

Maximum Peak Output Power, Lowest channel (2402 MHz, 8DPSK)

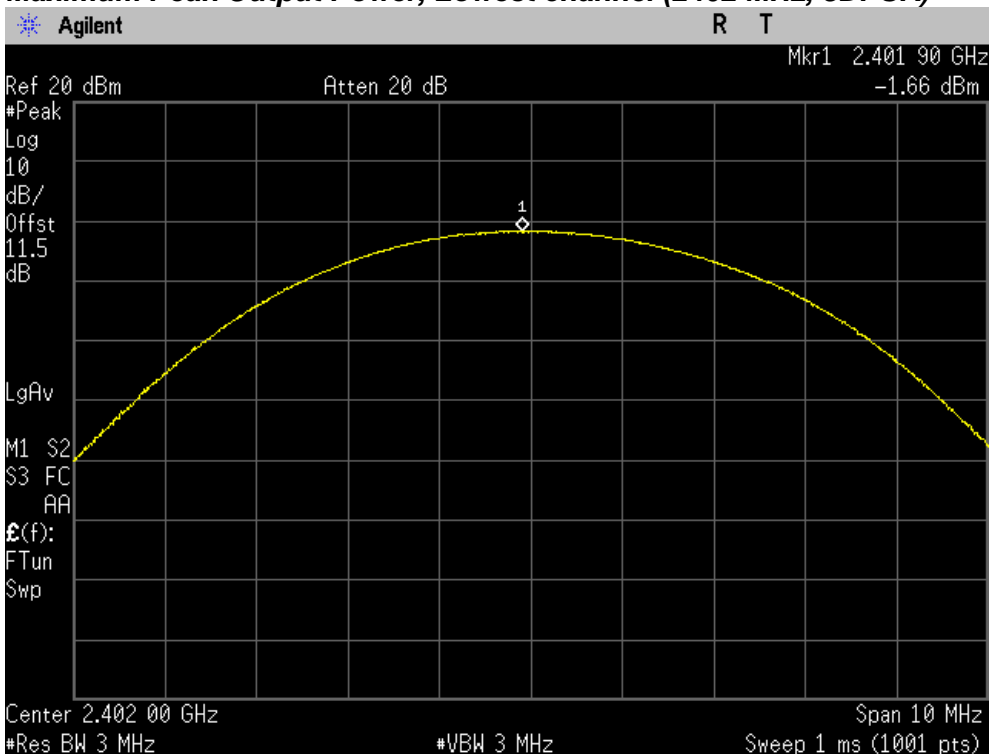

Maximum Peak Output Power, Middle channel (2441 MHz, 8DPSK)

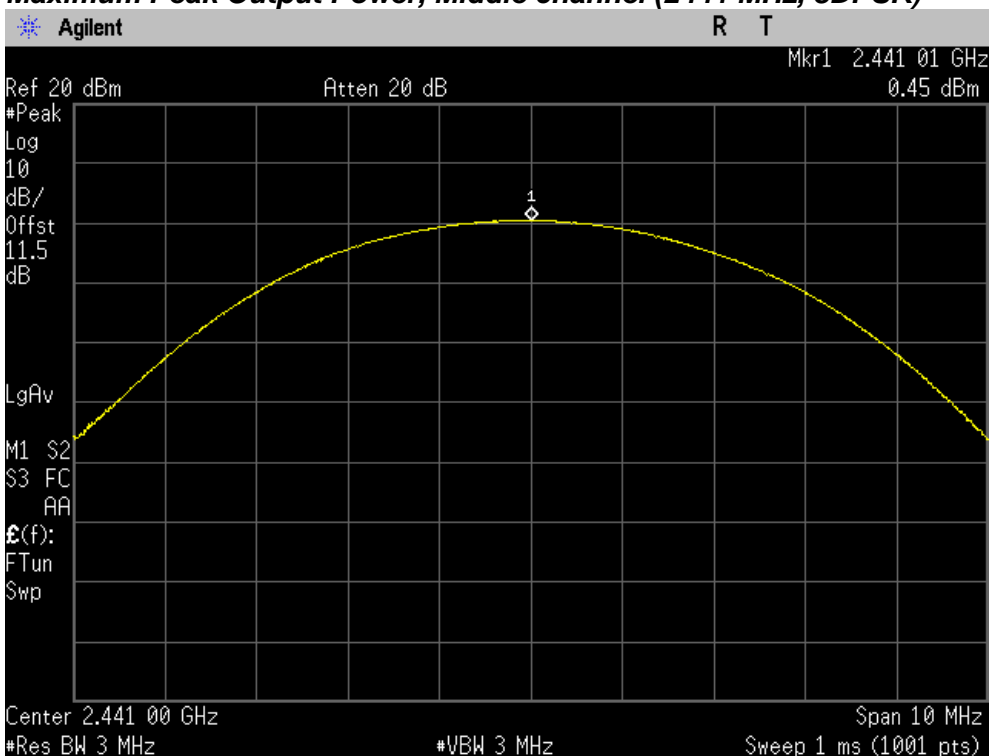

PLOT OF TEST DATA

Maximum Peak Output Power, Highest channel (2480 MHz, 8DPSK)

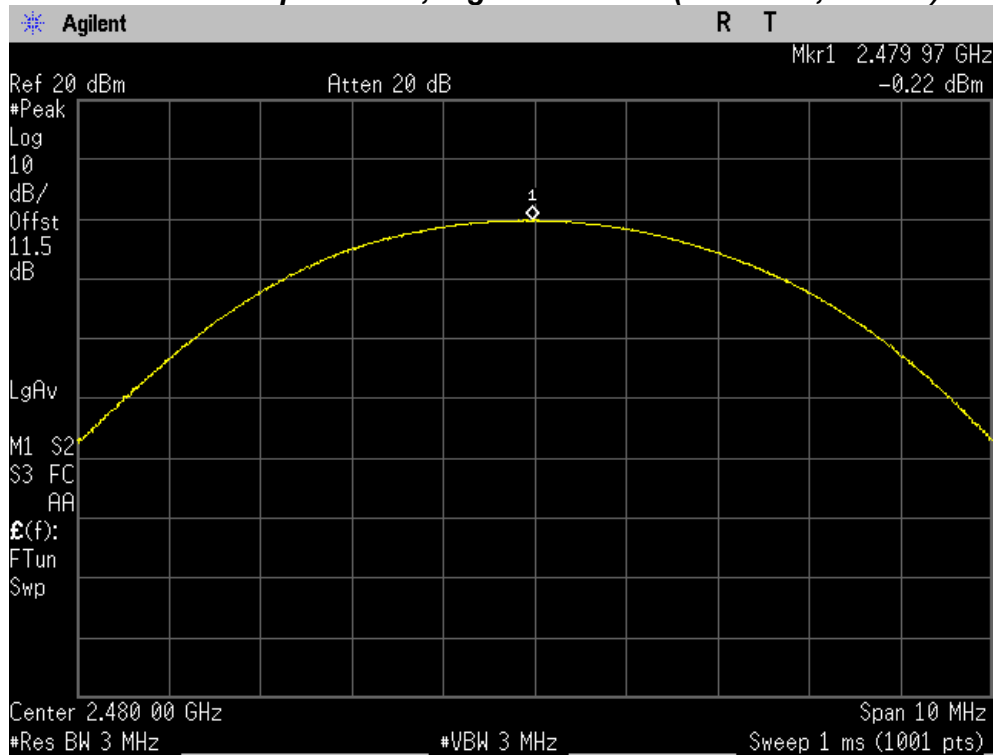

TEST DATA

8.8 Conducted Spurious Emission

FCC §15.247(d), IC RSS-210 A8.5

Test Mode : Set to Lowest channel, Middle channel and Highest channel

Result:

Modulation Mode	Frequency(MHz)	Result	Limit(dBc)
GFSK	2402	More than 30 dBc	20
GFSK	2441	More than 30 dBc	20
GFSK	2480	More than 30 dBc	20
$\pi/4$ DQPSK	2402	More than 30 dBc	20
$\pi/4$ DQPSK	2441	More than 30 dBc	20
$\pi/4$ DQPSK	2480	More than 30 dBc	20
8DPSK	2402	More than 30 dBc	20
8DPSK	2441	More than 30 dBc	20
8DPSK	2480	More than 30 dBc	20

PLOT OF TEST DATA

Conducted Spurious Emissions, 30 MHz ~ 10 GHz(2402 MHz, GFSK Mode)

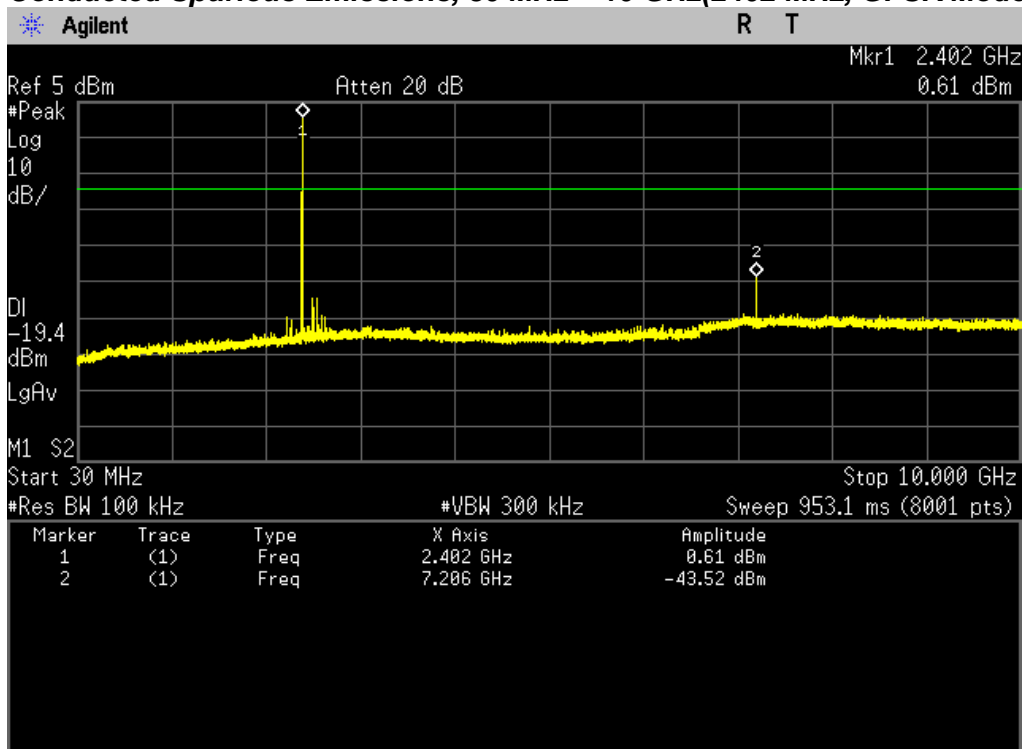

Conducted Spurious Emissions, 10 GHz ~ 25 GHz(2402 MHz, GFSK Mode)

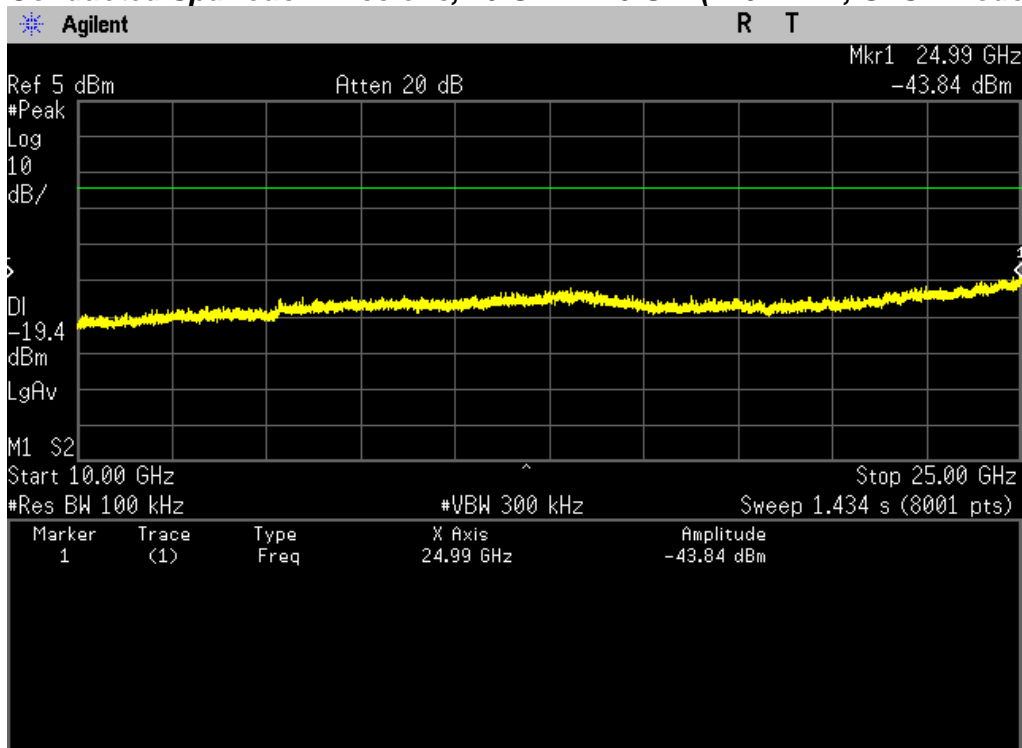

PLOT OF TEST DATA

Conducted Spurious Emissions, 30 MHz ~ 10 GHz(2441 MHz, GFSK Mode)

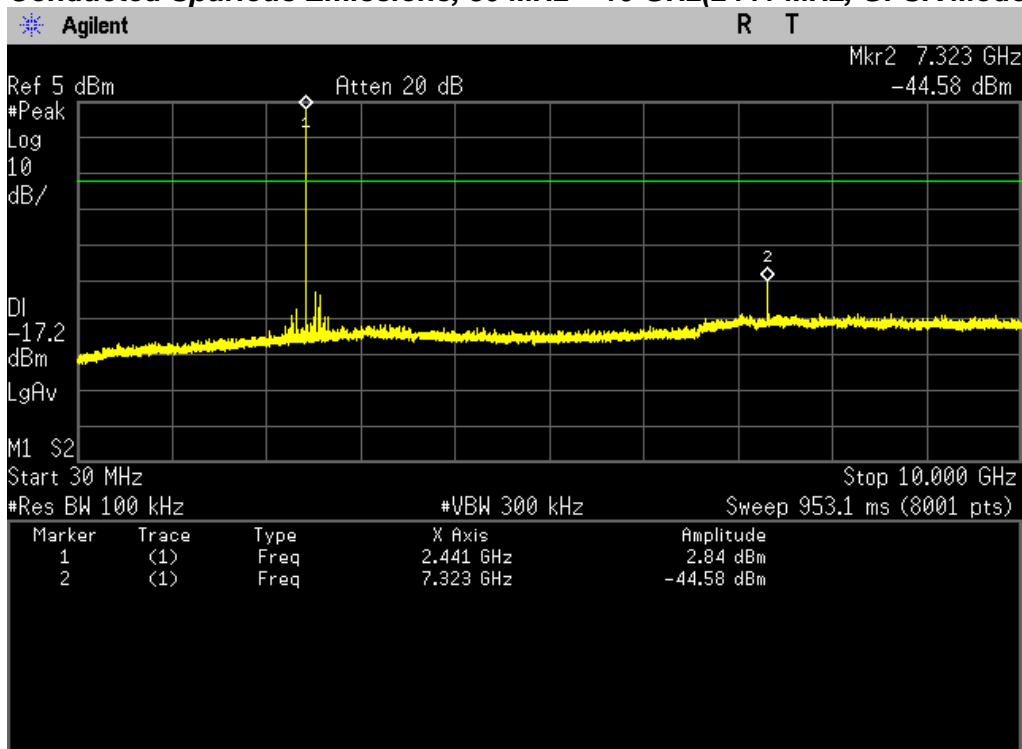

Conducted Spurious Emissions, 10 GHz ~ 25GHz(2441 MHz, GFSK Mode)

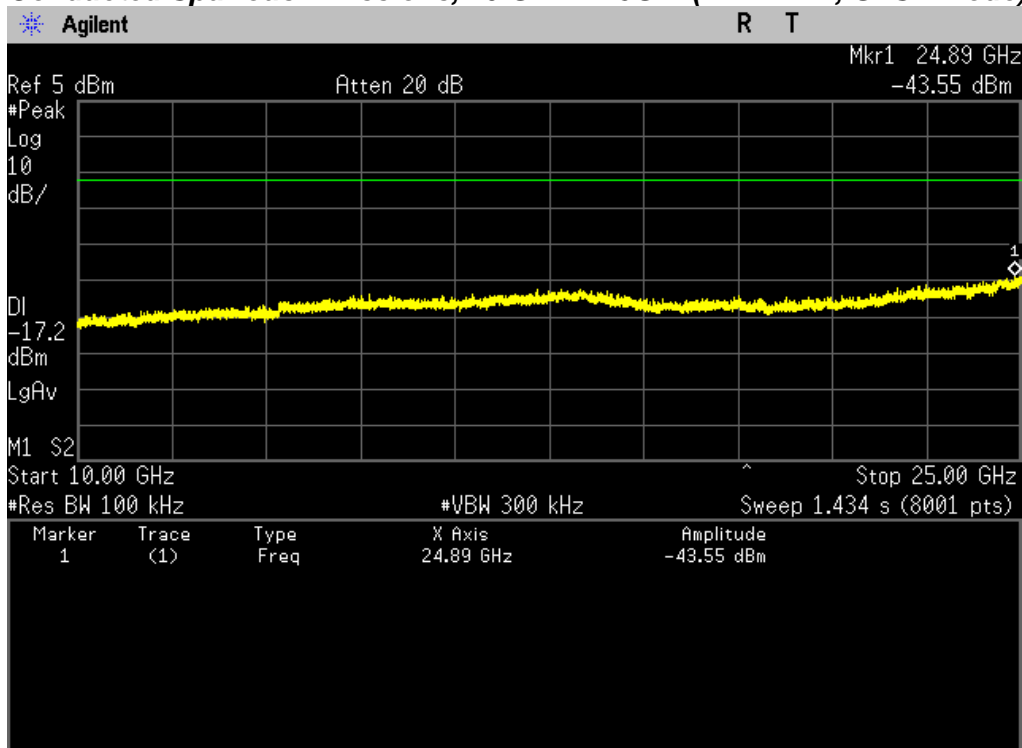

PLOT OF TEST DATA

Conducted Spurious Emissions, 30 MHz ~ 10 GHz(2480 MHz, GFSK Mode)

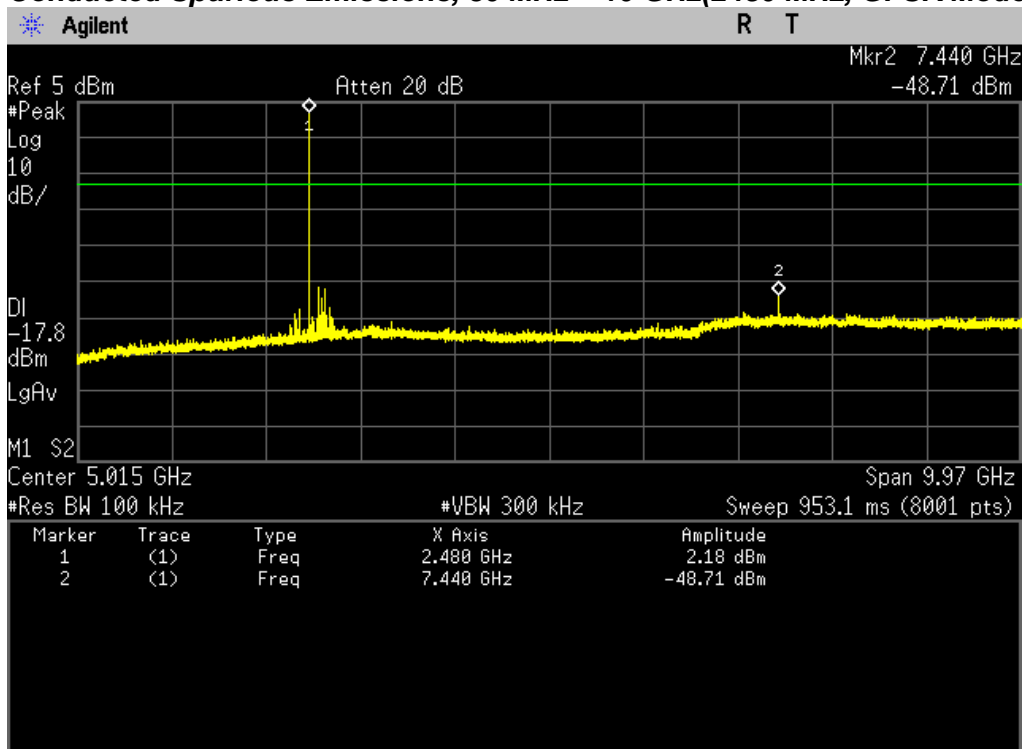

Conducted Spurious Emissions, 10 GHz ~ 25 GHz(2480 MHz, GFSK Mode)

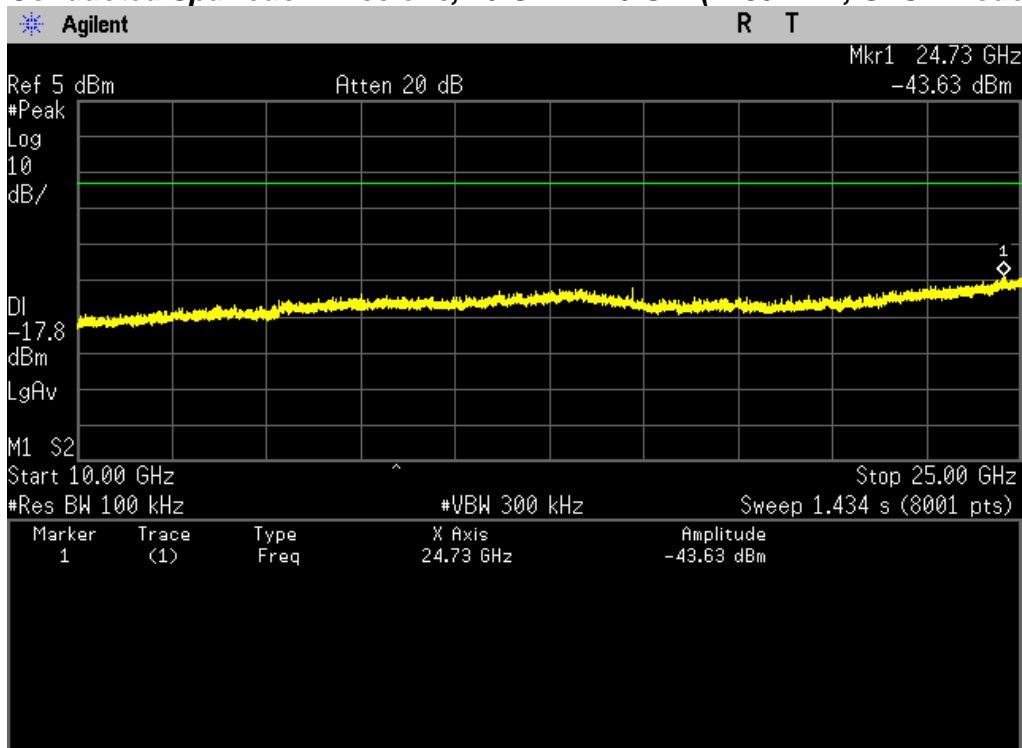

PLOT OF TEST DATA

Conducted Spurious Emissions, 30 MHz ~ 10 GHz(2402 MHz, $\pi/4$ DQPSK Mode)

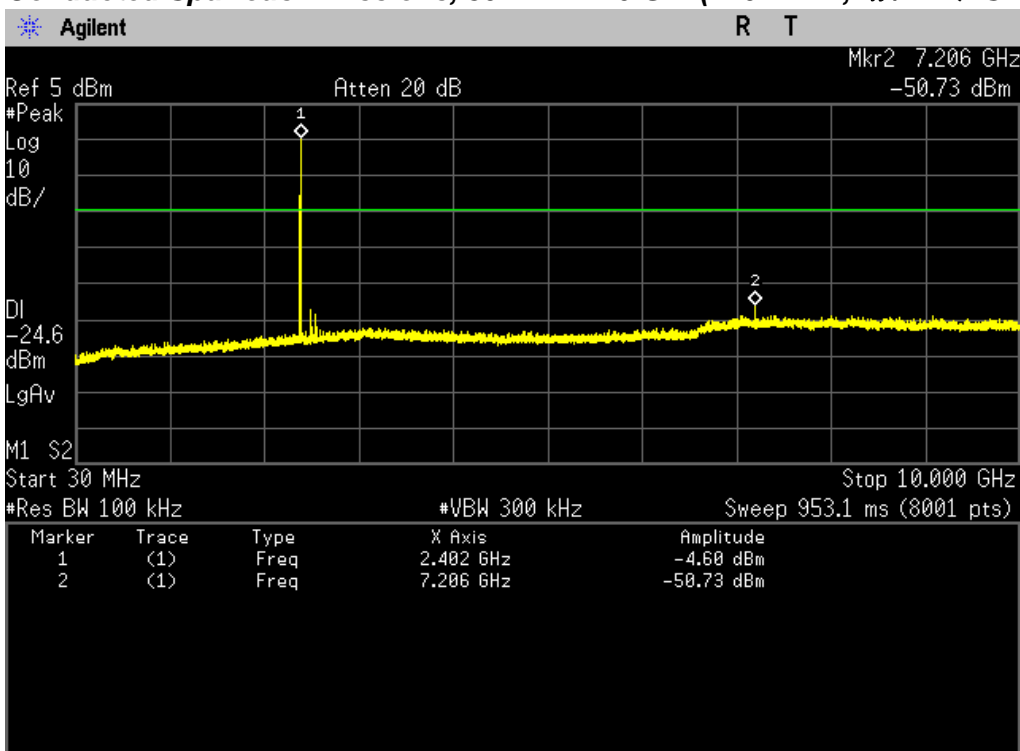

Conducted Spurious Emissions, 10 GHz ~ 25 GHz(2402 MHz, $\pi/4$ DQPSK Mode)

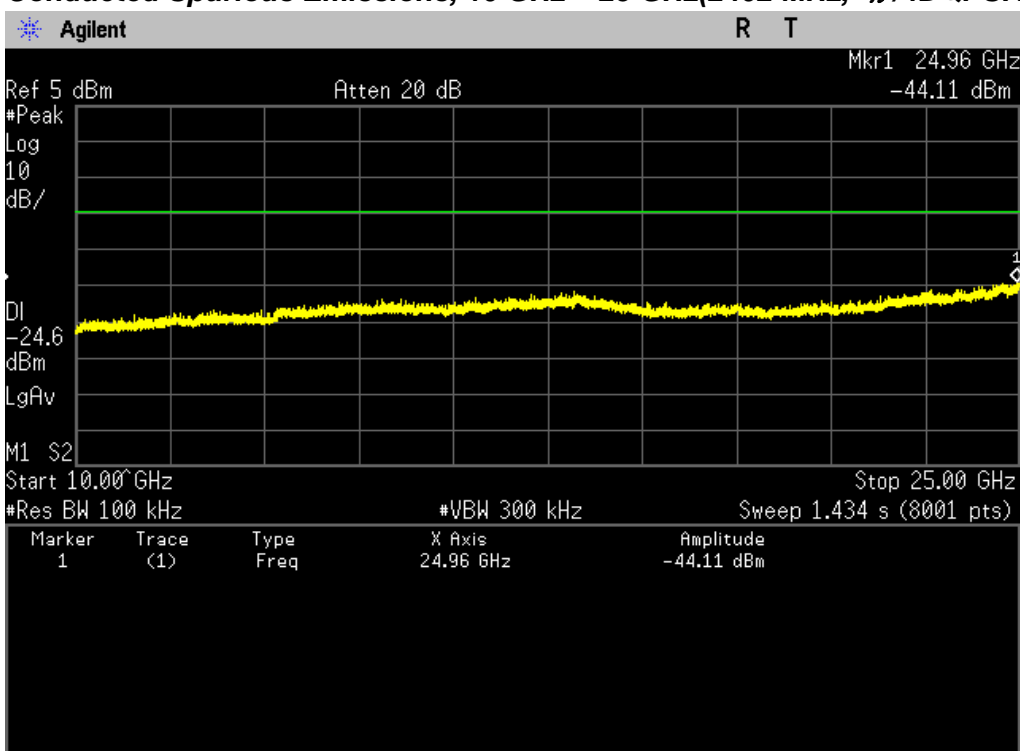

PLOT OF TEST DATA

Conducted Spurious Emissions, 30 MHz ~ 10 GHz(2441 MHz, $\pi/4$ DQPSK Mode)

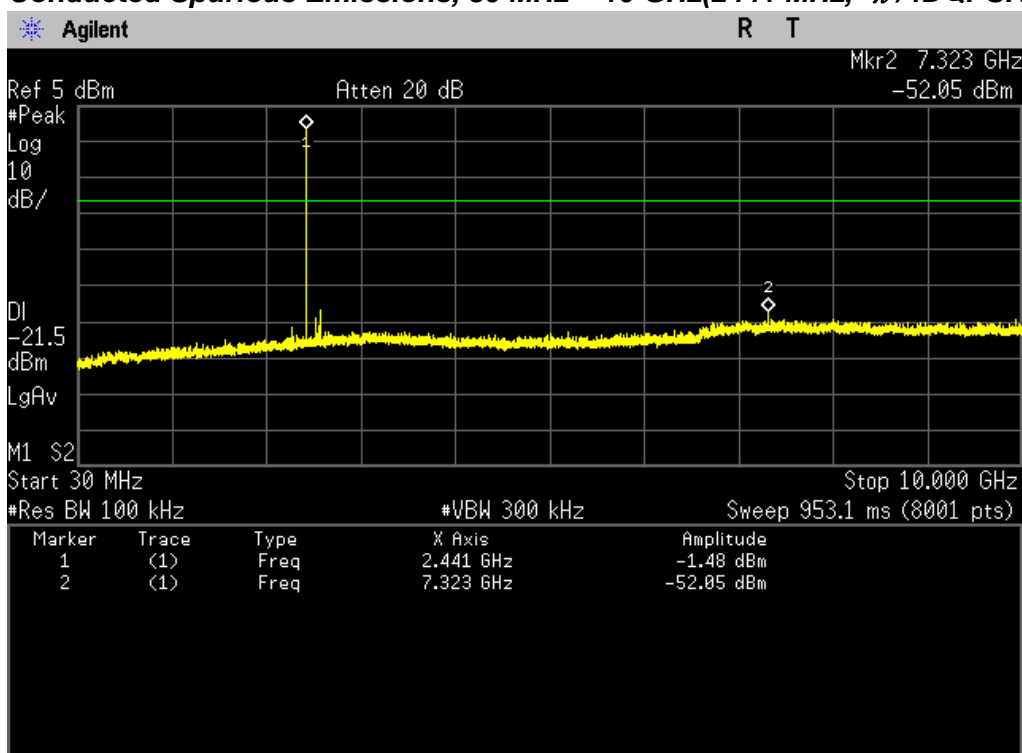

Conducted Spurious Emissions, 10 GHz ~ 25GHz(2441 MHz, $\pi/4$ DQPSK Mode)

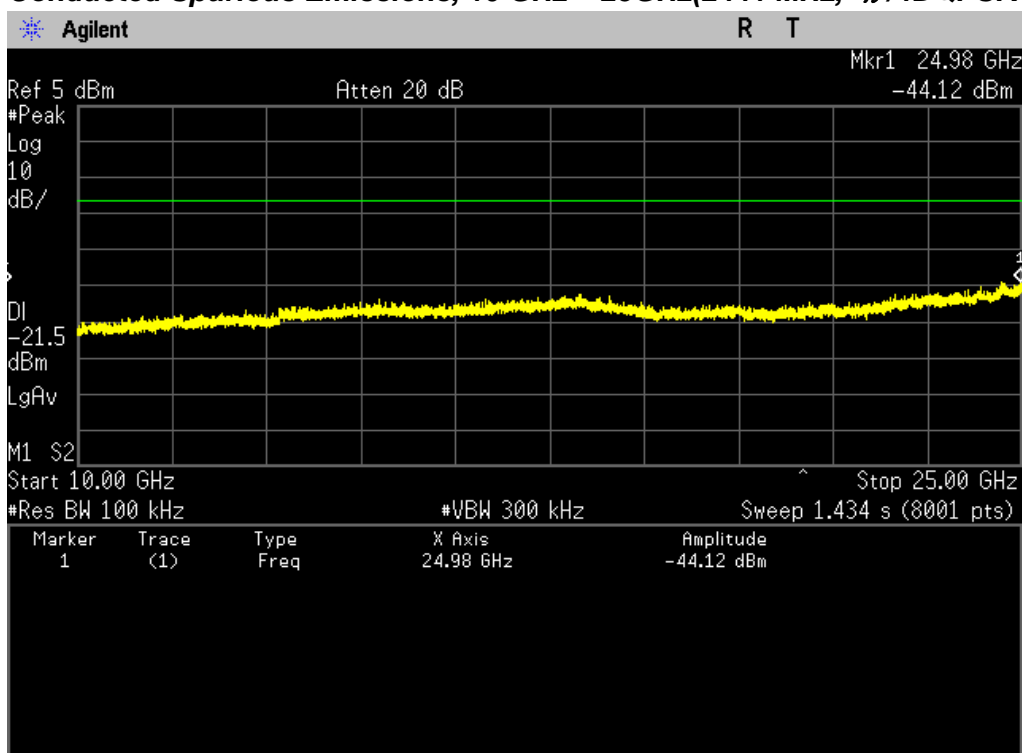

PLOT OF TEST DATA

Conducted Spurious Emissions, 30 MHz ~ 10 GHz(2480 MHz, $\pi/4$ DQPSK Mode)

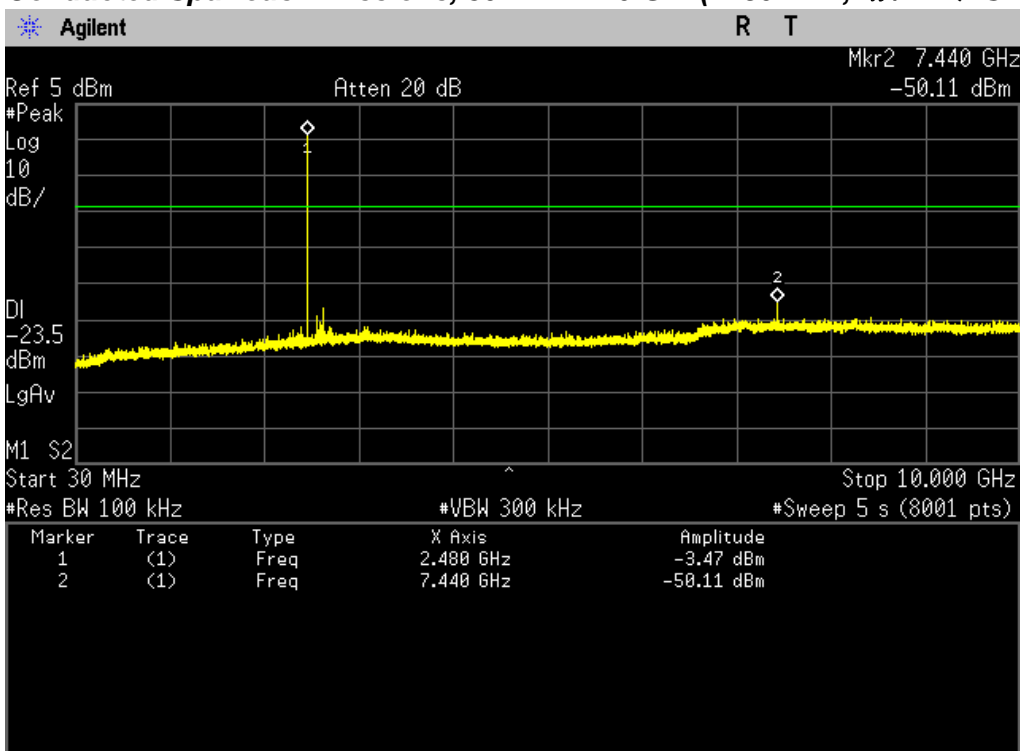

Conducted Spurious Emissions, 10 GHz ~ 25 GHz(2480 MHz, $\pi/4$ DQPSK Mode)

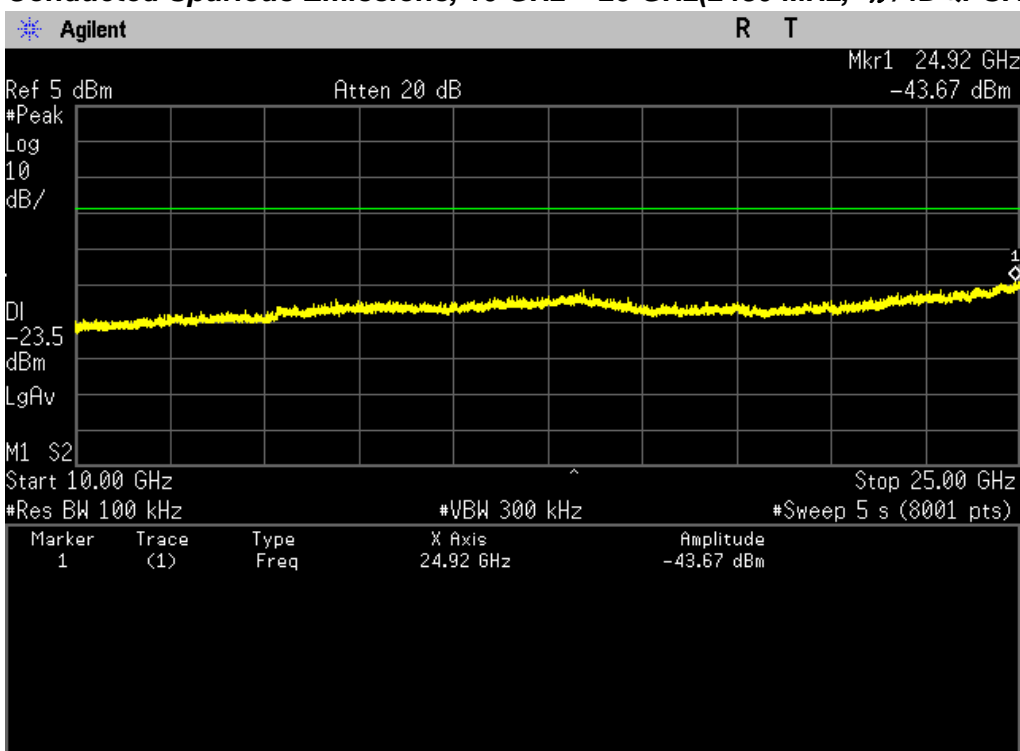

PLOT OF TEST DATA

Conducted Spurious Emissions, 30 MHz ~ 10 GHz(2402 MHz, 8DPSK Mode)

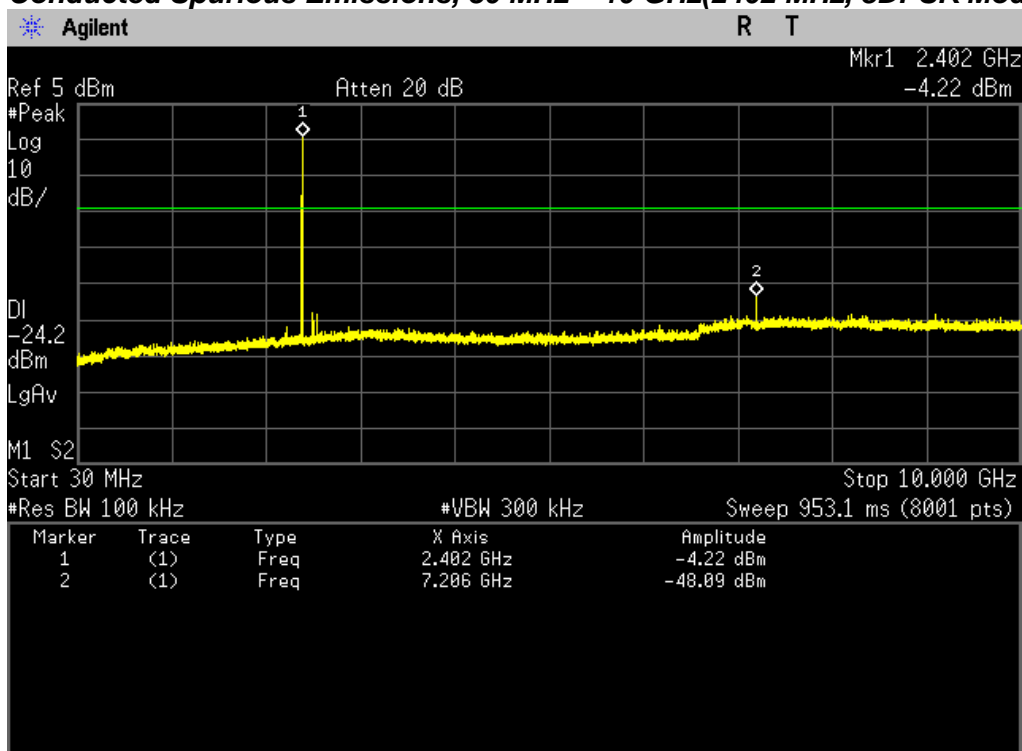

Conducted Spurious Emissions, 10 GHz ~ 25 GHz(2402 MHz, 8DPSK Mode)

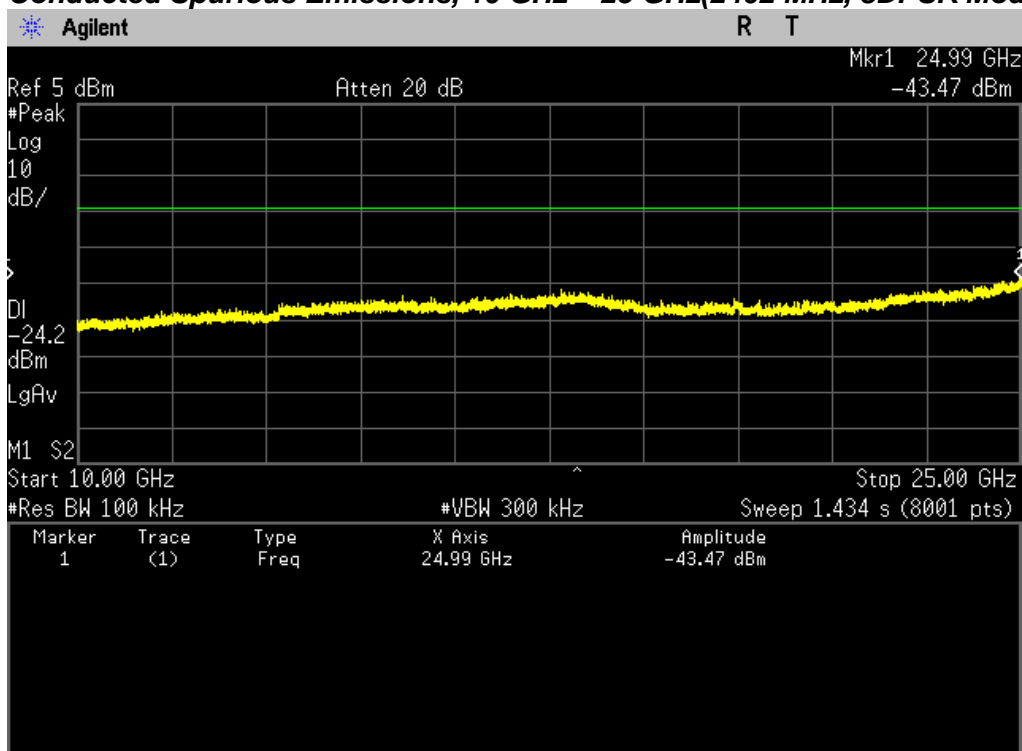

PLOT OF TEST DATA

Conducted Spurious Emissions, 30 MHz ~ 10 GHz(2441 MHz, 8DPSK Mode)

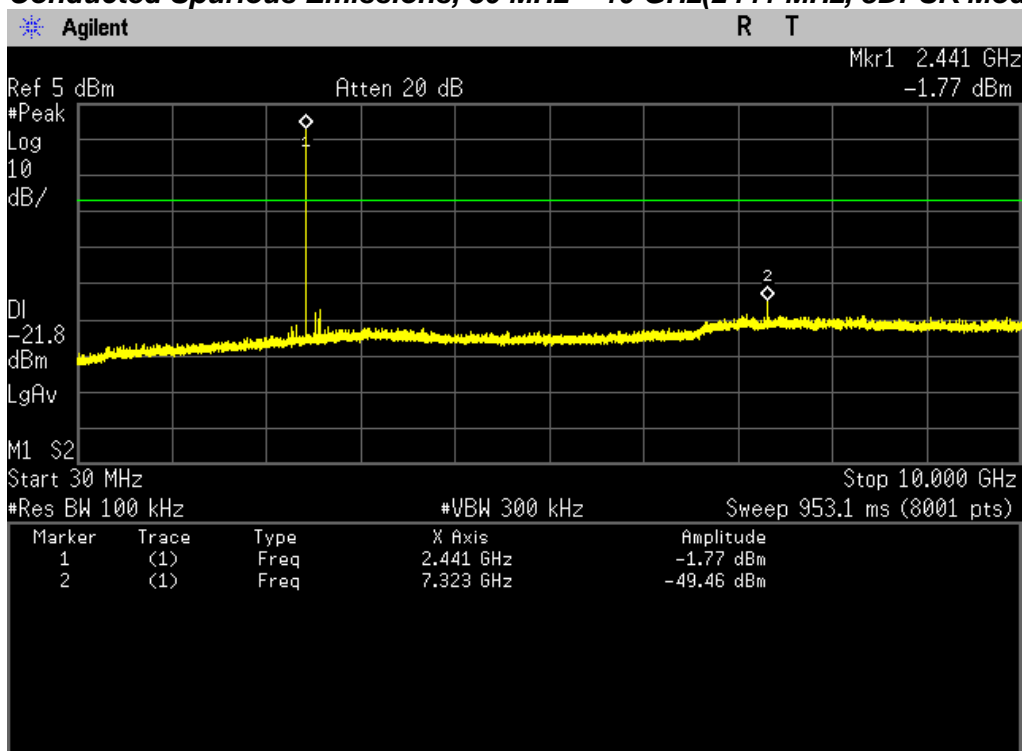

Conducted Spurious Emissions, 10 GHz ~ 25GHz(2441 MHz, 8DPSK Mode)

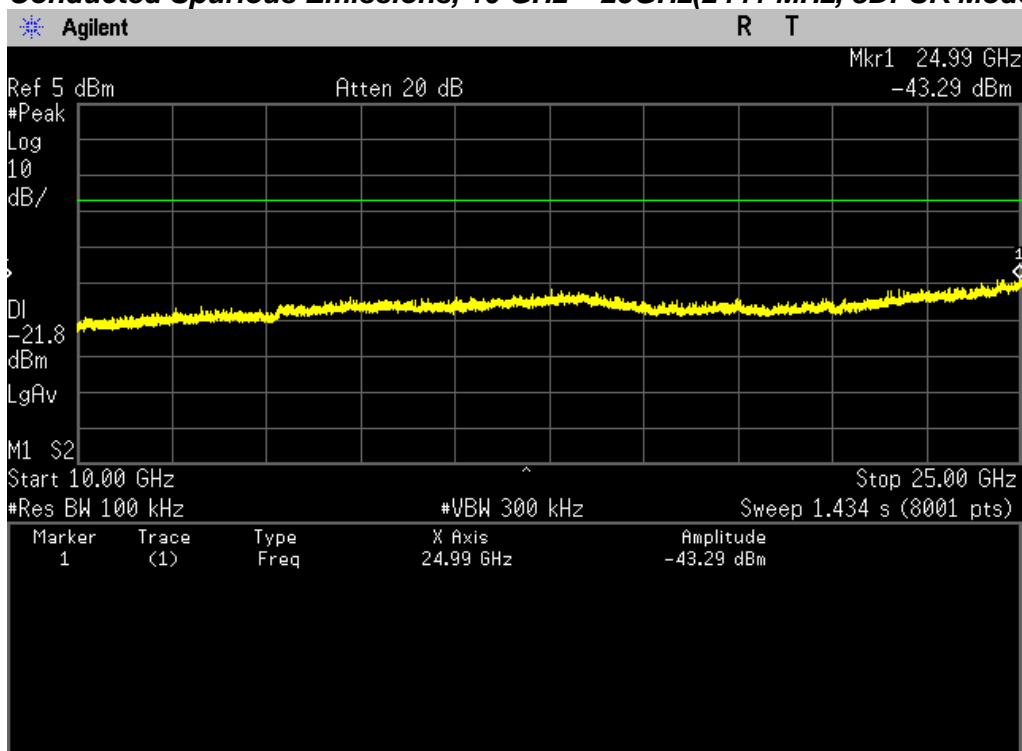

PLOT OF TEST DATA

Conducted Spurious Emissions, 30 MHz ~ 10 GHz(2480 MHz, 8DPSK Mode)

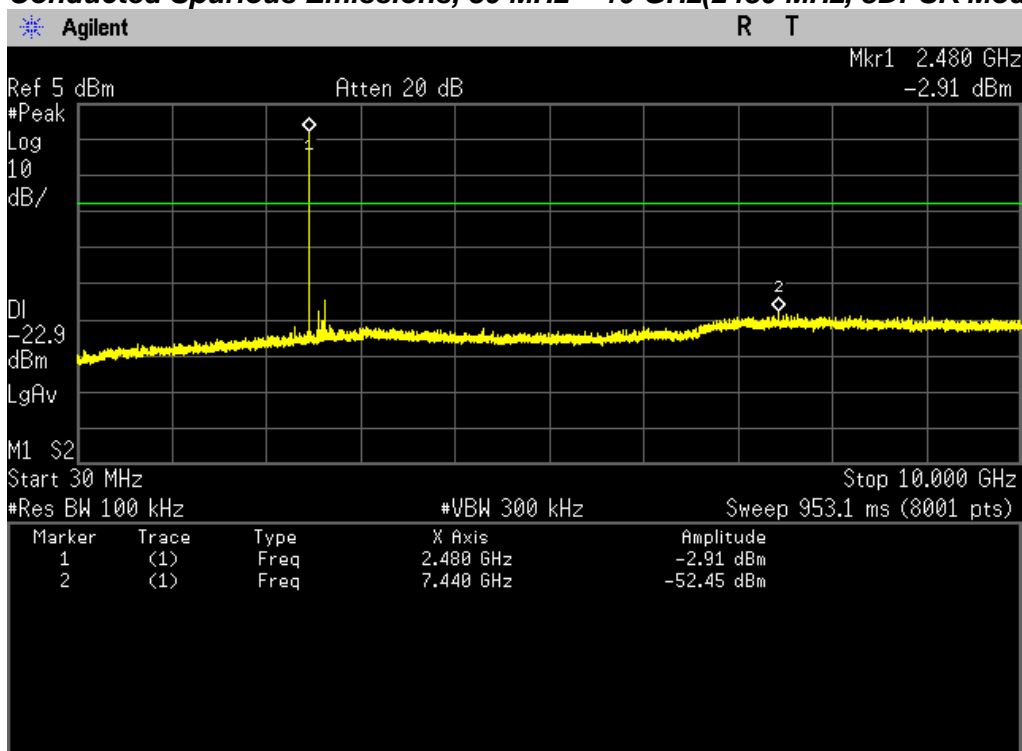

Conducted Spurious Emissions, 10 GHz ~ 25 GHz(2480 MHz, 8DPSK Mode)

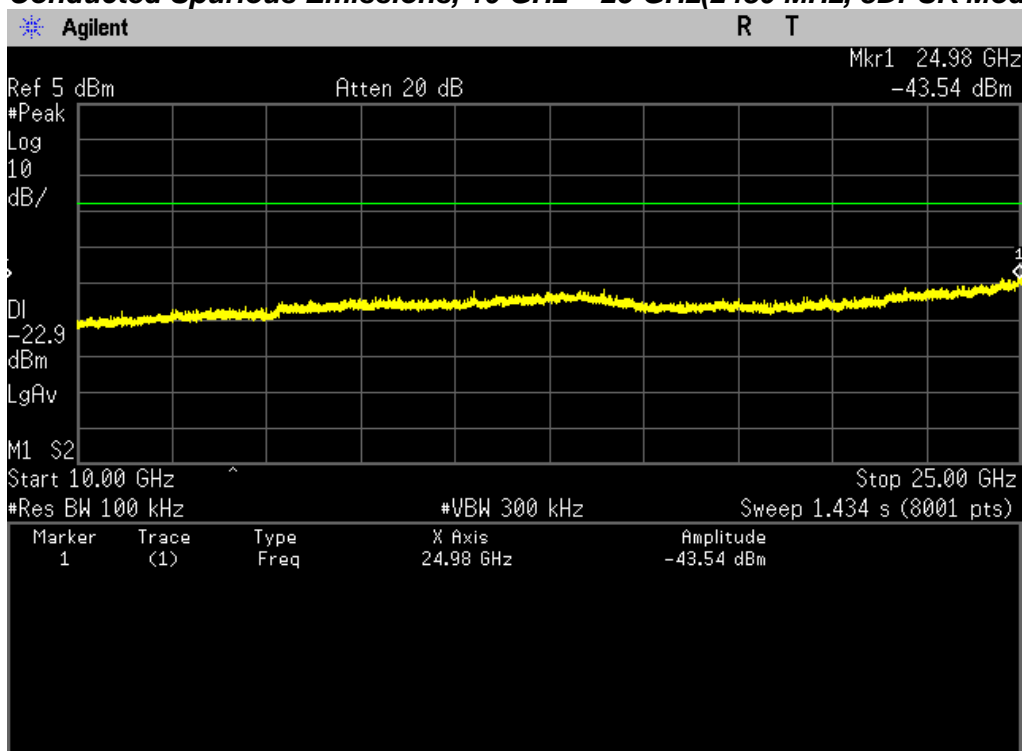

PLOT OF TEST DATA

Band Edge Lowest Channel(2402 MHz, GFSK)_ Non-hopping mode

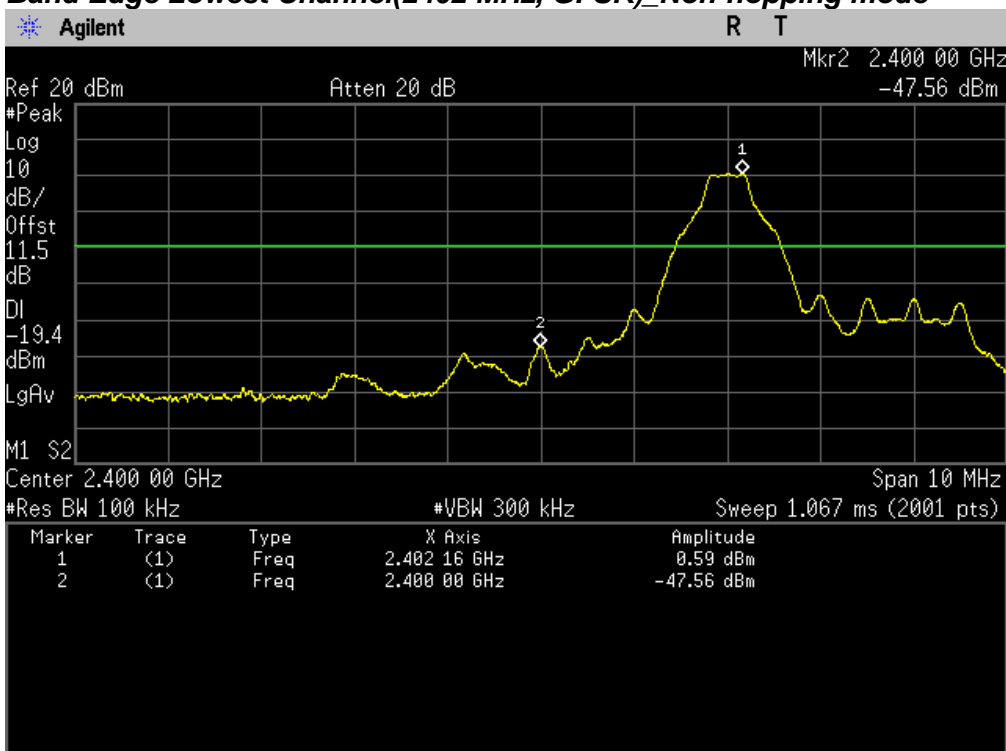

Band Edge Lowest Channel(2402 MHz, GFSK)_ Hopping mode

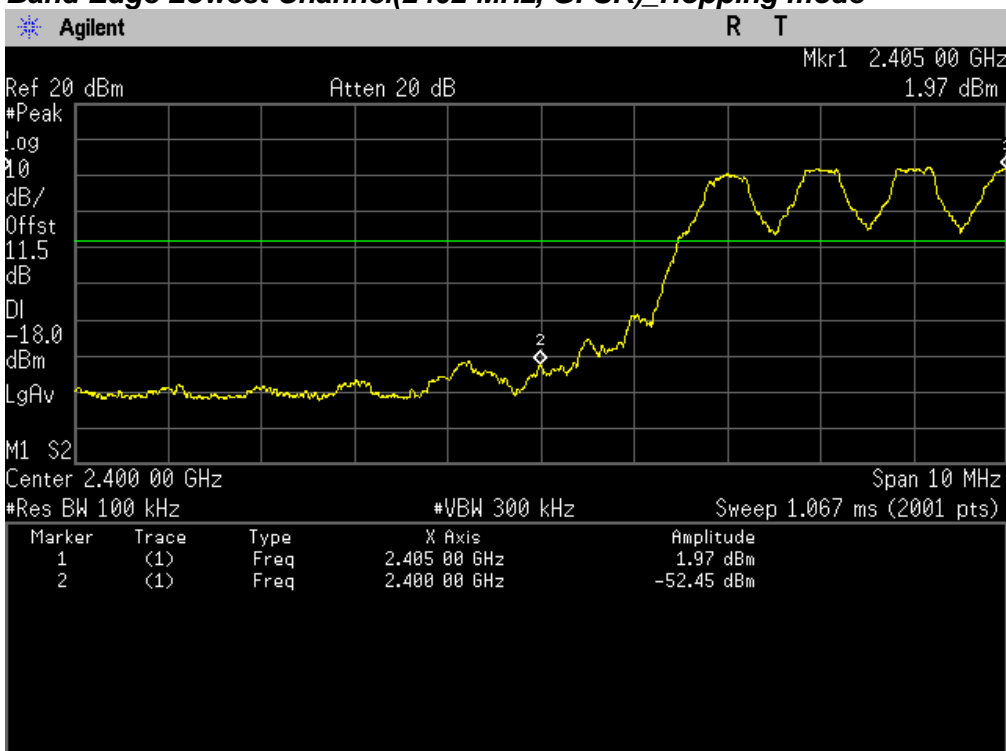

PLOT OF TEST DATA

Band Edge Highest Channel(2480 MHz, GFSK)_Non-hopping mode

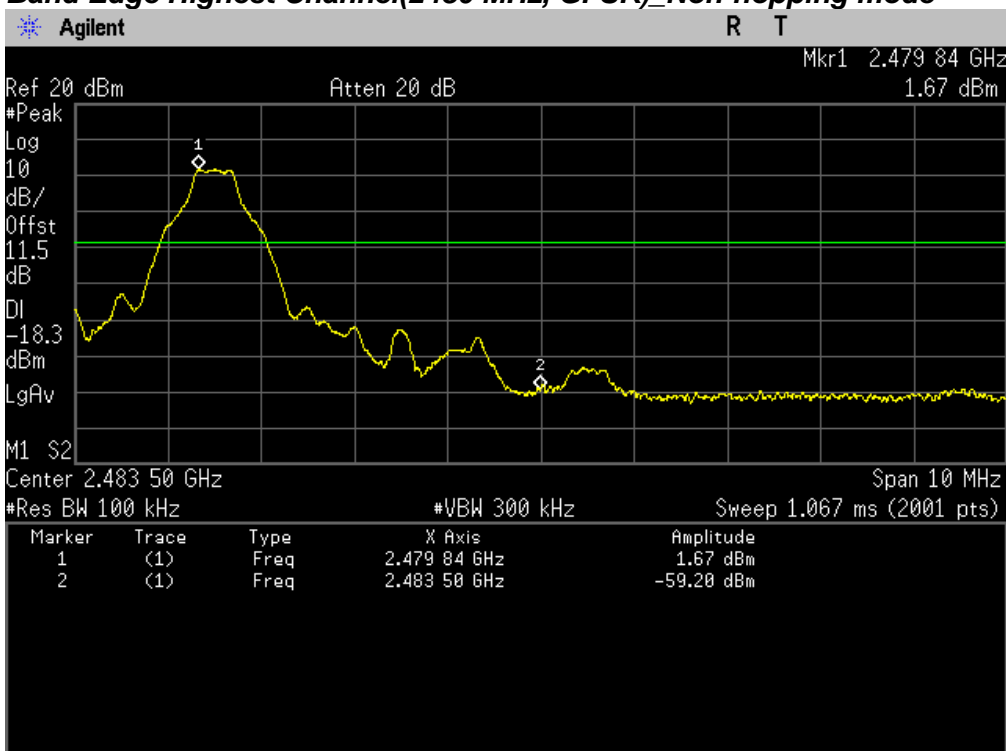

Band Edge Highest Channel(2480 MHz, GFSK)_Hopping mode

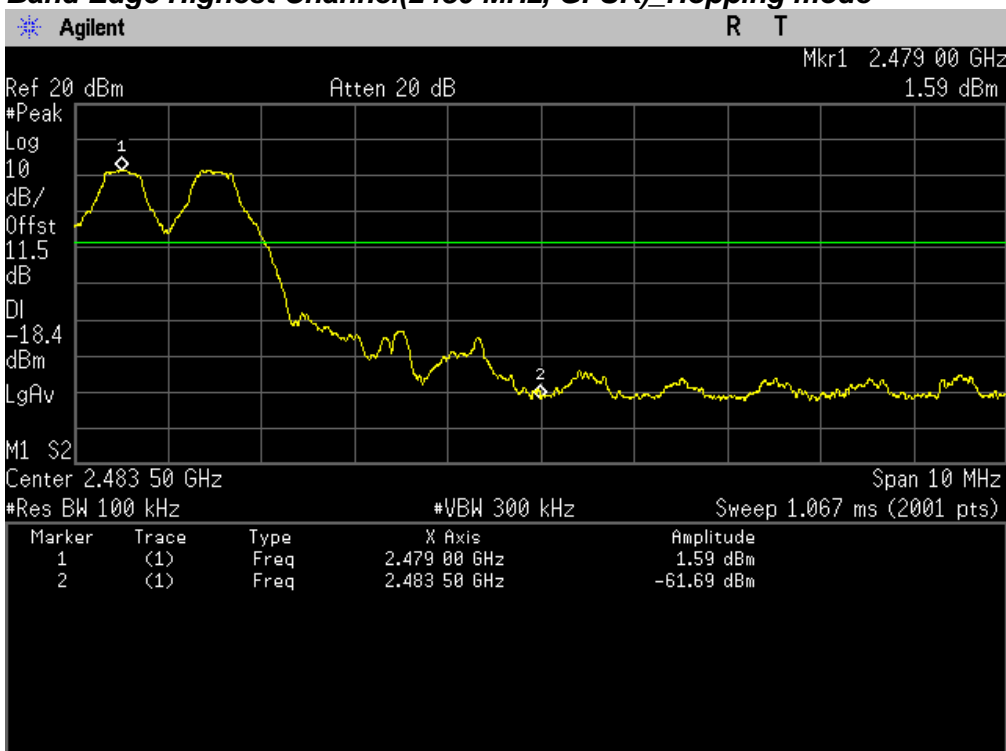

PLOT OF TEST DATA

Band Edge Lowest Channel(2402 MHz, $\pi/4$ DQPSK Mode)_Non-hopping mode

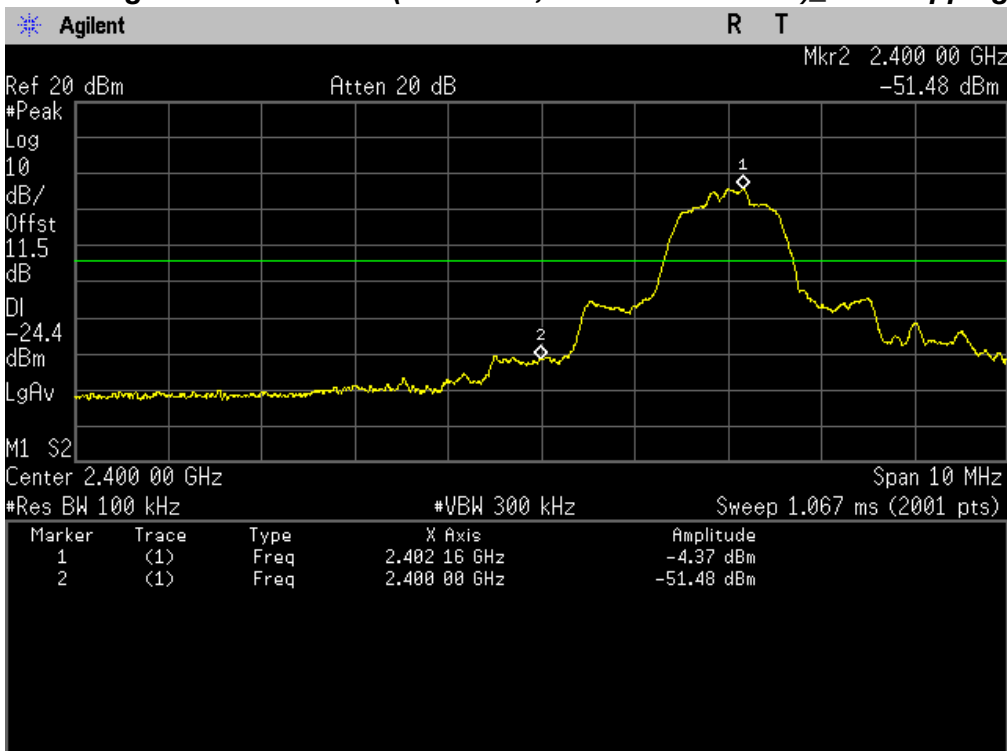

Band Edge Lowest Channel(2402 MHz, $\pi/4$ DQPSK Mode)_Hopping mode

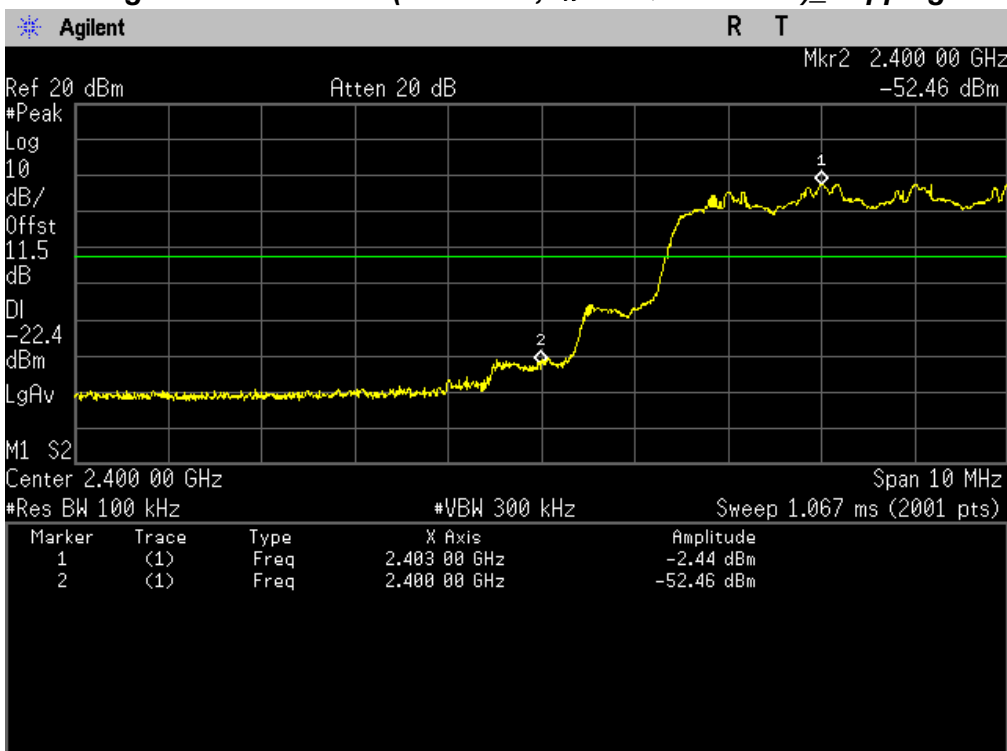

PLOT OF TEST DATA

Band Edge Highest Channel(2480 MHz, $\pi/4$ DQPSK Mode)_Non-hopping mode

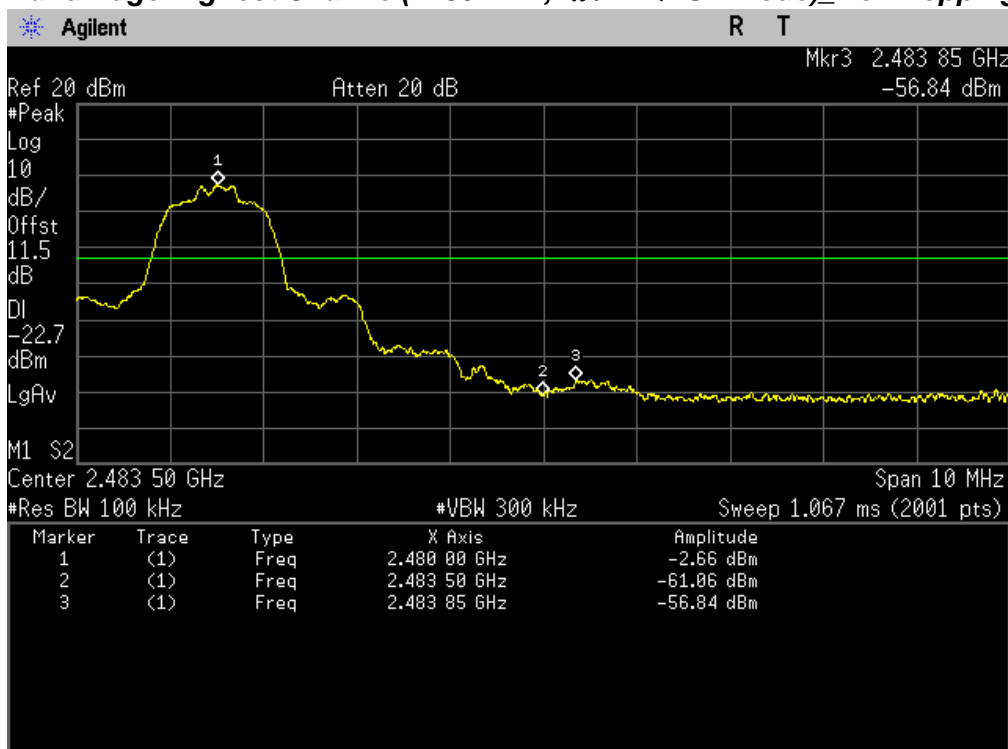

Band Edge Highest Channel(2480 MHz, $\pi/4$ DQPSK Mode)_Hopping mode

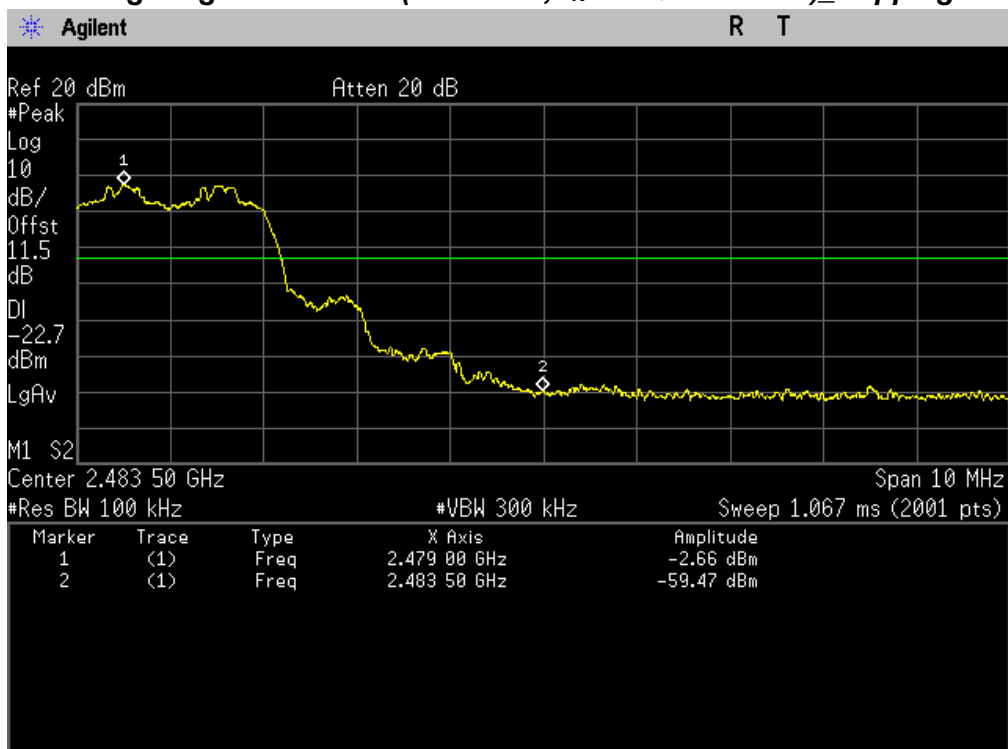

PLOT OF TEST DATA

Band Edge Lowest Channel(2402 MHz, 8DPSK)_ Non-hopping mode

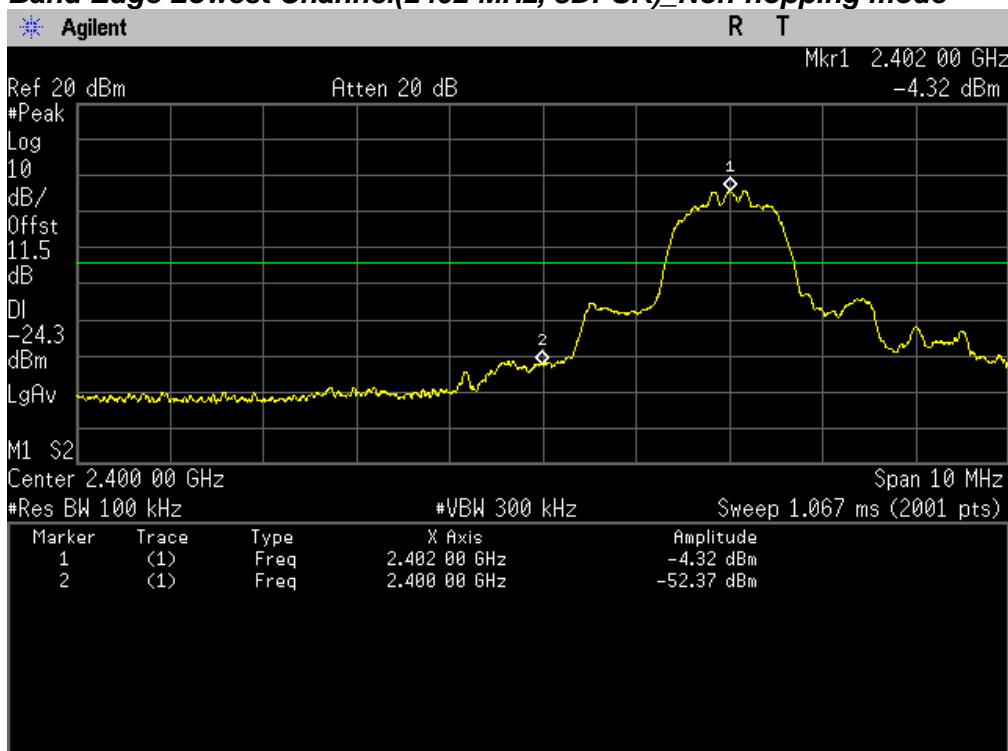

Band Edge Lowest Channel(2402 MHz, 8DPSK)_ Hopping mode

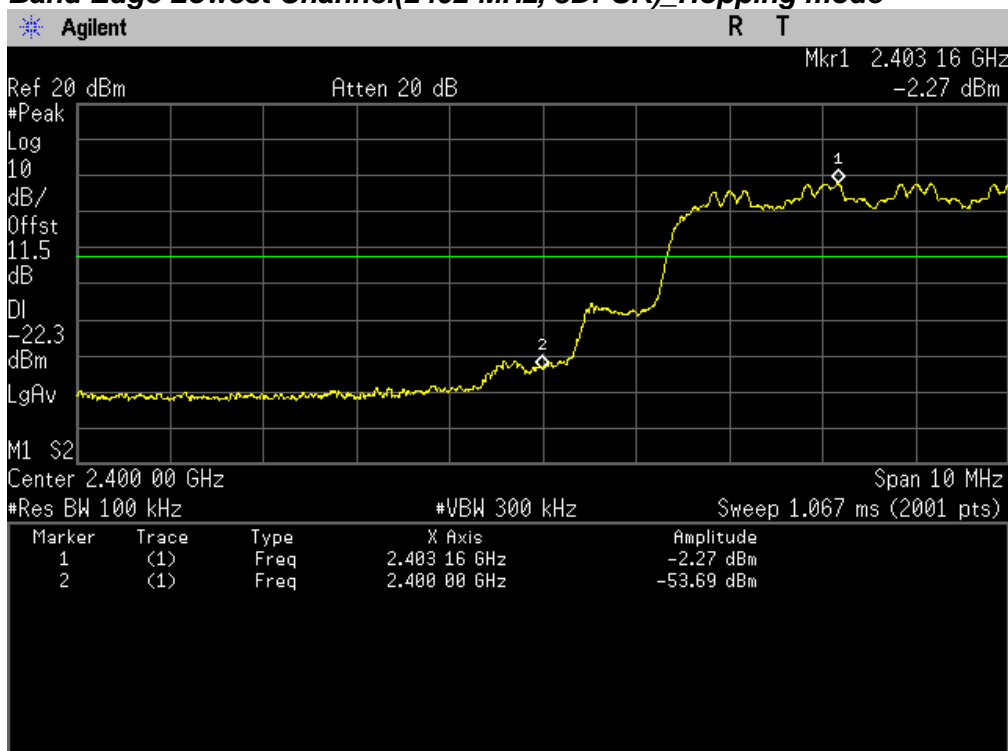

PLOT OF TEST DATA

Band Edge Highest Channel(2480 MHz, 8DPSK)_Non-hopping mode

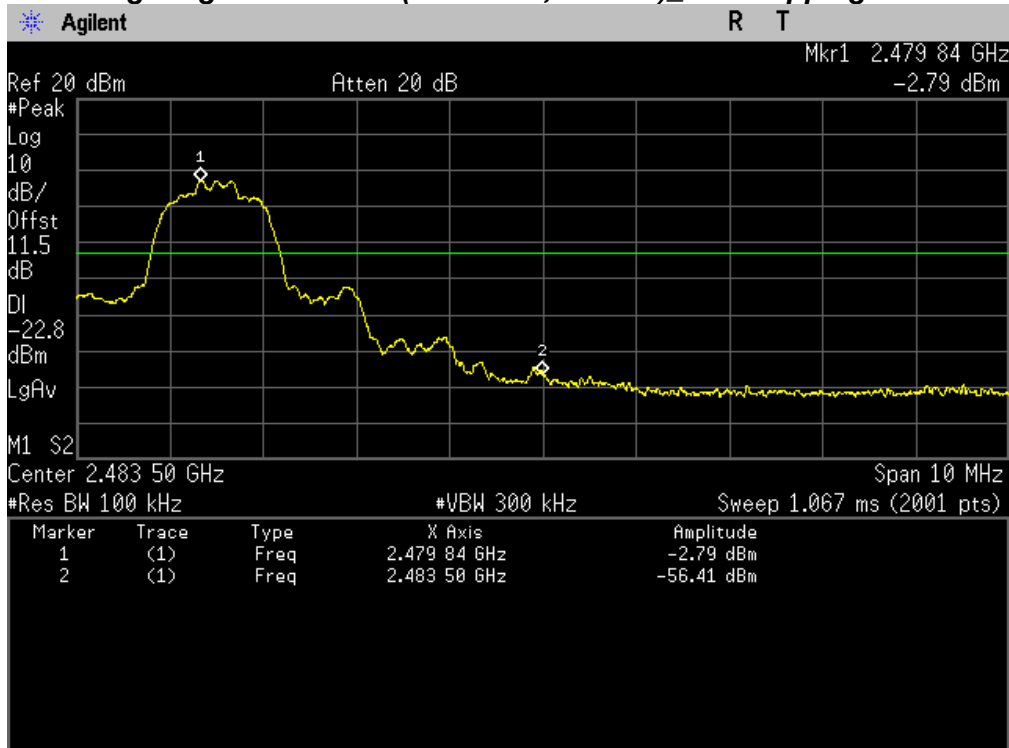

Band Edge Highest Channel(2480 MHz, 8DPSK)_Hopping mode

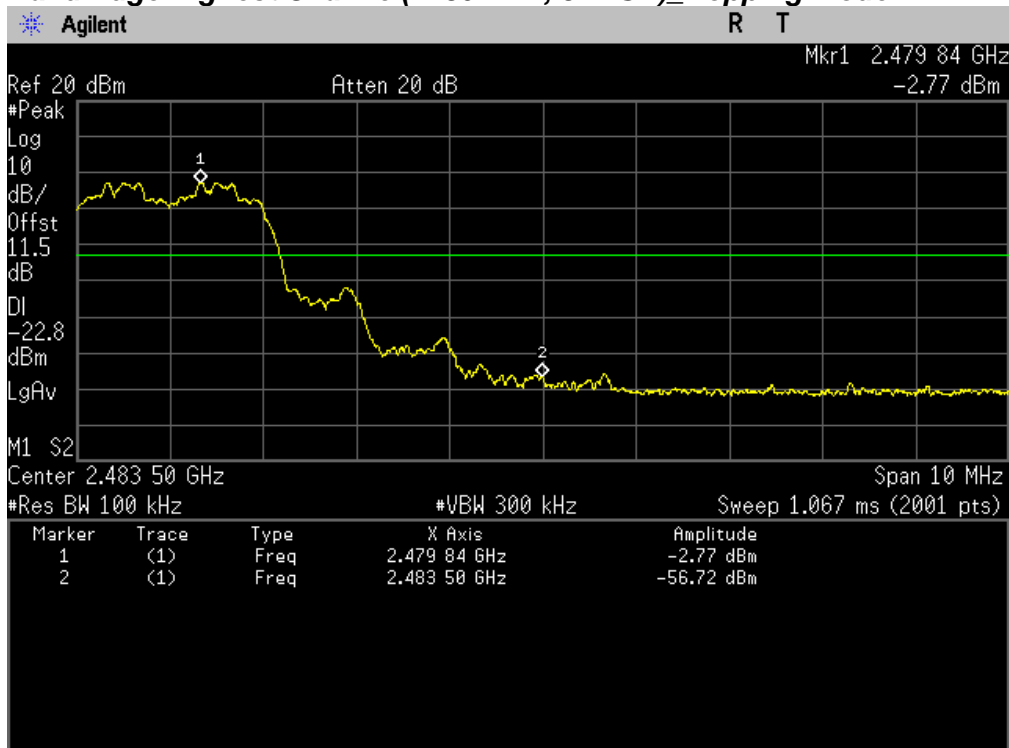

TEST DATA

8.9 Radiated Spurious Emission

FCC §15.247(d), IC RSS-210 A8.5

Test Mode : Set to Lowest channel, Middle channel and Highest channel

Result:

Lowest Channel

Frequency (MHz)	Reading (dBµV)	Pol* (H/V)	mode	AF+CL+Amp (dB)**	Result (dBµV/m)	Limit (dBµV/m)	Margin (dB)
1080.00	45.7	V	peak	-4.6	41.1	74.0	32.9
1080.00	37.1	V	average	-4.6	32.5	54.0	21.5
1106.50	45.4	V	peak	-4.6	40.8	74.0	33.2
1106.50	36.0	V	average	-4.6	31.4	54.0	22.6
1500.00	44.5	H	peak	-3.5	41.0	74.0	33.0
1500.00	34.7	H	average	-3.5	31.2	54.0	22.8
2246.00	43.4	H	peak	-1.3	42.1	74.0	31.9
2246.00	37.1	H	average	-1.3	35.8	54.0	18.2
2298.00	42.1	H	peak	-1.1	41.0	74.0	33.0
2298.00	35.3	H	average	-1.1	34.2	54.0	19.8
4804.00	45.0	V	peak	9.0	54.0	74.0	20.0
4804.00	39.8	V	average	9.0	48.8	54.0	5.2

TEST DATA

Middle Channel

Frequency (MHz)	Reading (dBμV)	Pol* (H/V)	mode	AF+CL+Amp (dB)**	Result (dBμV/m)	Limit (dBμV/m)	Margin (dB)
1080.00	46.0	V	peak	-4.6	41.4	74.0	32.6
1080.00	37.1	V	average	-4.6	32.5	54.0	21.5
2285.00	42.4	H	peak	-1.2	41.2	74.0	32.8
2285.00	34.8	H	average	-1.2	33.6	54.0	20.4
2311.00	42.0	H	peak	-1.1	40.9	74.0	33.1
2311.00	35.3	H	average	-1.1	34.2	54.0	19.8
2337.00	43.6	H	peak	-0.9	42.7	74.0	31.3
2337.00	35.2	H	average	-0.9	34.3	54.0	19.7
2493.00	44.1	H	peak	-0.3	43.8	74.0	30.2
2493.00	38.6	H	average	-0.3	38.3	54.0	15.7
4882.00	47.5	V	peak	9.2	56.7	74.0	17.3
4882.00	42.4	V	average	9.2	51.6	54.0	2.4
7323.00	40.9	H	peak	15.7	56.6	74.0	17.4
7323.00	34.6	H	average	15.7	50.3	54.0	3.7

TEST DATA

Highest Channel

Frequency (MHz)	Reading (dB μ V)	Pol* (H/V)	mode	AF+CL+Amp (dB)**	Result (dB μ V/m)	Limit (dB μ V/m)	Margin (dB)
1500.00	43.7	H	peak	-3.5	40.2	74.0	33.8
1500.00	36.8	H	average	-3.5	33.3	54.0	20.7
2324.00	44.0	H	peak	-1.0	43.0	74.0	31.0
2324.00	36.5	H	average	-1.0	35.5	54.0	18.5
2350.50	42.8	H	peak	-0.8	42.0	74.0	32.0
2350.50	36.1	H	average	-0.8	35.3	54.0	18.7
2376.00	42.4	H	peak	-0.8	41.6	74.0	32.4
2376.00	37.4	H	average	-0.8	36.6	54.0	17.4
2584.00	47.6	H	peak	0.0	47.6	74.0	26.4
2584.00	44.7	H	average	0.0	44.7	54.0	9.3
4960.00	45.8	V	peak	9.4	55.2	74.0	18.8
4960.00	40.6	V	average	9.4	50.0	54.0	4.0
7440.00	41.6	H	peak	15.8	57.4	74.0	16.6
7440.00	34.1	H	average	15.8	49.9	54.0	4.1

Note:

1. *Pol. H = Horizontal V = Vertical
2. **AF + CL + Amp. = Antenna Factor + Cable Loss + Amplifier.
3. Other spurious was under 20 dB below Fundamental.
4. GFSK modulation was the worst condition.
5. For measurements the resolution bandwidth was set to 1 MHz, and then the video bandwidth was set to 1 MHz for peak measurements and 10 Hz for average measurements with peak detector.
6. The spectrum was measured from 9 kHz to 10th harmonic and the worst-case emissions were reported. No significant emissions were found beyond the fifth harmonic for this device.

TEST DATA

8.10 Radiated Restricted Band Edge

FCC §15.247(d), IC RSS-210 A8.5

Test Mode : Set to Lowest channel, Middle channel and Highest channel

GFSK mode

Lowest Channel

Frequency (MHz)	Reading (dBµV)	Pol* (H/V)	mode	AF+CL+Amp (dB)**	Result (dBµV/m)	Limit (dBµV/m)	Margin (dB)
2389.98	42.40	H	peak	-0.80	41.60	74.0	32.40
2389.98	30.30	H	average	-0.80	29.50	54.0	24.50

Highest Channel

Frequency (MHz)	Reading (dBµV)	Pol* (H/V)	mode	AF+CL+Amp (dB)**	Result (dBµV/m)	Limit (dBµV/m)	Margin (dB)
2483.50	62.70	H	peak	-0.20	62.50	74.0	11.50
2483.50	41.20	H	average	-0.20	38.13	54.0	15.87

8DPSK

Lowest Channel

Frequency (MHz)	Reading (dBµV)	Pol* (H/V)	mode	AF+CL+Amp (dB)**	Result (dBµV/m)	Limit (dBµV/m)	Margin (dB)
2389.98	41.20	H	peak	-0.80	40.40	74.0	33.60
2389.98	29.50	H	average	-0.80	28.70	54.0	25.30

Highest Channel

Frequency (MHz)	Reading (dBµV)	Pol* (H/V)	mode	AF+CL+Amp (dB)**	Result (dBµV/m)	Limit (dBµV/m)	Margin (dB)
2483.50	59.50	H	peak	-0.20	59.30	74.0	14.70
2483.50	41.20	H	average	-0.20	41.50	54.0	12.50

Note:

1. *Pol. H = Horizontal V = Vertical
2. **AF + CL + Amp. = Antenna Factor + Cable Loss + Amplifier.
3. The result of 8DPSK modulation was recorded which was the worst condition in EDR mode.
4. For measurements the resolution bandwidth was set to 1 MHz, and then the video bandwidth was set to 1 MHz for peak measurements and 10 Hz for average measurements with peak detector.

9. TEST EQUIPMENT

No.	Instrument	Manufacturer	Model	Serial No.	Calibration Date	Calibration Interval
1	*Test Receiver	R & S	ESCS 30	833364/020	Jan. 12 2012	1 year
2	*Test Receiver	R & S	ESCS 30	100302	Oct. 08 2012	1 year
3	*Amplifier	HP	8447F	2805A03427	Jul. 17 2012	1 year
4	*Amplifier	Sonoma Instrument	310N	291916	Jul. 16 2012	1 year
5	*Amplifier	R & S	SCU18	10065	Apr. 05 2012	1 year
6	*Amplifier	R & S	SCU26	10011	Jun. 01 2012	1 year
7	Amplifier	R & S	SCU40	10008	Jun. 01 2012	1 year
8	*Pre Amplifier	HP	8449B	3008A00107	Jan. 13 2012	1 year
9	*Pre Amplifier	HP	8447F	2805A03351	Jul. 17 2012	1 year
10	*Spectrum Analyzer	Agilent	E4440A	MY44303257	Jul. 16 2012	1 year
11	*Spectrum Analyzer	Agilent	E4440A	MY44022567	Apr. 05 2012	1 year
12	*Spectrum Analyzer	R & S	FSP40	100361	Jul. 17 2012	1 year
13	*Loop Antenna	R & S	HFH2-Z2	100279	Feb. 21 2012	2 year
14	Wideband Power Sensor	R & S	NRP-Z81	100634	Apr. 05 2012	1 year
15	*Biconical Log Antenna	ARA	LPB-2520/A	1180	Apr. 26 2012	2 year
16	*Horn Antenna	SCHWARZBECK	BBHA9120D	9120D-474	Aug. 13 2012	2 year
17	*Horn Antenna	Q-par Angus	QSH20S20	8179	Mar. 28 2011	2 year
18	Horn Antenna	Q-par Angus	QSH22K20	8180	Mar. 28 2011	2 year
19	*Trilog-Broadband Antenna	SCHWARZBECK	VULB 9163	9163-454	Feb. 24 2012	2 year
20	Trilog-Broadband Antenna	SCHWARZBECK	VULB 9168	9168-257	Apr. 26 2012	2 year
21	*LISN	R & S	ESH3-Z5	833874/006	Oct. 08 2012	1 year
22	*LISN	R & S	ESH2-Z5	100227	Apr. 04 2012	1 year
23	*Position Controller	DAEIL EMC	N/A	N/A	N/A	N/A
24	*Turn Table	DAEIL EMC	N/A	N/A	N/A	N/A
25	*Antenna Mast	DAEIL EMC	N/A	N/A	N/A	N/A
26	*Anechoic Chamber	EM Eng.	N/A	N/A	N/A	N/A
27	*Shielded Room	EM Eng.	N/A	N/A	N/A	N/A
28	*Position Controller	Seo-Young EMC	N/A	N/A	N/A	N/A
29	*Turn Table	Seo-Young EMC	N/A	N/A	N/A	N/A
30	*Antenna Mast	Seo-Young EMC	N/A	N/A	N/A	N/A
31	*Anechoic Chamber	Seo-Young EMC	N/A	N/A	N/A	N/A
32	*Shielded Room	Seo-Young EMC	N/A	N/A	N/A	N/A

*) Test equipment used during the test

10. ACCURACY OF MEASUREMENT

The Measurement Uncertainties stated were calculated in accordance with the requirements of measurement uncertainty contained in CISPR 16-4-2 with the confidence level of 95%

1. Conducted Uncertainty Calculation

Source of Uncertainty	X_i	Uncertainty of X_i		Coverage factor k	$u(X_i)$ (dB)	C_i	$C_i u(X_i)$ (dB)
		Value (dB)	Probability Distribution				
Receiver reading	RI	± 0.1	normal 1	1.000	0.1	1	0.1
Attenuation AMN-Receiver	LC	± 0.08	normal 2	2.000	0.04	1	0.04
AMN Voltage division factor	LAMN	± 0.8	normal 2	2.000	0.4	1	0.4
Sine wave voltage	dVSW	± 2.00	normal 2	2.000	1.00	1	1.00
Pulse amplitude response	dVPA	± 1.50	rectangular	1.732	0.87	1	0.87
Pulse repetition rate response	dVPR	± 1.50	rectangular	1.732	0.87	1	0.87
Noise floor proximity	dVNF	± 0.00	-	-	0.00	1	0.00
AMN Impedance	dZ	± 1.80	triangular	2.449	0.73	1	0.73
Ⓐ Mismatch	M	+ 0.70	U-Shaped	1.414	0.49	1	0.49
Ⓑ Mismatch	M	- 0.80	U-Shaped	1.414	- 0.56	1	- 0.56
Measurement System Repeatability	RS	0.05	normal 1	1.000	0.05	1	0.05
Remark	Ⓐ: AMN-Receiver Mismatch : + Ⓑ: AMN-Receiver Mismatch : -						
Combined Standard Uncertainty	Normal			± 1.88			
Expanded Uncertainty U	Normal ($k = 2$)			± 3.76			

2. Radiation Uncertainty Calculation

Source of Uncertainty	X_i	Uncertainty of X_i		Coverage factor k	$u(X_i)$ (dB)	C_i	$C_i u(X_i)$ (dB)
		Value (dB)	Probability Distribution				
Receiver reading	RI	± 0.10	normal 1	1.000	0.10	1	0.10
Sine wave voltage	dVsw	± 2.00	normal 2	2.000	1.00	1	1.00
Pulse amplitude response	dVpa	± 1.50	rectangular	1.732	0.87	1	0.87
Pulse repetition rate response	dVpr	± 1.50	rectangular	1.732	0.87	1	0.87
Noise floor proximity	dVnf	± 0.50	normal 2	2.000	0.25	1	0.25
Antenna Factor Calibration	AF	± 1.50	normal 2	2.000	0.75	1	0.75
Attenuation Antenna-receiver	CL	± 0.52	normal 2	2.000	0.26	1	0.26
Antenna Directivity	AD	± 1.00	rectangular	1.732	0.58	1	0.58
Antenna Factor Height Dependence	AH	± 0.50	rectangular	1.732	0.29	1	0.29
Antenna Phase Centre Variation	AP	± 0.30	rectangular	1.732	0.17	1	0.17
Antenna Factor Frequency Interpolation	AI	± 0.30	rectangular	1.732	0.17	1	0.17
Site Imperfections	SI	± 4.00	triangular	2.449	1.63	1	1.63
Measurement Distance Variation	DV	± 0.10	rectangular	1.732	0.06	1	0.06
Antenna Balance	Dbal	± 0.90	rectangular	1.732	0.52	1	0.52
Cross Polarisation	DCross	± 0.90	rectangular	1.732	0.52	1	0.52
Ⓐ Mismatch	M	+ 0.25	U-Shaped	1.414	0.18	1	0.18
Ⓑ Mismatch	M	- 0.26	U-Shaped	1.414	- 0.18	1	- 0.18
Ⓒ Mismatch	M	+ 0.98	U-Shaped	1.414	0.69	1	0.69
Ⓓ Mismatch	M	- 1.11	U-Shaped	1.414	- 0.79	1	- 0.79
Measurement System Repeatability	RS	0.09	normal 1	1.000	0.09	1	0.09
Remark	Ⓐ: Biconical Antenna-receiver Mismatch : + (< 200 MHz) Ⓑ: Biconical Antenna-receiver Mismatch : - (< 200 MHz) Ⓒ: Log Periodic Antenna-receiver Mismatch : + (≥ 200 MHz) Ⓓ: Log Periodic Antenna-receiver Mismatch : - (≥ 200 MHz)						
Combined Standard Uncertainty	Normal			± 2.63 (< 200 MHz) ± 2.74 (≥ 200 MHz)			
Expanded Uncertainty U	Normal ($k = 2$)			± 5.26 (< 200 MHz) ± 5.48 (≥ 200 MHz)			