





TEST REPORT

Report No.:	EM201300699-1	Application No.:	ZJ00032008
Client:	Harman International Industries, Incorporated		
Address:	8500 Balboa Blvd, Northridge, CA 91329, United States		
Sample Description:	Active speaker system with wireless streaming		
Model:	AUTHENTICS L8		
Adding Model:	/		
FCC ID	APIAUTHENL8		
Test Specification:	FCC Part 15,Subpart C:2012		
Test Date:	2013-08-08 to 2013-09-09		
Issue Date:	2013-09-10		
Test Result:	Pass.		
Prepared By:	Reviewed By:	Approved By:	
Lynn Xiao / Test Engineer	Jane Cao / Test Engineer	Gavin Wu / Manager	
			
Date:2013-09-10	Date:2013-09-10	Date:2013-09-10	
Other Aspects:			
/			
Abbreviations: ok / P = passed; fail / F = failed; n.a. / N = not applicable			
The test result in this test report refers exclusively to the presented test sample. This report shall not be reproduced except in full, without the written approval of GRGT.			

DIRECTIONS OF TEST

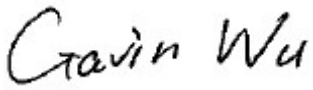
1. This station carries out test task according to the national regulation of verifications which can be traced to National Primary Standards and BIPM.
2. The test report merely corresponds to the test sample. It is not permitted to copy extracts of these test result without the written permission of the test laboratory.
3. If there is any objection concerning the test, the client should inform the laboratory within 15 days from the date of receiving the test report.

Table of Contents

- 1. TEST RESULT SUMMARY5**
- 2. GENERAL DESCRIPTION OF EUT6**
 - 2.1 APPLICANT6
 - 2.2 MANUFACTURER6
 - 2.3 BASIC DESCRIPTION OF EQUIPMENT UNDER TEST6
- 3. LABORATORY AND ACCREDITATIONS7**
 - 3.1 LABORATORY7
 - 3.2 ACCREDITATIONS.....7
 - 3.3 MEASUREMENT UNCERTAINTY7
 - 3.4 LIST OF USED TEST EQUIPMENT AT GRGT8
- 4. TEST RESULTS9**
 - 4.1 E.U.T. TEST CONDITIONS9
 - 4.2 ANTENNA REQUIREMENT.....11
 - 4.3 OCCUPIED BANDWIDTH.....12
 - 4.3.1 LIMITS.....12
 - 4.3.2 TEST PROCEDURES.....12
 - 4.3.3 TEST SETUP12
 - 4.3.4 TEST RESULTS12
 - 4.4 CARRIER FREQUENCIES SEPARATED16
 - 4.4.1 LIMITS.....16
 - 4.4.2 TEST PROCEDURES.....16
 - 4.4.3 TEST SETUP16
 - 4.4.4 TEST RESULTS16
 - 4.5 HOPPING CHANNEL NUMBER20
 - 4.5.1 LIMITS.....20
 - 4.5.2 TEST PROCEDURES.....20
 - 4.5.3 TEST SETUP20
 - 4.5.4 TEST RESULTS20
 - 4.6 DWELL TIME.....22
 - 4.6.1 LIMITS.....22
 - 4.6.2 TEST PROCEDURES.....22
 - 4.6.3 TEST SETUP22
 - 4.6.4 TEST RESULTS22
 - 4.7 CONDUCTED EMISSION MEASUREMENT39
 - 4.7.1 LIMITS.....39
 - 4.7.2 TEST PROCEDURES.....39
 - 4.7.3 TEST SETUP40
 - 4.7.4 TEST RESULTS41
 - 4.8 MAXIMUM PEAK OUTPUT POWER43
 - 4.8.1 LIMITS.....43
 - 4.8.2 TEST PROCEDURES.....43
 - 4.8.3 TEST SETUP43
 - 4.8.4 TEST RESULTS43
 - 4.9 CONDUCTED SPURIOUS EMISSIONS47
 - 4.9.1 LIMITS.....47
 - 4.9.2 TEST PROCEDURES.....47
 - 4.9.3 TEST SETUP47
 - 4.9.4 TEST RESULTS47
 - 4.10 RADIATED SPURIOUS EMISSIONS57
 - 4.10.1 LIMITS.....57
 - 4.10.2 TEST PROCEDURES.....57
 - 4.10.3 TEST SETUP58
 - 4.10.4 TEST RESULTS60
 - 4.11 BAND EDGES REQUIREMENT66
 - 4.11.1 LIMITS.....66
 - 4.11.2 TEST PROCEDURES.....66
 - 4.11.3 TEST SETUP66

4.11.4 TEST RESULTS66
4.11.5 Radiated Emissions which fall in the restricted bands69

1. TEST RESULT SUMMARY

Section B of FCC Part 15.247:2013			
Standard	Item	Limit / Severity	Result
FCC Part 15,Subpart C (15.247)	Antenna Requirement	Section 15.247 (c)	PASS
	Occupied Bandwidth	Section 15.247 (a1)	PASS
	Carrier Frequencies Separated	Section 15.247(a)(1)	PASS
	Hopping Channel Number	Section 15.247(a)(1)(iii)	PASS
	Dwell Time	Section 15.247(a)(1)(iii)	PASS
	Maximum Peak Output Power	Section 15.247(b)(1)	PASS
	Conducted Emission	Section 15.207	PASS
	Conducted Spurious Emission (30MHz to 25GHz)	Section 15.209 &15.247(d)	PASS
	Radiated Spurious Emission (30MHz to 25GHz)	Section 15.209 &15.247(d)	PASS
	Band Edges Measurement	Section 15.247 (d) &15.205	PASS

2. GENERAL DESCRIPTION OF EUT

2.1 APPLICANT

Name: Harman International Industries, Incorporated
Address: 8500 Balboa Blvd, Northridge, CA 91329, United States

2.2 MANUFACTURER

Name: Harman International Industries, Incorporated
Address: 8500 Balboa Blvd, Northridge, CA 91329, United States

2.3 BASIC DESCRIPTION OF EQUIPMENT UNDER TEST

Equipment: Active speaker system with wireless streaming
Model No.: JAUTHENTICS L8
Trade Name: JBL
Power supply AC 100-240V,50/60Hz
Frequency Range 2402MHz~2480MHz
Type of Modulation GFSK, 8DPSK, Pi/4 QPSK
Channels: Channels with 1MHz step
Antenna Type PCB antenna

3. LABORATORY AND ACCREDITATIONS

3.1 LABORATORY

The tests and measurements refer to this report were performed by Guangzhou GRG Metrology and Test CO., LTD.

Add. : 163 Pingyun Rd, West of Huangpu Ave, Guangzhou, 510656, P. R. China

Telephone: +86-20-38699959, 38699960, 38699961

Fax : +86-20-38695185

3.2 ACCREDITATIONS

Our laboratories are accredited and approved by the following approval agencies according to ISO/IEC 17025.

USA	FCC Listed Lab (No. 688188)
China	CNAS (No.L0446)
China	DILAC (No.DL175)
Canada	Registration No.:8355A-1

3.3 MEASUREMENT UNCERTAINTY

Where relevant, the following measurement uncertainty levels have been estimated for tests performed on the EUT as specified in CISPR 16-4-2:

Measurement		Frequency	Uncertainty
Radiated Emission	Horizontal	30MHz~1000MHz	4.2dB
		1GHz~26.5GHz	4.2dB
	Vertical	30MHz~1000MHz	4.4dB
		1GHz~26.5GHz	4.4dB
Conducted Emission		9kHz~30MHz	3.1 dB

This uncertainty represents an expanded uncertainty factor of $k=2$.

3.4 LIST OF USED TEST EQUIPMENT AT GRGT

Name of Equipment	Manufacturer	Model	Serial Number	Calibration Due
Conducted Emissions				
EMI Receiver	R&S	ESU40	100529	2014-01-24
L.I.S.N	SCHWARZBECK	NSLK 8127	8127450	2014-08-05
Spurious Emissions at Antenna Port				
Receiver	R&S	ESU40	100106	2014-01-24
Restricted Bands				
Receiver	R&S	ESU40	100106	2014-01-24
Spurious Emissions				
Receiver	R&S	ESU40	100106	2014-01-24
Signal Generator	R&S	SML03	103002	2014-11-13
Biconical Log-periodic Antenna	ETS.LINDGREN	3142C	00075971	2014-05-26
Horn antenna	SCHWARZBECK	BBHA9120D	D752	2014-10-14
6 dB Bandwidth				
Receiver	R&S	ESU40	100106	2014-01-24
Maximum Peak Output Power				
Receiver	R&S	ESU40	100106	2014-01-24
100kHz Bandwidth of Frequency Band Edge				
Receiver	R&S	ESU40	100106	2014-01-24
Power Spectral Density				
Receiver	R&S	ESU40	100106	2014-01-24

4. TEST RESULTS

4.1 E.U.T. TEST CONDITIONS

Type of antenna: Integral

Temperature: 22.0 °C

Humidity: 54 % RH

Atmospheric Pressure: 1011 mbar

Test frequencies: According to the 15.31(m) Measurements on intentional radiators or receivers, other than TV broadcast receivers, shall be performed and, if required, reported for each band in which the device can be operated with the device operating at the number of frequencies in each band specified in the following table:

Frequency range over which device operates	Number of frequencies	Location in the range of operation
1 MHz or less	1	Middle
1 to 10 MHz	2	1 near top and 1 near bottom
More than 10 MHz	3	1 near top, 1 near middle and 1 near bottom

EUT channels and frequencies list:

Channel	Frequency (MHz)	Channel	Frequency (MHz)	Channel	Frequency (MHz)
0	2402	14	2416	28	2430
1	2403	15	2417	29	2431
2	2404	16	2418	30	2432
3	2405	17	2419	31	2433
4	2406	18	2420	32	2434
5	2407	19	2421	33	2435
6	2408	20	2422	34	2436
7	2409	21	2423	35	2437
8	2410	22	2424	36	2438
9	2411	23	2425	37	2439
10	2412	24	2426	38	2440
11	2413	25	2427	39	2441
12	2414	26	2428	40	2442
13	2415	27	2429	41	2443

Channel	Frequency (MHz)	Channel	Frequency (MHz)	Channel	Frequency (MHz)
42	2444	55	2457	68	2470
43	2445	56	2458	69	2471
44	2446	57	2459	70	2472
45	2447	58	2460	71	2473
46	2448	59	2461	72	2474
47	2449	60	2462	73	2475
48	2450	61	2463	74	2476
49	2451	62	2464	75	2477
50	2452	63	2465	76	2478
51	2453	64	2466	77	2479
52	2454	65	2467	78	2480
53	2455	66	2468		
54	2456	67	2469		

Test frequency is the lowest channel: 0 channel(2402MHz), middle channel: 39 channel(2441MHz) and highest channel: 78 channel(2480MHz)

4.2 ANTENNA REQUIREMENT

The EUT antenna is PCB Printed antenna. Antenna gain is 2.98~3.14dBi .which accordance 15.203.is considered sufficient to comply with the provisions of this section.

4.3 OCCUPIED BANDWIDTH

4.3.1 LIMITS

Frequency hopping systems operating in the 2400-2483.5 MHz band may have hopping channel carrier frequencies that are separated by 25 kHz or two-thirds of the 20 dB bandwidth of the hopping channel, whichever is greater, provided the systems operate with an output power no greater than 125 mW.

4.3.2 TEST PROCEDURES

1. Remove the antenna from the EUT and then connect a low RF cable from the antenna port to the spectrum;
2. Set the spectrum analyzer: Span = approximately 2 to 3 times the 20dB bandwidth, centre on a hopping channel;
3. Set the spectrum analyzer: RBW \geq 1% of the 20dB bandwidth (set 100 kHz). VBW \geq RBW. Sweep = auto; Detector Function = Peak. Trace = Max Hold.
4. Mark the peak frequency and -20dB bandwidth.
5. Bandwidth value is OBW value.

Remark:

Pre-test the 3 modulation to find GFSK and 8DPSK is worse case, so only record GFSK and 8DPSK test data.

4.3.3 TEST SETUP

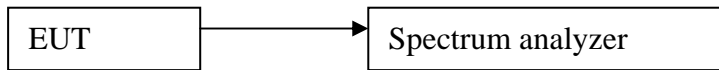

4.3.4 TEST RESULTS

For GFSK

Frequency (GHz)	Test Channel	bandwidth
2.402	Lowest	1.12MHz
2.441	Middle	1.11MHz
2.480	Highest	1.11MHz

For 8DPSK

Frequency (GHz)	Test Channel	bandwidth
2.402	Lowest	1.36MHz
2.441	Middle	1.33MHz
2.480	Highest	1.34MHz

Result plot as follows:

GFSK Lowest Channel:

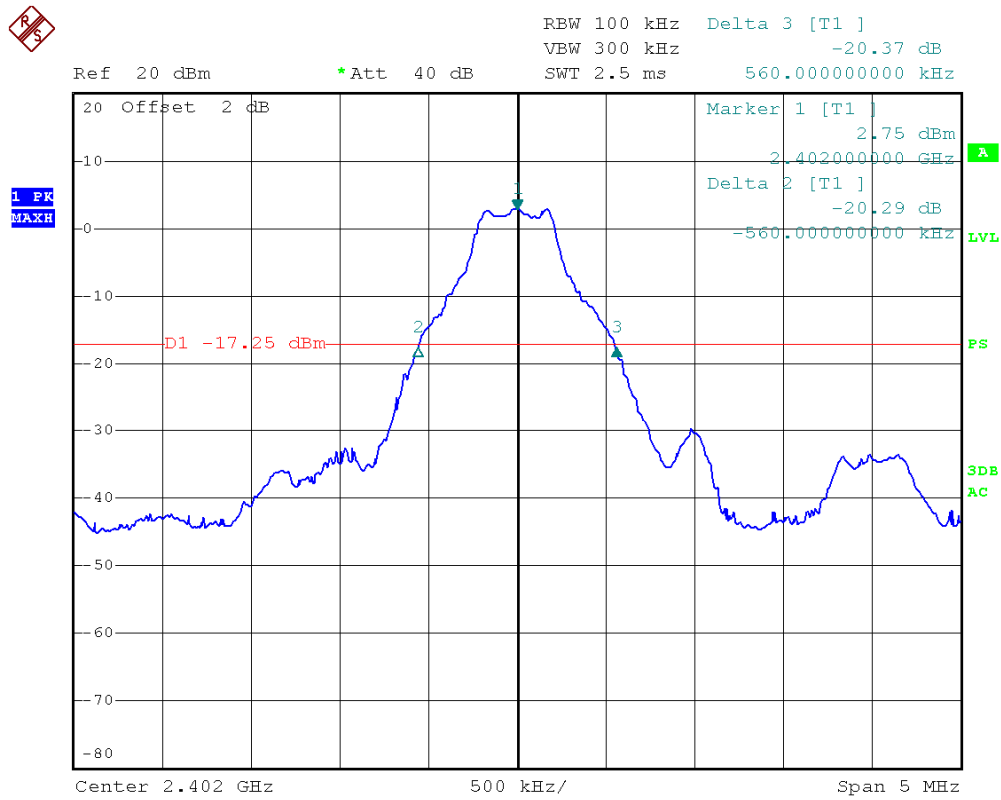

GFSK Middle Channel:

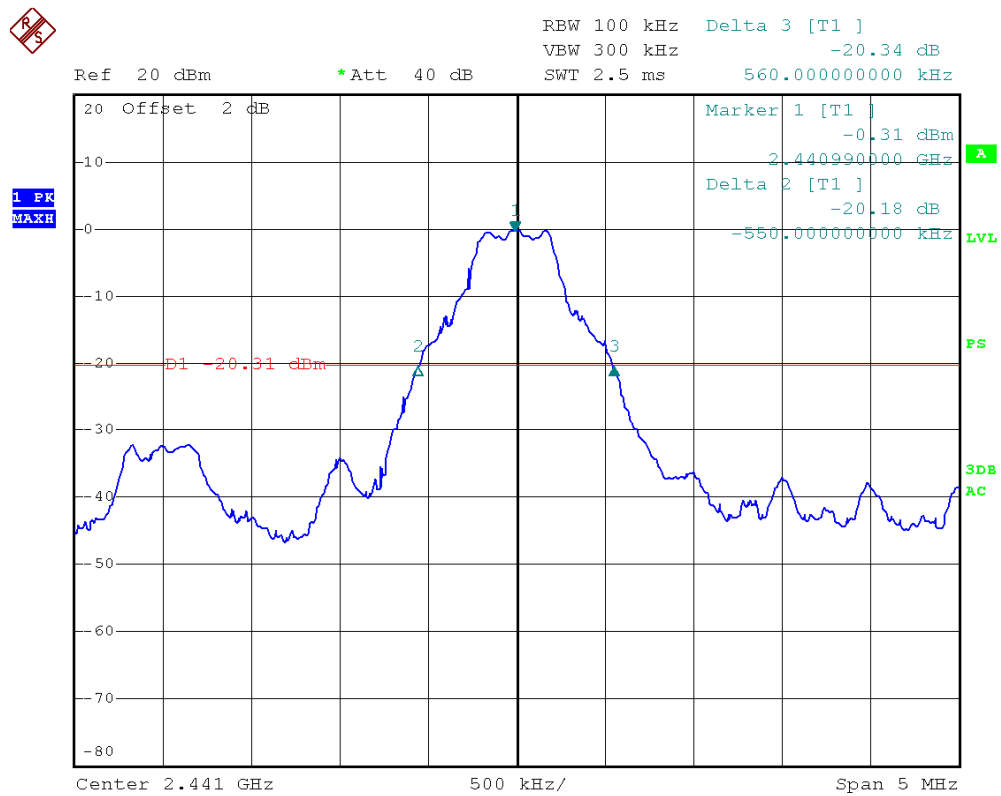

GFSK Highest Channel:

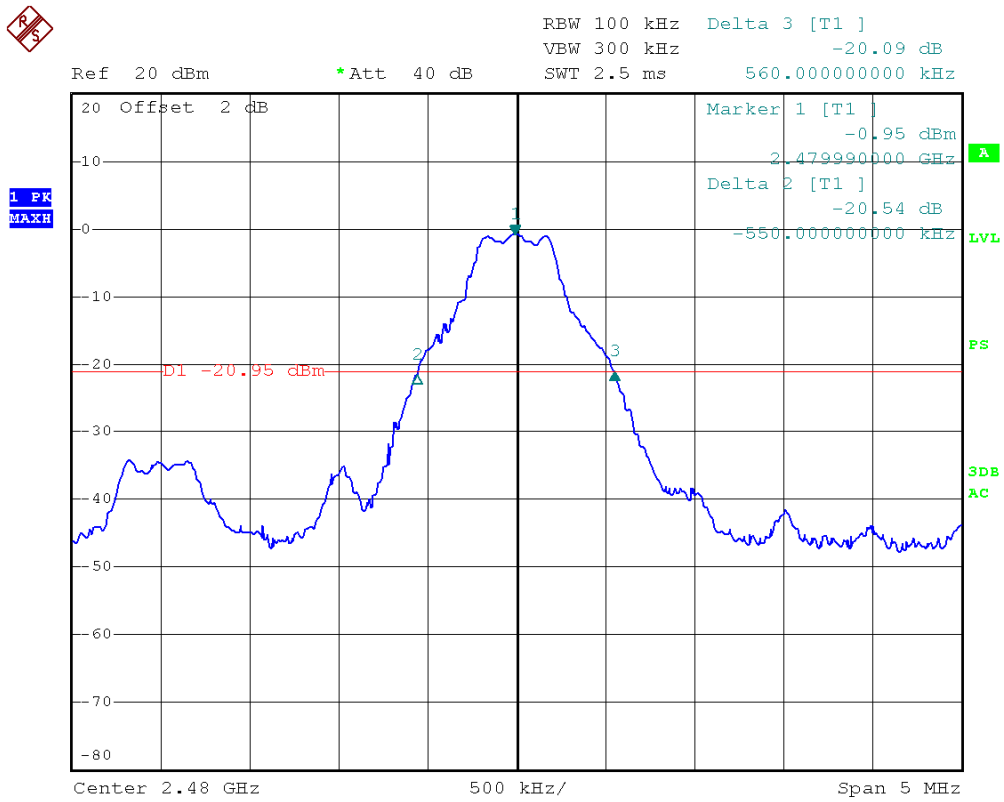

8DPSK Lowest Channel:

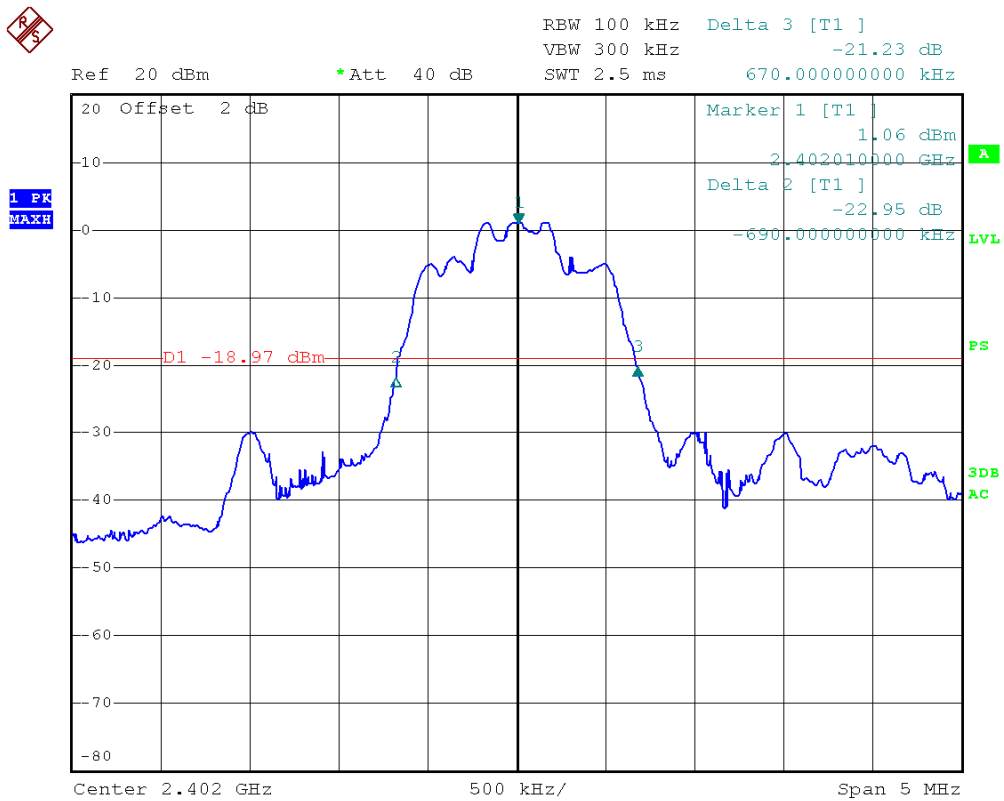

8DPSK Middle Channel:

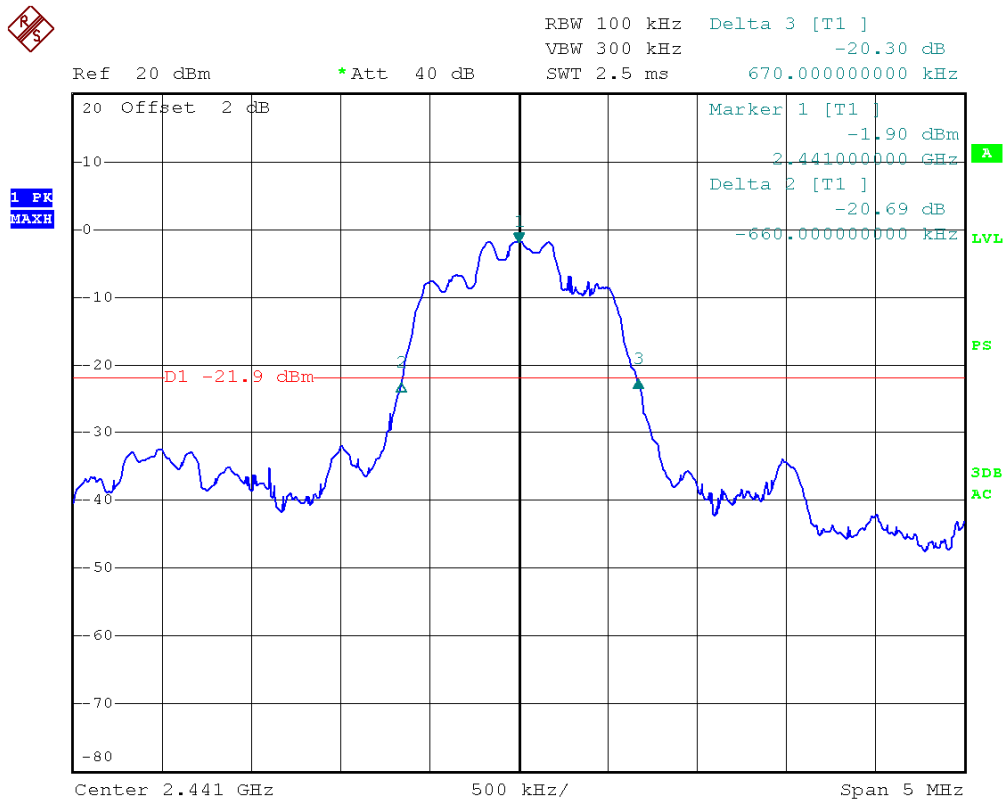

8DPSK Highest Channel:

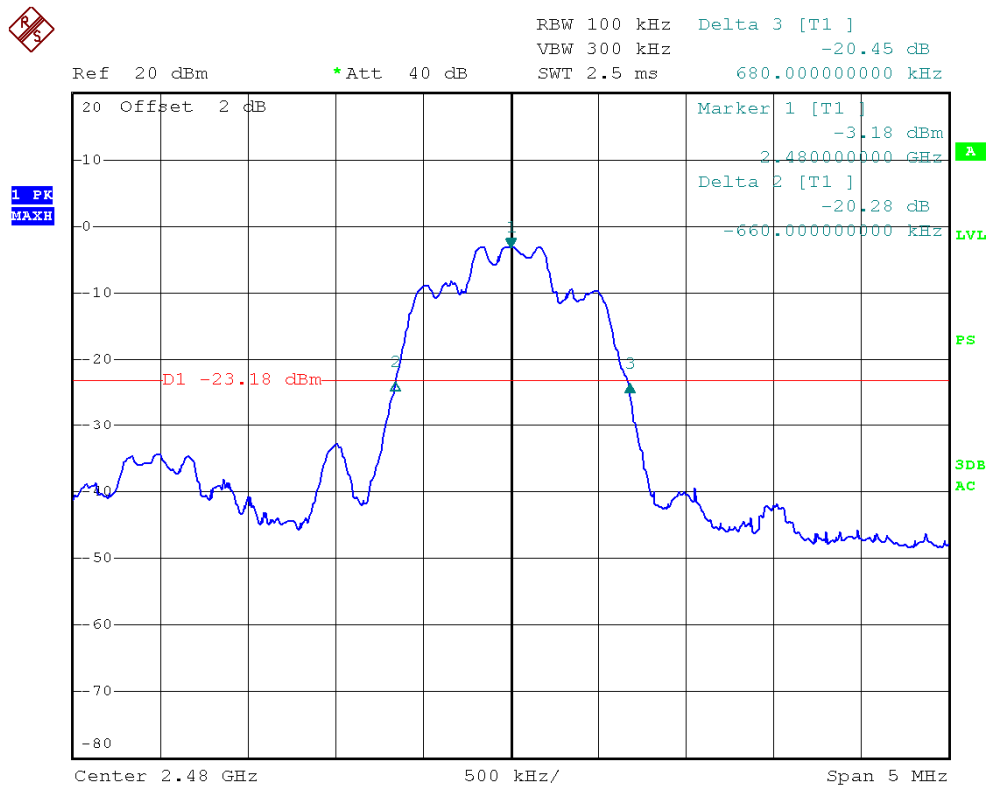

4.4 CARRIER FREQUENCIES SEPARATED

4.4.1 LIMITS

Frequency hopping systems operating in the 2400-2483.5 MHz band may have hopping channel carrier frequencies that are separated by 25 kHz or two-thirds of the 20 dB bandwidth of the hopping channel, whichever is greater, provided the systems operate with an output power no greater than 125 mW.

4.4.2 TEST PROCEDURES

1. Remove the antenna from the EUT and then connect a low RF cable from the antenna port to the spectrum.
2. Set the spectrum analyzer: RBW \geq 1% of the span (set 100 kHz). VBW \geq RBW, Span = 3MHz. Sweep = auto; Detector Function = Peak. Trace = Max, hold.
3. Allow the trace to stabilize. Use the marker-delta function to determine the separation between the peaks of the adjacent channels. The limit is specified in one of the subparagraphs of this Section. Submit this plot.

Remark :

Pre-test the 3 modulation to find GFSK and 8DPSK is worse case, so only record GFSK and 8DPSK test data.

4.4.3 TEST SETUP

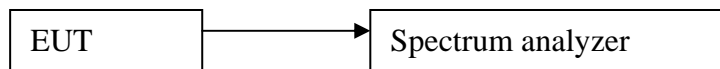

4.4.4 TEST RESULTS

Mode	Test Channel	Carrier Frequencies Separated	2/3 20 dB bandwidth	PASS/FAIL
GFSK	Lower Channels (channel 0 and channel 1)	1.002MHz	0.75 MHz	Pass
	Middle Channels (channel 39 and channel 40)	1.002MHz	0.74 MHz	Pass
	Upper Channels (channel 77 and channel 78)	1.008MHz	0.74 MHz	Pass
8DPSK	Lower Channels (channel 0 and channel 1)	1.002MHz	0.91 MHz	Pass
	Middle Channels (channel 39 and channel 40)	1.002MHz	0.89 MHz	Pass
	Upper Channels (channel 77 and channel 78)	1.008MHz	0.89 MHz	Pass

Result plot as follows:

GFSK Lowest Channels:

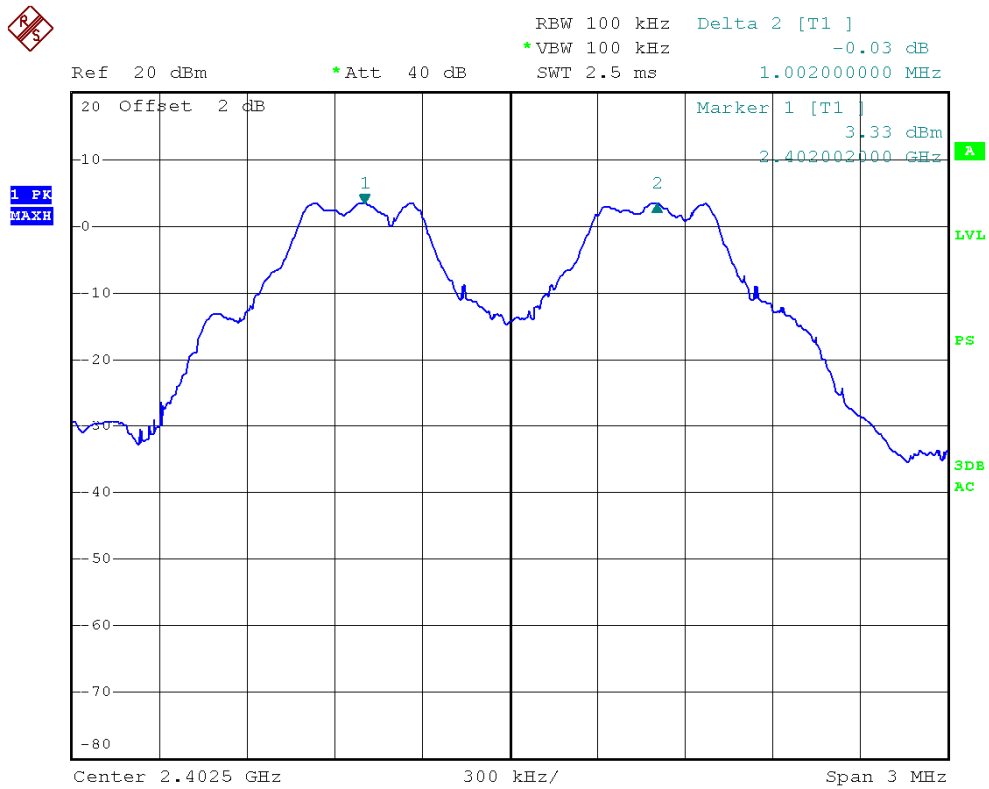

GFSK Middle Channels:

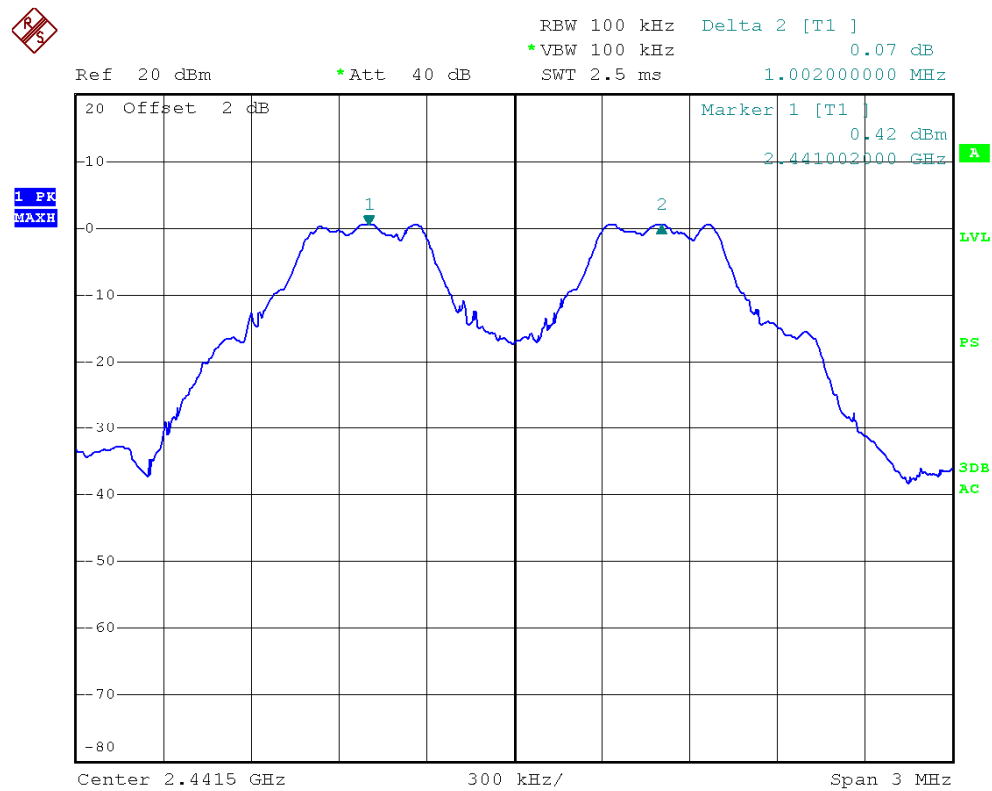

GFSK Highest Channels:

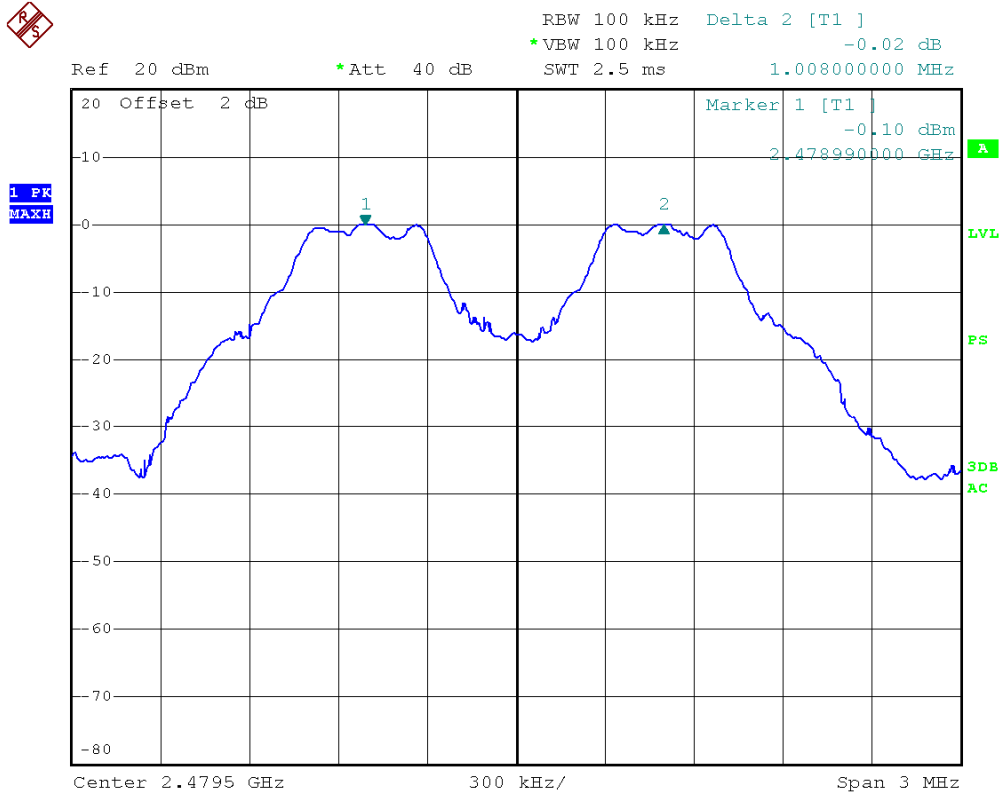

8DPSK Lowest Channels:

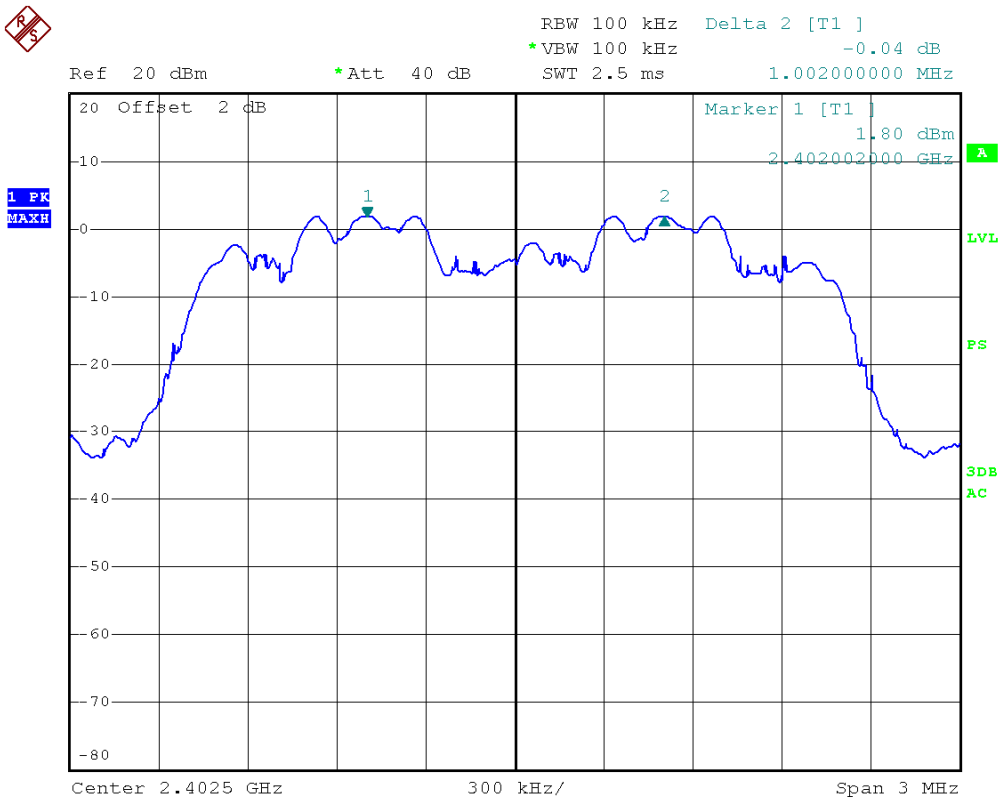

8DPSK Middle Channels:

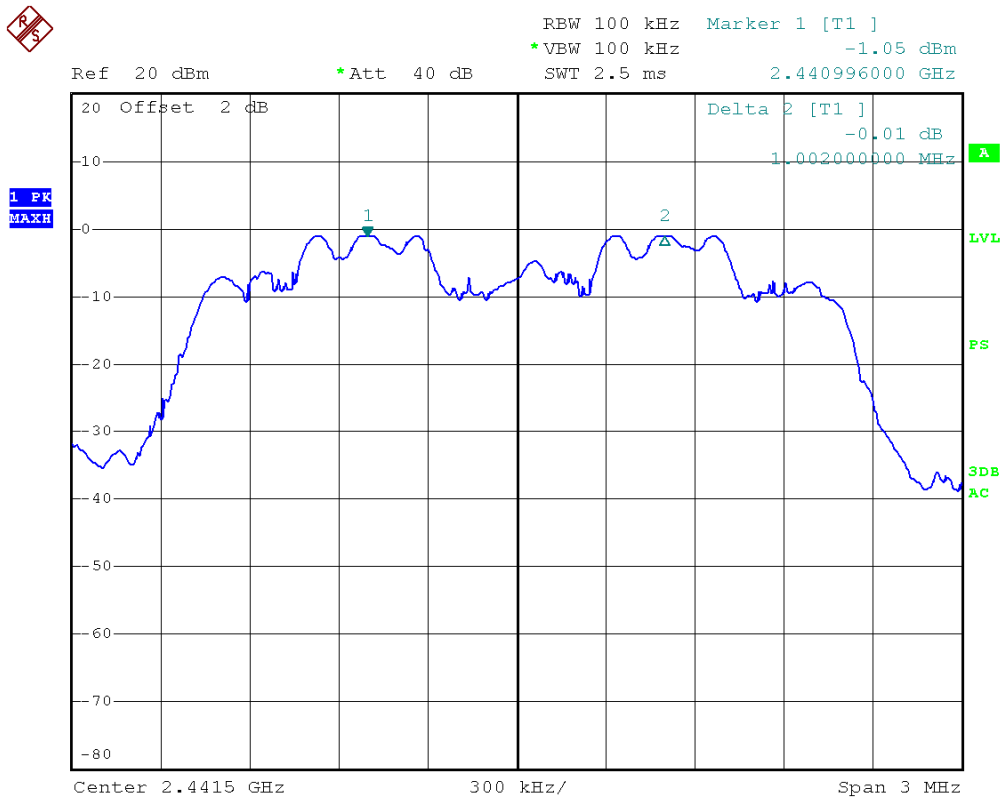

8DPSK Highest Channels:

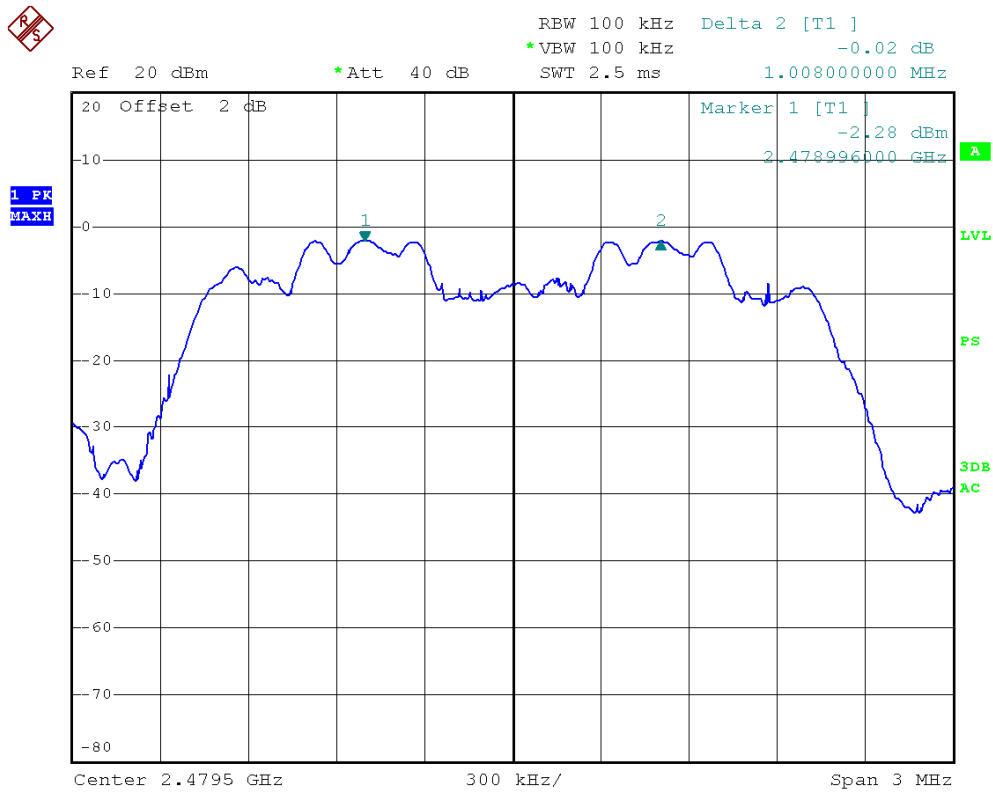

Test result: The unit does meet the FCC requirements.

4.5 HOPPING CHANNEL NUMBER

4.5.1 LIMITS

Regulation 15.247 (a) (1)(iii) Frequency hopping systems in the 2400-2483.5 MHz band shall use at least 15 channels.

4.5.2 TEST PROCEDURES

1. Remove the antenna from the EUT and then connect a low RF cable from the antenna port to the spectrum.
2. Set the spectrum analyzer: RBW = 100 kHz. VBW = 100 kHz. Sweep = auto; Detector Function = Peak. Trace = Max hold.
3. Allow the trace to stabilize. It may prove necessary to break the span up to sections. in order to clearly show all of the hopping frequencies. The limit is specified in one of the subparagraphs of this Section.
4. Set the spectrum analyzer: start frequency = 2400MHz. stop frequency = 2483.5MHz. Submit the test result graph.

4.5.3 TEST SETUP

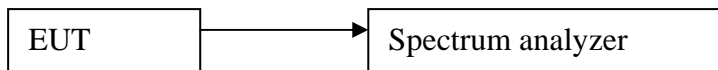

4.5.4 TEST RESULTS

Test result: Total channels are 79 channels.

Result plot as follows:

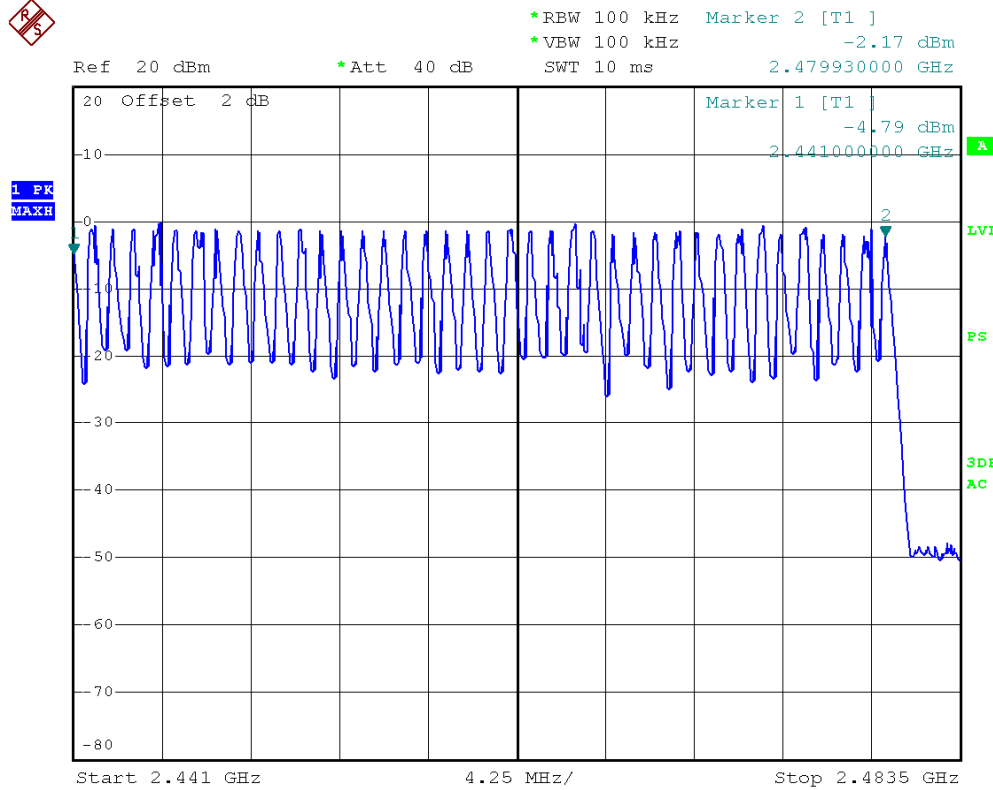
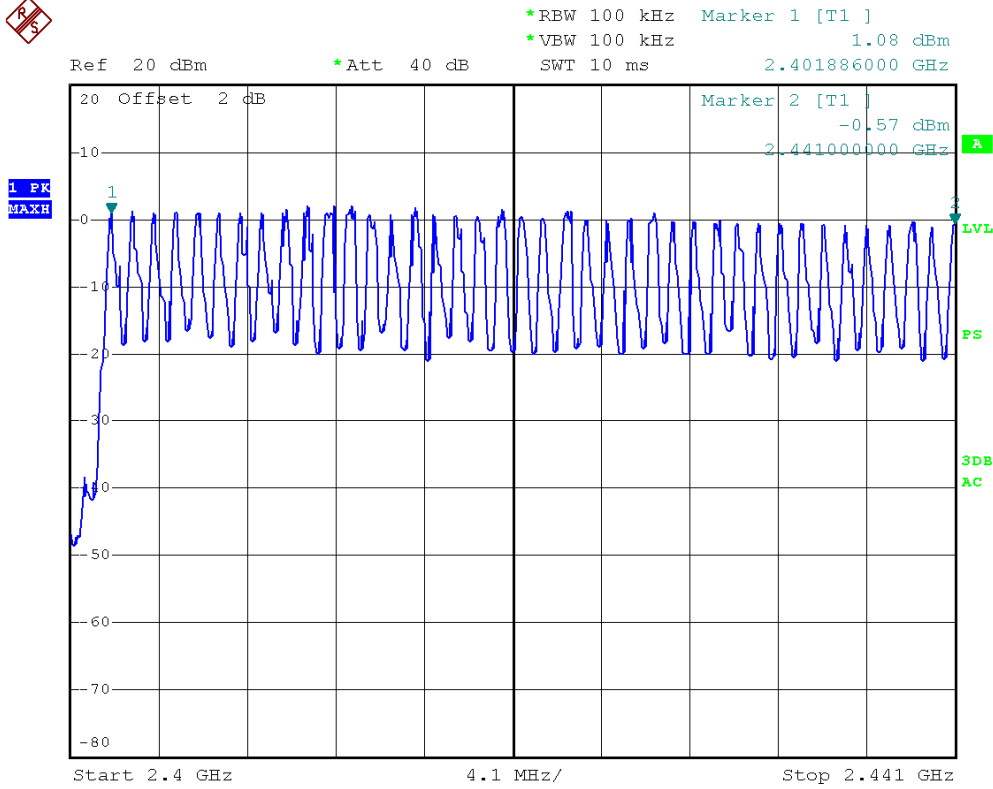

Test result: The unit does meet the FCC requirements.

4.6 DWELL TIME

4.6.1 LIMITS

Regulation 15.247(a)(1)(iii) Frequency hopping systems in the 2400-2483.5 MHz band shall use at least 15 channels. The average time of occupancy on any channel shall not be greater than 0.4 seconds within a period of 0.4 seconds multiplied by the number of hopping channels employed. Frequency hopping systems may avoid or suppress transmissions on a particular hopping frequency provided that a minimum of 15 channels are used.

4.6.2 TEST PROCEDURES

1. Remove the antenna from the EUT and then connect a low RF cable from the antenna port to the spectrum.
2. Set spectrum analyzer span = 0. centered on a hopping channel;
3. Set RBW = 1MHz and VBW = 3MHz.Sweep = as necessary to capture the entire dwell time per hopping channel. Detector Function = Peak. Trace = Max hold;
4. Use the marker-delta function to determine the dwell time. If this value varies with different modes of operation (e.g., data rate, modulation format, etc.). Repeat this test for each variation. The limit is specified in one of the subparagraphs of this Section. Submit this plot(s). An oscilloscope may be used instead of a spectrum analyzer.

4.6.3 TEST SETUP

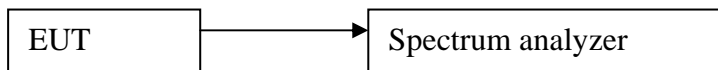

4.6.4 TEST RESULTS

The test period: $T = 0.4 \text{ Second/Channel} \times 79 \text{ Channel} = 31.6 \text{ s}$

1. Channel 0: 2.402GHz

DH1	time slot=	0.405	(ms)*	$(1600/(2*79))$	*	31.6	=	129.6	ms
DH3	time slot=	1.669	(ms)*	$(1600/(4*79))$	*	31.6	=	267.0	ms
DH5	time slot=	2.917	(ms)*	$(1600/(6*79))$	*	31.6	=	311.1	ms
2DH1	time slot=	0.423	(ms)*	$(1600/(2*79))$	*	31.6	=	135.4	ms
2DH3	time slot=	1.685	(ms)*	$(1600/(4*79))$	*	31.6	=	269.6	ms
2DH5	time slot=	2.933	(ms)*	$(1600/(6*79))$	*	31.6	=	312.9	ms
3DH1	time slot=	0.414	(ms)*	$(1600/(2*79))$	*	31.6	=	132.5	ms
3DH3	time slot=	1.669	(ms)*	$(1600/(4*79))$	*	31.6	=	267.0	ms
3DH5	time slot=	2.917	(ms)*	$(1600/(6*79))$	*	31.6	=	311.1	ms

2. Channel 39: 2.441GHz

DH1	time slot=	0.405	(ms)*	(1600/(2*79))	*	31.6	=	129.6	ms
DH3	time slot=	1.669	(ms)*	(1600/(4*79))	*	31.6	=	267.0	ms
DH5	time slot=	2.917	(ms)*	(1600/(6*79))	*	31.6	=	311.1	ms

2DH1	time slot=	0.414	(ms)*	(1600/(2*79))	*	31.6	=	132.5	ms
2DH3	time slot=	1.669	(ms)*	(1600/(4*79))	*	31.6	=	267.0	ms
2DH5	time slot=	2.933	(ms)*	(1600/(6*79))	*	31.6	=	312.9	ms

3DH1	time slot=	0.414	(ms)*	(1600/(2*79))	*	31.6	=	132.5	ms
3DH3	time slot=	1.669	(ms)*	(1600/(4*79))	*	31.6	=	267.0	ms
3DH5	time slot=	2.933	(ms)*	(1600/(6*79))	*	31.6	=	312.9	ms

3. Channel 78: 2.480GHz

DH1	time slot=	0.405	(ms)*	(1600/(2*79))	*	31.6	=	129.6	ms
DH3	time slot=	1.669	(ms)*	(1600/(4*79))	*	31.6	=	267.0	ms
DH5	time slot=	2.917	(ms)*	(1600/(6*79))	*	31.6	=	311.1	ms

2DH1	time slot=	0.405	(ms)*	(1600/(2*79))	*	31.6	=	129.6	ms
2DH3	time slot=	1.669	(ms)*	(1600/(4*79))	*	31.6	=	267.0	ms
2DH5	time slot=	2.933	(ms)*	(1600/(6*79))	*	31.6	=	312.9	ms

3DH1	time slot=	0.405	(ms)*	(1600/(2*79))	*	31.6	=	129.6	ms
3DH3	time slot=	1.669	(ms)*	(1600/(4*79))	*	31.6	=	267.0	ms
3DH5	time slot=	2.917	(ms)*	(1600/(6*79))	*	31.6	=	311.1	ms

**The results are not greater than 0.4 seconds.
The unit does meet the requirements.**

Please refer the graph as below:

1. Lowest channel (2.402 GHz):

DH1

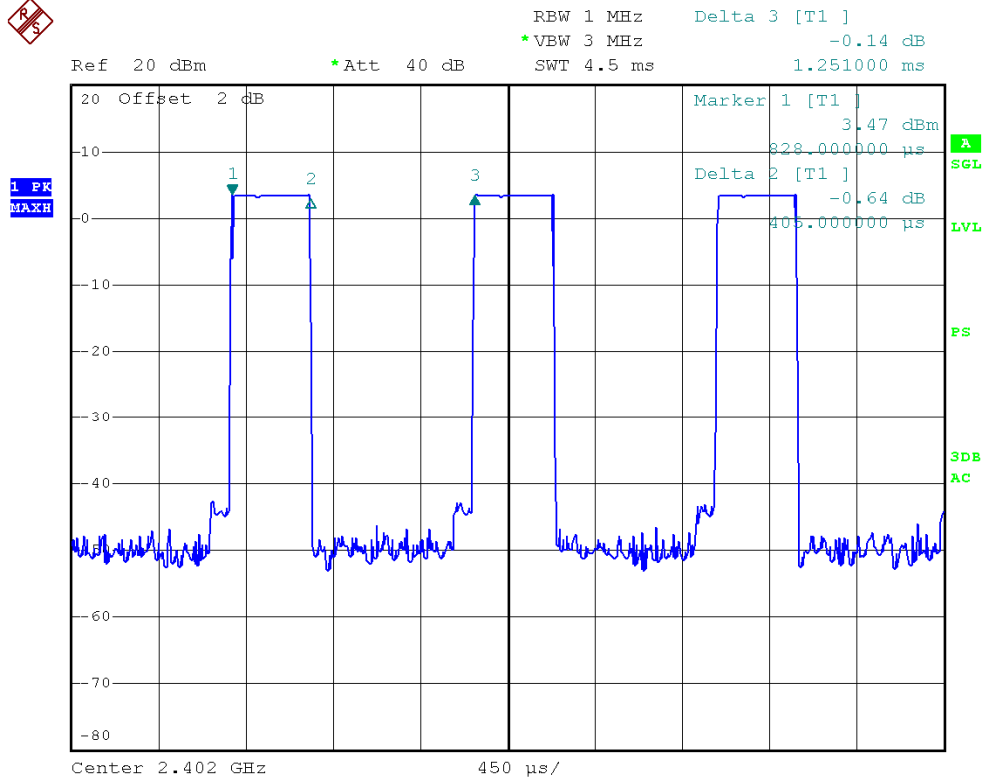

DH3:

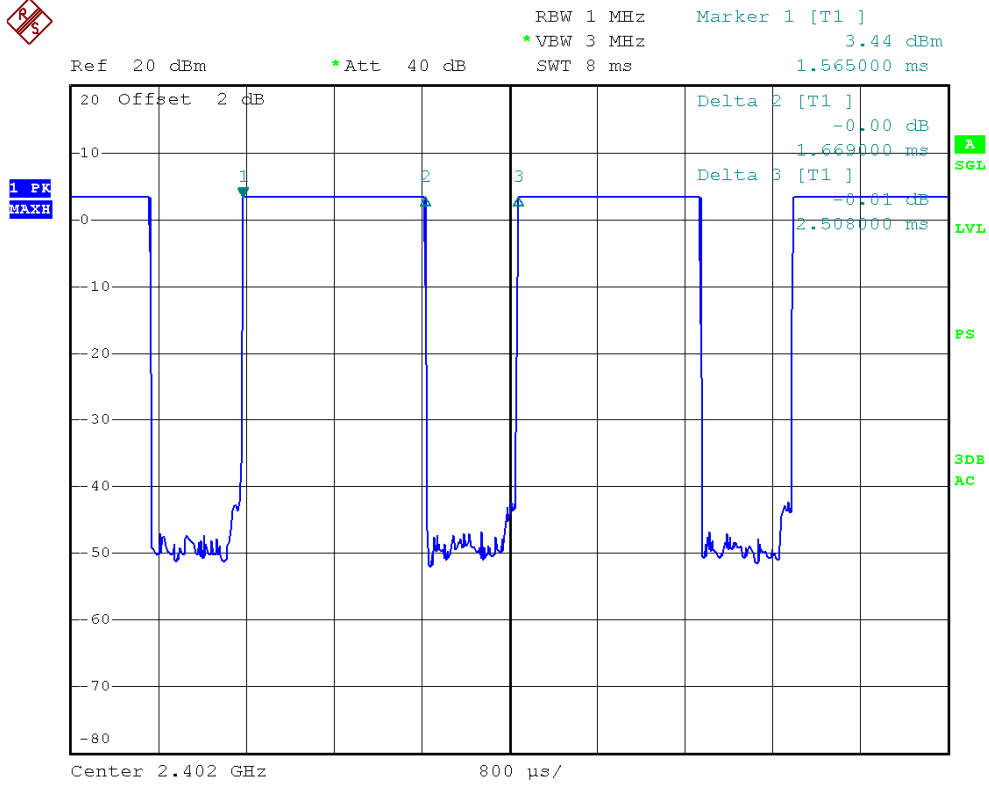

DH5:

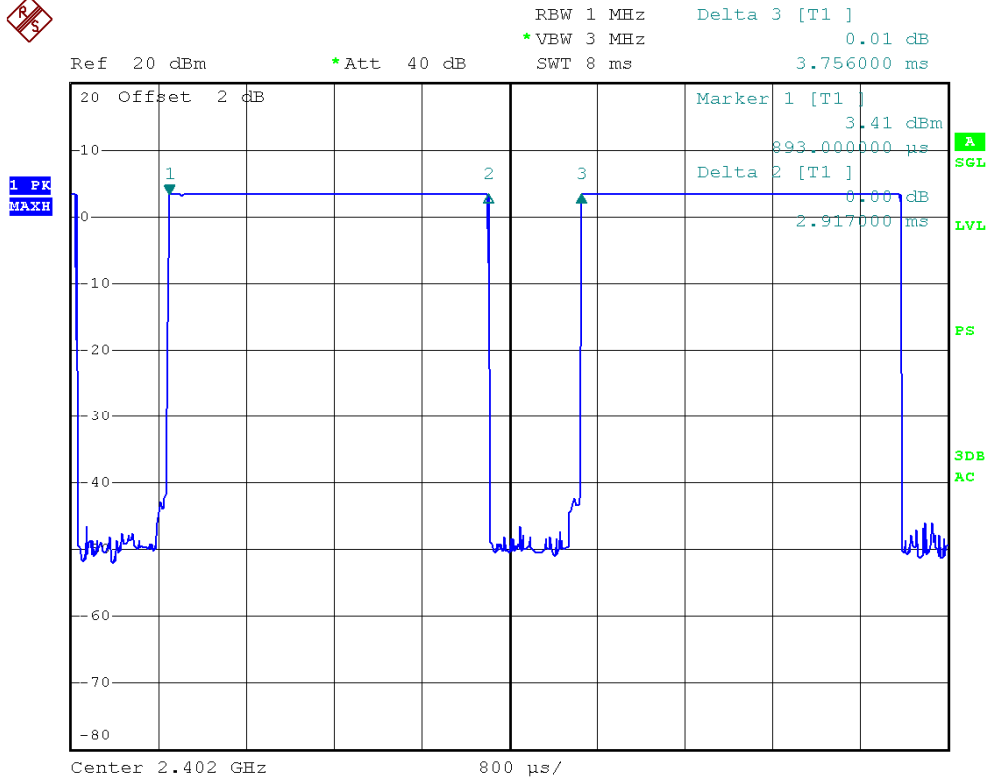

2DH1

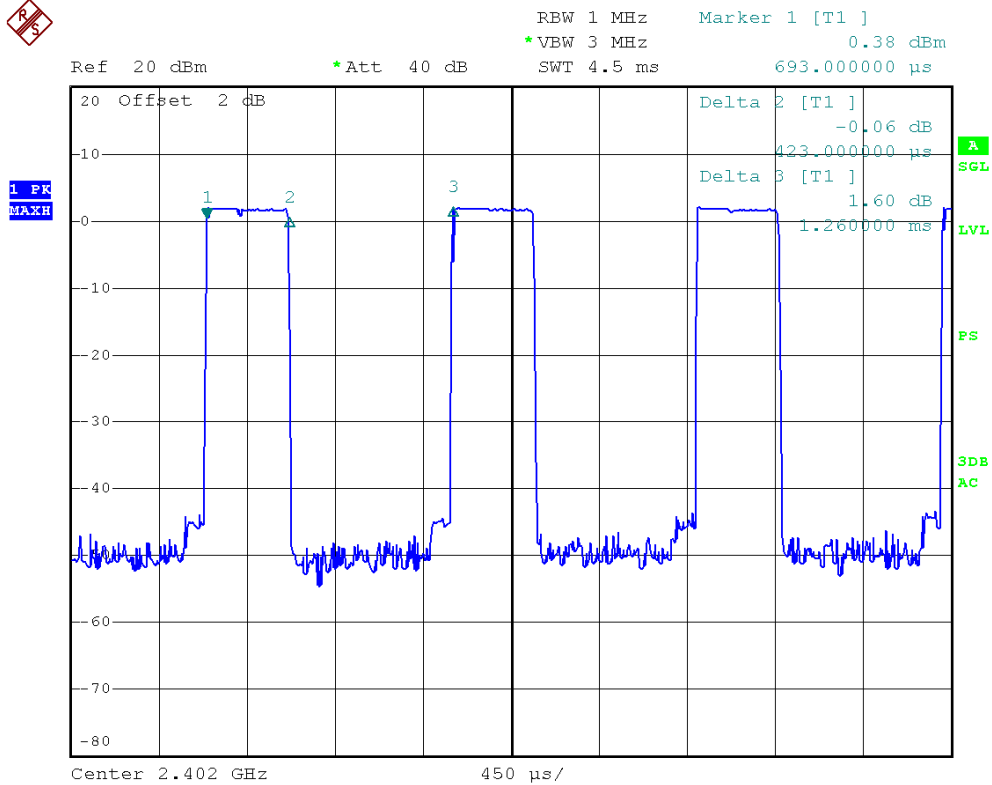

2DH3

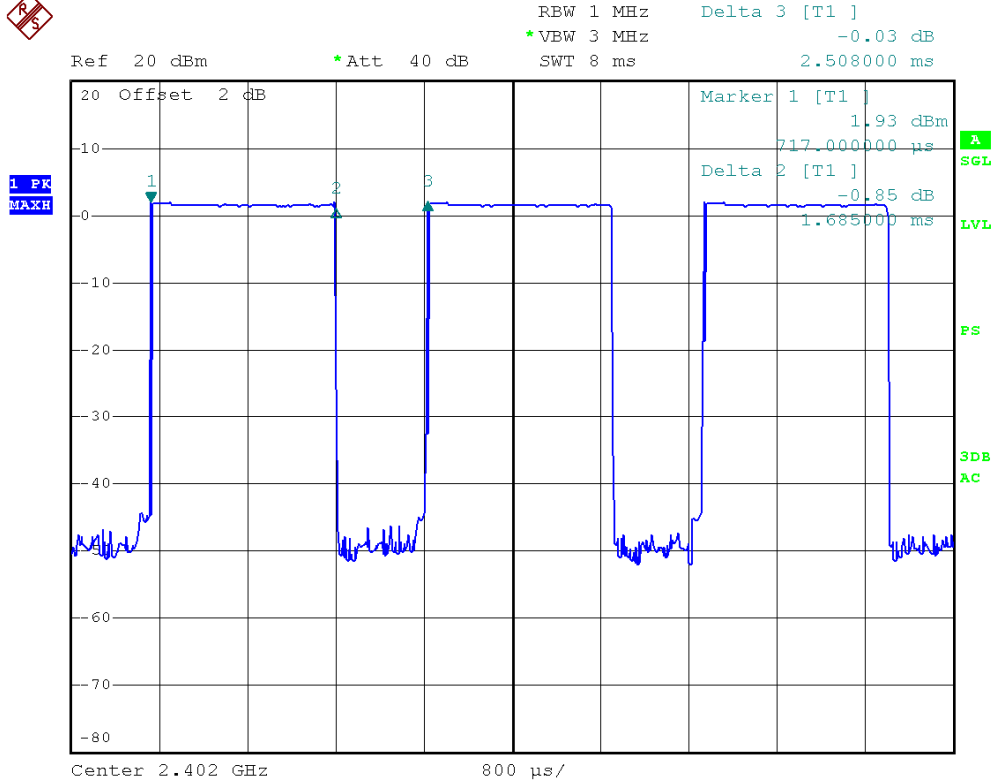

2DH5

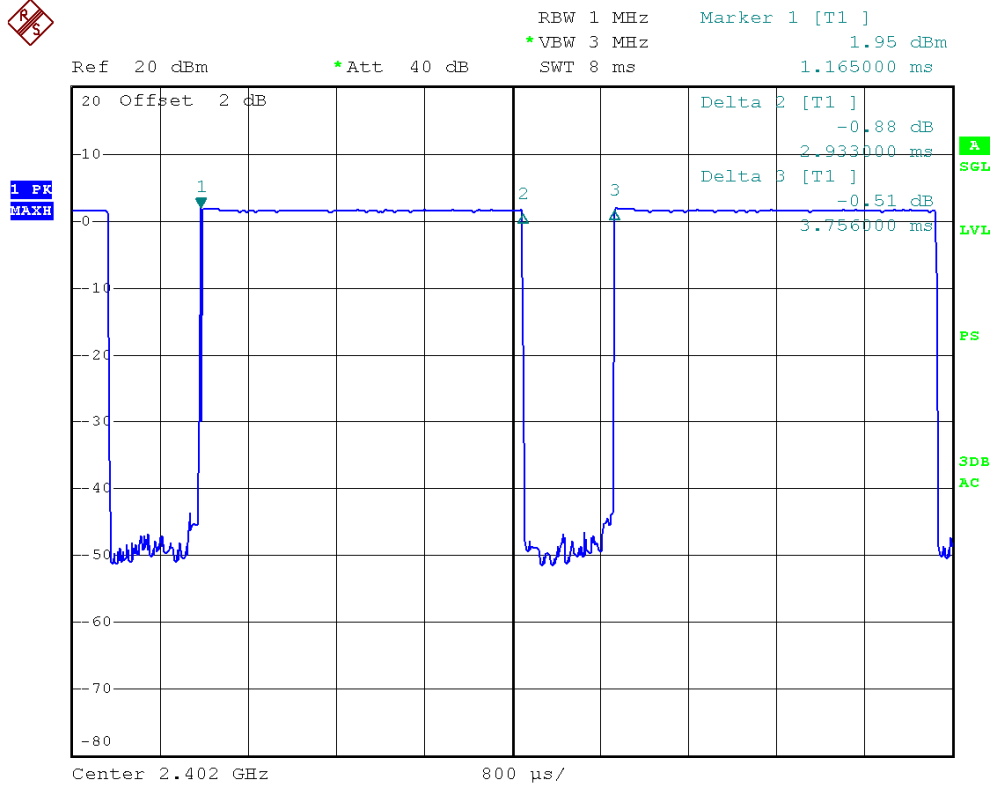

3DH1

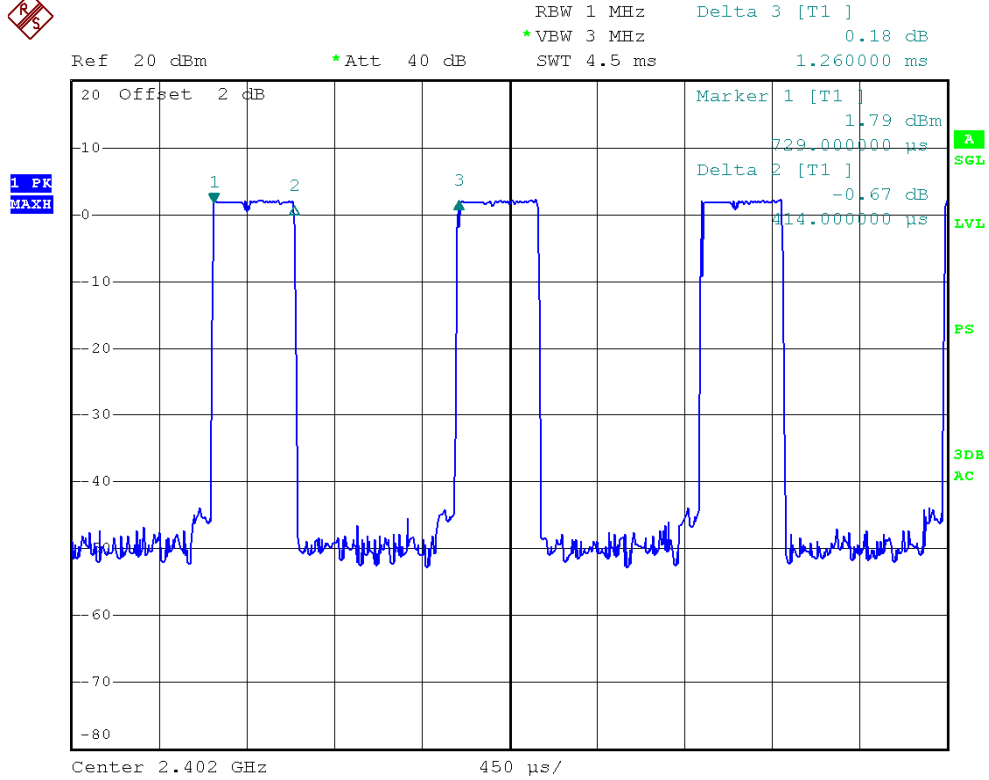

3DH3

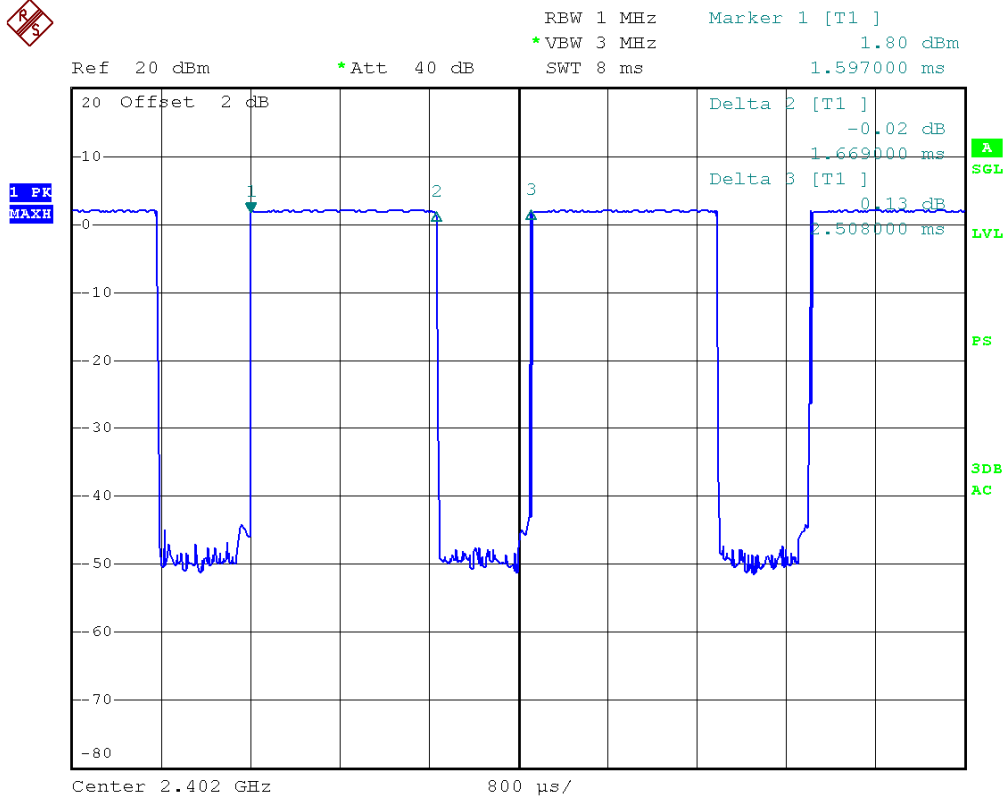

3DH5



RBW 1 MHz Delta 3 [T1] 0.02 dB
*VBW 3 MHz
SWT 8 ms 3.756000 ms
Ref 20 dBm *Att 40 dB

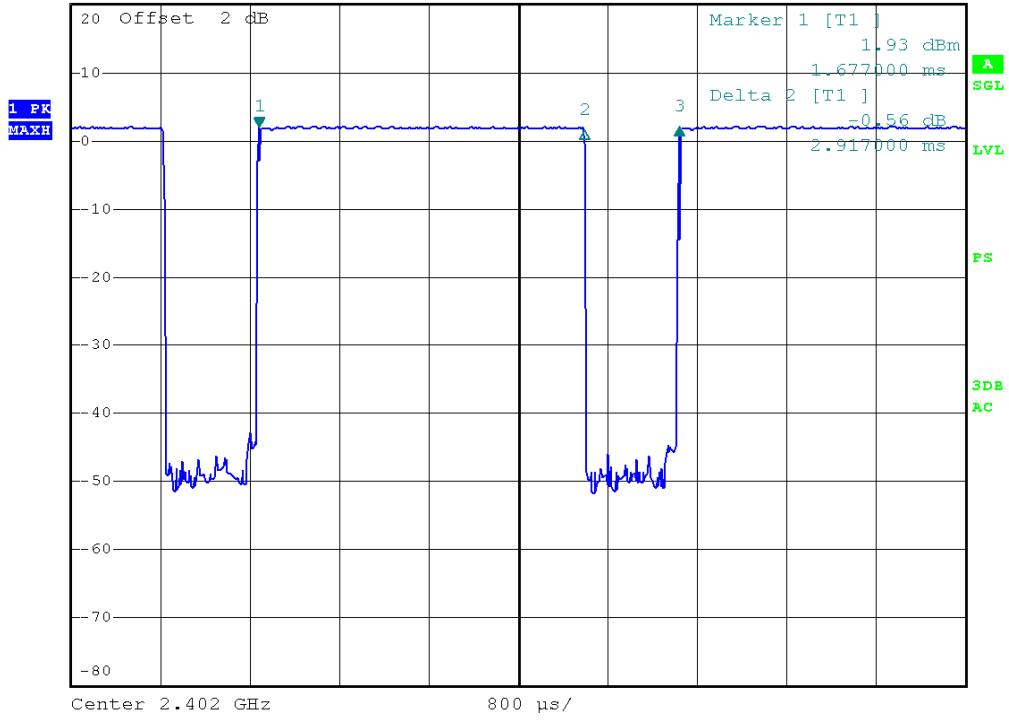

2. Middle Channel (2.441GHz)

DH1

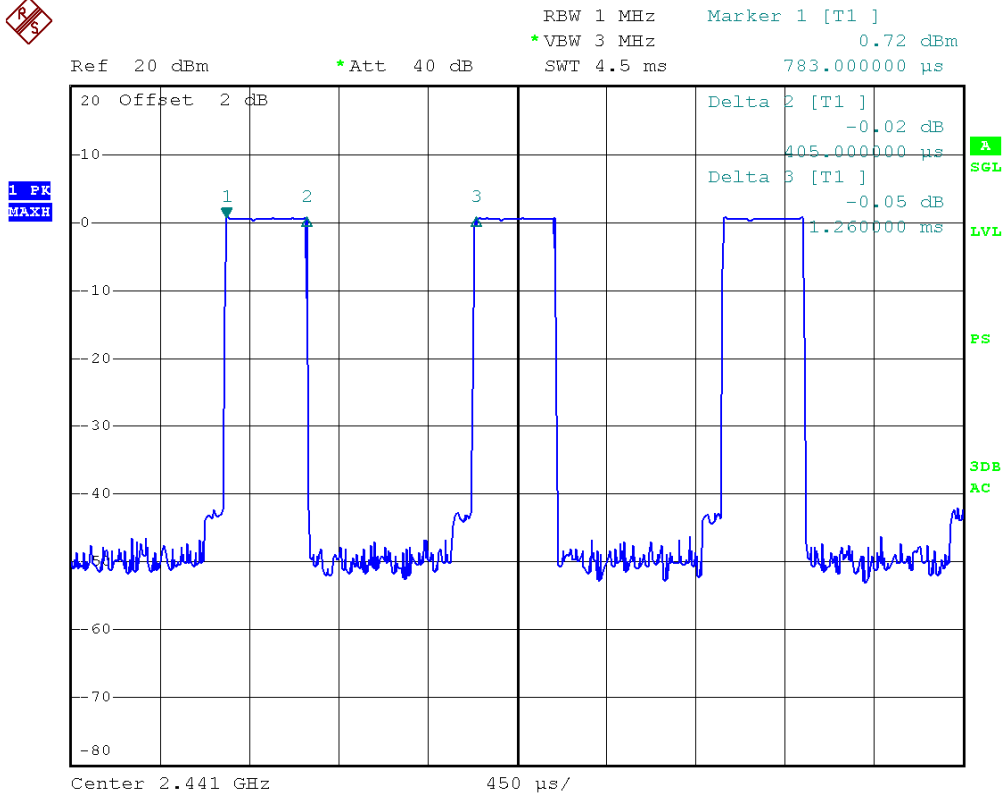

DH3

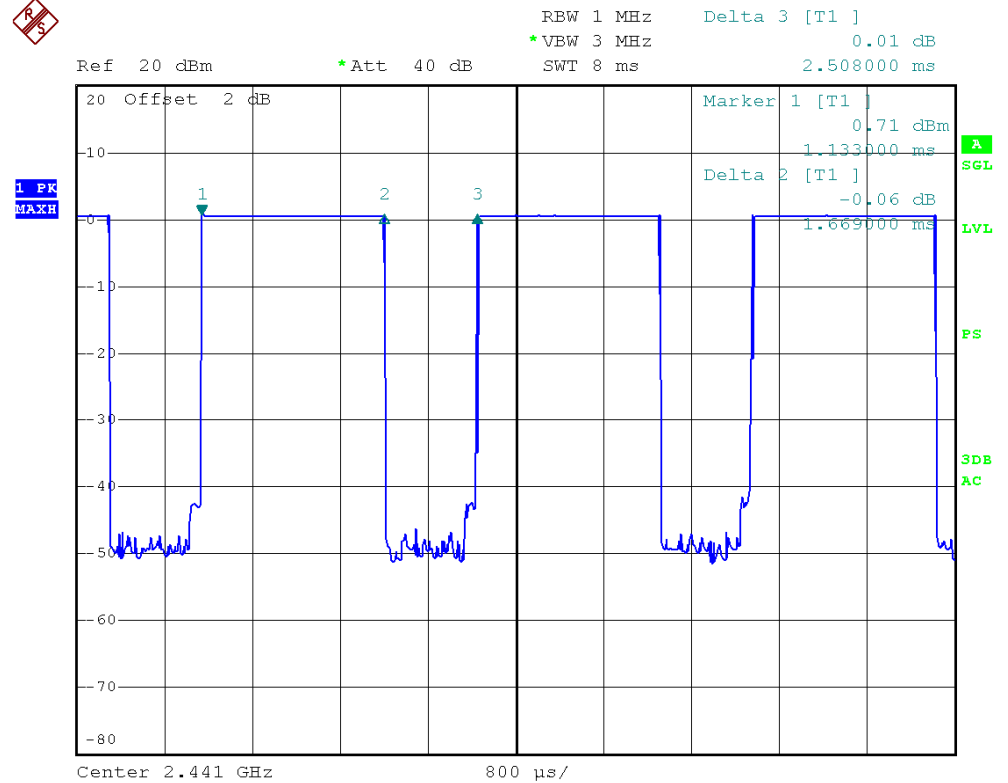

DH5

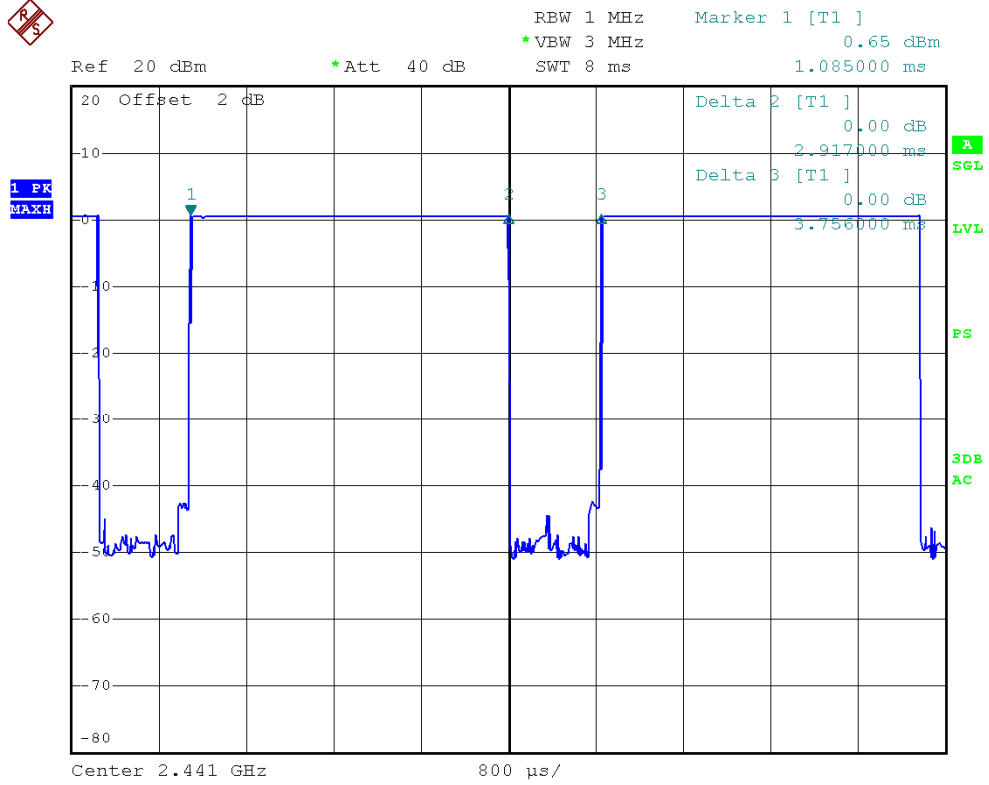

2DH1

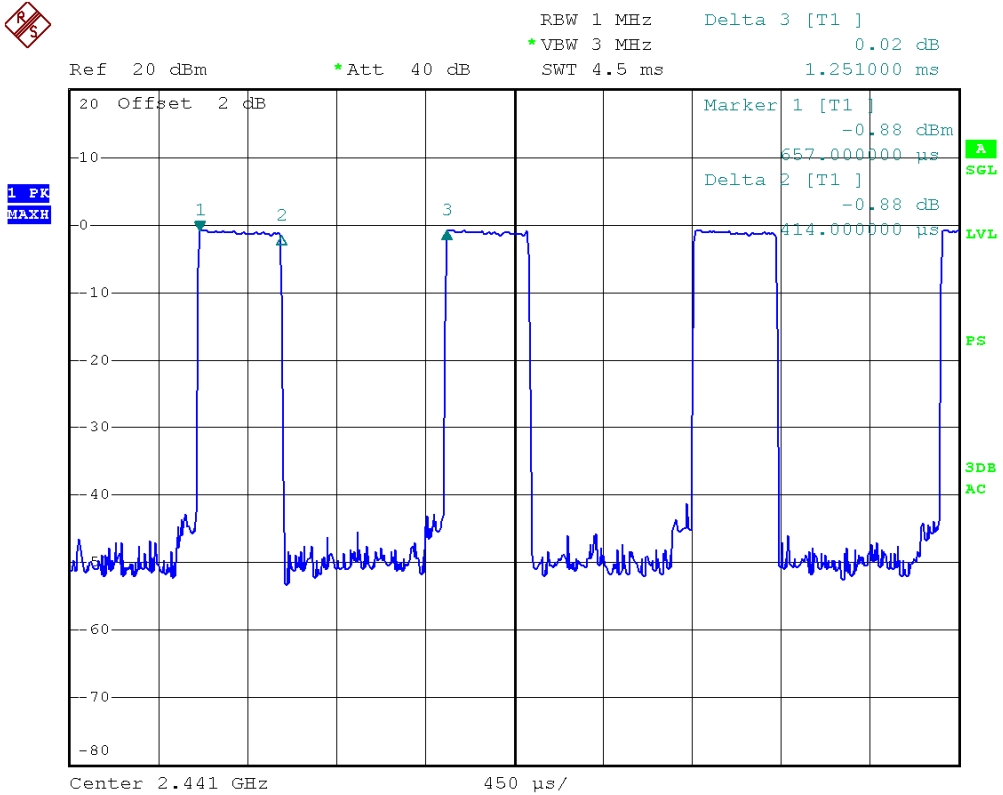

2DH3

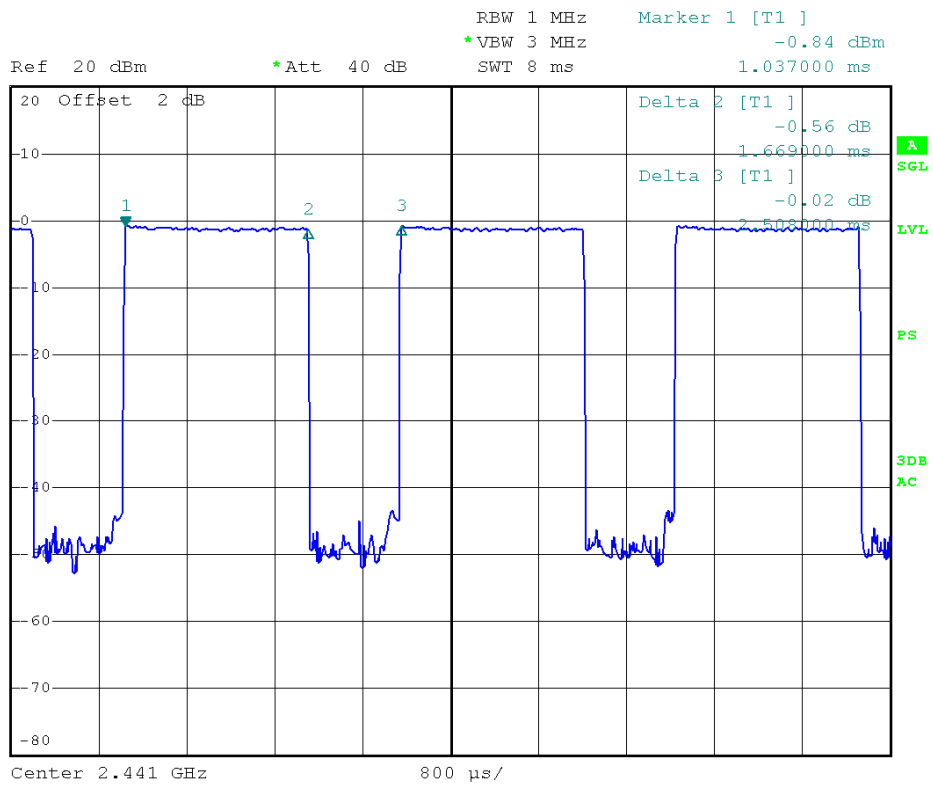

2DH5

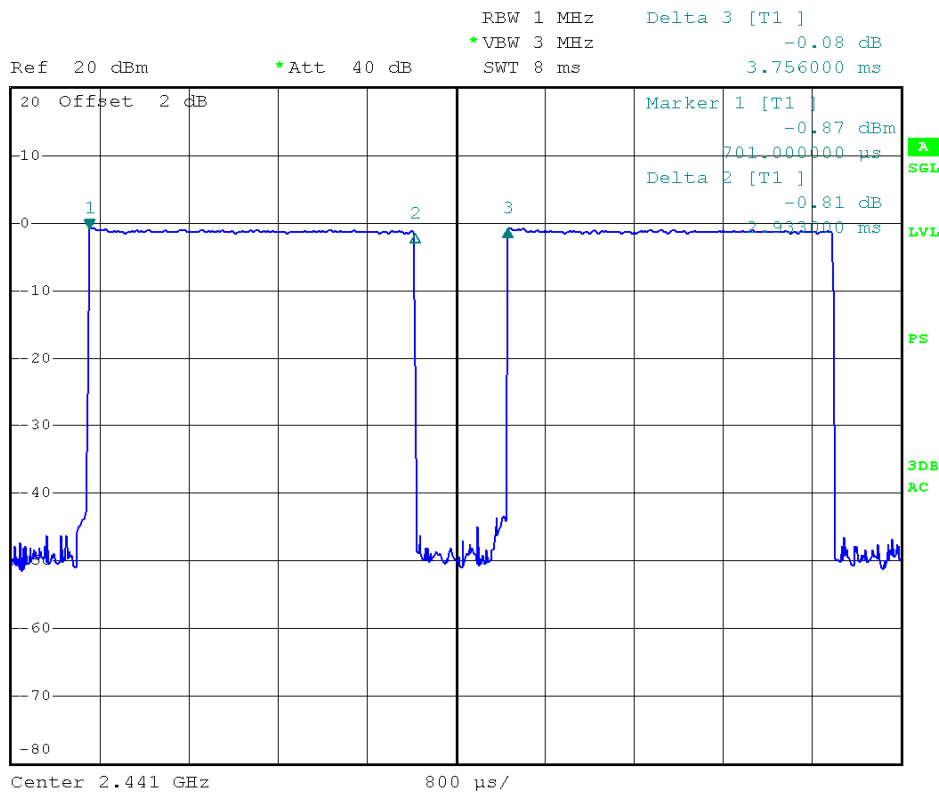

3DH1

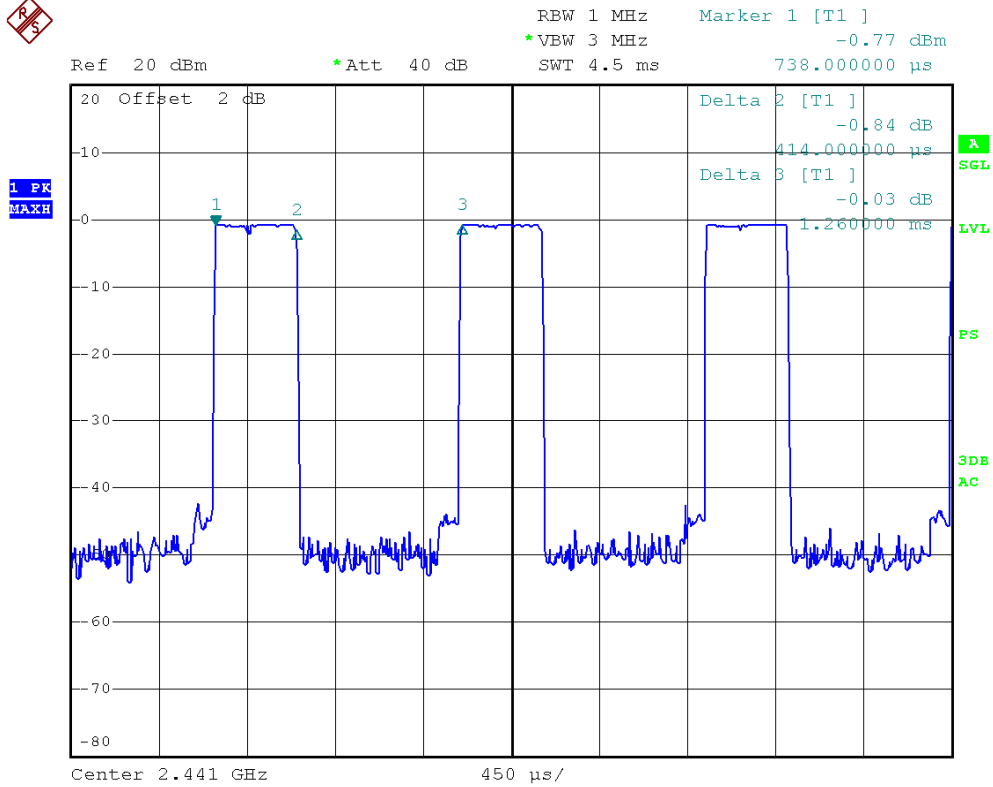

3DH3

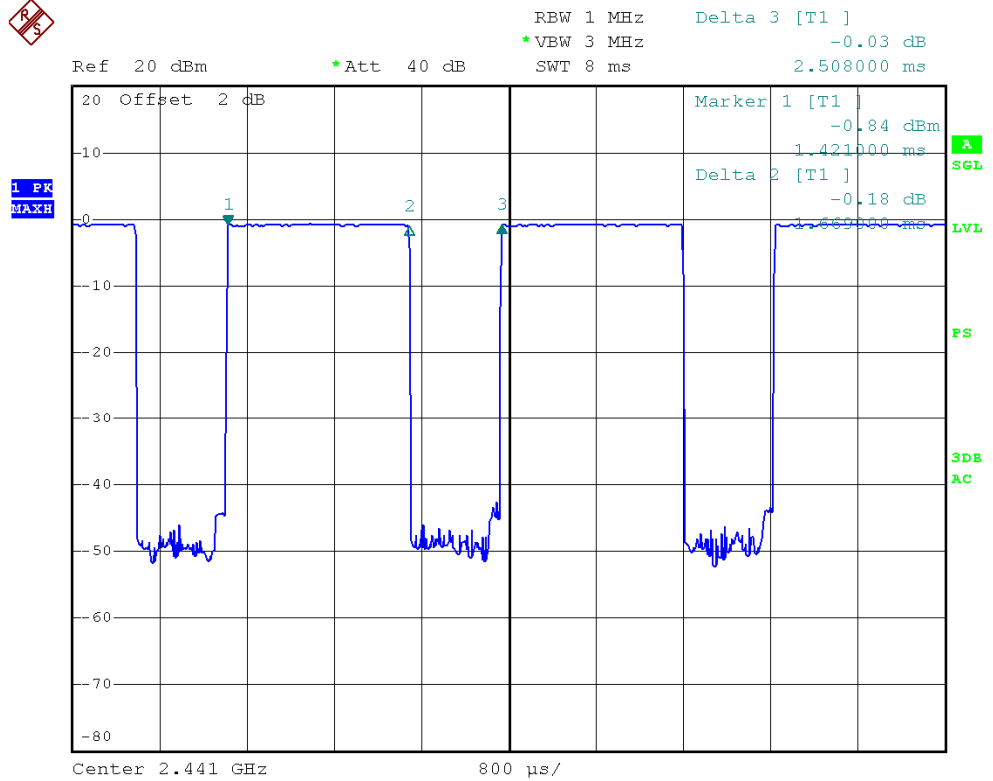

3DH5

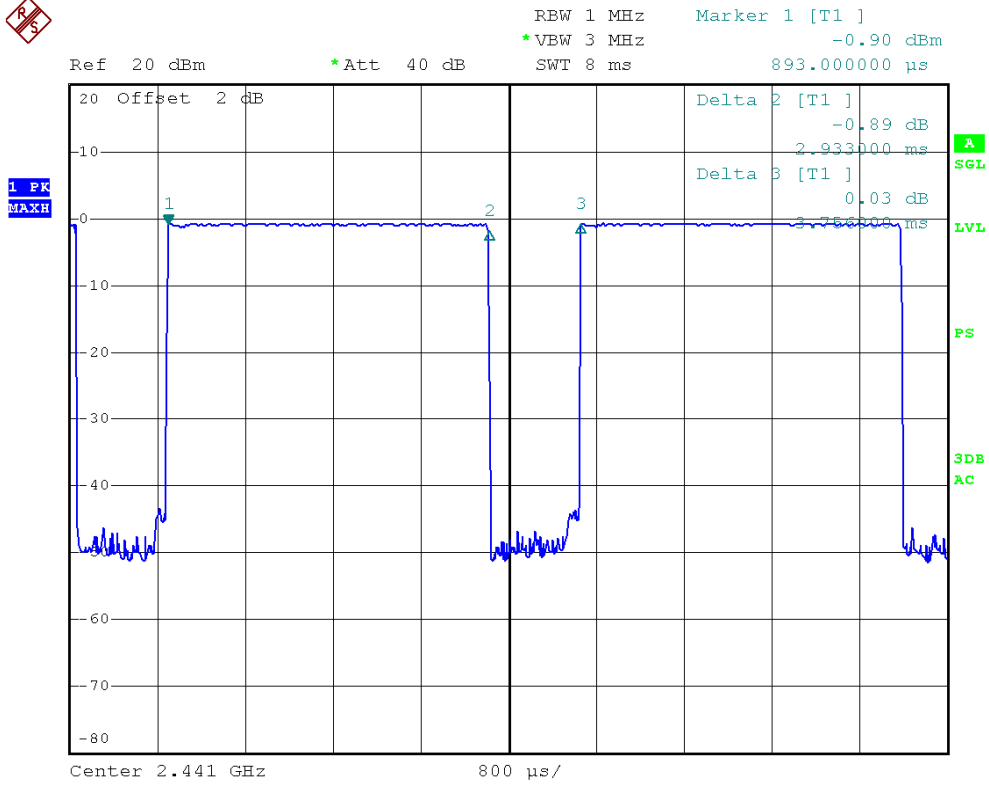

3. Highest channel (2.480GHz)

DH1

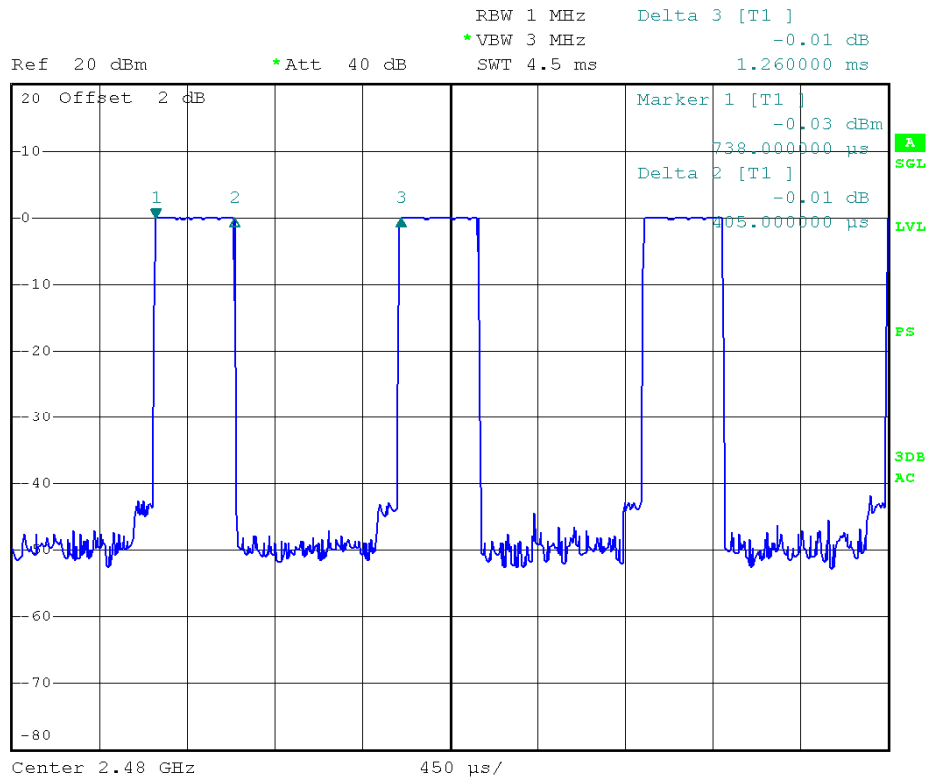

DH3

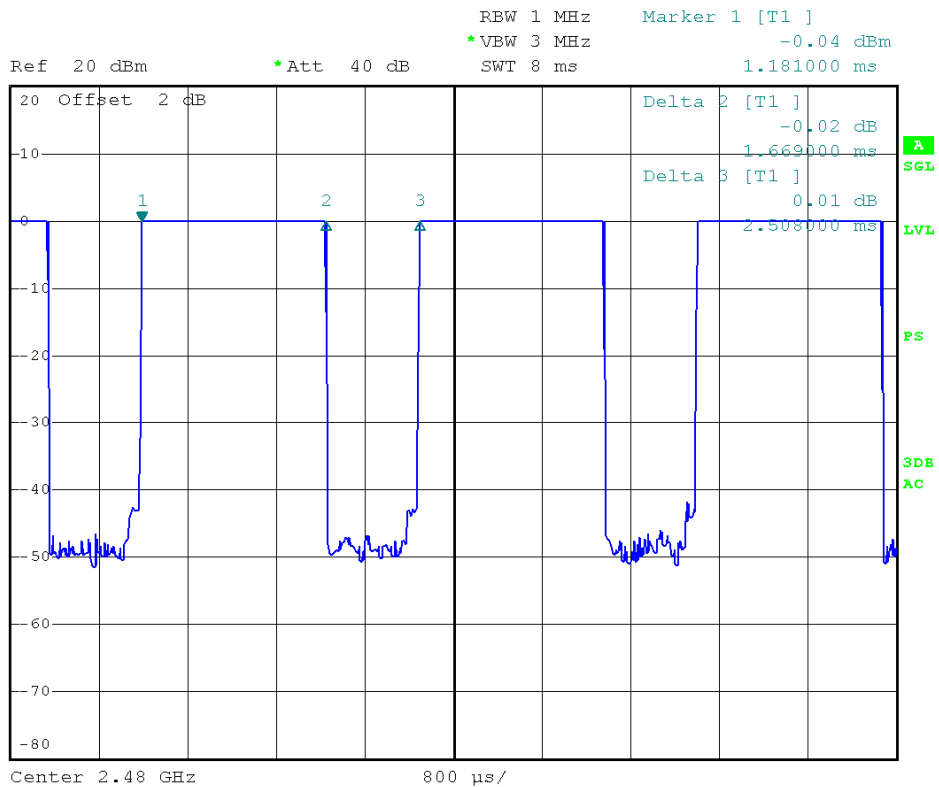

DH5

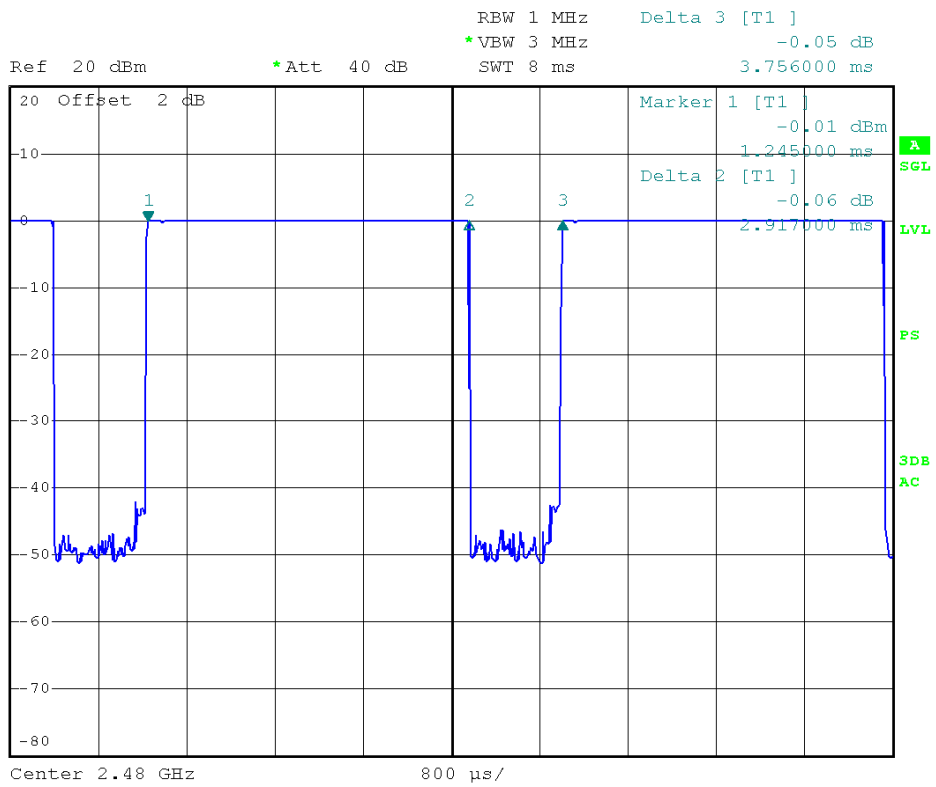

2DH1

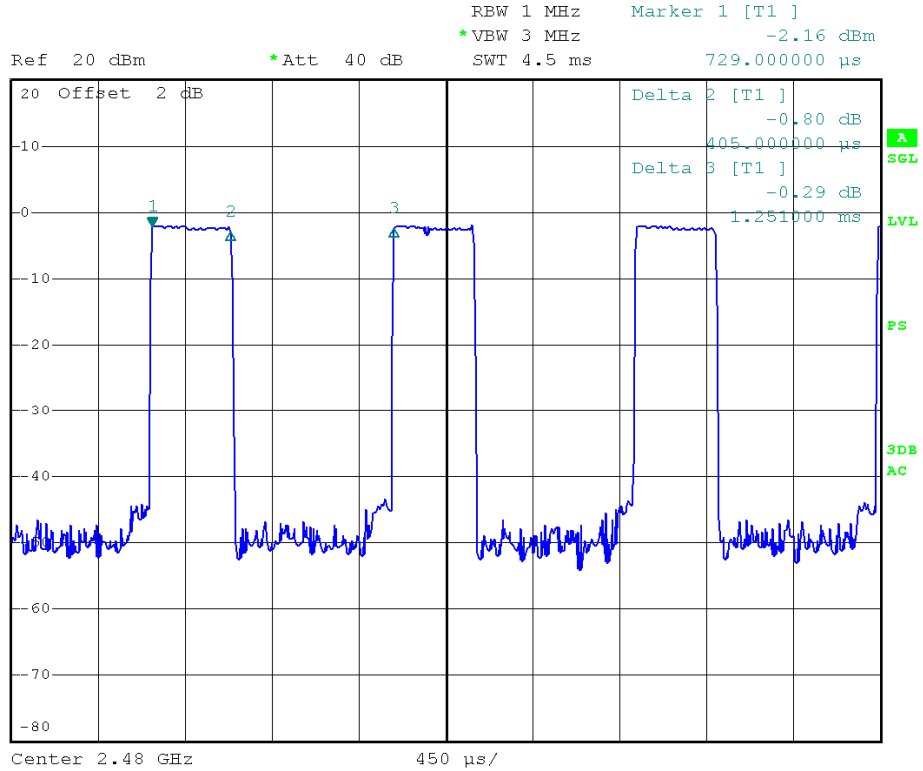

2DH3

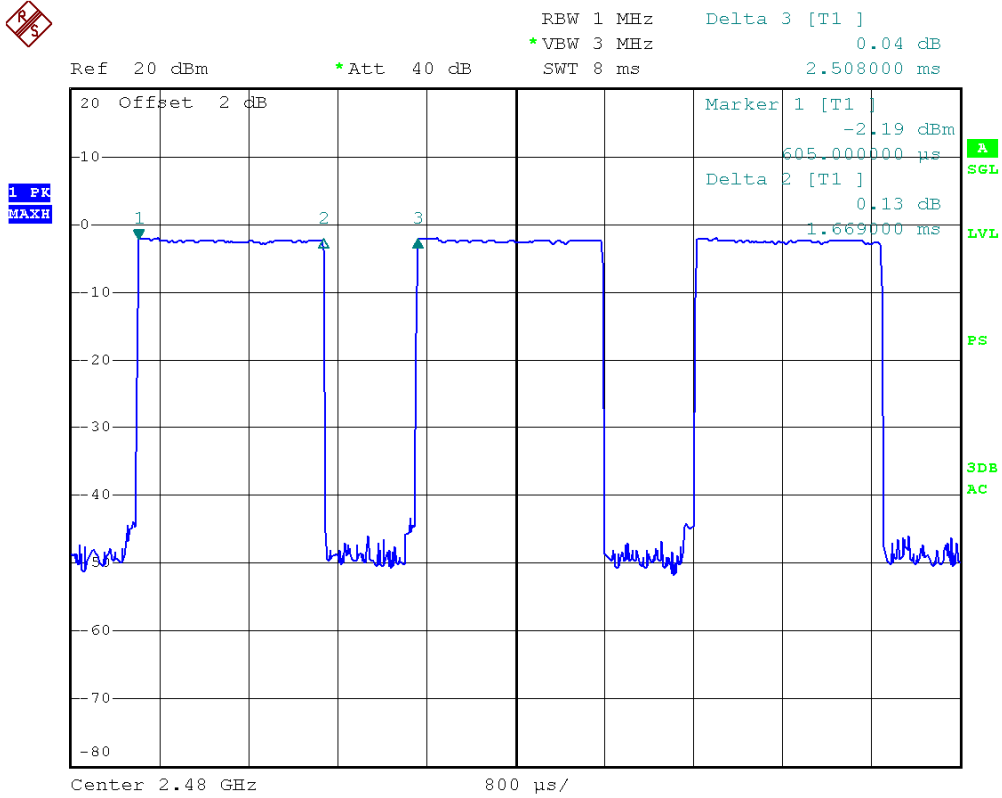

2DH5

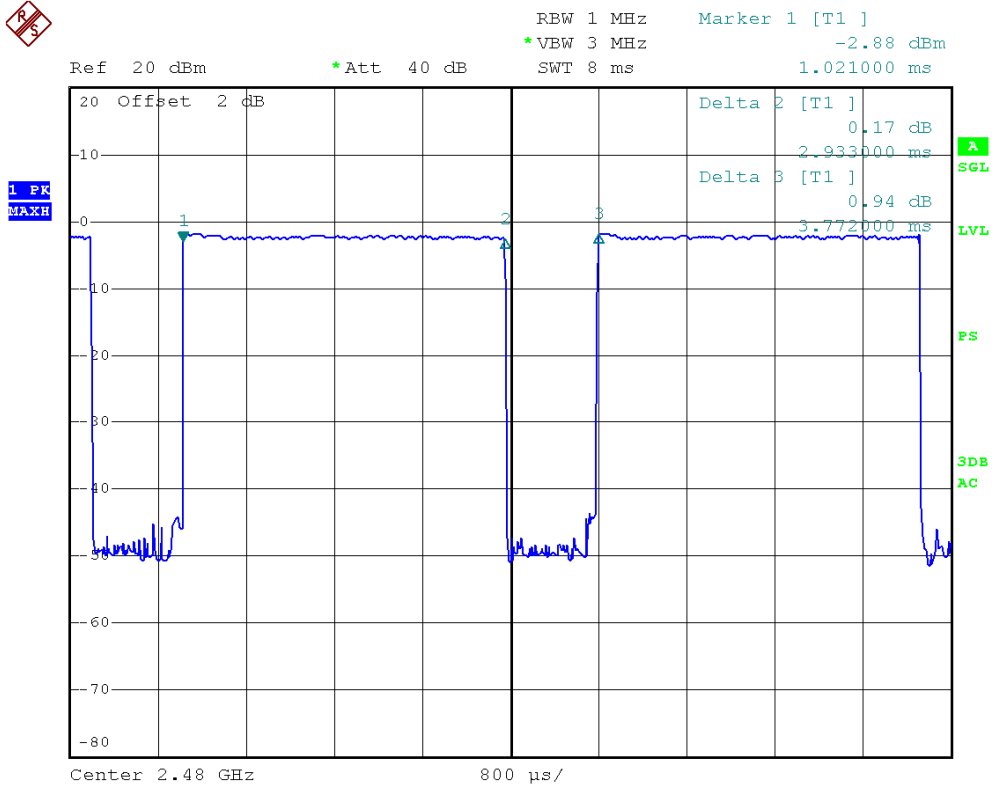

3DH1

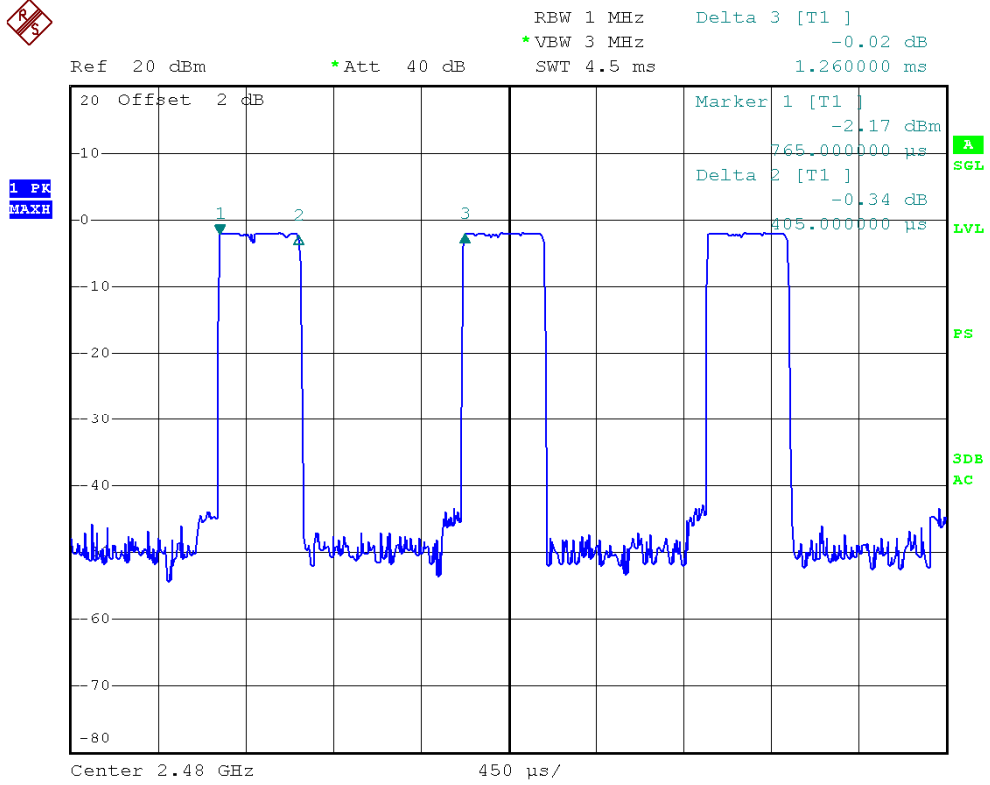

3DH3

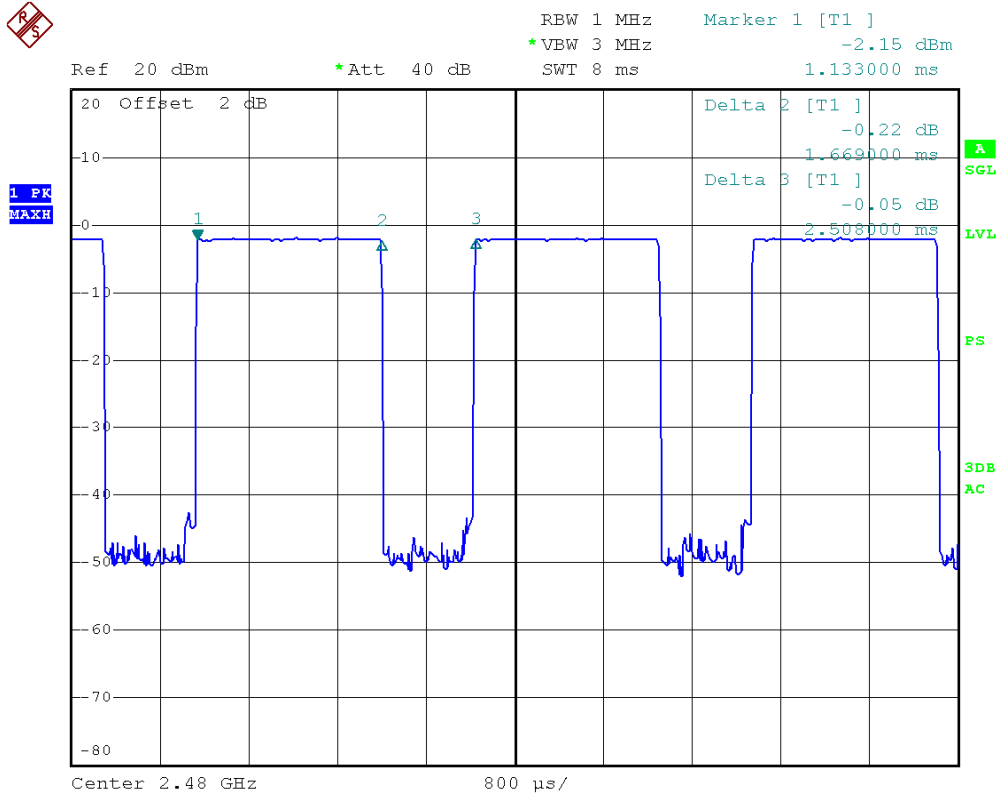

3DH5



RBW 1 MHz Delta 3 [T1] 0.00 dB
*VBW 3 MHz
SWT 8 ms 3.756000 ms

Ref 20 dBm

*Att 40 dB

1 PK
MAXH

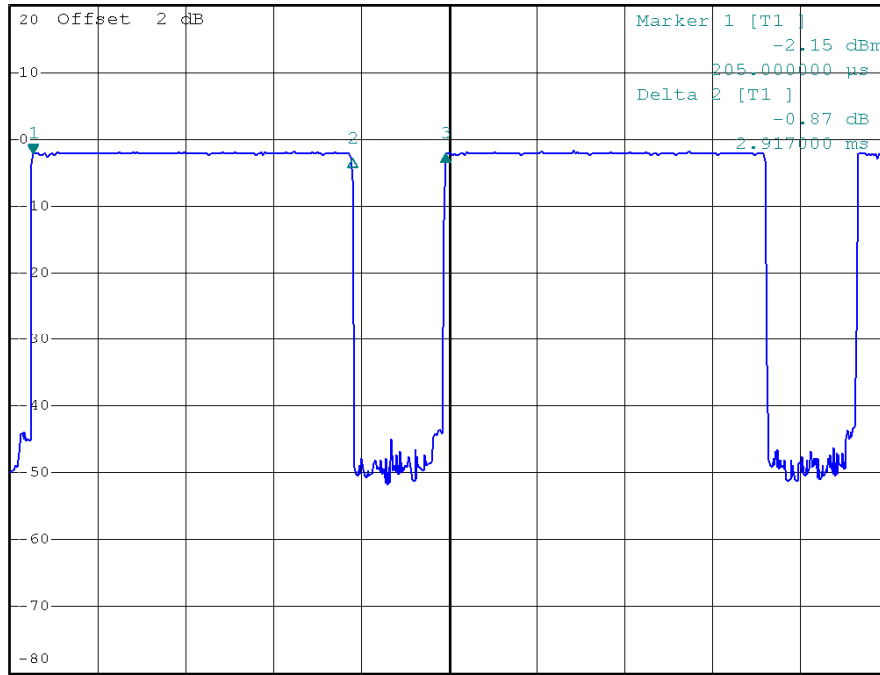

4.7 CONDUCTED EMISSION MEASUREMENT

4.7.1 LIMITS

Frequency range	Limits (dB μ V)	
	Quasi-peak	Average
150kHz ~ 0.5MHz	66~56	56~46
0.5 MHz ~ 5 MHz	56	46
5 MHz ~ 30 MHz	60	50

4.7.2 TEST PROCEDURES

Procedure of Preliminary Test

For measurement of the disturbance voltage the equipment under test (EUT) is connected to the power supply mains and any other extended network via one or more artificial network(s). An EUT, whether intended to be grounded or not, and which is to be used on a table is configured as follows:

- Either the bottom or the rear of the EUT shall be at a controlled distance of 40 cm from a reference ground plane. This ground plane is normally the wall or floor of a shielded room. It may also be a grounded metal plane of at least 2 m by 2 m. This is physically accomplished as follows:
 - 1) Place the EUT on a table of non-conducting material which is at least 80 cm high. Place the EUT so that it is 40 cm from the wall of the shielded room, or
 - 2) place the EUT on a table of non-conducting material which is 40 cm high so that the bottom of the EUT is 40 cm above the ground plane;
- All other conductive surfaces of the EUT shall be at least 80 cm from the reference ground plane;
- The EUT are placed on the floor that one side of the housings is 40 cm from the vertical reference ground plane and other metallic parts;
- Interconnecting cables that hang closer than 40 cm to the ground plane shall be folded back and forth forming a bundle 30 cm to 40 cm long, hanging approximately in the middle between the ground plane and the table.
- I/O cables that are connected to a peripheral shall be bundled in the centre. The end of the cable may be terminated if required using correct terminating impedance. The total length shall not exceed 1 m.

The test mode(s) described in Item 2.4 were scanned during the preliminary test. After the preliminary scan, we found the test mode described in Item 2.4 producing the highest emission level. The EUT configuration and cable configuration of the above highest emission levels were recorded for reference of the final test.

Procedure of Final Test

EUT and support equipment were set up on the test bench as per the configuration with highest emission level in the preliminary test. A scan was taken on both power lines, recording at least the six highest emissions. Emission frequency and amplitude were recorded into a computer in which correction factors were used to calculate the emission level and compare reading to the applicable limit. The test data of the worst-case condition(s) was recorded.

4.7.3 TEST SETUP

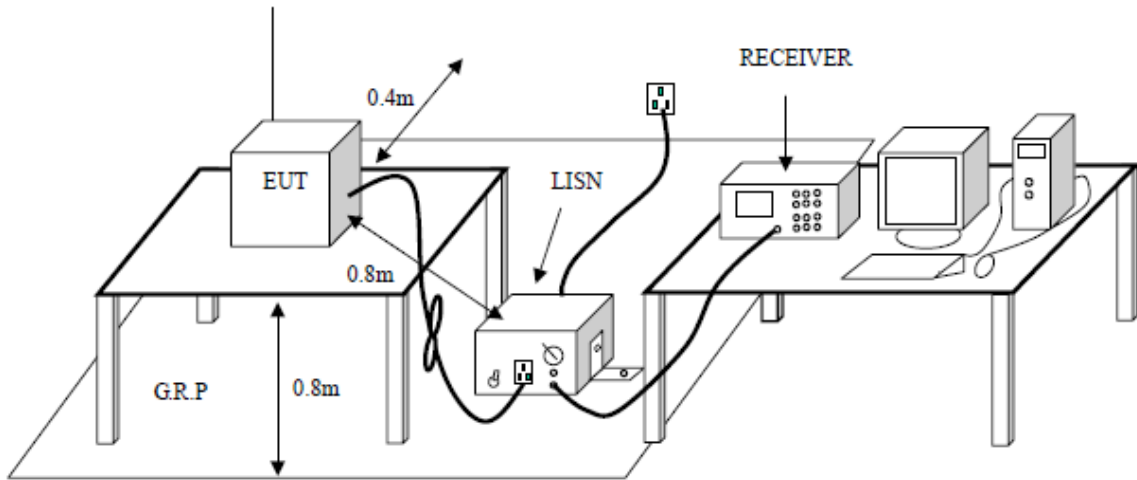

4.7.4 TEST RESULTS

Project No.:	ZJ00032008	Probe:	L1
Standard:	(CE)FCC PART 15 class B_QP	Power Source:	
Test item:	Conduction Test	Date:	2013-8-12
Temp./Hum.(%RH):	21/56%RH	Time:	14:45:08
EUT:	JBL AUTHENTICS L8	Test Result:	Pass
Model:			
Note:			

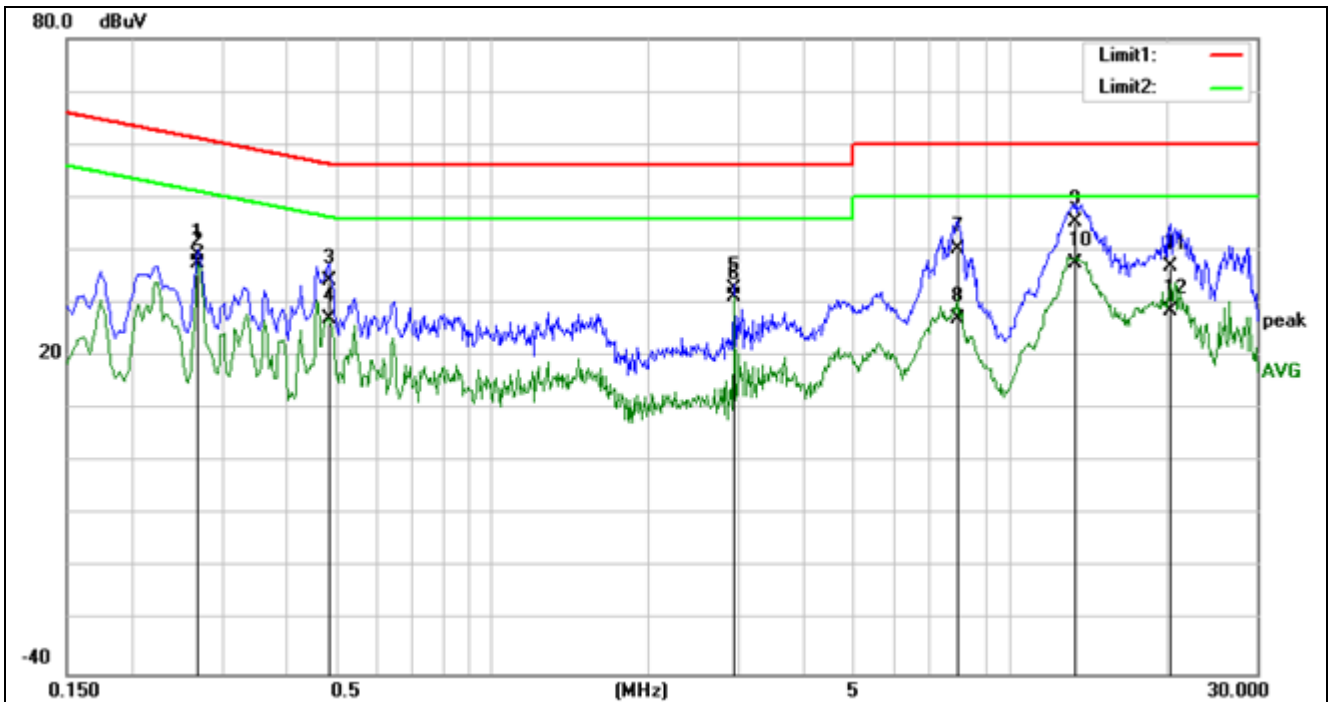

No.	Frequency (MHz)	Reading (dBuV)	Correct Factor(dB)	Result (dBuV)	Limit (dBuV)	Margin (dB)	Remark
1	0.2700	38.98	0.12	39.10	61.12	-22.02	QP
2	0.2700	37.48	0.12	37.60	51.12	-13.52	AVG
3	0.4820	34.08	0.12	34.20	56.30	-22.10	QP
4	0.4820	26.98	0.12	27.10	46.30	-19.20	AVG
5	2.9340	32.61	0.29	32.90	56.00	-23.10	QP
6	2.9340	30.81	0.29	31.10	46.00	-14.90	AVG
7	7.9380	39.72	0.58	40.30	60.00	-19.70	QP
8	7.9380	26.62	0.58	27.20	50.00	-22.80	AVG
9	13.3380	44.78	0.72	45.50	60.00	-14.50	QP
10	13.3380	36.98	0.72	37.70	50.00	-12.30	AVG
11	20.3900	35.96	1.14	37.10	60.00	-22.90	QP
12	20.3900	27.46	1.14	28.60	50.00	-21.40	AVG

Project No.:	ZJ00032008	Probe:	N
Standard:	(CE)FCC PART 15 class B_QP	Power Source:	
Test item:	Conduction Test	Date:	2013-8-12
Temp./Hum.(%RH):	21/56%RH	Time:	14:50:31
EUT:	JBL AUTHENTICS L8	Test Result:	Pass
Model:			
Note:			

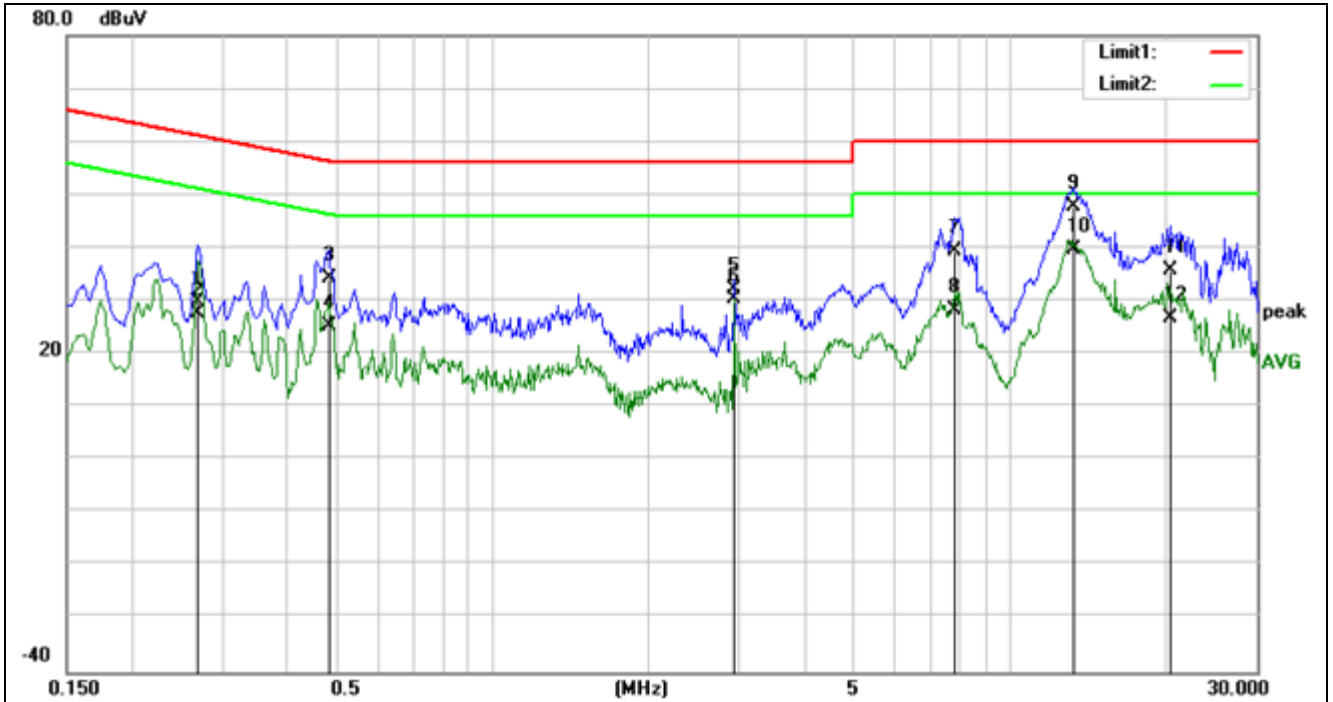

No.	Frequency (MHz)	Reading (dBuV)	Correct Factor(dB)	Result (dBuV)	Limit (dBuV)	Margin (dB)	Remark
1	0.2700	29.48	0.12	29.60	61.12	-31.52	QP
2	0.2700	27.48	0.12	27.60	51.12	-23.52	AVG
3	0.4820	34.28	0.12	34.40	56.30	-21.90	QP
4	0.4820	25.08	0.12	25.20	46.30	-21.10	AVG
5	2.9340	31.81	0.29	32.10	56.00	-23.90	QP
6	2.9340	30.11	0.29	30.40	46.00	-15.60	AVG
7	7.8220	38.82	0.58	39.40	60.00	-20.60	QP
8	7.8220	27.72	0.58	28.30	50.00	-21.70	AVG
9	13.2980	47.09	0.71	47.80	60.00	-12.20	QP
10	13.2980	39.09	0.71	39.80	50.00	-10.20	AVG
11	20.3860	34.66	1.14	35.80	60.00	-24.20	QP
12	20.3860	25.46	1.14	26.60	50.00	-23.40	AVG

4.8 MAXIMUM PEAK OUTPUT POWER

4.8.1 LIMITS

Regulation 15.247 (b)(1) For frequency hopping systems operating in the 2400-2483.5 MHz band employing at least 75 non-overlapping hopping channels, and all frequency hopping systems in the 5725-5850 MHz band: 1 watt. For all other frequency hopping systems in the 2400-2483.5 MHz band: 0.125 watts. Refer to the result "Hopping channel number" of this document. The 1 watt (30.0dBm) limit applies.

4.8.2 TEST PROCEDURES

1. Remove the antenna from the EUT and then connect a low RF cable from the antenna port to the spectrum.
2. Set the spectrum analyzer: RBW = 3 MHz. VBW = 3 MHz. Sweep = auto; Detector Function = Peak.
3. Keep the EUT in transmitting at lowest, medium and highest channel individually. Record the max value.

Remark:

1. Pre-test the 3 modulation to find GFSK and 8DPSK is worse case, so only record GFSK and 8DPSK test data.
2. Cable loss = 2dB, the receiver offset loss 2dB

4.8.3 TEST SETUP

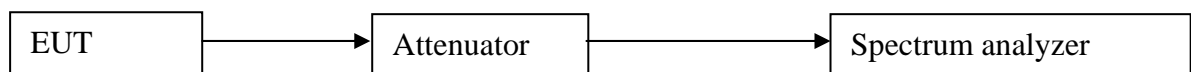

4.8.4 TEST RESULTS

For GFSK:

Test Channel	Fundamental Frequency (GHz)	Max Output Power(dBm)	Limit (dBm)	Pass/Fail
Lowest	2.402	2.71	30.0	Pass
Middle	2.441	-0.03	30.0	Pass
Highest	2.480	-0.61	30.0	Pass

For 8DPSK:

Test Channel	Fundamental Frequency (GHz)	Max Output Power(dBm)	Limit (dBm)	Pass/Fail
Lowest	2.402	1.75	30.0	Pass
Middle	2.441	-0.98	30.0	Pass
Highest	2.480	-1.94	30.0	Pass

Test result: The unit does meet the FCC requirements.

Test result plot as follows:

GFSK Lowest Channel:

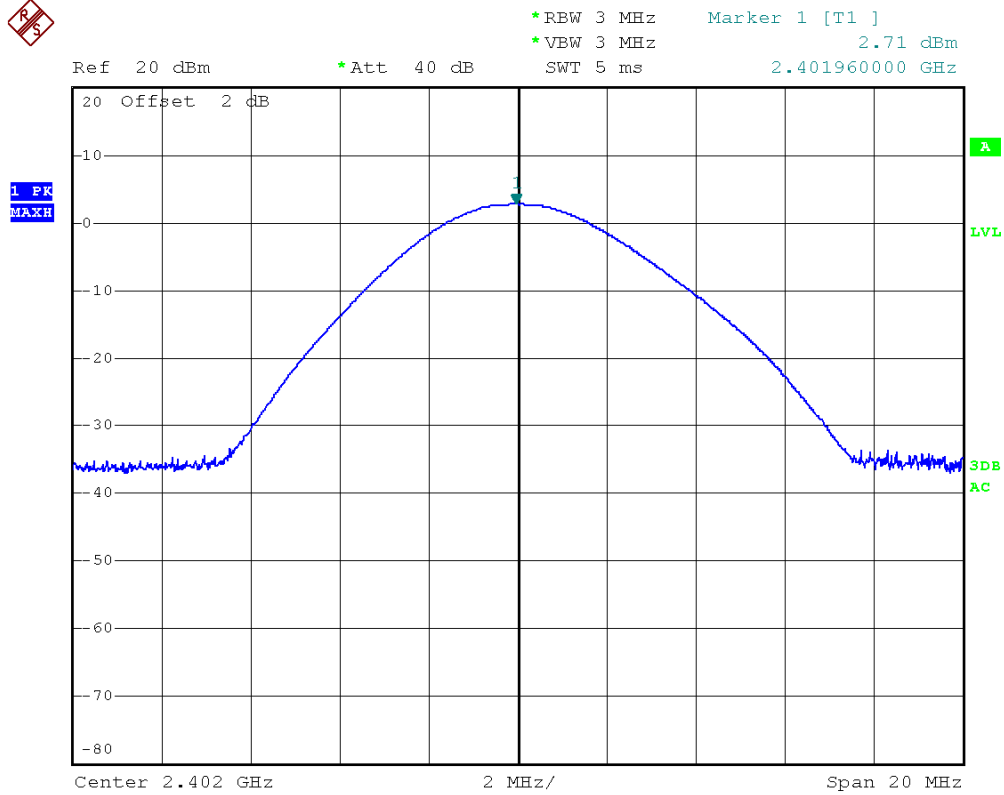

GFSK Middle Channel:

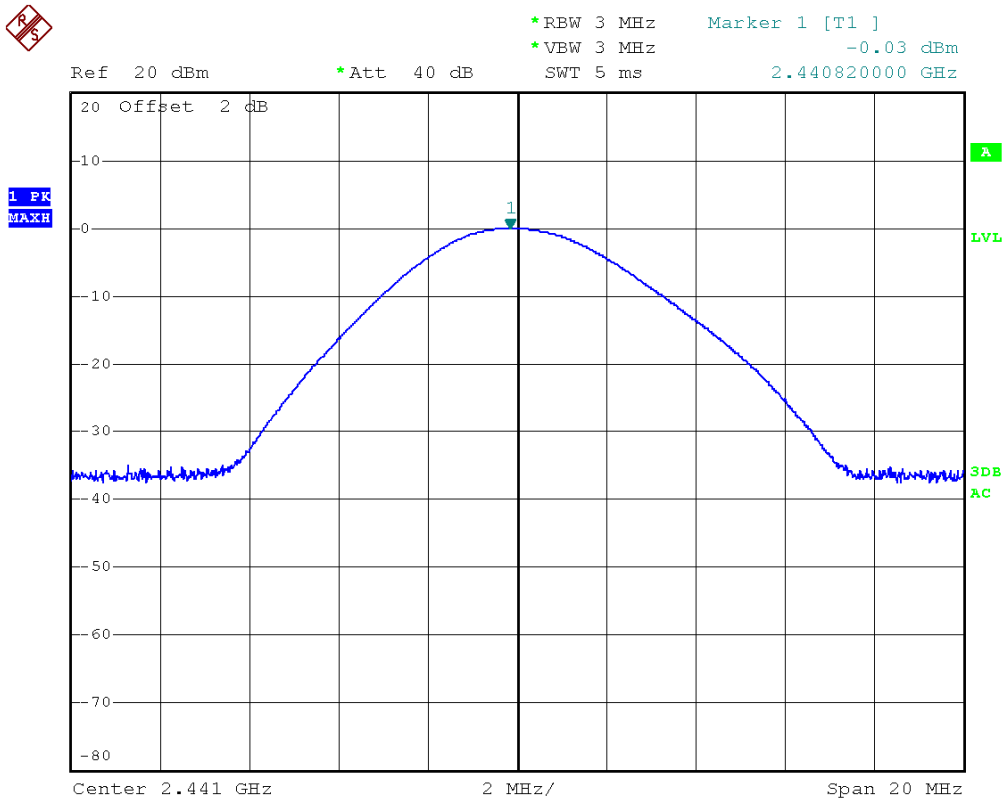

GFSK Highest Channel:

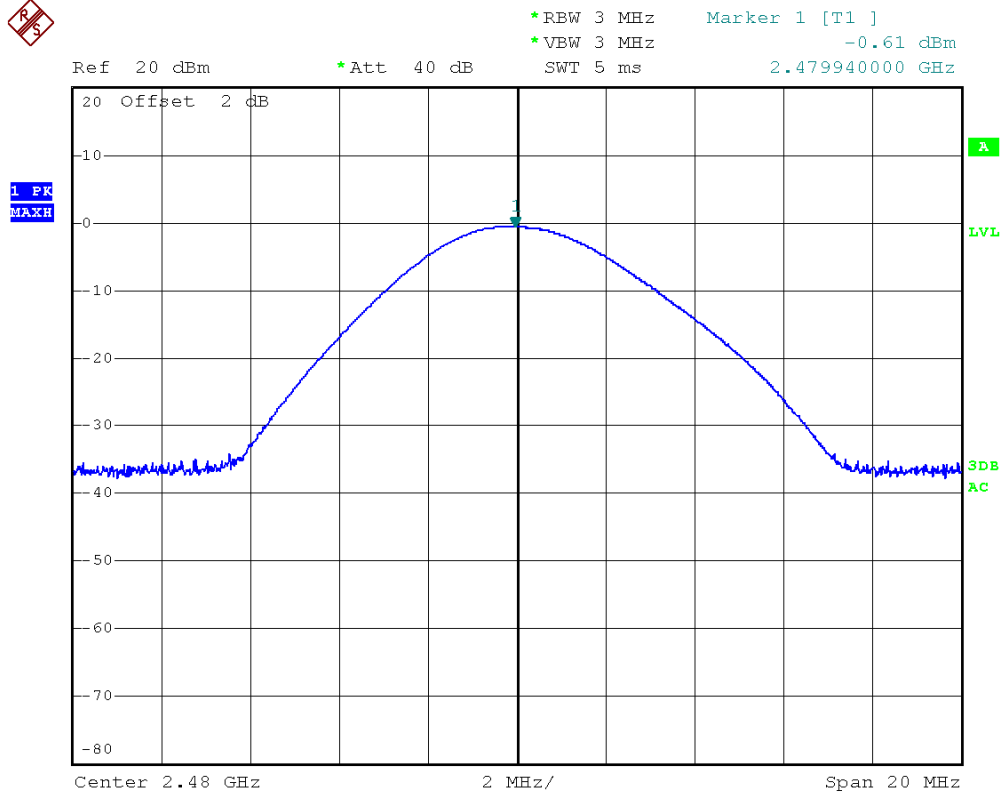

8DPSK Lowest Channel:

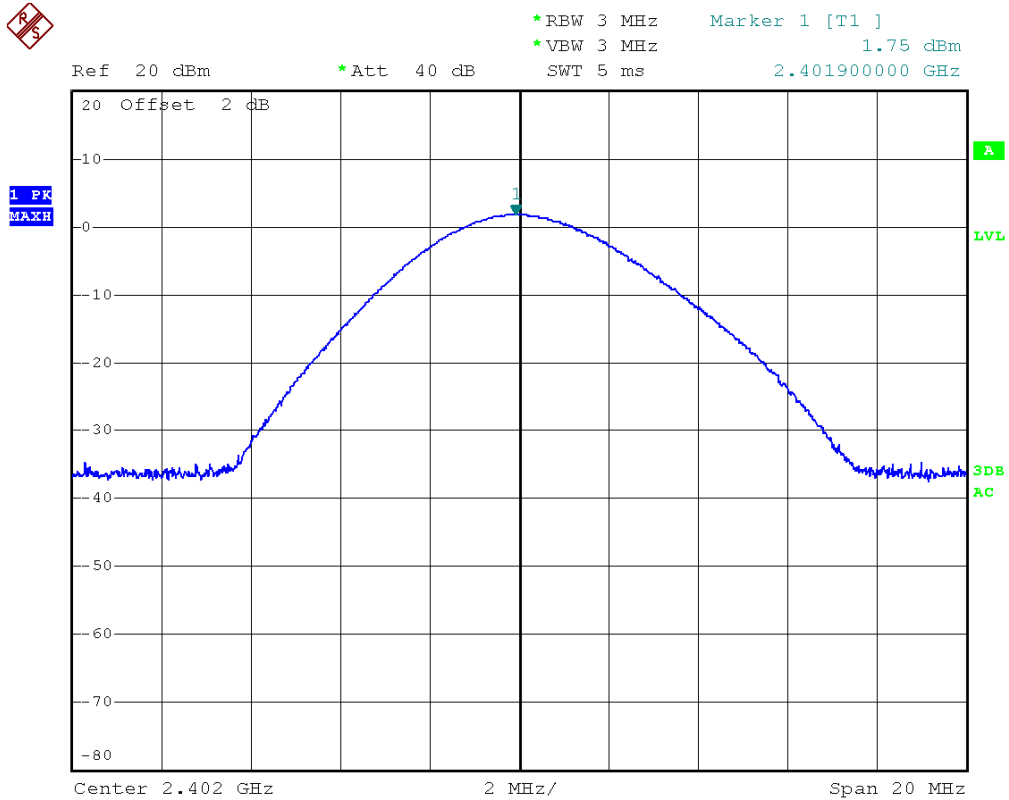

8DPSK Middle Channel:

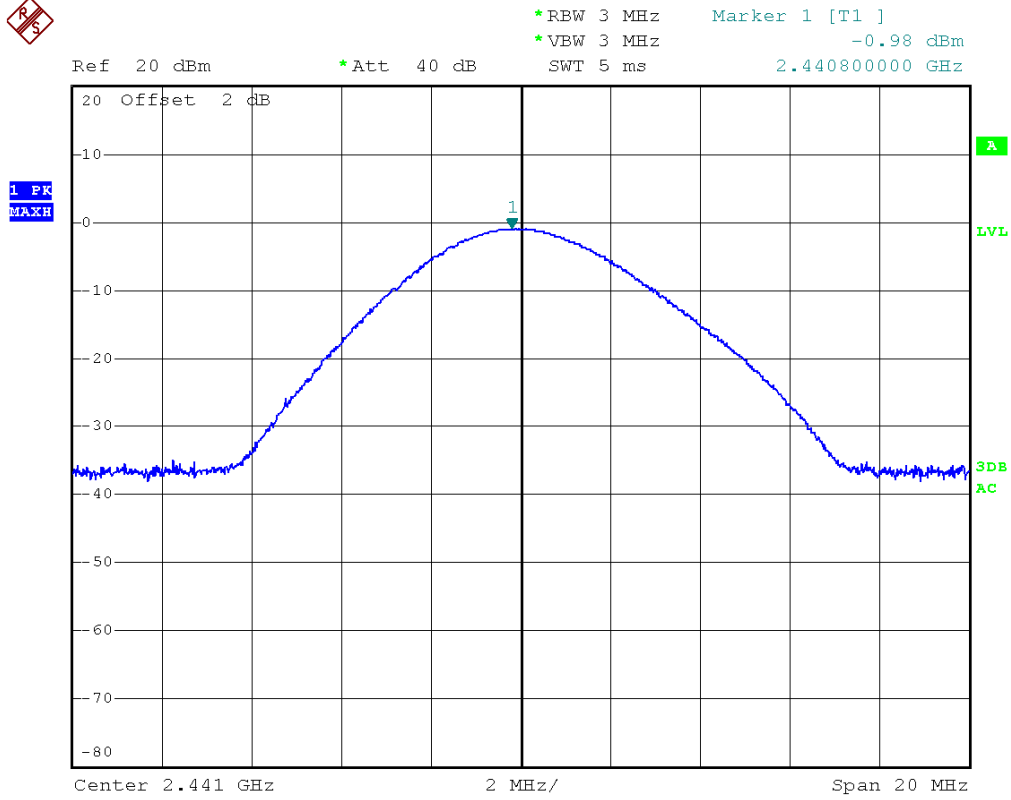

8DPSK Highest Channel:

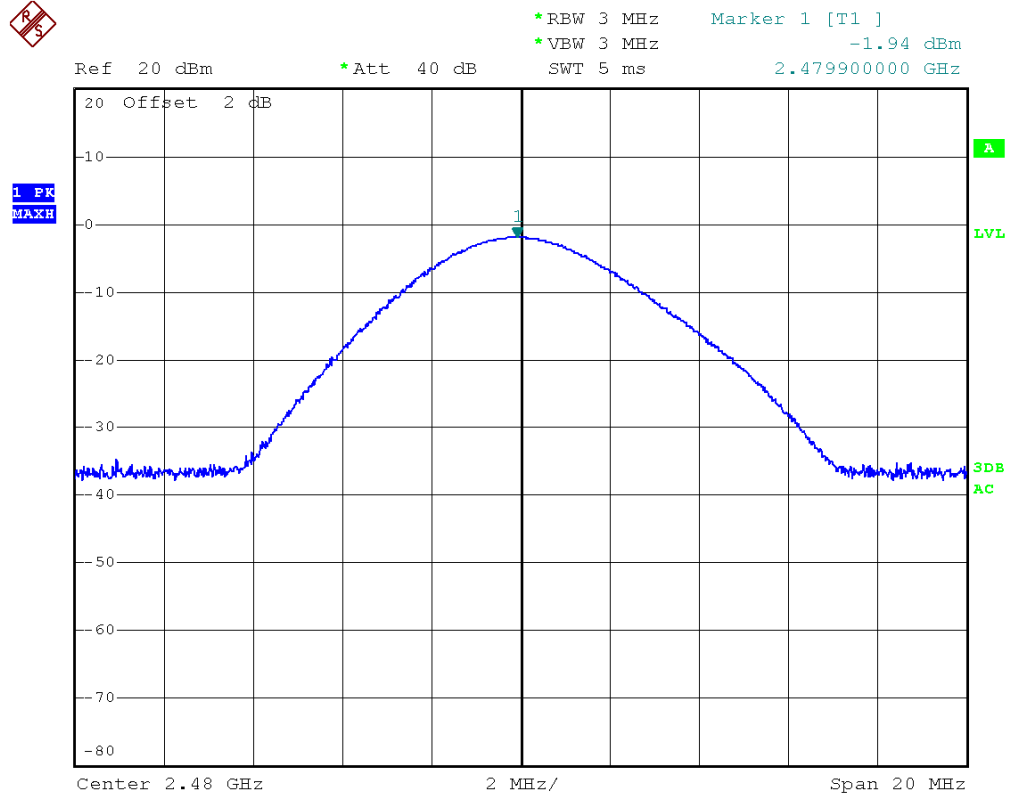

4.9 CONDUCTED SPURIOUS EMISSIONS

4.9.1 LIMITS

(d) In any 100 kHz bandwidth outside the frequency band in which the spread spectrum or digitally modulated intentional radiator is operating. The radio frequency power that is produced by the intentional radiator shall be at least 20 dB below that in the 100 kHz bandwidth within the band that contains the highest level of the desired power. based on either an RF conducted or a radiated measurement. Provided the transmitter demonstrates compliance with the peak conducted power limits.

4.9.2 TEST PROCEDURES

Remove the antenna from the EUT and then connect a low attenuation cable from the antenna port to the spectrum.

Below 1GHz Set the spectrum analyzer: RBW =100KHz VBW \geq RBW, Span = enough to catch the trace. Sweep = auto; Detector Function = Peak. Trace = Max, hold.

Above 1GHz Set the spectrum analyzer: RBW =1MHz VBW \geq RBW, Span = enough to catch the trace. Sweep = auto; Detector Function = Peak. Trace = Max, hold.

4.9.3 TEST SETUP

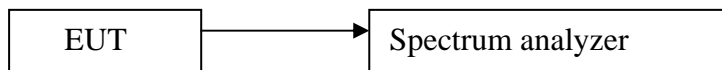

4.9.4 TEST RESULTS

The unit does meet the FCC requirements.

Test result plot as follows:

For GFSK

Lowest Channel:

30M to 1GHz

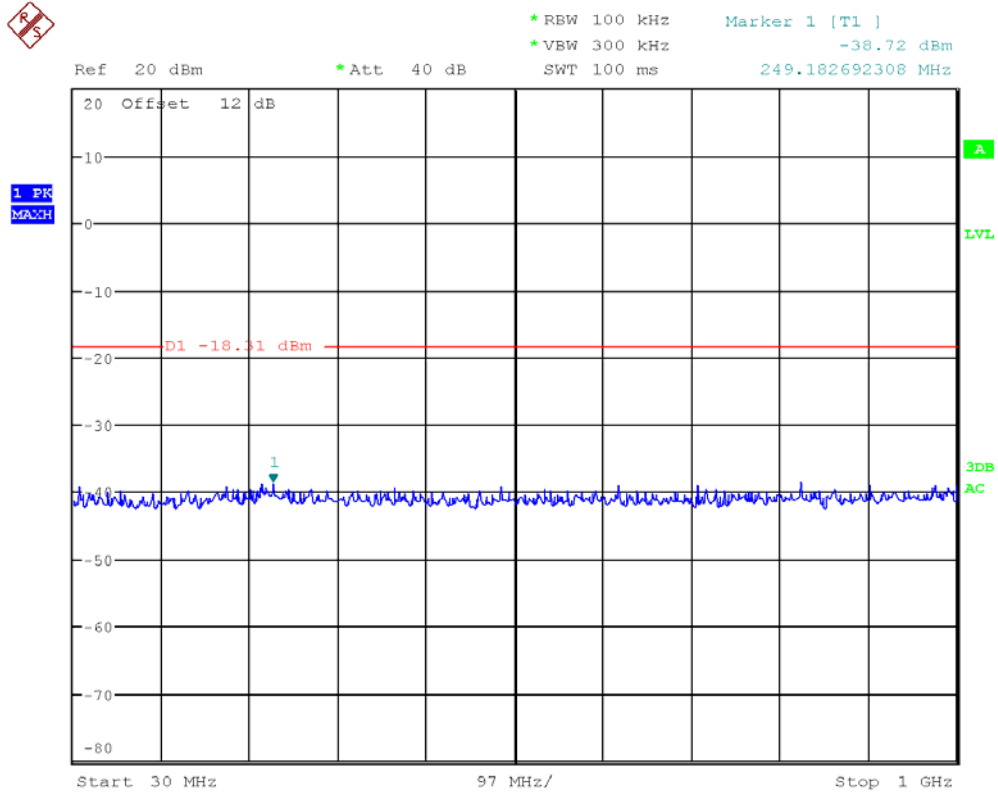

1G to 10GHz

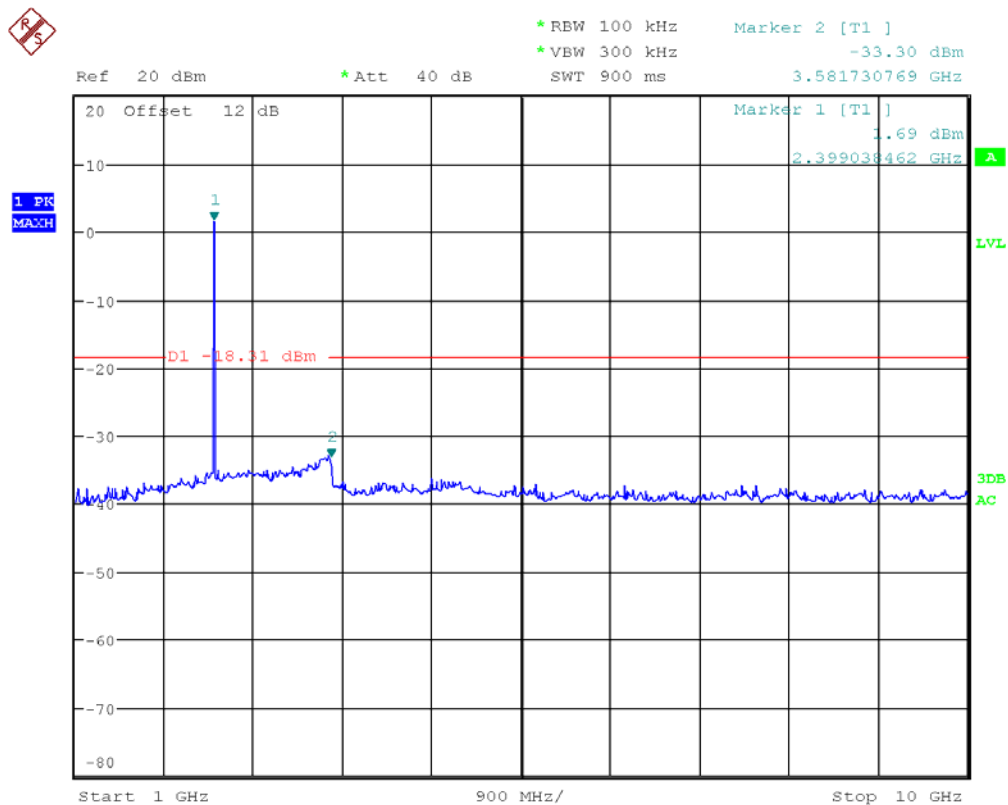

10G to 25GHz

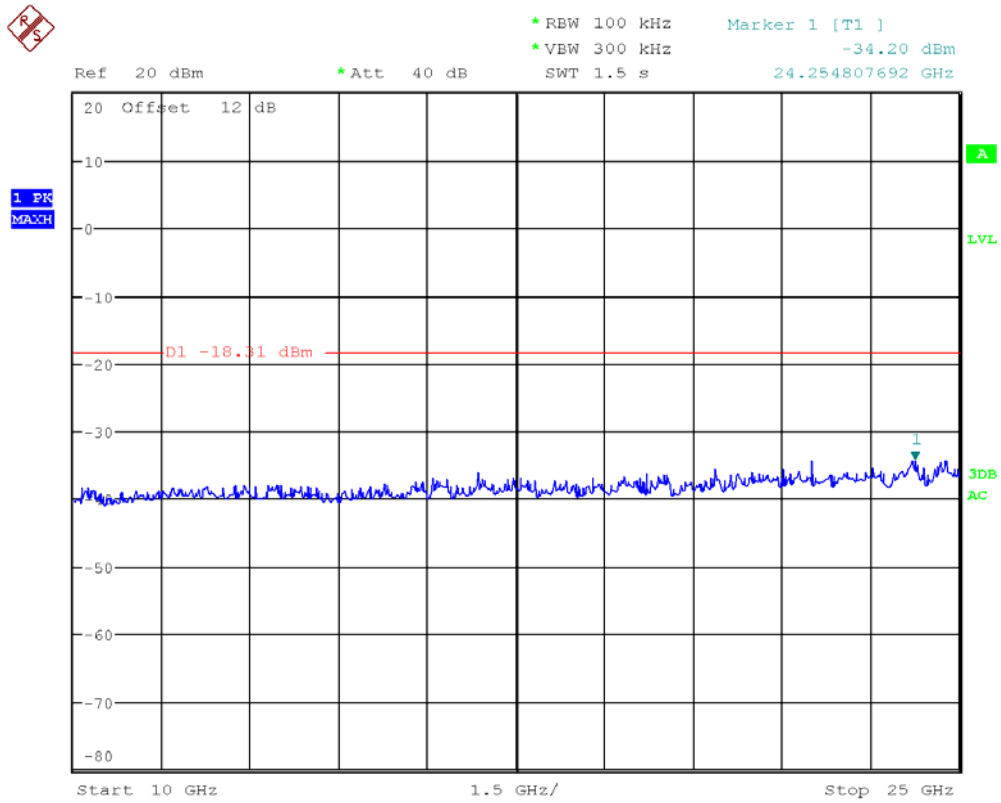

Middle Channel:

30M to 1GHz

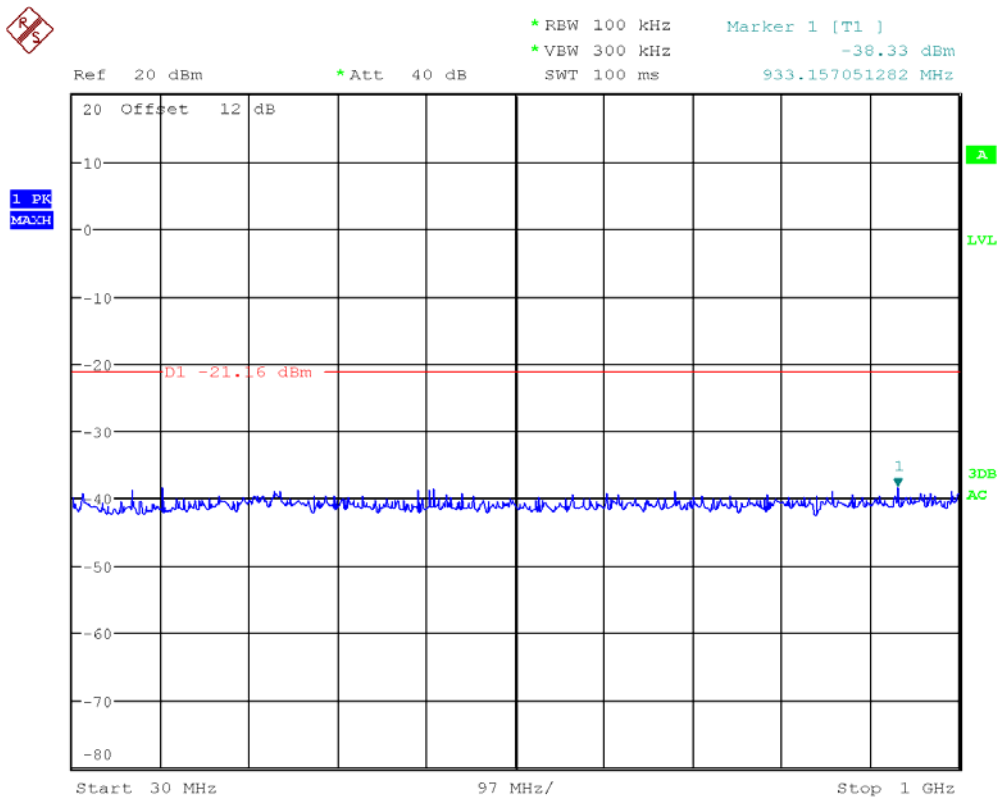

1G to 10GHz

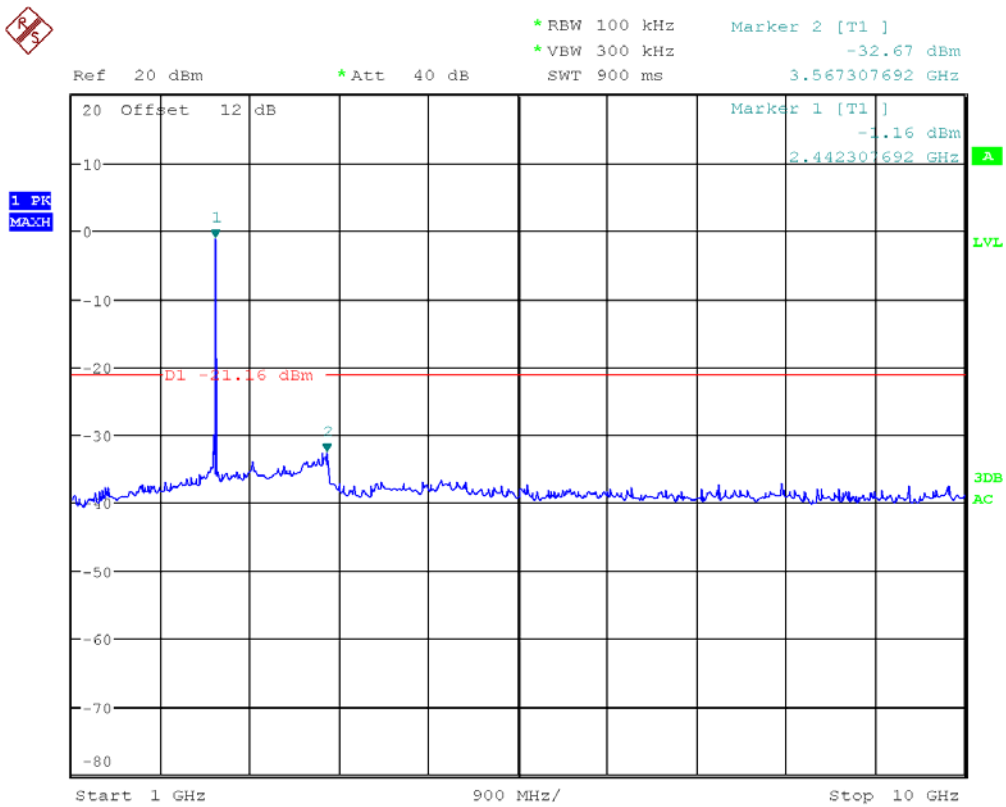

10G to 25GHz

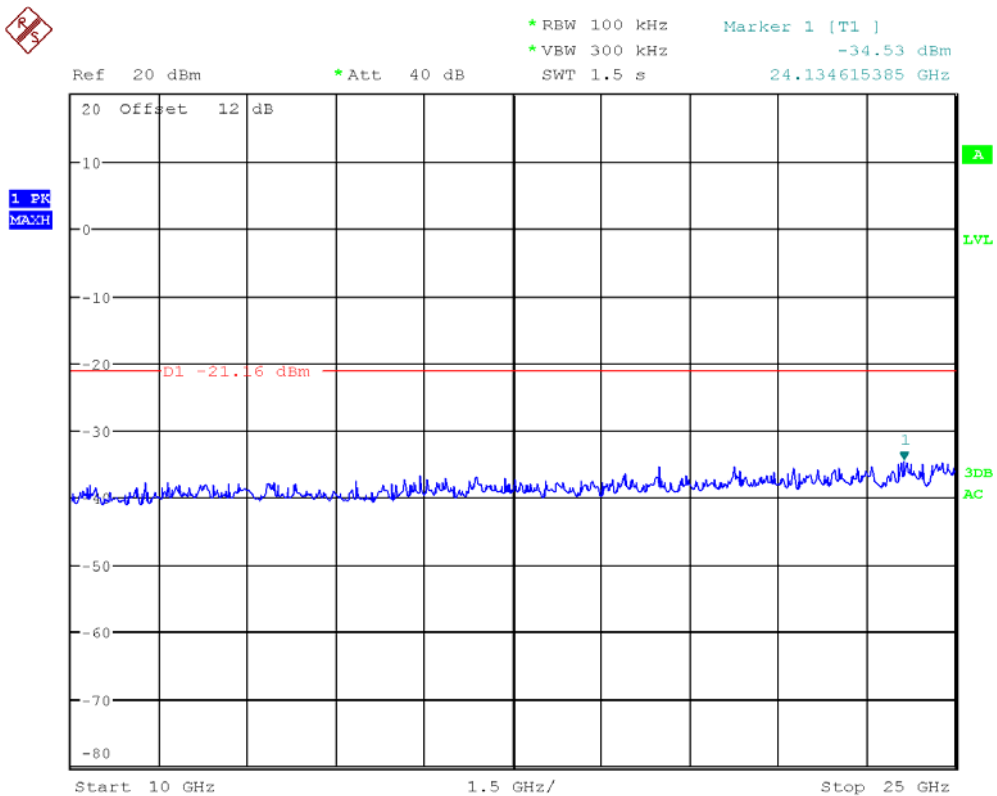

Highest Channel:

30M to 1GHz

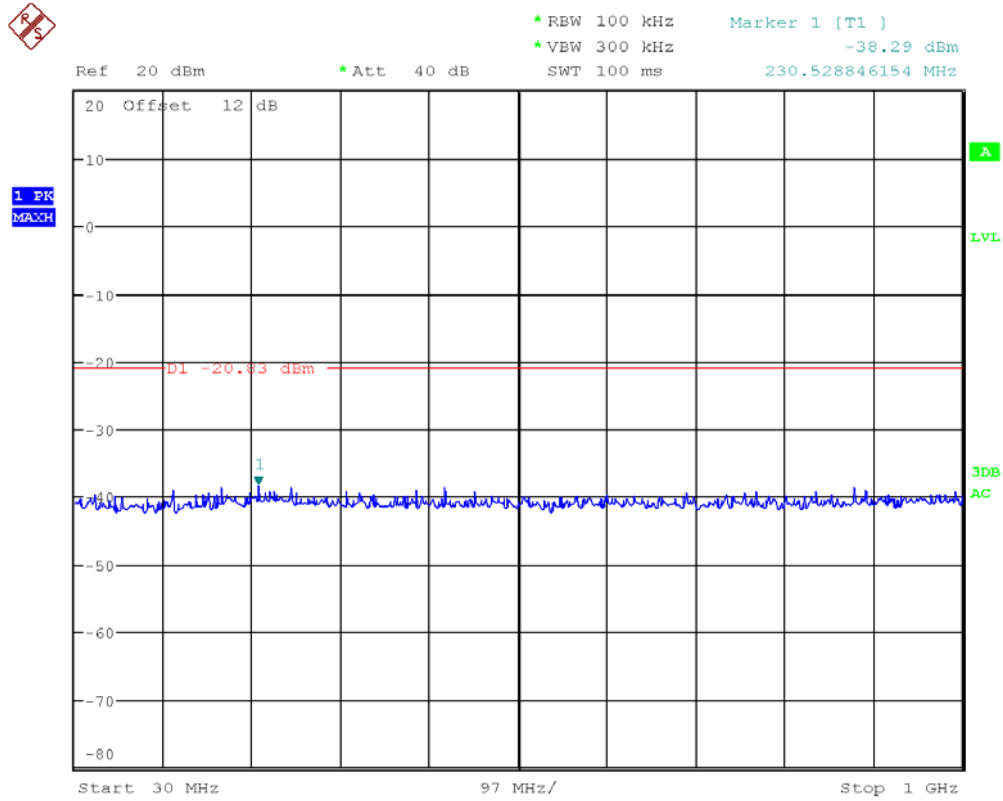

1G to 10GHz

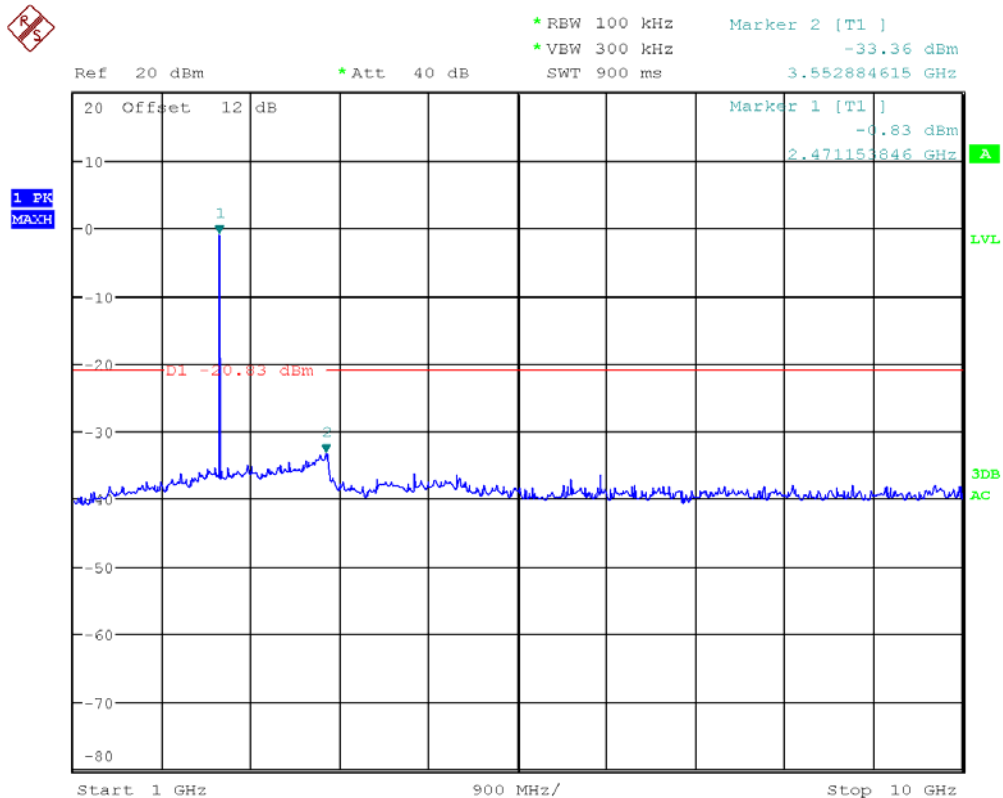

10G to 25GHz

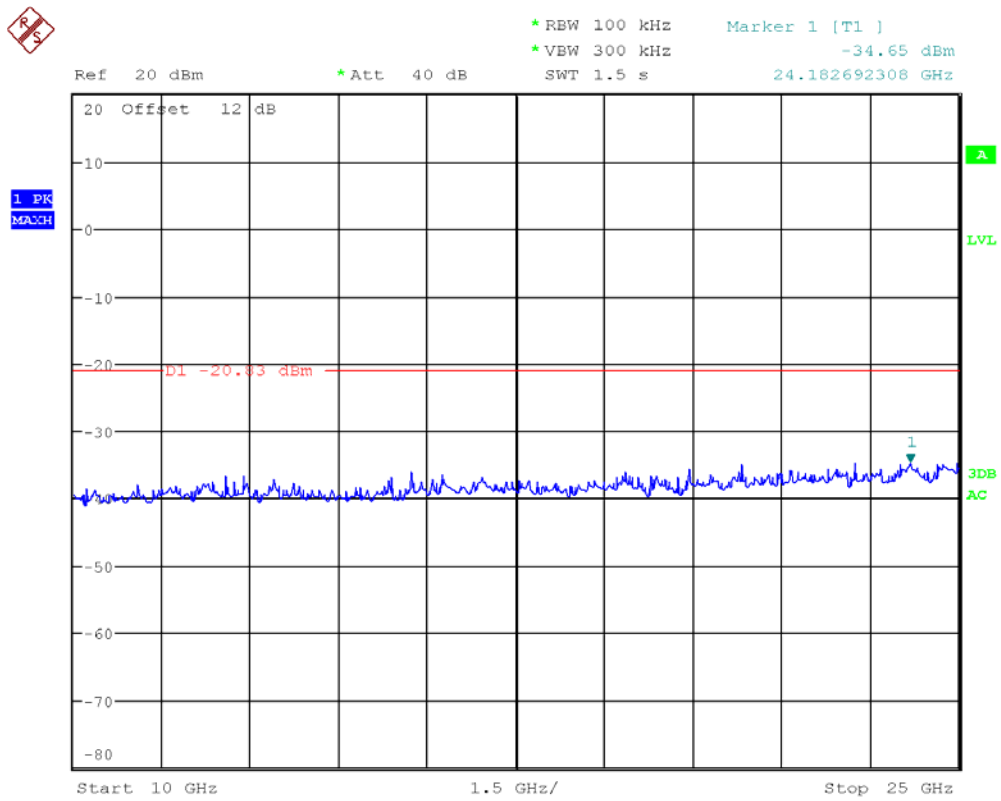

For 8DPSK

Lowest Channel:

30M to 1GHz

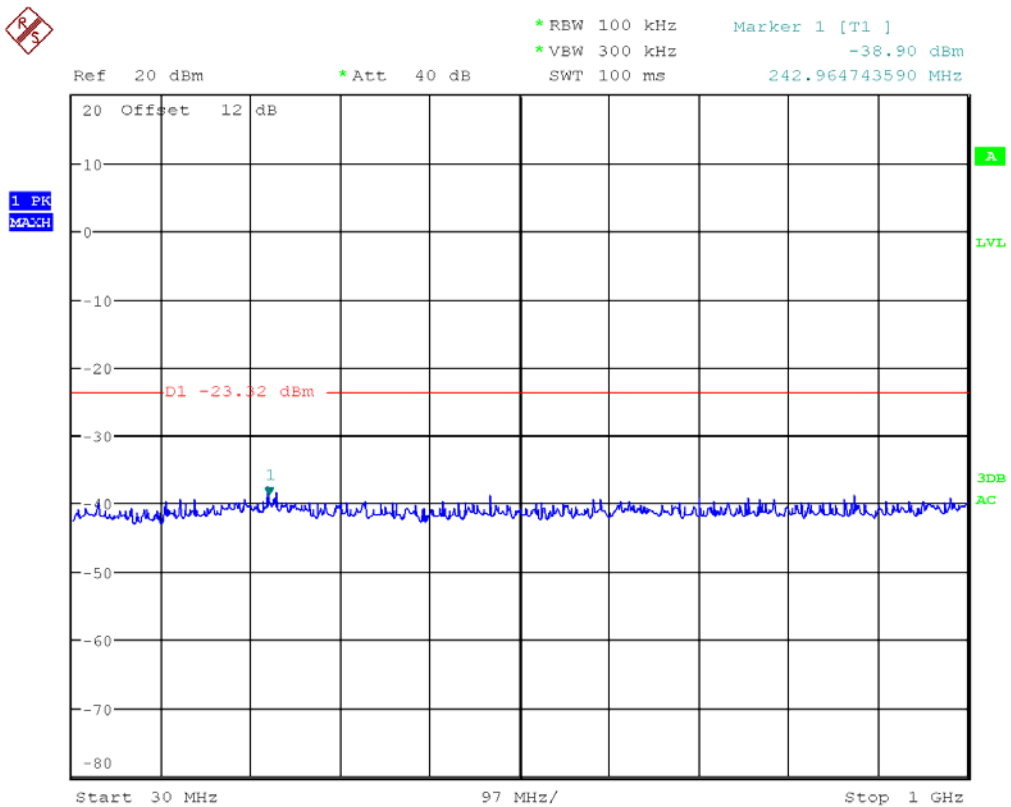

1G to 10GHz

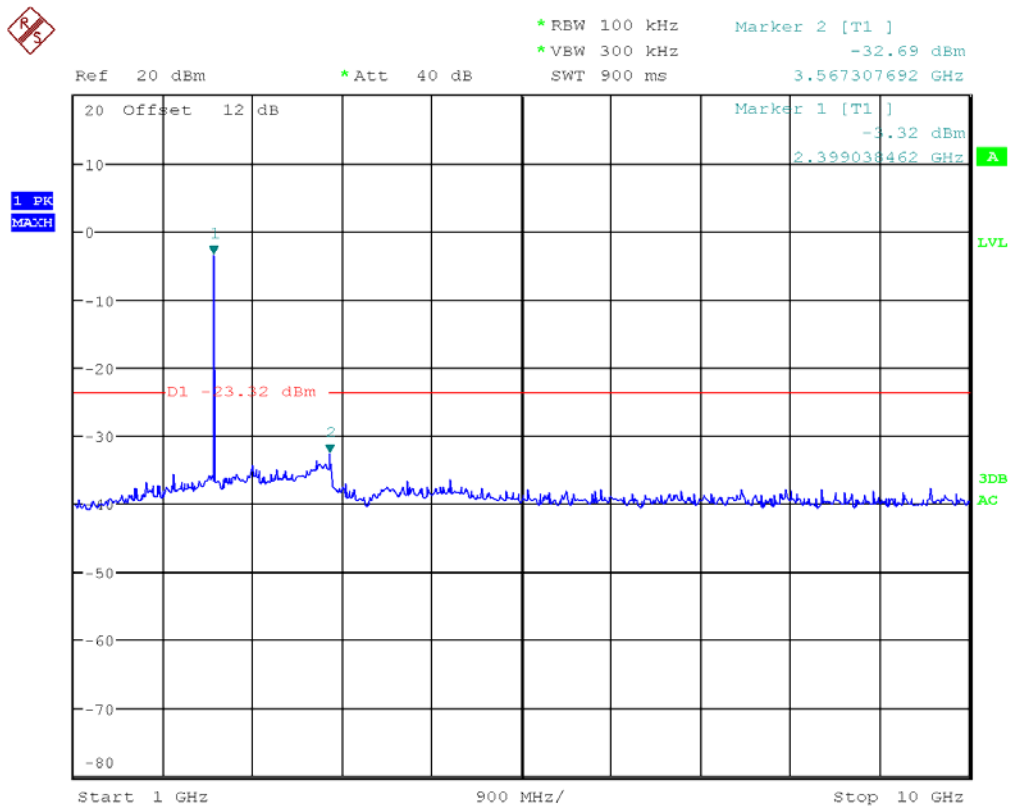

10G to 25GHz

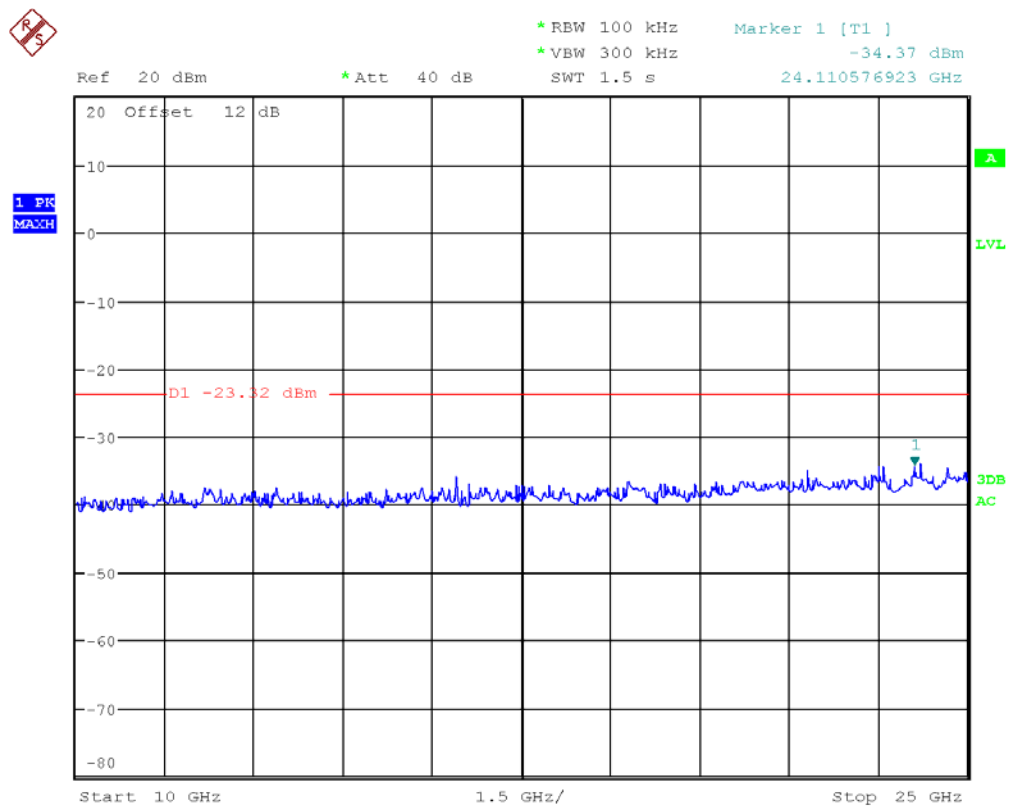

Middle Channel:

30M to 1GHz

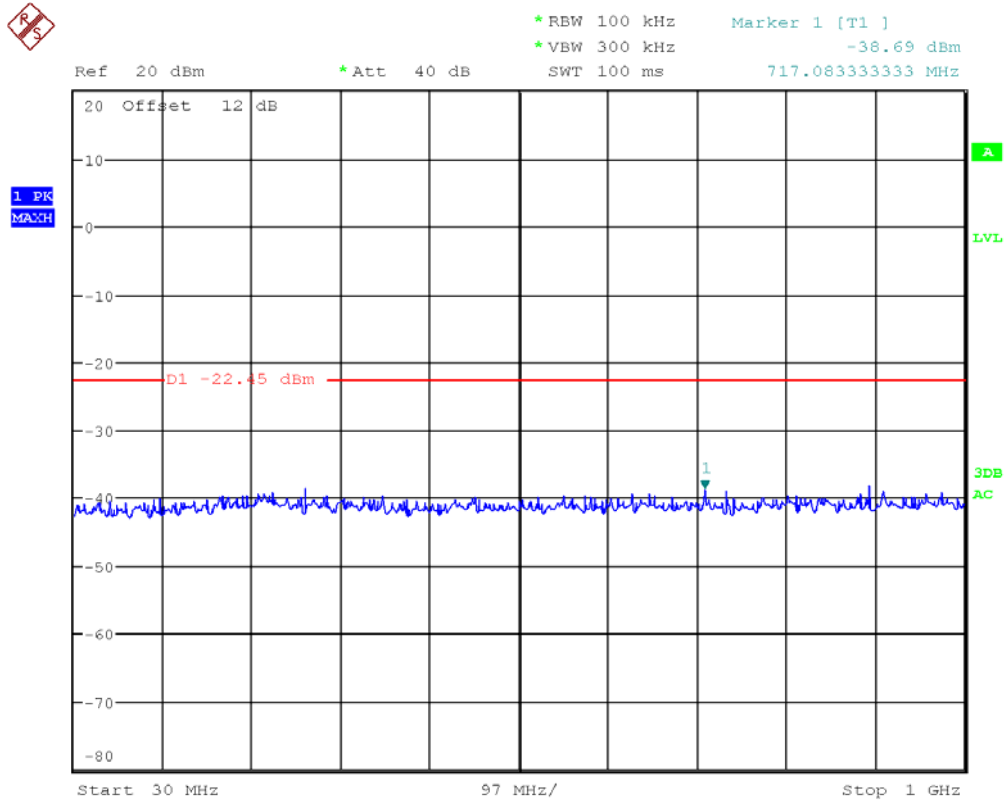

1G to 10GHz

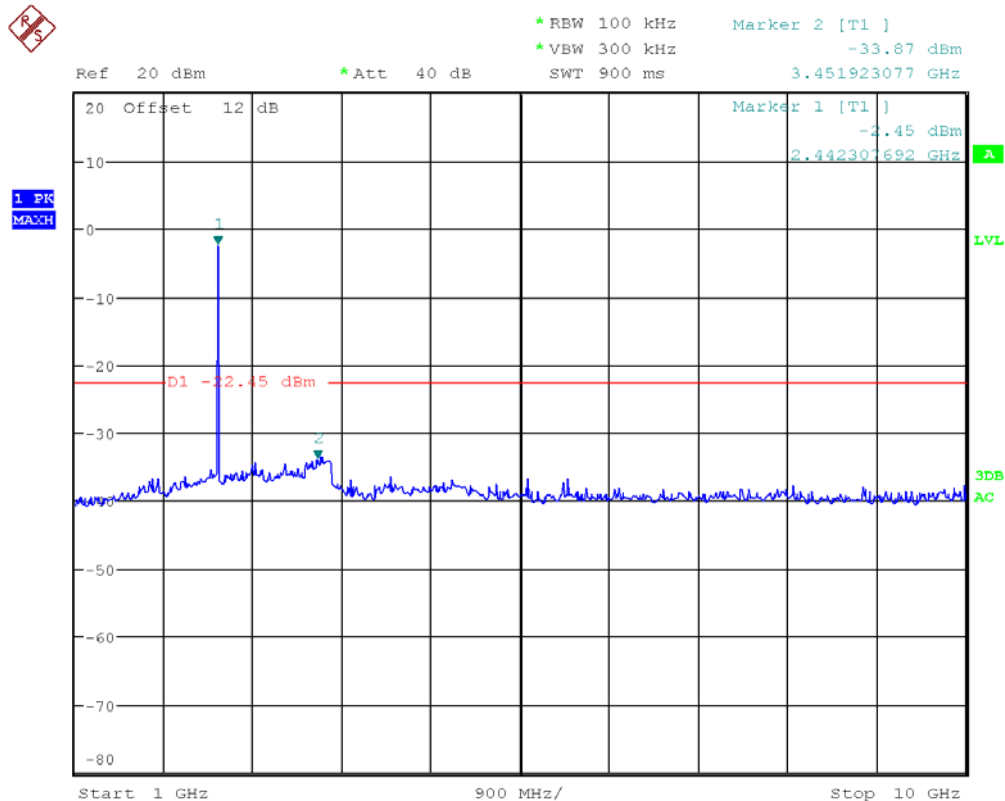

10G to 25GHz

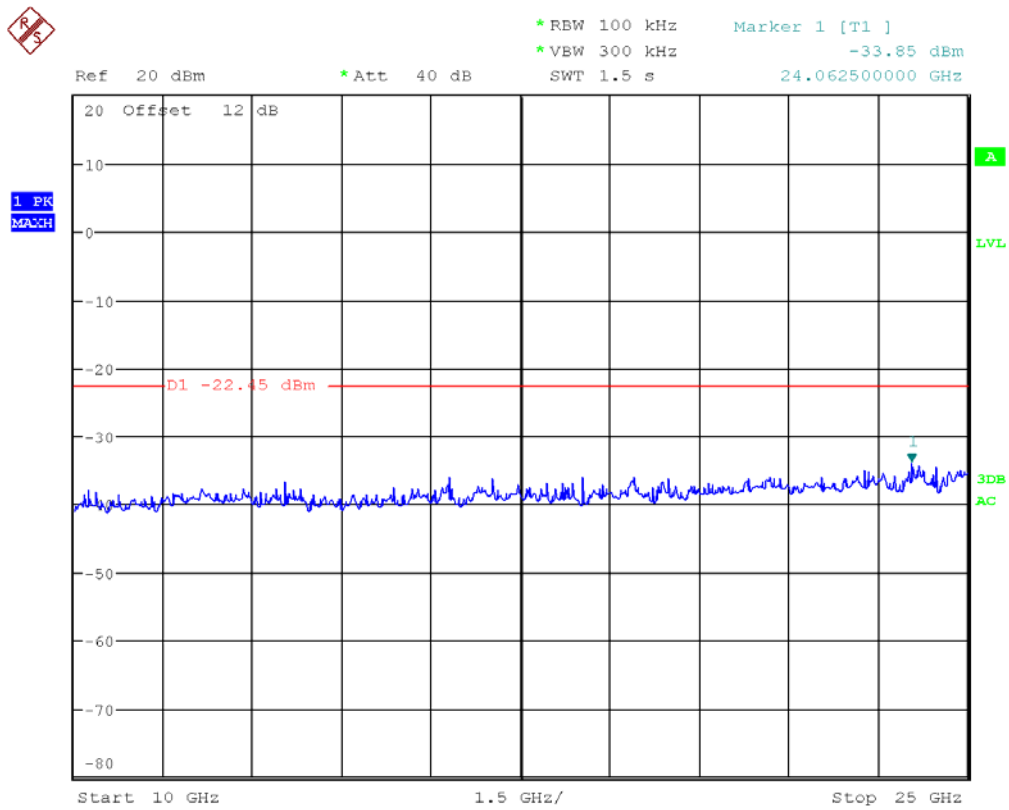

Highest Channel

30M to 1GHz

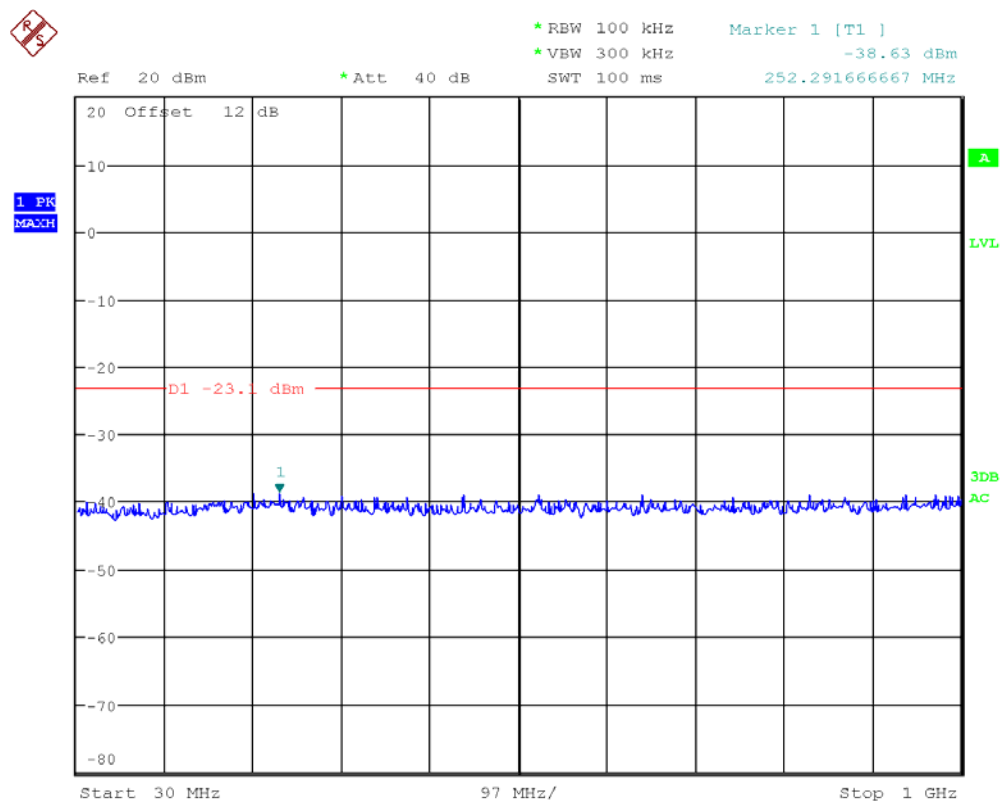

1G to 10GHz

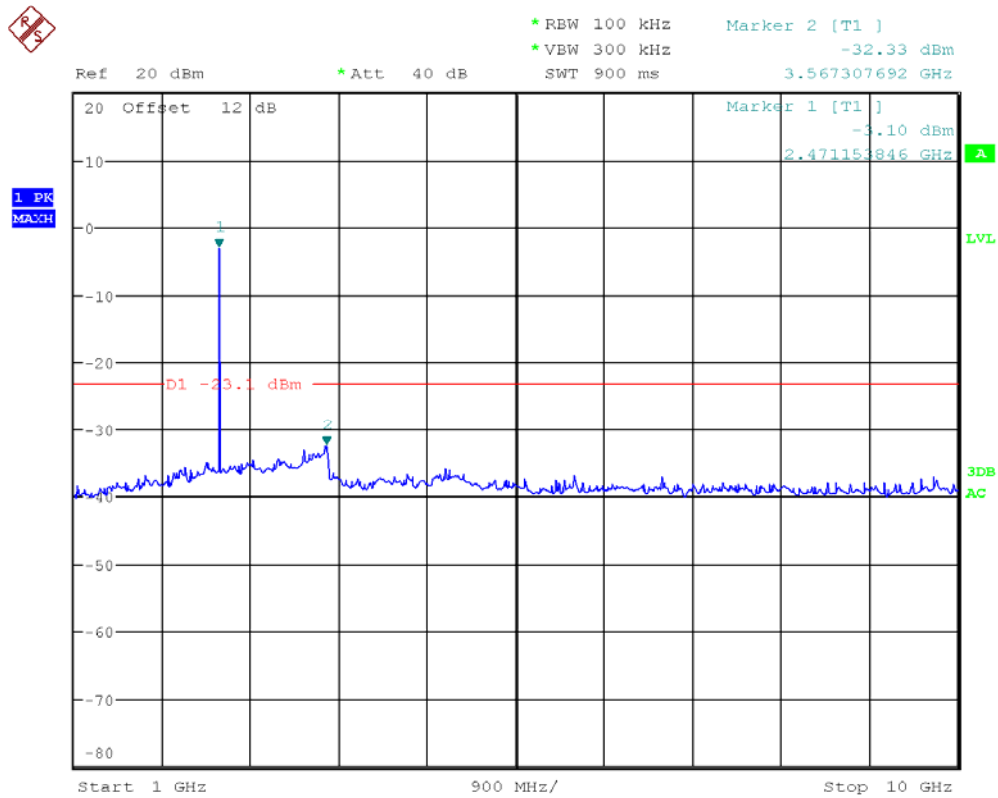

10G to 25GHz

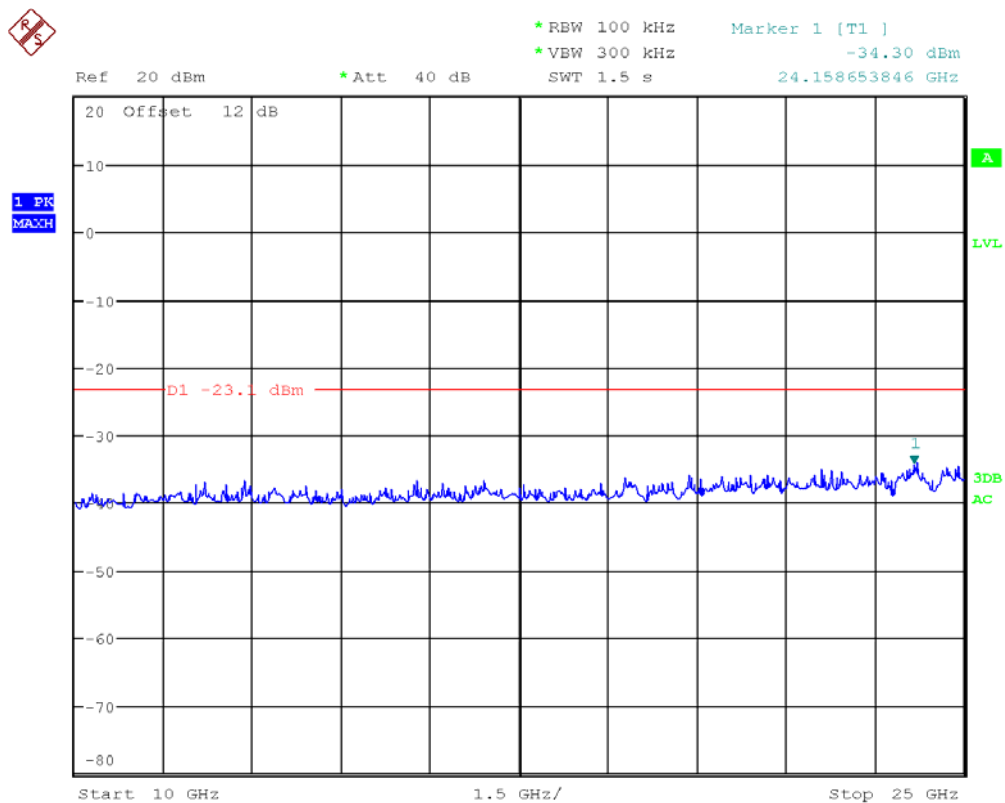

4.10 RADIATED SPURIOUS EMISSIONS

4.10.1 LIMITS

Frequency (MHz)	Quasi-peak(μ V/m)	Measurement distance(m)	Quasi-peak(dB μ V/m)@distance 3m
0.009-0.490	2400/F(kHz)	300	53.8~88.5
0.490-1.705	24000/F(kHz)	30	43~53.8
1.705-30.0	30	30	49.5
30 ~ 88	100	3	40
88~216	150	3	43.5
216 ~ 960	200	3	46
Above 960	500	3	54

NOTE: (1) The lower limit shall apply at the transition frequencies.

Frequency (GHz)	Quasi-peak(dB μ V/m)
1 ~ 26.5	74
1~ 26.5	54

4.10.2 TEST PROCEDURES

Procedure of Preliminary Test

According to ANSI C63.10:2009, a calibrated, linearly polarized antenna shall be positioned at the specified distance from the periphery of the EUT. The specified distance is the distance between the horizontal projection onto the ground plane of the closest periphery of the EUT and the projection onto the ground plane of the center of the axis of the elements of the receiving antenna.

Measurements shall be made with the antenna positioned in both the horizontal and vertical planes of polarization. The measurement antenna shall be varied in height above the reference ground plane to obtain the maximum signal strength. Unless otherwise specified, the measurement distance shall be 3 m. At any measurement distance, the antenna height shall be varied from 1 m to 4 m. These height scans apply for both horizontal and vertical polarizations, except that for vertical polarization, the minimum height of the center of the antenna shall be increased so that the lowest point of the bottom of the lowest antenna element clears the site reference ground plane by at least 25 cm. For a tuned dipole, the minimum heights as measured from the center of the antenna are those specified in the NSA measurement requirements.

For tabletop systems, cables or wires should be manipulated within the range of likely arrangements. For floor-standing equipment, the cables or wires should be located in the same manner as the user would install them and no further manipulation is made. For combination EUTs, the tabletop and floor-standing portions of the EUT shall follow the procedures for their respective setups and cable manipulation.

Table-top equipment is placed on a non-conductive set-up table with height $0,8\text{ m} \pm 0,01\text{ m}$, ANSI C63.10:2009 specifies the method to determine the impact of the non-conductive set-up table on test results. If the manner of cable installation is not known, or if it changes with each installation, cables or wires for floor-standing equipment shall be manipulated to the extent possible to produce the maximum level of emissions. For each mode of operation required to be tested, the frequency spectrum shall be monitored. Variations in antenna height between 1 m and 4 m, antenna polarization, EUT azimuth, and cable or wire placement shall be explored to produce the emission that has the highest amplitude relative to the limit.

Procedure of Final Test

EUT and support equipment were set up on the turntable as per the configuration with highest emission level in the preliminary test. The Analyzer / Receiver scanned from 30MHz to 1000MHz. Emissions were scanned and measured rotating the EUT to 360 degrees, varying cable placement and positioning the antenna 1 to 4 meters above the ground plane, in both the vertical and the horizontal polarization, to maximize the emission reading level. Record at least six highest emissions. Emission frequency, amplitude, antenna position, polarization and turntable position were recorded into a computer in which correction factors were used to calculate the emission level and compare reading to the applicable limit and only QP reading is presented. The test data of the worst-case condition(s) was recorded.

Procedure of Final Test

EUT and support equipment were set up on the test bench as per the configuration with highest emission level in the preliminary test. A scan was taken on both power lines, recording at least the six highest emissions. Emission frequency and amplitude were recorded into a computer in which correction factors were used to calculate the emission level and compare reading to the applicable limit. The test data of the worst-case condition(s) was recorded.

Below 1GHz Set the spectrum analyzer: RBW =100KHz VBW >= RBW , Span = enough to captch the trace. Sweep = auto; Detector Function = Peak. Trace = Max,hold.

Above 1GHz Set the spectrum analyzer: RBW =1MHz VBW >= RBW , Span = enough to captch the trace. Sweep = auto; Detector Function = Peak. Trace = Max,hold.

Pre-test for normal mode and EDR mode, to find the EDR is the worst case.

The worst case emissions were reported.

4.10.3 TEST SETUP

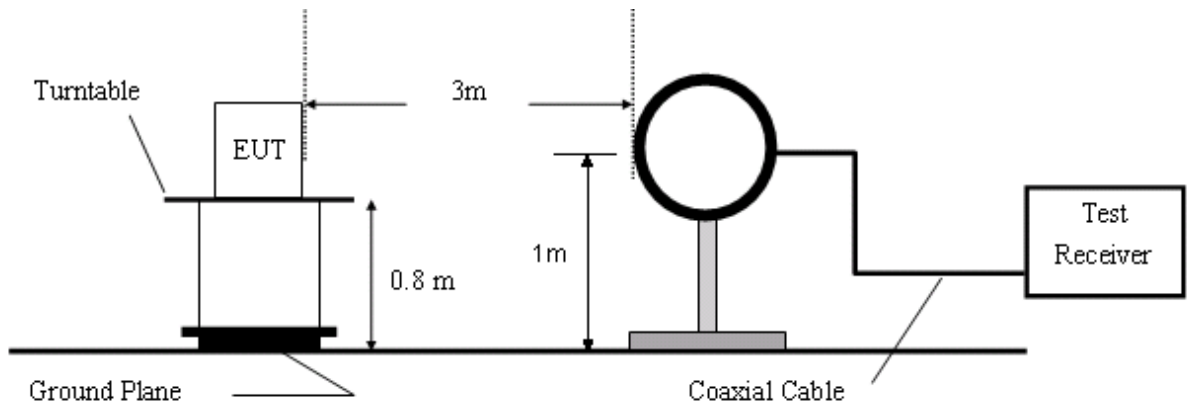

Figure 1. 9 KHz to 30MHz radiated emissions test configuration

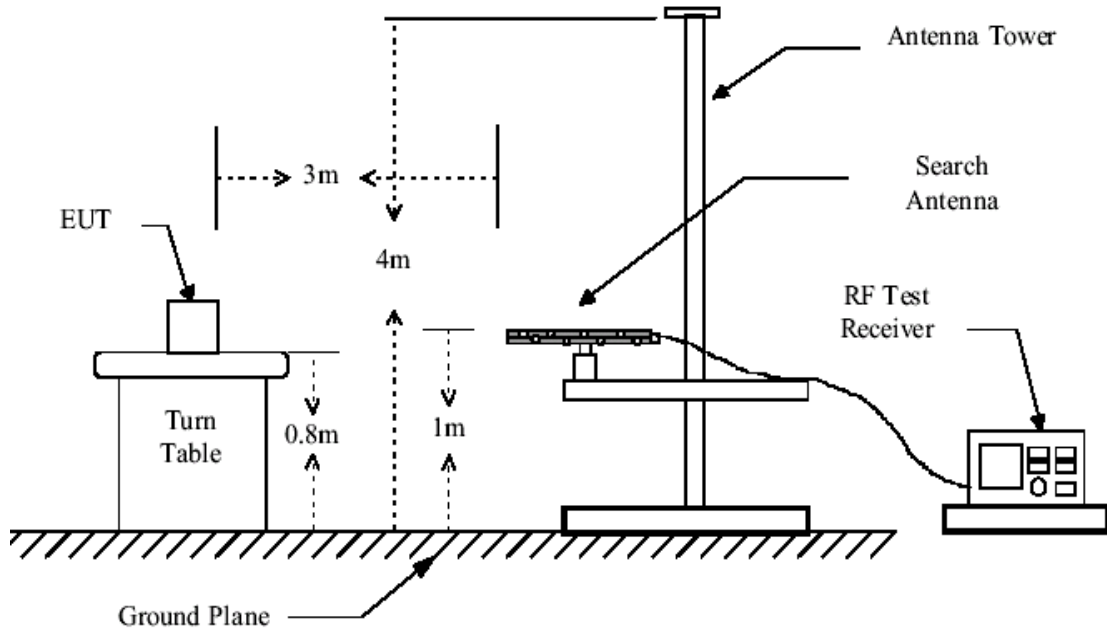

Figure 2. 30MHz to 1GHz radiated emissions test configuration

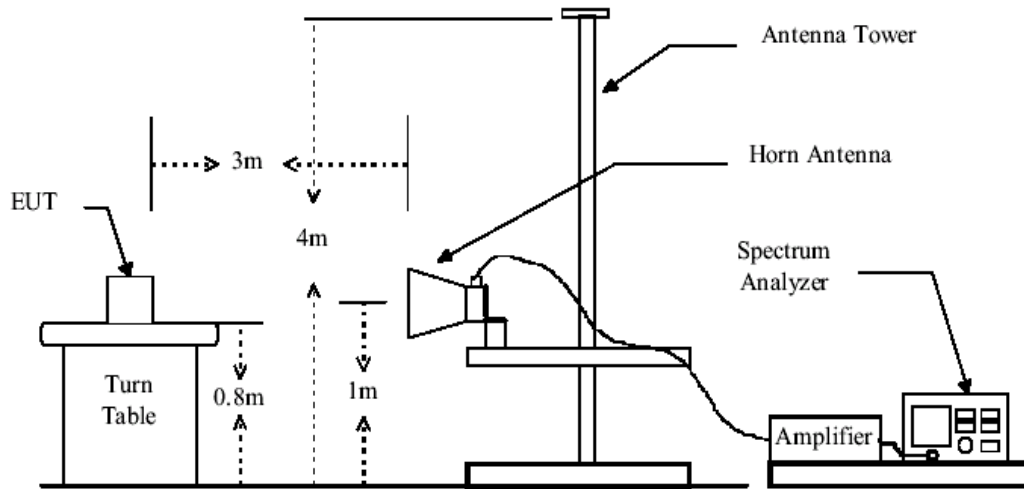

Figure 3. Above 1GHz radiated emissions test configuration

4.10.4 TEST RESULTS

1. Low Frequency 2402MHz

30MHz~1GHz Spurious Emissions .Quasi-Peak Measurement

No.	Frequency (MHz)	Reading (dBuV/m)	Correct Factor(dB/m)	Result (dBuV/m)	Limit (dBuV/m)	Over Limit (dB)	Antenna polarization
1	31.2036	12.02	18.68	30.70	40.00	-9.30	Vertical
2	71.6804	30.71	7.79	38.50	40.00	-1.50	Vertical
3	73.7229	19.62	7.98	27.60	40.00	-12.40	Vertical
4	83.8947	29.92	8.98	38.90	40.00	-1.10	Vertical
5	112.3675	13.86	9.34	23.20	43.50	-20.30	Vertical
6	481.6523	22.63	19.97	42.60	46.00	-3.40	Vertical
7	30.5100	1.78	19.12	20.90	40.00	-19.10	Horizontal
8	83.8947	21.32	8.98	30.30	40.00	-9.70	Horizontal
9	172.2345	25.37	10.63	36.00	43.50	-7.50	Horizontal
10	269.9983	28.35	14.15	42.50	46.00	-3.50	Horizontal
11	319.5776	25.70	16.20	41.90	46.00	-4.10	Horizontal
12	481.6523	16.63	19.97	36.60	46.00	-9.40	Horizontal

1~25 GHz Harmonics & Spurious Emissions. Peak & Average Measurement

Vertical:

No.	Frequency (MHz)	Reading (dBuV/m)	Correct Factor(dB/m)	Result (dBuV/m)	Limit (dBuV/m)	Over Limit (dB)	/
1	1602.941	36.73	12.06	48.79	74.00	-25.21	peak
2	1602.941	21.84	12.06	33.90	54.00	-20.10	AVG
3	1835.663	33.31	14.45	47.76	74.00	-26.24	peak
4	1835.663	14.45	14.45	28.90	54.00	-25.10	AVG
5	2015.198	36.62	16.64	53.26	74.00	-20.74	peak
6	2015.198	16.86	16.64	33.50	54.00	-20.50	AVG
7	12826.912	27.27	26.74	54.01	74.00	-19.99	peak
8	12826.912	14.06	26.74	40.80	54.00	-13.20	AVG
9	16849.641	27.07	30.41	57.48	74.00	-16.52	peak
10	16849.641	12.79	30.41	43.20	54.00	-10.80	AVG
11	18000.000	27.99	32.56	60.55	74.00	-13.45	peak
12	18000.000	12.54	32.56	45.10	54.00	-8.90	AVG

Horizontal

No.	Frequency (MHz)	Reading (dBuV/m)	Correct Factor(dB/m)	Result (dBuV/m)	Limit (dBuV/m)	Over Limit (dB)	Antenna polarization
1	1059.821	34.46	7.63	42.09	74.00	-31.91	peak
2	1059.821	15.07	7.63	22.70	54.00	-31.30	AVG
3	1602.941	34.22	12.06	46.28	74.00	-27.72	peak
4	1602.941	11.64	12.06	23.70	54.00	-30.30	AVG
5	2675.600	27.86	19.95	47.81	74.00	-26.19	peak
6	2675.600	8.75	19.95	28.70	54.00	-25.30	AVG
7	12937.883	27.62	27.20	54.82	74.00	-19.18	peak
8	12937.883	13.50	27.20	40.70	54.00	-13.30	AVG
9	16753.154	28.52	30.20	58.72	74.00	-15.28	peak
10	16753.154	14.30	30.20	44.50	54.00	-9.50	AVG
11	17845.610	28.21	31.74	59.95	74.00	-14.05	peak
12	17845.610	12.06	31.74	43.80	54.00	-10.20	AVG

The field strength is calculated by adding the Antenna Factor. Correct Factor.

The basic equation with a sample calculation is as follows:

Final Test Level =Receiver Reading + Correct Factor

2. Middle Frequency 2441MHz

30MHz~1GHz Spurious Emissions .Quasi-Peak Measurement

No.	Frequency (MHz)	Reading (dBuV/m)	Correct Factor(dB/m)	Result (dBuV/m)	Limit (dBuV/m)	Over Limit (dB)	Antenna polarization
1	30.0000	5.37	19.43	24.80	40.00	-15.20	Vertical
2	31.5563	5.54	18.46	24.00	40.00	-16.00	Vertical
3	34.3316	7.30	16.80	24.10	40.00	-15.90	Vertical
4	88.7442	17.61	9.49	27.10	43.50	-16.40	Vertical
5	92.8248	18.47	9.73	28.20	43.50	-15.30	Vertical
6	103.2841	15.27	9.83	25.10	43.50	-18.40	Vertical
7	32.6384	-1.12	17.82	16.70	40.00	-23.30	Horizontal
8	35.7089	0.46	15.94	16.40	40.00	-23.60	Horizontal
9	122.9389	25.70	8.80	34.50	43.50	-9.00	Horizontal
10	221.7906	24.72	12.58	37.30	46.00	-8.70	Horizontal
11	269.9983	29.55	14.15	43.70	46.00	-2.30	Horizontal
12	319.5776	28.30	16.20	44.50	46.00	-1.50	Horizontal

1~25 GHz Harmonics & Spurious Emissions. Peak & Average Measurement

Vertical:

No.	Frequency (MHz)	Reading (dBuV/m)	Correct Factor(dB/m)	Result (dBuV/m)	Limit (dBuV/m)	Over Limit (dB)	/
1	1625.678	37.45	12.37	49.82	74.00	-24.18	peak
2	1625.678	15.83	12.37	28.20	54.00	-25.80	AVG
3	2018.749	35.30	16.69	51.99	74.00	-22.01	peak
4	2018.749	11.81	16.69	28.50	54.00	-25.50	AVG
5	2689.769	28.04	19.82	47.86	74.00	-26.14	peak
6	2689.769	9.48	19.82	29.30	54.00	-24.70	AVG
7	10165.110	28.24	23.50	51.74	74.00	-22.26	peak
8	10165.110	12.90	23.50	36.40	54.00	-17.60	AVG
9	13200.564	27.15	27.76	54.91	74.00	-19.09	peak
10	13200.564	11.04	27.76	38.80	54.00	-15.20	AVG
11	17743.419	28.29	31.19	59.48	74.00	-14.52	peak
12	17743.419	11.91	31.19	43.10	54.00	-10.90	AVG

Horizontal

No.	Frequency (MHz)	Reading (dBuV/m)	Correct Factor(dB/m)	Result (dBuV/m)	Limit (dBuV/m)	Over Limit (dB)	Antenna polarization
1	1399.722	31.24	9.98	41.22	74.00	-32.78	peak
2	1399.722	14.52	9.98	24.50	54.00	-29.50	AVG
3	1625.678	31.50	12.37	43.87	74.00	-30.13	peak
4	1625.678	13.83	12.37	26.20	54.00	-27.80	AVG
5	2642.827	26.10	20.23	46.33	74.00	-27.67	peak
6	2642.827	9.37	20.23	29.60	54.00	-24.40	AVG
7	12937.883	27.96	27.20	55.16	74.00	-18.84	peak
8	12937.883	13.60	27.20	40.80	54.00	-13.20	AVG
9	16801.328	27.93	30.30	58.23	74.00	-15.77	peak
10	16801.328	12.60	30.30	42.90	54.00	-11.10	AVG
11	17440.346	30.30	30.00	60.30	74.00	-13.70	peak
12	17440.346	13.40	30.00	43.40	54.00	-10.60	AVG

The field strength is calculated by adding the Antenna Factor. Correct Factor.

The basic equation with a sample calculation is as follows:

Final Test Level =Receiver Reading + Correct Factor

3. High Frequency 2480MHz

30MHz~1GHz Spurious Emissions .Quasi-Peak Measurement

No.	Frequency (MHz)	Reading (dBuV/m)	Correct Factor(dB/m)	Result (dBuV/m)	Limit (dBuV/m)	Over Limit (dB)	Antenna polarization
1	30.1691	5.57	19.33	24.90	40.00	-15.10	Vertical
2	35.5088	7.43	16.07	23.50	40.00	-16.50	Vertical
3	92.8248	17.27	9.73	27.00	43.50	-16.50	Vertical
4	105.0401	21.65	9.75	31.40	43.50	-12.10	Vertical
5	269.9983	23.55	14.15	37.70	46.00	-8.30	Vertical
6	481.6523	18.83	19.97	38.80	46.00	-7.20	Vertical
7	31.2036	2.82	18.68	21.50	40.00	-18.50	Horizontal
8	35.9102	3.89	15.81	19.70	40.00	-20.30	Horizontal
9	231.9889	31.71	12.99	44.70	46.00	-1.30	Horizontal
10	269.9983	30.25	14.15	44.40	46.00	-1.60	Horizontal
11	319.5776	27.20	16.20	43.40	46.00	-2.60	Horizontal
12	576.5407	11.02	21.28	32.30	46.00	-13.70	Horizontal

1~25 GHz Harmonics & Spurious Emissions. Peak & Average Measurement

Vertical:

No.	Frequency (MHz)	Reading (dBuV/m)	Correct Factor(dB/m)	Result (dBuV/m)	Limit (dBuV/m)	Over Limit (dB)	/
1	1654.553	32.80	12.75	45.55	74.00	-28.45	peak
2	1654.553	17.35	12.75	30.10	54.00	-23.90	AVG
3	1835.663	33.72	14.45	48.17	74.00	-25.83	peak
4	1835.663	16.35	14.45	30.80	54.00	-23.20	AVG
5	2675.600	28.57	19.95	48.52	74.00	-25.48	peak
6	2675.600	13.55	19.95	33.50	54.00	-20.50	AVG
7	6476.304	28.05	19.69	47.74	74.00	-26.26	peak
8	6476.304	12.81	19.69	32.50	54.00	-21.50	AVG
9	13049.814	27.51	27.52	55.03	74.00	-18.97	peak
10	13049.814	13.28	27.52	40.80	54.00	-13.20	AVG
11	16849.641	28.15	30.41	58.56	74.00	-15.44	peak
12	16849.641	12.69	30.41	43.10	54.00	-10.90	AVG

Horizontal

No.	Frequency (MHz)	Reading (dBuV/m)	Correct Factor(dB/m)	Result (dBuV/m)	Limit (dBuV/m)	Over Limit (dB)	Antenna polarization
1	1052.383	34.49	7.61	42.10	74.00	-31.90	peak
2	1052.383	15.69	7.61	23.30	54.00	-30.70	AVG
3	1654.553	32.80	12.75	45.55	74.00	-28.45	peak
4	1654.553	13.95	12.75	26.70	54.00	-27.30	AVG
5	1835.663	33.72	14.45	48.17	74.00	-25.83	peak
6	1835.663	15.45	14.45	29.90	54.00	-24.10	AVG
7	12900.786	28.09	27.04	55.13	74.00	-18.87	peak
8	12900.786	11.86	27.04	38.90	54.00	-15.10	AVG
9	16946.684	29.18	30.63	59.81	74.00	-14.19	peak
10	16946.684	11.07	30.63	41.70	54.00	-12.30	AVG
11	17845.610	28.72	31.74	60.46	74.00	-13.54	peak
12	17845.610	10.66	31.74	42.40	54.00	-11.60	AVG

Remark:

- 1). No any other emissions level which are attenuated less than 20dB below the limit.
According to 15.31(o), The amplitude of spurious emissions from intentional radiators and emissions from unintentional radiators which are attenuated more than 20 dB below the permissible value need not be reported unless specifically required elsewhere in this Part.
Hence there no other emissions have been reported.
- 2). As shown in Section, for frequencies above 1000 MHz. the above field strength limits are based on average limits. However, the peak field strength of any emission shall not exceed the maximum permitted average limits specified above by more than 20 dB under any condition of modulation.
- 3). The test only perform the EUT in transmitting status since the test frequencies were over 1GHz only required transmitting status.

Test result: The unit does meet the requirements.

4.11 BAND EDGES REQUIREMENT

4.11.1 LIMITS

Section 15.247 (d) In any 100 kHz bandwidth outside the frequency band in which the spread spectrum or digitally modulated intentional radiator is operating, the radio frequency power that is produced by the intentional radiator shall be at least 20 dB below that in the 100 kHz bandwidth within the band that contains the highest level of the desired power, based on either an RF conducted or a radiated measurement, provided the transmitter demonstrates compliance with the peak conducted power limits. If the transmitter complies with the conducted power limits based on the use of RMS averaging over a time interval, as permitted under paragraph (b)(3) of this section, the attenuation required under this paragraph shall be 30 dB instead of 20 dB. Attenuation below the general limits specified in Section 15.209(a) is not required.

4.11.2 TEST PROCEDURES

1. Check the calibration of the measuring instrument using either an internal calibrator or a known signal from an external generator.
2. Position the EUT without connection to measurement instrument. Turn on the EUT and connect its antenna terminal to measurement instrument via a low loss cable. Then set it to any one measured frequency within its operating range, and make sure the instrument is operated in its linear range.
3. Set RBW to 100 kHz and VBW of spectrum analyzer to 300 kHz with a convenient frequency span including 100 kHz bandwidth from band edge.
Note: For Restricted Band
RBW=100 kHz
VBW=300 kHz
4. Measure the highest amplitude appearing on spectral display and set it as a reference level. Plot the graph with marking the highest point and edge frequency.

Repeat above procedures until all measured frequencies were complete.

4.11.3 TEST SETUP

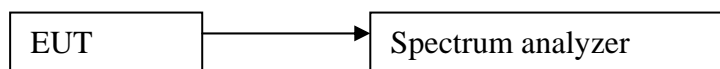

4.11.4 TEST RESULTS

The unit does meet the FCC requirements.

Test result plot as follows:

For GFSK

Lowest Channel

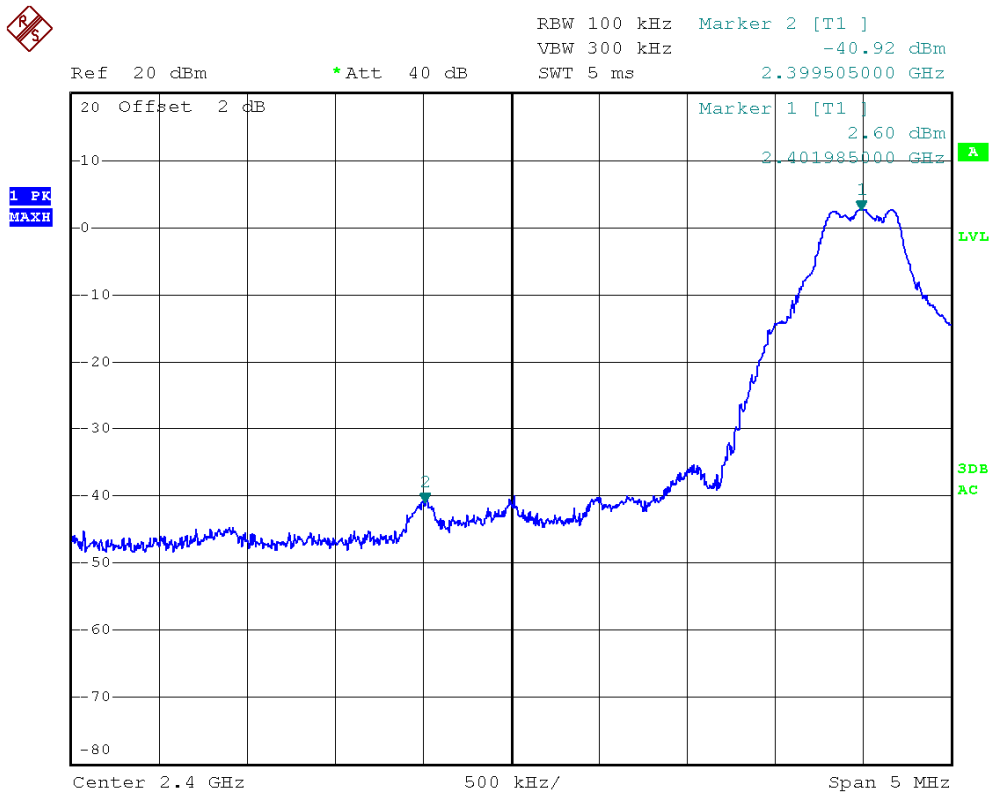

Highest Channel

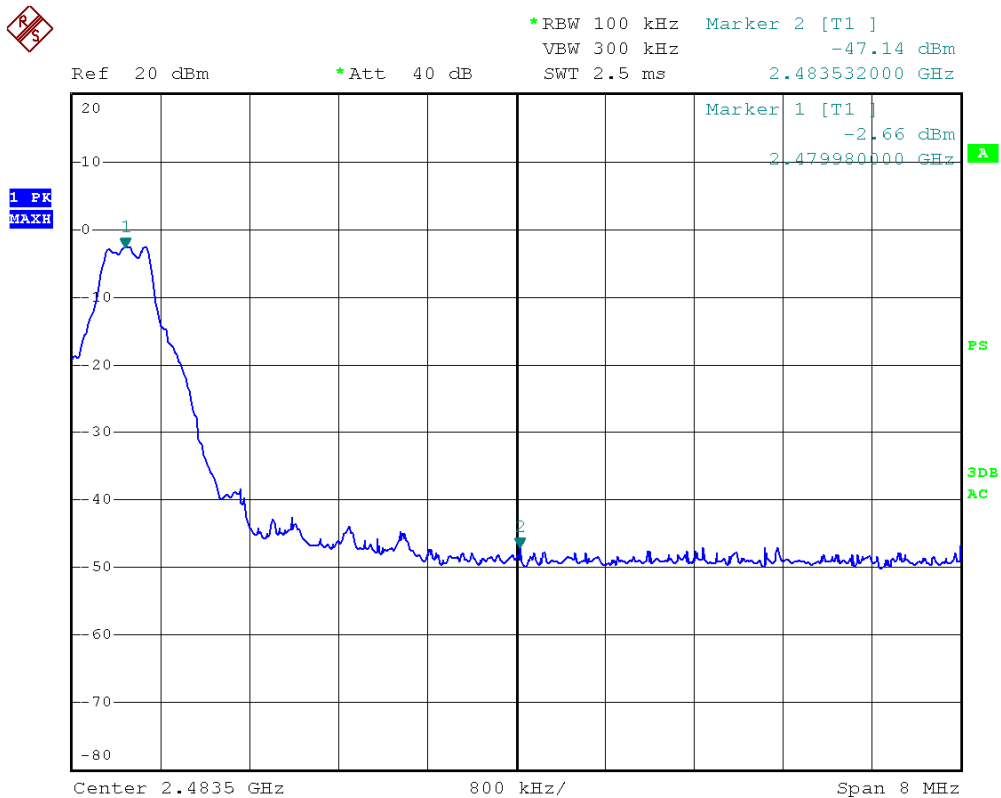

For 8DPSK

Lowest Channel

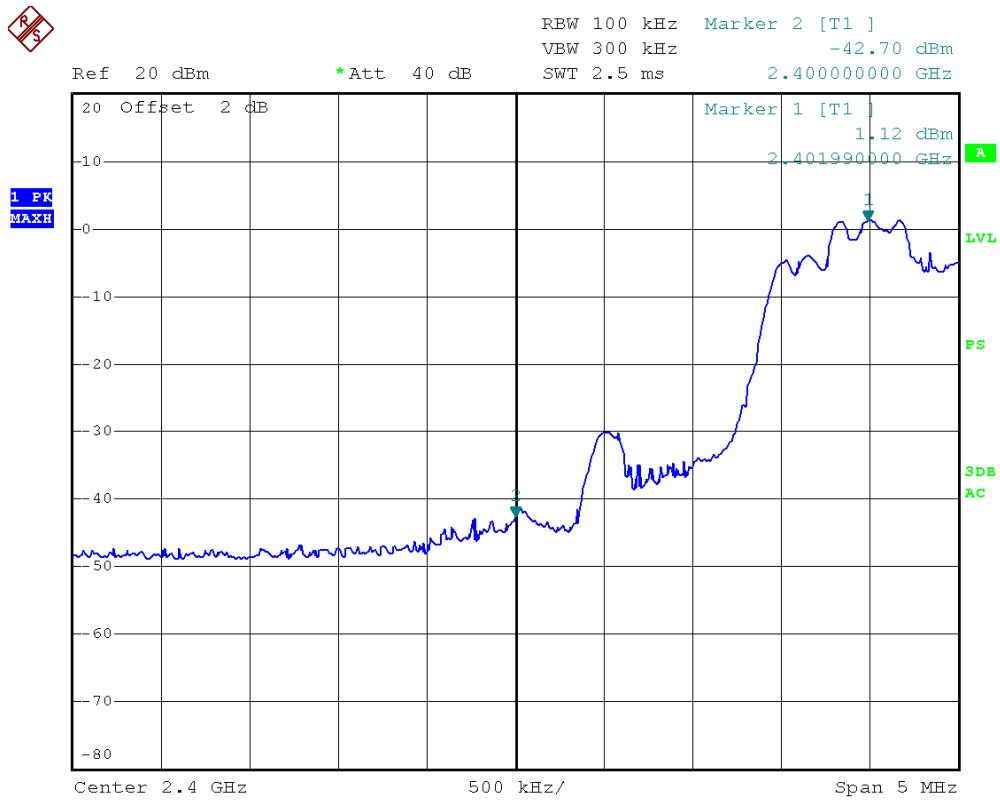

Highest Channel

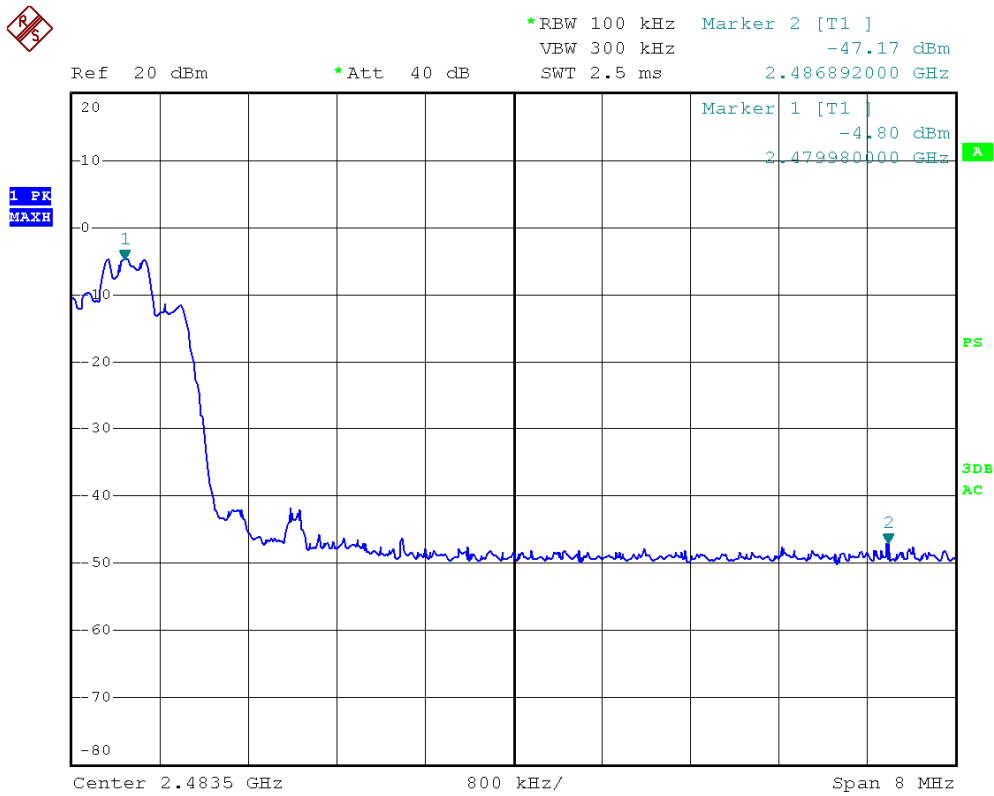

4.11.5 Radiated Emissions which fall in the restricted bands

Section 15.247(d) In addition, radiated emissions which fall in the restricted bands. as defined in Section 15.205(a), must also comply with the radiated emission limits specified in Section 15.209(a) (see Section 15.205(c)).

Test Requirement:

Section 15.205 Restricted bands of operation.

(a) Except as shown in paragraph (d) of this section. only spurious emissions are permitted in any of the frequency bands listed below:

MHz	MHz	MHz	GHz
0.090 - 0.110	16.42 - 16.423	399.9 - 410	4.5 - 5.15
¹ 0.495 - 0.505	16.69475 -	608 - 614	5.35 - 5.46
2.1735 - 2.1905	16.69525	960 - 1240	7.25 - 7.75
4.125 - 4.128	16.80425 -	1300 - 1427	8.025 - 8.5
4.17725 - 4.17775	16.80475	1435 - 1626.5	9.0 - 9.2
4.20725 - 4.20775	25.5 - 25.67	1645.5 - 1646.5	9.3 - 9.5
6.215 - 6.218	37.5 - 38.25	1660 - 1710	10.6 - 12.7
6.26775 - 6.26825	73 - 74.6	1718.8 - 1722.2	13.25 - 13.4
6.31175 - 6.31225	74.8 - 75.2	2200 - 2300	14.47 - 14.5
8.291 - 8.294	108 - 121.94	2310 - 2390	15.35 - 16.2
8.362 - 8.366	123 - 138	2483.5 - 2500	17.7 - 21.4
8.37625 - 8.38675	149.9 - 150.05	2655 - 2900	22.01 - 23.12
8.41425 - 8.41475	156.52475 -	3260 - 3267	23.6 - 24.0
12.29 - 12.293	156.52525	3332 - 3339	31.2 - 31.8
12.51975 -	156.7 - 156.9	3345.8 - 3358	36.43 - 36.5
12.52025	162.0125 - 167.17	3600 - 4400	
12.57675 -	167.72 - 173.2		
12.57725	240 - 285		
13.36 - 13.41	322 - 335.4		

Pretest the Bluetooth normal mode and EDR mode, record normal mode date
 The field strength was measured with an EMI measuring receiver and 1 MHz RBW / VBW for peak and with 1MHz RBW / 10Hz VBW for average at a distance of 3m.

Test Result:

Channel Low

No.	Freq MHz	Reading dBuV	Factor dB	Level dBuV/m	Limit dBuV/m	Over Limit dB	Remark	Pol V/H
1	2390.000	26.00	13.97	39.97	74.00	-34.03	peak	VERTICAL
2	2400.000	27.58	14.24	41.82	74.00	-32.18	peak	VERTICAL
3	2390.000	14.98	13.97	28.95	54.00	-25.05	AVG	VERTICAL
4	2400.000	15.00	14.24	29.24	54.00	-24.76	AVG	VERTICAL
1	2390.000	26.65	13.97	40.62	74.00	-33.38	peak	HORIZONTAL
2	2400.000	28.06	14.24	42.30	74.00	-31.70	peak	HORIZONTAL
3	2390.000	14.95	13.97	28.92	54.00	-25.08	AVG	HORIZONTAL
4	2400.000	16.59	14.24	30.83	54.00	-23.17	AVG	HORIZONTAL

Channel High

No.	Freq MHz	Reading dBuV	Factor dB	Level dBuV/m	Limit dBuV/m	Over Limit dB	Remark	Pol V/H
1	2483.500	26.31	14.04	40.35	74.00	-33.65	peak	VERTICAL
2	2500.000	24.92	13.97	38.89	74.00	-35.11	peak	VERTICAL
3	2483.500	14.89	14.04	28.93	54.00	-25.07	AVG	VERTICAL
4	2500.000	14.87	13.97	28.84	54.00	-25.16	AVG	VERTICAL
1	2483.500	25.13	14.04	39.17	74.00	-34.83	peak	HORIZONTAL
2	2500.000	25.35	13.97	39.32	74.00	-34.68	peak	HORIZONTAL
3	2483.500	14.99	14.04	29.03	54.00	-24.97	AVG	HORIZONTAL
4	2500.000	14.87	13.97	28.84	54.00	-25.16	AVG	HORIZONTAL

Remark: Max field strength in 3m distance. No any other emission which falls in restricted bands can be detected and be reported.

-----**This is the last page of the report.**-----