

TEST REPORT

Application No.: SZCR2408003018AT
Applicant: Harman International Industries, Inc.
Address of Applicant: 8500 Balboa Boulevard, Northridge, California, 91329, United States
Manufacturer: Harman International Industries, Inc.
Address of Manufacturer: 8500 Balboa Boulevard, Northridge, California, 91329, United States
Equipment Under Test (EUT):
EUT Name: Wireless Speaker
Model No.: Authentics 200
Trade Mark: JBL
FCC ID: APIAUTH200A
Standard(s) : 47 CFR Part 15, Subpart E 15.407
Date of Receipt: 2024-08-05
Date of Test: 2024-08-17 to 2024-09-07
Date of Issue: 2024-10-21

Test Result:	Pass*
---------------------	--------------

* In the configuration tested, the EUT complied with the standards specified above.



Keny Xu
EMC Laboratory Manager



Revision Record				
Version	Chapter	Date	Modifier	Remark
01		2024-10-21		Original

Authorized for issue by:			
		<i>Benson Wang</i>	
		Benson Wang/Project Engineer	
		<i>Eric Fu</i>	
		Eric Fu/Reviewer	



Unless otherwise agreed in writing, this document is issued by the Company subject to its General Conditions of Service printed overleaf, available on request or accessible at <https://www.sgs.com/en/Terms-and-Conditions>. Attention is drawn to the limitation of liability, indemnification and jurisdiction issues defined therein. Any holder of this document is advised that information contained hereon reflects the Company's findings at the time of its intervention only and within the limits of Client's instructions, if any. The Company's sole responsibility is to its Client and this document does not exonerate parties to a transaction from exercising all their rights and obligations under the transaction documents. This document cannot be reproduced except in full, without prior written approval of the Company. Any unauthorized alteration, forgery or falsification of the content or appearance of this document is unlawful and offenders may be prosecuted to the fullest extent of the law. Unless otherwise stated the results shown in this test report refer only to the sample(s) tested and such sample(s) are retained for 30 days only.

Attention: To check the authenticity of testing /inspection report & certificate, please contact us at telephone: (86-755) 8307 1443, or email: CN.Doccheck@sgs.com

2 Test Summary

Radio Spectrum Technical Requirement				
Item	Standard	Method	Requirement	Result
Antenna Requirement	47 CFR Part 15, Subpart E 15.407	N/A	47 CFR Part 15, Subpart C 15.203	Pass
Transmission in the Absence of Data		N/A	47 CFR Part 15, Subpart E 15.407 (c)	Pass

Radio Spectrum Matter Part				
Item	Standard	Method	Requirement	Result
Conducted Emissions at AC Power Line (150kHz-30MHz)	47 CFR Part 15, Subpart E 15.407	ANSI C63.10 (2013) Section 6.2	47 CFR Part 15, Subpart C 15.207 & Subpart E 15.407 b(9)	Pass
Maximum Conducted output power		KDB 789033 D02 II E	47 CFR Part 15, Subpart E 15.407 (a)	Pass
Radiated Emissions (Below 1GHz)		KDB 789033 D02 II G	47 CFR Part 15, Subpart C 15.209 & Subpart E 15.407(b)	Pass
Radiated Emissions (Above 1GHz)		KDB 789033 D02 II G	47 CFR Part 15, Subpart C 15.209 & Subpart E 15.407(b)	Pass
Radiated Emissions which fall in the restricted bands		KDB 789033 D02 II G	47 CFR Part 15, Subpart C 15.209 & Subpart E 15.407(b)	Pass
Channel Move Time		KDB 905462 D02 Section 7.8.3	KDB 905462 D02 Section 5.1	Pass
Duty Cycle		KDB 789033 II B 1	KDB 789033 D02 II B 1	Pass
99% Bandwidth		KDB 789033 II D	N/A	Pass
26dB Emission bandwidth		KDB 789033 D02 II C 1	47 CFR Part 15, Subpart E 15.407 (a)	Pass
Minimum 6 dB bandwidth (5.725-5.85 GHz band)		KDB 789033 D02 II C 2	47 CFR Part 15, Subpart E 15.407 (e)	Pass
Peak Power spectrum density		KDB 789033 D02 II F	47 CFR Part 15, Subpart E 15.407 (a)	Pass
Frequency Stability		ANSI C63.10 (2013) Section 6.8	47 CFR Part 15, Subpart E 15.407 (g)	Pass
Channel Closing Transmission Time		KDB 905462 D02 Section 7.8.3	KDB 905462 D02 Section 5.1	Pass



Unless otherwise agreed in writing, this document is issued by the Company subject to its General Conditions of Service printed overleaf, available on request or accessible at <https://www.sgs.com/en/Terms-and-Conditions>. Attention is drawn to the limitation of liability, indemnification and jurisdiction issues defined therein. Any holder of this document is advised that information contained hereon reflects the Company's findings at the time of its intervention only and within the limits of Client's instructions, if any. The Company's sole responsibility is to its Client and this document does not exonerate parties to a transaction from exercising all their rights and obligations under the transaction documents. This document cannot be reproduced except in full, without prior written approval of the Company. Any unauthorized alteration, forgery or falsification of the content or appearance of this document is unlawful and offenders may be prosecuted to the fullest extent of the law. Unless otherwise stated the results shown in this test report refer only to the sample(s) tested and such sample(s) are retained for 30 days only.

Attention: To check the authenticity of testing /inspection report & certificate, please contact us at telephone: (86-755) 8307 1443, or email: CN.Doccheck@sgs.com

3 Contents

	Page
1 Cover Page	1
2 Test Summary	3
3 Contents	4
4 General Information	7
4.1 Details of E.U.T.	7
4.2 Description of Support Units	7
4.3 Measurement Uncertainty	8
4.4 Test Location	9
4.5 Test Facility	9
4.6 Deviation from Standards	9
4.7 Abnormalities from Standard Conditions	9
5 Equipment List	10
6 Radio Spectrum Technical Requirement	13
6.1 Antenna Requirement	13
6.1.1 Test Requirement:	13
6.1.2 Conclusion	13
6.2 Transmission in the Absence of Data	14
6.2.1 Test Requirement:	14
6.2.2 Conclusion	14
7 Radio Spectrum Matter Test Results	15
7.1 Conducted Emissions at AC Power Line (150kHz-30MHz)	15
7.1.1 E.U.T. Operation	15
7.1.2 Test Mode Description	15
7.1.3 Test Setup Diagram	16
7.1.4 Measurement Procedure and Data	17
7.2 Maximum Conducted output power	20
7.2.1 E.U.T. Operation	20
7.2.2 Test Mode Description	20
7.2.3 Test Setup Diagram	22
7.2.4 Measurement Procedure and Data	22
7.3 Radiated Emissions (Below 1GHz)	23
7.3.1 E.U.T. Operation	23
7.3.2 Test Mode Description	23
7.3.3 Test Setup Diagram	24
7.3.4 Measurement Procedure and Data	25
7.4 Radiated Emissions (Above 1GHz)	28
7.4.1 E.U.T. Operation	28
7.4.2 Test Mode Description	29
7.4.3 Test Setup Diagram	30



Unless otherwise agreed in writing, this document is issued by the Company subject to its General Conditions of Service printed overleaf, available on request or accessible at <https://www.sgs.com/en/Terms-and-Conditions>. Attention is drawn to the limitation of liability, indemnification and jurisdiction issues defined therein. Any holder of this document is advised that information contained hereon reflects the Company's findings at the time of its intervention only and within the limits of Client's instructions, if any. The Company's sole responsibility is to its Client and this document does not exonerate parties to a transaction from exercising all their rights and obligations under the transaction documents. This document cannot be reproduced except in full, without prior written approval of the Company. Any unauthorized alteration, forgery or falsification of the content or appearance of this document is unlawful and offenders may be prosecuted to the fullest extent of the law. Unless otherwise stated the results shown in this test report refer only to the sample(s) tested and such sample(s) are retained for 30 days only.

Attention: To check the authenticity of testing /inspection report & certificate, please contact us at telephone: (86-755) 8307 1443, or email: CN.Doccheck@sgs.com

SGS-CSTC Standards Technical Services Co., Ltd. Shenzhen Branch
 No.1 Workshop, M-10, Middle Section, Science & Technology Park, Nanshan District, Shenzhen, Guangdong, China 518057 t (86-755) 26012053 f (86-755) 26710594 www.sgs.com.cn
 中国·广东·深圳市南山区科技园中区M-10栋1号厂房 邮编: 518057 t (86-755) 26012053 f (86-755) 26710594 sgs.china@sgs.com

- 7.4.4 Measurement Procedure and Data.....31
- 7.5 Radiated Emissions which fall in the restricted bands 150
 - 7.5.1 E.U.T. Operation 151
 - 7.5.2 Test Mode Description 151
 - 7.5.3 Test Setup Diagram 152
 - 7.5.4 Measurement Procedure and Data..... 153
- 7.6 Channel Move Time 300
 - 7.6.1 E.U.T. Operation 300
 - 7.6.2 Test Mode Description 301
 - 7.6.3 Test Setup Diagram 301
 - 7.6.4 Measurement Procedure and Data..... 302
- 7.7 Duty Cycle 303
 - 7.7.1 E.U.T. Operation 303
 - 7.7.2 Test Mode Description 303
 - 7.7.3 Test Setup Diagram 304
 - 7.7.4 Measurement Procedure and Data..... 304
- 7.8 99% Bandwidth 305
 - 7.8.1 E.U.T. Operation 305
 - 7.8.2 Test Mode Description 305
 - 7.8.3 Test Setup Diagram 306
 - 7.8.4 Measurement Procedure and Data..... 306
- 7.9 26dB Emission bandwidth 307
 - 7.9.1 E.U.T. Operation 307
 - 7.9.2 Test Mode Description 307
 - 7.9.3 Test Setup Diagram 308
 - 7.9.4 Measurement Procedure and Data..... 308
- 7.10 Minimum 6 dB bandwidth (5.725-5.85 GHz band) 309
 - 7.10.1 E.U.T. Operation..... 309
 - 7.10.2 Test Mode Description..... 309
 - 7.10.3 Test Setup Diagram..... 310
 - 7.10.4 Measurement Procedure and Data 310
- 7.11 Peak Power spectrum density..... 311
 - 7.11.1 E.U.T. Operation..... 311
 - 7.11.2 Test Mode Description..... 311
 - 7.11.3 Test Setup Diagram..... 312
 - 7.11.4 Measurement Procedure and Data 312
- 7.12 Frequency Stability 313
 - 7.12.1 E.U.T. Operation..... 313
 - 7.12.2 Test Mode Description..... 313
 - 7.12.3 Test Setup Diagram..... 314
 - 7.12.4 Measurement Procedure and Data 314
- 7.13 Channel Closing Transmission Time 315
 - 7.13.1 E.U.T. Operation..... 315
 - 7.13.2 Test Mode Description..... 316
 - 7.13.3 Test Setup Diagram..... 316
 - 7.13.4 Measurement Procedure and Data 317
- 8 Test Setup Photo 318**
- 9 EUT Constructional Details (EUT Photos) 318**



Unless otherwise agreed in writing, this document is issued by the Company subject to its General Conditions of Service printed overleaf, available on request or accessible at <https://www.sgs.com/en/Terms-and-Conditions>. Attention is drawn to the limitation of liability, indemnification and jurisdiction issues defined therein. Any holder of this document is advised that information contained hereon reflects the Company's findings at the time of its intervention only and within the limits of Client's instructions, if any. The Company's sole responsibility is to its Client and this document does not exonerate parties to a transaction from exercising all their rights and obligations under the transaction documents. This document cannot be reproduced except in full, without prior written approval of the Company. Any unauthorized alteration, forgery or falsification of the content or appearance of this document is unlawful and offenders may be prosecuted to the fullest extent of the law. Unless otherwise stated the results shown in this test report refer only to the sample(s) tested and such sample(s) are retained for 30 days only.

Attention: To check the authenticity of testing /inspection report & certificate, please contact us at telephone: (86-755) 8307 1443, or email: CN.Doccheck@sgs.com

No.1 Workshop, M-10, Middle Section, Science & Technology Park, Nanshan District, Shenzhen, Guangdong, China 518057 t (86-755) 26012053 f (86-755) 26710594 www.sgs.com.cn
 中国·广东·深圳市南山区科技园中区M-10栋1号厂房 邮编: 518057 t (86-755) 26012053 f (86-755) 26710594 sgs.china@sgs.com



SGS-CSTC Standards Technical Services Co., Ltd. Shenzhen Branch

SZEMC-TRF-01 Rev. A/1

Report No.: SZCR240800301805

Page: 6 of 663

10 Appendix.....319



Unless otherwise agreed in writing, this document is issued by the Company subject to its General Conditions of Service printed overleaf, available on request or accessible at <https://www.sgs.com/en/Terms-and-Conditions>. Attention is drawn to the limitation of liability, indemnification and jurisdiction issues defined therein. Any holder of this document is advised that information contained hereon reflects the Company's findings at the time of its intervention only and within the limits of Client's instructions, if any. The Company's sole responsibility is to its Client and this document does not exonerate parties to a transaction from exercising all their rights and obligations under the transaction documents. This document cannot be reproduced except in full, without prior written approval of the Company. Any unauthorized alteration, forgery or falsification of the content or appearance of this document is unlawful and offenders may be prosecuted to the fullest extent of the law. Unless otherwise stated the results shown in this test report refer only to the sample(s) tested and such sample(s) are retained for 30 days only.

Attention: To check the authenticity of testing /inspection report & certificate, please contact us at telephone: (86-755) 8307 1443, or email: CN.Doccheck@sgs.com

SGS-CSTC Standards Technical Services Co., Ltd.
Shenzhen Branch (CMAA) Laboratory

No.1 Workshop, M-10, Middle Section, Science & Technology Park, Nanshan District, Shenzhen, Guangdong, China 518057 t (86-755) 26012053 f (86-755) 26710594 www.sgsgroup.com.cn
中国·广东·深圳市南山区科技园中区M-10栋1号厂房 邮编: 518057 t (86-755) 26012053 f (86-755) 26710594 sgs.china@sgs.com

4 General Information

4.1 Details of E.U.T.

Power supply:	AC 100-240V 50/60Hz
Cable(s):	AC cable 200cm unshielded without ferrite core
Cable Loss (for RF conducted test):	0.5dB
Operation Frequency/Number of channels (20MHz):	U-NII-1: 5180-5240MHz (4 Channels); U-NII-2A: 5260-5320MHz (4 Channels); U-NII-2C: 5500-5700MHz (11 Channels); U-NII-3: 5745-5825MHz (5 Channels)
Operation Frequency/Number of channels/(40MHz):	U-NII-1: 5190-5230MHz (2 Channels); U-NII-2A: 5270-5310MHz (2 Channels); U-NII-2C: 5510-5670MHz (5 Channels); U-NII-3: 5755-5795MHz (2 Channels)
Operation Frequency/Number of channels (80MHz):	U-NII-1: 5210MHz (1 Channel); U-NII-2A: 5290MHz (1 Channels); U-NII-2C: 5530-5610MHz (2 Channels); U-NII-3: 5775MHz (1 Channel)
Modulation Type:	802.11a: OFDM (64QAM, 16QAM, QPSK, BPSK); 802.11n: OFDM (BPSK, QPSK, 16QAM, 64QAM); 802.11ac: OFDM (BPSK, QPSK, 16QAM, 64QAM, 256QAM); 802.11ax: OFDMA (BPSK, QPSK, 16QAM, 64QAM, 256QAM, 1024QAM)
Channel Spacing:	802.11a/n(HT20)/ac(VHT20)/ax(HEW20): 20MHz; 802.11n(HT40)/ac(VHT40)/ax(HEW40): 40MHz; 802.11ac(VHT80)/ax(HEW80): 80MHz;
DFS Function:	Slave without Radar detection
TPC Function:	Support TPC function
Antenna Type:	FPC Antenna
Antenna Gain:	Antenna 1: 3.23dBi; Antenna 2: 5.73dBi; Directional gain: 7.58dBi

Remark: The information in this section is provided by the applicant or manufacturer, SGS is not liable to the accuracy, suitability, reliability or/and integrity of the information.

4.2 Description of Support Units

Description	Manufacturer	Model No.	Serial No.
--	--	--	--
The EUT has been tested as an independent unit.			



4.3 Measurement Uncertainty

Test Item	Measurement Uncertainty
Conducted Emissions at AC Power Line (150kHz-30MHz)	± 3.1dB
Maximum Conducted output power	± 0.75dB
Radiated Emissions (Below 1GHz)	± 6.0dB for 3m; ± 5.0dB for 10m
Radiated Emissions (Above 1GHz)	± 4.6dB (1-18GHz); ± 4.8dB (18-40GHz)
Radiated Emissions which fall in the restricted bands	± 6.0dB (below 1GHz); ± 4.6dB (above 1GHz);
Duty Cycle	± 0.37%
99% Bandwidth	± 3%
26dB Emission bandwidth	± 3%
Minimum 6 dB bandwidth (5.725-5.85 GHz band)	± 3%
Peak Power spectrum density	± 2.84dB
Frequency Stability	± 7.25 x 10 ⁻⁸

Remark:

The U_{lab} (lab Uncertainty) is less than U_{CISPR/ETSI} (CISPR/ETSI Uncertainty), so the test results

- compliance is deemed to occur if no measured disturbance level exceeds the disturbance limit;
- non-compliance is deemed to occur if any measured disturbance level exceeds the disturbance limit.



Unless otherwise agreed in writing, this document is issued by the Company subject to its General Conditions of Service printed overleaf, available on request or accessible at <https://www.sgs.com/en/Terms-and-Conditions>. Attention is drawn to the limitation of liability, indemnification and jurisdiction issues defined therein. Any holder of this document is advised that information contained hereon reflects the Company's findings at the time of its intervention only and within the limits of Client's instructions, if any. The Company's sole responsibility is to its Client and this document does not exonerate parties to a transaction from exercising all their rights and obligations under the transaction documents. This document cannot be reproduced except in full, without prior written approval of the Company. Any unauthorized alteration, forgery or falsification of the content or appearance of this document is unlawful and offenders may be prosecuted to the fullest extent of the law. Unless otherwise stated the results shown in this test report refer only to the sample(s) tested and such sample(s) are retained for 30 days only.

Attention: To check the authenticity of testing /inspection report & certificate, please contact us at telephone: (86-755) 8307 1443, or email: CN.Doccheck@sgs.com

4.4 Test Location

All tests were performed at:

SGS-CSTC Standards Technical Services Co., Ltd., Shenzhen Branch

No. 1 Workshop, M-10, Middle Section, Science & Technology Park, Nanshan District, Shenzhen, Guangdong, China. 518057.

Tel: +86 755 2601 2053 Fax: +86 755 2671 0594

No tests were sub-contracted.

4.5 Test Facility

The test facility is recognized, certified, or accredited by the following organizations:

• A2LA (Certificate No. 3816.01)

SGS-CSTC Standards Technical Services Co., Ltd., Shenzhen EMC Laboratory is accredited by the American Association for Laboratory Accreditation(A2LA). Certificate No. 3816.01.

• VCCI (Member No. 1937)

The 3m Fully-anechoic chamber for above 1GHz, 10m Semi-anechoic chamber for below 1GHz, Shielded Room for Mains Port Conducted Interference Measurement and Telecommunication Port Conducted Interference Measurement of SGS-CSTC Standards Technical Services Co., Ltd. Shenzhen EMC laboratory have been registered in accordance with the Regulations for Voluntary Control Measures with Registration No.: G-20026, R-14188, C-12383 and T-11153 respectively.

• FCC –Designation Number: CN1336

SGS-CSTC Standards Technical Services Co., Ltd., Shenzhen EMC Laboratory has been recognized as an accredited testing laboratory.

Designation Number: CN1336. Test Firm Registration Number: 787754.

• Innovation, Science and Economic Development Canada

SGS-CSTC Standards Technical Services Co., Ltd., Shenzhen EMC Laboratory has been recognized by ISED as an accredited testing laboratory.

CAB identifier: CN0006.

IC#: 4620C.

4.6 Deviation from Standards

None

4.7 Abnormalities from Standard Conditions

None



Unless otherwise agreed in writing, this document is issued by the Company subject to its General Conditions of Service printed overleaf, available on request or accessible at <https://www.sgs.com/en/Terms-and-Conditions>. Attention is drawn to the limitation of liability, indemnification and jurisdiction issues defined therein. Any holder of this document is advised that information contained hereon reflects the Company's findings at the time of its intervention only and within the limits of Client's instructions, if any. The Company's sole responsibility is to its Client and this document does not exonerate parties to a transaction from exercising all their rights and obligations under the transaction documents. This document cannot be reproduced except in full, without prior written approval of the Company. Any unauthorized alteration, forgery or falsification of the content or appearance of this document is unlawful and offenders may be prosecuted to the fullest extent of the law. Unless otherwise stated the results shown in this test report refer only to the sample(s) tested and such sample(s) are retained for 30 days only.

Attention: To check the authenticity of testing /inspection report & certificate, please contact us at telephone: (86-755) 8307 1443, or email: CN.Doccheck@sgs.com

5 Equipment List

Conducted Emissions at AC Power Line (150kHz-30MHz)					
Equipment	Manufacturer	Model No.	Inventory No.	Cal Date	Cal Due Date
Shielding Room	ZhongYu Electron	GB-88	SEM001-06	2022-05-14	2025-05-13
EMI Test Receiver	Rohde&Schwarz	ESCI	SEM004-02	2024-03-14	2025-03-13
Matching Pad	N/A	N/A	SEM021-23	2024-03-20	2025-03-19
Matching Pad	N/A	N/A	SEM021-24	2024-03-20	2025-03-19
Measurement Software	AUDIX	e3 V8.2014-6-27a	N/A	N/A	N/A
Coaxial Cable	SGS	N/A	SEM024-01	2024-07-06	2025-07-05
LISN	Rohde&Schwarz	ENV216	SEM007-01	2024-08-15	2025-08-14
LISN	ETS-LINDGREN	3816/2	SEM007-02	2024-03-14	2025-03-13

Maximum Conducted output power					
Equipment	Manufacturer	Model No.	Inventory No.	Cal Date	Cal Due Date
Power Sensor	TST PASS	TSPS2023R	SEM009-26	2024-03-27	2025-03-26
Power Sensor	KEYSIGHT	U2021XA	SEM009-16	2024-03-14	2025-03-13
DC Power Supply	Chroma	62012P-80-60	SEM011-11	2024-08-14	2025-08-13
MXA Signal Analyzer	KEYSIGHT	N9020A	SEM004-19	2024-03-14	2025-03-13
Signal Generator	KEYSIGHT	N5173B	SEM006-05	2024-09-14	2025-09-13
Measurement Software	TST PASS	TST PASS V2.0	N/A	N/A	N/A
Coaxial Cable	SGS	N/A	SEM031-01	2024-07-06	2025-07-05
Attenuator	Huber+Suhner	6620_SMA-50-1	SEM021-09	2024-03-27	2025-03-26
Programmable Temperature & Humidity Chamber	Votsch Industrietechnik GmbH	VT 4002	SEM002-15	2024-03-19	2025-03-18



Unless otherwise agreed in writing, this document is issued by the Company subject to its General Conditions of Service printed overleaf, available on request or accessible at <https://www.sgs.com/en/Terms-and-Conditions>. Attention is drawn to the limitation of liability, indemnification and jurisdiction issues defined therein. Any holder of this document is advised that information contained hereon reflects the Company's findings at the time of its intervention only and within the limits of Client's instructions, if any. The Company's sole responsibility is to its Client and this document does not exonerate parties to a transaction from exercising all their rights and obligations under the transaction documents. This document cannot be reproduced except in full, without prior written approval of the Company. Any unauthorized alteration, forgery or falsification of the content or appearance of this document is unlawful and offenders may be prosecuted to the fullest extent of the law. Unless otherwise stated the results shown in this test report refer only to the sample(s) tested and such sample(s) are retained for 30 days only.

Attention: To check the authenticity of testing /inspection report & certificate, please contact us at telephone: (86-755) 8307 1443, or email: CN.Doccheck@sgs.com

SGS-CSTC Standards Technical Services Co., Ltd. Shenzhen Branch

SZEMC-TRF-01 Rev. A/1

Report No.: SZCR240800301805

Page: 11 of 663

Radiated Emissions (Below 1GHz)					
Equipment	Manufacturer	Model No.	Inventory No.	Cal Date	Cal Due Date
10m Semi-Anechoic Chamber	SAEMC	FSAC1018	SEM001-03	2024-03-26	2025-03-25
MXE EMI receiver	KEYSIGHT	N9038A	SEM004-16	2024-08-14	2025-08-13
Trilog-Broadband Antenna	Schwarzbeck	VULB9168	SEM003-18	2023-09-23	2025-09-22
Pre-amplifier	Sonoma Instrument Co	310N	SEM005-04	2024-03-27	2025-03-26
Loop Antenna	ETS-Lindgren	6502	SEM003-08	2023-11-20	2025-11-19
Measurement Software	AUDIX	e3 V8.2014-6-27	N/A	N/A	N/A
Coaxial Cable	SGS	N/A	SEM029-01	2024-07-06	2025-07-05

Radiated Emissions (Above 1GHz)					
Equipment	Manufacturer	Model No.	Inventory No.	Cal Date	Cal Due Date
3m Fully-Anechoic Chamber	AUDIX	N/A	SEM001-02	2024-05-11	2027-05-10
Signal Analyzer	Rohde & Schwarz	FSV40	SEM008-04	2024-03-15	2025-03-14
Horn Antenna	Rohde&Schwarz	HF907	SEM003-07	2023-07-23	2025-07-22
Microwave system amplifier	Agilent	83017A	SEM005-25	2024-09-14	2025-09-13
Measurement Software	AUDIX	e3 V8.2014-6-27	N/A	N/A	N/A
Coaxial Cable	SGS	N/A	SEM026-01	2024-07-06	2025-07-05
Broad-Band Horn Antenna	Schwarzbeck	BBHA 9170	SEM003-15	2024-08-10	2025-08-09
Pre-Amplifier	Compliance Directions Systems Inc.	PAP-2640-50	SEM005-08	2024-03-15	2025-03-14



Unless otherwise agreed in writing, this document is issued by the Company subject to its General Conditions of Service printed overleaf, available on request or accessible at <https://www.sgs.com/en/Terms-and-Conditions>. Attention is drawn to the limitation of liability, indemnification and jurisdiction issues defined therein. Any holder of this document is advised that information contained hereon reflects the Company's findings at the time of its intervention only and within the limits of Client's instructions, if any. The Company's sole responsibility is to its Client and this document does not exonerate parties to a transaction from exercising all their rights and obligations under the transaction documents. This document cannot be reproduced except in full, without prior written approval of the Company. Any unauthorized alteration, forgery or falsification of the content or appearance of this document is unlawful and offenders may be prosecuted to the fullest extent of the law. Unless otherwise stated the results shown in this test report refer only to the sample(s) tested and such sample(s) are retained for 30 days only.

Attention: To check the authenticity of testing /inspection report & certificate, please contact us at telephone: (86-755) 8307 1443, or email: CN.Doccheck@sgs.com

SGS-CSTC Standards Technical Services Co., Ltd. Shenzhen Branch

SZEMC-TRF-01 Rev. A/1

Report No.: SZCR240800301805

Page: 12 of 663

DFS Test					
Equipment	Manufacturer	Model No.	Inventory No.	Cal Date	Cal Due Date
Manual Step Attenuator	KEYSIGHT	8494B	SEM021-05	2024-03-27	2025-03-26
Manual Step Attenuator	KEYSIGHT	8496B	SEM021-06	2024-03-27	2025-03-26
Measurement Software	KEYSIGHT	Signal Studio for DFS Radar Profiles V2.2.0.0	N/A	N/A	N/A
Measurement Software	Agilent	ISMonitor10	N/A	N/A	N/A
MXG Vector Signal Generator	Agilent	N5182A	SEM006-21	2024-03-27	2025-03-26
MXA Signal Analyzer	KEYSIGHT	N9020A	SEM004-22	2024-03-14	2025-03-13

RF Conducted Test					
Equipment	Manufacturer	Model No.	Inventory No.	Cal Date	Cal Due Date
DC Power Supply	Chroma	62012P-80-60	SEM011-11	2024-08-14	2025-08-13
MXA Signal Analyzer	KEYSIGHT	N9020A	SEM004-19	2024-03-14	2025-03-13
Signal Generator	KEYSIGHT	N5173B	SEM006-05	2024-09-14	2025-09-13
Measurement Software	TST PASS	TST PASS V2.0	N/A	N/A	N/A
Coaxial Cable	SGS	N/A	SEM031-01	2024-07-06	2025-07-05
Attenuator	Huber+Suhner	6620_SMA-50-1	SEM021-09	2024-03-27	2025-03-26
Programmable Temperature & Humidity Chamber	Votsch Industrietechnik GmbH	VT 4002	SEM002-15	2024-03-19	2025-03-18

General used equipment					
Equipment	Manufacturer	Model No.	Inventory No.	Cal Date	Cal Due Date
Humidity/ Temperature Indicator	deli	8838	SEM002-32	2024-07-24	2025-07-23
Humidity/ Temperature Indicator	deli	8838	SEM002-33	2024-07-24	2025-07-23
Barometer	Changchun Meteorological Industry Factory	DYM3	SEM002-01	2024-03-18	2025-03-17



Unless otherwise agreed in writing, this document is issued by the Company subject to its General Conditions of Service printed overleaf, available on request or accessible at <https://www.sgs.com/en/Terms-and-Conditions>. Attention is drawn to the limitation of liability, indemnification and jurisdiction issues defined therein. Any holder of this document is advised that information contained hereon reflects the Company's findings at the time of its intervention only and within the limits of Client's instructions, if any. The Company's sole responsibility is to its Client and this document does not exonerate parties to a transaction from exercising all their rights and obligations under the transaction documents. This document cannot be reproduced except in full, without prior written approval of the Company. Any unauthorized alteration, forgery or falsification of the content or appearance of this document is unlawful and offenders may be prosecuted to the fullest extent of the law. Unless otherwise stated the results shown in this test report refer only to the sample(s) tested and such sample(s) are retained for 30 days only.

Attention: To check the authenticity of testing /inspection report & certificate, please contact us at telephone: (86-755) 8307 1443, or email: CN.Doccheck@sgs.com
 No.1 Workshop, M-10, Middle Section, Science & Technology Park, Nanshan District, Shenzhen, Guangdong, China 518057 t (86-755) 26012053 f (86-755) 26710594 www.sgs.com.cn
 中国·广东·深圳市南山区科技园中区M-10栋1号厂房 邮编: 518057 t (86-755) 26012053 f (86-755) 26710594 sgs.china@sgs.com

6 Radio Spectrum Technical Requirement

6.1 Antenna Requirement

6.1.1 Test Requirement:

47 CFR Part 15, Subpart C 15.203

6.1.2 Conclusion

15.203 requirement:

An intentional radiator shall be designed to ensure that no antenna other than that furnished by the responsible party shall be used with the device. The use of a permanently attached antenna or of an antenna that uses a unique coupling to the intentional radiator, the manufacturer may design the unit so that a broken antenna can be replaced by the user, but the use of a standard antenna jack or electrical connector is prohibited.

EUT Antenna:

The antenna is integrated on the main PCB and no consideration of replacement. The best case gain of the antenna is Antenna 1: 3.23dBi; Antenna 2: 5.73dBi; Directional gain: 7.58dB.

Antenna location: Refer to internal photos



Unless otherwise agreed in writing, this document is issued by the Company subject to its General Conditions of Service printed overleaf, available on request or accessible at <https://www.sgs.com/en/Terms-and-Conditions>. Attention is drawn to the limitation of liability, indemnification and jurisdiction issues defined therein. Any holder of this document is advised that information contained hereon reflects the Company's findings at the time of its intervention only and within the limits of Client's instructions, if any. The Company's sole responsibility is to its Client and this document does not exonerate parties to a transaction from exercising all their rights and obligations under the transaction documents. This document cannot be reproduced except in full, without prior written approval of the Company. Any unauthorized alteration, forgery or falsification of the content or appearance of this document is unlawful and offenders may be prosecuted to the fullest extent of the law. Unless otherwise stated the results shown in this test report refer only to the sample(s) tested and such sample(s) are retained for 30 days only.

Attention: To check the authenticity of testing /inspection report & certificate, please contact us at telephone: (86-755) 8307 1443, or email: CN.Doccheck@sgs.com

6.2 Transmission in the Absence of Data

6.2.1 Test Requirement:

47 CFR Part 15, Subpart E 15.407 (c)

6.2.2 Conclusion

Standard Requirement:

The device shall automatically discontinue transmission in case of either absence of information to transmit or operational failure. These provisions are not intended to preclude the transmission of control or signalling information or the use of repetitive codes used by certain digital technologies to complete frame or burst intervals.

Applicants shall include in their application for equipment authorization a description of how this requirement is met.

EUT Details:

WIFI chip support automatically discontinue transmission in case of either absence of information to transmit or operational failure, if the chip detect absence of information to transmit or operational failure, it will be automatically shut off.



Unless otherwise agreed in writing, this document is issued by the Company subject to its General Conditions of Service printed overleaf, available on request or accessible at <https://www.sgs.com/en/Terms-and-Conditions>. Attention is drawn to the limitation of liability, indemnification and jurisdiction issues defined therein. Any holder of this document is advised that information contained hereon reflects the Company's findings at the time of its intervention only and within the limits of Client's instructions, if any. The Company's sole responsibility is to its Client and this document does not exonerate parties to a transaction from exercising all their rights and obligations under the transaction documents. This document cannot be reproduced except in full, without prior written approval of the Company. Any unauthorized alteration, forgery or falsification of the content or appearance of this document is unlawful and offenders may be prosecuted to the fullest extent of the law. Unless otherwise stated the results shown in this test report refer only to the sample(s) tested and such sample(s) are retained for 30 days only.

Attention: To check the authenticity of testing /inspection report & certificate, please contact us at telephone: (86-755) 8307 1443, or email: CN.Doccheck@sgs.com

7 Radio Spectrum Matter Test Results

7.1 Conducted Emissions at AC Power Line (150kHz-30MHz)

Test Requirement 47 CFR Part 15, Subpart C 15.207 & Subpart E 15.407 b(9)

Test Method: ANSI C63.10 (2013) Section 6.2

Limit:

Frequency of emission(MHz)	Conducted limit(dB μ V)	
	Quasi-peak	Average
0.15-0.5	66 to 56*	56 to 46*
0.5-5	56	46
5-30	60	50

*Decreases with the logarithm of the frequency.

7.1.1 E.U.T. Operation

Operating Environment:

Temperature: 23.5 °C Humidity: 45.5 % RH Atmospheric Pressure: 1020 mbar

7.1.2 Test Mode Description

Pre-scan / Final test	Mode Code	Description
Final test	05	TX mode (U-NII-1)_Keep the EUT in continuously transmitting mode with all modulation types. All data rates for each modulation type have been tested and found the data rate @ 6Mbps is the worst case of IEEE 802.11a; data rate @ MCS0 is the worst case of IEEE 802.11n(HT20); data rate @ MCS0 is the worst case of IEEE 802.11n(HT40); data rate @ MCS0 is the worst case of IEEE 802.11ac(VHT20); data rate @ MCS0 is the worst case of IEEE 802.11ac(VHT40); data rate @ MCS0 is the worst case of IEEE 802.11ac(VHT80), data rate @ MCS0 is the worst case of IEEE 802.11ax(HEW20); data rate @ MCS0 is the worst case of IEEE 802.11ax(HEW40); data rate @ MCS0 is the worst case of IEEE 802.11ax(HEW80), final test modes are considering the modulation and worse data rates. Only the data of worst case is recorded in the report.
Pre-scan	06	TX mode (U-NII-2A)_Keep the EUT in continuously transmitting mode with all modulation types. All data rates for each modulation type have been tested and found the data rate @ 6Mbps is the worst case of IEEE 802.11a; data rate @ MCS0 is the worst case of IEEE 802.11n(HT20); data rate @ MCS0 is the worst case of IEEE 802.11n(HT40); data rate @ MCS0 is the worst case of IEEE 802.11ac(VHT20); data rate @ MCS0 is the worst case of IEEE 802.11ac(VHT40); data rate @ MCS0 is the worst case of IEEE 802.11ac(VHT80), data rate @ MCS0 is the worst case of IEEE 802.11ax(HEW20); data rate @ MCS0 is the worst case of IEEE 802.11ax(HEW40); data rate @ MCS0 is the worst case of IEEE 802.11ax(HEW80), final test modes are considering the modulation and worse data rates. Only the data of worst case is recorded in the report.



Unless otherwise agreed in writing, this document is issued by the Company subject to its General Conditions of Service printed overleaf, available on request or accessible at <https://www.sgs.com/en/Terms-and-Conditions>. Attention is drawn to the limitation of liability, indemnification and jurisdiction issues defined therein. Any holder of this document is advised that information contained hereon reflects the Company's findings at the time of its intervention only and within the limits of Client's instructions, if any. The Company's sole responsibility is to its Client and this document does not exonerate parties to a transaction from exercising all their rights and obligations under the transaction documents. This document cannot be reproduced except in full, without prior written approval of the Company. Any unauthorized alteration, forgery or falsification of the content or appearance of this document is unlawful and offenders may be prosecuted to the fullest extent of the law. Unless otherwise stated the results shown in this test report refer only to the sample(s) tested and such sample(s) are retained for 30 days only.

Pre-scan	07	TX mode (U-NII-2C)_Keep the EUT in continuously transmitting mode with all modulation types.All data rates for each modulation type have been tested and found the data rate @ 6Mbps is the worst case of IEEE 802.11a; data rate @ MCS0 is the worst case of IEEE 802.11n(HT20); data rate @ MCS0 is the worst case of IEEE 802.11n(HT40); data rate @ MCS0 is the worst case of IEEE 802.11ac(VHT20); data rate @ MCS0 is the worst case of IEEE 802.11ac(VHT40); data rate @ MCS0 is the worst case of IEEE 802.11ac(VHT80) , data rate @ MCS0 is the worst case of IEEE 802.11ax(HEW20); data rate @ MCS0 is the worst case of IEEE 802.11ax(HEW40); data rate @ MCS0 is the worst case of IEEE 802.11ax(HEW80). Only the data of worst case is recorded in the report.
Pre-scan	08	TX mode (U-NII-3)_Keep the EUT in continuously transmitting mode with all modulation types. All data rates for each modulation type have been tested and found the data rate @ 6Mbps is the worst case of IEEE 802.11a; data rate @ MCS0 is the worst case of IEEE 802.11n(HT20); data rate @ MCS0 is the worst case of IEEE 802.11n(HT40); data rate @ MCS0 is the worst case of IEEE 802.11ac(VHT20); data rate @ MCS0 is the worst case of IEEE 802.11ac(VHT40); data rate @ MCS0 is the worst case of IEEE 802.11ac(VHT80); data rate @ MCS0 is the worst case of IEEE 802.11ax(HEW20); data rate @ MCS0 is the worst case of IEEE 802.11ax(HEW40); data rate @ MCS0 is the worst case of IEEE 802.11ax(HEW80), final test modes are considering the modulation and worse data rates. Only the data of worst case is recorded in the report.

7.1.3 Test Setup Diagram

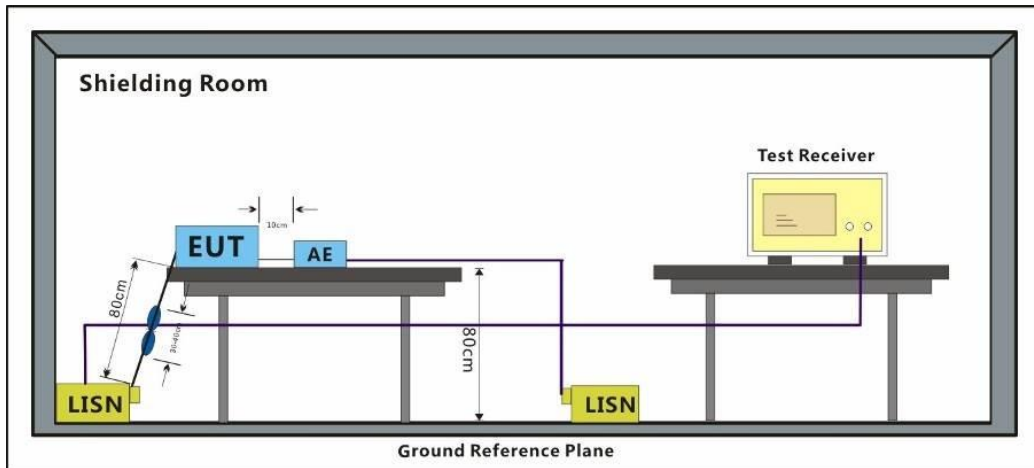

Unless otherwise agreed in writing, this document is issued by the Company subject to its General Conditions of Service printed overleaf, available on request or accessible at <https://www.sgs.com/en/Terms-and-Conditions>. Attention is drawn to the limitation of liability, indemnification and jurisdiction issues defined therein. Any holder of this document is advised that information contained hereon reflects the Company's findings at the time of its intervention only and within the limits of Client's instructions, if any. The Company's sole responsibility is to its Client and this document does not exonerate parties to a transaction from exercising all their rights and obligations under the transaction documents. This document cannot be reproduced except in full, without prior written approval of the Company. Any unauthorized alteration, forgery or falsification of the content or appearance of this document is unlawful and offenders may be prosecuted to the fullest extent of the law. Unless otherwise stated the results shown in this test report refer only to the sample(s) tested and such sample(s) are retained for 30 days only.

Attention: To check the authenticity of testing /inspection report & certificate, please contact us at telephone: (86-755) 8307 1443, or email: CN.Doccheck@sgs.com
 No.1 Workshop, M-10, Middle Section, Science & Technology Park, Nanshan District, Shenzhen, Guangdong, China 518057 t (86-755) 26012053 f (86-755) 26710594 www.sgs.com.cn
 中国·广东·深圳市南山区科技园中区M-10栋1号厂房 邮编: 518057 t (86-755) 26012053 f (86-755) 26710594 sgs.china@sgs.com

7.1.4 Measurement Procedure and Data

- 1) The mains terminal disturbance voltage test was conducted in a shielded room.
- 2) The EUT was connected to AC power source through a LISN 1 (Line Impedance Stabilization Network) which provides a 50ohm/50μH + 5ohm linear impedance. The power cables of all other units of the EUT were connected to a second LISN 2, which was bonded to the ground reference plane in the same way as the LISN 1 for the unit being measured. A multiple socket outlet strip was used to connect multiple power cables to a single LISN provided the rating of the LISN was not exceeded.
- 3) The tabletop EUT was placed upon a non-metallic table 0.8m above the ground reference plane. And for floor-standing arrangement, the EUT was placed on the horizontal ground reference plane,
- 4) The test was performed with a vertical ground reference plane. The rear of the EUT shall be 0.4 m from the vertical ground reference plane. The vertical ground reference plane was bonded to the horizontal ground reference plane. The LISN 1 was placed 0.8 m from the boundary of the unit under test and bonded to a ground reference plane for LISNs mounted on top of the ground reference plane. This distance was between the closest points of the LISN 1 and the EUT. All other units of the EUT and associated equipment was at least 0.8 m from the LISN 2.
- 5) In order to find the maximum emission, the relative positions of equipment and all of the interface cables must be changed according to ANSI C63.10 on conducted measurement.

Remark: Level=Read Level+ Cable Loss+ LISN Factor



Unless otherwise agreed in writing, this document is issued by the Company subject to its General Conditions of Service printed overleaf, available on request or accessible at <https://www.sgs.com/en/Terms-and-Conditions>. Attention is drawn to the limitation of liability, indemnification and jurisdiction issues defined therein. Any holder of this document is advised that information contained hereon reflects the Company's findings at the time of its intervention only and within the limits of Client's instructions, if any. The Company's sole responsibility is to its Client and this document does not exonerate parties to a transaction from exercising all their rights and obligations under the transaction documents. This document cannot be reproduced except in full, without prior written approval of the Company. Any unauthorized alteration, forgery or falsification of the content or appearance of this document is unlawful and offenders may be prosecuted to the fullest extent of the law. Unless otherwise stated the results shown in this test report refer only to the sample(s) tested and such sample(s) are retained for 30 days only.

Attention: To check the authenticity of testing /inspection report & certificate, please contact us at telephone: (86-755) 8307 1443, or email: CN.Doccheck@sgs.com

Test Mode: 05; Line: Live line

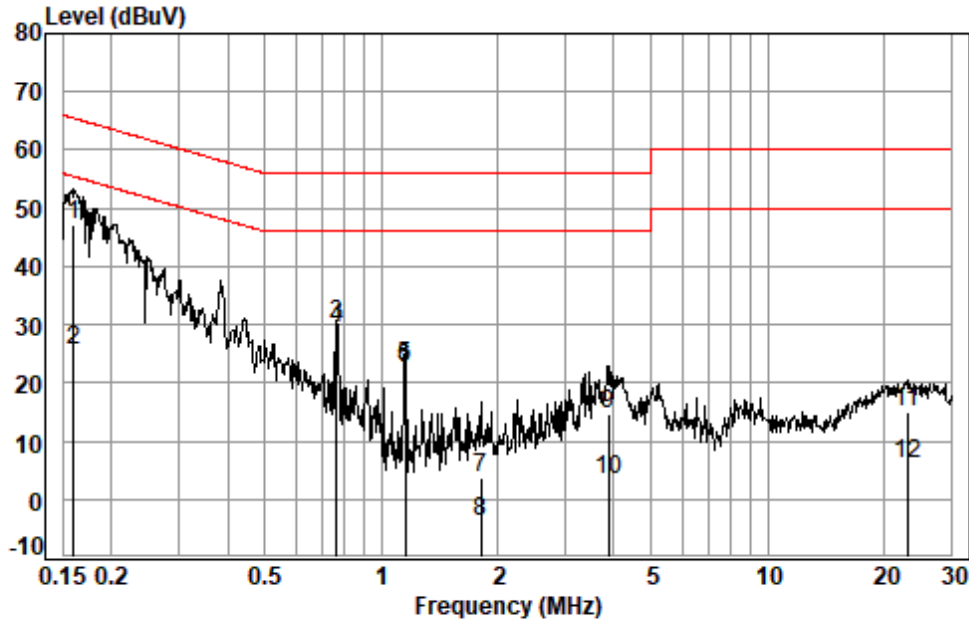

Site : Shielding Room

Condition: Line

Job No. : 03018AT

Test mode: 05

: 2#

	Freq	Cable Loss	LISN Factor	Read Level	Limit Level	Limit Line	Over Limit	Remark
	MHz	dB	dB	dBuV	dBuV	dBuV	dB	
1 *	0.1598	0.02	9.89	37.09	47.00	65.47	-18.47	QP
2	0.1598	0.02	9.89	15.55	25.46	55.47	-30.01	Average
3	0.7670	0.05	10.02	19.83	29.90	56.00	-26.10	QP
4 *	0.7670	0.05	10.02	19.42	29.49	46.00	-16.51	Average
5	1.1534	0.06	10.02	12.76	22.84	56.00	-33.16	QP
6	1.1534	0.06	10.02	12.55	22.63	46.00	-23.37	Average
7	1.8096	0.07	10.01	-6.31	3.77	56.00	-52.23	QP
8	1.8096	0.07	10.01	-14.07	-3.99	46.00	-49.99	Average
9	3.8808	0.08	10.02	4.58	14.68	56.00	-41.32	QP
10	3.8808	0.08	10.02	-6.83	3.27	46.00	-42.73	Average
11	23.0181	0.29	10.26	4.34	14.89	60.00	-45.11	QP
12	23.0181	0.29	10.26	-4.55	6.00	50.00	-44.00	Average



Unless otherwise agreed in writing, this document is issued by the Company subject to its General Conditions of Service printed overleaf, available on request or accessible at <https://www.sgs.com/en/Terms-and-Conditions>. Attention is drawn to the limitation of liability, indemnification and jurisdiction issues defined therein. Any holder of this document is advised that information contained hereon reflects the Company's findings at the time of its intervention only and within the limits of Client's instructions, if any. The Company's sole responsibility is to its Client and this document does not exonerate parties to a transaction from exercising all their rights and obligations under the transaction documents. This document cannot be reproduced except in full, without prior written approval of the Company. Any unauthorized alteration, forgery or falsification of the content or appearance of this document is unlawful and offenders may be prosecuted to the fullest extent of the law. Unless otherwise stated the results shown in this test report refer only to the sample(s) tested and such sample(s) are retained for 30 days only.

Test Mode: 05; Line: Neutral Line

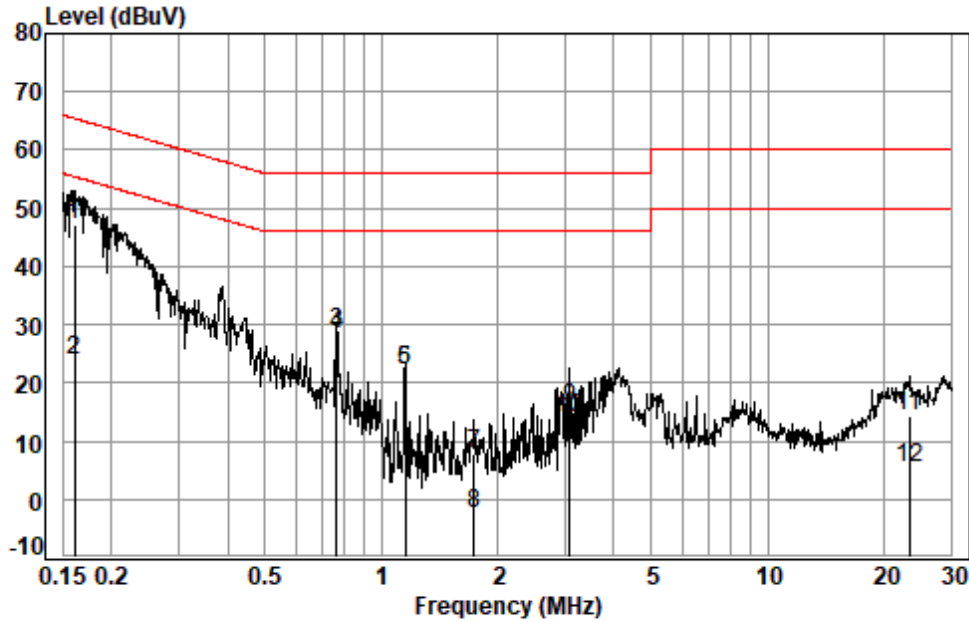

Site : Shielding Room
 Condition: Neutral
 Job No. : 03018AT
 Test mode: 05
 : 2#

	Freq	Cable Loss	LISN Factor	Read Level	Limit Level	Limit Line	Over Limit	Remark
	MHz	dB	dB	dBuV	dBuV	dBuV	dB	
1 *	0.1607	0.02	9.89	37.10	47.01	65.43	-18.42	QP
2	0.1607	0.02	9.89	13.89	23.80	55.43	-31.63	Average
3	0.7670	0.05	9.95	18.65	28.65	56.00	-27.35	QP
4 *	0.7670	0.05	9.95	18.22	28.22	46.00	-17.78	Average
5	1.1534	0.06	9.99	12.27	22.32	56.00	-33.68	QP
6	1.1534	0.06	9.99	12.15	22.20	46.00	-23.80	Average
7	1.7345	0.07	9.95	-2.14	7.88	56.00	-48.12	QP
8	1.7345	0.07	9.95	-12.42	-2.40	46.00	-48.40	Average
9	3.0738	0.08	9.97	5.56	15.61	56.00	-40.39	QP
10	3.0738	0.08	9.97	4.05	14.10	46.00	-31.90	Average
11	23.2633	0.30	10.34	3.68	14.32	60.00	-45.68	QP
12	23.2633	0.30	10.34	-5.21	5.43	50.00	-44.57	Average



Unless otherwise agreed in writing, this document is issued by the Company subject to its General Conditions of Service printed overleaf, available on request or accessible at <https://www.sgs.com/en/Terms-and-Conditions>. Attention is drawn to the limitation of liability, indemnification and jurisdiction issues defined therein. Any holder of this document is advised that information contained hereon reflects the Company's findings at the time of its intervention only and within the limits of Client's instructions, if any. The Company's sole responsibility is to its Client and this document does not exonerate parties to a transaction from exercising all their rights and obligations under the transaction documents. This document cannot be reproduced except in full, without prior written approval of the Company. Any unauthorized alteration, forgery or falsification of the content or appearance of this document is unlawful and offenders may be prosecuted to the fullest extent of the law. Unless otherwise stated the results shown in this test report refer only to the sample(s) tested and such sample(s) are retained for 30 days only.

7.2 Maximum Conducted output power

Test Requirement 47 CFR Part 15, Subpart E 15.407 (a)
 Test Method: KDB 789033 D02 II E

Limit:

Frequency band(MHz)	Limit
5150-5250	≤1W(30dBm) for master device
	≤250mW(24dBm) for client device
5250-5350	≤250mW(24dBm) or 11dBm+10logB*
5470-5725	≤250mW(24dBm) or 11dBm+10logB*
5725-5850	≤1W(30dBm)
Remark:	* Where B is the 26dB emission bandwidth in MHz. The maximum conducted output power must be measured over any interval of continuous transmission using instrumentation calibrated in terms of an rms-equivalent voltage.

7.2.1 E.U.T. Operation

Operating Environment:

Temperature: 24.2 °C Humidity: 46.7 % RH Atmospheric Pressure: 1020 mbar

7.2.2 Test Mode Description

Pre-scan / Final test	Mode Code	Description
Final test	05	TX mode (U-NII-1)_Keep the EUT in continuously transmitting mode with all modulation types. All data rates for each modulation type have been tested and found the data rate @ 6Mbps is the worst case of IEEE 802.11a; data rate @ MCS0 is the worst case of IEEE 802.11n(HT20); data rate @ MCS0 is the worst case of IEEE 802.11n(HT40); data rate @ MCS0 is the worst case of IEEE 802.11ac(VHT20); data rate @ MCS0 is the worst case of IEEE 802.11ac(VHT40); data rate @ MCS0 is the worst case of IEEE 802.11ac(VHT80), data rate @ MCS0 is the worst case of IEEE 802.11ax(HEW20); data rate @ MCS0 is the worst case of IEEE 802.11ax(HEW40); data rate @ MCS0 is the worst case of IEEE 802.11ax(HEW80), final test modes are considering the modulation and worse data rates. Only the data of worst case is recorded in the report.



Unless otherwise agreed in writing, this document is issued by the Company subject to its General Conditions of Service printed overleaf, available on request or accessible at <https://www.sgs.com/en/Terms-and-Conditions>. Attention is drawn to the limitation of liability, indemnification and jurisdiction issues defined therein. Any holder of this document is advised that information contained hereon reflects the Company's findings at the time of its intervention only and within the limits of Client's instructions, if any. The Company's sole responsibility is to its Client and this document does not exonerate parties to a transaction from exercising all their rights and obligations under the transaction documents. This document cannot be reproduced except in full, without prior written approval of the Company. Any unauthorized alteration, forgery or falsification of the content or appearance of this document is unlawful and offenders may be prosecuted to the fullest extent of the law. Unless otherwise stated the results shown in this test report refer only to the sample(s) tested and such sample(s) are retained for 30 days only.

Final test	06	TX mode (U-NII-2A)_Keep the EUT in continuously transmitting mode with all modulation types. All data rates for each modulation type have been tested and found the data rate @ 6Mbps is the worst case of IEEE 802.11a; data rate @ MCS0 is the worst case of IEEE 802.11n(HT20); data rate @ MCS0 is the worst case of IEEE 802.11n(HT40); data rate @ MCS0 is the worst case of IEEE 802.11ac(VHT20); data rate @ MCS0 is the worst case of IEEE 802.11ac(VHT40); data rate @ MCS0 is the worst case of IEEE 802.11ac(VHT80), data rate @ MCS0 is the worst case of IEEE 802.11ax(HEW20); data rate @ MCS0 is the worst case of IEEE 802.11ax(HEW40); data rate @ MCS0 is the worst case of IEEE 802.11ax(HEW80), final test modes are considering the modulation and worse data rates. Only the data of worst case is recorded in the report.
Final test	07	TX mode (U-NII-2C)_Keep the EUT in continuously transmitting mode with all modulation types.All data rates for each modulation type have been tested and found the data rate @ 6Mbps is the worst case of IEEE 802.11a; data rate @ MCS0 is the worst case of IEEE 802.11n(HT20); data rate @ MCS0 is the worst case of IEEE 802.11n(HT40); data rate @ MCS0 is the worst case of IEEE 802.11ac(VHT20); data rate @ MCS0 is the worst case of IEEE 802.11ac(VHT40); data rate @ MCS0 is the worst case of IEEE 802.11ac(VHT80) , data rate @ MCS0 is the worst case of IEEE 802.11ax(HEW20); data rate @ MCS0 is the worst case of IEEE 802.11ax(HEW40); data rate @ MCS0 is the worst case of IEEE 802.11ax(HEW80). Only the data of worst case is recorded in the report.
Final test	08	TX mode (U-NII-3)_Keep the EUT in continuously transmitting mode with all modulation types. All data rates for each modulation type have been tested and found the data rate @ 6Mbps is the worst case of IEEE 802.11a; data rate @ MCS0 is the worst case of IEEE 802.11n(HT20); data rate @ MCS0 is the worst case of IEEE 802.11n(HT40); data rate @ MCS0 is the worst case of IEEE 802.11ac(VHT20); data rate @ MCS0 is the worst case of IEEE 802.11ac(VHT40); data rate @ MCS0 is the worst case of IEEE 802.11ac(VHT80); data rate @ MCS0 is the worst case of IEEE 802.11ax(HEW20); data rate @ MCS0 is the worst case of IEEE 802.11ax(HEW40); data rate @ MCS0 is the worst case of IEEE 802.11ax(HEW80), final test modes are considering the modulation and worse data rates. Only the data of worst case is recorded in the report.



Unless otherwise agreed in writing, this document is issued by the Company subject to its General Conditions of Service printed overleaf, available on request or accessible at <https://www.sgs.com/en/Terms-and-Conditions>. Attention is drawn to the limitation of liability, indemnification and jurisdiction issues defined therein. Any holder of this document is advised that information contained hereon reflects the Company's findings at the time of its intervention only and within the limits of Client's instructions, if any. The Company's sole responsibility is to its Client and this document does not exonerate parties to a transaction from exercising all their rights and obligations under the transaction documents. This document cannot be reproduced except in full, without prior written approval of the Company. Any unauthorized alteration, forgery or falsification of the content or appearance of this document is unlawful and offenders may be prosecuted to the fullest extent of the law. Unless otherwise stated the results shown in this test report refer only to the sample(s) tested and such sample(s) are retained for 30 days only.

Attention: To check the authenticity of testing /inspection report & certificate, please contact us at telephone: (86-755) 8307 1443, or email: CN.Doccheck@sgs.com
 No.1 Workshop, M-10, Middle Section, Science & Technology Park, Nanshan District, Shenzhen, Guangdong, China 518057 t (86-755) 26012053 f (86-755) 26710594 www.sgs.com.cn
 中国·广东·深圳市南山区科技园中区M-10栋1号厂房 邮编: 518057 t (86-755) 26012053 f (86-755) 26710594 sgs.china@sgs.com

7.2.3 Test Setup Diagram

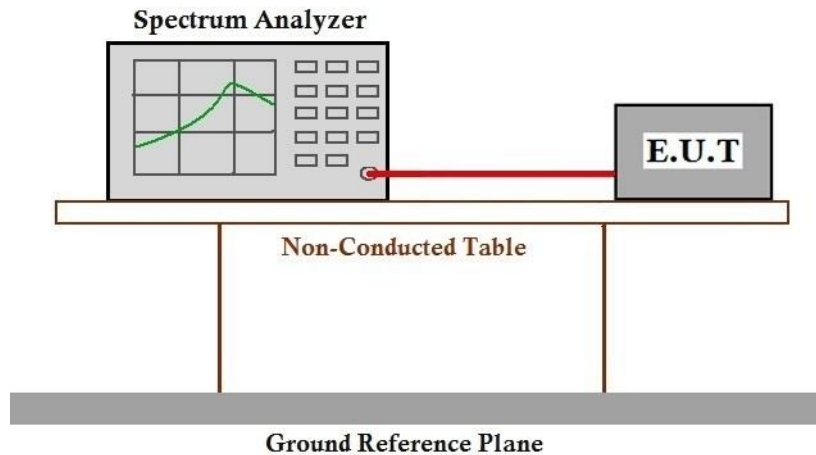

7.2.4 Measurement Procedure and Data

Note: Since the verify power the same operating range bandwidth and smaller power can be covered by the higher power.

Please Refer to Appendix for Details



Unless otherwise agreed in writing, this document is issued by the Company subject to its General Conditions of Service printed overleaf, available on request or accessible at <https://www.sgs.com/en/Terms-and-Conditions>. Attention is drawn to the limitation of liability, indemnification and jurisdiction issues defined therein. Any holder of this document is advised that information contained hereon reflects the Company's findings at the time of its intervention only and within the limits of Client's instructions, if any. The Company's sole responsibility is to its Client and this document does not exonerate parties to a transaction from exercising all their rights and obligations under the transaction documents. This document cannot be reproduced except in full, without prior written approval of the Company. Any unauthorized alteration, forgery or falsification of the content or appearance of this document is unlawful and offenders may be prosecuted to the fullest extent of the law. Unless otherwise stated the results shown in this test report refer only to the sample(s) tested and such sample(s) are retained for 30 days only.

Attention: To check the authenticity of testing /inspection report & certificate, please contact us at telephone: (86-755) 8307 1443, or email: CN.Doccheck@sgs.com

7.3 Radiated Emissions (Below 1GHz)

Test Requirement 47 CFR Part 15, Subpart C 15.209 & Subpart E 15.407(b)

Test Method: KDB 789033 D02 II G

Measurement Distance: 10m

Limit:

Frequency(MHz)	Field strength(microvolts/meter)	Measurement distance(meters)
0.009-0.490	2400/F(kHz)	300
0.490-1.705	24000/F(kHz)	30
1.705-30.0	30	30
30-88	100	3
88-216	150	3
216-960	200	3
960-1000	500	3

7.3.1 E.U.T. Operation

Operating Environment:

Temperature: 23.6 °C Humidity: 50.5 % RH Atmospheric Pressure: 1020 mbar

7.3.2 Test Mode Description

Pre-scan / Final test	Mode Code	Description
Final test	05	TX mode (U-NII-1)_Keep the EUT in continuously transmitting mode with all modulation types. All data rates for each modulation type have been tested and found the data rate @ 6Mbps is the worst case of IEEE 802.11a; data rate @ MCS0 is the worst case of IEEE 802.11n(HT20); data rate @ MCS0 is the worst case of IEEE 802.11n(HT40); data rate @ MCS0 is the worst case of IEEE 802.11ac(VHT20); data rate @ MCS0 is the worst case of IEEE 802.11ac(VHT40); data rate @ MCS0 is the worst case of IEEE 802.11ac(VHT80), data rate @ MCS0 is the worst case of IEEE 802.11ax(HEW20); data rate @ MCS0 is the worst case of IEEE 802.11ax(HEW40); data rate @ MCS0 is the worst case of IEEE 802.11ax(HEW80), final test modes are considering the modulation and worse data rates. Only the data of worst case is recorded in the report.
Pre-scan	06	TX mode (U-NII-2A)_Keep the EUT in continuously transmitting mode with all modulation types. All data rates for each modulation type have been tested and found the data rate @ 6Mbps is the worst case of IEEE 802.11a; data rate @ MCS0 is the worst case of IEEE 802.11n(HT20); data rate @ MCS0 is the worst case of IEEE 802.11n(HT40); data rate @ MCS0 is the worst case of IEEE 802.11ac(VHT20); data rate @ MCS0 is the worst case of IEEE 802.11ac(VHT40); data rate @ MCS0 is the worst case of IEEE 802.11ac(VHT80), data rate @ MCS0 is the worst case of IEEE 802.11ax(HEW20); data rate @ MCS0 is the worst case of



Unless otherwise agreed in writing, this document is issued by the Company subject to its General Conditions of Service printed overleaf, available on request or accessible at <https://www.sgs.com/en/Terms-and-Conditions>. Attention is drawn to the limitation of liability, indemnification and jurisdiction issues defined therein. Any holder of this document is advised that information contained hereon reflects the Company's findings at the time of its intervention only and within the limits of Client's instructions, if any. The Company's sole responsibility is to its Client and this document does not exonerate parties to a transaction from exercising all their rights and obligations under the transaction documents. This document cannot be reproduced except in full, without prior written approval of the Company. Any unauthorized alteration, forgery or falsification of the content or appearance of this document is unlawful and offenders may be prosecuted to the fullest extent of the law. Unless otherwise stated the results shown in this test report refer only to the sample(s) tested and such sample(s) are retained for 30 days only.

		IEEE 802.11ax(HEW40); data rate @ MCS0 is the worst case of IEEE 802.11ax(HEW80), final test modes are considering the modulation and worse data rates. Only the data of worst case is recorded in the report.
Pre-scan	07	TX mode (U-NII-2C)_Keep the EUT in continuously transmitting mode with all modulation types.All data rates for each modulation type have been tested and found the data rate @ 6Mbps is the worst case of IEEE 802.11a; data rate @ MCS0 is the worst case of IEEE 802.11n(HT20); data rate @ MCS0 is the worst case of IEEE 802.11n(HT40); data rate @ MCS0 is the worst case of IEEE 802.11ac(VHT20); data rate @ MCS0 is the worst case of IEEE 802.11ac(VHT40); data rate @ MCS0 is the worst case of IEEE 802.11ac(VHT80) , data rate @ MCS0 is the worst case of IEEE 802.11ax(HEW20); data rate @ MCS0 is the worst case of IEEE 802.11ax(HEW40); data rate @ MCS0 is the worst case of IEEE 802.11ax(HEW80). Only the data of worst case is recorded in the report.
Pre-scan	08	TX mode (U-NII-3)_Keep the EUT in continuously transmitting mode with all modulation types. All data rates for each modulation type have been tested and found the data rate @ 6Mbps is the worst case of IEEE 802.11a; data rate @ MCS0 is the worst case of IEEE 802.11n(HT20); data rate @ MCS0 is the worst case of IEEE 802.11n(HT40); data rate @ MCS0 is the worst case of IEEE 802.11ac(VHT20); data rate @ MCS0 is the worst case of IEEE 802.11ac(VHT40); data rate @ MCS0 is the worst case of IEEE 802.11ac(VHT80); data rate @ MCS0 is the worst case of IEEE 802.11ax(HEW20); data rate @ MCS0 is the worst case of IEEE 802.11ax(HEW40); data rate @ MCS0 is the worst case of IEEE 802.11ax(HEW80), final test modes are considering the modulation and worse data rates. Only the data of worst case is recorded in the report.

7.3.3 Test Setup Diagram

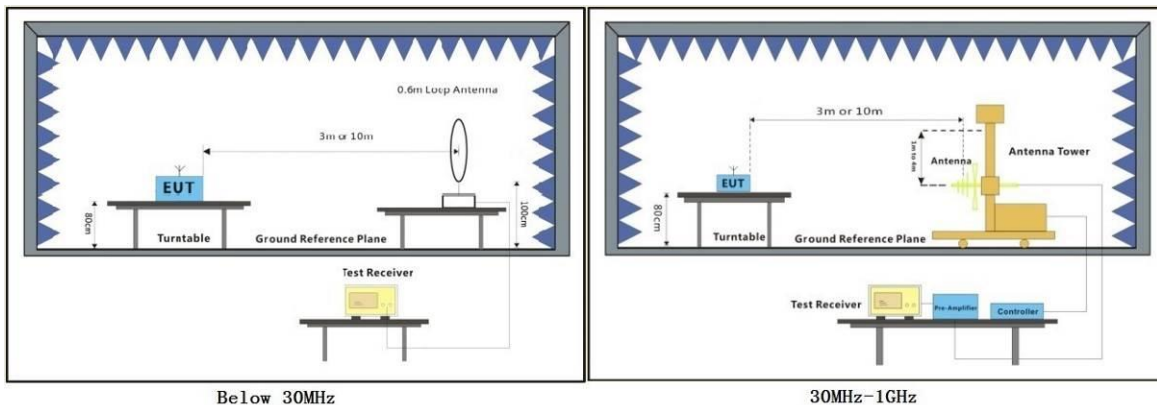

Below 30MHz

30MHz-1GHz



7.3.4 Measurement Procedure and Data

- a. For below 1GHz, the EUT was placed on the top of a rotating table 0.8 meters above the ground at a 3 meter semi-anechoic chamber. The table was rotated 360 degrees to determine the position of the highest radiation.
- b. The EUT was set 3 or 10 meters away from the interference-receiving antenna, which was mounted on the top of a variable-height antenna tower.
- c. The antenna height is varied from one meter to four meters above the ground to determine the maximum value of the field strength. Both horizontal and vertical polarizations of the antenna are set to make the measurement.
- d. For each suspected emission, the EUT was arranged to its worst case and then the antenna was tuned to heights from 1 meter to 4 meters (for the test frequency of below 30MHz, the antenna was tuned to heights 1 meter) and the rotatable table was turned from 0 degrees to 360 degrees to find the maximum reading.
- e. The test-receiver system was set to Peak Detect Function and Specified Bandwidth with Maximum Hold Mode.
- f. If the emission level of the EUT in peak mode was 10dB lower than the limit specified, then testing could be stopped and the peak values of the EUT would be reported. Otherwise the emissions that did not have 10dB margin would be re-tested one by one using quasi-peak method as specified and then reported in a data sheet.
- g. Test the EUT in the lowest channel, the middle channel, the Highest channel.
- h. The radiation measurements are performed in X, Y, Z axis positioning for Transmitting mode, and found the X axis positioning which it is the worst case.
- i. Repeat above procedures until all frequencies measured was complete.

Remark:

1. Level= Read Level+ Cable Loss+ Antenna Factor- Preamp Factor
2. For emission below 1GHz, through the pre-scan found the worst case is the lowest channel of 802.11a. Only the worst case is recorded in the report.
3. Scan from 9kHz to 30MHz, the disturbance below 30MHz was very low. The points marked on above plots are the highest emissions could be found when testing, so only above points had been displayed. The amplitude of spurious emissions from the radiator which are attenuated more than 20dB below the limit need not be reported.
4. The disturbance below 1GHz was very low and the harmonics were the highest point could be found when testing, so only the above harmonics had been displayed.



Unless otherwise agreed in writing, this document is issued by the Company subject to its General Conditions of Service printed overleaf, available on request or accessible at <https://www.sgs.com/en/Terms-and-Conditions>. Attention is drawn to the limitation of liability, indemnification and jurisdiction issues defined therein. Any holder of this document is advised that information contained hereon reflects the Company's findings at the time of its intervention only and within the limits of Client's instructions, if any. The Company's sole responsibility is to its Client and this document does not exonerate parties to a transaction from exercising all their rights and obligations under the transaction documents. This document cannot be reproduced except in full, without prior written approval of the Company. Any unauthorized alteration, forgery or falsification of the content or appearance of this document is unlawful and offenders may be prosecuted to the fullest extent of the law. Unless otherwise stated the results shown in this test report refer only to the sample(s) tested and such sample(s) are retained for 30 days only.

Attention: To check the authenticity of testing /inspection report & certificate, please contact us at telephone: (86-755) 8307 1443, or email: CN.Doccheck@sgs.com

Test Mode: 05; Polarity: Horizontal

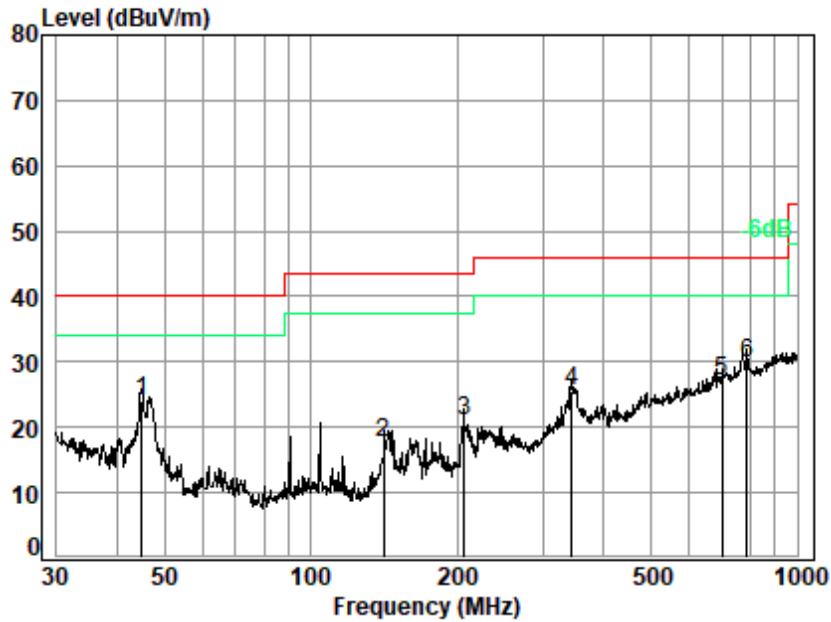

Site : chamber
 Condition: 3m HORIZONTAL
 Job No. : 03018AT/03019AT
 Test Mode: 05
 : 2#

	Ant	Cable	Preamp	Read	Limit	Over				
	Freq	Factor	Loss	Level	Level	Line	Limit	Remark		
	MHz	dB/m	dB	dB	dBuV	dBuV/m	dBuV/m	dB		
1	q	44.90	14.25	0.79	27.75	36.68	23.97	40.00	-16.03	QP
2		141.33	11.96	1.41	27.42	31.65	17.60	43.50	-25.90	QP
3		206.40	14.61	1.76	27.14	31.68	20.91	43.50	-22.59	QP
4		344.39	19.47	2.34	26.93	30.53	25.41	46.00	-20.59	QP
5		699.30	25.93	3.51	27.73	25.22	26.93	46.00	-19.07	QP
6		787.85	27.15	3.79	27.51	26.47	29.90	46.00	-16.10	QP



Unless otherwise agreed in writing, this document is issued by the Company subject to its General Conditions of Service printed overleaf, available on request or accessible at <https://www.sgs.com/en/Terms-and-Conditions>. Attention is drawn to the limitation of liability, indemnification and jurisdiction issues defined therein. Any holder of this document is advised that information contained hereon reflects the Company's findings at the time of its intervention only and within the limits of Client's instructions, if any. The Company's sole responsibility is to its Client and this document does not exonerate parties to a transaction from exercising all their rights and obligations under the transaction documents. This document cannot be reproduced except in full, without prior written approval of the Company. Any unauthorized alteration, forgery or falsification of the content or appearance of this document is unlawful and offenders may be prosecuted to the fullest extent of the law. Unless otherwise stated the results shown in this test report refer only to the sample(s) tested and such sample(s) are retained for 30 days only.

Test Mode: 05; Polarity: Vertical

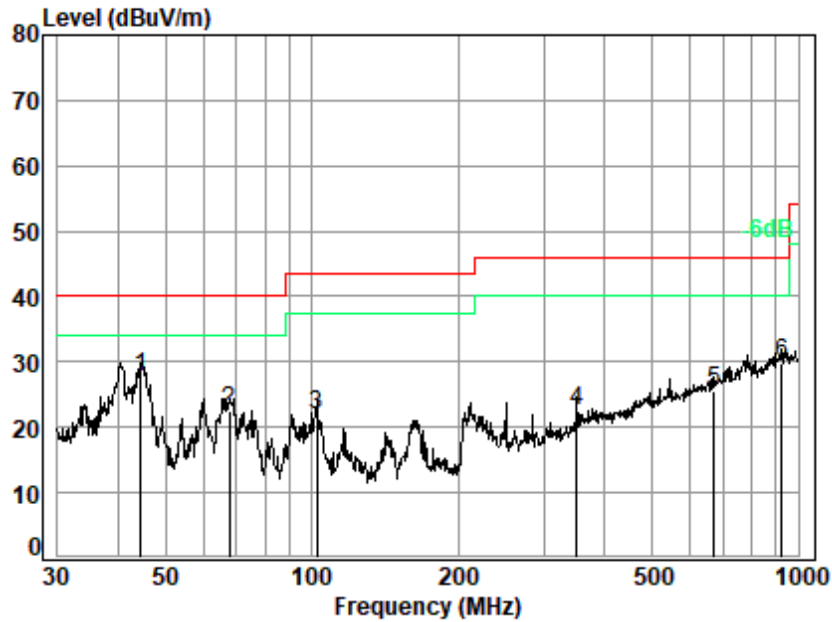

Site : chamber
 Condition: 3m VERTICAL
 Job No. : 03018AT/03019AT
 Test Mode: 05
 : 2#

	Ant	Cable	Preamp	Read	Limit	Over			
	Freq	Factor	Loss	Factor	Level	Level	Line	Limit	Remark
	MHz	dB/m	dB	dB	dBuV	dBuV/m	dBuV/m	dB	
1	q	44.59	14.36	0.79	27.75	40.42	27.82	40.00	-12.18 QP
2		67.68	10.75	0.97	27.68	38.44	22.48	40.00	-17.52 QP
3		102.36	12.31	1.20	27.58	35.99	21.92	43.50	-21.58 QP
4		350.48	19.94	2.36	26.96	27.32	22.66	46.00	-23.34 QP
5		670.49	25.57	3.42	27.80	24.46	25.65	46.00	-20.35 QP
6		925.76	28.18	4.16	26.58	24.08	29.84	46.00	-16.16 QP



Unless otherwise agreed in writing, this document is issued by the Company subject to its General Conditions of Service printed overleaf, available on request or accessible at <https://www.sgs.com/en/Terms-and-Conditions>. Attention is drawn to the limitation of liability, indemnification and jurisdiction issues defined therein. Any holder of this document is advised that information contained hereon reflects the Company's findings at the time of its intervention only and within the limits of Client's instructions, if any. The Company's sole responsibility is to its Client and this document does not exonerate parties to a transaction from exercising all their rights and obligations under the transaction documents. This document cannot be reproduced except in full, without prior written approval of the Company. Any unauthorized alteration, forgery or falsification of the content or appearance of this document is unlawful and offenders may be prosecuted to the fullest extent of the law. Unless otherwise stated the results shown in this test report refer only to the sample(s) tested and such sample(s) are retained for 30 days only.

7.4 Radiated Emissions (Above 1GHz)

Test Requirement 47 CFR Part 15, Subpart C 15.209 & Subpart E 15.407(b)

Test Method: KDB 789033 D02 II G

Measurement Distance: 3m

Limit:

Frequency(MHz)	Field strength(microvolts/meter)	Measurement distance(meters)
Above 1GHz	500	3
<p>*(1) For transmitters operating in the 5.15-5.25 GHz band: All emissions outside of the 5.15-5.35 GHz band shall not exceed an e.i.r.p. of -27 dBm/MHz.</p> <p>(2) For transmitters operating in the 5.25-5.35 GHz band: All emissions outside of the 5.15-5.35 GHz band shall not exceed an e.i.r.p. of -27 dBm/MHz.</p> <p>(3) For transmitters operating in the 5.47-5.725 GHz band: All emissions outside of the 5.47-5.725 GHz band shall not exceed an e.i.r.p. of -27 dBm/MHz.</p> <p>(4) For transmitters operating in the 5.725-5.85 GHz band:</p> <p>(i) All emissions shall be limited to a level of -27 dBm/MHz at 75 MHz or more above or below the band edge increasing linearly to 10 dBm/MHz at 25 MHz above or below the band edge, and from 25 MHz above or below the band edge increasing linearly to a level of 15.6 dBm/MHz at 5 MHz above or below the band edge, and from 5 MHz above or below the band edge increasing linearly to a level of 27 dBm/MHz at the band edge.</p> <p>Remark: The emission limits shown in the above table are based on measurements employing a CISPR quasi-peak detector except for the frequency bands 9-90kHz, 110-490kHz and above 1000 MHz. Radiated emission limits in these three bands are based on measurements employing an average detector, the peak field strength of any emission shall not exceed the maximum permitted average limits specified above by more than 20 dB under any condition of modulation.</p>		

7.4.1 E.U.T. Operation

Operating Environment:

Temperature: 23.6 °C Humidity: 66.1 % RH Atmospheric Pressure: 1020 mbar



Unless otherwise agreed in writing, this document is issued by the Company subject to its General Conditions of Service printed overleaf, available on request or accessible at <https://www.sgs.com/en/Terms-and-Conditions>. Attention is drawn to the limitation of liability, indemnification and jurisdiction issues defined therein. Any holder of this document is advised that information contained hereon reflects the Company's findings at the time of its intervention only and within the limits of Client's instructions, if any. The Company's sole responsibility is to its Client and this document does not exonerate parties to a transaction from exercising all their rights and obligations under the transaction documents. This document cannot be reproduced except in full, without prior written approval of the Company. Any unauthorized alteration, forgery or falsification of the content or appearance of this document is unlawful and offenders may be prosecuted to the fullest extent of the law. Unless otherwise stated the results shown in this test report refer only to the sample(s) tested and such sample(s) are retained for 30 days only.

Attention: To check the authenticity of testing /inspection report & certificate, please contact us at telephone: (86-755) 8307 1443, or email: CN.Doccheck@sgs.com
 No.1 Workshop, M-10, Middle Section, Science & Technology Park, Nanshan District, Shenzhen, Guangdong, China 518057 t (86-755) 26012053 f (86-755) 26710594 www.sgs.com.cn
 中国·广东·深圳市南山区科技园中区M-10栋1号厂房 邮编: 518057 t (86-755) 26012053 f (86-755) 26710594 sgs.china@sgs.com

7.4.2 Test Mode Description

Pre-scan / Final test	Mode Code	Description
Final test	05	TX mode (U-NII-1)_Keep the EUT in continuously transmitting mode with all modulation types. All data rates for each modulation type have been tested and found the data rate @ 6Mbps is the worst case of IEEE 802.11a; data rate @ MCS0 is the worst case of IEEE 802.11n(HT20); data rate @ MCS0 is the worst case of IEEE 802.11n(HT40); data rate @ MCS0 is the worst case of IEEE 802.11ac(VHT20); data rate @ MCS0 is the worst case of IEEE 802.11ac(VHT40); data rate @ MCS0 is the worst case of IEEE 802.11ac(VHT80), data rate @ MCS0 is the worst case of IEEE 802.11ax(HEW20); data rate @ MCS0 is the worst case of IEEE 802.11ax(HEW40); data rate @ MCS0 is the worst case of IEEE 802.11ax(HEW80), final test modes are considering the modulation and worse data rates. Only the data of worst case is recorded in the report.
Final test	06	TX mode (U-NII-2A)_Keep the EUT in continuously transmitting mode with all modulation types. All data rates for each modulation type have been tested and found the data rate @ 6Mbps is the worst case of IEEE 802.11a; data rate @ MCS0 is the worst case of IEEE 802.11n(HT20); data rate @ MCS0 is the worst case of IEEE 802.11n(HT40); data rate @ MCS0 is the worst case of IEEE 802.11ac(VHT20); data rate @ MCS0 is the worst case of IEEE 802.11ac(VHT40); data rate @ MCS0 is the worst case of IEEE 802.11ac(VHT80), data rate @ MCS0 is the worst case of IEEE 802.11ax(HEW20); data rate @ MCS0 is the worst case of IEEE 802.11ax(HEW40); data rate @ MCS0 is the worst case of IEEE 802.11ax(HEW80), final test modes are considering the modulation and worse data rates. Only the data of worst case is recorded in the report.
Final test	07	TX mode (U-NII-2C)_Keep the EUT in continuously transmitting mode with all modulation types. All data rates for each modulation type have been tested and found the data rate @ 6Mbps is the worst case of IEEE 802.11a; data rate @ MCS0 is the worst case of IEEE 802.11n(HT20); data rate @ MCS0 is the worst case of IEEE 802.11n(HT40); data rate @ MCS0 is the worst case of IEEE 802.11ac(VHT20); data rate @ MCS0 is the worst case of IEEE 802.11ac(VHT40); data rate @ MCS0 is the worst case of IEEE 802.11ac(VHT80) , data rate @ MCS0 is the worst case of IEEE 802.11ax(HEW20); data rate @ MCS0 is the worst case of IEEE 802.11ax(HEW40); data rate @ MCS0 is the worst case of IEEE 802.11ax(HEW80). Only the data of worst case is recorded in the report.
Final test	08	TX mode (U-NII-3)_Keep the EUT in continuously transmitting mode with all modulation types. All data rates for each modulation type have been tested and found the data rate @ 6Mbps is the worst case of IEEE 802.11a; data rate @ MCS0 is the worst case of IEEE 802.11n(HT20); data rate @ MCS0 is the worst case of IEEE 802.11n(HT40); data rate @ MCS0 is the worst case of IEEE 802.11ac(VHT20); data rate @ MCS0 is the worst case of IEEE 802.11ac(VHT40); data rate @ MCS0 is the worst case of IEEE 802.11ac(VHT80); data rate @ MCS0 is the worst case of IEEE 802.11ax(HEW20); data rate @ MCS0 is the worst case of IEEE 802.11ax(HEW40); data rate @ MCS0 is the worst case of IEEE 802.11ax(HEW80), final test modes are considering the modulation and worse data rates. Only the data of worst case is recorded in the report.



Unless otherwise agreed in writing, this document is issued by the Company subject to its General Conditions of Service printed overleaf, available on request or accessible at <https://www.sgs.com/en/Terms-and-Conditions>. Attention is drawn to the limitation of liability, indemnification and jurisdiction issues defined therein. Any holder of this document is advised that information contained hereon reflects the Company's findings at the time of its intervention only and within the limits of Client's instructions, if any. The Company's sole responsibility is to its Client and this document does not exonerate parties to a transaction from exercising all their rights and obligations under the transaction documents. This document cannot be reproduced except in full, without prior written approval of the Company. Any unauthorized alteration, forgery or falsification of the content or appearance of this document is unlawful and offenders may be prosecuted to the fullest extent of the law. Unless otherwise stated the results shown in this test report refer only to the sample(s) tested and such sample(s) are retained for 30 days only.

Attention: To check the authenticity of testing /inspection report & certificate, please contact us at telephone: (86-755) 8307 1443, or email: CN.Doccheck@sgs.com

SGS-CSTC Standards Technical Services Co., Ltd. Shenzhen Branch
 No.1 Workshop, M-10, Middle Section, Science & Technology Park, Nanshan District, Shenzhen, Guangdong, China 518057 t (86-755) 26012053 f (86-755) 26710594 www.sgsgroup.com.cn
 中国·广东·深圳市南山区科技园中区M-10栋1号厂房 邮编: 518057 t (86-755) 26012053 f (86-755) 26710594 sgs.china@sgs.com

7.4.3 Test Setup Diagram

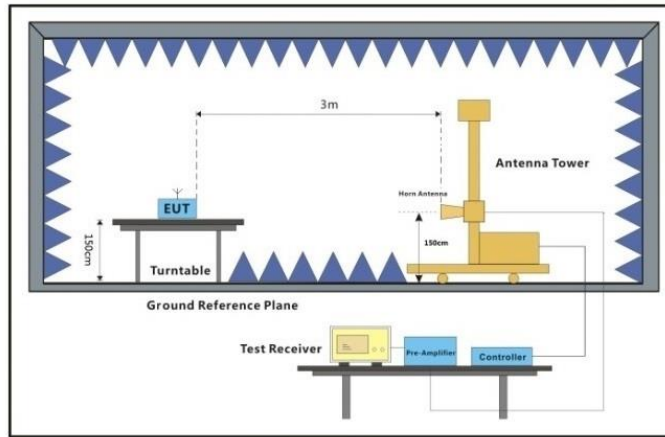

Above 1GHz



7.4.4 Measurement Procedure and Data

- a. For above 1GHz, the EUT was placed on the top of a rotating table 1.5 meters above the ground at a 3 meter fully-anechoic chamber. The table was rotated 360 degrees to determine the position of the highest radiation.
- b. The EUT was set 3 meters away from the interference-receiving antenna, which was mounted on the top of a variable-height antenna tower.
- c. The antenna height is varied from one meter to four meters above the ground to determine the maximum value of the field strength. Both horizontal and vertical polarizations of the antenna are set to make the measurement.
- d. For each suspected emission, the EUT was arranged to its worst case and then the antenna was tuned to heights from 1 meter to 4 meters (for the test frequency of below 30MHz, the antenna was tuned to heights 1 meter) and the rotatable table was turned from 0 degrees to 360 degrees to find the maximum reading.
- e. The test-receiver system was set to Peak Detect Function and Specified Bandwidth with Maximum Hold Mode.
- f. If the emission level of the EUT in peak mode was 10dB lower than the limit specified, then testing could be stopped and the peak values of the EUT would be reported. Otherwise the emissions that did not have 10dB margin would be re-tested one by one using peak or average method as specified and then reported in a data sheet.
- g. Test the EUT in the lowest channel, the middle channel, the Highest channel.
- h. The radiation measurements are performed in X, Y, Z axis positioning for Transmitting mode, and found the X axis positioning which it is the worst case.
- i. Repeat above procedures until all frequencies measured was complete.

Remark:

- 1. Level= Read Level+ Cable Loss+ Antenna Factor- Preamp Factor
- 2. Scan from 18GHz to 40GHz, the disturbance above 18GHz was very low. The points marked on above plots are the highest emissions could be found when testing, so only above points had been displayed. The amplitude of spurious emissions from the radiator which are attenuated more than 20dB below the limit need not be reported.
- 3. As shown in this section, for frequencies above 1GHz, the field strength limits are based on average limits. However, the peak field strength of any emission shall not exceed the maximum permitted average limits specified above by more than 20 dB under any condition of modulation. For the emissions whose peak level is lower than the average limit, only the peak measurement is shown in the report.
- 4. The disturbance above 18GHz were very low and the harmonics were the highest point could be found when testing, so only the above harmonics had been displayed.
- 5. For devices with multiple operating modes, measurements on the middle channel is used to determine the worst-case mode(s). Only the worst case mode with the highest output power and the mode with the highest output power spectral density for each modulation family (e.g., OFDM and direct sequence spread spectrum) is recorded in the test report.



Test Mode: 05; Polarity: Horizontal; Modulation:802.11a; Bandwidth:20MHz; Channel:Low

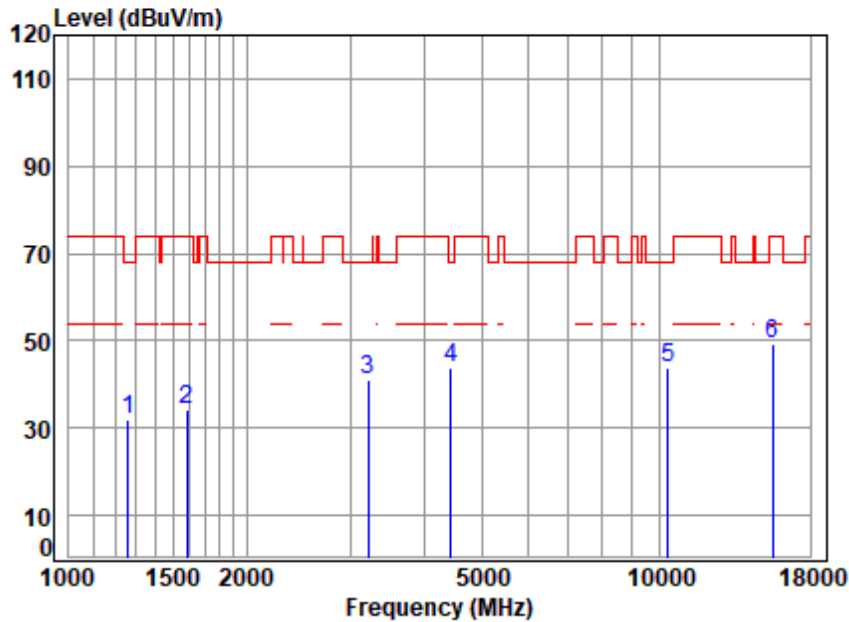

Site : chamber
 Condition: 3m HORIZONTAL
 Job No : 03018AT\03019AT
 Mode : 5180 TX RSE
 Note : 5G WIFI 11A

	Freq	Cable Loss	Ant Factor	Preamp Factor	Read Level	Level	Limit	Over	Remark
	MHz	dB	dB/m	dB	dBuV	dBuV/m	dBuV/m	dB	
1	1260.149	3.76	25.04	61.58	64.77	31.99	68.20	-36.21	peak
2	1583.392	4.16	26.87	61.68	64.89	34.24	74.00	-39.76	peak
3	3214.623	6.27	32.67	61.36	63.59	41.17	68.20	-27.03	peak
4	4430.628	7.17	34.43	61.57	63.61	43.64	68.20	-24.56	peak
5	10360.000	11.14	37.10	62.35	57.82	43.71	68.20	-24.49	peak
6	15540.000	13.79	41.10	62.88	57.39	49.40	74.00	-24.60	peak



Unless otherwise agreed in writing, this document is issued by the Company subject to its General Conditions of Service printed overleaf, available on request or accessible at <https://www.sgs.com/en/Terms-and-Conditions>. Attention is drawn to the limitation of liability, indemnification and jurisdiction issues defined therein. Any holder of this document is advised that information contained hereon reflects the Company's findings at the time of its intervention only and within the limits of Client's instructions, if any. The Company's sole responsibility is to its Client and this document does not exonerate parties to a transaction from exercising all their rights and obligations under the transaction documents. This document cannot be reproduced except in full, without prior written approval of the Company. Any unauthorized alteration, forgery or falsification of the content or appearance of this document is unlawful and offenders may be prosecuted to the fullest extent of the law. Unless otherwise stated the results shown in this test report refer only to the sample(s) tested and such sample(s) are retained for 30 days only.

Test Mode: 05; Polarity: Vertical; Modulation:802.11a; Bandwidth:20MHz; Channel:Low

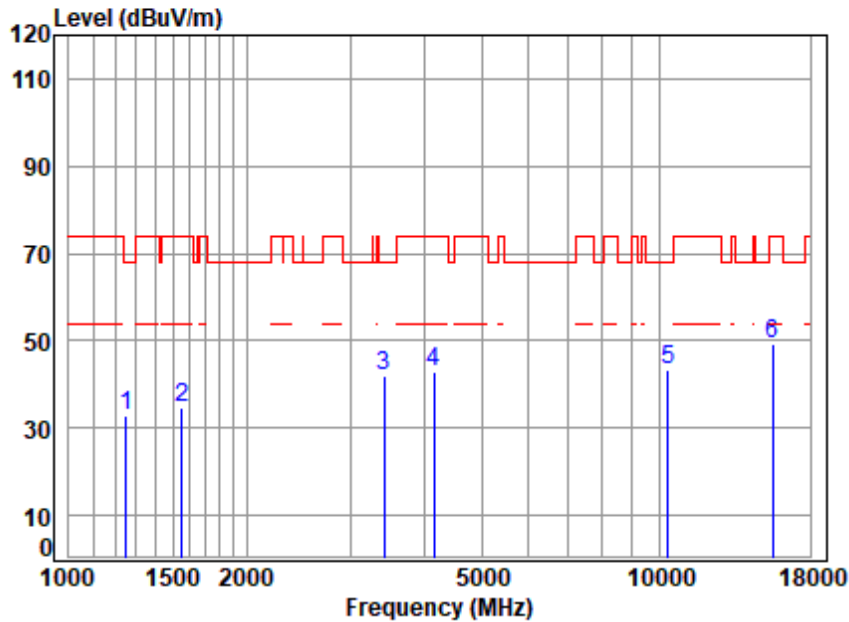

Site : chamber
 Condition: 3m VERTICAL
 Job No : 03018AT\03019AT
 Mode : 5180 TX RSE
 Note : 5G WIFI 11A

	Freq	Cable Loss	Ant Factor	Preamp Factor	Read Level	Level	Limit	Over	Remark
	MHz	dB	dB/m	dB	dBuV	dBuV/m	dBuV/m	dB	
1	1252.885	3.75	25.08	61.57	65.44	32.70	68.20	-35.50	peak
2	1551.677	4.12	26.99	61.67	65.35	34.79	74.00	-39.21	peak
3	3415.787	6.45	32.21	61.31	64.51	41.86	68.20	-26.34	peak
4	4157.664	6.85	33.80	61.32	63.60	42.93	74.00	-31.07	peak
5	10360.000	11.14	37.10	62.35	57.63	43.52	68.20	-24.68	peak
6	15540.000	13.79	41.10	62.88	57.22	49.23	74.00	-24.77	peak



Unless otherwise agreed in writing, this document is issued by the Company subject to its General Conditions of Service printed overleaf, available on request or accessible at <https://www.sgs.com/en/Terms-and-Conditions>. Attention is drawn to the limitation of liability, indemnification and jurisdiction issues defined therein. Any holder of this document is advised that information contained hereon reflects the Company's findings at the time of its intervention only and within the limits of Client's instructions, if any. The Company's sole responsibility is to its Client and this document does not exonerate parties to a transaction from exercising all their rights and obligations under the transaction documents. This document cannot be reproduced except in full, without prior written approval of the Company. Any unauthorized alteration, forgery or falsification of the content or appearance of this document is unlawful and offenders may be prosecuted to the fullest extent of the law. Unless otherwise stated the results shown in this test report refer only to the sample(s) tested and such sample(s) are retained for 30 days only.

Test Mode: 05; Polarity: Horizontal; Modulation:802.11a; Bandwidth:20MHz; Channel:middle

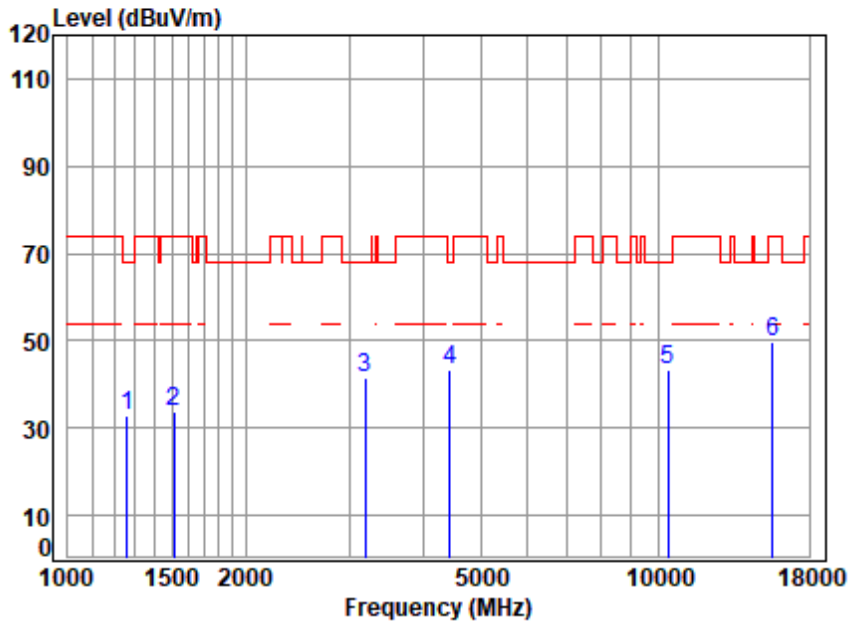

Site : chamber
 Condition: 3m HORIZONTAL
 Job No : 03018AT\03019AT
 Mode : 5200 TX RSE
 Note : 5G WIFI 11A

	Freq	Cable Loss	Ant Factor	Preamp Factor	Read Level	Level	Limit Line	Over Limit	Remark
	MHz	dB	dB/m	dB	dBuV	dBuV/m	dBuV/m	dB	
1	1260.149	3.76	25.04	61.58	65.81	33.03	68.20	-35.17	peak
2	1511.833	4.06	26.85	61.66	64.54	33.79	74.00	-40.21	peak
3	3186.869	6.25	32.79	61.37	64.02	41.69	68.20	-26.51	peak
4	4430.628	7.17	34.43	61.57	63.22	43.25	68.20	-24.95	peak
5	10400.000	11.20	37.10	62.36	57.61	43.55	68.20	-24.65	peak
6	p15600.000	13.86	41.10	62.89	57.60	49.67	74.00	-24.33	peak



Unless otherwise agreed in writing, this document is issued by the Company subject to its General Conditions of Service printed overleaf, available on request or accessible at <https://www.sgs.com/en/Terms-and-Conditions>. Attention is drawn to the limitation of liability, indemnification and jurisdiction issues defined therein. Any holder of this document is advised that information contained hereon reflects the Company's findings at the time of its intervention only and within the limits of Client's instructions, if any. The Company's sole responsibility is to its Client and this document does not exonerate parties to a transaction from exercising all their rights and obligations under the transaction documents. This document cannot be reproduced except in full, without prior written approval of the Company. Any unauthorized alteration, forgery or falsification of the content or appearance of this document is unlawful and offenders may be prosecuted to the fullest extent of the law. Unless otherwise stated the results shown in this test report refer only to the sample(s) tested and such sample(s) are retained for 30 days only.

Test Mode: 05; Polarity: Vertical; Modulation:802.11a; Bandwidth:20MHz; Channel:middle

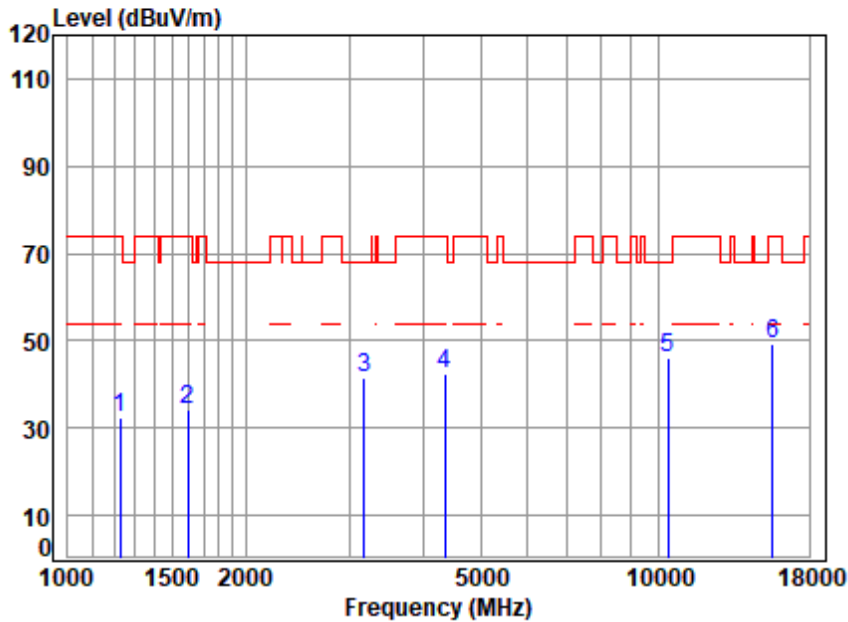

Site : chamber
 Condition: 3m VERTICAL
 Job No : 03018AT\03019AT
 Mode : 5200 TX RSE
 Note : 5G WIFI 11A

	Freq	Cable Loss	Ant Factor	Preamp Factor	Read Level	Level	Limit	Over	Remark
	MHz	dB	dB/m	dB	dBuV	dBuV/m	dBuV/m	dB	
1	1227.791	3.72	24.79	61.56	65.47	32.42	74.00	-41.58	peak
2	1597.181	4.18	26.81	61.69	65.02	34.32	74.00	-39.68	peak
3	3177.672	6.24	32.72	61.37	63.88	41.47	68.20	-26.73	peak
4	4354.454	7.08	34.44	61.50	62.54	42.56	74.00	-31.44	peak
5	10400.000	11.20	37.10	62.36	59.96	45.90	68.20	-22.30	peak
6	15600.000	13.86	41.10	62.89	57.39	49.46	74.00	-24.54	peak



Unless otherwise agreed in writing, this document is issued by the Company subject to its General Conditions of Service printed overleaf, available on request or accessible at <https://www.sgs.com/en/Terms-and-Conditions>. Attention is drawn to the limitation of liability, indemnification and jurisdiction issues defined therein. Any holder of this document is advised that information contained hereon reflects the Company's findings at the time of its intervention only and within the limits of Client's instructions, if any. The Company's sole responsibility is to its Client and this document does not exonerate parties to a transaction from exercising all their rights and obligations under the transaction documents. This document cannot be reproduced except in full, without prior written approval of the Company. Any unauthorized alteration, forgery or falsification of the content or appearance of this document is unlawful and offenders may be prosecuted to the fullest extent of the law. Unless otherwise stated the results shown in this test report refer only to the sample(s) tested and such sample(s) are retained for 30 days only.

Test Mode: 05; Polarity: Horizontal; Modulation:802.11a; Bandwidth:20MHz; Channel:High

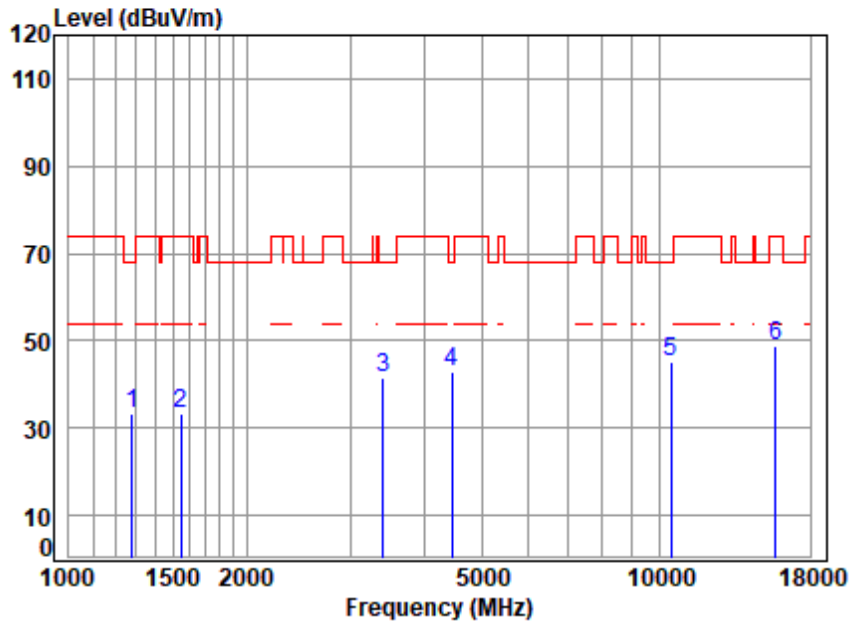

Site : chamber
 Condition: 3m HORIZONTAL
 Job No : 03018AT\03019AT
 Mode : 5240 TX RSE
 Note : 5G WIFI 11A

	Freq	Cable Loss	Ant Factor	Preamp Factor	Read Level	Level	Limit Line	Over Limit	Remark
	MHz	dB	dB/m	dB	dBuV	dBuV/m	dBuV/m	dB	
1	1278.492	3.78	24.93	61.58	66.06	33.19	68.20	-35.01	peak
2	1547.199	4.11	26.99	61.67	64.04	33.47	74.00	-40.53	peak
3	3405.929	6.44	32.33	61.31	64.20	41.66	68.20	-26.54	peak
4	4456.315	7.20	34.12	61.59	63.13	42.86	68.20	-25.34	peak
5	10480.000	11.33	37.26	62.38	59.03	45.24	68.20	-22.96	peak
6	15720.000	14.01	41.22	62.91	56.64	48.96	74.00	-25.04	peak



Unless otherwise agreed in writing, this document is issued by the Company subject to its General Conditions of Service printed overleaf, available on request or accessible at <https://www.sgs.com/en/Terms-and-Conditions>. Attention is drawn to the limitation of liability, indemnification and jurisdiction issues defined therein. Any holder of this document is advised that information contained hereon reflects the Company's findings at the time of its intervention only and within the limits of Client's instructions, if any. The Company's sole responsibility is to its Client and this document does not exonerate parties to a transaction from exercising all their rights and obligations under the transaction documents. This document cannot be reproduced except in full, without prior written approval of the Company. Any unauthorized alteration, forgery or falsification of the content or appearance of this document is unlawful and offenders may be prosecuted to the fullest extent of the law. Unless otherwise stated the results shown in this test report refer only to the sample(s) tested and such sample(s) are retained for 30 days only.

Test Mode: 05; Polarity: Vertical; Modulation:802.11a; Bandwidth:20MHz; Channel:High

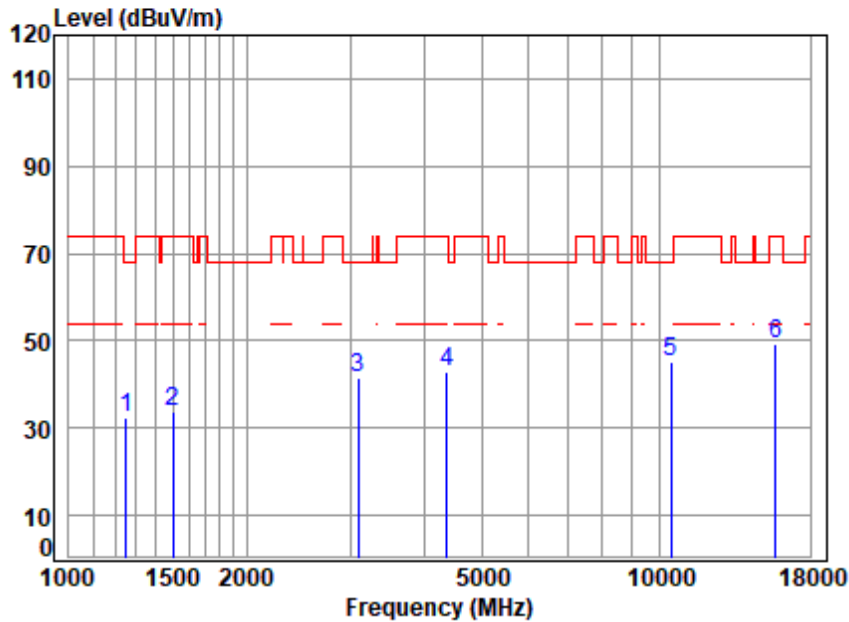

Site : chamber
 Condition: 3m VERTICAL
 Job No : 03018AT\03019AT
 Mode : 5240 TX RSE
 Note : 5G WIFI 11A

	Freq	Cable Loss	Ant Factor	Preamp Factor	Read Level	Level	Limit Line	Over Limit	Remark
	MHz	dB	dB/m	dB	dBuV	dBuV/m	dBuV/m	dB	
1	1249.269	3.75	25.09	61.57	65.28	32.55	68.20	-35.65	peak
2	1503.119	4.04	26.81	61.66	64.36	33.55	74.00	-40.45	peak
3	3087.140	6.15	31.24	61.40	65.54	41.53	68.20	-26.67	peak
4	4367.058	7.10	34.54	61.51	62.66	42.79	74.00	-31.21	peak
5	10480.000	11.33	37.26	62.38	58.80	45.01	68.20	-23.19	peak
6	15720.000	14.01	41.22	62.91	57.15	49.47	74.00	-24.53	peak



Unless otherwise agreed in writing, this document is issued by the Company subject to its General Conditions of Service printed overleaf, available on request or accessible at <https://www.sgs.com/en/Terms-and-Conditions>. Attention is drawn to the limitation of liability, indemnification and jurisdiction issues defined therein. Any holder of this document is advised that information contained hereon reflects the Company's findings at the time of its intervention only and within the limits of Client's instructions, if any. The Company's sole responsibility is to its Client and this document does not exonerate parties to a transaction from exercising all their rights and obligations under the transaction documents. This document cannot be reproduced except in full, without prior written approval of the Company. Any unauthorized alteration, forgery or falsification of the content or appearance of this document is unlawful and offenders may be prosecuted to the fullest extent of the law. Unless otherwise stated the results shown in this test report refer only to the sample(s) tested and such sample(s) are retained for 30 days only.

Test Mode: 05; Polarity: Horizontal; Modulation:802.11n; Bandwidth:20MHz; Channel:Low

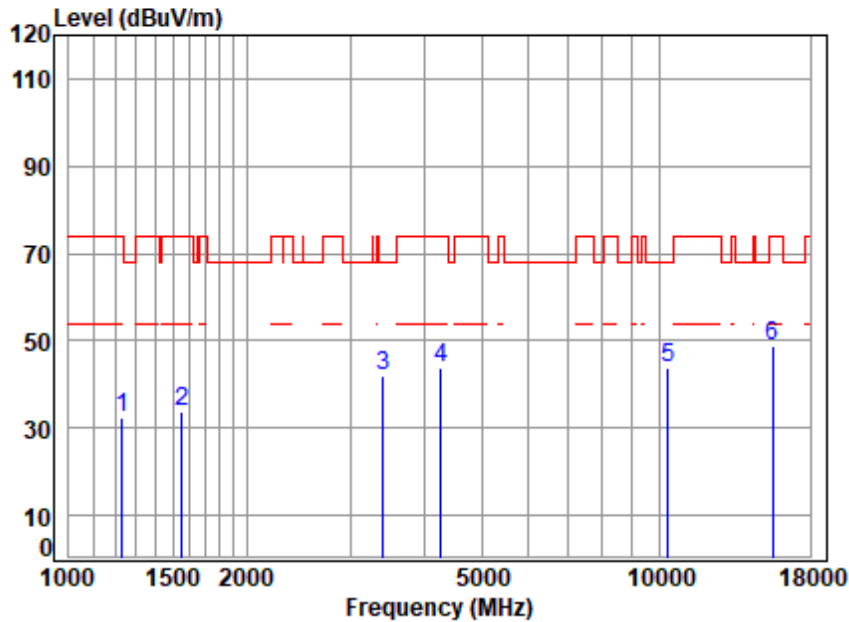

Site : chamber
 Condition: 3m HORIZONTAL
 Job No : 03018AT\03019AT
 Mode : 5180 TX RSE
 Note : 5G WIFI 11N20

	Freq	Cable Loss	Ant Factor	Preamp Factor	Read Level	Limit Level	Over Limit	Remark
	MHz	dB	dB/m	dB	dBuV	dBuV/m	dBuV/m	dB
1	1231.345	3.72	24.84	61.57	65.62	32.61	74.00	-41.39 peak
2	1556.169	4.12	26.98	61.67	64.32	33.75	74.00	-40.25 peak
3	3405.929	6.44	32.33	61.31	64.41	41.87	68.20	-26.33 peak
4	4267.237	6.98	33.87	61.42	64.17	43.60	74.00	-30.40 peak
5	10360.000	11.14	37.10	62.35	57.93	43.82	68.20	-24.38 peak
6	15540.000	13.79	41.10	62.88	56.84	48.85	74.00	-25.15 peak



Unless otherwise agreed in writing, this document is issued by the Company subject to its General Conditions of Service printed overleaf, available on request or accessible at <https://www.sgs.com/en/Terms-and-Conditions>. Attention is drawn to the limitation of liability, indemnification and jurisdiction issues defined therein. Any holder of this document is advised that information contained hereon reflects the Company's findings at the time of its intervention only and within the limits of Client's instructions, if any. The Company's sole responsibility is to its Client and this document does not exonerate parties to a transaction from exercising all their rights and obligations under the transaction documents. This document cannot be reproduced except in full, without prior written approval of the Company. Any unauthorized alteration, forgery or falsification of the content or appearance of this document is unlawful and offenders may be prosecuted to the fullest extent of the law. Unless otherwise stated the results shown in this test report refer only to the sample(s) tested and such sample(s) are retained for 30 days only.

Test Mode: 05; Polarity: Vertical; Modulation:802.11n; Bandwidth:20MHz; Channel:Low

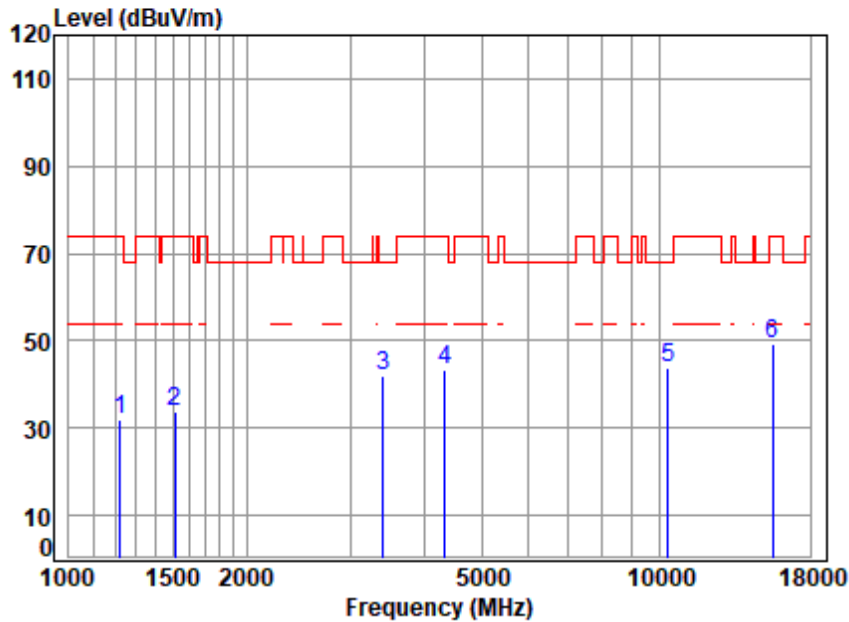

Site : chamber
 Condition: 3m VERTICAL
 Job No : 03018AT\03019AT
 Mode : 5180 TX RSE
 Note : 5G WIFI 11N20

	Freq	Cable Loss	Ant Factor	Preamp Factor	Read Level	Level	Limit Line	Over Limit	Remark
	MHz	dB	dB/m	dB	dBuV	dBuV/m	dBuV/m	dB	
1	1220.714	3.71	24.69	61.56	64.95	31.79	74.00	-42.21	peak
2	1511.833	4.06	26.85	61.66	64.32	33.57	74.00	-40.43	peak
3	3405.929	6.44	32.33	61.31	64.52	41.98	68.20	-26.22	peak
4	4341.886	7.07	34.34	61.49	63.30	43.22	74.00	-30.78	peak
5	10360.000	11.14	37.10	62.35	57.81	43.70	68.20	-24.50	peak
6	15540.000	13.79	41.10	62.88	57.19	49.20	74.00	-24.80	peak



Unless otherwise agreed in writing, this document is issued by the Company subject to its General Conditions of Service printed overleaf, available on request or accessible at <https://www.sgs.com/en/Terms-and-Conditions>. Attention is drawn to the limitation of liability, indemnification and jurisdiction issues defined therein. Any holder of this document is advised that information contained hereon reflects the Company's findings at the time of its intervention only and within the limits of Client's instructions, if any. The Company's sole responsibility is to its Client and this document does not exonerate parties to a transaction from exercising all their rights and obligations under the transaction documents. This document cannot be reproduced except in full, without prior written approval of the Company. Any unauthorized alteration, forgery or falsification of the content or appearance of this document is unlawful and offenders may be prosecuted to the fullest extent of the law. Unless otherwise stated the results shown in this test report refer only to the sample(s) tested and such sample(s) are retained for 30 days only.

Test Mode: 05; Polarity: Horizontal; Modulation:802.11n; Bandwidth:20MHz; Channel:middle

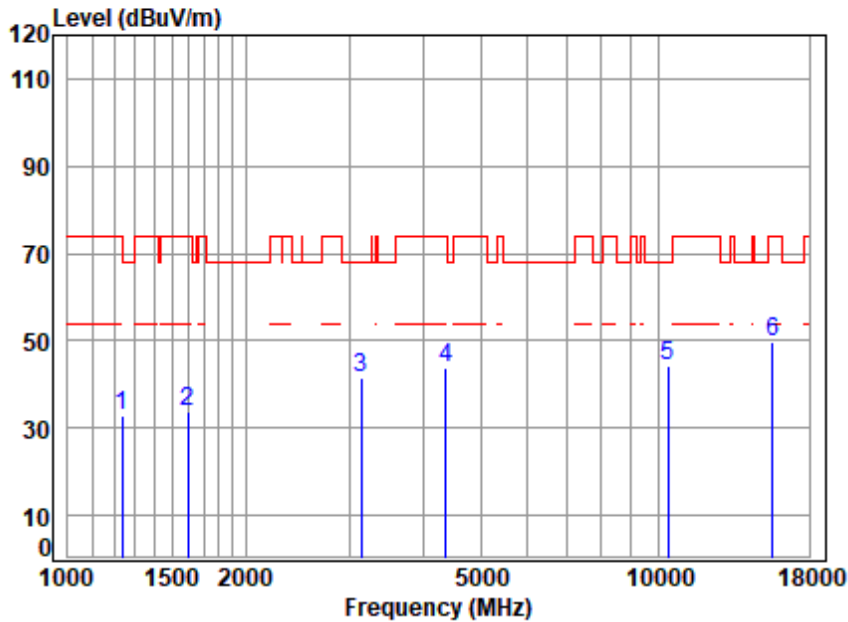

Site : chamber
 Condition: 3m HORIZONTAL
 Job No : 03018AT\03019AT
 Mode : 5200 TX RSE
 Note : 5G WIFI 11N20

	Freq	Cable Loss	Ant Factor	Preamp Factor	Read Level	Level	Limit Line	Over Limit	Remark
	MHz	dB	dB/m	dB	dBuV	dBuV/m	dBuV/m	dB	
1	1234.909	3.73	24.89	61.57	65.90	32.95	74.00	-41.05	peak
2	1597.181	4.18	26.81	61.69	64.36	33.66	74.00	-40.34	peak
3	3141.145	6.20	32.34	61.38	64.37	41.53	68.20	-26.67	peak
4	4367.058	7.10	34.54	61.51	63.86	43.99	74.00	-30.01	peak
5	10400.000	11.20	37.10	62.36	58.25	44.19	68.20	-24.01	peak
6	15600.000	13.86	41.10	62.89	57.73	49.80	74.00	-24.20	peak



Unless otherwise agreed in writing, this document is issued by the Company subject to its General Conditions of Service printed overleaf, available on request or accessible at <https://www.sgs.com/en/Terms-and-Conditions>. Attention is drawn to the limitation of liability, indemnification and jurisdiction issues defined therein. Any holder of this document is advised that information contained hereon reflects the Company's findings at the time of its intervention only and within the limits of Client's instructions, if any. The Company's sole responsibility is to its Client and this document does not exonerate parties to a transaction from exercising all their rights and obligations under the transaction documents. This document cannot be reproduced except in full, without prior written approval of the Company. Any unauthorized alteration, forgery or falsification of the content or appearance of this document is unlawful and offenders may be prosecuted to the fullest extent of the law. Unless otherwise stated the results shown in this test report refer only to the sample(s) tested and such sample(s) are retained for 30 days only.

Test Mode: 05; Polarity: Vertical; Modulation:802.11n; Bandwidth:20MHz; Channel:middle

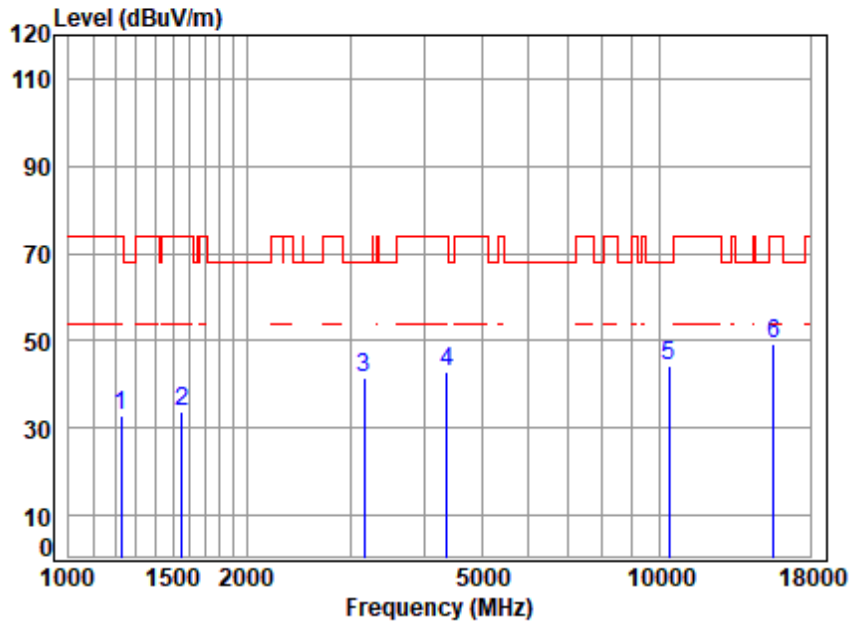

Site : chamber
 Condition: 3m VERTICAL
 Job No : 03018AT\03019AT
 Mode : 5200 TX RSE
 Note : 5G WIFI 11N20

	Freq	Cable Loss	Ant Factor	Preamp Factor	Read Level	Level	Limit	Over	Remark
	MHz	dB	dB/m	dB	dBuV	dBuV/m	dBuV/m	dB	
1	1227.791	3.72	24.79	61.56	65.86	32.81	74.00	-41.19	peak
2	1556.169	4.12	26.98	61.67	64.14	33.57	74.00	-40.43	peak
3	3159.355	6.22	32.57	61.38	64.10	41.51	68.20	-26.69	peak
4	4367.058	7.10	34.54	61.51	62.90	43.03	74.00	-30.97	peak
5	10400.000	11.20	37.10	62.36	58.43	44.37	68.20	-23.83	peak
6	15600.000	13.86	41.10	62.89	57.12	49.19	74.00	-24.81	peak



Unless otherwise agreed in writing, this document is issued by the Company subject to its General Conditions of Service printed overleaf, available on request or accessible at <https://www.sgs.com/en/Terms-and-Conditions>. Attention is drawn to the limitation of liability, indemnification and jurisdiction issues defined therein. Any holder of this document is advised that information contained hereon reflects the Company's findings at the time of its intervention only and within the limits of Client's instructions, if any. The Company's sole responsibility is to its Client and this document does not exonerate parties to a transaction from exercising all their rights and obligations under the transaction documents. This document cannot be reproduced except in full, without prior written approval of the Company. Any unauthorized alteration, forgery or falsification of the content or appearance of this document is unlawful and offenders may be prosecuted to the fullest extent of the law. Unless otherwise stated the results shown in this test report refer only to the sample(s) tested and such sample(s) are retained for 30 days only.

Test Mode: 05; Polarity: Horizontal; Modulation:802.11n; Bandwidth:20MHz; Channel:High

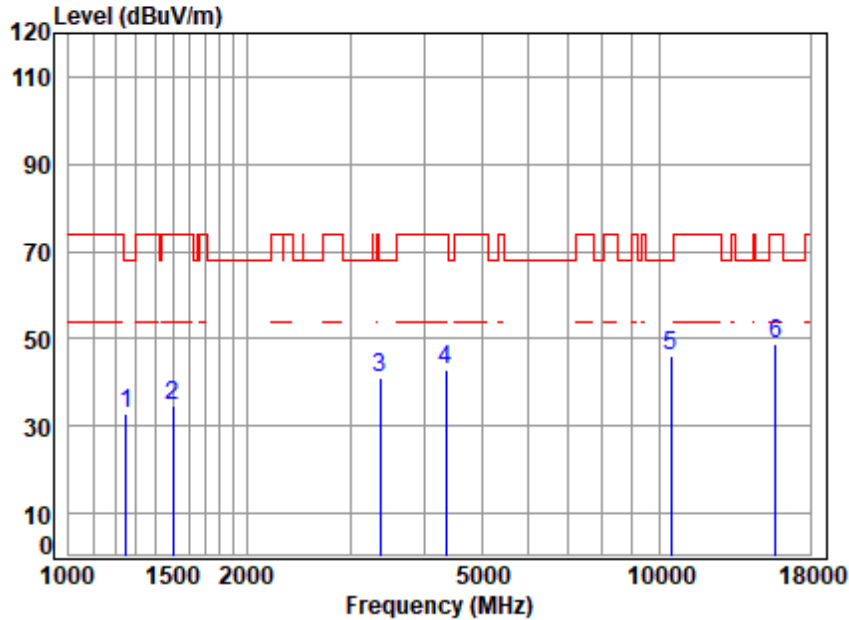

Site : chamber
 Condition: 3m HORIZONTAL
 Job No : 03018AT\03019AT
 Mode : 5240 TX RSE
 Note : 5G WIFI 11N20

	Freq	Cable Loss	Ant Factor	Preamp Factor	Read Level	Level	Limit Line	Over Limit	Remark
	MHz	dB	dB/m	dB	dBuV	dBuV/m	dBuV/m	dB	
1	1252.885	3.75	25.08	61.57	65.71	32.97	68.20	-35.23	peak
2	1503.119	4.04	26.81	61.66	65.44	34.63	74.00	-39.37	peak
3	3366.778	6.41	32.20	61.32	63.66	40.95	68.20	-27.25	peak
4	4354.454	7.08	34.44	61.50	62.79	42.81	74.00	-31.19	peak
5	10480.000	11.33	37.26	62.38	59.83	46.04	68.20	-22.16	peak
6	15720.000	14.01	41.22	62.91	56.70	49.02	74.00	-24.98	peak



Unless otherwise agreed in writing, this document is issued by the Company subject to its General Conditions of Service printed overleaf, available on request or accessible at <https://www.sgs.com/en/Terms-and-Conditions>. Attention is drawn to the limitation of liability, indemnification and jurisdiction issues defined therein. Any holder of this document is advised that information contained hereon reflects the Company's findings at the time of its intervention only and within the limits of Client's instructions, if any. The Company's sole responsibility is to its Client and this document does not exonerate parties to a transaction from exercising all their rights and obligations under the transaction documents. This document cannot be reproduced except in full, without prior written approval of the Company. Any unauthorized alteration, forgery or falsification of the content or appearance of this document is unlawful and offenders may be prosecuted to the fullest extent of the law. Unless otherwise stated the results shown in this test report refer only to the sample(s) tested and such sample(s) are retained for 30 days only.

Test Mode: 05; Polarity: Vertical; Modulation:802.11n; Bandwidth:20MHz; Channel:High

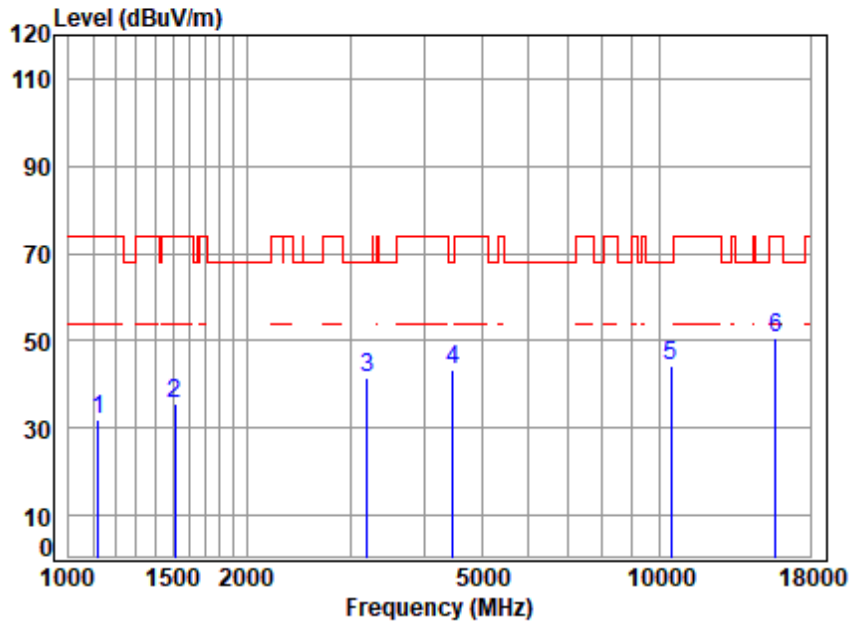

Site : chamber
 Condition: 3m VERTICAL
 Job No : 03018AT\03019AT
 Mode : 5240 TX RSE
 Note : 5G WIFI 11N20

	Freq	Cable Loss	Ant Factor	Preamp Factor	Read Level	Level	Limit	Over	Remark
	MHz	dB	dB/m	dB	dBuV	dBuV/m	dBuV/m	dB	
1	1122.563	3.58	23.79	61.52	66.18	32.03	74.00	-41.97	peak
2	1511.833	4.06	26.85	61.66	66.21	35.46	74.00	-38.54	peak
3	3196.094	6.25	32.87	61.36	63.72	41.48	68.20	-26.72	peak
4	4469.214	7.22	33.97	61.60	63.80	43.39	68.20	-24.81	peak
5	10480.000	11.33	37.26	62.38	58.12	44.33	68.20	-23.87	peak
6	p15720.000	14.01	41.22	62.91	58.29	50.61	74.00	-23.39	peak



Unless otherwise agreed in writing, this document is issued by the Company subject to its General Conditions of Service printed overleaf, available on request or accessible at <https://www.sgs.com/en/Terms-and-Conditions>. Attention is drawn to the limitation of liability, indemnification and jurisdiction issues defined therein. Any holder of this document is advised that information contained hereon reflects the Company's findings at the time of its intervention only and within the limits of Client's instructions, if any. The Company's sole responsibility is to its Client and this document does not exonerate parties to a transaction from exercising all their rights and obligations under the transaction documents. This document cannot be reproduced except in full, without prior written approval of the Company. Any unauthorized alteration, forgery or falsification of the content or appearance of this document is unlawful and offenders may be prosecuted to the fullest extent of the law. Unless otherwise stated the results shown in this test report refer only to the sample(s) tested and such sample(s) are retained for 30 days only.

Test Mode: 05; Polarity: Horizontal; Modulation:802.11n; Bandwidth:40MHz; Channel:Low

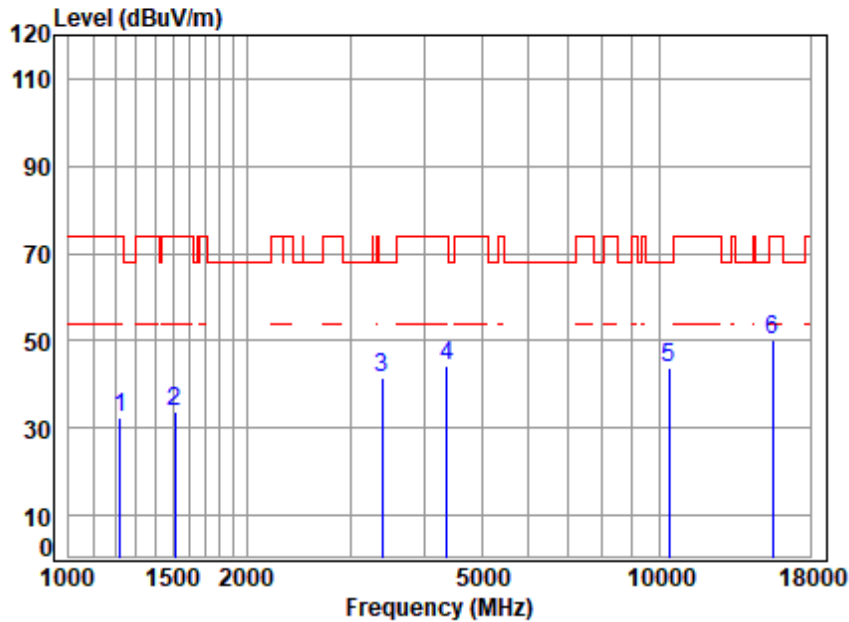

Site : chamber
 Condition: 3m HORIZONTAL
 Job No : 03018AT\03019AT
 Mode : 5190 TX RSE
 Note : 5G WIFI 11N40

	Freq	Cable Loss	Ant Factor	Preamp Factor	Read Level	Level	Limit Line	Over Limit	Remark
	MHz	dB	dB/m	dB	dBuV	dBuV/m	dBuV/m	dB	
1	1224.247	3.71	24.74	61.56	65.32	32.21	74.00	-41.79	peak
2	1511.833	4.06	26.85	61.66	64.43	33.68	74.00	-40.32	peak
3	3396.098	6.43	32.38	61.31	64.05	41.55	68.20	-26.65	peak
4	4367.058	7.10	34.54	61.51	64.09	44.22	74.00	-29.78	peak
5	10380.000	11.17	37.10	62.36	58.05	43.96	68.20	-24.24	peak
6	p15570.000	13.83	41.10	62.89	58.24	50.28	74.00	-23.72	peak



Unless otherwise agreed in writing, this document is issued by the Company subject to its General Conditions of Service printed overleaf, available on request or accessible at <https://www.sgs.com/en/Terms-and-Conditions>. Attention is drawn to the limitation of liability, indemnification and jurisdiction issues defined therein. Any holder of this document is advised that information contained hereon reflects the Company's findings at the time of its intervention only and within the limits of Client's instructions, if any. The Company's sole responsibility is to its Client and this document does not exonerate parties to a transaction from exercising all their rights and obligations under the transaction documents. This document cannot be reproduced except in full, without prior written approval of the Company. Any unauthorized alteration, forgery or falsification of the content or appearance of this document is unlawful and offenders may be prosecuted to the fullest extent of the law. Unless otherwise stated the results shown in this test report refer only to the sample(s) tested and such sample(s) are retained for 30 days only.

Test Mode: 05; Polarity: Vertical; Modulation:802.11n; Bandwidth:40MHz; Channel:Low

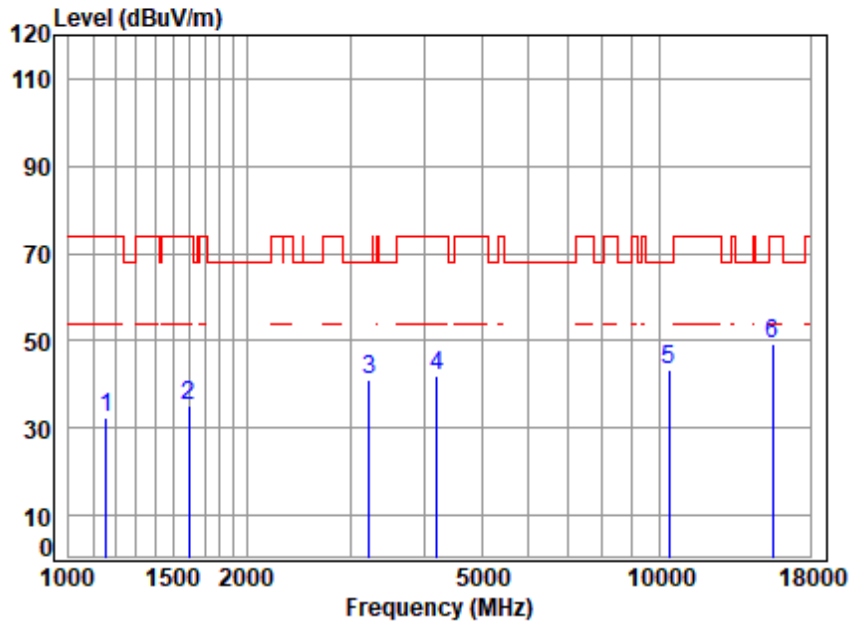

Site : chamber
 Condition: 3m VERTICAL
 Job No : 03018AT\03019AT
 Mode : 5190 TX RSE
 Note : 5G WIFI 11N40

	Cable	Ant	Preamp	Read	Limit	Over		
Freq	Loss	Factor	Factor	Level	Level	Line	Limit	Remark
MHz	dB	dB/m	dB	dBuV	dBuV/m	dBuV/m	dB	
1	1155.483	3.62	23.95	61.54	66.26	32.29	74.00	-41.71 peak
2	1597.181	4.18	26.81	61.69	65.67	34.97	74.00	-39.03 peak
3	3223.928	6.28	32.52	61.36	63.63	41.07	68.20	-27.13 peak
4	4206.011	6.91	33.80	61.37	62.79	42.13	74.00	-31.87 peak
5	10380.000	11.17	37.10	62.36	57.35	43.26	68.20	-24.94 peak
6	p15570.000	13.83	41.10	62.89	57.44	49.48	74.00	-24.52 peak



Unless otherwise agreed in writing, this document is issued by the Company subject to its General Conditions of Service printed overleaf, available on request or accessible at <https://www.sgs.com/en/Terms-and-Conditions>. Attention is drawn to the limitation of liability, indemnification and jurisdiction issues defined therein. Any holder of this document is advised that information contained hereon reflects the Company's findings at the time of its intervention only and within the limits of Client's instructions, if any. The Company's sole responsibility is to its Client and this document does not exonerate parties to a transaction from exercising all their rights and obligations under the transaction documents. This document cannot be reproduced except in full, without prior written approval of the Company. Any unauthorized alteration, forgery or falsification of the content or appearance of this document is unlawful and offenders may be prosecuted to the fullest extent of the law. Unless otherwise stated the results shown in this test report refer only to the sample(s) tested and such sample(s) are retained for 30 days only.

Test Mode: 05; Polarity: Horizontal; Modulation:802.11n; Bandwidth:40MHz; Channel:High

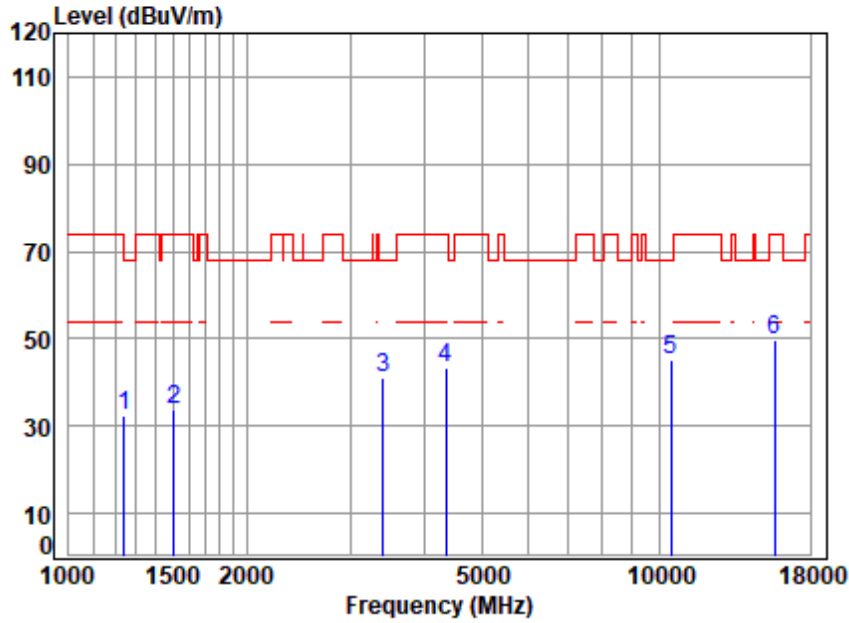

Site : chamber
 Condition: 3m HORIZONTAL
 Job No : 03018AT\03019AT
 Mode : 5230 TX RSE
 Note : 5G WIFI 11N40

	Freq	Cable Loss	Ant Factor	Preamp Factor	Read Level	Level	Limit Line	Over Limit	Remark
	MHz	dB	dB/m	dB	dBuV	dBuV/m	dBuV/m	dB	
1	1242.068	3.74	24.99	61.57	65.14	32.30	68.20	-35.90	peak
2	1507.470	4.05	26.83	61.66	64.64	33.86	74.00	-40.14	peak
3	3405.929	6.44	32.33	61.31	63.56	41.02	68.20	-27.18	peak
4	4354.454	7.08	34.44	61.50	63.20	43.22	74.00	-30.78	peak
5	10460.000	11.30	37.22	62.38	58.90	45.04	68.20	-23.16	peak
6	15690.000	13.97	41.19	62.91	57.35	49.60	74.00	-24.40	peak



Unless otherwise agreed in writing, this document is issued by the Company subject to its General Conditions of Service printed overleaf, available on request or accessible at <https://www.sgs.com/en/Terms-and-Conditions>. Attention is drawn to the limitation of liability, indemnification and jurisdiction issues defined therein. Any holder of this document is advised that information contained hereon reflects the Company's findings at the time of its intervention only and within the limits of Client's instructions, if any. The Company's sole responsibility is to its Client and this document does not exonerate parties to a transaction from exercising all their rights and obligations under the transaction documents. This document cannot be reproduced except in full, without prior written approval of the Company. Any unauthorized alteration, forgery or falsification of the content or appearance of this document is unlawful and offenders may be prosecuted to the fullest extent of the law. Unless otherwise stated the results shown in this test report refer only to the sample(s) tested and such sample(s) are retained for 30 days only.

Test Mode: 05; Polarity: Vertical; Modulation:802.11n; Bandwidth:40MHz; Channel:High

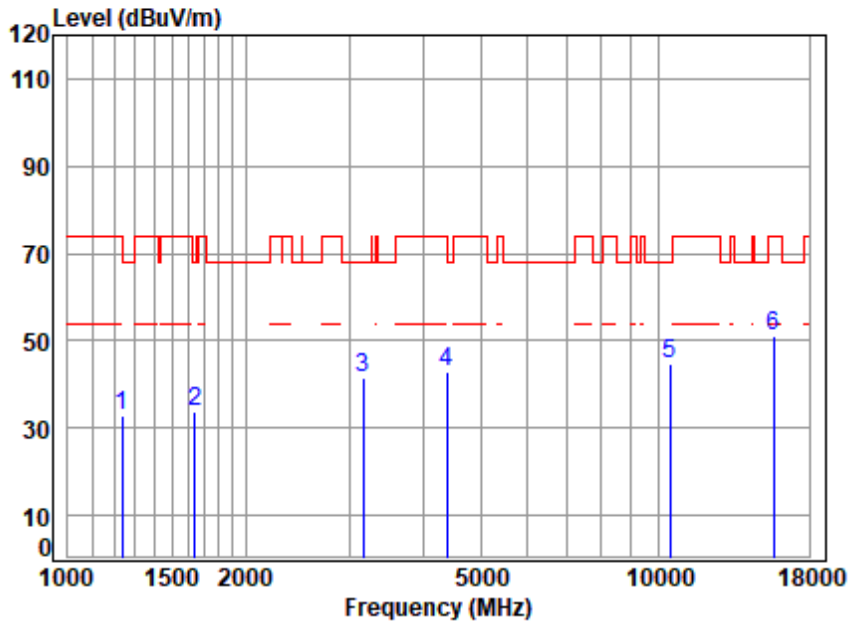

Site : chamber
 Condition: 3m VERTICAL
 Job No : 03018AT\03019AT
 Mode : 5230 TX RSE
 Note : 5G WIFI 11N40

	Freq	Cable Loss	Ant Factor	Preamp Factor	Read Level	Level	Limit Line	Over Limit	Remark
	MHz	dB	dB/m	dB	dBuV	dBuV/m	dBuV/m	dB	
1	1234.909	3.73	24.89	61.57	65.80	32.85	74.00	-41.15	peak
2	1644.019	4.25	26.36	61.70	64.80	33.71	68.20	-34.49	peak
3	3168.500	6.23	32.65	61.37	63.81	41.32	68.20	-26.88	peak
4	4379.699	7.11	34.64	61.52	62.51	42.74	74.00	-31.26	peak
5	10460.000	11.30	37.22	62.38	58.36	44.50	68.20	-23.70	peak
6	p15690.000	13.97	41.19	62.91	58.70	50.95	74.00	-23.05	peak



Unless otherwise agreed in writing, this document is issued by the Company subject to its General Conditions of Service printed overleaf, available on request or accessible at <https://www.sgs.com/en/Terms-and-Conditions>. Attention is drawn to the limitation of liability, indemnification and jurisdiction issues defined therein. Any holder of this document is advised that information contained hereon reflects the Company's findings at the time of its intervention only and within the limits of Client's instructions, if any. The Company's sole responsibility is to its Client and this document does not exonerate parties to a transaction from exercising all their rights and obligations under the transaction documents. This document cannot be reproduced except in full, without prior written approval of the Company. Any unauthorized alteration, forgery or falsification of the content or appearance of this document is unlawful and offenders may be prosecuted to the fullest extent of the law. Unless otherwise stated the results shown in this test report refer only to the sample(s) tested and such sample(s) are retained for 30 days only.

Test Mode: 05; Polarity: Horizontal; Modulation:802.11 ax(Full RU0); Bandwidth:20MHz; Channel:Low

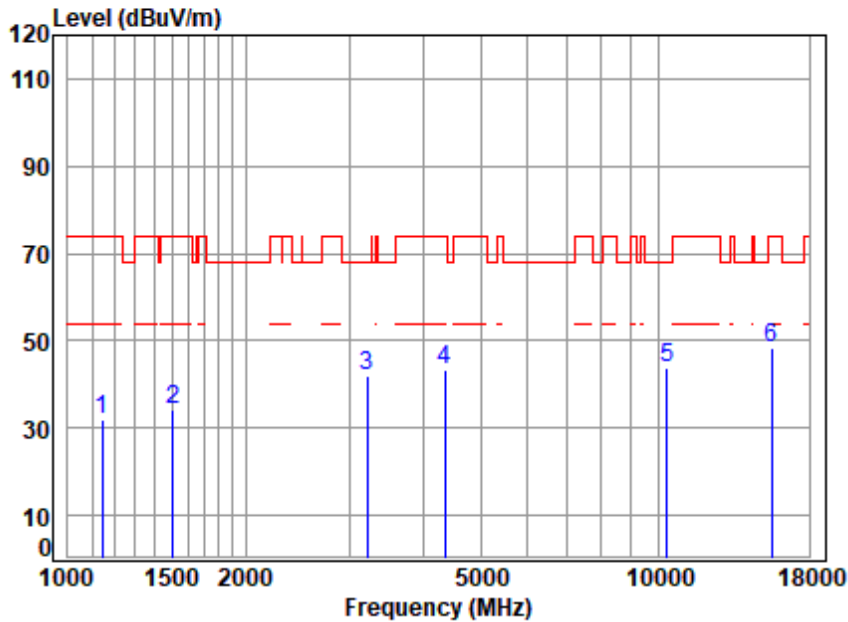

Site : chamber
 Condition: 3m HORIZONTAL
 Job No : 03018AT\03019AT
 Mode : 5180 TX RSE
 Note : 5G WIFI 11AX20

	Freq	Cable Loss	Ant Factor	Preamp Factor	Read Level	Level	Limit Line	Over Limit	Remark
	MHz	dB	dB/m	dB	dBuV	dBuV/m	dBuV/m	dB	
1	1145.507	3.61	23.88	61.53	65.99	31.95	74.00	-42.05	peak
2	1507.470	4.05	26.83	61.66	64.85	34.07	74.00	-39.93	peak
3	3214.623	6.27	32.67	61.36	64.24	41.82	68.20	-26.38	peak
4	4354.454	7.08	34.44	61.50	63.29	43.31	74.00	-30.69	peak
5	10360.000	11.14	37.10	62.35	57.77	43.66	68.20	-24.54	peak
6	15540.000	13.79	41.10	62.88	56.30	48.31	74.00	-25.69	peak



Unless otherwise agreed in writing, this document is issued by the Company subject to its General Conditions of Service printed overleaf, available on request or accessible at <https://www.sgs.com/en/Terms-and-Conditions>. Attention is drawn to the limitation of liability, indemnification and jurisdiction issues defined therein. Any holder of this document is advised that information contained hereon reflects the Company's findings at the time of its intervention only and within the limits of Client's instructions, if any. The Company's sole responsibility is to its Client and this document does not exonerate parties to a transaction from exercising all their rights and obligations under the transaction documents. This document cannot be reproduced except in full, without prior written approval of the Company. Any unauthorized alteration, forgery or falsification of the content or appearance of this document is unlawful and offenders may be prosecuted to the fullest extent of the law. Unless otherwise stated the results shown in this test report refer only to the sample(s) tested and such sample(s) are retained for 30 days only.

Test Mode: 05; Polarity: Vertical; Modulation:802.11ax(Full RU0); Bandwidth:20MHz; Channel:Low

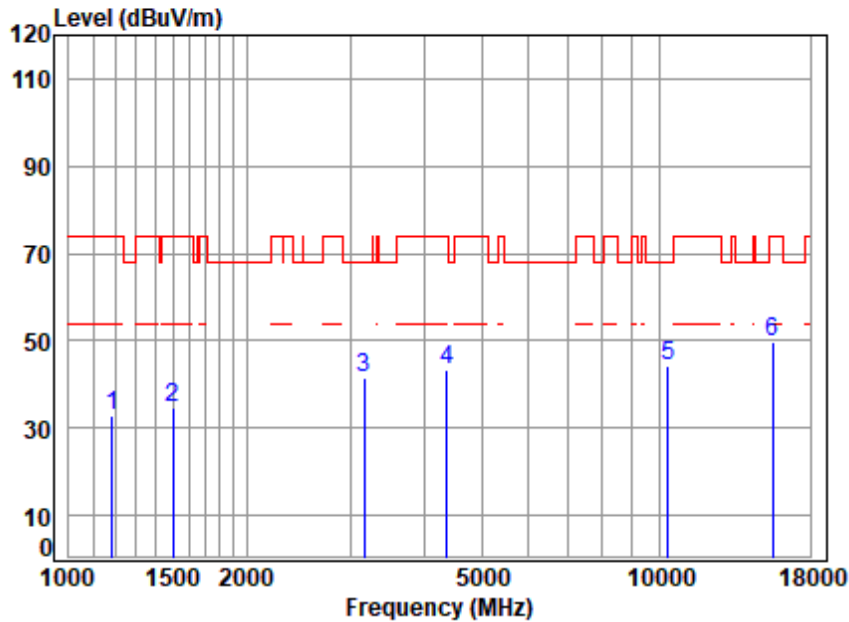

Site : chamber
 Condition: 3m VERTICAL
 Job No : 03018AT\03019AT
 Mode : 5180 TX RSE
 Note : 5G WIFI 11AX20

	Freq	Cable Loss	Ant Factor	Preamp Factor	Read Level	Level	Limit	Over	Remark
	MHz	dB	dB/m	dB	dBuV	dBuV/m	dBuV/m	dB	
1	1185.936	3.66	24.26	61.55	66.29	32.66	74.00	-41.34	peak
2	1503.119	4.04	26.81	61.66	65.67	34.86	74.00	-39.14	peak
3	3168.500	6.23	32.65	61.37	63.82	41.33	68.20	-26.87	peak
4	4367.058	7.10	34.54	61.51	62.99	43.12	74.00	-30.88	peak
5	10360.000	11.14	37.10	62.35	58.36	44.25	68.20	-23.95	peak
6	15540.000	13.79	41.10	62.88	57.88	49.89	74.00	-24.11	peak



Unless otherwise agreed in writing, this document is issued by the Company subject to its General Conditions of Service printed overleaf, available on request or accessible at <https://www.sgs.com/en/Terms-and-Conditions>. Attention is drawn to the limitation of liability, indemnification and jurisdiction issues defined therein. Any holder of this document is advised that information contained hereon reflects the Company's findings at the time of its intervention only and within the limits of Client's instructions, if any. The Company's sole responsibility is to its Client and this document does not exonerate parties to a transaction from exercising all their rights and obligations under the transaction documents. This document cannot be reproduced except in full, without prior written approval of the Company. Any unauthorized alteration, forgery or falsification of the content or appearance of this document is unlawful and offenders may be prosecuted to the fullest extent of the law. Unless otherwise stated the results shown in this test report refer only to the sample(s) tested and such sample(s) are retained for 30 days only.

Test Mode: 05; Polarity: Horizontal; Modulation:802.11ax(Full RU0); Bandwidth:20MHz; Channel:middle

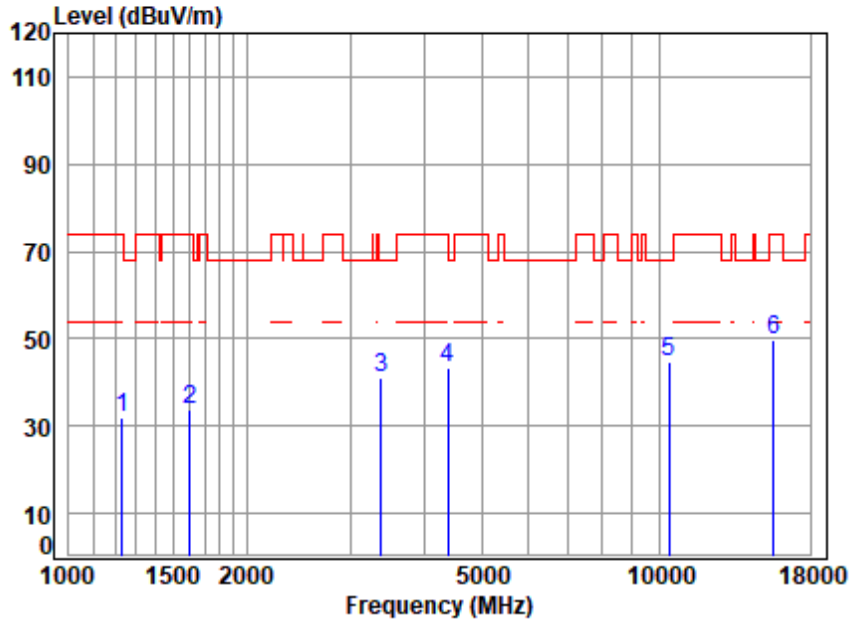

Site : chamber
 Condition: 3m HORIZONTAL
 Job No : 03018AT\03019AT
 Mode : 5200 TX RSE
 Note : 5G WIFI 11AX20

	Freq	Cable Loss	Ant Factor	Preamp Factor	Read Level	Level	Limit Line	Over Limit	Remark
	MHz	dB	dB/m	dB	dBuV	dBuV/m	dBuV/m	dB	
1	1231.345	3.72	24.84	61.57	64.99	31.98	74.00	-42.02	peak
2	1601.804	4.19	26.78	61.69	64.43	33.71	74.00	-40.29	peak
3	3386.297	6.42	32.32	61.31	63.71	41.14	68.20	-27.06	peak
4	4392.376	7.13	34.74	61.53	62.92	43.26	74.00	-30.74	peak
5	10400.000	11.20	37.10	62.36	58.85	44.79	68.20	-23.41	peak
6	15600.000	13.86	41.10	62.89	57.55	49.62	74.00	-24.38	peak



Unless otherwise agreed in writing, this document is issued by the Company subject to its General Conditions of Service printed overleaf, available on request or accessible at <https://www.sgs.com/en/Terms-and-Conditions>. Attention is drawn to the limitation of liability, indemnification and jurisdiction issues defined therein. Any holder of this document is advised that information contained hereon reflects the Company's findings at the time of its intervention only and within the limits of Client's instructions, if any. The Company's sole responsibility is to its Client and this document does not exonerate parties to a transaction from exercising all their rights and obligations under the transaction documents. This document cannot be reproduced except in full, without prior written approval of the Company. Any unauthorized alteration, forgery or falsification of the content or appearance of this document is unlawful and offenders may be prosecuted to the fullest extent of the law. Unless otherwise stated the results shown in this test report refer only to the sample(s) tested and such sample(s) are retained for 30 days only.

Test Mode: 05; Polarity: Vertical; Modulation:802.11ax(Full RU0); Bandwidth:20MHz; Channel:middle

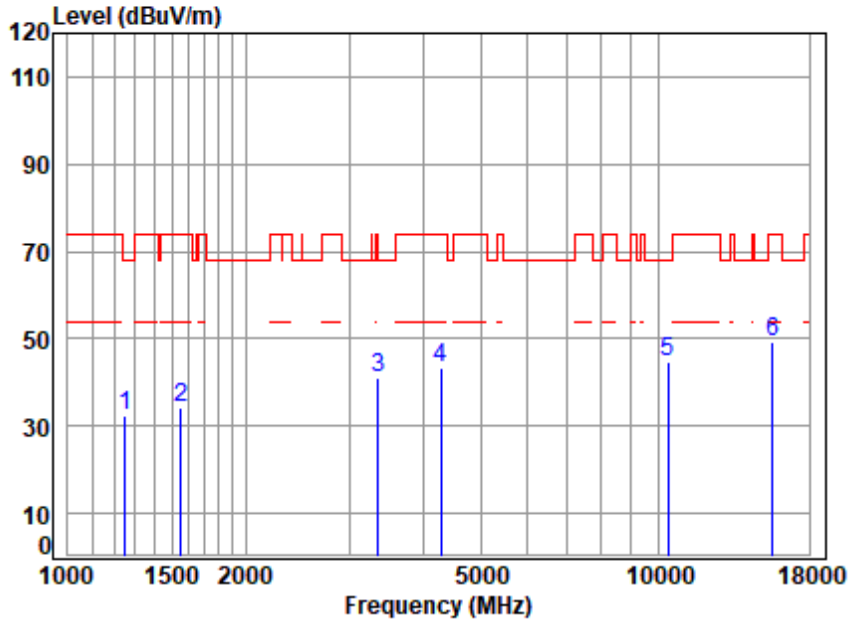

Site : chamber
 Condition: 3m VERTICAL
 Job No : 03018AT\03019AT
 Mode : 5200 TX RSE
 Note : 5G WIFI 11AX20

	Freq	Cable Loss	Ant Factor	Preamp Factor	Read Level	Level	Limit Line	Over Limit	Remark
	MHz	dB	dB/m	dB	dBuV	dBuV/m	dBuV/m	dB	
1	1249.269	3.75	25.09	61.57	65.13	32.40	68.20	-35.80	peak
2	1551.677	4.12	26.99	61.67	64.71	34.15	74.00	-39.85	peak
3	3357.061	6.40	32.14	61.32	63.92	41.14	74.00	-32.86	peak
4	4279.589	6.99	33.92	61.43	63.74	43.22	74.00	-30.78	peak
5	10400.000	11.20	37.10	62.36	58.75	44.69	68.20	-23.51	peak
6	15600.000	13.86	41.10	62.89	57.29	49.36	74.00	-24.64	peak



Unless otherwise agreed in writing, this document is issued by the Company subject to its General Conditions of Service printed overleaf, available on request or accessible at <https://www.sgs.com/en/Terms-and-Conditions>. Attention is drawn to the limitation of liability, indemnification and jurisdiction issues defined therein. Any holder of this document is advised that information contained hereon reflects the Company's findings at the time of its intervention only and within the limits of Client's instructions, if any. The Company's sole responsibility is to its Client and this document does not exonerate parties to a transaction from exercising all their rights and obligations under the transaction documents. This document cannot be reproduced except in full, without prior written approval of the Company. Any unauthorized alteration, forgery or falsification of the content or appearance of this document is unlawful and offenders may be prosecuted to the fullest extent of the law. Unless otherwise stated the results shown in this test report refer only to the sample(s) tested and such sample(s) are retained for 30 days only.

Test Mode: 05; Polarity: Horizontal; Modulation:802.11ax(Full RU0); Bandwidth:20MHz; Channel:High

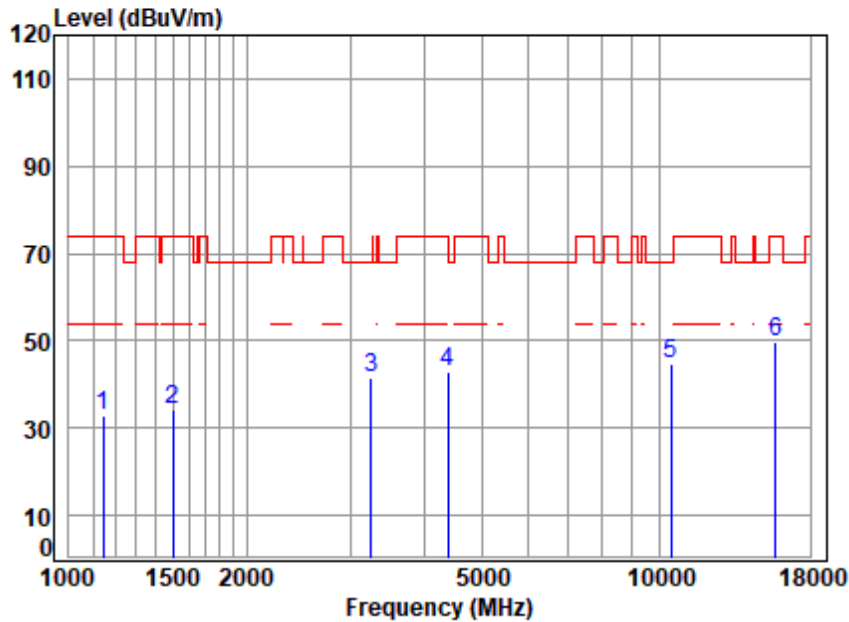

Site : chamber
 Condition: 3m HORIZONTAL
 Job No : 03018AT\03019AT
 Mode : 5240 TX RSE
 Note : 5G WIFI 11AX20

	Freq	Cable Loss	Ant Factor	Preamp Factor	Read Level	Level	Limit Line	Over Limit	Remark
	MHz	dB	dB/m	dB	dBuV	dBuV/m	dBuV/m	dB	
1	1145.507	3.61	23.88	61.53	66.76	32.72	74.00	-41.28	peak
2	1503.119	4.04	26.81	61.66	65.01	34.20	74.00	-39.80	peak
3	3252.005	6.31	32.06	61.35	64.35	41.37	68.20	-26.83	peak
4	4392.376	7.13	34.74	61.53	62.60	42.94	74.00	-31.06	peak
5	10480.000	11.33	37.26	62.38	58.56	44.77	68.20	-23.43	peak
6	15720.000	14.01	41.22	62.91	57.33	49.65	74.00	-24.35	peak



Unless otherwise agreed in writing, this document is issued by the Company subject to its General Conditions of Service printed overleaf, available on request or accessible at <https://www.sgs.com/en/Terms-and-Conditions>. Attention is drawn to the limitation of liability, indemnification and jurisdiction issues defined therein. Any holder of this document is advised that information contained hereon reflects the Company's findings at the time of its intervention only and within the limits of Client's instructions, if any. The Company's sole responsibility is to its Client and this document does not exonerate parties to a transaction from exercising all their rights and obligations under the transaction documents. This document cannot be reproduced except in full, without prior written approval of the Company. Any unauthorized alteration, forgery or falsification of the content or appearance of this document is unlawful and offenders may be prosecuted to the fullest extent of the law. Unless otherwise stated the results shown in this test report refer only to the sample(s) tested and such sample(s) are retained for 30 days only.

Test Mode: 05; Polarity: Vertical; Modulation:802.11ax(Full RU0); Bandwidth:20MHz; Channel:High

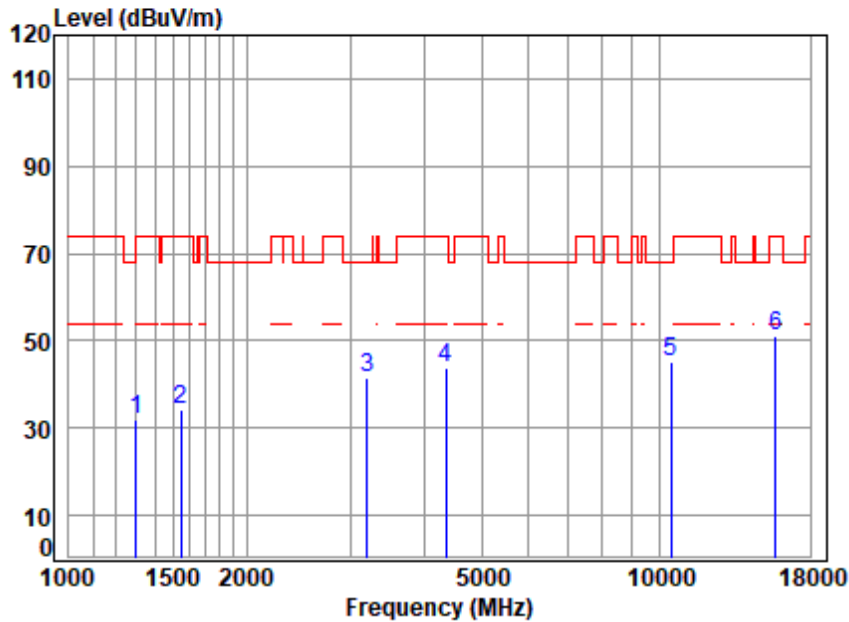

Site : chamber
 Condition: 3m VERTICAL
 Job No : 03018AT\03019AT
 Mode : 5240 TX RSE
 Note : 5G WIFI 11AX20

	Cable	Ant	Preamp	Read	Limit	Over		
Freq	Loss	Factor	Factor	Level	Level	Line	Limit	Remark
MHz	dB	dB/m	dB	dBuV	dBuV/m	dBuV/m	dB	
1	1300.858	3.81	24.79	61.59	65.07	32.08	74.00	-41.92 peak
2	1547.199	4.11	26.99	61.67	65.00	34.43	74.00	-39.57 peak
3	3196.094	6.25	32.87	61.36	63.60	41.36	68.20	-26.84 peak
4	4354.454	7.08	34.44	61.50	63.59	43.61	74.00	-30.39 peak
5	10480.000	11.33	37.26	62.38	58.75	44.96	68.20	-23.24 peak
6	p15720.000	14.01	41.22	62.91	58.93	51.25	74.00	-22.75 peak



Unless otherwise agreed in writing, this document is issued by the Company subject to its General Conditions of Service printed overleaf, available on request or accessible at <https://www.sgs.com/en/Terms-and-Conditions>. Attention is drawn to the limitation of liability, indemnification and jurisdiction issues defined therein. Any holder of this document is advised that information contained hereon reflects the Company's findings at the time of its intervention only and within the limits of Client's instructions, if any. The Company's sole responsibility is to its Client and this document does not exonerate parties to a transaction from exercising all their rights and obligations under the transaction documents. This document cannot be reproduced except in full, without prior written approval of the Company. Any unauthorized alteration, forgery or falsification of the content or appearance of this document is unlawful and offenders may be prosecuted to the fullest extent of the law. Unless otherwise stated the results shown in this test report refer only to the sample(s) tested and such sample(s) are retained for 30 days only.

Test Mode: 05; Polarity: Horizontal; Modulation:802.11 ax(Full RU0); Bandwidth:40MHz; Channel:Low

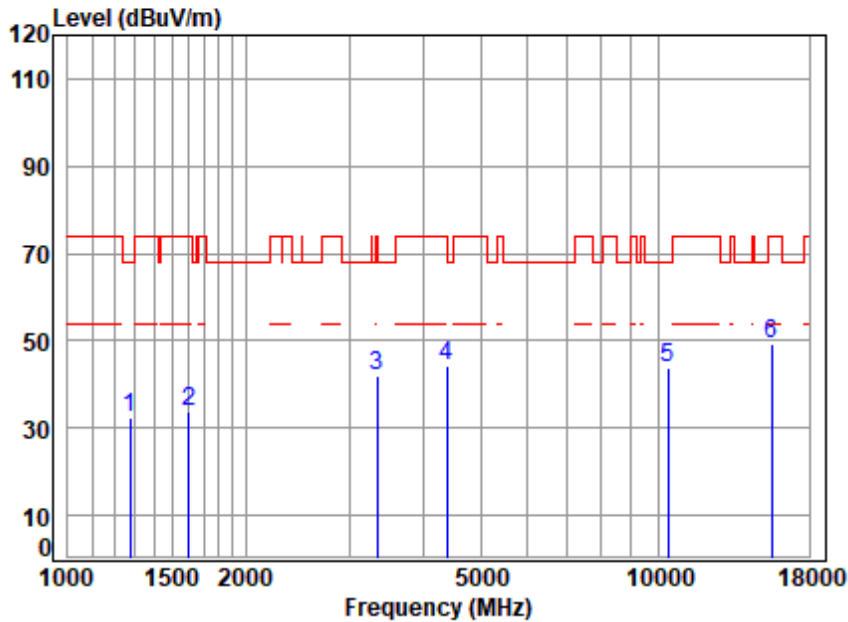

Site : chamber
 Condition: 3m HORIZONTAL
 Job No : 03018AT\03019AT
 Mode : 5190 TX RSE
 Note : 5G WIFI 11AX40

	Freq	Cable Loss	Ant Factor	Preamp Factor	Read Level	Level	Limit Line	Over Limit	Remark
	MHz	dB	dB/m	dB	dBuV	dBuV/m	dBuV/m	dB	
1	1274.802	3.78	24.95	61.58	65.08	32.23	68.20	-35.97	peak
2	1601.804	4.19	26.78	61.69	64.60	33.88	74.00	-40.12	peak
3	3347.371	6.39	32.05	61.32	64.70	41.82	74.00	-32.18	peak
4	4379.699	7.11	34.64	61.52	64.07	44.30	74.00	-29.70	peak
5	10380.000	11.17	37.10	62.36	57.73	43.64	68.20	-24.56	peak
6	p15570.000	13.83	41.10	62.89	57.42	49.46	74.00	-24.54	peak



Unless otherwise agreed in writing, this document is issued by the Company subject to its General Conditions of Service printed overleaf, available on request or accessible at <https://www.sgs.com/en/Terms-and-Conditions>. Attention is drawn to the limitation of liability, indemnification and jurisdiction issues defined therein. Any holder of this document is advised that information contained hereon reflects the Company's findings at the time of its intervention only and within the limits of Client's instructions, if any. The Company's sole responsibility is to its Client and this document does not exonerate parties to a transaction from exercising all their rights and obligations under the transaction documents. This document cannot be reproduced except in full, without prior written approval of the Company. Any unauthorized alteration, forgery or falsification of the content or appearance of this document is unlawful and offenders may be prosecuted to the fullest extent of the law. Unless otherwise stated the results shown in this test report refer only to the sample(s) tested and such sample(s) are retained for 30 days only.

Test Mode: 05; Polarity: Vertical; Modulation:802.11ax(Full RU0); Bandwidth:40MHz; Channel:Low

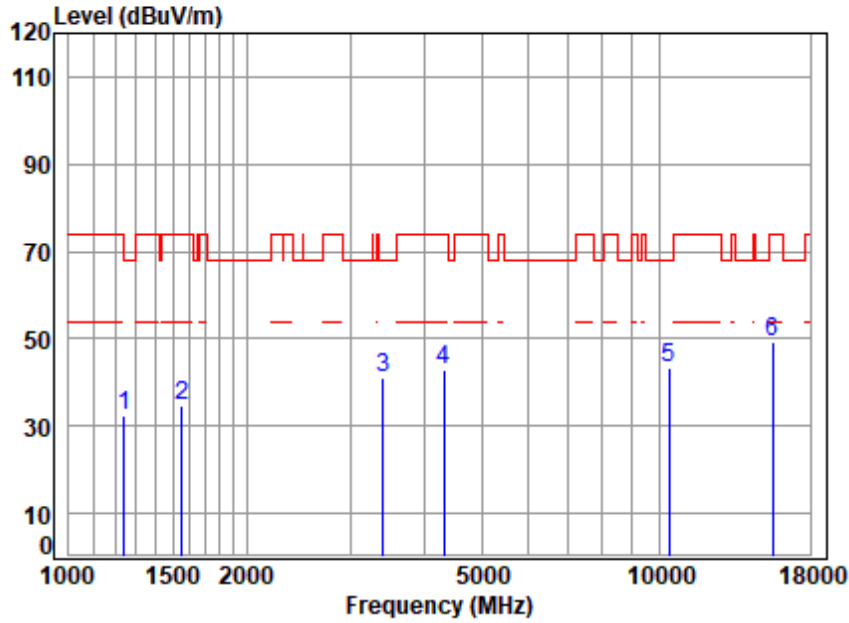

Site : chamber
 Condition: 3m VERTICAL
 Job No : 03018AT\03019AT
 Mode : 5190 TX RSE
 Note : 5G WIFI 11AX40

	Freq	Cable Loss	Ant Factor	Preamp Factor	Read Level	Level	Limit Line	Over Limit	Remark
	MHz	dB	dB/m	dB	dBuV	dBuV/m	dBuV/m	dB	
1	1242.068	3.74	24.99	61.57	65.25	32.41	68.20	-35.79	peak
2	1556.169	4.12	26.98	61.67	65.03	34.46	74.00	-39.54	peak
3	3405.929	6.44	32.33	61.31	63.73	41.19	68.20	-27.01	peak
4	4316.859	7.04	34.13	61.47	63.07	42.77	74.00	-31.23	peak
5	10380.000	11.17	37.10	62.36	57.41	43.32	68.20	-24.88	peak
6	15570.000	13.83	41.10	62.89	57.06	49.10	74.00	-24.90	peak



Unless otherwise agreed in writing, this document is issued by the Company subject to its General Conditions of Service printed overleaf, available on request or accessible at <https://www.sgs.com/en/Terms-and-Conditions>. Attention is drawn to the limitation of liability, indemnification and jurisdiction issues defined therein. Any holder of this document is advised that information contained hereon reflects the Company's findings at the time of its intervention only and within the limits of Client's instructions, if any. The Company's sole responsibility is to its Client and this document does not exonerate parties to a transaction from exercising all their rights and obligations under the transaction documents. This document cannot be reproduced except in full, without prior written approval of the Company. Any unauthorized alteration, forgery or falsification of the content or appearance of this document is unlawful and offenders may be prosecuted to the fullest extent of the law. Unless otherwise stated the results shown in this test report refer only to the sample(s) tested and such sample(s) are retained for 30 days only.

Test Mode: 05; Polarity: Horizontal; Modulation:802.11ax(Full RU0); Bandwidth:40MHz; Channel:High

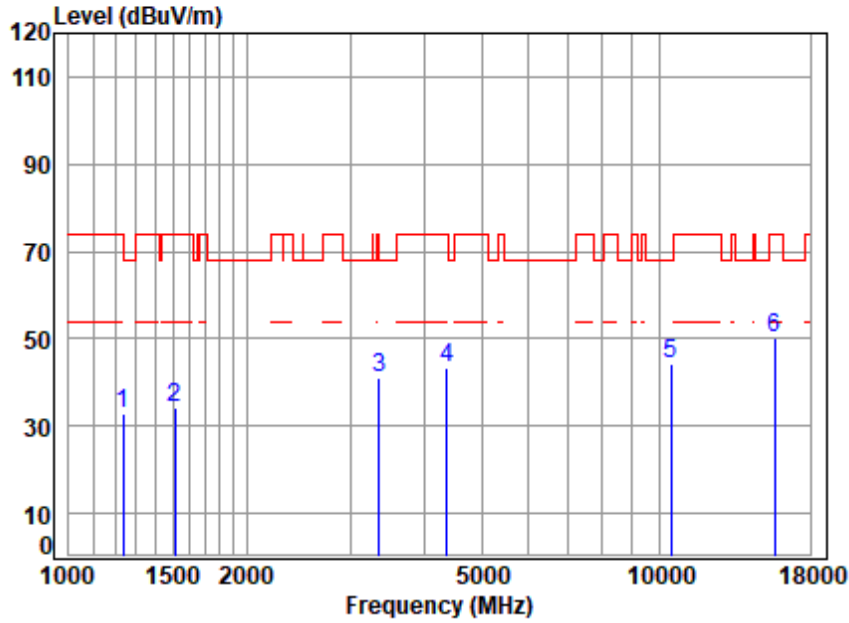

Site : chamber
 Condition: 3m HORIZONTAL
 Job No : 03018AT\03019AT
 Mode : 5230 TX RSE
 Note : 5G WIFI 11AX40

	Freq	Cable Loss	Ant Factor	Preamp Factor	Read Level	Level	Limit Line	Over Limit	Remark
	MHz	dB	dB/m	dB	dBuV	dBuV/m	dBuV/m	dB	
1	1238.483	3.73	24.94	61.57	65.75	32.85	74.00	-41.15	peak
2	1511.833	4.06	26.85	61.66	65.01	34.26	74.00	-39.74	peak
3	3357.061	6.40	32.14	61.32	63.93	41.15	74.00	-32.85	peak
4	4367.058	7.10	34.54	61.51	63.36	43.49	74.00	-30.51	peak
5	10460.000	11.30	37.22	62.38	57.96	44.10	68.20	-24.10	peak
6	p15690.000	13.97	41.19	62.91	58.12	50.37	74.00	-23.63	peak



Unless otherwise agreed in writing, this document is issued by the Company subject to its General Conditions of Service printed overleaf, available on request or accessible at <https://www.sgs.com/en/Terms-and-Conditions>. Attention is drawn to the limitation of liability, indemnification and jurisdiction issues defined therein. Any holder of this document is advised that information contained hereon reflects the Company's findings at the time of its intervention only and within the limits of Client's instructions, if any. The Company's sole responsibility is to its Client and this document does not exonerate parties to a transaction from exercising all their rights and obligations under the transaction documents. This document cannot be reproduced except in full, without prior written approval of the Company. Any unauthorized alteration, forgery or falsification of the content or appearance of this document is unlawful and offenders may be prosecuted to the fullest extent of the law. Unless otherwise stated the results shown in this test report refer only to the sample(s) tested and such sample(s) are retained for 30 days only.

Test Mode: 05; Polarity: Vertical; Modulation:802.11ax(Full RU0); Bandwidth:40MHz; Channel:High

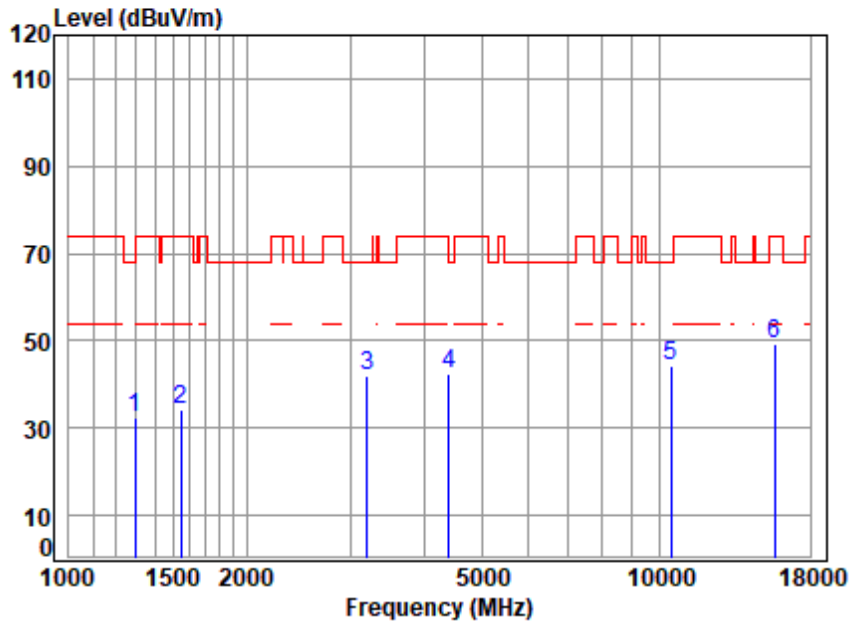

Site : chamber
 Condition: 3m VERTICAL
 Job No : 03018AT\03019AT
 Mode : 5230 TX RSE
 Note : 5G WIFI 11AX40

	Cable	Ant	Preamp	Read	Limit	Over		
Freq	Loss	Factor	Factor	Level	Level	Line	Limit	Remark
MHz	dB	dB/m	dB	dBuV	dBuV/m	dBuV/m	dB	
1	1293.359	3.80	24.84	61.59	65.27	32.32	68.20	-35.88 peak
2	1547.199	4.11	26.99	61.67	64.97	34.40	74.00	-39.60 peak
3	3196.094	6.25	32.87	61.36	64.18	41.94	68.20	-26.26 peak
4	4405.090	7.14	34.74	61.55	61.95	42.28	68.20	-25.92 peak
5	10460.000	11.30	37.22	62.38	58.09	44.23	68.20	-23.97 peak
6	15690.000	13.97	41.19	62.91	57.17	49.42	74.00	-24.58 peak



Unless otherwise agreed in writing, this document is issued by the Company subject to its General Conditions of Service printed overleaf, available on request or accessible at <https://www.sgs.com/en/Terms-and-Conditions>. Attention is drawn to the limitation of liability, indemnification and jurisdiction issues defined therein. Any holder of this document is advised that information contained hereon reflects the Company's findings at the time of its intervention only and within the limits of Client's instructions, if any. The Company's sole responsibility is to its Client and this document does not exonerate parties to a transaction from exercising all their rights and obligations under the transaction documents. This document cannot be reproduced except in full, without prior written approval of the Company. Any unauthorized alteration, forgery or falsification of the content or appearance of this document is unlawful and offenders may be prosecuted to the fullest extent of the law. Unless otherwise stated the results shown in this test report refer only to the sample(s) tested and such sample(s) are retained for 30 days only.

Test Mode: 05; Polarity: Horizontal; Modulation:802.11ax(Full RU0); Bandwidth:80MHz; Channel:middle

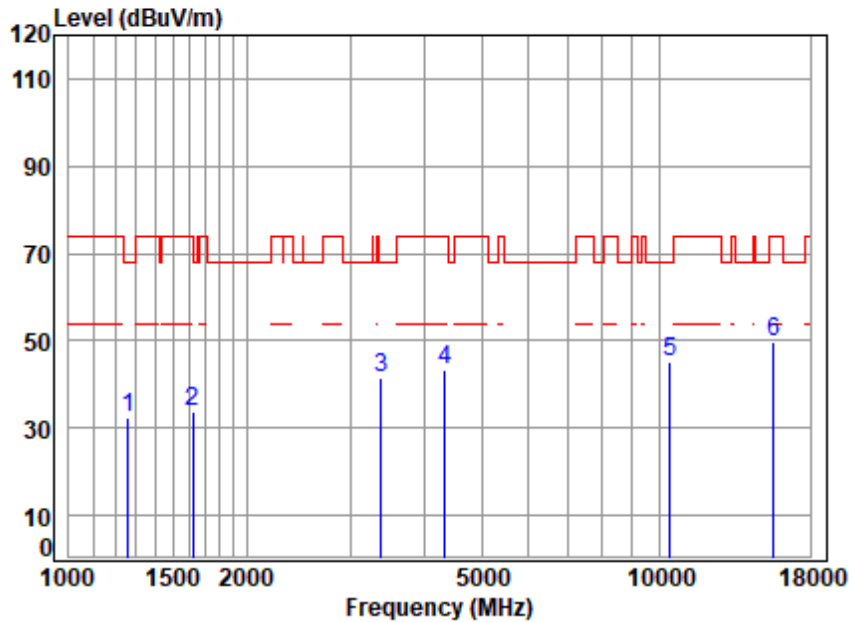

Site : chamber
 Condition: 3m HORIZONTAL
 Job No : 03018AT\03019AT
 Mode : 5210 TX RSE
 Note : 5G WIFI 11AX80

	Freq	Cable Loss	Ant Factor	Preamp Factor	Read Level	Level	Limit Line	Over Limit	Remark
	MHz	dB	dB/m	dB	dBuV	dBuV/m	dBuV/m	dB	
1	1260.149	3.76	25.04	61.58	65.20	32.42	68.20	-35.78	peak
2	1620.431	4.21	26.60	61.69	64.75	33.87	74.00	-40.13	peak
3	3376.523	6.42	32.26	61.32	64.33	41.69	68.20	-26.51	peak
4	4341.886	7.07	34.34	61.49	63.30	43.22	74.00	-30.78	peak
5	10420.000	11.23	37.14	62.37	59.04	45.04	68.20	-23.16	peak
6	15630.000	13.90	41.13	62.90	57.66	49.79	74.00	-24.21	peak



Unless otherwise agreed in writing, this document is issued by the Company subject to its General Conditions of Service printed overleaf, available on request or accessible at <https://www.sgs.com/en/Terms-and-Conditions>. Attention is drawn to the limitation of liability, indemnification and jurisdiction issues defined therein. Any holder of this document is advised that information contained hereon reflects the Company's findings at the time of its intervention only and within the limits of Client's instructions, if any. The Company's sole responsibility is to its Client and this document does not exonerate parties to a transaction from exercising all their rights and obligations under the transaction documents. This document cannot be reproduced except in full, without prior written approval of the Company. Any unauthorized alteration, forgery or falsification of the content or appearance of this document is unlawful and offenders may be prosecuted to the fullest extent of the law. Unless otherwise stated the results shown in this test report refer only to the sample(s) tested and such sample(s) are retained for 30 days only.

Test Mode: 05; Polarity: Vertical; Modulation:802.11ax(Full RU0); Bandwidth:80MHz; Channel:middle

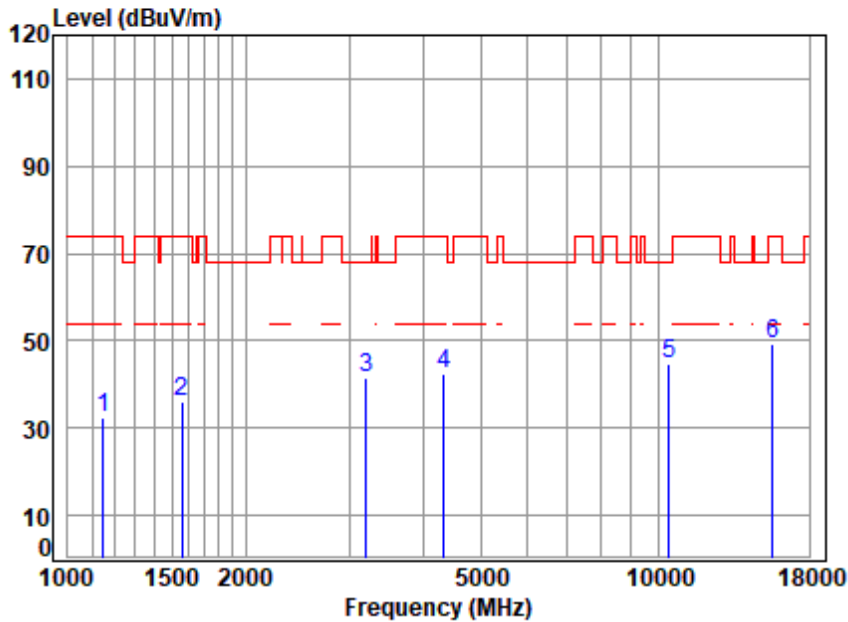

Site : chamber
 Condition: 3m VERTICAL
 Job No : 03018AT\03019AT
 Mode : 5210 TX RSE
 Note : 5G WIFI 11AX80

	Cable	Ant	Preamp	Read	Limit	Over		
Freq	Loss	Factor	Factor	Level	Level	Line	Limit	Remark
MHz	dB	dB/m	dB	dBuV	dBuV/m	dBuV/m	dB	
1	1148.823	3.61	23.90	61.53	66.44	32.42	74.00	-41.58 peak
2	1560.673	4.13	26.96	61.68	66.65	36.06	74.00	-37.94 peak
3	3205.345	6.26	32.81	61.36	63.66	41.37	68.20	-26.83 peak
4	4329.354	7.05	34.23	61.48	62.83	42.63	74.00	-31.37 peak
5	p10420.000	11.23	37.14	62.37	58.81	44.81	68.20	-23.39 peak
6	15630.000	13.90	41.13	62.90	57.33	49.46	74.00	-24.54 peak



Unless otherwise agreed in writing, this document is issued by the Company subject to its General Conditions of Service printed overleaf, available on request or accessible at <https://www.sgs.com/en/Terms-and-Conditions>. Attention is drawn to the limitation of liability, indemnification and jurisdiction issues defined therein. Any holder of this document is advised that information contained hereon reflects the Company's findings at the time of its intervention only and within the limits of Client's instructions, if any. The Company's sole responsibility is to its Client and this document does not exonerate parties to a transaction from exercising all their rights and obligations under the transaction documents. This document cannot be reproduced except in full, without prior written approval of the Company. Any unauthorized alteration, forgery or falsification of the content or appearance of this document is unlawful and offenders may be prosecuted to the fullest extent of the law. Unless otherwise stated the results shown in this test report refer only to the sample(s) tested and such sample(s) are retained for 30 days only.

Test Mode: 06; Polarity: Horizontal; Modulation:802.11a; Bandwidth:20MHz; Channel:Low

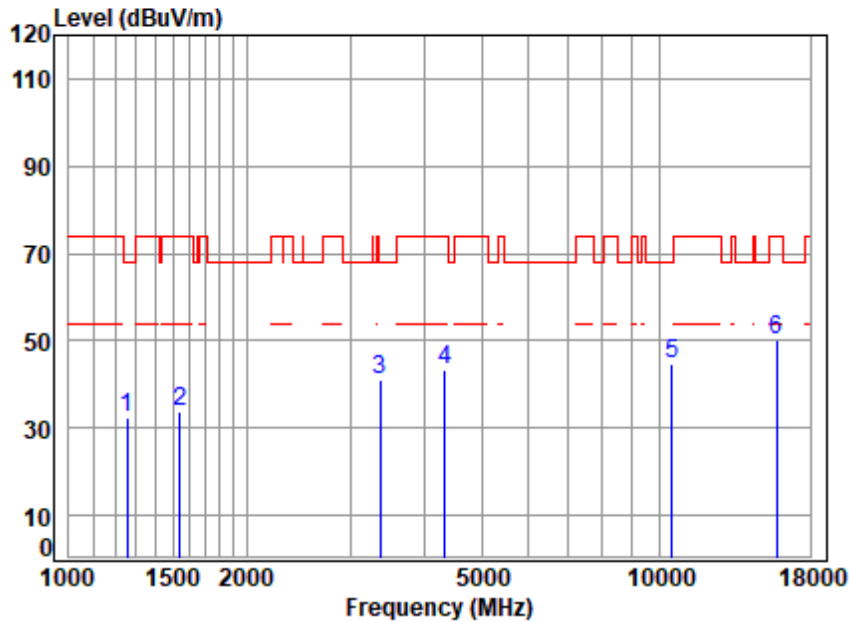

Site : chamber
 Condition: 3m HORIZONTAL
 Job No : 03018AT\03019AT
 Mode : 5260 TX RSE
 Note : 5G WIFI 11A

	Freq	Cable Loss	Ant Factor	Preamp Factor	Read Level	Level	Limit Line	Over Limit	Remark
	MHz	dB	dB/m	dB	dBuV	dBuV/m	dBuV/m	dB	
1	1256.512	3.76	25.06	61.58	65.04	32.28	68.20	-35.92	peak
2	1542.733	4.10	26.97	61.67	64.23	33.63	74.00	-40.37	peak
3	3366.778	6.41	32.20	61.32	63.68	40.97	68.20	-27.23	peak
4	4329.354	7.05	34.23	61.48	63.68	43.48	74.00	-30.52	peak
5	10520.000	11.37	37.30	62.39	58.27	44.55	68.20	-23.65	peak
6	15780.000	14.08	41.28	62.92	57.88	50.32	74.00	-23.68	peak



Unless otherwise agreed in writing, this document is issued by the Company subject to its General Conditions of Service printed overleaf, available on request or accessible at <https://www.sgs.com/en/Terms-and-Conditions>. Attention is drawn to the limitation of liability, indemnification and jurisdiction issues defined therein. Any holder of this document is advised that information contained hereon reflects the Company's findings at the time of its intervention only and within the limits of Client's instructions, if any. The Company's sole responsibility is to its Client and this document does not exonerate parties to a transaction from exercising all their rights and obligations under the transaction documents. This document cannot be reproduced except in full, without prior written approval of the Company. Any unauthorized alteration, forgery or falsification of the content or appearance of this document is unlawful and offenders may be prosecuted to the fullest extent of the law. Unless otherwise stated the results shown in this test report refer only to the sample(s) tested and such sample(s) are retained for 30 days only.

Test Mode: 06; Polarity: Vertical; Modulation:802.11a; Bandwidth:20MHz; Channel:Low

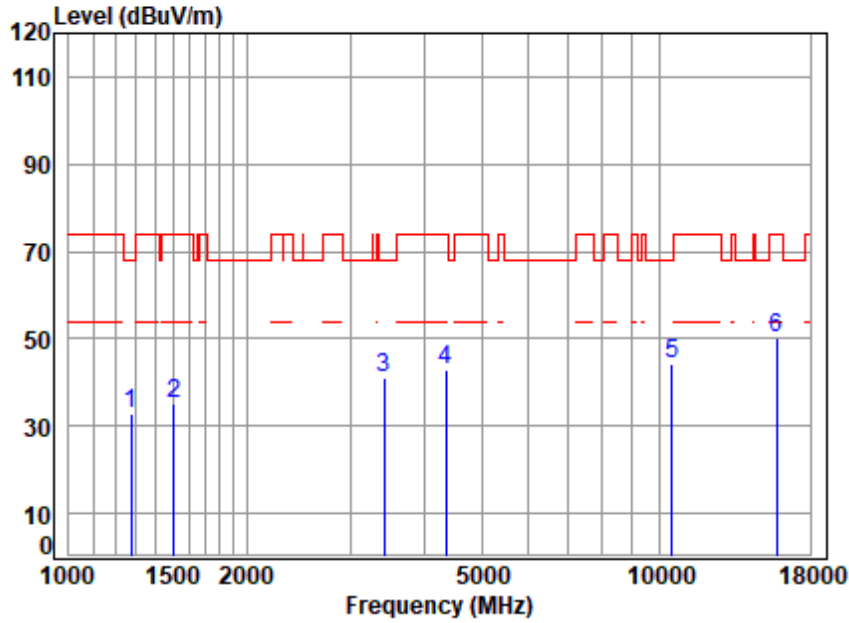

Site : chamber
 Condition: 3m VERTICAL
 Job No : 03018AT\03019AT
 Mode : 5260 TX RSE
 Note : 5G WIFI 11A

	Freq	Cable Loss	Ant Factor	Preamp Factor	Read Level	Level	Limit Line	Over Limit	Remark
	MHz	dB	dB/m	dB	dBuV	dBuV/m	dBuV/m	dB	
1	1274.802	3.78	24.95	61.58	65.80	32.95	68.20	-35.25	peak
2	1507.470	4.05	26.83	61.66	65.73	34.95	74.00	-39.05	peak
3	3425.675	6.46	32.09	61.30	63.94	41.19	68.20	-27.01	peak
4	4354.454	7.08	34.44	61.50	62.97	42.99	74.00	-31.01	peak
5	10520.000	11.37	37.30	62.39	57.78	44.06	68.20	-24.14	peak
6	p15780.000	14.08	41.28	62.92	57.74	50.18	74.00	-23.82	peak



Unless otherwise agreed in writing, this document is issued by the Company subject to its General Conditions of Service printed overleaf, available on request or accessible at <https://www.sgs.com/en/Terms-and-Conditions>. Attention is drawn to the limitation of liability, indemnification and jurisdiction issues defined therein. Any holder of this document is advised that information contained hereon reflects the Company's findings at the time of its intervention only and within the limits of Client's instructions, if any. The Company's sole responsibility is to its Client and this document does not exonerate parties to a transaction from exercising all their rights and obligations under the transaction documents. This document cannot be reproduced except in full, without prior written approval of the Company. Any unauthorized alteration, forgery or falsification of the content or appearance of this document is unlawful and offenders may be prosecuted to the fullest extent of the law. Unless otherwise stated the results shown in this test report refer only to the sample(s) tested and such sample(s) are retained for 30 days only.

Test Mode: 06; Polarity: Horizontal; Modulation:802.11a; Bandwidth:20MHz; Channel:middle

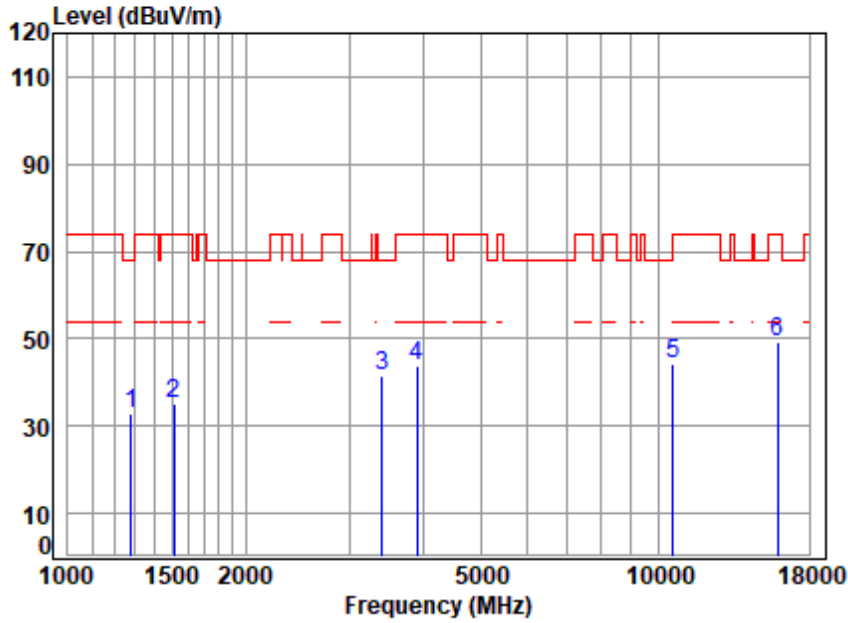

Site : chamber
 Condition: 3m HORIZONTAL
 Job No : 03018AT\03019AT
 Mode : 5300 TX RSE
 Note : 5G WIFI 11A

	Freq	Cable Loss	Ant Factor	Preamp Factor	Read Level	Level	Limit Line	Over Limit	Remark
	MHz	dB	dB/m	dB	dBuV	dBuV/m	dBuV/m	dB	
1	1282.193	3.79	24.91	61.58	65.90	33.02	68.20	-35.18	peak
2	1511.833	4.06	26.85	61.66	66.00	35.25	74.00	-38.75	peak
3	3405.929	6.44	32.33	61.31	64.06	41.52	68.20	-26.68	peak
4	3901.516	6.63	33.79	61.19	64.47	43.70	74.00	-30.30	peak
5	10600.000	11.43	37.30	62.41	58.16	44.48	68.20	-23.72	peak
6	15900.000	14.23	41.40	62.94	56.70	49.39	74.00	-24.61	peak



Unless otherwise agreed in writing, this document is issued by the Company subject to its General Conditions of Service printed overleaf, available on request or accessible at <https://www.sgs.com/en/Terms-and-Conditions>. Attention is drawn to the limitation of liability, indemnification and jurisdiction issues defined therein. Any holder of this document is advised that information contained hereon reflects the Company's findings at the time of its intervention only and within the limits of Client's instructions, if any. The Company's sole responsibility is to its Client and this document does not exonerate parties to a transaction from exercising all their rights and obligations under the transaction documents. This document cannot be reproduced except in full, without prior written approval of the Company. Any unauthorized alteration, forgery or falsification of the content or appearance of this document is unlawful and offenders may be prosecuted to the fullest extent of the law. Unless otherwise stated the results shown in this test report refer only to the sample(s) tested and such sample(s) are retained for 30 days only.

Test Mode: 06; Polarity: Vertical; Modulation:802.11a; Bandwidth:20MHz; Channel:middle

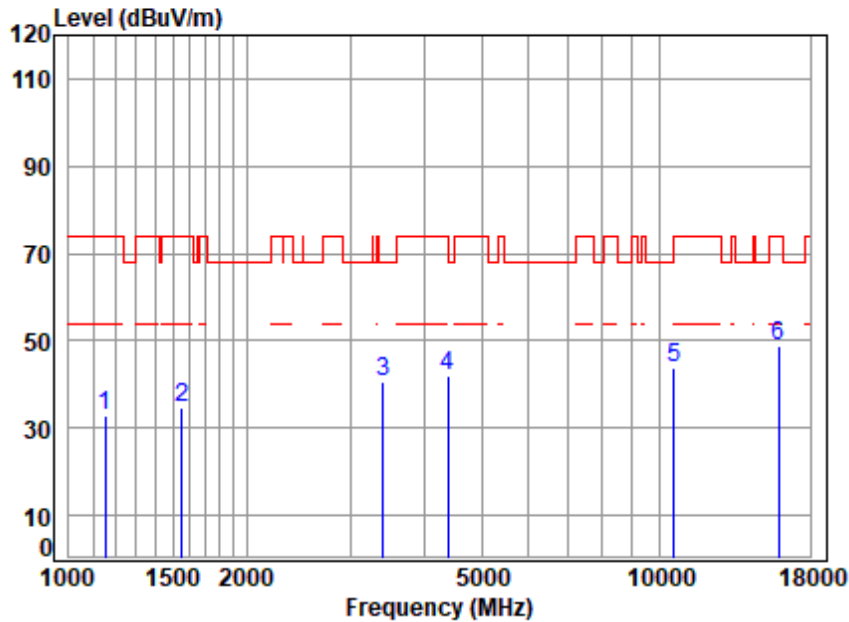

Site : chamber
 Condition: 3m VERTICAL
 Job No : 03018AT\03019AT
 Mode : 5300 TX RSE
 Note : 5G WIFI 11A

	Freq	Cable Loss	Ant Factor	Preamp Factor	Read Level	Level	Limit Line	Over Limit	Remark
	MHz	dB	dB/m	dB	dBuV	dBuV/m	dBuV/m	dB	
1	1152.148	3.62	23.92	61.54	66.67	32.67	74.00	-41.33	peak
2	1551.677	4.12	26.99	61.67	65.35	34.79	74.00	-39.21	peak
3	3405.929	6.44	32.33	61.31	63.37	40.83	68.20	-27.37	peak
4	4392.376	7.13	34.74	61.53	61.83	42.17	74.00	-31.83	peak
5	p10600.000	11.43	37.30	62.41	57.64	43.96	68.20	-24.24	peak
6	15900.000	14.23	41.40	62.94	56.35	49.04	74.00	-24.96	peak



Unless otherwise agreed in writing, this document is issued by the Company subject to its General Conditions of Service printed overleaf, available on request or accessible at <https://www.sgs.com/en/Terms-and-Conditions>. Attention is drawn to the limitation of liability, indemnification and jurisdiction issues defined therein. Any holder of this document is advised that information contained hereon reflects the Company's findings at the time of its intervention only and within the limits of Client's instructions, if any. The Company's sole responsibility is to its Client and this document does not exonerate parties to a transaction from exercising all their rights and obligations under the transaction documents. This document cannot be reproduced except in full, without prior written approval of the Company. Any unauthorized alteration, forgery or falsification of the content or appearance of this document is unlawful and offenders may be prosecuted to the fullest extent of the law. Unless otherwise stated the results shown in this test report refer only to the sample(s) tested and such sample(s) are retained for 30 days only.

Test Mode: 06; Polarity: Horizontal; Modulation:802.11a; Bandwidth:20MHz; Channel:High

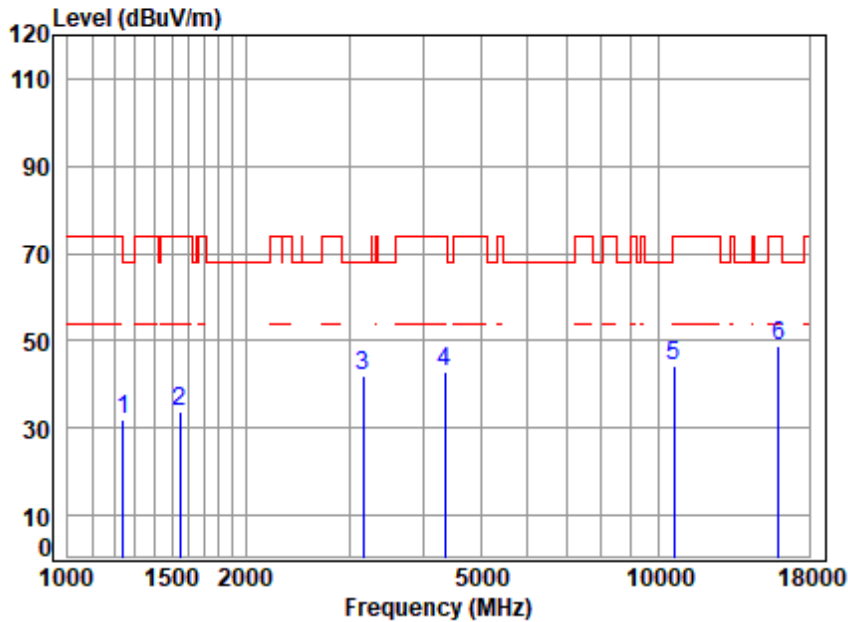

Site : chamber
 Condition: 3m HORIZONTAL
 Job No : 03018AT\03019AT
 Mode : 5320 TX RSE
 Note : 5G WIFI 11A

	Freq	Cable Loss	Ant Factor	Preamp Factor	Read Level	Level	Limit Line	Over Limit	Remark
	MHz	dB	dB/m	dB	dBuV	dBuV/m	dBuV/m	dB	
1	1242.068	3.74	24.99	61.57	64.89	32.05	68.20	-36.15	peak
2	1547.199	4.11	26.99	61.67	64.40	33.83	74.00	-40.17	peak
3	3159.355	6.22	32.57	61.38	64.52	41.93	68.20	-26.27	peak
4	4354.454	7.08	34.44	61.50	62.88	42.90	74.00	-31.10	peak
5	10640.000	11.45	37.22	62.42	58.15	44.40	74.00	-29.60	peak
6	p15960.000	14.30	41.52	62.95	56.09	48.96	74.00	-25.04	peak



Unless otherwise agreed in writing, this document is issued by the Company subject to its General Conditions of Service printed overleaf, available on request or accessible at <https://www.sgs.com/en/Terms-and-Conditions>. Attention is drawn to the limitation of liability, indemnification and jurisdiction issues defined therein. Any holder of this document is advised that information contained hereon reflects the Company's findings at the time of its intervention only and within the limits of Client's instructions, if any. The Company's sole responsibility is to its Client and this document does not exonerate parties to a transaction from exercising all their rights and obligations under the transaction documents. This document cannot be reproduced except in full, without prior written approval of the Company. Any unauthorized alteration, forgery or falsification of the content or appearance of this document is unlawful and offenders may be prosecuted to the fullest extent of the law. Unless otherwise stated the results shown in this test report refer only to the sample(s) tested and such sample(s) are retained for 30 days only.

Test Mode: 06; Polarity: Vertical; Modulation:802.11a; Bandwidth:20MHz; Channel:High

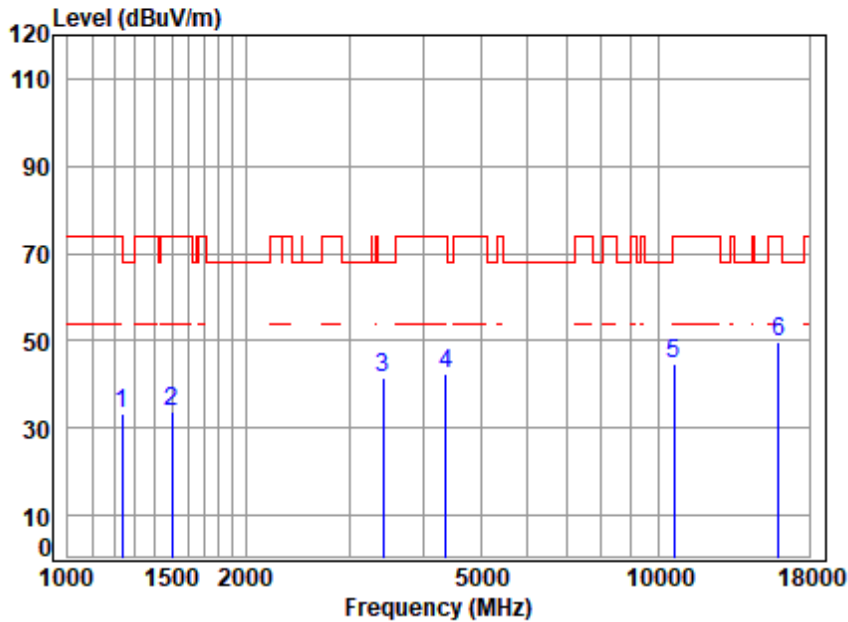

Site : chamber
 Condition: 3m VERTICAL
 Job No : 03018AT\03019AT
 Mode : 5320 TX RSE
 Note : 5G WIFI 11A

	Freq	Cable Loss	Ant Factor	Preamp Factor	Read Level	Level	Limit Line	Over Limit	Remark
	MHz	dB	dB/m	dB	dBuV	dBuV/m	dBuV/m	dB	
1	1238.483	3.73	24.94	61.57	66.13	33.23	74.00	-40.77	peak
2	1503.119	4.04	26.81	61.66	64.65	33.84	74.00	-40.16	peak
3	3425.675	6.46	32.09	61.30	64.46	41.71	68.20	-26.49	peak
4	4367.058	7.10	34.54	61.51	62.45	42.58	74.00	-31.42	peak
5	10640.000	11.45	37.22	62.42	58.66	44.91	74.00	-29.09	peak
6	p15960.000	14.30	41.52	62.95	56.71	49.58	74.00	-24.42	peak



Unless otherwise agreed in writing, this document is issued by the Company subject to its General Conditions of Service printed overleaf, available on request or accessible at <https://www.sgs.com/en/Terms-and-Conditions>. Attention is drawn to the limitation of liability, indemnification and jurisdiction issues defined therein. Any holder of this document is advised that information contained hereon reflects the Company's findings at the time of its intervention only and within the limits of Client's instructions, if any. The Company's sole responsibility is to its Client and this document does not exonerate parties to a transaction from exercising all their rights and obligations under the transaction documents. This document cannot be reproduced except in full, without prior written approval of the Company. Any unauthorized alteration, forgery or falsification of the content or appearance of this document is unlawful and offenders may be prosecuted to the fullest extent of the law. Unless otherwise stated the results shown in this test report refer only to the sample(s) tested and such sample(s) are retained for 30 days only.

Test Mode: 06; Polarity: Horizontal; Modulation:802.11n; Bandwidth:20MHz; Channel:Low

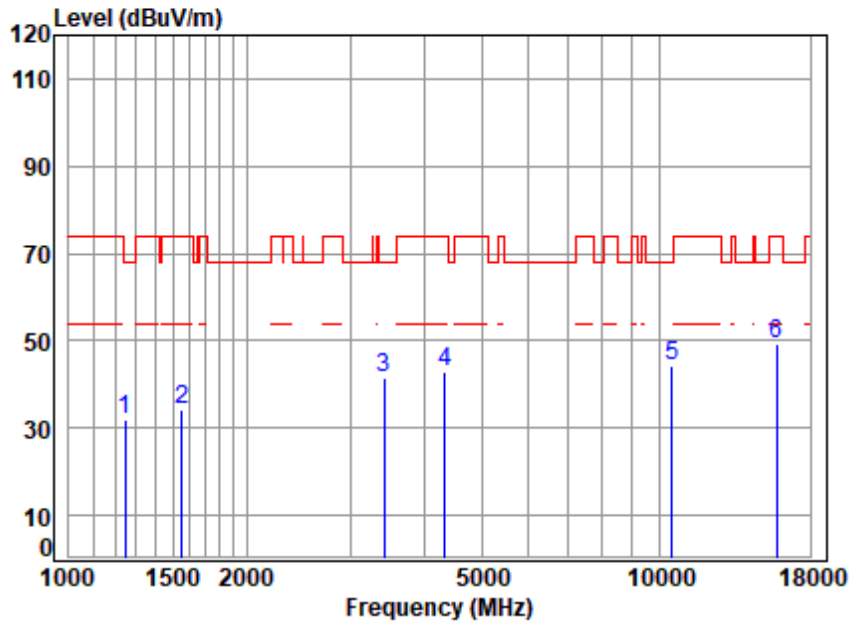

Site : chamber
 Condition: 3m HORIZONTAL
 Job No : 03018AT\03019AT
 Mode : 5260 TX RSE
 Note : 5G WIFI 11N20

	Freq	Cable Loss	Ant Factor	Preamp Factor	Read Level	Level	Limit Line	Over Limit	Remark
	MHz	dB	dB/m	dB	dBuV	dBuV/m	dBuV/m	dB	
1	1245.663	3.74	25.04	61.57	64.90	32.11	68.20	-36.09	peak
2	1556.169	4.12	26.98	61.67	64.92	34.35	74.00	-39.65	peak
3	3415.787	6.45	32.21	61.31	64.11	41.46	68.20	-26.74	peak
4	4341.886	7.07	34.34	61.49	62.84	42.76	74.00	-31.24	peak
5	10520.000	11.37	37.30	62.39	57.86	44.14	68.20	-24.06	peak
6	15780.000	14.08	41.28	62.92	56.70	49.14	74.00	-24.86	peak



Unless otherwise agreed in writing, this document is issued by the Company subject to its General Conditions of Service printed overleaf, available on request or accessible at <https://www.sgs.com/en/Terms-and-Conditions>. Attention is drawn to the limitation of liability, indemnification and jurisdiction issues defined therein. Any holder of this document is advised that information contained hereon reflects the Company's findings at the time of its intervention only and within the limits of Client's instructions, if any. The Company's sole responsibility is to its Client and this document does not exonerate parties to a transaction from exercising all their rights and obligations under the transaction documents. This document cannot be reproduced except in full, without prior written approval of the Company. Any unauthorized alteration, forgery or falsification of the content or appearance of this document is unlawful and offenders may be prosecuted to the fullest extent of the law. Unless otherwise stated the results shown in this test report refer only to the sample(s) tested and such sample(s) are retained for 30 days only.

Test Mode: 06; Polarity: Vertical; Modulation:802.11n; Bandwidth:20MHz; Channel:Low

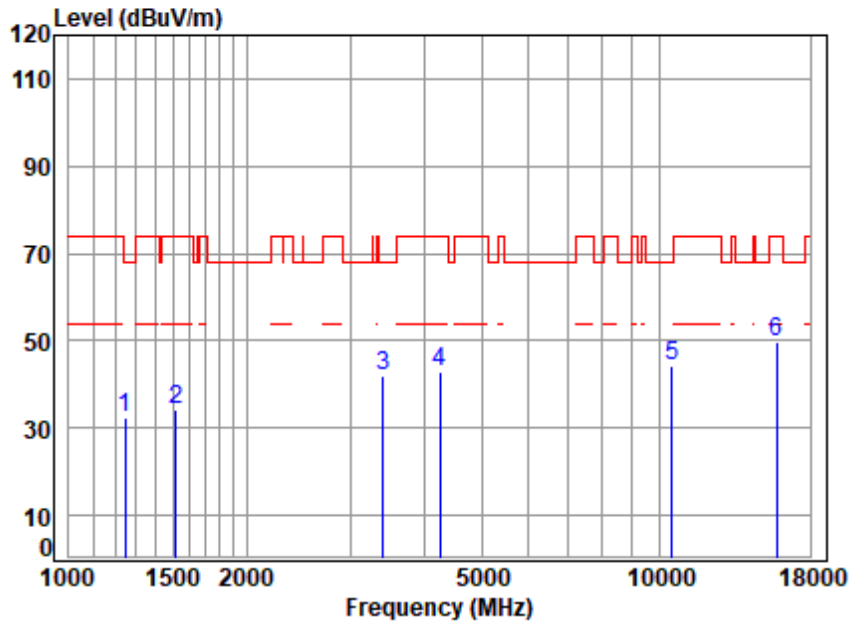

Site : chamber
 Condition: 3m VERTICAL
 Job No : 03018AT\03019AT
 Mode : 5260 TX RSE
 Note : 5G WIFI 11N20

	Freq	Cable Loss	Ant Factor	Preamp Factor	Read Level	Level	Limit Line	Over Limit	Remark
	MHz	dB	dB/m	dB	dBuV	dBuV/m	dBuV/m	dB	
1	1245.663	3.74	25.04	61.57	65.10	32.31	68.20	-35.89	peak
2	1520.598	4.07	26.88	61.66	65.13	34.42	74.00	-39.58	peak
3	3405.929	6.44	32.33	61.31	64.44	41.90	68.20	-26.30	peak
4	4242.641	6.95	33.80	61.40	63.48	42.83	74.00	-31.17	peak
5	10520.000	11.37	37.30	62.39	58.02	44.30	68.20	-23.90	peak
6	15780.000	14.08	41.28	62.92	57.10	49.54	74.00	-24.46	peak



Unless otherwise agreed in writing, this document is issued by the Company subject to its General Conditions of Service printed overleaf, available on request or accessible at <https://www.sgs.com/en/Terms-and-Conditions>. Attention is drawn to the limitation of liability, indemnification and jurisdiction issues defined therein. Any holder of this document is advised that information contained hereon reflects the Company's findings at the time of its intervention only and within the limits of Client's instructions, if any. The Company's sole responsibility is to its Client and this document does not exonerate parties to a transaction from exercising all their rights and obligations under the transaction documents. This document cannot be reproduced except in full, without prior written approval of the Company. Any unauthorized alteration, forgery or falsification of the content or appearance of this document is unlawful and offenders may be prosecuted to the fullest extent of the law. Unless otherwise stated the results shown in this test report refer only to the sample(s) tested and such sample(s) are retained for 30 days only.

Test Mode: 06; Polarity: Horizontal; Modulation:802.11n; Bandwidth:20MHz; Channel:middle

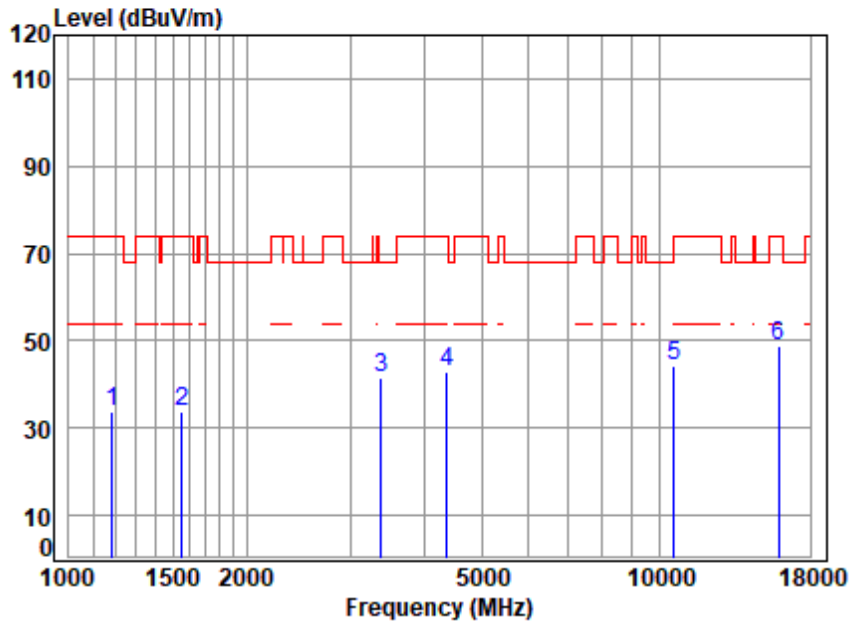

Site : chamber
 Condition: 3m HORIZONTAL
 Job No : 03018AT\03019AT
 Mode : 5300 TX RSE
 Note : 5G WIFI 11N20

	Freq	Cable Loss	Ant Factor	Preamp Factor	Read Level	Level	Limit Line	Over Limit	Remark
	MHz	dB	dB/m	dB	dBuV	dBuV/m	dBuV/m	dB	
1	1185.936	3.66	24.26	61.55	67.31	33.68	74.00	-40.32	peak
2	1556.169	4.12	26.98	61.67	64.27	33.70	74.00	-40.30	peak
3	3376.523	6.42	32.26	61.32	63.97	41.33	68.20	-26.87	peak
4	4367.058	7.10	34.54	61.51	62.73	42.86	74.00	-31.14	peak
5	10600.000	11.43	37.30	62.41	58.15	44.47	68.20	-23.73	peak
6	15900.000	14.23	41.40	62.94	56.20	48.89	74.00	-25.11	peak



Unless otherwise agreed in writing, this document is issued by the Company subject to its General Conditions of Service printed overleaf, available on request or accessible at <https://www.sgs.com/en/Terms-and-Conditions>. Attention is drawn to the limitation of liability, indemnification and jurisdiction issues defined therein. Any holder of this document is advised that information contained hereon reflects the Company's findings at the time of its intervention only and within the limits of Client's instructions, if any. The Company's sole responsibility is to its Client and this document does not exonerate parties to a transaction from exercising all their rights and obligations under the transaction documents. This document cannot be reproduced except in full, without prior written approval of the Company. Any unauthorized alteration, forgery or falsification of the content or appearance of this document is unlawful and offenders may be prosecuted to the fullest extent of the law. Unless otherwise stated the results shown in this test report refer only to the sample(s) tested and such sample(s) are retained for 30 days only.

Test Mode: 06; Polarity: Vertical; Modulation:802.11n; Bandwidth:20MHz; Channel:middle

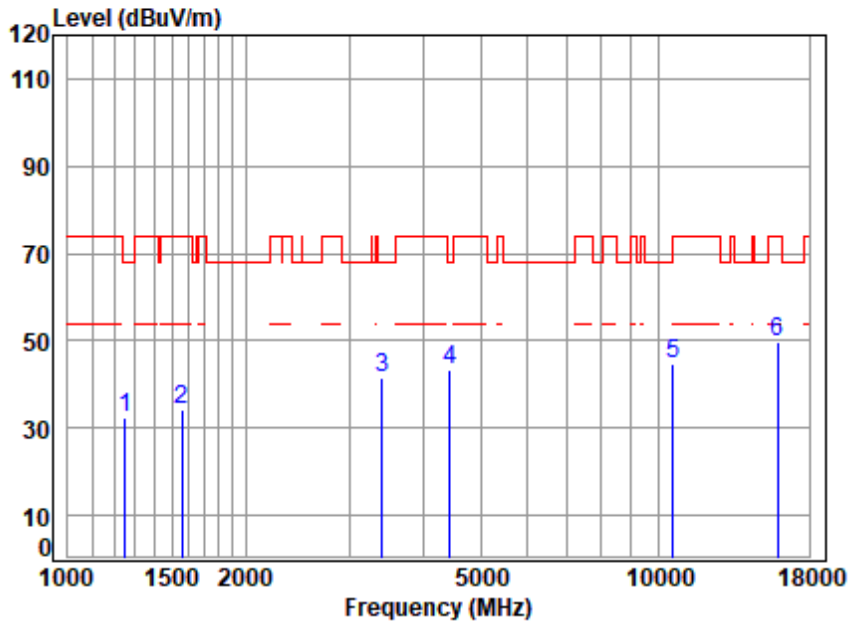

Site : chamber
 Condition: 3m VERTICAL
 Job No : 03018AT\03019AT
 Mode : 5300 TX RSE
 Note : 5G WIFI 11N20

	Freq	Cable Loss	Ant Factor	Preamp Factor	Read Level	Level	Limit Line	Over Limit	Remark
	MHz	dB	dB/m	dB	dBuV	dBuV/m	dBuV/m	dB	
1	1252.885	3.75	25.08	61.57	65.13	32.39	68.20	-35.81	peak
2	1560.673	4.13	26.96	61.68	64.96	34.37	74.00	-39.63	peak
3	3405.929	6.44	32.33	61.31	64.01	41.47	68.20	-26.73	peak
4	4443.453	7.19	34.28	61.58	63.33	43.22	68.20	-24.98	peak
5	10600.000	11.43	37.30	62.41	58.57	44.89	68.20	-23.31	peak
6	15900.000	14.23	41.40	62.94	56.83	49.52	74.00	-24.48	peak



Unless otherwise agreed in writing, this document is issued by the Company subject to its General Conditions of Service printed overleaf, available on request or accessible at <https://www.sgs.com/en/Terms-and-Conditions>. Attention is drawn to the limitation of liability, indemnification and jurisdiction issues defined therein. Any holder of this document is advised that information contained hereon reflects the Company's findings at the time of its intervention only and within the limits of Client's instructions, if any. The Company's sole responsibility is to its Client and this document does not exonerate parties to a transaction from exercising all their rights and obligations under the transaction documents. This document cannot be reproduced except in full, without prior written approval of the Company. Any unauthorized alteration, forgery or falsification of the content or appearance of this document is unlawful and offenders may be prosecuted to the fullest extent of the law. Unless otherwise stated the results shown in this test report refer only to the sample(s) tested and such sample(s) are retained for 30 days only.

Test Mode: 06; Polarity: Horizontal; Modulation:802.11n; Bandwidth:20MHz; Channel:High

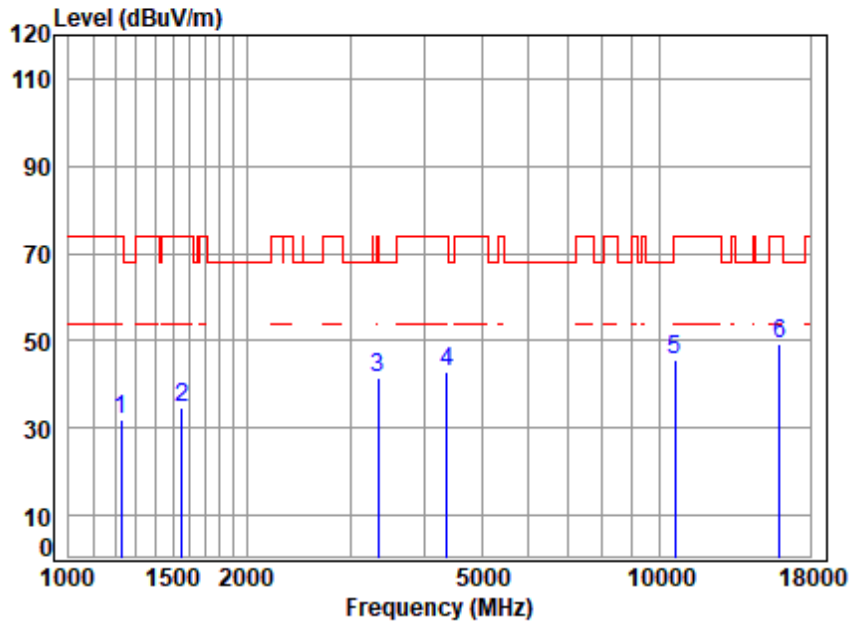

Site : chamber
 Condition: 3m HORIZONTAL
 Job No : 03018AT\03019AT
 Mode : 5320 TX RSE
 Note : 5G WIFI 11N20

	Freq	Cable Loss	Ant Factor	Preamp Factor	Read Level	Level	Limit	Over	Remark
	MHz	dB	dB/m	dB	dBuV	dBuV/m	dBuV/m	dB	
1	1227.791	3.72	24.79	61.56	65.07	32.02	74.00	-41.98	peak
2	1551.677	4.12	26.99	61.67	65.15	34.59	74.00	-39.41	peak
3	3337.710	6.38	31.88	61.33	64.59	41.52	74.00	-32.48	peak
4	4367.058	7.10	34.54	61.51	62.86	42.99	74.00	-31.01	peak
5	10640.000	11.45	37.22	62.42	59.35	45.60	74.00	-28.40	peak
6	p15960.000	14.30	41.52	62.95	56.21	49.08	74.00	-24.92	peak



Unless otherwise agreed in writing, this document is issued by the Company subject to its General Conditions of Service printed overleaf, available on request or accessible at <https://www.sgs.com/en/Terms-and-Conditions>. Attention is drawn to the limitation of liability, indemnification and jurisdiction issues defined therein. Any holder of this document is advised that information contained hereon reflects the Company's findings at the time of its intervention only and within the limits of Client's instructions, if any. The Company's sole responsibility is to its Client and this document does not exonerate parties to a transaction from exercising all their rights and obligations under the transaction documents. This document cannot be reproduced except in full, without prior written approval of the Company. Any unauthorized alteration, forgery or falsification of the content or appearance of this document is unlawful and offenders may be prosecuted to the fullest extent of the law. Unless otherwise stated the results shown in this test report refer only to the sample(s) tested and such sample(s) are retained for 30 days only.

Test Mode: 06; Polarity: Vertical; Modulation:802.11n; Bandwidth:20MHz; Channel:High

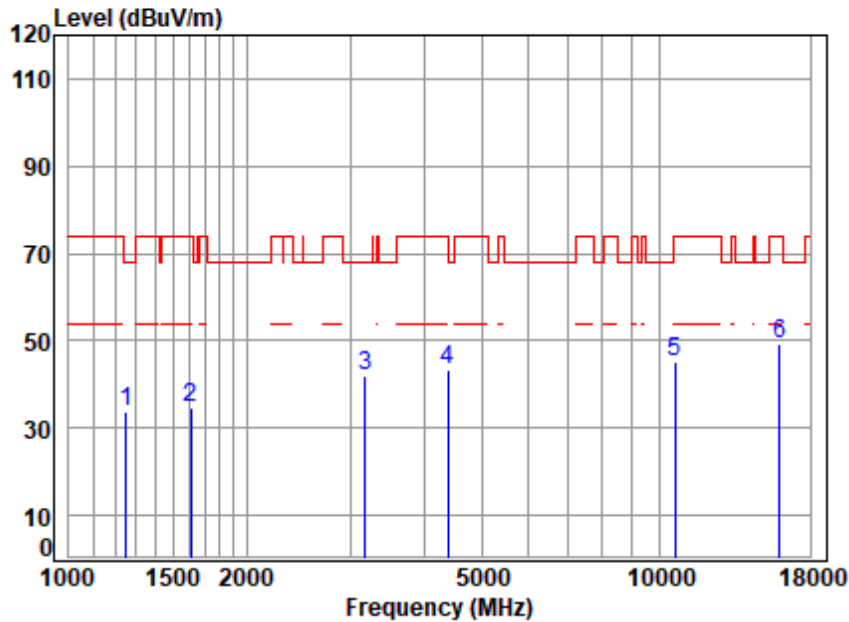

Site : chamber
 Condition: 3m VERTICAL
 Job No : 03018AT\03019AT
 Mode : 5320 TX RSE
 Note : 5G WIFI 11N20

	Freq	Cable Loss	Ant Factor	Preamp Factor	Read Level	Level	Limit Line	Over Limit	Remark
	MHz	dB	dB/m	dB	dBuV	dBuV/m	dBuV/m	dB	
1	1252.885	3.75	25.08	61.57	66.49	33.75	68.20	-34.45	peak
2	1611.091	4.20	26.69	61.69	65.35	34.55	74.00	-39.45	peak
3	3177.672	6.24	32.72	61.37	64.23	41.82	68.20	-26.38	peak
4	4379.699	7.11	34.64	61.52	63.28	43.51	74.00	-30.49	peak
5	10640.000	11.45	37.22	62.42	59.06	45.31	74.00	-28.69	peak
6	p15960.000	14.30	41.52	62.95	56.20	49.07	74.00	-24.93	peak



Unless otherwise agreed in writing, this document is issued by the Company subject to its General Conditions of Service printed overleaf, available on request or accessible at <https://www.sgs.com/en/Terms-and-Conditions>. Attention is drawn to the limitation of liability, indemnification and jurisdiction issues defined therein. Any holder of this document is advised that information contained hereon reflects the Company's findings at the time of its intervention only and within the limits of Client's instructions, if any. The Company's sole responsibility is to its Client and this document does not exonerate parties to a transaction from exercising all their rights and obligations under the transaction documents. This document cannot be reproduced except in full, without prior written approval of the Company. Any unauthorized alteration, forgery or falsification of the content or appearance of this document is unlawful and offenders may be prosecuted to the fullest extent of the law. Unless otherwise stated the results shown in this test report refer only to the sample(s) tested and such sample(s) are retained for 30 days only.

Test Mode: 06; Polarity: Horizontal; Modulation:802.11n; Bandwidth:40MHz; Channel:Low

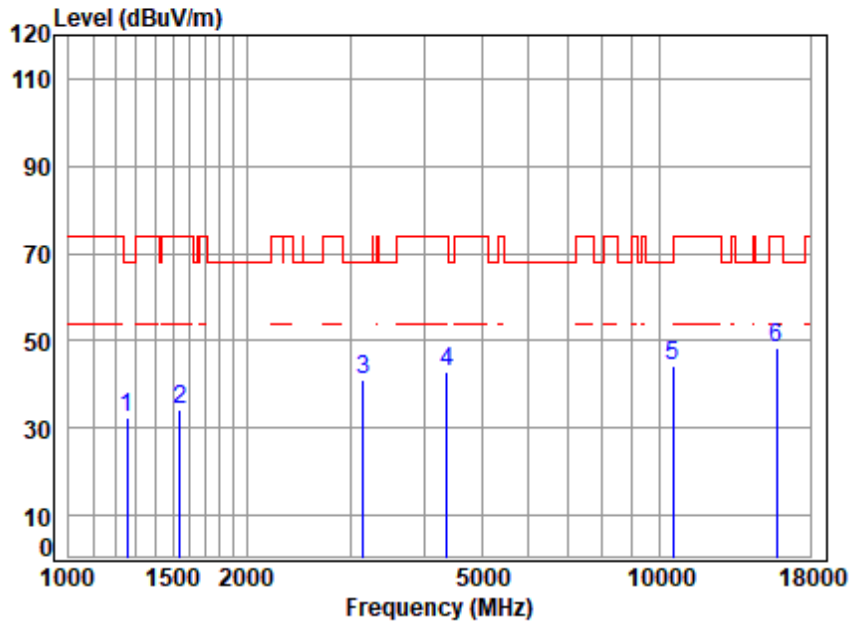

Site : chamber
 Condition: 3m HORIZONTAL
 Job No : 03018AT\03019AT
 Mode : 5270 TX RSE
 Note : 5G WIFI 11N40

	Freq	Cable Loss	Ant Factor	Preamp Factor	Read Level	Level	Limit Line	Over Limit	Remark
	MHz	dB	dB/m	dB	dBuV	dBuV/m	dBuV/m	dB	
1	1256.512	3.76	25.06	61.58	65.02	32.26	68.20	-35.94	peak
2	1542.733	4.10	26.97	61.67	64.68	34.08	74.00	-39.92	peak
3	3150.237	6.21	32.50	61.38	63.90	41.23	68.20	-26.97	peak
4	4367.058	7.10	34.54	61.51	62.85	42.98	74.00	-31.02	peak
5	10540.000	11.39	37.30	62.40	58.05	44.34	68.20	-23.86	peak
6	15810.000	14.12	41.31	62.93	56.09	48.59	74.00	-25.41	peak



Unless otherwise agreed in writing, this document is issued by the Company subject to its General Conditions of Service printed overleaf, available on request or accessible at <https://www.sgs.com/en/Terms-and-Conditions>. Attention is drawn to the limitation of liability, indemnification and jurisdiction issues defined therein. Any holder of this document is advised that information contained hereon reflects the Company's findings at the time of its intervention only and within the limits of Client's instructions, if any. The Company's sole responsibility is to its Client and this document does not exonerate parties to a transaction from exercising all their rights and obligations under the transaction documents. This document cannot be reproduced except in full, without prior written approval of the Company. Any unauthorized alteration, forgery or falsification of the content or appearance of this document is unlawful and offenders may be prosecuted to the fullest extent of the law. Unless otherwise stated the results shown in this test report refer only to the sample(s) tested and such sample(s) are retained for 30 days only.

Test Mode: 06; Polarity: Vertical; Modulation:802.11n; Bandwidth:40MHz; Channel:Low

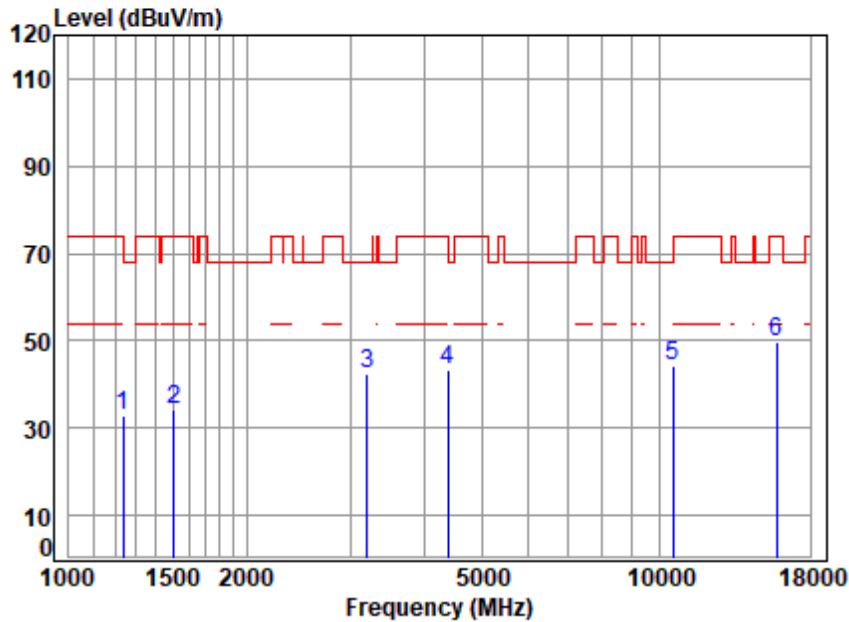

Site : chamber
 Condition: 3m VERTICAL
 Job No : 03018AT\03019AT
 Mode : 5270 TX RSE
 Note : 5G WIFI 11N40

	Freq	Cable Loss	Ant Factor	Preamp Factor	Read Level	Level	Limit Line	Over Limit	Remark
	MHz	dB	dB/m	dB	dBuV	dBuV/m	dBuV/m	dB	
1	1234.909	3.73	24.89	61.57	65.61	32.66	74.00	-41.34	peak
2	1507.470	4.05	26.83	61.66	65.09	34.31	74.00	-39.69	peak
3	3205.345	6.26	32.81	61.36	64.55	42.26	68.20	-25.94	peak
4	4379.699	7.11	34.64	61.52	63.26	43.49	74.00	-30.51	peak
5	10540.000	11.39	37.30	62.40	58.05	44.34	68.20	-23.86	peak
6	15810.000	14.12	41.31	62.93	57.15	49.65	74.00	-24.35	peak



Unless otherwise agreed in writing, this document is issued by the Company subject to its General Conditions of Service printed overleaf, available on request or accessible at <https://www.sgs.com/en/Terms-and-Conditions>. Attention is drawn to the limitation of liability, indemnification and jurisdiction issues defined therein. Any holder of this document is advised that information contained hereon reflects the Company's findings at the time of its intervention only and within the limits of Client's instructions, if any. The Company's sole responsibility is to its Client and this document does not exonerate parties to a transaction from exercising all their rights and obligations under the transaction documents. This document cannot be reproduced except in full, without prior written approval of the Company. Any unauthorized alteration, forgery or falsification of the content or appearance of this document is unlawful and offenders may be prosecuted to the fullest extent of the law. Unless otherwise stated the results shown in this test report refer only to the sample(s) tested and such sample(s) are retained for 30 days only.

Test Mode: 06; Polarity: Horizontal; Modulation:802.11n; Bandwidth:40MHz; Channel:High

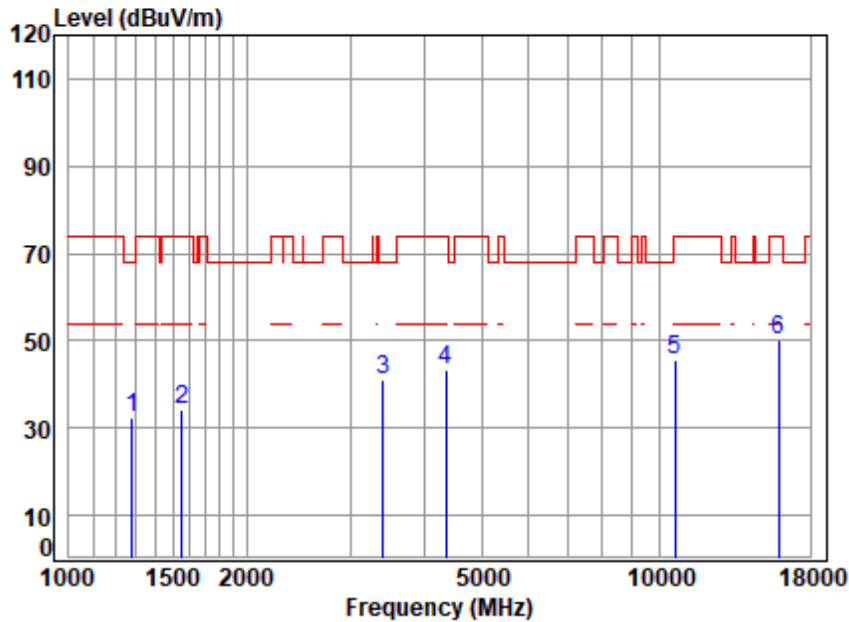

Site : chamber
 Condition: 3m HORIZONTAL
 Job No : 03018AT\03019AT
 Mode : 5310 TX RSE
 Note : 5G WIFI 11N40

	Freq	Cable Loss	Ant Factor	Preamp Factor	Read Level	Level	Limit	Over	Remark
	MHz	dB	dB/m	dB	dBuV	dBuV/m	dBuV/m	dB	
1	1278.492	3.78	24.93	61.58	65.17	32.30	68.20	-35.90	peak
2	1556.169	4.12	26.98	61.67	64.97	34.40	74.00	-39.60	peak
3	3405.929	6.44	32.33	61.31	63.69	41.15	68.20	-27.05	peak
4	4354.454	7.08	34.44	61.50	63.37	43.39	74.00	-30.61	peak
5	10620.000	11.44	37.26	62.42	59.34	45.62	74.00	-28.38	peak
6	p15930.000	14.27	41.46	62.95	57.24	50.02	74.00	-23.98	peak



Unless otherwise agreed in writing, this document is issued by the Company subject to its General Conditions of Service printed overleaf, available on request or accessible at <https://www.sgs.com/en/Terms-and-Conditions>. Attention is drawn to the limitation of liability, indemnification and jurisdiction issues defined therein. Any holder of this document is advised that information contained hereon reflects the Company's findings at the time of its intervention only and within the limits of Client's instructions, if any. The Company's sole responsibility is to its Client and this document does not exonerate parties to a transaction from exercising all their rights and obligations under the transaction documents. This document cannot be reproduced except in full, without prior written approval of the Company. Any unauthorized alteration, forgery or falsification of the content or appearance of this document is unlawful and offenders may be prosecuted to the fullest extent of the law. Unless otherwise stated the results shown in this test report refer only to the sample(s) tested and such sample(s) are retained for 30 days only.

Test Mode: 06; Polarity: Vertical; Modulation:802.11n; Bandwidth:40MHz; Channel:High

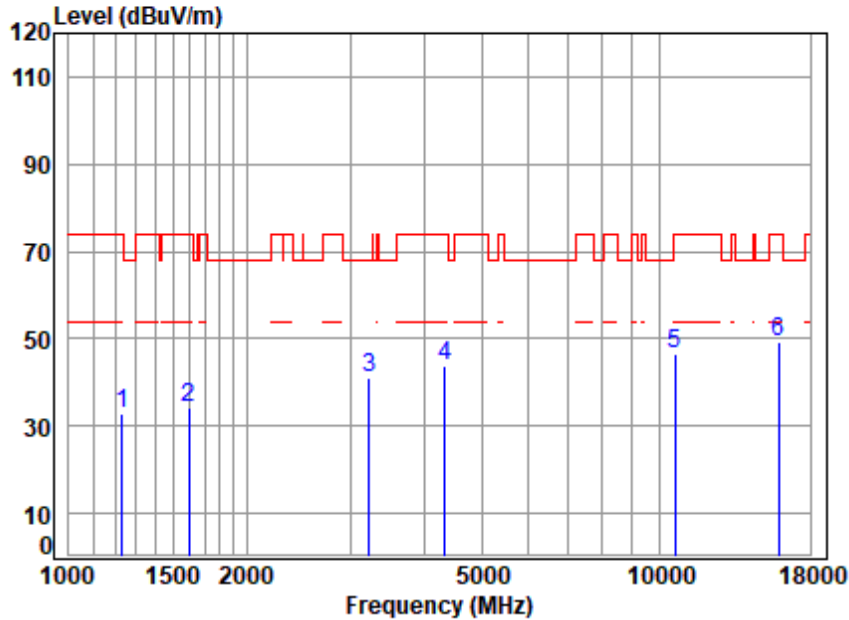

Site : chamber
 Condition: 3m VERTICAL
 Job No : 03018AT\03019AT
 Mode : 5310 TX RSE
 Note : 5G WIFI 11N40

	Freq	Cable Loss	Ant Factor	Preamp Factor	Read Level	Level	Limit Line	Over Limit	Remark
	MHz	dB	dB/m	dB	dBuV	dBuV/m	dBuV/m	dB	
1	1231.345	3.72	24.84	61.57	65.87	32.86	74.00	-41.14	peak
2	1597.181	4.18	26.81	61.69	64.95	34.25	74.00	-39.75	peak
3	3223.928	6.28	32.52	61.36	63.73	41.17	68.20	-27.03	peak
4	4341.886	7.07	34.34	61.49	63.77	43.69	74.00	-30.31	peak
5	10620.000	11.44	37.26	62.42	60.08	46.36	74.00	-27.64	peak
6	p15930.000	14.27	41.46	62.95	56.58	49.36	74.00	-24.64	peak



Unless otherwise agreed in writing, this document is issued by the Company subject to its General Conditions of Service printed overleaf, available on request or accessible at <https://www.sgs.com/en/Terms-and-Conditions>. Attention is drawn to the limitation of liability, indemnification and jurisdiction issues defined therein. Any holder of this document is advised that information contained hereon reflects the Company's findings at the time of its intervention only and within the limits of Client's instructions, if any. The Company's sole responsibility is to its Client and this document does not exonerate parties to a transaction from exercising all their rights and obligations under the transaction documents. This document cannot be reproduced except in full, without prior written approval of the Company. Any unauthorized alteration, forgery or falsification of the content or appearance of this document is unlawful and offenders may be prosecuted to the fullest extent of the law. Unless otherwise stated the results shown in this test report refer only to the sample(s) tested and such sample(s) are retained for 30 days only.

Test Mode: 06; Polarity: Horizontal; Modulation:802.11 ax(Full RU0); Bandwidth:20MHz; Channel:Low

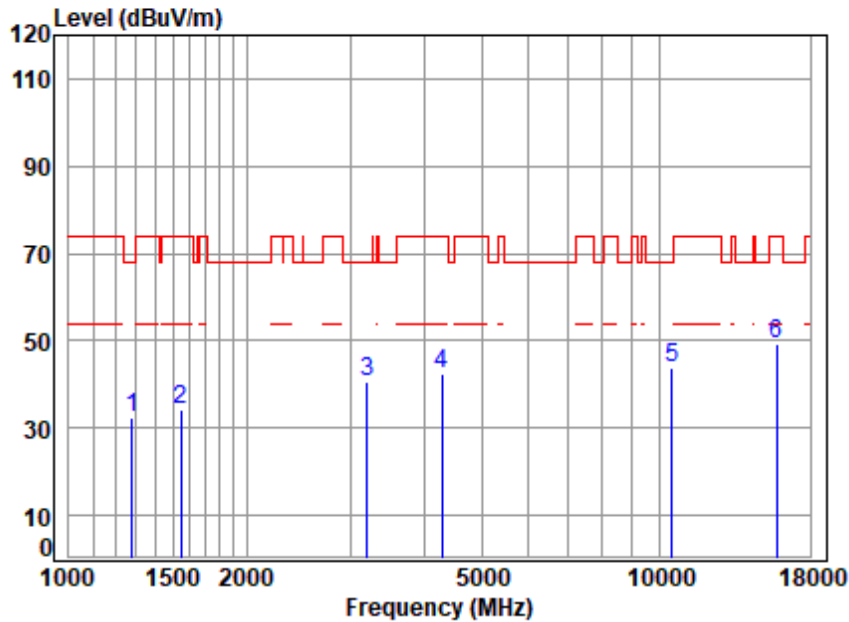

Site : chamber
 Condition: 3m HORIZONTAL
 Job No : 03018AT\03019AT
 Mode : 5260 TX RSE
 Note : 5G WIFI 11AX20

	Freq	Cable Loss	Ant Factor	Preamp Factor	Read Level	Level	Limit Line	Over Limit	Remark
	MHz	dB	dB/m	dB	dBuV	dBuV/m	dBuV/m	dB	
1	1282.193	3.79	24.91	61.58	65.13	32.25	68.20	-35.95	peak
2	1547.199	4.11	26.99	61.67	65.01	34.44	74.00	-39.56	peak
3	3205.345	6.26	32.81	61.36	62.86	40.57	68.20	-27.63	peak
4	4291.977	7.01	33.97	61.44	62.91	42.45	74.00	-31.55	peak
5	10520.000	11.37	37.30	62.39	57.66	43.94	68.20	-24.26	peak
6	15780.000	14.08	41.28	62.92	57.00	49.44	74.00	-24.56	peak



Unless otherwise agreed in writing, this document is issued by the Company subject to its General Conditions of Service printed overleaf, available on request or accessible at <https://www.sgs.com/en/Terms-and-Conditions>. Attention is drawn to the limitation of liability, indemnification and jurisdiction issues defined therein. Any holder of this document is advised that information contained hereon reflects the Company's findings at the time of its intervention only and within the limits of Client's instructions, if any. The Company's sole responsibility is to its Client and this document does not exonerate parties to a transaction from exercising all their rights and obligations under the transaction documents. This document cannot be reproduced except in full, without prior written approval of the Company. Any unauthorized alteration, forgery or falsification of the content or appearance of this document is unlawful and offenders may be prosecuted to the fullest extent of the law. Unless otherwise stated the results shown in this test report refer only to the sample(s) tested and such sample(s) are retained for 30 days only.

Test Mode: 06; Polarity: Vertical; Modulation:802.11ax(Full RU0); Bandwidth:20MHz; Channel:Low

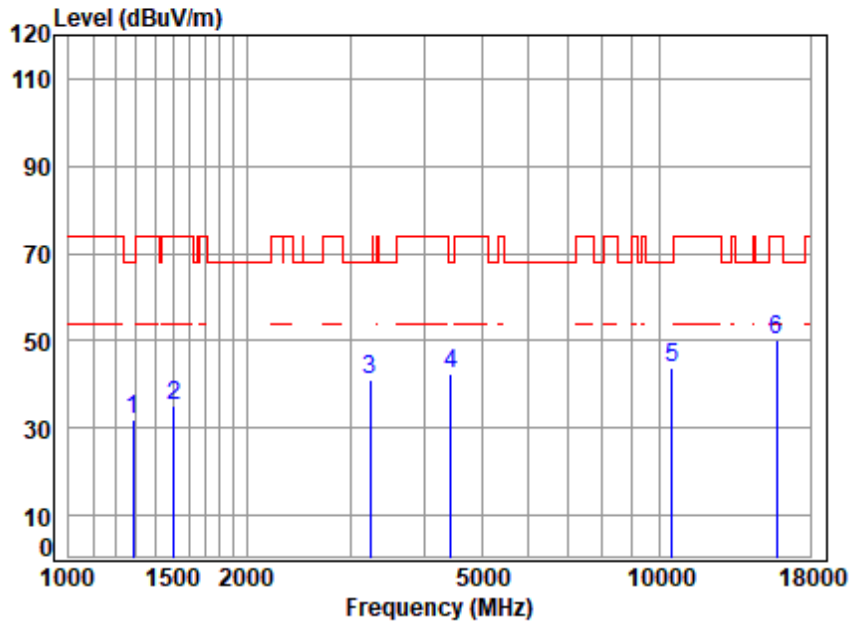

Site : chamber
 Condition: 3m VERTICAL
 Job No : 03018AT\03019AT
 Mode : 5260 TX RSE
 Note : 5G WIFI 11AX20

	Freq	Cable Loss	Ant Factor	Preamp Factor	Read Level	Level	Limit Line	Over Limit	Remark
	MHz	dB	dB/m	dB	dBuV	dBuV/m	dBuV/m	dB	
1	1285.904	3.79	24.88	61.59	65.01	32.09	68.20	-36.11	peak
2	1507.470	4.05	26.83	61.66	65.73	34.95	74.00	-39.05	peak
3	3233.260	6.29	32.37	61.35	63.54	40.85	68.20	-27.35	peak
4	4443.453	7.19	34.28	61.58	62.59	42.48	68.20	-25.72	peak
5	10520.000	11.37	37.30	62.39	57.66	43.94	68.20	-24.26	peak
6	p15780.000	14.08	41.28	62.92	57.63	50.07	74.00	-23.93	peak



Unless otherwise agreed in writing, this document is issued by the Company subject to its General Conditions of Service printed overleaf, available on request or accessible at <https://www.sgs.com/en/Terms-and-Conditions>. Attention is drawn to the limitation of liability, indemnification and jurisdiction issues defined therein. Any holder of this document is advised that information contained hereon reflects the Company's findings at the time of its intervention only and within the limits of Client's instructions, if any. The Company's sole responsibility is to its Client and this document does not exonerate parties to a transaction from exercising all their rights and obligations under the transaction documents. This document cannot be reproduced except in full, without prior written approval of the Company. Any unauthorized alteration, forgery or falsification of the content or appearance of this document is unlawful and offenders may be prosecuted to the fullest extent of the law. Unless otherwise stated the results shown in this test report refer only to the sample(s) tested and such sample(s) are retained for 30 days only.

Test Mode: 06; Polarity: Horizontal; Modulation:802.11ax(Full RU0); Bandwidth:20MHz; Channel:middle

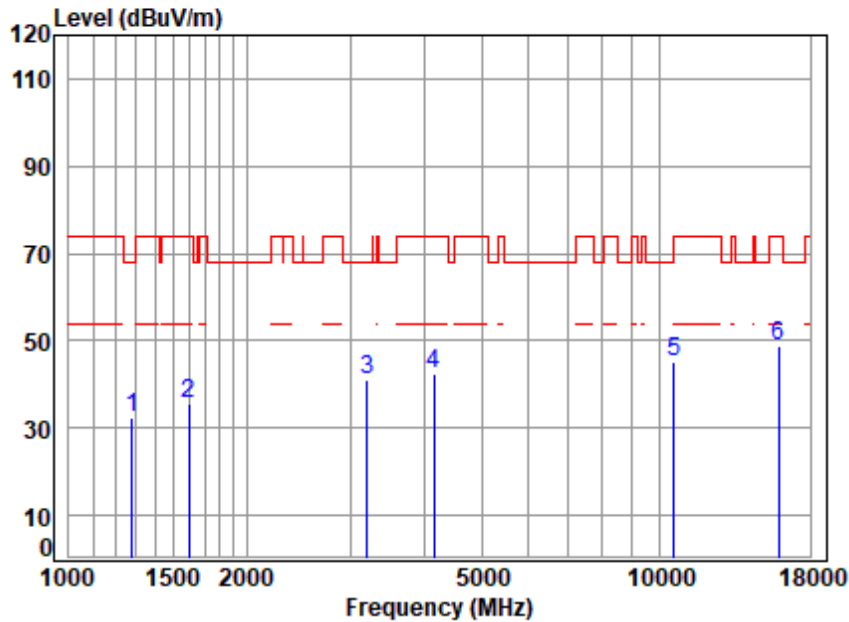

Site : chamber
 Condition: 3m HORIZONTAL
 Job No : 03018AT\03019AT
 Mode : 5300 TX RSE
 Note : 5G WIFI 11AX20

	Freq	Cable Loss	Ant Factor	Preamp Factor	Read Level	Level	Limit Line	Over Limit	Remark
	MHz	dB	dB/m	dB	dBuV	dBuV/m	dBuV/m	dB	
1	1282.193	3.79	24.91	61.58	65.48	32.60	68.20	-35.60	peak
2	1597.181	4.18	26.81	61.69	66.19	35.49	74.00	-38.51	peak
3	3205.345	6.26	32.81	61.36	63.19	40.90	68.20	-27.30	peak
4	4145.664	6.83	33.73	61.31	63.08	42.33	74.00	-31.67	peak
5	10600.000	11.43	37.30	62.41	58.88	45.20	68.20	-23.00	peak
6	15900.000	14.23	41.40	62.94	56.16	48.85	74.00	-25.15	peak



Unless otherwise agreed in writing, this document is issued by the Company subject to its General Conditions of Service printed overleaf, available on request or accessible at <https://www.sgs.com/en/Terms-and-Conditions>. Attention is drawn to the limitation of liability, indemnification and jurisdiction issues defined therein. Any holder of this document is advised that information contained hereon reflects the Company's findings at the time of its intervention only and within the limits of Client's instructions, if any. The Company's sole responsibility is to its Client and this document does not exonerate parties to a transaction from exercising all their rights and obligations under the transaction documents. This document cannot be reproduced except in full, without prior written approval of the Company. Any unauthorized alteration, forgery or falsification of the content or appearance of this document is unlawful and offenders may be prosecuted to the fullest extent of the law. Unless otherwise stated the results shown in this test report refer only to the sample(s) tested and such sample(s) are retained for 30 days only.

Test Mode: 06; Polarity: Vertical; Modulation:802.11ax(Full RU0); Bandwidth:20MHz; Channel:middle

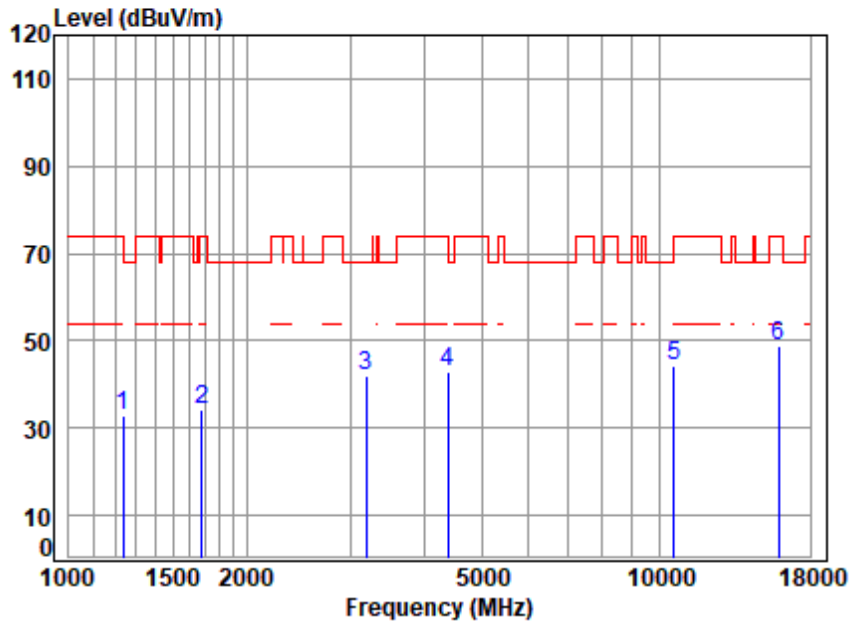

Site : chamber
 Condition: 3m VERTICAL
 Job No : 03018AT\03019AT
 Mode : 5300 TX RSE
 Note : 5G WIFI 11AX20

	Freq	Cable Loss	Ant Factor	Preamp Factor	Read Level	Limit Level	Over Limit	Remark
	MHz	dB	dB/m	dB	dBuV	dBuV/m	dBuV/m	dB
1	1234.909	3.73	24.89	61.57	65.97	33.02	74.00	-40.98 peak
2	1677.621	4.29	26.24	61.71	65.42	34.24	74.00	-39.76 peak
3	3186.869	6.25	32.79	61.37	64.30	41.97	68.20	-26.23 peak
4	4392.376	7.13	34.74	61.53	62.76	43.10	74.00	-30.90 peak
5	10600.000	11.43	37.30	62.41	57.90	44.22	68.20	-23.98 peak
6	15900.000	14.23	41.40	62.94	56.20	48.89	74.00	-25.11 peak



Unless otherwise agreed in writing, this document is issued by the Company subject to its General Conditions of Service printed overleaf, available on request or accessible at <https://www.sgs.com/en/Terms-and-Conditions>. Attention is drawn to the limitation of liability, indemnification and jurisdiction issues defined therein. Any holder of this document is advised that information contained hereon reflects the Company's findings at the time of its intervention only and within the limits of Client's instructions, if any. The Company's sole responsibility is to its Client and this document does not exonerate parties to a transaction from exercising all their rights and obligations under the transaction documents. This document cannot be reproduced except in full, without prior written approval of the Company. Any unauthorized alteration, forgery or falsification of the content or appearance of this document is unlawful and offenders may be prosecuted to the fullest extent of the law. Unless otherwise stated the results shown in this test report refer only to the sample(s) tested and such sample(s) are retained for 30 days only.

Test Mode: 06; Polarity: Horizontal; Modulation:802.11ax(Full RU0); Bandwidth:20MHz; Channel:High

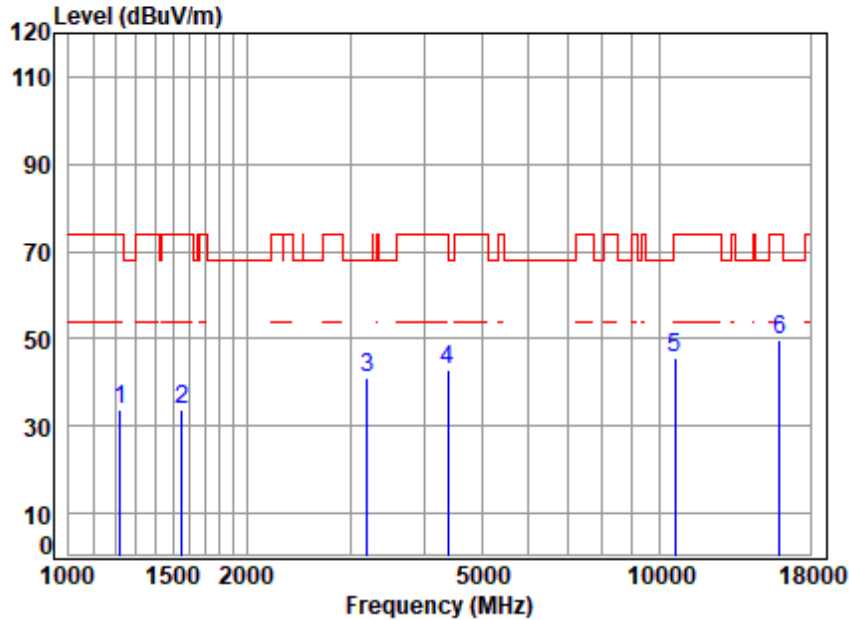

Site : chamber
 Condition: 3m HORIZONTAL
 Job No : 03018AT\03019AT
 Mode : 5320 TX RSE
 Note : 5G WIFI 11AX20

	Cable	Ant	Preamp	Read	Limit	Over		
Freq	Loss	Factor	Factor	Level	Level	Line	Limit	Remark
MHz	dB	dB/m	dB	dBuV	dBuV/m	dBuV/m	dB	
1	1224.247	3.71	24.74	61.56	66.84	33.73	74.00	-40.27 peak
2	1556.169	4.12	26.98	61.67	64.43	33.86	74.00	-40.14 peak
3	3196.094	6.25	32.87	61.36	63.22	40.98	68.20	-27.22 peak
4	4379.699	7.11	34.64	61.52	62.55	42.78	74.00	-31.22 peak
5	10640.000	11.45	37.22	62.42	59.35	45.60	74.00	-28.40 peak
6	p15960.000	14.30	41.52	62.95	57.02	49.89	74.00	-24.11 peak



Unless otherwise agreed in writing, this document is issued by the Company subject to its General Conditions of Service printed overleaf, available on request or accessible at <https://www.sgs.com/en/Terms-and-Conditions>. Attention is drawn to the limitation of liability, indemnification and jurisdiction issues defined therein. Any holder of this document is advised that information contained hereon reflects the Company's findings at the time of its intervention only and within the limits of Client's instructions, if any. The Company's sole responsibility is to its Client and this document does not exonerate parties to a transaction from exercising all their rights and obligations under the transaction documents. This document cannot be reproduced except in full, without prior written approval of the Company. Any unauthorized alteration, forgery or falsification of the content or appearance of this document is unlawful and offenders may be prosecuted to the fullest extent of the law. Unless otherwise stated the results shown in this test report refer only to the sample(s) tested and such sample(s) are retained for 30 days only.

Test Mode: 06; Polarity: Vertical; Modulation:802.11ax(Full RU0); Bandwidth:20MHz; Channel:High

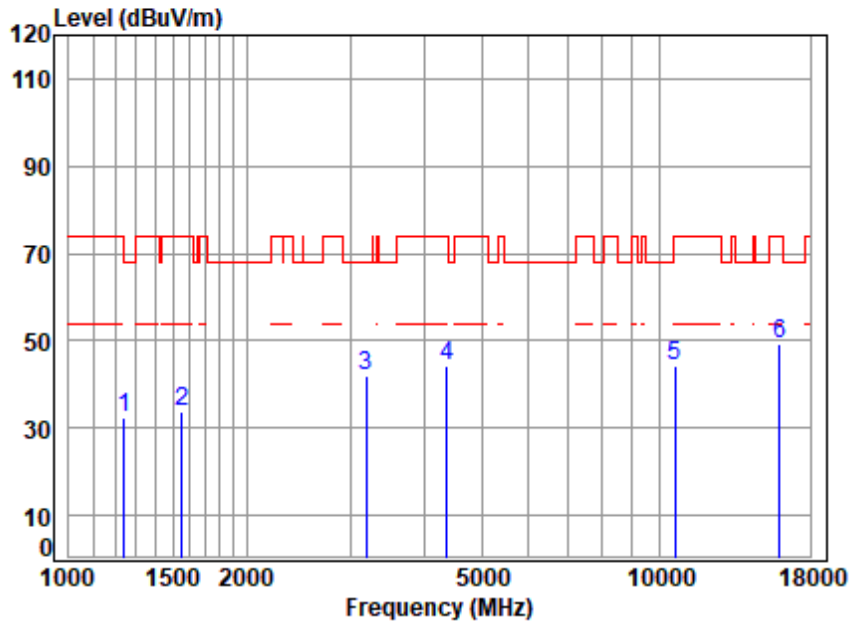

Site : chamber
 Condition: 3m VERTICAL
 Job No : 03018AT\03019AT
 Mode : 5320 TX RSE
 Note : 5G WIFI 11AX20

	Freq	Cable Loss	Ant Factor	Preamp Factor	Read Level	Level	Limit Line	Over Limit	Remark
	MHz	dB	dB/m	dB	dBuV	dBuV/m	dBuV/m	dB	
1	1242.068	3.74	24.99	61.57	65.09	32.25	68.20	-35.95	peak
2	1556.169	4.12	26.98	61.67	64.39	33.82	74.00	-40.18	peak
3	3186.869	6.25	32.79	61.37	64.38	42.05	68.20	-26.15	peak
4	4367.058	7.10	34.54	61.51	64.11	44.24	74.00	-29.76	peak
5	10640.000	11.45	37.22	62.42	58.12	44.37	74.00	-29.63	peak
6	p15960.000	14.30	41.52	62.95	56.22	49.09	74.00	-24.91	peak



Unless otherwise agreed in writing, this document is issued by the Company subject to its General Conditions of Service printed overleaf, available on request or accessible at <https://www.sgs.com/en/Terms-and-Conditions>. Attention is drawn to the limitation of liability, indemnification and jurisdiction issues defined therein. Any holder of this document is advised that information contained hereon reflects the Company's findings at the time of its intervention only and within the limits of Client's instructions, if any. The Company's sole responsibility is to its Client and this document does not exonerate parties to a transaction from exercising all their rights and obligations under the transaction documents. This document cannot be reproduced except in full, without prior written approval of the Company. Any unauthorized alteration, forgery or falsification of the content or appearance of this document is unlawful and offenders may be prosecuted to the fullest extent of the law. Unless otherwise stated the results shown in this test report refer only to the sample(s) tested and such sample(s) are retained for 30 days only.

Test Mode: 06; Polarity: Horizontal; Modulation:802.11 ax(Full RU0); Bandwidth:40MHz; Channel:Low

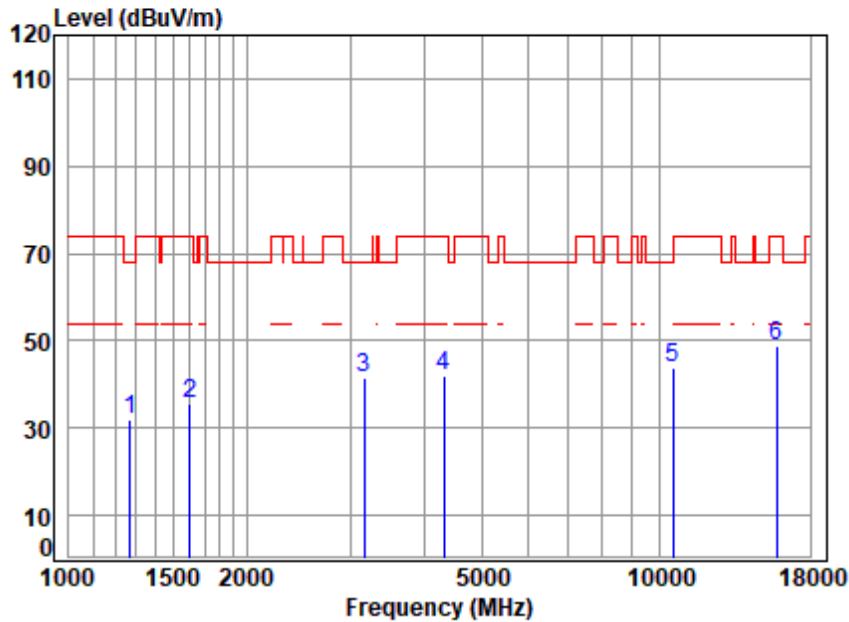

Site : chamber
 Condition: 3m HORIZONTAL
 Job No : 03018AT\03019AT
 Mode : 5270 TX RSE
 Note : 5G WIFI 11AX40

	Freq	Cable Loss	Ant Factor	Preamp Factor	Read Level	Level	Limit Line	Over Limit	Remark
	MHz	dB	dB/m	dB	dBuV	dBuV/m	dBuV/m	dB	
1	1271.123	3.77	24.97	61.58	64.97	32.13	68.20	-36.07	peak
2	1606.441	4.19	26.74	61.69	66.29	35.53	74.00	-38.47	peak
3	3168.500	6.23	32.65	61.37	64.03	41.54	68.20	-26.66	peak
4	4316.859	7.04	34.13	61.47	62.50	42.20	74.00	-31.80	peak
5	10540.000	11.39	37.30	62.40	57.42	43.71	68.20	-24.49	peak
6	15810.000	14.12	41.31	62.93	56.34	48.84	74.00	-25.16	peak



Unless otherwise agreed in writing, this document is issued by the Company subject to its General Conditions of Service printed overleaf, available on request or accessible at <https://www.sgs.com/en/Terms-and-Conditions>. Attention is drawn to the limitation of liability, indemnification and jurisdiction issues defined therein. Any holder of this document is advised that information contained hereon reflects the Company's findings at the time of its intervention only and within the limits of Client's instructions, if any. The Company's sole responsibility is to its Client and this document does not exonerate parties to a transaction from exercising all their rights and obligations under the transaction documents. This document cannot be reproduced except in full, without prior written approval of the Company. Any unauthorized alteration, forgery or falsification of the content or appearance of this document is unlawful and offenders may be prosecuted to the fullest extent of the law. Unless otherwise stated the results shown in this test report refer only to the sample(s) tested and such sample(s) are retained for 30 days only.

Test Mode: 06; Polarity: Vertical; Modulation:802.11ax(Full RU0); Bandwidth:40MHz; Channel:Low

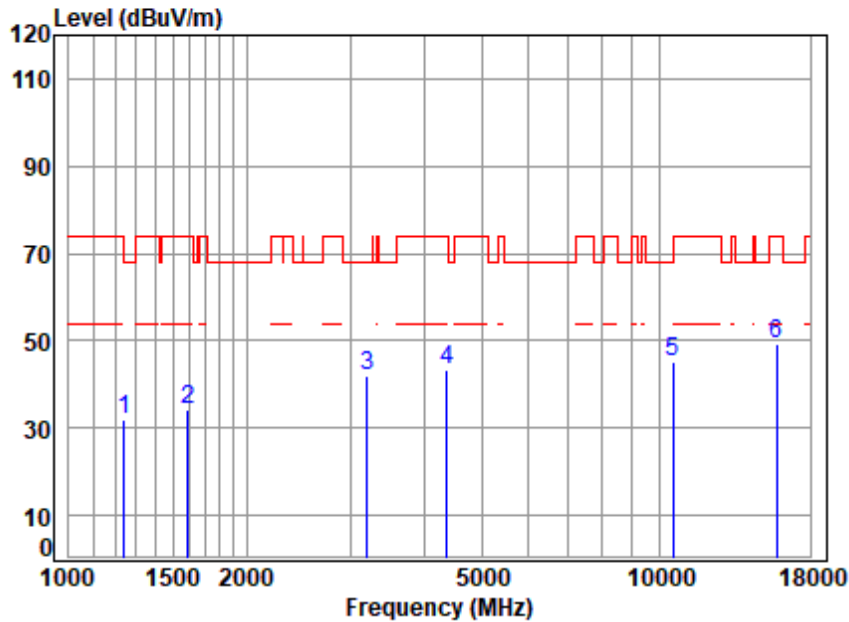

Site : chamber
 Condition: 3m VERTICAL
 Job No : 03018AT\03019AT
 Mode : 5270 TX RSE
 Note : 5G WIFI 11AX40

	Freq	Cable Loss	Ant Factor	Preamp Factor	Read Level	Level	Limit Line	Over Limit	Remark
	MHz	dB	dB/m	dB	dBuV	dBuV/m	dBuV/m	dB	
1	1242.068	3.74	24.99	61.57	64.56	31.72	68.20	-36.48	peak
2	1592.571	4.18	26.83	61.68	65.00	34.33	74.00	-39.67	peak
3	3205.345	6.26	32.81	61.36	64.34	42.05	68.20	-26.15	peak
4	4367.058	7.10	34.54	61.51	63.01	43.14	74.00	-30.86	peak
5	10540.000	11.39	37.30	62.40	58.83	45.12	68.20	-23.08	peak
6	15810.000	14.12	41.31	62.93	56.65	49.15	74.00	-24.85	peak



Unless otherwise agreed in writing, this document is issued by the Company subject to its General Conditions of Service printed overleaf, available on request or accessible at <https://www.sgs.com/en/Terms-and-Conditions>. Attention is drawn to the limitation of liability, indemnification and jurisdiction issues defined therein. Any holder of this document is advised that information contained hereon reflects the Company's findings at the time of its intervention only and within the limits of Client's instructions, if any. The Company's sole responsibility is to its Client and this document does not exonerate parties to a transaction from exercising all their rights and obligations under the transaction documents. This document cannot be reproduced except in full, without prior written approval of the Company. Any unauthorized alteration, forgery or falsification of the content or appearance of this document is unlawful and offenders may be prosecuted to the fullest extent of the law. Unless otherwise stated the results shown in this test report refer only to the sample(s) tested and such sample(s) are retained for 30 days only.

Test Mode: 06; Polarity: Horizontal; Modulation:802.11ax(Full RU0); Bandwidth:40MHz; Channel:High

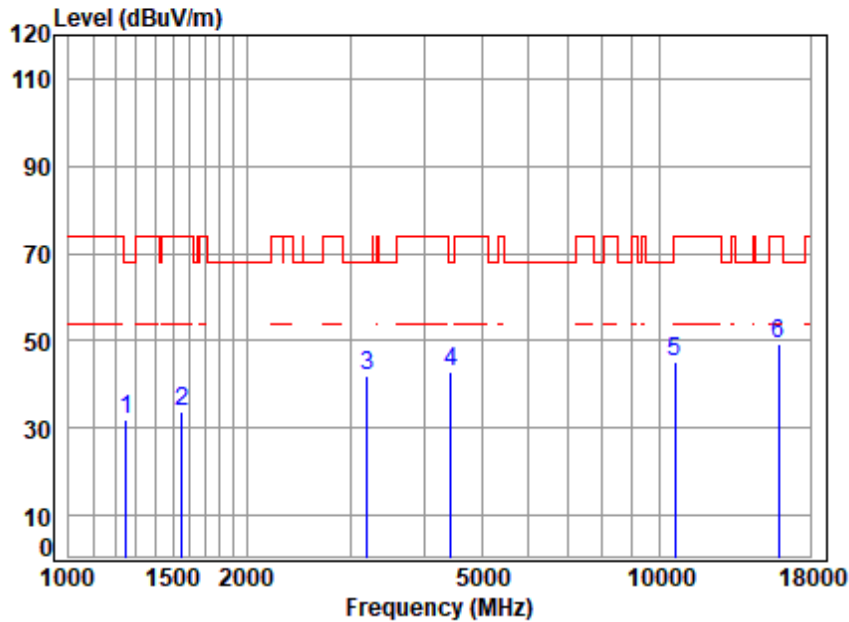

Site : chamber
 Condition: 3m HORIZONTAL
 Job No : 03018AT\03019AT
 Mode : 5310 TX RSE
 Note : 5G WIFI 11AX40

	Freq	Cable Loss	Ant Factor	Preamp Factor	Read Level	Level	Limit Line	Over Limit	Remark
	MHz	dB	dB/m	dB	dBuV	dBuV/m	dBuV/m	dB	
1	1249.269	3.75	25.09	61.57	64.83	32.10	68.20	-36.10	peak
2	1556.169	4.12	26.98	61.67	64.26	33.69	74.00	-40.31	peak
3	3196.094	6.25	32.87	61.36	64.14	41.90	68.20	-26.30	peak
4	4443.453	7.19	34.28	61.58	62.92	42.81	68.20	-25.39	peak
5	10620.000	11.44	37.26	62.42	58.90	45.18	74.00	-28.82	peak
6	p15930.000	14.27	41.46	62.95	56.56	49.34	74.00	-24.66	peak



Unless otherwise agreed in writing, this document is issued by the Company subject to its General Conditions of Service printed overleaf, available on request or accessible at <https://www.sgs.com/en/Terms-and-Conditions>. Attention is drawn to the limitation of liability, indemnification and jurisdiction issues defined therein. Any holder of this document is advised that information contained hereon reflects the Company's findings at the time of its intervention only and within the limits of Client's instructions, if any. The Company's sole responsibility is to its Client and this document does not exonerate parties to a transaction from exercising all their rights and obligations under the transaction documents. This document cannot be reproduced except in full, without prior written approval of the Company. Any unauthorized alteration, forgery or falsification of the content or appearance of this document is unlawful and offenders may be prosecuted to the fullest extent of the law. Unless otherwise stated the results shown in this test report refer only to the sample(s) tested and such sample(s) are retained for 30 days only.

Test Mode: 06; Polarity: Vertical; Modulation:802.11ax(Full RU0); Bandwidth:40MHz; Channel:High

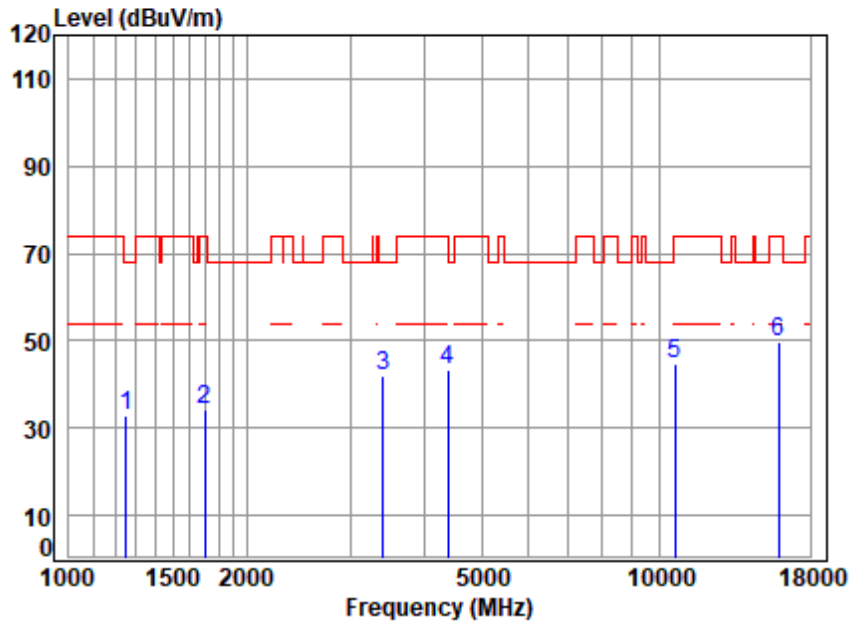

Site : chamber
 Condition: 3m VERTICAL
 Job No : 03018AT\03019AT
 Mode : 5310 TX RSE
 Note : 5G WIFI 11AX40

	Freq	Cable Loss	Ant Factor	Preamp Factor	Read Level	Level	Limit Line	Over Limit	Remark
	MHz	dB	dB/m	dB	dBuV	dBuV/m	dBuV/m	dB	
1	1249.269	3.75	25.09	61.57	65.40	32.67	68.20	-35.53	peak
2	1697.129	4.32	26.21	61.71	65.41	34.23	74.00	-39.77	peak
3	3405.929	6.44	32.33	61.31	64.43	41.89	68.20	-26.31	peak
4	4392.376	7.13	34.74	61.53	62.91	43.25	74.00	-30.75	peak
5	10620.000	11.44	37.26	62.42	58.53	44.81	74.00	-29.19	peak
6	p15930.000	14.27	41.46	62.95	56.81	49.59	74.00	-24.41	peak



Unless otherwise agreed in writing, this document is issued by the Company subject to its General Conditions of Service printed overleaf, available on request or accessible at <https://www.sgs.com/en/Terms-and-Conditions>. Attention is drawn to the limitation of liability, indemnification and jurisdiction issues defined therein. Any holder of this document is advised that information contained hereon reflects the Company's findings at the time of its intervention only and within the limits of Client's instructions, if any. The Company's sole responsibility is to its Client and this document does not exonerate parties to a transaction from exercising all their rights and obligations under the transaction documents. This document cannot be reproduced except in full, without prior written approval of the Company. Any unauthorized alteration, forgery or falsification of the content or appearance of this document is unlawful and offenders may be prosecuted to the fullest extent of the law. Unless otherwise stated the results shown in this test report refer only to the sample(s) tested and such sample(s) are retained for 30 days only.

Test Mode: 06; Polarity: Horizontal; Modulation:802.11ax(Full RU0); Bandwidth:80MHz; Channel:middle

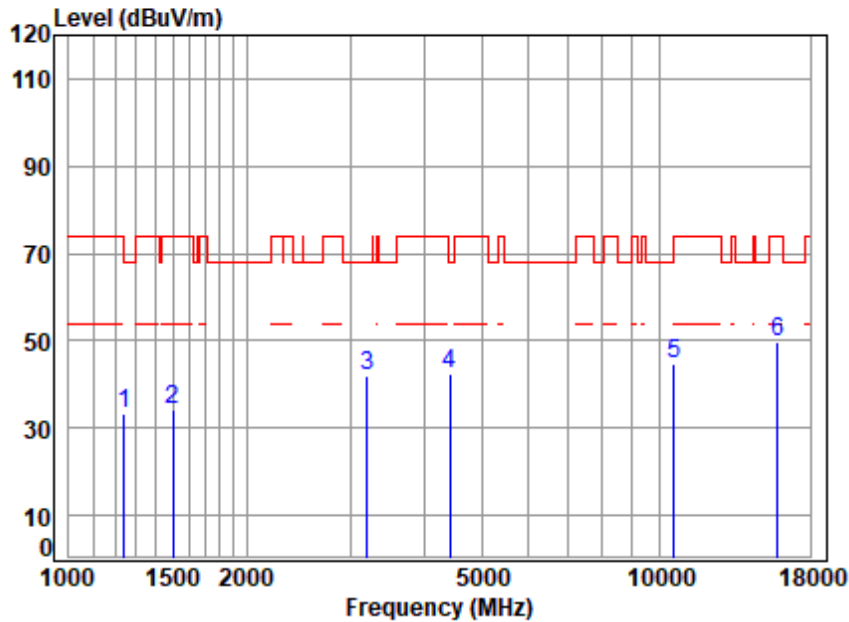

Site : chamber
 Condition: 3m HORIZONTAL
 Job No : 03018AT\03019AT
 Mode : 5290 TX RSE
 Note : 5G WIFI 11AX80

	Freq	Cable Loss	Ant Factor	Preamp Factor	Read Level	Level	Limit Line	Over Limit	Remark
	MHz	dB	dB/m	dB	dBuV	dBuV/m	dBuV/m	dB	
1	1242.068	3.74	24.99	61.57	66.17	33.33	68.20	-34.87	peak
2	1503.119	4.04	26.81	61.66	64.87	34.06	74.00	-39.94	peak
3	3196.094	6.25	32.87	61.36	64.09	41.85	68.20	-26.35	peak
4	4417.841	7.16	34.59	61.56	62.29	42.48	68.20	-25.72	peak
5	10580.000	11.41	37.30	62.41	58.24	44.54	68.20	-23.66	peak
6	15870.000	14.19	41.37	62.94	56.92	49.54	74.00	-24.46	peak



Unless otherwise agreed in writing, this document is issued by the Company subject to its General Conditions of Service printed overleaf, available on request or accessible at <https://www.sgs.com/en/Terms-and-Conditions>. Attention is drawn to the limitation of liability, indemnification and jurisdiction issues defined therein. Any holder of this document is advised that information contained hereon reflects the Company's findings at the time of its intervention only and within the limits of Client's instructions, if any. The Company's sole responsibility is to its Client and this document does not exonerate parties to a transaction from exercising all their rights and obligations under the transaction documents. This document cannot be reproduced except in full, without prior written approval of the Company. Any unauthorized alteration, forgery or falsification of the content or appearance of this document is unlawful and offenders may be prosecuted to the fullest extent of the law. Unless otherwise stated the results shown in this test report refer only to the sample(s) tested and such sample(s) are retained for 30 days only.

Test Mode: 06; Polarity: Vertical; Modulation:802.11ax(Full RU0); Bandwidth:80MHz; Channel:middle

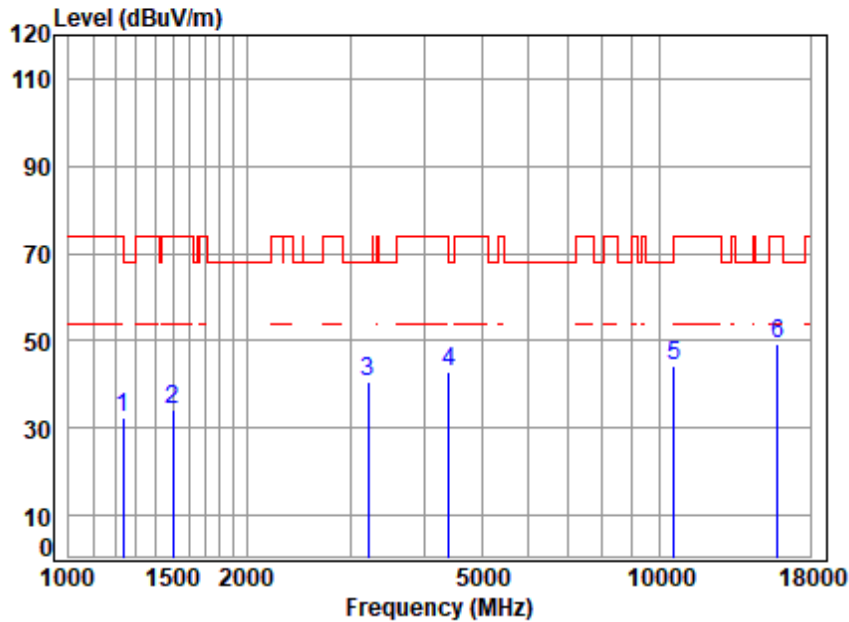

Site : chamber
 Condition: 3m VERTICAL
 Job No : 03018AT\03019AT
 Mode : 5290 TX RSE
 Note : 5G WIFI 11AX80

	Freq	Cable Loss	Ant Factor	Preamp Factor	Read Level	Level	Limit	Over	Remark
	MHz	dB	dB/m	dB	dBuV	dBuV/m	dBuV/m	dB	
1	1234.909	3.73	24.89	61.57	65.37	32.42	74.00	-41.58	peak
2	1503.119	4.04	26.81	61.66	64.85	34.04	74.00	-39.96	peak
3	3214.623	6.27	32.67	61.36	63.08	40.66	68.20	-27.54	peak
4	4405.090	7.14	34.74	61.55	62.57	42.90	68.20	-25.30	peak
5	10580.000	11.41	37.30	62.41	57.99	44.29	68.20	-23.91	peak
6	15870.000	14.19	41.37	62.94	56.82	49.44	74.00	-24.56	peak



Unless otherwise agreed in writing, this document is issued by the Company subject to its General Conditions of Service printed overleaf, available on request or accessible at <https://www.sgs.com/en/Terms-and-Conditions>. Attention is drawn to the limitation of liability, indemnification and jurisdiction issues defined therein. Any holder of this document is advised that information contained hereon reflects the Company's findings at the time of its intervention only and within the limits of Client's instructions, if any. The Company's sole responsibility is to its Client and this document does not exonerate parties to a transaction from exercising all their rights and obligations under the transaction documents. This document cannot be reproduced except in full, without prior written approval of the Company. Any unauthorized alteration, forgery or falsification of the content or appearance of this document is unlawful and offenders may be prosecuted to the fullest extent of the law. Unless otherwise stated the results shown in this test report refer only to the sample(s) tested and such sample(s) are retained for 30 days only.

Test Mode: 07; Polarity: Horizontal; Modulation:802.11a; Bandwidth:20MHz; Channel:Low

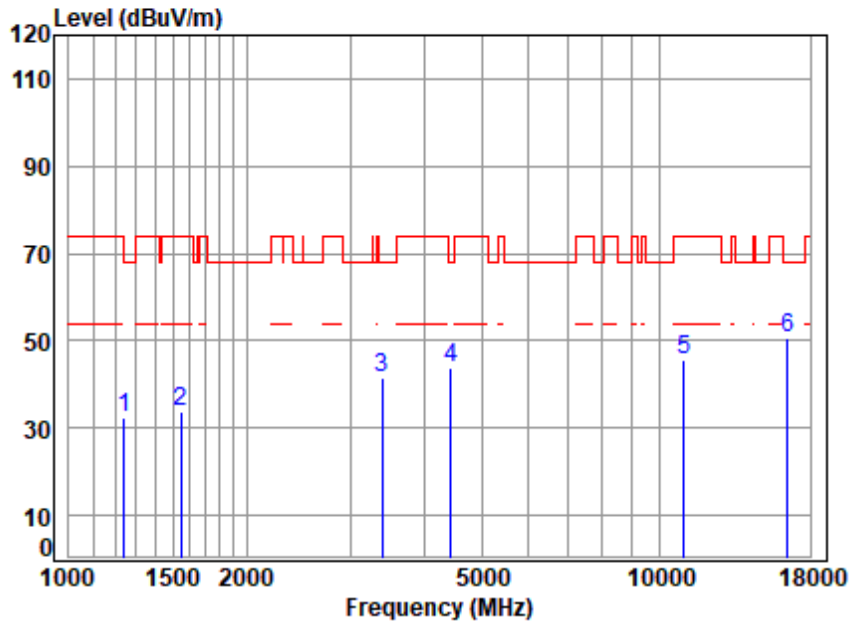

Site : chamber
 Condition: 3m HORIZONTAL
 Job No : 03018AT\03019AT
 Mode : 5500 TX RSE
 Note : 5G WIFI 11A

	Freq	Cable Loss	Ant Factor	Preamp Factor	Read Level	Level	Limit Line	Over Limit	Remark
	MHz	dB	dB/m	dB	dBuV	dBuV/m	dBuV/m	dB	
1	1242.068	3.74	24.99	61.57	65.40	32.56	68.20	-35.64	peak
2	1547.199	4.11	26.99	61.67	64.32	33.75	74.00	-40.25	peak
3	3396.098	6.43	32.38	61.31	63.98	41.48	68.20	-26.72	peak
4	4430.628	7.17	34.43	61.57	63.60	43.63	68.20	-24.57	peak
5	11000.000	11.68	37.50	62.51	58.76	45.43	74.00	-28.57	peak
6	p16500.000	13.99	42.10	62.42	56.97	50.64	68.20	-17.56	peak



Unless otherwise agreed in writing, this document is issued by the Company subject to its General Conditions of Service printed overleaf, available on request or accessible at <https://www.sgs.com/en/Terms-and-Conditions>. Attention is drawn to the limitation of liability, indemnification and jurisdiction issues defined therein. Any holder of this document is advised that information contained hereon reflects the Company's findings at the time of its intervention only and within the limits of Client's instructions, if any. The Company's sole responsibility is to its Client and this document does not exonerate parties to a transaction from exercising all their rights and obligations under the transaction documents. This document cannot be reproduced except in full, without prior written approval of the Company. Any unauthorized alteration, forgery or falsification of the content or appearance of this document is unlawful and offenders may be prosecuted to the fullest extent of the law. Unless otherwise stated the results shown in this test report refer only to the sample(s) tested and such sample(s) are retained for 30 days only.

Test Mode: 07; Polarity: Vertical; Modulation:802.11a; Bandwidth:20MHz; Channel:Low

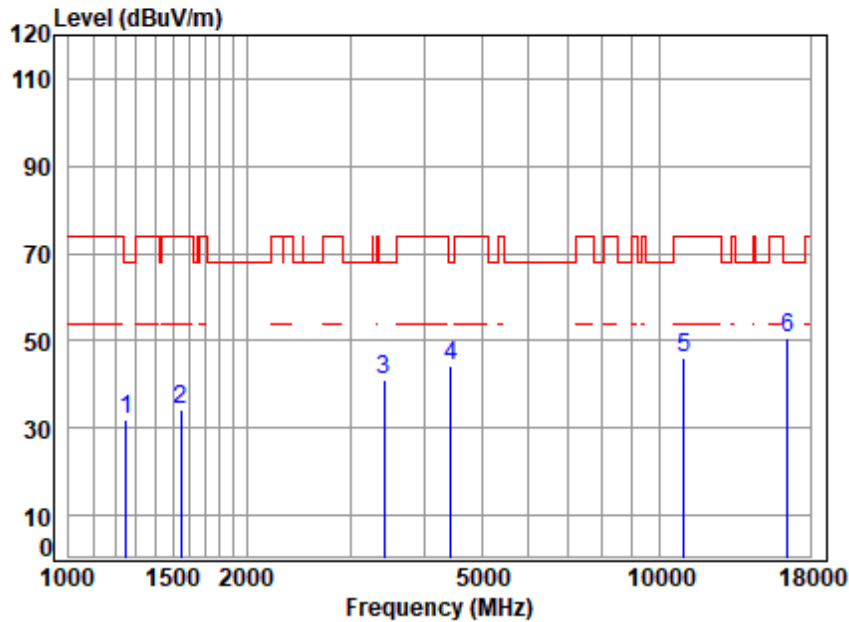

Site : chamber
 Condition: 3m VERTICAL
 Job No : 03018AT\03019AT
 Mode : 5500 TX RSE
 Note : 5G WIFI 11A

	Freq	Cable Loss	Ant Factor	Preamp Factor	Read Level	Level	Limit Line	Over Limit	Remark
	MHz	dB	dB/m	dB	dBuV	dBuV/m	dBuV/m	dB	
1	1249.269	3.75	25.09	61.57	64.66	31.93	68.20	-36.27	peak
2	1547.199	4.11	26.99	61.67	64.76	34.19	74.00	-39.81	peak
3	3415.787	6.45	32.21	61.31	63.88	41.23	68.20	-26.97	peak
4	4443.453	7.19	34.28	61.58	64.17	44.06	68.20	-24.14	peak
5	11000.000	11.68	37.50	62.51	59.34	46.01	74.00	-27.99	peak
6	p16500.000	13.99	42.10	62.42	56.75	50.42	68.20	-17.78	peak



Unless otherwise agreed in writing, this document is issued by the Company subject to its General Conditions of Service printed overleaf, available on request or accessible at <https://www.sgs.com/en/Terms-and-Conditions>. Attention is drawn to the limitation of liability, indemnification and jurisdiction issues defined therein. Any holder of this document is advised that information contained hereon reflects the Company's findings at the time of its intervention only and within the limits of Client's instructions, if any. The Company's sole responsibility is to its Client and this document does not exonerate parties to a transaction from exercising all their rights and obligations under the transaction documents. This document cannot be reproduced except in full, without prior written approval of the Company. Any unauthorized alteration, forgery or falsification of the content or appearance of this document is unlawful and offenders may be prosecuted to the fullest extent of the law. Unless otherwise stated the results shown in this test report refer only to the sample(s) tested and such sample(s) are retained for 30 days only.

Test Mode: 07; Polarity: Horizontal; Modulation:802.11a; Bandwidth:20MHz; Channel:middle

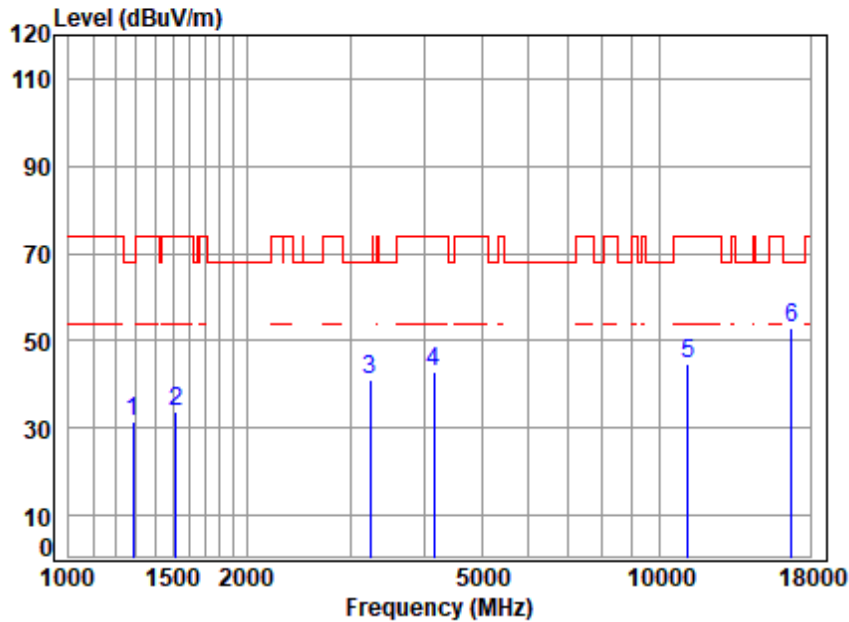

Site : chamber
 Condition: 3m HORIZONTAL
 Job No : 03018AT\03019AT
 Mode : 5580 TX RSE
 Note : 5G WIFI 11A

	Freq	Cable Loss	Ant Factor	Preamp Factor	Read Level	Level	Limit Line	Over Limit	Remark
	MHz	dB	dB/m	dB	dBuV	dBuV/m	dBuV/m	dB	
1	1285.904	3.79	24.88	61.59	64.62	31.70	68.20	-36.50	peak
2	1516.210	4.06	26.86	61.66	64.57	33.83	74.00	-40.17	peak
3	3233.260	6.29	32.37	61.35	63.92	41.23	68.20	-26.97	peak
4	4157.664	6.85	33.80	61.32	63.68	43.01	74.00	-30.99	peak
5	11160.000	11.77	37.62	62.54	57.86	44.71	74.00	-29.29	peak
6	p16740.000	14.15	42.78	62.17	58.18	52.94	68.20	-15.26	peak



Unless otherwise agreed in writing, this document is issued by the Company subject to its General Conditions of Service printed overleaf, available on request or accessible at <https://www.sgs.com/en/Terms-and-Conditions>. Attention is drawn to the limitation of liability, indemnification and jurisdiction issues defined therein. Any holder of this document is advised that information contained hereon reflects the Company's findings at the time of its intervention only and within the limits of Client's instructions, if any. The Company's sole responsibility is to its Client and this document does not exonerate parties to a transaction from exercising all their rights and obligations under the transaction documents. This document cannot be reproduced except in full, without prior written approval of the Company. Any unauthorized alteration, forgery or falsification of the content or appearance of this document is unlawful and offenders may be prosecuted to the fullest extent of the law. Unless otherwise stated the results shown in this test report refer only to the sample(s) tested and such sample(s) are retained for 30 days only.

Test Mode: 07; Polarity: Vertical; Modulation:802.11a; Bandwidth:20MHz; Channel:middle

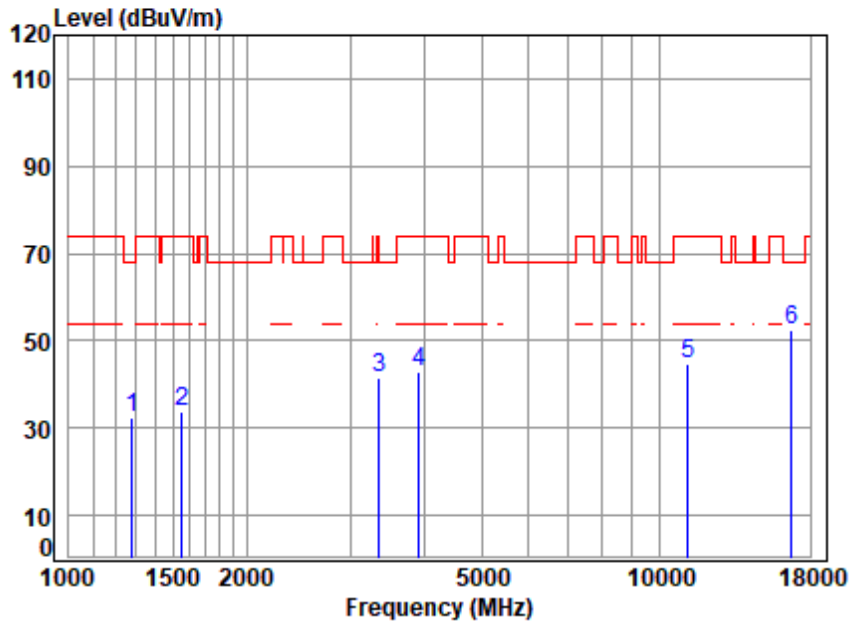

Site : chamber
 Condition: 3m VERTICAL
 Job No : 03018AT\03019AT
 Mode : 5580 TX RSE
 Note : 5G WIFI 11A

	Freq	Cable Loss	Ant Factor	Preamp Factor	Read Level	Level	Limit Line	Over Limit	Remark
	MHz	dB	dB/m	dB	dBuV	dBuV/m	dBuV/m	dB	
1	1282.193	3.79	24.91	61.58	65.17	32.29	68.20	-35.91	peak
2	1556.169	4.12	26.98	61.67	64.53	33.96	74.00	-40.04	peak
3	3357.061	6.40	32.14	61.32	64.52	41.74	74.00	-32.26	peak
4	3912.809	6.63	33.72	61.19	63.59	42.75	74.00	-31.25	peak
5	11160.000	11.77	37.62	62.54	57.99	44.84	74.00	-29.16	peak
6	p16740.000	14.15	42.78	62.17	57.80	52.56	68.20	-15.64	peak



Unless otherwise agreed in writing, this document is issued by the Company subject to its General Conditions of Service printed overleaf, available on request or accessible at <https://www.sgs.com/en/Terms-and-Conditions>. Attention is drawn to the limitation of liability, indemnification and jurisdiction issues defined therein. Any holder of this document is advised that information contained hereon reflects the Company's findings at the time of its intervention only and within the limits of Client's instructions, if any. The Company's sole responsibility is to its Client and this document does not exonerate parties to a transaction from exercising all their rights and obligations under the transaction documents. This document cannot be reproduced except in full, without prior written approval of the Company. Any unauthorized alteration, forgery or falsification of the content or appearance of this document is unlawful and offenders may be prosecuted to the fullest extent of the law. Unless otherwise stated the results shown in this test report refer only to the sample(s) tested and such sample(s) are retained for 30 days only.

Test Mode: 07; Polarity: Horizontal; Modulation:802.11a; Bandwidth:20MHz; Channel:High

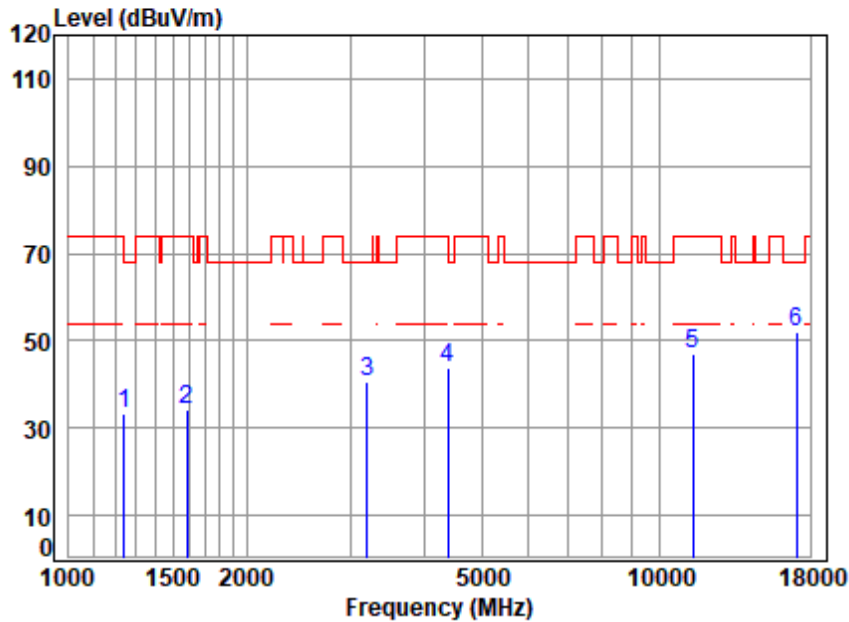

Site : chamber
 Condition: 3m HORIZONTAL
 Job No : 03018AT\03019AT
 Mode : 5700 TX RSE
 Note : 5G WIFI 11A

	Freq	Cable Loss	Ant Factor	Preamp Factor	Read Level	Level	Limit Line	Over Limit	Remark
	MHz	dB	dB/m	dB	dBuV	dBuV/m	dBuV/m	dB	
1	1242.068	3.74	24.99	61.57	66.35	33.51	68.20	-34.69	peak
2	1583.392	4.16	26.87	61.68	64.67	34.02	74.00	-39.98	peak
3	3196.094	6.25	32.87	61.36	63.05	40.81	68.20	-27.39	peak
4	4392.376	7.13	34.74	61.53	63.58	43.92	74.00	-30.08	peak
5	11400.000	11.90	37.70	62.60	60.17	47.17	74.00	-26.83	peak
6	p17100.000	14.44	43.10	61.79	56.18	51.93	68.20	-16.27	peak



Unless otherwise agreed in writing, this document is issued by the Company subject to its General Conditions of Service printed overleaf, available on request or accessible at <https://www.sgs.com/en/Terms-and-Conditions>. Attention is drawn to the limitation of liability, indemnification and jurisdiction issues defined therein. Any holder of this document is advised that information contained hereon reflects the Company's findings at the time of its intervention only and within the limits of Client's instructions, if any. The Company's sole responsibility is to its Client and this document does not exonerate parties to a transaction from exercising all their rights and obligations under the transaction documents. This document cannot be reproduced except in full, without prior written approval of the Company. Any unauthorized alteration, forgery or falsification of the content or appearance of this document is unlawful and offenders may be prosecuted to the fullest extent of the law. Unless otherwise stated the results shown in this test report refer only to the sample(s) tested and such sample(s) are retained for 30 days only.

Test Mode: 07; Polarity: Vertical; Modulation:802.11a; Bandwidth:20MHz; Channel:High

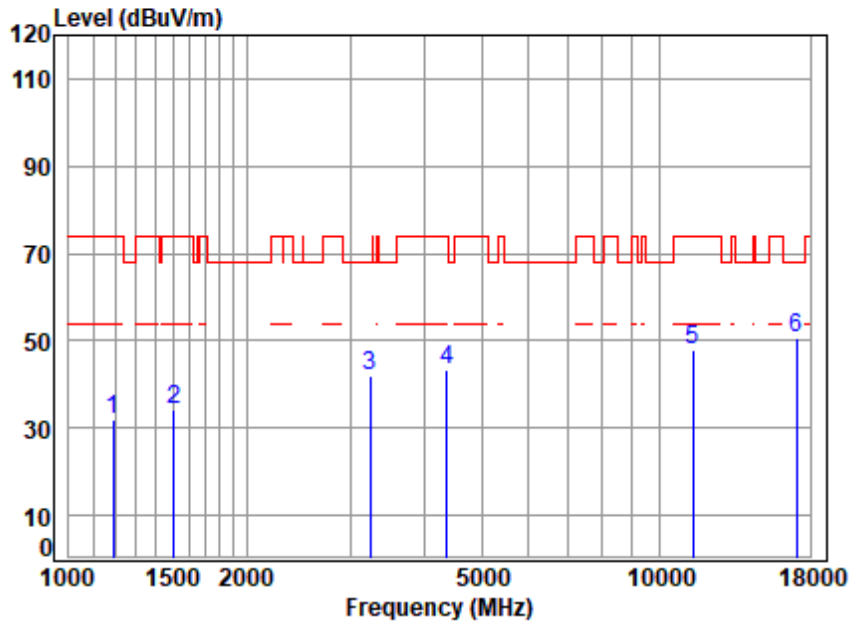

Site : chamber
 Condition: 3m VERTICAL
 Job No : 03018AT\03019AT
 Mode : 5700 TX RSE
 Note : 5G WIFI 11A

	Freq	Cable Loss	Ant Factor	Preamp Factor	Read Level	Level	Limit Line	Over Limit	Remark
	MHz	dB	dB/m	dB	dBuV	dBuV/m	dBuV/m	dB	
1	1189.368	3.67	24.29	61.55	65.41	31.82	74.00	-42.18	peak
2	1507.470	4.05	26.83	61.66	64.96	34.18	74.00	-39.82	peak
3	3242.619	6.30	32.22	61.35	64.74	41.91	68.20	-26.29	peak
4	4367.058	7.10	34.54	61.51	63.24	43.37	74.00	-30.63	peak
5	11400.000	11.90	37.70	62.60	60.88	47.88	74.00	-26.12	peak
6	p17100.000	14.44	43.10	61.79	54.83	50.58	68.20	-17.62	peak



Unless otherwise agreed in writing, this document is issued by the Company subject to its General Conditions of Service printed overleaf, available on request or accessible at <https://www.sgs.com/en/Terms-and-Conditions>. Attention is drawn to the limitation of liability, indemnification and jurisdiction issues defined therein. Any holder of this document is advised that information contained hereon reflects the Company's findings at the time of its intervention only and within the limits of Client's instructions, if any. The Company's sole responsibility is to its Client and this document does not exonerate parties to a transaction from exercising all their rights and obligations under the transaction documents. This document cannot be reproduced except in full, without prior written approval of the Company. Any unauthorized alteration, forgery or falsification of the content or appearance of this document is unlawful and offenders may be prosecuted to the fullest extent of the law. Unless otherwise stated the results shown in this test report refer only to the sample(s) tested and such sample(s) are retained for 30 days only.

Test Mode: 07; Polarity: Horizontal; Modulation:802.11n; Bandwidth:20MHz; Channel:Low

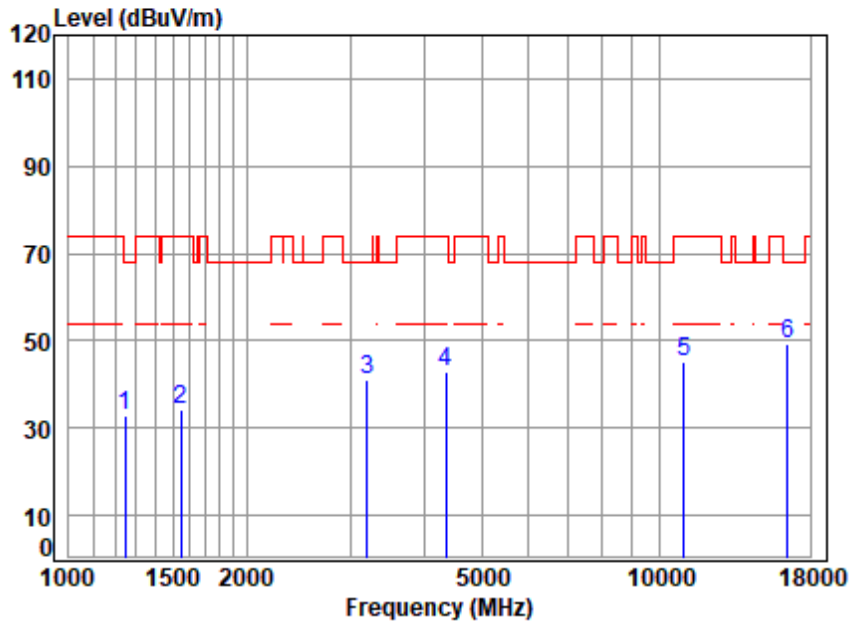

Site : chamber
 Condition: 3m HORIZONTAL
 Job No : 03018AT\03019AT
 Mode : 5500 TX RSE
 Note : 5G WIFI 11N20

	Freq	Cable Loss	Ant Factor	Preamp Factor	Read Level	Level	Limit Line	Over Limit	Remark
	MHz	dB	dB/m	dB	dBuV	dBuV/m	dBuV/m	dB	
1	1245.663	3.74	25.04	61.57	65.67	32.88	68.20	-35.32	peak
2	1547.199	4.11	26.99	61.67	64.79	34.22	74.00	-39.78	peak
3	3196.094	6.25	32.87	61.36	63.21	40.97	68.20	-27.23	peak
4	4354.454	7.08	34.44	61.50	62.69	42.71	74.00	-31.29	peak
5	11000.000	11.68	37.50	62.51	58.45	45.12	74.00	-28.88	peak
6	p16500.000	13.99	42.10	62.42	55.65	49.32	68.20	-18.88	peak



Unless otherwise agreed in writing, this document is issued by the Company subject to its General Conditions of Service printed overleaf, available on request or accessible at <https://www.sgs.com/en/Terms-and-Conditions>. Attention is drawn to the limitation of liability, indemnification and jurisdiction issues defined therein. Any holder of this document is advised that information contained hereon reflects the Company's findings at the time of its intervention only and within the limits of Client's instructions, if any. The Company's sole responsibility is to its Client and this document does not exonerate parties to a transaction from exercising all their rights and obligations under the transaction documents. This document cannot be reproduced except in full, without prior written approval of the Company. Any unauthorized alteration, forgery or falsification of the content or appearance of this document is unlawful and offenders may be prosecuted to the fullest extent of the law. Unless otherwise stated the results shown in this test report refer only to the sample(s) tested and such sample(s) are retained for 30 days only.

Test Mode: 07; Polarity: Vertical; Modulation:802.11n; Bandwidth:20MHz; Channel:Low

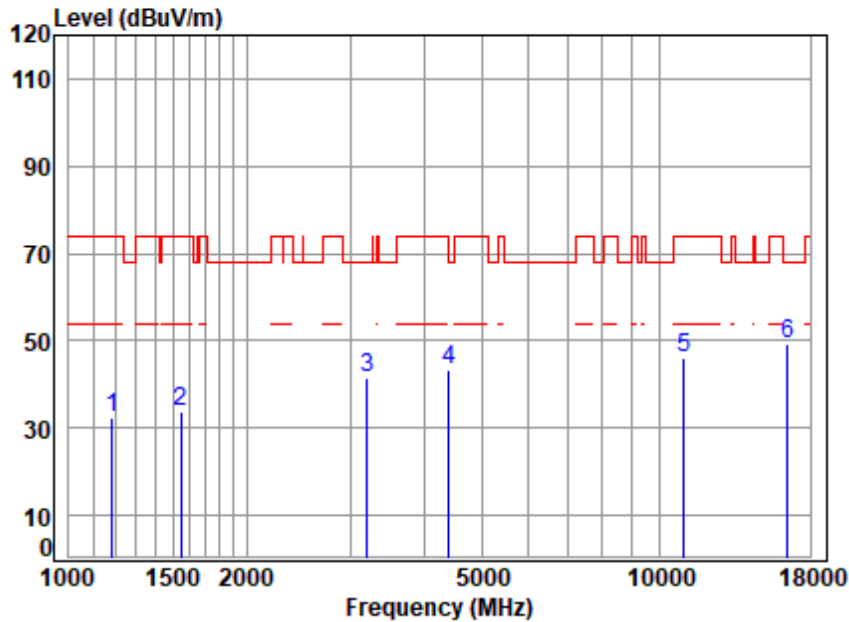

Site : chamber
 Condition: 3m VERTICAL
 Job No : 03018AT\03019AT
 Mode : 5500 TX RSE
 Note : 5G WIFI 11N20

	Freq	Cable Loss	Ant Factor	Preamp Factor	Read Level	Level	Limit Line	Over Limit	Remark
	MHz	dB	dB/m	dB	dBuV	dBuV/m	dBuV/m	dB	
1	1182.513	3.66	24.23	61.55	66.17	32.51	74.00	-41.49	peak
2	1547.199	4.11	26.99	61.67	64.53	33.96	74.00	-40.04	peak
3	3205.345	6.26	32.81	61.36	63.95	41.66	68.20	-26.54	peak
4	4405.090	7.14	34.74	61.55	62.94	43.27	68.20	-24.93	peak
5	11000.000	11.68	37.50	62.51	59.22	45.89	74.00	-28.11	peak
6	p16500.000	13.99	42.10	62.42	55.67	49.34	68.20	-18.86	peak



Unless otherwise agreed in writing, this document is issued by the Company subject to its General Conditions of Service printed overleaf, available on request or accessible at <https://www.sgs.com/en/Terms-and-Conditions>. Attention is drawn to the limitation of liability, indemnification and jurisdiction issues defined therein. Any holder of this document is advised that information contained hereon reflects the Company's findings at the time of its intervention only and within the limits of Client's instructions, if any. The Company's sole responsibility is to its Client and this document does not exonerate parties to a transaction from exercising all their rights and obligations under the transaction documents. This document cannot be reproduced except in full, without prior written approval of the Company. Any unauthorized alteration, forgery or falsification of the content or appearance of this document is unlawful and offenders may be prosecuted to the fullest extent of the law. Unless otherwise stated the results shown in this test report refer only to the sample(s) tested and such sample(s) are retained for 30 days only.

Test Mode: 07; Polarity: Horizontal; Modulation:802.11n; Bandwidth:20MHz; Channel:middle

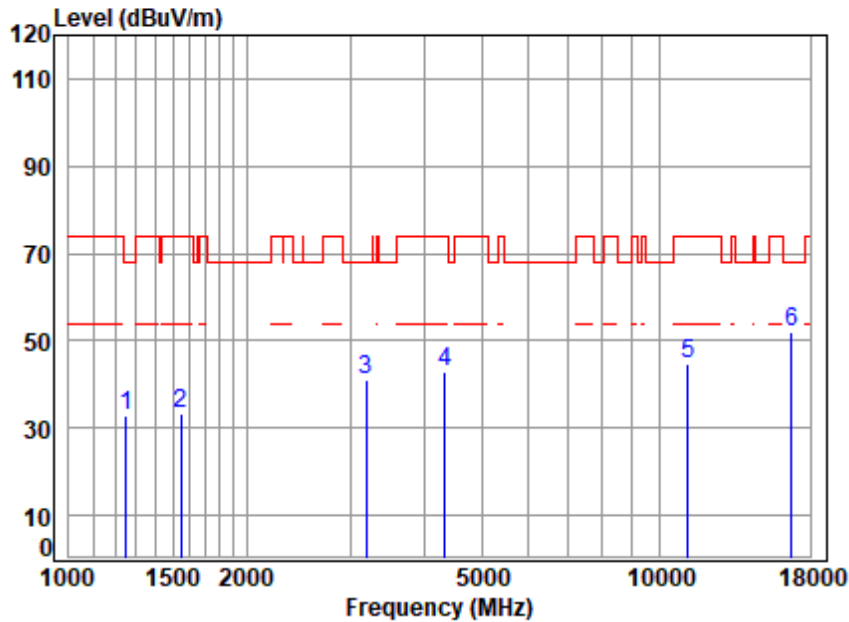

Site : chamber
 Condition: 3m HORIZONTAL
 Job No : 03018AT\03019AT
 Mode : 5580 TX RSE
 Note : 5G WIFI 11N20

	Freq	Cable Loss	Ant Factor	Preamp Factor	Read Level	Level	Limit Line	Over Limit	Remark
	MHz	dB	dB/m	dB	dBuV	dBuV/m	dBuV/m	dB	
1	1249.269	3.75	25.09	61.57	65.57	32.84	68.20	-35.36	peak
2	1547.199	4.11	26.99	61.67	64.08	33.51	74.00	-40.49	peak
3	3186.869	6.25	32.79	61.37	63.39	41.06	68.20	-27.14	peak
4	4329.354	7.05	34.23	61.48	62.97	42.77	74.00	-31.23	peak
5	11160.000	11.77	37.62	62.54	58.04	44.89	74.00	-29.11	peak
6	p16740.000	14.15	42.78	62.17	57.44	52.20	68.20	-16.00	peak



Unless otherwise agreed in writing, this document is issued by the Company subject to its General Conditions of Service printed overleaf, available on request or accessible at <https://www.sgs.com/en/Terms-and-Conditions>. Attention is drawn to the limitation of liability, indemnification and jurisdiction issues defined therein. Any holder of this document is advised that information contained hereon reflects the Company's findings at the time of its intervention only and within the limits of Client's instructions, if any. The Company's sole responsibility is to its Client and this document does not exonerate parties to a transaction from exercising all their rights and obligations under the transaction documents. This document cannot be reproduced except in full, without prior written approval of the Company. Any unauthorized alteration, forgery or falsification of the content or appearance of this document is unlawful and offenders may be prosecuted to the fullest extent of the law. Unless otherwise stated the results shown in this test report refer only to the sample(s) tested and such sample(s) are retained for 30 days only.

Test Mode: 07; Polarity: Vertical; Modulation:802.11n; Bandwidth:20MHz; Channel:middle

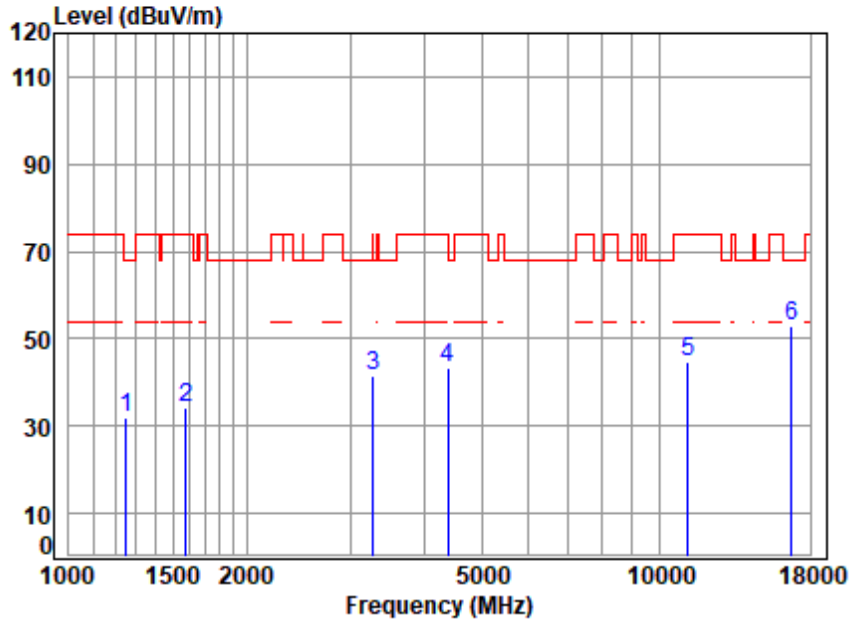

Site : chamber
 Condition: 3m VERTICAL
 Job No : 03018AT\03019AT
 Mode : 5580 TX RSE
 Note : 5G WIFI 11N20

	Freq	Cable Loss	Ant Factor	Preamp Factor	Read Level	Level	Limit Line	Over Limit	Remark
	MHz	dB	dB/m	dB	dBuV	dBuV/m	dBuV/m	dB	
1	1249.269	3.75	25.09	61.57	64.73	32.00	68.20	-36.20	peak
2	1578.822	4.16	26.88	61.68	64.75	34.11	74.00	-39.89	peak
3	3280.326	6.33	31.55	61.34	64.92	41.46	68.20	-26.74	peak
4	4392.376	7.13	34.74	61.53	63.04	43.38	74.00	-30.62	peak
5	11160.000	11.77	37.62	62.54	57.83	44.68	74.00	-29.32	peak
6	p16740.000	14.15	42.78	62.17	58.12	52.88	68.20	-15.32	peak



Unless otherwise agreed in writing, this document is issued by the Company subject to its General Conditions of Service printed overleaf, available on request or accessible at <https://www.sgs.com/en/Terms-and-Conditions>. Attention is drawn to the limitation of liability, indemnification and jurisdiction issues defined therein. Any holder of this document is advised that information contained hereon reflects the Company's findings at the time of its intervention only and within the limits of Client's instructions, if any. The Company's sole responsibility is to its Client and this document does not exonerate parties to a transaction from exercising all their rights and obligations under the transaction documents. This document cannot be reproduced except in full, without prior written approval of the Company. Any unauthorized alteration, forgery or falsification of the content or appearance of this document is unlawful and offenders may be prosecuted to the fullest extent of the law. Unless otherwise stated the results shown in this test report refer only to the sample(s) tested and such sample(s) are retained for 30 days only.

Test Mode: 07; Polarity: Horizontal; Modulation:802.11n; Bandwidth:20MHz; Channel:High

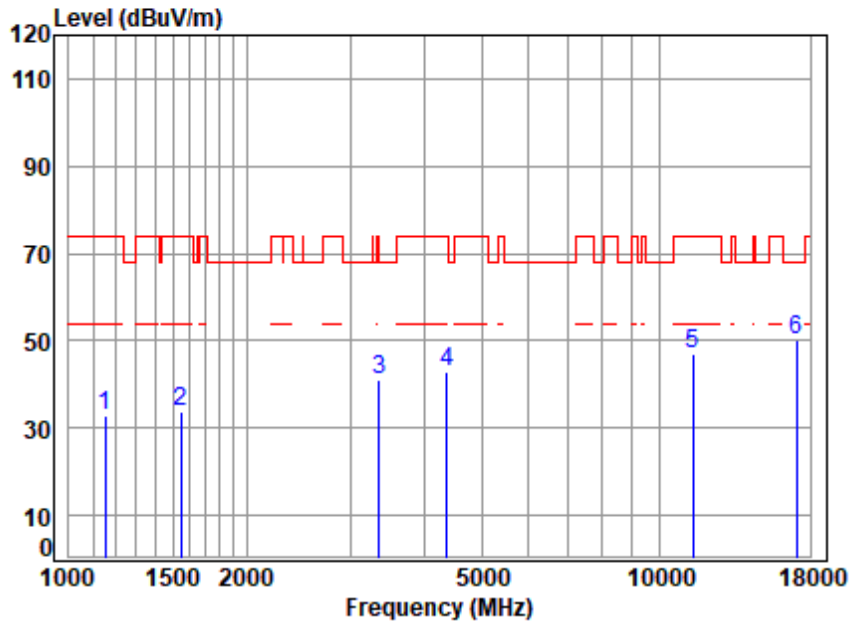

Site : chamber
 Condition: 3m HORIZONTAL
 Job No : 03018AT\03019AT
 Mode : 5700 TX RSE
 Note : 5G WIFI 11N20

	Freq	Cable Loss	Ant Factor	Preamp Factor	Read Level	Level	Limit Line	Over Limit	Remark
	MHz	dB	dB/m	dB	dBuV	dBuV/m	dBuV/m	dB	
1	1152.148	3.62	23.92	61.54	66.73	32.73	74.00	-41.27	peak
2	1547.199	4.11	26.99	61.67	64.20	33.63	74.00	-40.37	peak
3	3357.061	6.40	32.14	61.32	64.03	41.25	74.00	-32.75	peak
4	4367.058	7.10	34.54	61.51	62.70	42.83	74.00	-31.17	peak
5	11400.000	11.90	37.70	62.60	59.98	46.98	74.00	-27.02	peak
6	p17100.000	14.44	43.10	61.79	54.63	50.38	68.20	-17.82	peak



Unless otherwise agreed in writing, this document is issued by the Company subject to its General Conditions of Service printed overleaf, available on request or accessible at <https://www.sgs.com/en/Terms-and-Conditions>. Attention is drawn to the limitation of liability, indemnification and jurisdiction issues defined therein. Any holder of this document is advised that information contained hereon reflects the Company's findings at the time of its intervention only and within the limits of Client's instructions, if any. The Company's sole responsibility is to its Client and this document does not exonerate parties to a transaction from exercising all their rights and obligations under the transaction documents. This document cannot be reproduced except in full, without prior written approval of the Company. Any unauthorized alteration, forgery or falsification of the content or appearance of this document is unlawful and offenders may be prosecuted to the fullest extent of the law. Unless otherwise stated the results shown in this test report refer only to the sample(s) tested and such sample(s) are retained for 30 days only.

Test Mode: 07; Polarity: Vertical; Modulation:802.11n; Bandwidth:20MHz; Channel:High

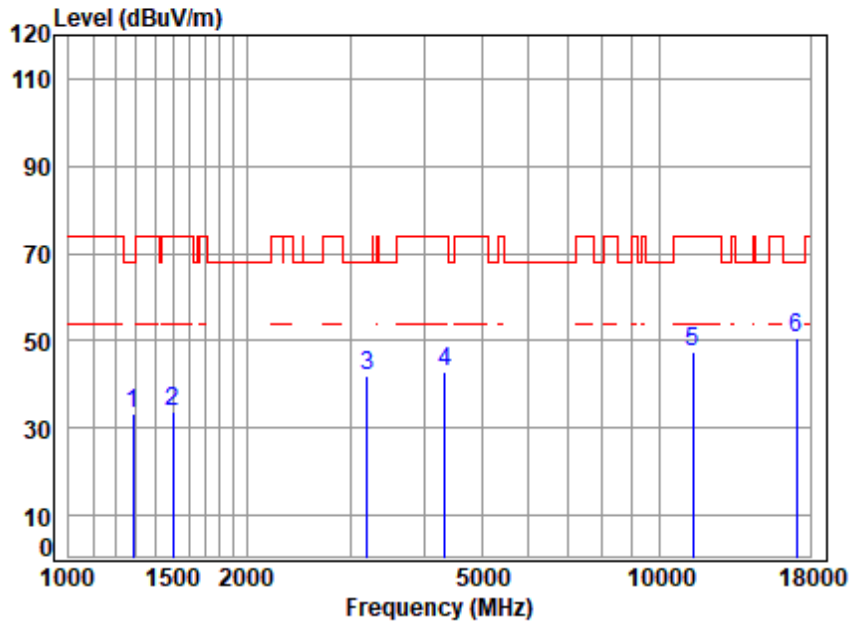

Site : chamber
 Condition: 3m VERTICAL
 Job No : 03018AT\03019AT
 Mode : 5700 TX RSE
 Note : 5G WIFI 11N20

	Freq	Cable Loss	Ant Factor	Preamp Factor	Read Level	Level	Limit Line	Over Limit	Remark
	MHz	dB	dB/m	dB	dBuV	dBuV/m	dBuV/m	dB	
1	1285.904	3.79	24.88	61.59	66.40	33.48	68.20	-34.72	peak
2	1503.119	4.04	26.81	61.66	64.72	33.91	74.00	-40.09	peak
3	3205.345	6.26	32.81	61.36	64.19	41.90	68.20	-26.30	peak
4	4341.886	7.07	34.34	61.49	63.02	42.94	74.00	-31.06	peak
5	11400.000	11.90	37.70	62.60	60.31	47.31	74.00	-26.69	peak
6	p17100.000	14.44	43.10	61.79	54.81	50.56	68.20	-17.64	peak



Unless otherwise agreed in writing, this document is issued by the Company subject to its General Conditions of Service printed overleaf, available on request or accessible at <https://www.sgs.com/en/Terms-and-Conditions>. Attention is drawn to the limitation of liability, indemnification and jurisdiction issues defined therein. Any holder of this document is advised that information contained hereon reflects the Company's findings at the time of its intervention only and within the limits of Client's instructions, if any. The Company's sole responsibility is to its Client and this document does not exonerate parties to a transaction from exercising all their rights and obligations under the transaction documents. This document cannot be reproduced except in full, without prior written approval of the Company. Any unauthorized alteration, forgery or falsification of the content or appearance of this document is unlawful and offenders may be prosecuted to the fullest extent of the law. Unless otherwise stated the results shown in this test report refer only to the sample(s) tested and such sample(s) are retained for 30 days only.

Test Mode: 07; Polarity: Horizontal; Modulation:802.11n; Bandwidth:40MHz; Channel:Low

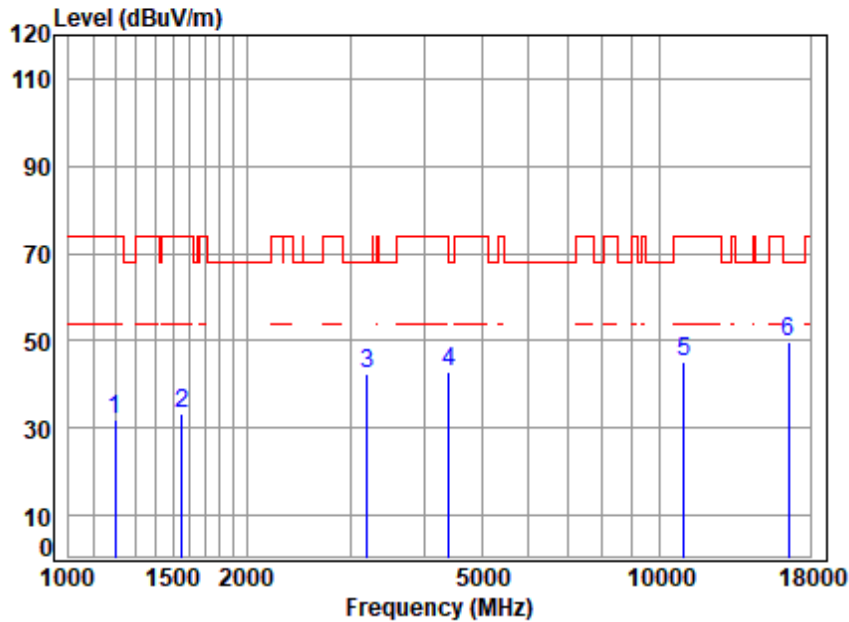

Site : chamber
 Condition: 3m HORIZONTAL
 Job No : 03018AT\03019AT
 Mode : 5510 TX RSE
 Note : 5G WIFI 11N40

	Freq	Cable Loss	Ant Factor	Preamp Factor	Read Level	Level	Limit Line	Over Limit	Remark
	MHz	dB	dB/m	dB	dBuV	dBuV/m	dBuV/m	dB	
1	1199.726	3.68	24.40	61.55	65.22	31.75	74.00	-42.25	peak
2	1551.677	4.12	26.99	61.67	64.02	33.46	74.00	-40.54	peak
3	3196.094	6.25	32.87	61.36	64.72	42.48	68.20	-25.72	peak
4	4405.090	7.14	34.74	61.55	62.53	42.86	68.20	-25.34	peak
5	11020.000	11.69	37.50	62.51	58.61	45.29	74.00	-28.71	peak
6	p16530.000	14.01	42.16	62.39	55.91	49.69	68.20	-18.51	peak



Unless otherwise agreed in writing, this document is issued by the Company subject to its General Conditions of Service printed overleaf, available on request or accessible at <https://www.sgs.com/en/Terms-and-Conditions>. Attention is drawn to the limitation of liability, indemnification and jurisdiction issues defined therein. Any holder of this document is advised that information contained hereon reflects the Company's findings at the time of its intervention only and within the limits of Client's instructions, if any. The Company's sole responsibility is to its Client and this document does not exonerate parties to a transaction from exercising all their rights and obligations under the transaction documents. This document cannot be reproduced except in full, without prior written approval of the Company. Any unauthorized alteration, forgery or falsification of the content or appearance of this document is unlawful and offenders may be prosecuted to the fullest extent of the law. Unless otherwise stated the results shown in this test report refer only to the sample(s) tested and such sample(s) are retained for 30 days only.

Test Mode: 07; Polarity: Vertical; Modulation:802.11n; Bandwidth:40MHz; Channel:Low

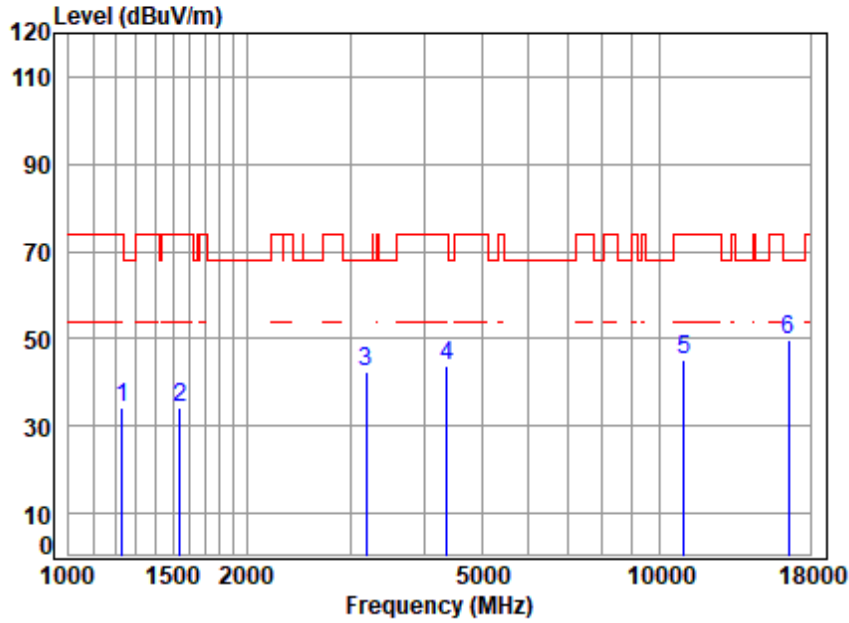

Site : chamber
 Condition: 3m VERTICAL
 Job No : 03018AT\03019AT
 Mode : 5510 TX RSE
 Note : 5G WIFI 11N40

	Freq	Cable Loss	Ant Factor	Preamp Factor	Read Level	Level	Limit Line	Over Limit	Remark
	MHz	dB	dB/m	dB	dBuV	dBuV/m	dBuV/m	dB	
1	1231.345	3.72	24.84	61.57	67.04	34.03	74.00	-39.97	peak
2	1542.733	4.10	26.97	61.67	64.88	34.28	74.00	-39.72	peak
3	3186.869	6.25	32.79	61.37	64.70	42.37	68.20	-25.83	peak
4	4367.058	7.10	34.54	61.51	63.85	43.98	74.00	-30.02	peak
5	11020.000	11.69	37.50	62.51	58.30	44.98	74.00	-29.02	peak
6	p16530.000	14.01	42.16	62.39	55.84	49.62	68.20	-18.58	peak



Unless otherwise agreed in writing, this document is issued by the Company subject to its General Conditions of Service printed overleaf, available on request or accessible at <https://www.sgs.com/en/Terms-and-Conditions>. Attention is drawn to the limitation of liability, indemnification and jurisdiction issues defined therein. Any holder of this document is advised that information contained hereon reflects the Company's findings at the time of its intervention only and within the limits of Client's instructions, if any. The Company's sole responsibility is to its Client and this document does not exonerate parties to a transaction from exercising all their rights and obligations under the transaction documents. This document cannot be reproduced except in full, without prior written approval of the Company. Any unauthorized alteration, forgery or falsification of the content or appearance of this document is unlawful and offenders may be prosecuted to the fullest extent of the law. Unless otherwise stated the results shown in this test report refer only to the sample(s) tested and such sample(s) are retained for 30 days only.

Test Mode: 07; Polarity: Horizontal; Modulation:802.11n; Bandwidth:40MHz; Channel:middle

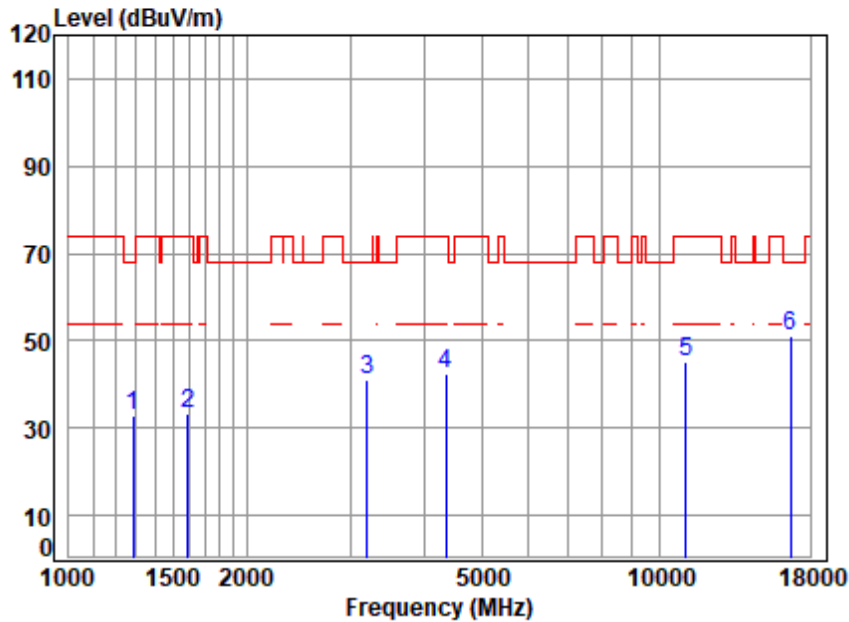

Site : chamber
 Condition: 3m HORIZONTAL
 Job No : 03018AT\03019AT
 Mode : 5550 TX RSE
 Note : 5G WIFI 11N40

	Freq	Cable Loss	Ant Factor	Preamp Factor	Read Level	Level	Limit Line	Over Limit	Remark
	MHz	dB	dB/m	dB	dBuV	dBuV/m	dBuV/m	dB	
1	1285.904	3.79	24.88	61.59	65.57	32.65	68.20	-35.55	peak
2	1592.571	4.18	26.83	61.68	63.98	33.31	74.00	-40.69	peak
3	3196.094	6.25	32.87	61.36	63.47	41.23	68.20	-26.97	peak
4	4354.454	7.08	34.44	61.50	62.32	42.34	74.00	-31.66	peak
5	11100.000	11.73	37.50	62.53	58.29	44.99	74.00	-29.01	peak
6	p16650.000	14.09	42.50	62.26	56.80	51.13	68.20	-17.07	peak



Unless otherwise agreed in writing, this document is issued by the Company subject to its General Conditions of Service printed overleaf, available on request or accessible at <https://www.sgs.com/en/Terms-and-Conditions>. Attention is drawn to the limitation of liability, indemnification and jurisdiction issues defined therein. Any holder of this document is advised that information contained hereon reflects the Company's findings at the time of its intervention only and within the limits of Client's instructions, if any. The Company's sole responsibility is to its Client and this document does not exonerate parties to a transaction from exercising all their rights and obligations under the transaction documents. This document cannot be reproduced except in full, without prior written approval of the Company. Any unauthorized alteration, forgery or falsification of the content or appearance of this document is unlawful and offenders may be prosecuted to the fullest extent of the law. Unless otherwise stated the results shown in this test report refer only to the sample(s) tested and such sample(s) are retained for 30 days only.

Test Mode: 07; Polarity: Vertical; Modulation:802.11n; Bandwidth:40MHz; Channel:middle

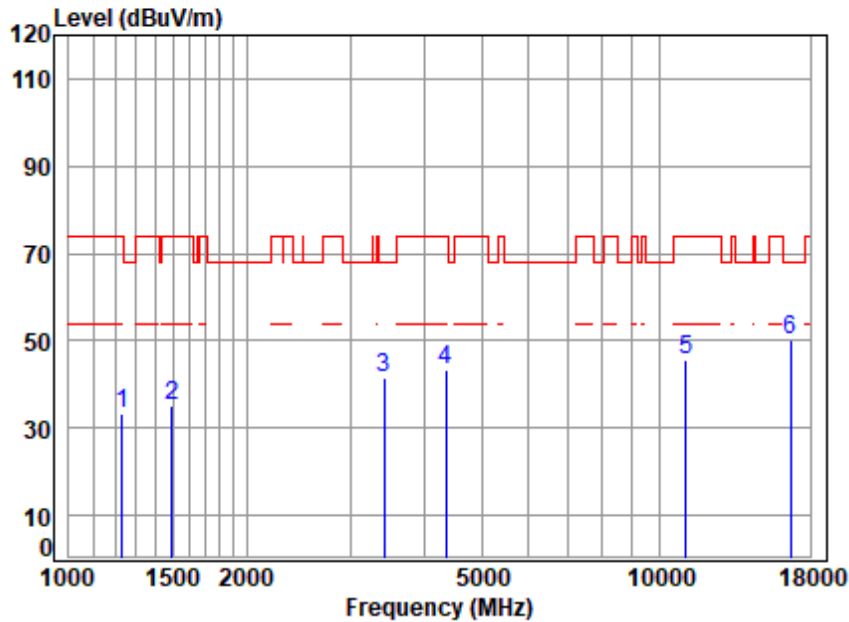

Site : chamber
 Condition: 3m VERTICAL
 Job No : 03018AT\03019AT
 Mode : 5550 TX RSE
 Note : 5G WIFI 11N40

	Freq	Cable Loss	Ant Factor	Preamp Factor	Read Level	Level	Limit Line	Over Limit	Remark
	MHz	dB	dB/m	dB	dBuV	dBuV/m	dBuV/m	dB	
1	1231.345	3.72	24.84	61.57	66.14	33.13	74.00	-40.87	peak
2	1494.455	4.03	26.64	61.66	66.15	35.16	74.00	-38.84	peak
3	3415.787	6.45	32.21	61.31	64.18	41.53	68.20	-26.67	peak
4	4354.454	7.08	34.44	61.50	63.21	43.23	74.00	-30.77	peak
5	11100.000	11.73	37.50	62.53	59.03	45.73	74.00	-28.27	peak
6	p16650.000	14.09	42.50	62.26	55.82	50.15	68.20	-18.05	peak



Unless otherwise agreed in writing, this document is issued by the Company subject to its General Conditions of Service printed overleaf, available on request or accessible at <https://www.sgs.com/en/Terms-and-Conditions>. Attention is drawn to the limitation of liability, indemnification and jurisdiction issues defined therein. Any holder of this document is advised that information contained hereon reflects the Company's findings at the time of its intervention only and within the limits of Client's instructions, if any. The Company's sole responsibility is to its Client and this document does not exonerate parties to a transaction from exercising all their rights and obligations under the transaction documents. This document cannot be reproduced except in full, without prior written approval of the Company. Any unauthorized alteration, forgery or falsification of the content or appearance of this document is unlawful and offenders may be prosecuted to the fullest extent of the law. Unless otherwise stated the results shown in this test report refer only to the sample(s) tested and such sample(s) are retained for 30 days only.

Test Mode: 07; Polarity: Horizontal; Modulation:802.11n; Bandwidth:40MHz; Channel:High

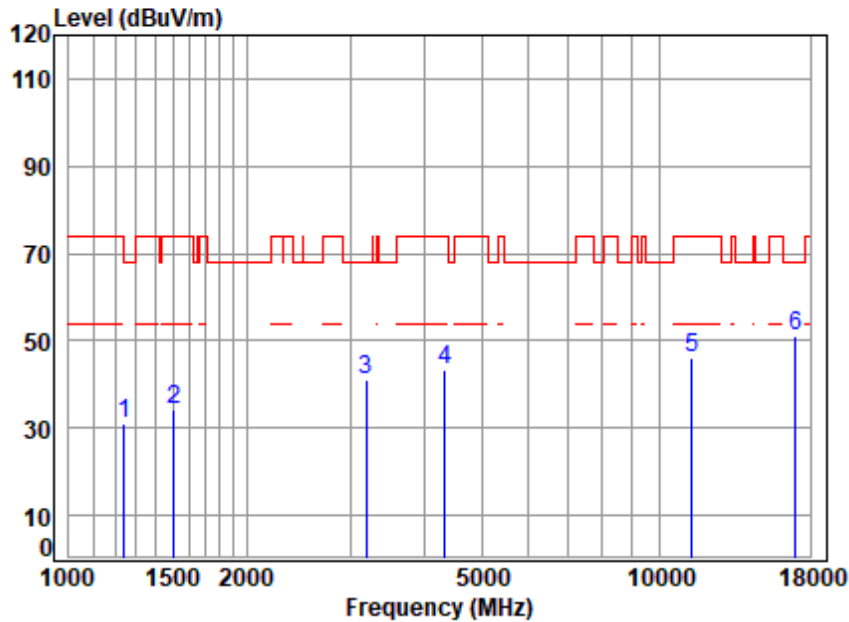

Site : chamber
 Condition: 3m HORIZONTAL
 Job No : 03018AT\03019AT
 Mode : 5670 TX RSE
 Note : 5G WIFI 11N40

	Freq	Cable Loss	Ant Factor	Preamp Factor	Read Level	Level	Limit Line	Over Limit	Remark
	MHz	dB	dB/m	dB	dBuV	dBuV/m	dBuV/m	dB	
1	1242.068	3.74	24.99	61.57	64.06	31.22	68.20	-36.98	peak
2	1507.470	4.05	26.83	61.66	65.08	34.30	74.00	-39.70	peak
3	3186.869	6.25	32.79	61.37	63.38	41.05	68.20	-27.15	peak
4	4329.354	7.05	34.23	61.48	63.33	43.13	74.00	-30.87	peak
5	11340.000	11.86	37.76	62.58	58.94	45.98	74.00	-28.02	peak
6	p17010.000	14.33	43.10	61.88	55.38	50.93	68.20	-17.27	peak



Unless otherwise agreed in writing, this document is issued by the Company subject to its General Conditions of Service printed overleaf, available on request or accessible at <https://www.sgs.com/en/Terms-and-Conditions>. Attention is drawn to the limitation of liability, indemnification and jurisdiction issues defined therein. Any holder of this document is advised that information contained hereon reflects the Company's findings at the time of its intervention only and within the limits of Client's instructions, if any. The Company's sole responsibility is to its Client and this document does not exonerate parties to a transaction from exercising all their rights and obligations under the transaction documents. This document cannot be reproduced except in full, without prior written approval of the Company. Any unauthorized alteration, forgery or falsification of the content or appearance of this document is unlawful and offenders may be prosecuted to the fullest extent of the law. Unless otherwise stated the results shown in this test report refer only to the sample(s) tested and such sample(s) are retained for 30 days only.

Test Mode: 07; Polarity: Vertical; Modulation:802.11n; Bandwidth:40MHz; Channel:High

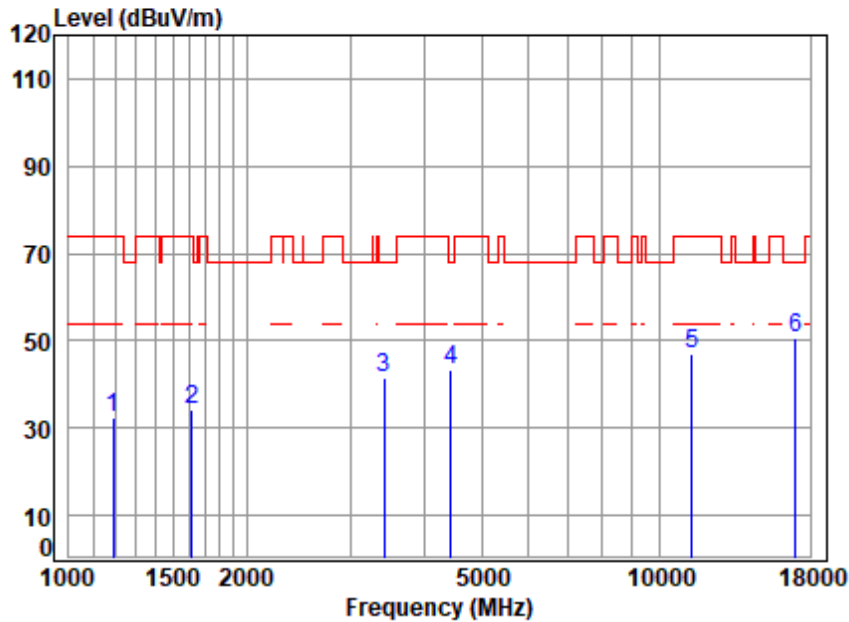

Site : chamber
 Condition: 3m VERTICAL
 Job No : 03018AT\03019AT
 Mode : 5670 TX RSE
 Note : 5G WIFI 11N40

	Freq	Cable Loss	Ant Factor	Preamp Factor	Read Level	Level	Limit Line	Over Limit	Remark
	MHz	dB	dB/m	dB	dBuV	dBuV/m	dBuV/m	dB	
1	1189.368	3.67	24.29	61.55	66.18	32.59	74.00	-41.41	peak
2	1615.754	4.21	26.64	61.69	64.90	34.06	74.00	-39.94	peak
3	3425.675	6.46	32.09	61.30	64.34	41.59	68.20	-26.61	peak
4	4443.453	7.19	34.28	61.58	63.29	43.18	68.20	-25.02	peak
5	11340.000	11.86	37.76	62.58	60.01	47.05	74.00	-26.95	peak
6	p17010.000	14.33	43.10	61.88	55.10	50.65	68.20	-17.55	peak



Unless otherwise agreed in writing, this document is issued by the Company subject to its General Conditions of Service printed overleaf, available on request or accessible at <https://www.sgs.com/en/Terms-and-Conditions>. Attention is drawn to the limitation of liability, indemnification and jurisdiction issues defined therein. Any holder of this document is advised that information contained hereon reflects the Company's findings at the time of its intervention only and within the limits of Client's instructions, if any. The Company's sole responsibility is to its Client and this document does not exonerate parties to a transaction from exercising all their rights and obligations under the transaction documents. This document cannot be reproduced except in full, without prior written approval of the Company. Any unauthorized alteration, forgery or falsification of the content or appearance of this document is unlawful and offenders may be prosecuted to the fullest extent of the law. Unless otherwise stated the results shown in this test report refer only to the sample(s) tested and such sample(s) are retained for 30 days only.

Test Mode: 07; Polarity: Horizontal; Modulation:802.11 ax(Full RU0); Bandwidth:20MHz; Channel:Low

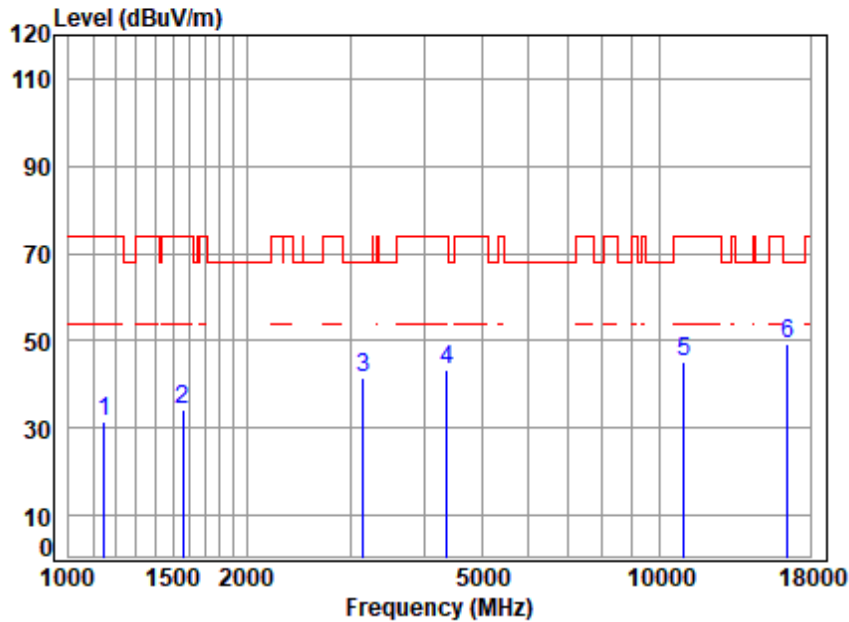

Site : chamber
 Condition: 3m HORIZONTAL
 Job No : 03018AT\03019AT
 Mode : 5500 TX RSE
 Note : 5G WIFI 11AX20

	Freq	Cable Loss	Ant Factor	Preamp Factor	Read Level	Level	Limit Line	Over Limit	Remark
	MHz	dB	dB/m	dB	dBuV	dBuV/m	dBuV/m	dB	
1	1148.823	3.61	23.90	61.53	65.36	31.34	74.00	-42.66	peak
2	1560.673	4.13	26.96	61.68	64.61	34.02	74.00	-39.98	peak
3	3150.237	6.21	32.50	61.38	64.23	41.56	68.20	-26.64	peak
4	4367.058	7.10	34.54	61.51	63.12	43.25	74.00	-30.75	peak
5	11000.000	11.68	37.50	62.51	58.48	45.15	74.00	-28.85	peak
6	p16500.000	13.99	42.10	62.42	55.60	49.27	68.20	-18.93	peak



Unless otherwise agreed in writing, this document is issued by the Company subject to its General Conditions of Service printed overleaf, available on request or accessible at <https://www.sgs.com/en/Terms-and-Conditions>. Attention is drawn to the limitation of liability, indemnification and jurisdiction issues defined therein. Any holder of this document is advised that information contained hereon reflects the Company's findings at the time of its intervention only and within the limits of Client's instructions, if any. The Company's sole responsibility is to its Client and this document does not exonerate parties to a transaction from exercising all their rights and obligations under the transaction documents. This document cannot be reproduced except in full, without prior written approval of the Company. Any unauthorized alteration, forgery or falsification of the content or appearance of this document is unlawful and offenders may be prosecuted to the fullest extent of the law. Unless otherwise stated the results shown in this test report refer only to the sample(s) tested and such sample(s) are retained for 30 days only.

Test Mode: 07; Polarity: Vertical; Modulation:802.11ax(Full RU0); Bandwidth:20MHz; Channel:Low

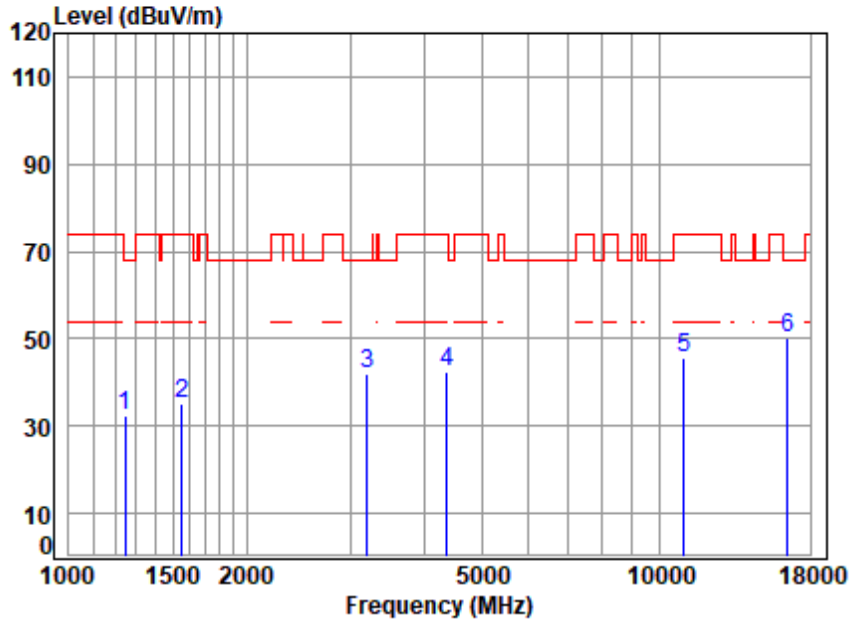

Site : chamber
 Condition: 3m VERTICAL
 Job No : 03018AT\03019AT
 Mode : 5500 TX RSE
 Note : 5G WIFI 11AX20

	Freq	Cable Loss	Ant Factor	Preamp Factor	Read Level	Level	Limit Line	Over Limit	Remark
	MHz	dB	dB/m	dB	dBuV	dBuV/m	dBuV/m	dB	
1	1245.663	3.74	25.04	61.57	65.11	32.32	68.20	-35.88	peak
2	1551.677	4.12	26.99	61.67	65.66	35.10	74.00	-38.90	peak
3	3196.094	6.25	32.87	61.36	64.01	41.77	68.20	-26.43	peak
4	4367.058	7.10	34.54	61.51	62.29	42.42	74.00	-31.58	peak
5	11000.000	11.68	37.50	62.51	58.89	45.56	74.00	-28.44	peak
6	p16500.000	13.99	42.10	62.42	56.43	50.10	68.20	-18.10	peak



Unless otherwise agreed in writing, this document is issued by the Company subject to its General Conditions of Service printed overleaf, available on request or accessible at <https://www.sgs.com/en/Terms-and-Conditions>. Attention is drawn to the limitation of liability, indemnification and jurisdiction issues defined therein. Any holder of this document is advised that information contained hereon reflects the Company's findings at the time of its intervention only and within the limits of Client's instructions, if any. The Company's sole responsibility is to its Client and this document does not exonerate parties to a transaction from exercising all their rights and obligations under the transaction documents. This document cannot be reproduced except in full, without prior written approval of the Company. Any unauthorized alteration, forgery or falsification of the content or appearance of this document is unlawful and offenders may be prosecuted to the fullest extent of the law. Unless otherwise stated the results shown in this test report refer only to the sample(s) tested and such sample(s) are retained for 30 days only.

Test Mode: 07; Polarity: Horizontal; Modulation:802.11ax(Full RU0); Bandwidth:20MHz; Channel:middle

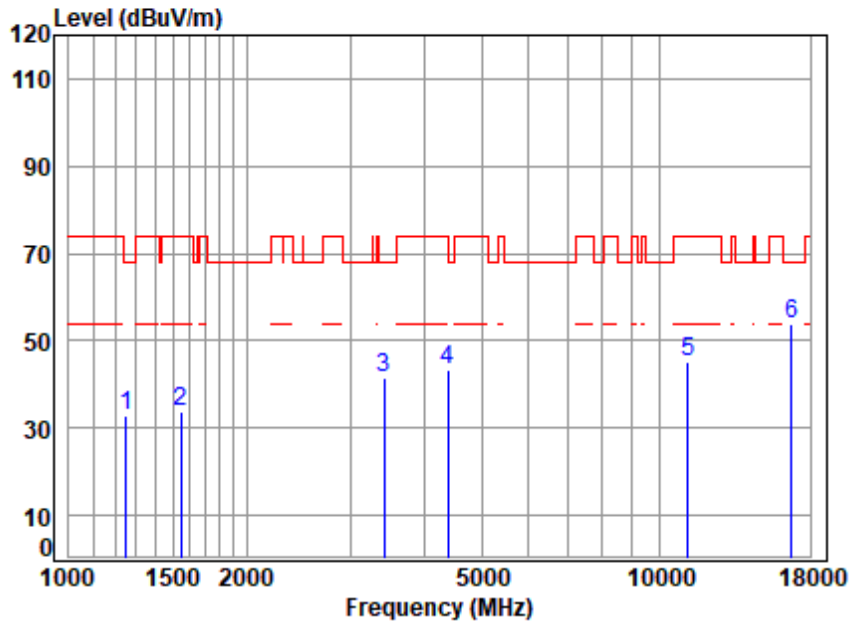

Site : chamber
 Condition: 3m HORIZONTAL
 Job No : 03018AT\03019AT
 Mode : 5580 TX RSE
 Note : 5G WIFI 11AX20

	Freq	Cable Loss	Ant Factor	Preamp Factor	Read Level	Level	Limit Line	Over Limit	Remark
	MHz	dB	dB/m	dB	dBuV	dBuV/m	dBuV/m	dB	
1	1252.885	3.75	25.08	61.57	65.43	32.69	68.20	-35.51	peak
2	1547.199	4.11	26.99	61.67	64.31	33.74	74.00	-40.26	peak
3	3415.787	6.45	32.21	61.31	63.95	41.30	68.20	-26.90	peak
4	4379.699	7.11	34.64	61.52	63.04	43.27	74.00	-30.73	peak
5	11160.000	11.77	37.62	62.54	58.44	45.29	74.00	-28.71	peak
6	p16740.000	14.15	42.78	62.17	59.28	54.04	68.20	-14.16	peak



Unless otherwise agreed in writing, this document is issued by the Company subject to its General Conditions of Service printed overleaf, available on request or accessible at <https://www.sgs.com/en/Terms-and-Conditions>. Attention is drawn to the limitation of liability, indemnification and jurisdiction issues defined therein. Any holder of this document is advised that information contained hereon reflects the Company's findings at the time of its intervention only and within the limits of Client's instructions, if any. The Company's sole responsibility is to its Client and this document does not exonerate parties to a transaction from exercising all their rights and obligations under the transaction documents. This document cannot be reproduced except in full, without prior written approval of the Company. Any unauthorized alteration, forgery or falsification of the content or appearance of this document is unlawful and offenders may be prosecuted to the fullest extent of the law. Unless otherwise stated the results shown in this test report refer only to the sample(s) tested and such sample(s) are retained for 30 days only.

Test Mode: 07; Polarity: Vertical; Modulation:802.11ax(Full RU0); Bandwidth:20MHz; Channel:middle

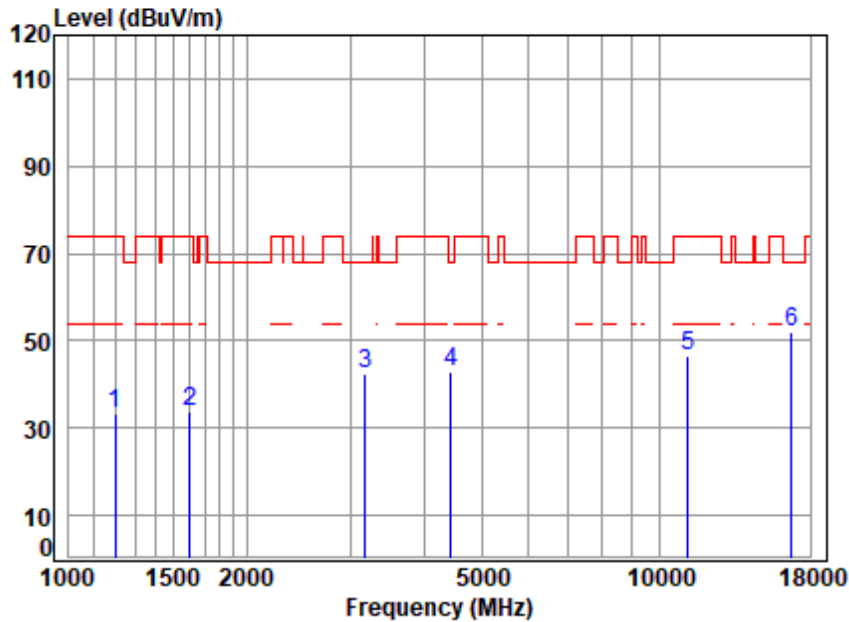

Site : chamber
 Condition: 3m VERTICAL
 Job No : 03018AT\03019AT
 Mode : 5580 TX RSE
 Note : 5G WIFI 11AX20

	Cable	Ant	Preamp	Read	Limit	Over		
Freq	Loss	Factor	Factor	Level	Level	Line	Limit	Remark
MHz	dB	dB/m	dB	dBuV	dBuV/m	dBuV/m	dB	
1	1199.726	3.68	24.40	61.55	66.67	33.20	74.00	-40.80 peak
2	1606.441	4.19	26.74	61.69	64.69	33.93	74.00	-40.07 peak
3	3177.672	6.24	32.72	61.37	64.63	42.22	68.20	-25.98 peak
4	4430.628	7.17	34.43	61.57	62.71	42.74	68.20	-25.46 peak
5	11160.000	11.77	37.62	62.54	59.60	46.45	74.00	-27.55 peak
6	p16740.000	14.15	42.78	62.17	57.40	52.16	68.20	-16.04 peak



Unless otherwise agreed in writing, this document is issued by the Company subject to its General Conditions of Service printed overleaf, available on request or accessible at <https://www.sgs.com/en/Terms-and-Conditions>. Attention is drawn to the limitation of liability, indemnification and jurisdiction issues defined therein. Any holder of this document is advised that information contained hereon reflects the Company's findings at the time of its intervention only and within the limits of Client's instructions, if any. The Company's sole responsibility is to its Client and this document does not exonerate parties to a transaction from exercising all their rights and obligations under the transaction documents. This document cannot be reproduced except in full, without prior written approval of the Company. Any unauthorized alteration, forgery or falsification of the content or appearance of this document is unlawful and offenders may be prosecuted to the fullest extent of the law. Unless otherwise stated the results shown in this test report refer only to the sample(s) tested and such sample(s) are retained for 30 days only.

Test Mode: 07; Polarity: Horizontal; Modulation:802.11ax(Full RU0); Bandwidth:20MHz; Channel:High

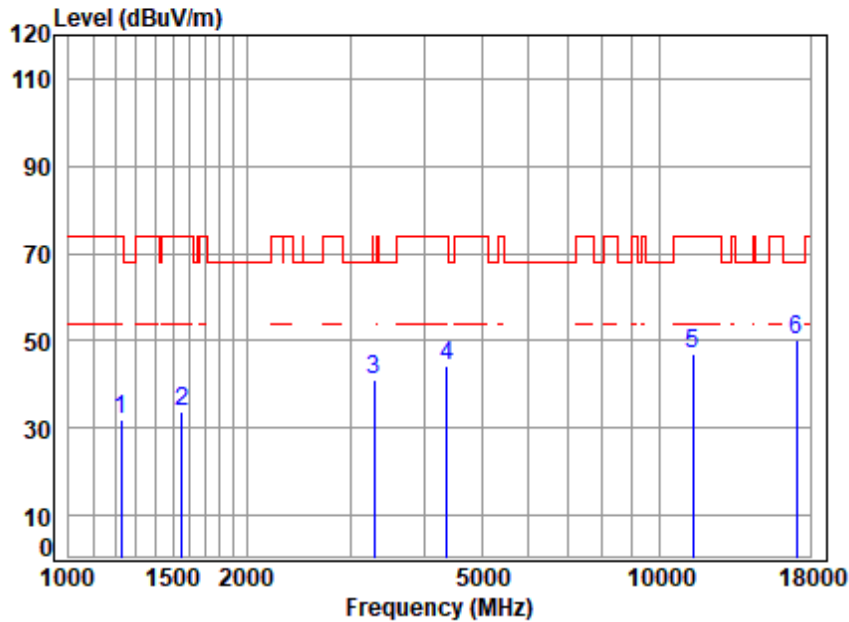

Site : chamber
 Condition: 3m HORIZONTAL
 Job No : 03018AT\03019AT
 Mode : 5700 TX RSE
 Note : 5G WIFI 11AX20

	Freq	Cable Loss	Ant Factor	Preamp Factor	Read Level	Level	Limit Line	Over Limit	Remark
	MHz	dB	dB/m	dB	dBuV	dBuV/m	dBuV/m	dB	
1	1227.791	3.72	24.79	61.56	65.09	32.04	74.00	-41.96	peak
2	1556.169	4.12	26.98	61.67	64.45	33.88	74.00	-40.12	peak
3	3289.821	6.34	31.38	61.34	64.76	41.14	68.20	-27.06	peak
4	4367.058	7.10	34.54	61.51	63.92	44.05	74.00	-29.95	peak
5	11400.000	11.90	37.70	62.60	59.94	46.94	74.00	-27.06	peak
6	p17100.000	14.44	43.10	61.79	54.53	50.28	68.20	-17.92	peak



Unless otherwise agreed in writing, this document is issued by the Company subject to its General Conditions of Service printed overleaf, available on request or accessible at <https://www.sgs.com/en/Terms-and-Conditions>. Attention is drawn to the limitation of liability, indemnification and jurisdiction issues defined therein. Any holder of this document is advised that information contained hereon reflects the Company's findings at the time of its intervention only and within the limits of Client's instructions, if any. The Company's sole responsibility is to its Client and this document does not exonerate parties to a transaction from exercising all their rights and obligations under the transaction documents. This document cannot be reproduced except in full, without prior written approval of the Company. Any unauthorized alteration, forgery or falsification of the content or appearance of this document is unlawful and offenders may be prosecuted to the fullest extent of the law. Unless otherwise stated the results shown in this test report refer only to the sample(s) tested and such sample(s) are retained for 30 days only.

Test Mode: 07; Polarity: Vertical; Modulation:802.11ax(Full RU0); Bandwidth:20MHz; Channel:High

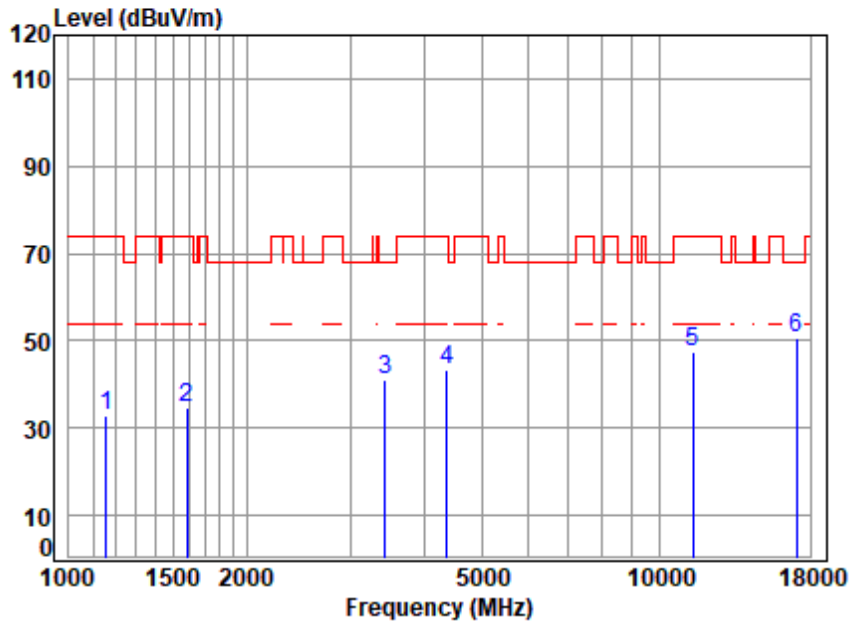

Site : chamber
 Condition: 3m VERTICAL
 Job No : 03018AT\03019AT
 Mode : 5700 TX RSE
 Note : 5G WIFI 11AX20

	Freq	Cable Loss	Ant Factor	Preamp Factor	Read Level	Level	Limit Line	Over Limit	Remark
	MHz	dB	dB/m	dB	dBuV	dBuV/m	dBuV/m	dB	
1	1155.483	3.62	23.95	61.54	66.62	32.65	74.00	-41.35	peak
2	1587.975	4.17	26.85	61.68	65.27	34.61	74.00	-39.39	peak
3	3435.590	6.47	31.97	61.30	63.89	41.03	68.20	-27.17	peak
4	4367.058	7.10	34.54	61.51	63.03	43.16	74.00	-30.84	peak
5	11400.000	11.90	37.70	62.60	60.42	47.42	74.00	-26.58	peak
6	p17100.000	14.44	43.10	61.79	55.08	50.83	68.20	-17.37	peak



Unless otherwise agreed in writing, this document is issued by the Company subject to its General Conditions of Service printed overleaf, available on request or accessible at <https://www.sgs.com/en/Terms-and-Conditions>. Attention is drawn to the limitation of liability, indemnification and jurisdiction issues defined therein. Any holder of this document is advised that information contained hereon reflects the Company's findings at the time of its intervention only and within the limits of Client's instructions, if any. The Company's sole responsibility is to its Client and this document does not exonerate parties to a transaction from exercising all their rights and obligations under the transaction documents. This document cannot be reproduced except in full, without prior written approval of the Company. Any unauthorized alteration, forgery or falsification of the content or appearance of this document is unlawful and offenders may be prosecuted to the fullest extent of the law. Unless otherwise stated the results shown in this test report refer only to the sample(s) tested and such sample(s) are retained for 30 days only.

Test Mode: 07; Polarity: Horizontal; Modulation:802.11 ax(Full RU0); Bandwidth:40MHz; Channel:Low

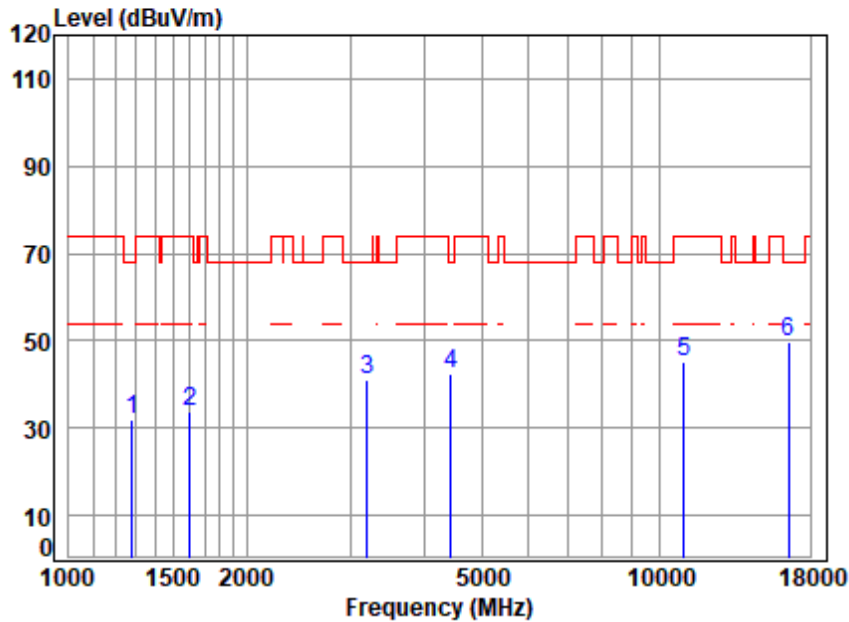

Site : chamber
 Condition: 3m HORIZONTAL
 Job No : 03018AT\03019AT
 Mode : 5510 TX RSE
 Note : 5G WIFI 11AX40

	Cable	Ant	Preamp	Read	Limit	Over		
Freq	Loss	Factor	Factor	Level	Level	Line	Limit	Remark
MHz	dB	dB/m	dB	dBuV	dBuV/m	dBuV/m	dB	
1	1282.193	3.79	24.91	61.58	64.88	32.00	68.20	-36.20 peak
2	1601.804	4.19	26.78	61.69	64.56	33.84	74.00	-40.16 peak
3	3205.345	6.26	32.81	61.36	63.44	41.15	68.20	-27.05 peak
4	4443.453	7.19	34.28	61.58	62.59	42.48	68.20	-25.72 peak
5	11020.000	11.69	37.50	62.51	58.61	45.29	74.00	-28.71 peak
6	p16530.000	14.01	42.16	62.39	56.05	49.83	68.20	-18.37 peak



Unless otherwise agreed in writing, this document is issued by the Company subject to its General Conditions of Service printed overleaf, available on request or accessible at <https://www.sgs.com/en/Terms-and-Conditions>. Attention is drawn to the limitation of liability, indemnification and jurisdiction issues defined therein. Any holder of this document is advised that information contained hereon reflects the Company's findings at the time of its intervention only and within the limits of Client's instructions, if any. The Company's sole responsibility is to its Client and this document does not exonerate parties to a transaction from exercising all their rights and obligations under the transaction documents. This document cannot be reproduced except in full, without prior written approval of the Company. Any unauthorized alteration, forgery or falsification of the content or appearance of this document is unlawful and offenders may be prosecuted to the fullest extent of the law. Unless otherwise stated the results shown in this test report refer only to the sample(s) tested and such sample(s) are retained for 30 days only.

Test Mode: 07; Polarity: Vertical; Modulation:802.11ax(Full RU0); Bandwidth:40MHz; Channel:Low

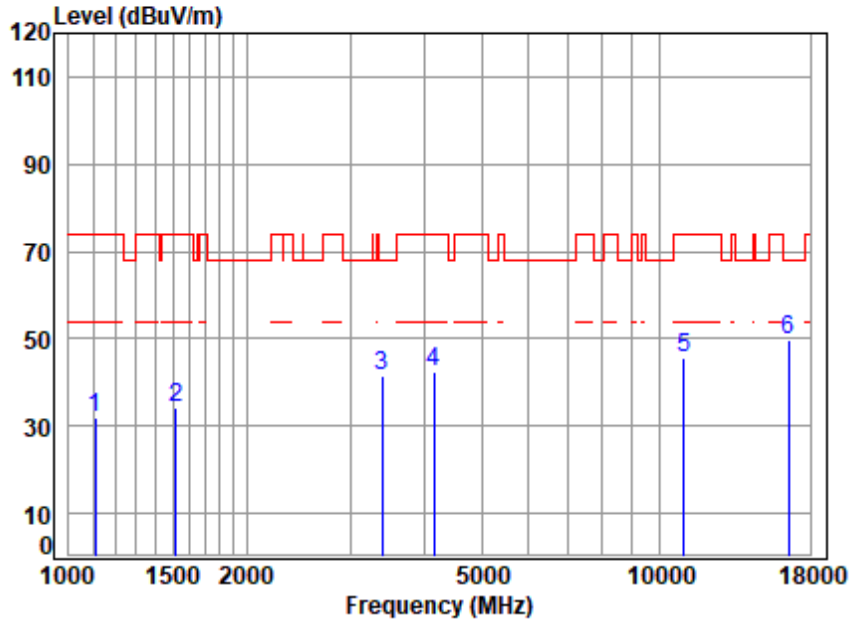

Site : chamber
 Condition: 3m VERTICAL
 Job No : 03018AT\03019AT
 Mode : 5510 TX RSE
 Note : 5G WIFI 11AX40

	Freq	Cable Loss	Ant Factor	Preamp Factor	Read Level	Level	Limit Line	Over Limit	Remark
	MHz	dB	dB/m	dB	dBuV	dBuV/m	dBuV/m	dB	
1	1109.660	3.56	23.74	61.52	66.29	32.07	74.00	-41.93	peak
2	1516.210	4.06	26.86	61.66	64.96	34.22	74.00	-39.78	peak
3	3396.098	6.43	32.38	61.31	63.98	41.48	68.20	-26.72	peak
4	4145.664	6.83	33.73	61.31	63.29	42.54	74.00	-31.46	peak
5	11020.000	11.69	37.50	62.51	58.79	45.47	74.00	-28.53	peak
6	p16530.000	14.01	42.16	62.39	55.96	49.74	68.20	-18.46	peak



Unless otherwise agreed in writing, this document is issued by the Company subject to its General Conditions of Service printed overleaf, available on request or accessible at <https://www.sgs.com/en/Terms-and-Conditions>. Attention is drawn to the limitation of liability, indemnification and jurisdiction issues defined therein. Any holder of this document is advised that information contained hereon reflects the Company's findings at the time of its intervention only and within the limits of Client's instructions, if any. The Company's sole responsibility is to its Client and this document does not exonerate parties to a transaction from exercising all their rights and obligations under the transaction documents. This document cannot be reproduced except in full, without prior written approval of the Company. Any unauthorized alteration, forgery or falsification of the content or appearance of this document is unlawful and offenders may be prosecuted to the fullest extent of the law. Unless otherwise stated the results shown in this test report refer only to the sample(s) tested and such sample(s) are retained for 30 days only.

Test Mode: 07; Polarity: Horizontal; Modulation:802.11ax(Full RU0); Bandwidth:40MHz; Channel:middle

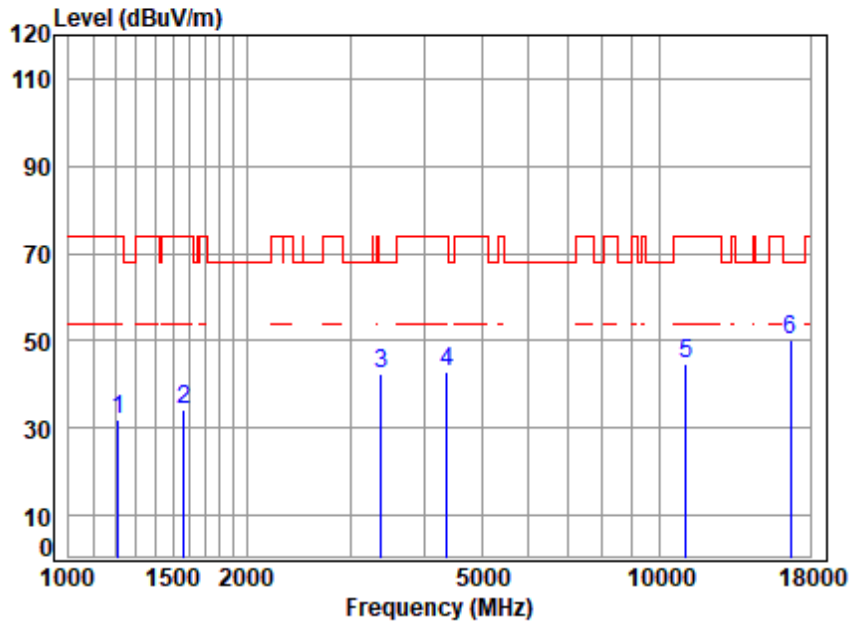

Site : chamber
 Condition: 3m HORIZONTAL
 Job No : 03018AT\03019AT
 Mode : 5550 TX RSE
 Note : 5G WIFI 11AX40

	Freq	Cable Loss	Ant Factor	Preamp Factor	Read Level	Level	Limit Line	Over Limit	Remark
	MHz	dB	dB/m	dB	dBuV	dBuV/m	dBuV/m	dB	
1	1213.677	3.70	24.59	61.56	65.27	32.00	74.00	-42.00	peak
2	1569.721	4.14	26.92	61.68	64.88	34.26	74.00	-39.74	peak
3	3386.297	6.42	32.32	61.31	65.10	42.53	68.20	-25.67	peak
4	4367.058	7.10	34.54	61.51	62.87	43.00	74.00	-31.00	peak
5	11100.000	11.73	37.50	62.53	57.82	44.52	74.00	-29.48	peak
6	p16650.000	14.09	42.50	62.26	55.87	50.20	68.20	-18.00	peak



Unless otherwise agreed in writing, this document is issued by the Company subject to its General Conditions of Service printed overleaf, available on request or accessible at <https://www.sgs.com/en/Terms-and-Conditions>. Attention is drawn to the limitation of liability, indemnification and jurisdiction issues defined therein. Any holder of this document is advised that information contained hereon reflects the Company's findings at the time of its intervention only and within the limits of Client's instructions, if any. The Company's sole responsibility is to its Client and this document does not exonerate parties to a transaction from exercising all their rights and obligations under the transaction documents. This document cannot be reproduced except in full, without prior written approval of the Company. Any unauthorized alteration, forgery or falsification of the content or appearance of this document is unlawful and offenders may be prosecuted to the fullest extent of the law. Unless otherwise stated the results shown in this test report refer only to the sample(s) tested and such sample(s) are retained for 30 days only.

Test Mode: 07; Polarity: Vertical; Modulation:802.11ax(Full RU0); Bandwidth:40MHz; Channel:middle

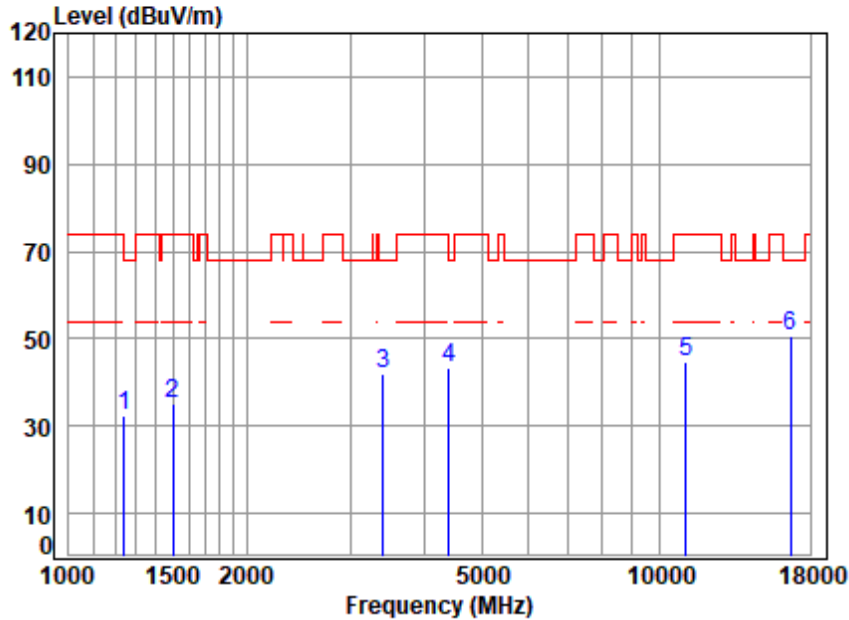

Site : chamber
 Condition: 3m VERTICAL
 Job No : 03018AT\03019AT
 Mode : 5550 TX RSE
 Note : 5G WIFI 11AX40

	Freq	Cable Loss	Ant Factor	Preamp Factor	Read Level	Level	Limit Line	Over Limit	Remark
	MHz	dB	dB/m	dB	dBuV	dBuV/m	dBuV/m	dB	
1	1242.068	3.74	24.99	61.57	65.02	32.18	68.20	-36.02	peak
2	1498.781	4.04	26.77	61.66	65.90	35.05	74.00	-38.95	peak
3	3405.929	6.44	32.33	61.31	64.34	41.80	68.20	-26.40	peak
4	4405.090	7.14	34.74	61.55	62.79	43.12	68.20	-25.08	peak
5	11100.000	11.73	37.50	62.53	58.14	44.84	74.00	-29.16	peak
6	p16650.000	14.09	42.50	62.26	56.45	50.78	68.20	-17.42	peak



Unless otherwise agreed in writing, this document is issued by the Company subject to its General Conditions of Service printed overleaf, available on request or accessible at <https://www.sgs.com/en/Terms-and-Conditions>. Attention is drawn to the limitation of liability, indemnification and jurisdiction issues defined therein. Any holder of this document is advised that information contained hereon reflects the Company's findings at the time of its intervention only and within the limits of Client's instructions, if any. The Company's sole responsibility is to its Client and this document does not exonerate parties to a transaction from exercising all their rights and obligations under the transaction documents. This document cannot be reproduced except in full, without prior written approval of the Company. Any unauthorized alteration, forgery or falsification of the content or appearance of this document is unlawful and offenders may be prosecuted to the fullest extent of the law. Unless otherwise stated the results shown in this test report refer only to the sample(s) tested and such sample(s) are retained for 30 days only.

Test Mode: 07; Polarity: Horizontal; Modulation:802.11ax(Full RU0); Bandwidth:40MHz; Channel:High

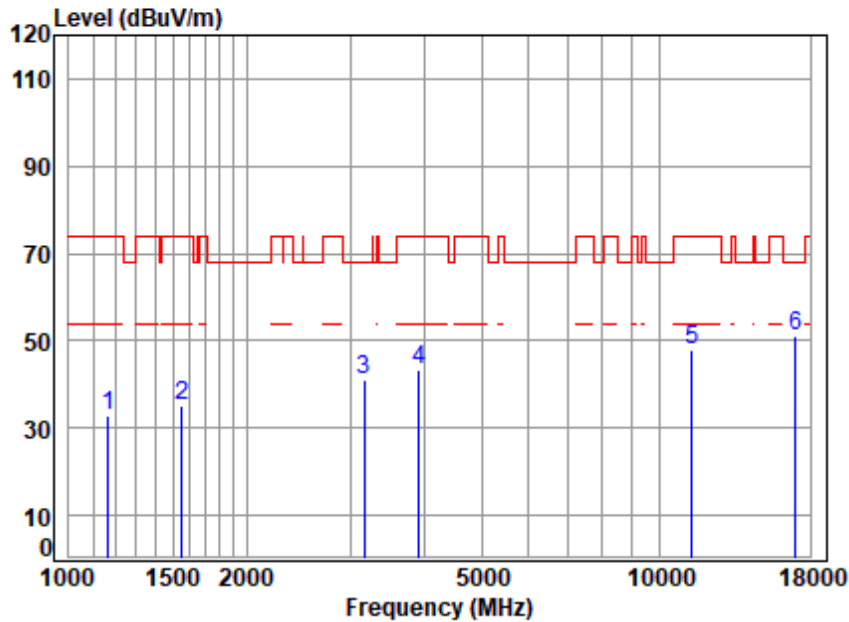

Site : chamber
 Condition: 3m HORIZONTAL
 Job No : 03018AT\03019AT
 Mode : 5670 TX RSE
 Note : 5G WIFI 11AX40

	Freq	Cable Loss	Ant Factor	Preamp Factor	Read Level	Level	Limit Line	Over Limit	Remark
	MHz	dB	dB/m	dB	dBuV	dBuV/m	dBuV/m	dB	
1	1165.546	3.64	24.06	61.54	66.73	32.89	74.00	-41.11	peak
2	1556.169	4.12	26.98	61.67	65.93	35.36	74.00	-38.64	peak
3	3168.500	6.23	32.65	61.37	63.67	41.18	68.20	-27.02	peak
4	3924.135	6.63	33.66	61.19	64.40	43.50	74.00	-30.50	peak
5	11340.000	11.86	37.76	62.58	60.87	47.91	74.00	-26.09	peak
6	p17010.000	14.33	43.10	61.88	55.64	51.19	68.20	-17.01	peak



Unless otherwise agreed in writing, this document is issued by the Company subject to its General Conditions of Service printed overleaf, available on request or accessible at <https://www.sgs.com/en/Terms-and-Conditions>. Attention is drawn to the limitation of liability, indemnification and jurisdiction issues defined therein. Any holder of this document is advised that information contained hereon reflects the Company's findings at the time of its intervention only and within the limits of Client's instructions, if any. The Company's sole responsibility is to its Client and this document does not exonerate parties to a transaction from exercising all their rights and obligations under the transaction documents. This document cannot be reproduced except in full, without prior written approval of the Company. Any unauthorized alteration, forgery or falsification of the content or appearance of this document is unlawful and offenders may be prosecuted to the fullest extent of the law. Unless otherwise stated the results shown in this test report refer only to the sample(s) tested and such sample(s) are retained for 30 days only.

Test Mode: 07; Polarity: Vertical; Modulation:802.11ax(Full RU0); Bandwidth:40MHz; Channel:High

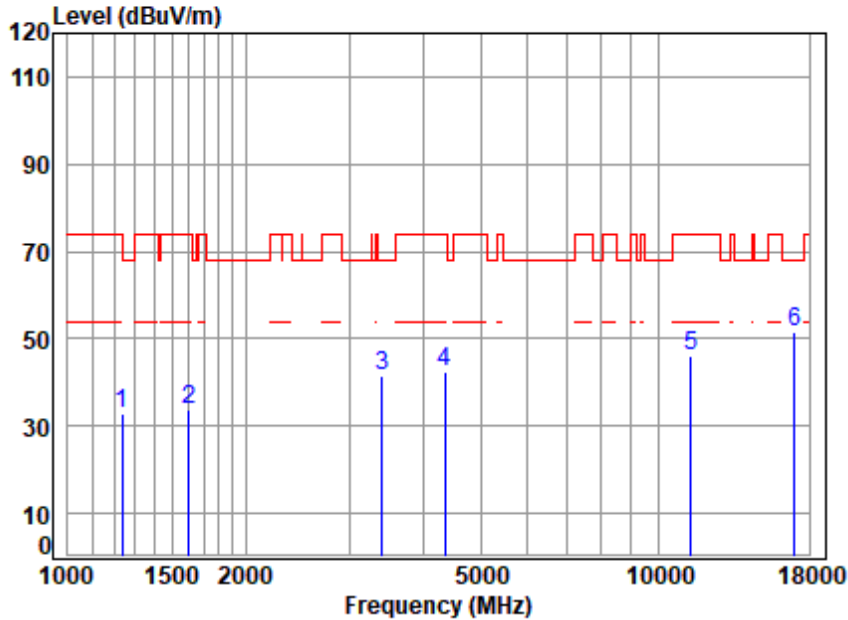

Site : chamber
 Condition: 3m VERTICAL
 Job No : 03018AT\03019AT
 Mode : 5670 TX RSE
 Note : 5G WIFI 11AX40

	Freq	Cable Loss	Ant Factor	Preamp Factor	Read Level	Level	Limit Line	Over Limit	Remark
	MHz	dB	dB/m	dB	dBuV	dBuV/m	dBuV/m	dB	
1	1238.483	3.73	24.94	61.57	65.79	32.89	74.00	-41.11	peak
2	1601.804	4.19	26.78	61.69	64.43	33.71	74.00	-40.29	peak
3	3405.929	6.44	32.33	61.31	64.05	41.51	68.20	-26.69	peak
4	4354.454	7.08	34.44	61.50	62.20	42.22	74.00	-31.78	peak
5	11340.000	11.86	37.76	62.58	58.93	45.97	74.00	-28.03	peak
6	p17010.000	14.33	43.10	61.88	55.94	51.49	68.20	-16.71	peak



Unless otherwise agreed in writing, this document is issued by the Company subject to its General Conditions of Service printed overleaf, available on request or accessible at <https://www.sgs.com/en/Terms-and-Conditions>. Attention is drawn to the limitation of liability, indemnification and jurisdiction issues defined therein. Any holder of this document is advised that information contained hereon reflects the Company's findings at the time of its intervention only and within the limits of Client's instructions, if any. The Company's sole responsibility is to its Client and this document does not exonerate parties to a transaction from exercising all their rights and obligations under the transaction documents. This document cannot be reproduced except in full, without prior written approval of the Company. Any unauthorized alteration, forgery or falsification of the content or appearance of this document is unlawful and offenders may be prosecuted to the fullest extent of the law. Unless otherwise stated the results shown in this test report refer only to the sample(s) tested and such sample(s) are retained for 30 days only.

Test Mode: 07; Polarity: Horizontal; Modulation:802.11 ax(Full RU0); Bandwidth:80MHz; Channel:Low

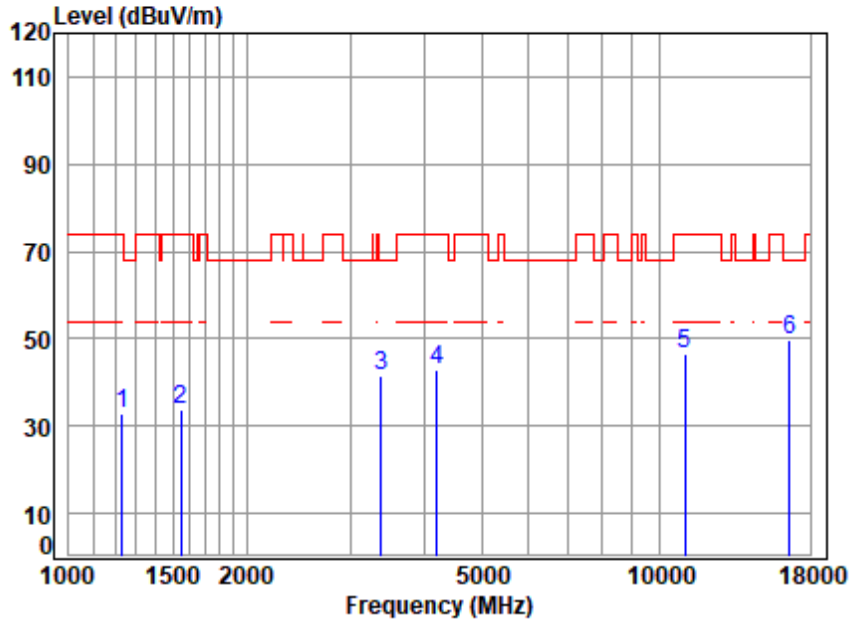

Site : chamber
 Condition: 3m HORIZONTAL
 Job No : 03018AT\03019AT
 Mode : 5530 TX RSE
 Note : 5G WIFI 11AX80

	Freq	Cable Loss	Ant Factor	Preamp Factor	Read Level	Level	Limit Line	Over Limit	Remark
	MHz	dB	dB/m	dB	dBuV	dBuV/m	dBuV/m	dB	
1	1231.345	3.72	24.84	61.57	65.88	32.87	74.00	-41.13	peak
2	1547.199	4.11	26.99	61.67	64.15	33.58	74.00	-40.42	peak
3	3376.523	6.42	32.26	61.32	63.99	41.35	68.20	-26.85	peak
4	4193.872	6.89	33.80	61.35	63.45	42.79	74.00	-31.21	peak
5	11060.000	11.71	37.50	62.52	59.85	46.54	74.00	-27.46	peak
6	p16590.000	14.05	42.28	62.32	55.90	49.91	68.20	-18.29	peak



Unless otherwise agreed in writing, this document is issued by the Company subject to its General Conditions of Service printed overleaf, available on request or accessible at <https://www.sgs.com/en/Terms-and-Conditions>. Attention is drawn to the limitation of liability, indemnification and jurisdiction issues defined therein. Any holder of this document is advised that information contained hereon reflects the Company's findings at the time of its intervention only and within the limits of Client's instructions, if any. The Company's sole responsibility is to its Client and this document does not exonerate parties to a transaction from exercising all their rights and obligations under the transaction documents. This document cannot be reproduced except in full, without prior written approval of the Company. Any unauthorized alteration, forgery or falsification of the content or appearance of this document is unlawful and offenders may be prosecuted to the fullest extent of the law. Unless otherwise stated the results shown in this test report refer only to the sample(s) tested and such sample(s) are retained for 30 days only.

Test Mode: 07; Polarity: Vertical; Modulation:802.11ax(Full RU0); Bandwidth:80MHz; Channel:Low

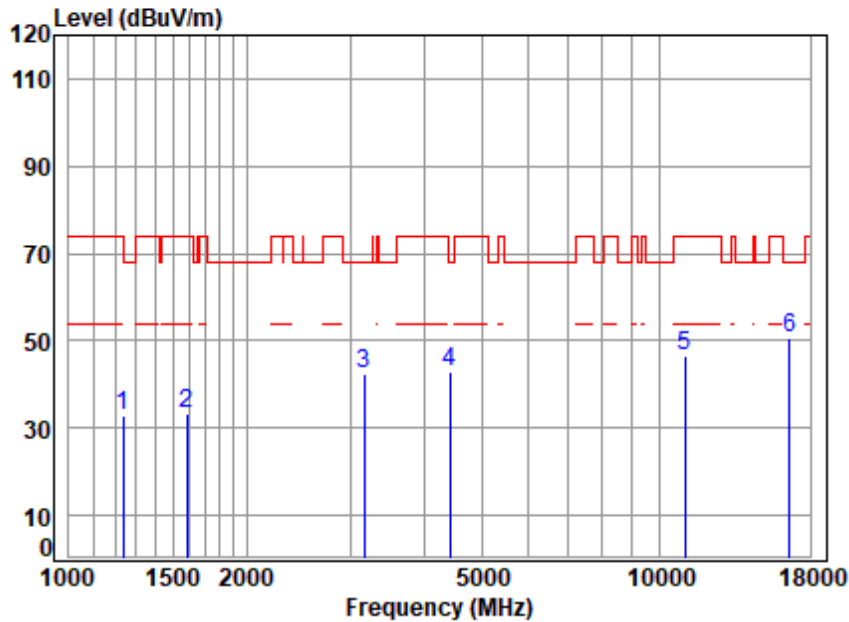

Site : chamber
 Condition: 3m VERTICAL
 Job No : 03018AT\03019AT
 Mode : 5530 TX RSE
 Note : 5G WIFI 11AX80

	Freq	Cable Loss	Ant Factor	Preamp Factor	Read Level	Level	Limit Line	Over Limit	Remark
	MHz	dB	dB/m	dB	dBuV	dBuV/m	dBuV/m	dB	
1	1234.909	3.73	24.89	61.57	65.72	32.77	74.00	-41.23	peak
2	1587.975	4.17	26.85	61.68	63.91	33.25	74.00	-40.75	peak
3	3168.500	6.23	32.65	61.37	64.95	42.46	68.20	-25.74	peak
4	4417.841	7.16	34.59	61.56	62.70	42.89	68.20	-25.31	peak
5	11060.000	11.71	37.50	62.52	59.91	46.60	74.00	-27.40	peak
6	p16590.000	14.05	42.28	62.32	56.44	50.45	68.20	-17.75	peak



Unless otherwise agreed in writing, this document is issued by the Company subject to its General Conditions of Service printed overleaf, available on request or accessible at <https://www.sgs.com/en/Terms-and-Conditions>. Attention is drawn to the limitation of liability, indemnification and jurisdiction issues defined therein. Any holder of this document is advised that information contained hereon reflects the Company's findings at the time of its intervention only and within the limits of Client's instructions, if any. The Company's sole responsibility is to its Client and this document does not exonerate parties to a transaction from exercising all their rights and obligations under the transaction documents. This document cannot be reproduced except in full, without prior written approval of the Company. Any unauthorized alteration, forgery or falsification of the content or appearance of this document is unlawful and offenders may be prosecuted to the fullest extent of the law. Unless otherwise stated the results shown in this test report refer only to the sample(s) tested and such sample(s) are retained for 30 days only.

Test Mode: 07; Polarity: Horizontal; Modulation:802.11ax(Full RU0); Bandwidth:80MHz; Channel:High

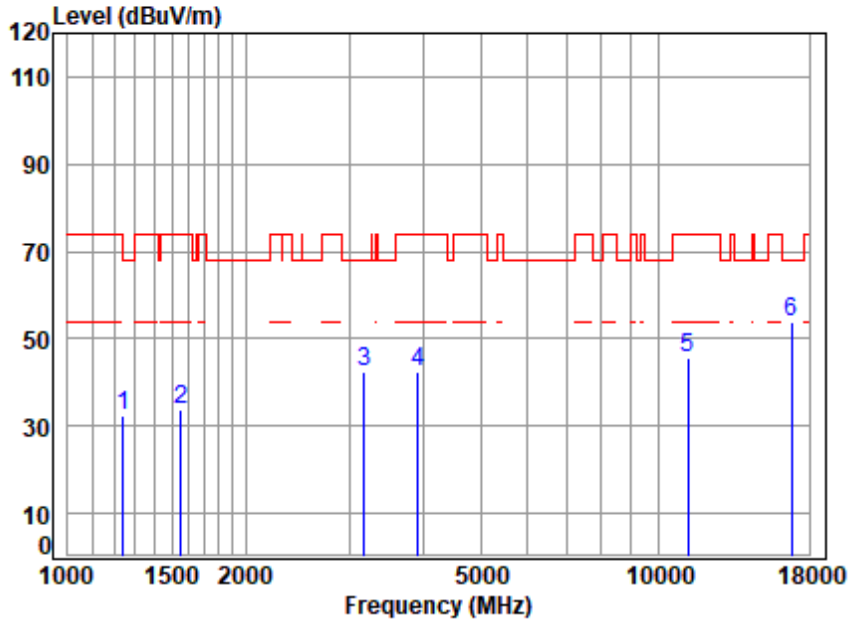

Site : chamber
 Condition: 3m HORIZONTAL
 Job No : 03018AT\03019AT
 Mode : 5610 TX RSE
 Note : 5G WIFI 11AX80

	Freq	Cable Loss	Ant Factor	Preamp Factor	Read Level	Level	Limit Line	Over Limit	Remark
	MHz	dB	dB/m	dB	dBuV	dBuV/m	dBuV/m	dB	
1	1242.068	3.74	24.99	61.57	65.10	32.26	68.20	-35.94	peak
2	1551.677	4.12	26.99	61.67	64.54	33.98	74.00	-40.02	peak
3	3177.672	6.24	32.72	61.37	64.67	42.26	68.20	-25.94	peak
4	3912.809	6.63	33.72	61.19	63.12	42.28	74.00	-31.72	peak
5	11220.000	11.80	37.72	62.56	58.85	45.81	74.00	-28.19	peak
6	p16830.000	14.21	42.99	62.07	58.58	53.71	68.20	-14.49	peak



Unless otherwise agreed in writing, this document is issued by the Company subject to its General Conditions of Service printed overleaf, available on request or accessible at <https://www.sgs.com/en/Terms-and-Conditions>. Attention is drawn to the limitation of liability, indemnification and jurisdiction issues defined therein. Any holder of this document is advised that information contained hereon reflects the Company's findings at the time of its intervention only and within the limits of Client's instructions, if any. The Company's sole responsibility is to its Client and this document does not exonerate parties to a transaction from exercising all their rights and obligations under the transaction documents. This document cannot be reproduced except in full, without prior written approval of the Company. Any unauthorized alteration, forgery or falsification of the content or appearance of this document is unlawful and offenders may be prosecuted to the fullest extent of the law. Unless otherwise stated the results shown in this test report refer only to the sample(s) tested and such sample(s) are retained for 30 days only.

Test Mode: 07; Polarity: Vertical; Modulation:802.11ax(Full RU0); Bandwidth:80MHz; Channel:High

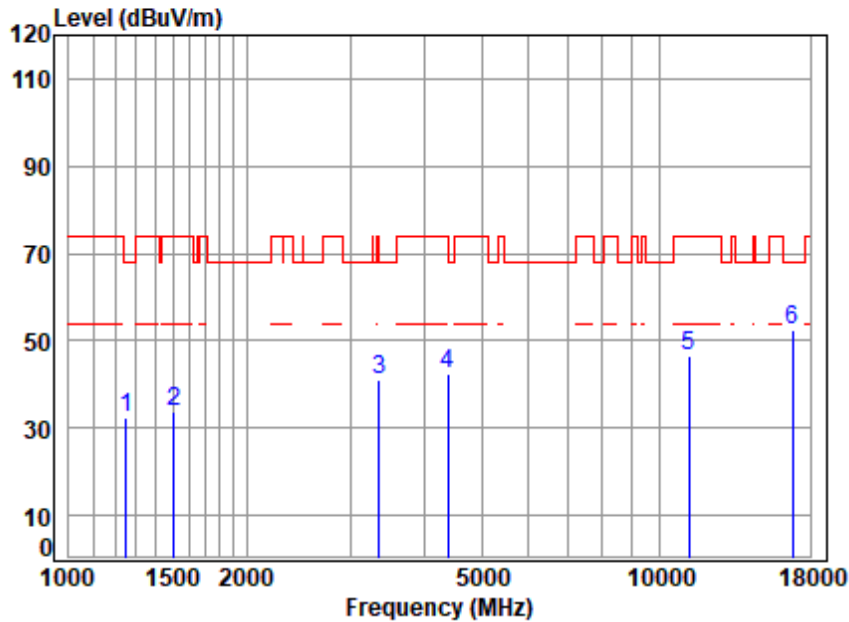

Site : chamber
 Condition: 3m VERTICAL
 Job No : 03018AT\03019AT
 Mode : 5610 TX RSE
 Note : 5G WIFI 11AX80

	Freq	Cable Loss	Ant Factor	Preamp Factor	Read Level	Level	Limit Line	Over Limit	Remark
	MHz	dB	dB/m	dB	dBuV	dBuV/m	dBuV/m	dB	
1	1252.885	3.75	25.08	61.57	64.99	32.25	68.20	-35.95	peak
2	1507.470	4.05	26.83	61.66	64.41	33.63	74.00	-40.37	peak
3	3357.061	6.40	32.14	61.32	63.72	40.94	74.00	-33.06	peak
4	4379.699	7.11	34.64	61.52	62.14	42.37	74.00	-31.63	peak
5	11220.000	11.80	37.72	62.56	59.41	46.37	74.00	-27.63	peak
6	p16830.000	14.21	42.99	62.07	57.11	52.24	68.20	-15.96	peak



Unless otherwise agreed in writing, this document is issued by the Company subject to its General Conditions of Service printed overleaf, available on request or accessible at <https://www.sgs.com/en/Terms-and-Conditions>. Attention is drawn to the limitation of liability, indemnification and jurisdiction issues defined therein. Any holder of this document is advised that information contained hereon reflects the Company's findings at the time of its intervention only and within the limits of Client's instructions, if any. The Company's sole responsibility is to its Client and this document does not exonerate parties to a transaction from exercising all their rights and obligations under the transaction documents. This document cannot be reproduced except in full, without prior written approval of the Company. Any unauthorized alteration, forgery or falsification of the content or appearance of this document is unlawful and offenders may be prosecuted to the fullest extent of the law. Unless otherwise stated the results shown in this test report refer only to the sample(s) tested and such sample(s) are retained for 30 days only.

Test Mode: 08; Polarity: Horizontal; Modulation:802.11a; Bandwidth:20MHz; Channel:Low

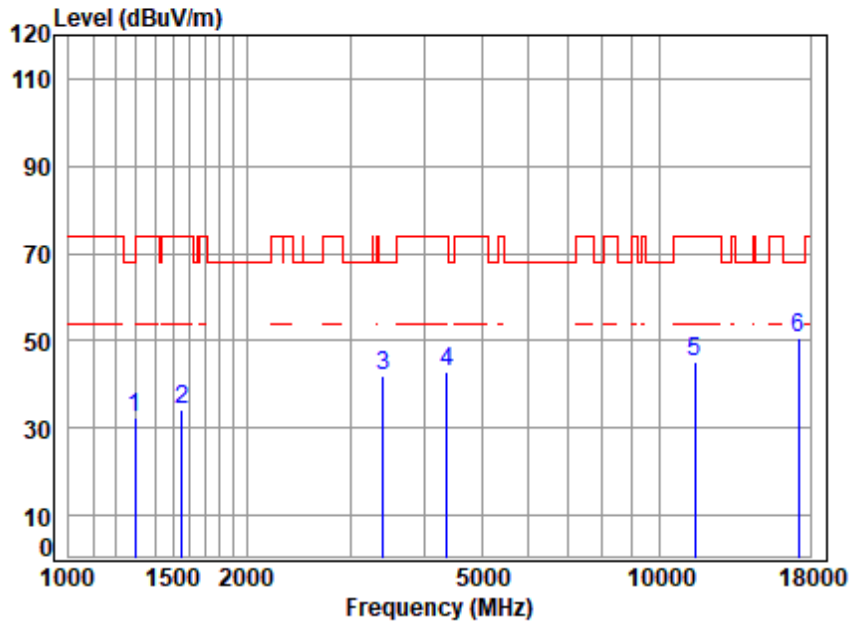

Site : chamber
 Condition: 3m HORIZONTAL
 Job No : 03018AT\03019AT
 Mode : 5745 TX RSE
 Note : 5G WIFI 11A

	Freq	Cable Loss	Ant Factor	Preamp Factor	Read Level	Level	Limit Line	Over Limit	Remark
	MHz	dB	dB/m	dB	dBuV	dBuV/m	dBuV/m	dB	
1	1297.103	3.81	24.82	61.59	65.32	32.36	68.20	-35.84	peak
2	1556.169	4.12	26.98	61.67	64.62	34.05	74.00	-39.95	peak
3	3405.929	6.44	32.33	61.31	64.30	41.76	68.20	-26.44	peak
4	4367.058	7.10	34.54	61.51	62.73	42.86	74.00	-31.14	peak
5	11490.000	11.94	37.79	62.62	58.12	45.23	74.00	-28.77	peak
6	p17235.000	14.59	43.03	61.65	54.59	50.56	68.20	-17.64	peak



Unless otherwise agreed in writing, this document is issued by the Company subject to its General Conditions of Service printed overleaf, available on request or accessible at <https://www.sgs.com/en/Terms-and-Conditions>. Attention is drawn to the limitation of liability, indemnification and jurisdiction issues defined therein. Any holder of this document is advised that information contained hereon reflects the Company's findings at the time of its intervention only and within the limits of Client's instructions, if any. The Company's sole responsibility is to its Client and this document does not exonerate parties to a transaction from exercising all their rights and obligations under the transaction documents. This document cannot be reproduced except in full, without prior written approval of the Company. Any unauthorized alteration, forgery or falsification of the content or appearance of this document is unlawful and offenders may be prosecuted to the fullest extent of the law. Unless otherwise stated the results shown in this test report refer only to the sample(s) tested and such sample(s) are retained for 30 days only.

Test Mode: 08; Polarity: Vertical; Modulation:802.11a; Bandwidth:20MHz; Channel:Low

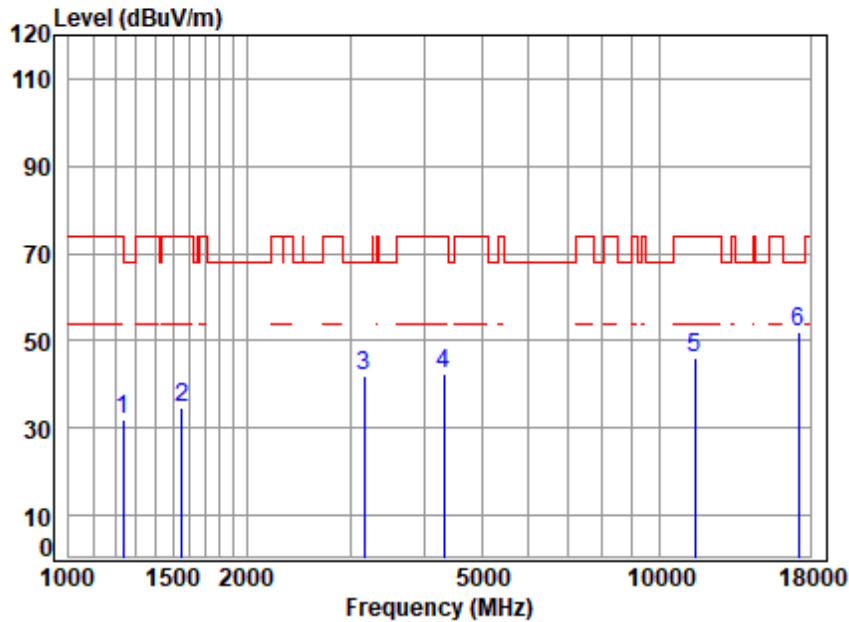

Site : chamber
 Condition: 3m VERTICAL
 Job No : 03018AT\03019AT
 Mode : 5745 TX RSE
 Note : 5G WIFI 11A

	Freq	Cable Loss	Ant Factor	Preamp Factor	Read Level	Level	Limit Line	Over Limit	Remark
	MHz	dB	dB/m	dB	dBuV	dBuV/m	dBuV/m	dB	
1	1238.483	3.73	24.94	61.57	65.00	32.10	74.00	-41.90	peak
2	1556.169	4.12	26.98	61.67	65.15	34.58	74.00	-39.42	peak
3	3168.500	6.23	32.65	61.37	64.33	41.84	68.20	-26.36	peak
4	4316.859	7.04	34.13	61.47	62.67	42.37	74.00	-31.63	peak
5	11490.000	11.94	37.79	62.62	58.84	45.95	74.00	-28.05	peak
6	p17235.000	14.59	43.03	61.65	56.04	52.01	68.20	-16.19	peak



Unless otherwise agreed in writing, this document is issued by the Company subject to its General Conditions of Service printed overleaf, available on request or accessible at <https://www.sgs.com/en/Terms-and-Conditions>. Attention is drawn to the limitation of liability, indemnification and jurisdiction issues defined therein. Any holder of this document is advised that information contained hereon reflects the Company's findings at the time of its intervention only and within the limits of Client's instructions, if any. The Company's sole responsibility is to its Client and this document does not exonerate parties to a transaction from exercising all their rights and obligations under the transaction documents. This document cannot be reproduced except in full, without prior written approval of the Company. Any unauthorized alteration, forgery or falsification of the content or appearance of this document is unlawful and offenders may be prosecuted to the fullest extent of the law. Unless otherwise stated the results shown in this test report refer only to the sample(s) tested and such sample(s) are retained for 30 days only.

Test Mode: 08; Polarity: Horizontal; Modulation:802.11a; Bandwidth:20MHz; Channel:middle

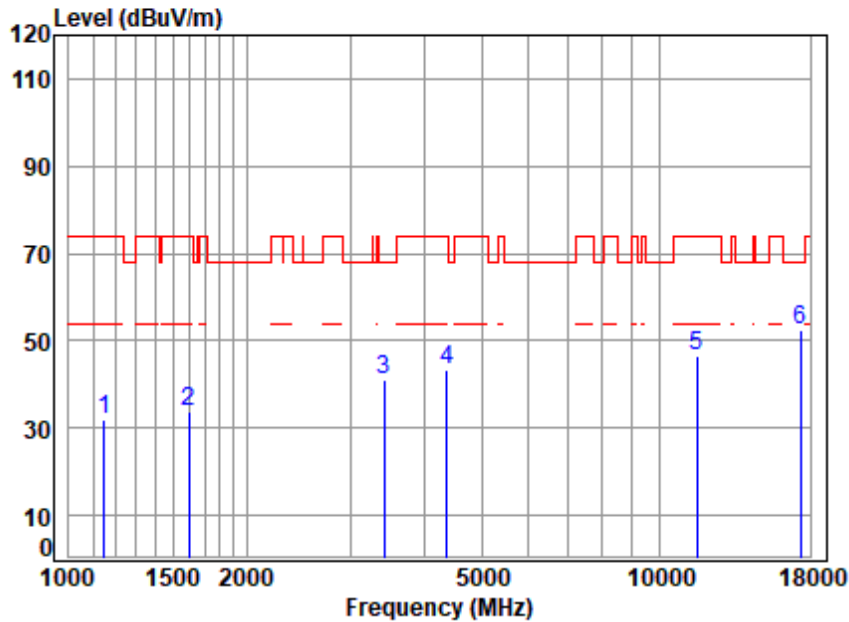

Site : chamber
 Condition: 3m HORIZONTAL
 Job No : 03018AT\03019AT
 Mode : 5785 TX RSE
 Note : 5G WIFI 11A

	Freq	Cable Loss	Ant Factor	Preamp Factor	Read Level	Level	Limit Line	Over Limit	Remark
	MHz	dB	dB/m	dB	dBuV	dBuV/m	dBuV/m	dB	
1	1148.823	3.61	23.90	61.53	66.04	32.02	74.00	-41.98	peak
2	1597.181	4.18	26.81	61.69	64.35	33.65	74.00	-40.35	peak
3	3425.675	6.46	32.09	61.30	63.81	41.06	68.20	-27.14	peak
4	4367.058	7.10	34.54	61.51	63.06	43.19	74.00	-30.81	peak
5	11570.000	11.95	37.73	62.64	59.38	46.42	74.00	-27.58	peak
6	p17355.000	14.73	43.26	61.53	56.10	52.56	68.20	-15.64	peak



Unless otherwise agreed in writing, this document is issued by the Company subject to its General Conditions of Service printed overleaf, available on request or accessible at <https://www.sgs.com/en/Terms-and-Conditions>. Attention is drawn to the limitation of liability, indemnification and jurisdiction issues defined therein. Any holder of this document is advised that information contained hereon reflects the Company's findings at the time of its intervention only and within the limits of Client's instructions, if any. The Company's sole responsibility is to its Client and this document does not exonerate parties to a transaction from exercising all their rights and obligations under the transaction documents. This document cannot be reproduced except in full, without prior written approval of the Company. Any unauthorized alteration, forgery or falsification of the content or appearance of this document is unlawful and offenders may be prosecuted to the fullest extent of the law. Unless otherwise stated the results shown in this test report refer only to the sample(s) tested and such sample(s) are retained for 30 days only.

Test Mode: 08; Polarity: Vertical; Modulation:802.11a; Bandwidth:20MHz; Channel:middle

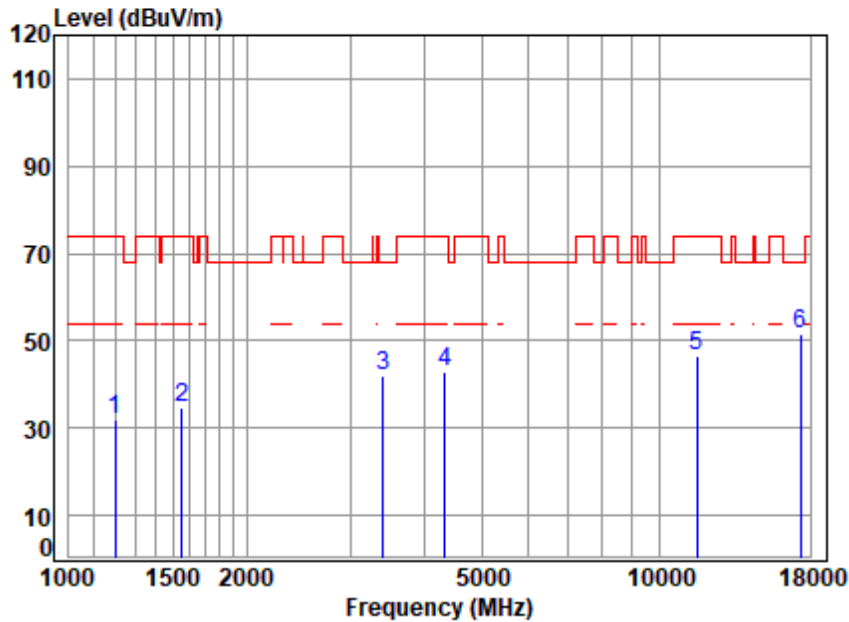

Site : chamber
 Condition: 3m VERTICAL
 Job No : 03018AT\03019AT
 Mode : 5785 TX RSE
 Note : 5G WIFI 11A

	Freq	Cable Loss	Ant Factor	Preamp Factor	Read Level	Limit Level	Over Limit	Remark
	MHz	dB	dB/m	dB	dBuV	dBuV/m	dBuV/m	dB
1	1196.264	3.68	24.36	61.55	65.30	31.79	74.00	-42.21 peak
2	1556.169	4.12	26.98	61.67	65.16	34.59	74.00	-39.41 peak
3	3405.929	6.44	32.33	61.31	64.40	41.86	68.20	-26.34 peak
4	4329.354	7.05	34.23	61.48	62.93	42.73	74.00	-31.27 peak
5	11570.000	11.95	37.73	62.64	59.55	46.59	74.00	-27.41 peak
6	p17355.000	14.73	43.26	61.53	55.05	51.51	68.20	-16.69 peak



Unless otherwise agreed in writing, this document is issued by the Company subject to its General Conditions of Service printed overleaf, available on request or accessible at <https://www.sgs.com/en/Terms-and-Conditions>. Attention is drawn to the limitation of liability, indemnification and jurisdiction issues defined therein. Any holder of this document is advised that information contained hereon reflects the Company's findings at the time of its intervention only and within the limits of Client's instructions, if any. The Company's sole responsibility is to its Client and this document does not exonerate parties to a transaction from exercising all their rights and obligations under the transaction documents. This document cannot be reproduced except in full, without prior written approval of the Company. Any unauthorized alteration, forgery or falsification of the content or appearance of this document is unlawful and offenders may be prosecuted to the fullest extent of the law. Unless otherwise stated the results shown in this test report refer only to the sample(s) tested and such sample(s) are retained for 30 days only.

Test Mode: 08; Polarity: Horizontal; Modulation:802.11a; Bandwidth:20MHz; Channel:High

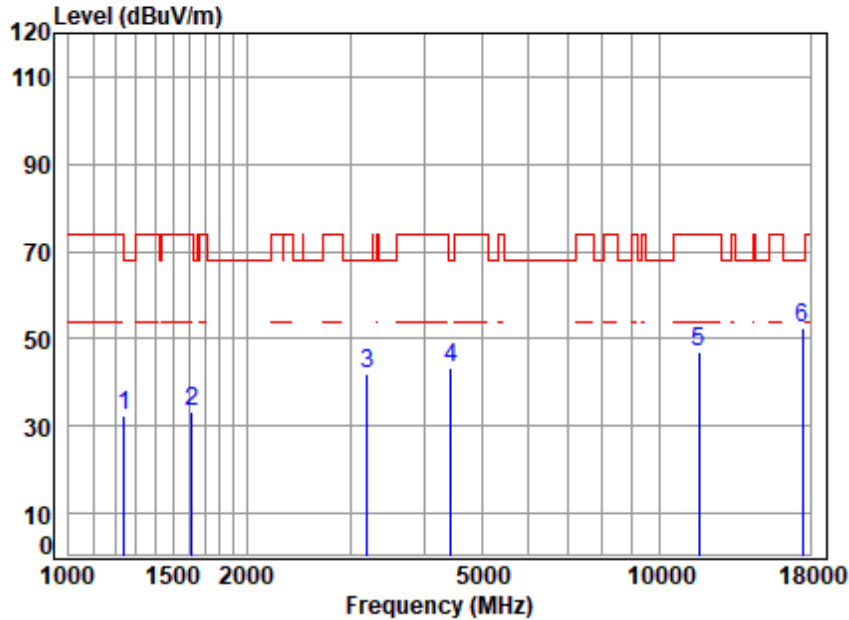

Site : chamber
 Condition: 3m HORIZONTAL
 Job No : 03018AT\03019AT
 Mode : 5825 TX RSE
 Note : 5G WIFI 11A

	Freq	Cable Loss	Ant Factor	Preamp Factor	Read Level	Level	Limit Line	Over Limit	Remark
	MHz	dB	dB/m	dB	dBuV	dBuV/m	dBuV/m	dB	
1	1242.068	3.74	24.99	61.57	65.32	32.48	68.20	-35.72	peak
2	1615.754	4.21	26.64	61.69	64.24	33.40	74.00	-40.60	peak
3	3196.094	6.25	32.87	61.36	64.06	41.82	68.20	-26.38	peak
4	4443.453	7.19	34.28	61.58	63.53	43.42	68.20	-24.78	peak
5	11650.000	11.95	37.80	62.65	59.73	46.83	74.00	-27.17	peak
6	p17475.000	14.86	43.40	61.41	55.47	52.32	68.20	-15.88	peak



Unless otherwise agreed in writing, this document is issued by the Company subject to its General Conditions of Service printed overleaf, available on request or accessible at <https://www.sgs.com/en/Terms-and-Conditions>. Attention is drawn to the limitation of liability, indemnification and jurisdiction issues defined therein. Any holder of this document is advised that information contained hereon reflects the Company's findings at the time of its intervention only and within the limits of Client's instructions, if any. The Company's sole responsibility is to its Client and this document does not exonerate parties to a transaction from exercising all their rights and obligations under the transaction documents. This document cannot be reproduced except in full, without prior written approval of the Company. Any unauthorized alteration, forgery or falsification of the content or appearance of this document is unlawful and offenders may be prosecuted to the fullest extent of the law. Unless otherwise stated the results shown in this test report refer only to the sample(s) tested and such sample(s) are retained for 30 days only.

Test Mode: 08; Polarity: Vertical; Modulation:802.11a; Bandwidth:20MHz; Channel:High

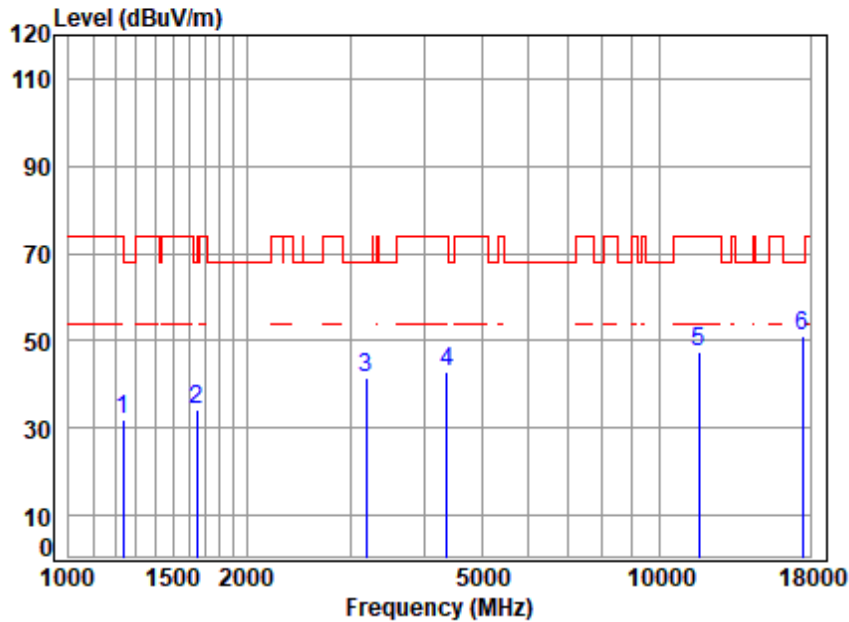

Site : chamber
 Condition: 3m VERTICAL
 Job No : 03018AT\03019AT
 Mode : 5825 TX RSE
 Note : 5G WIFI 11A

	Freq	Cable Loss	Ant Factor	Preamp Factor	Read Level	Level	Limit Line	Over Limit	Remark
	MHz	dB	dB/m	dB	dBuV	dBuV/m	dBuV/m	dB	
1	1238.483	3.73	24.94	61.57	64.91	32.01	74.00	-41.99	peak
2	1648.778	4.25	26.31	61.70	65.29	34.15	68.20	-34.05	peak
3	3186.869	6.25	32.79	61.37	63.66	41.33	68.20	-26.87	peak
4	4367.058	7.10	34.54	61.51	62.60	42.73	74.00	-31.27	peak
5	11650.000	11.95	37.80	62.65	60.35	47.45	74.00	-26.55	peak
6	p17475.000	14.86	43.40	61.41	54.40	51.25	68.20	-16.95	peak



Unless otherwise agreed in writing, this document is issued by the Company subject to its General Conditions of Service printed overleaf, available on request or accessible at <https://www.sgs.com/en/Terms-and-Conditions>. Attention is drawn to the limitation of liability, indemnification and jurisdiction issues defined therein. Any holder of this document is advised that information contained hereon reflects the Company's findings at the time of its intervention only and within the limits of Client's instructions, if any. The Company's sole responsibility is to its Client and this document does not exonerate parties to a transaction from exercising all their rights and obligations under the transaction documents. This document cannot be reproduced except in full, without prior written approval of the Company. Any unauthorized alteration, forgery or falsification of the content or appearance of this document is unlawful and offenders may be prosecuted to the fullest extent of the law. Unless otherwise stated the results shown in this test report refer only to the sample(s) tested and such sample(s) are retained for 30 days only.

Test Mode: 08; Polarity: Horizontal; Modulation:802.11n; Bandwidth:20MHz; Channel:Low

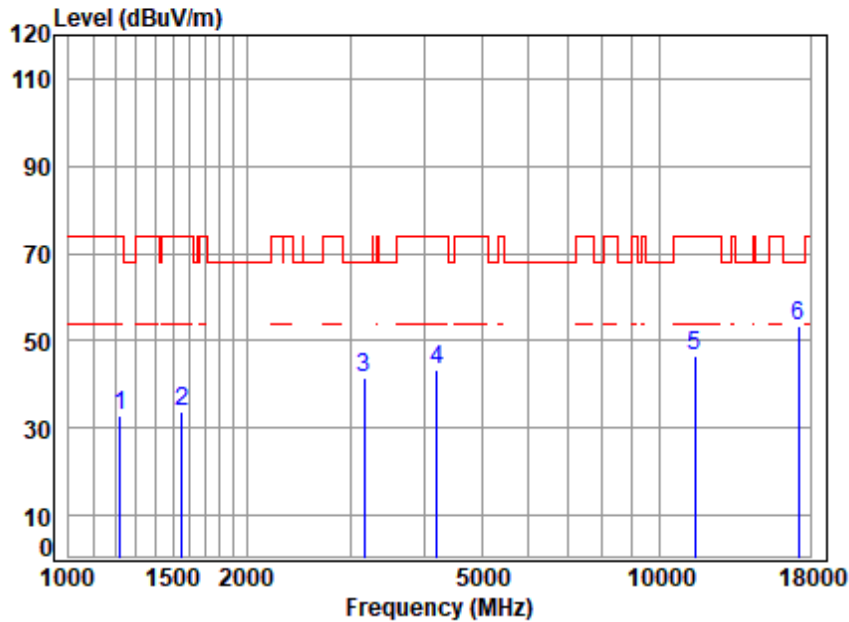

Site : chamber
 Condition: 3m HORIZONTAL
 Job No : 03018AT\03019AT
 Mode : 5745 TX RSE
 Note : 5G WIFI 11N20

	Freq	Cable Loss	Ant Factor	Preamp Factor	Read Level	Level	Limit Line	Over Limit	Remark
	MHz	dB	dB/m	dB	dBuV	dBuV/m	dBuV/m	dB	
1	1224.247	3.71	24.74	61.56	66.00	32.89	74.00	-41.11	peak
2	1556.169	4.12	26.98	61.67	64.40	33.83	74.00	-40.17	peak
3	3168.500	6.23	32.65	61.37	63.82	41.33	68.20	-26.87	peak
4	4193.872	6.89	33.80	61.35	63.92	43.26	74.00	-30.74	peak
5	11490.000	11.94	37.79	62.62	59.32	46.43	74.00	-27.57	peak
6	p17235.000	14.59	43.03	61.65	57.50	53.47	68.20	-14.73	peak



Unless otherwise agreed in writing, this document is issued by the Company subject to its General Conditions of Service printed overleaf, available on request or accessible at <https://www.sgs.com/en/Terms-and-Conditions>. Attention is drawn to the limitation of liability, indemnification and jurisdiction issues defined therein. Any holder of this document is advised that information contained hereon reflects the Company's findings at the time of its intervention only and within the limits of Client's instructions, if any. The Company's sole responsibility is to its Client and this document does not exonerate parties to a transaction from exercising all their rights and obligations under the transaction documents. This document cannot be reproduced except in full, without prior written approval of the Company. Any unauthorized alteration, forgery or falsification of the content or appearance of this document is unlawful and offenders may be prosecuted to the fullest extent of the law. Unless otherwise stated the results shown in this test report refer only to the sample(s) tested and such sample(s) are retained for 30 days only.

Test Mode: 08; Polarity: Vertical; Modulation:802.11n; Bandwidth:20MHz; Channel:Low

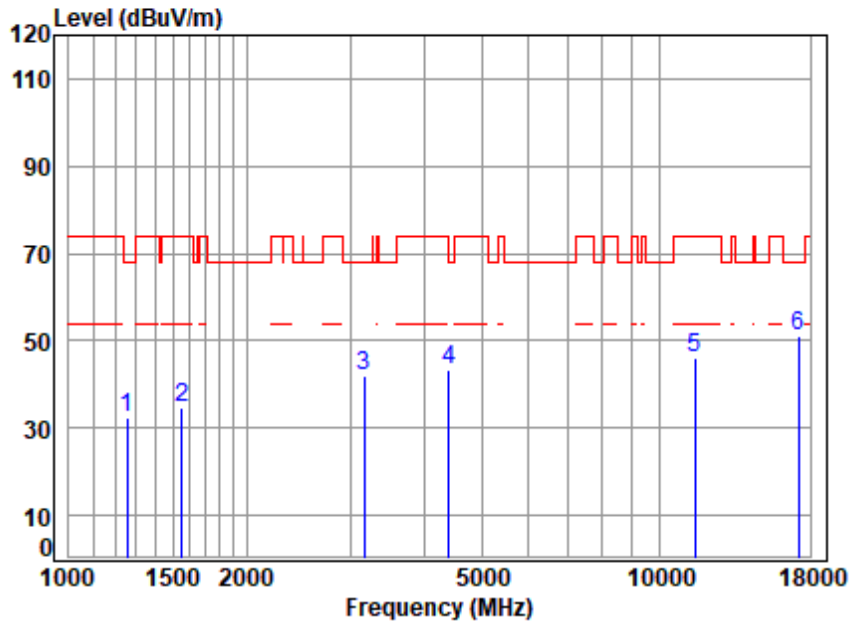

Site : chamber
 Condition: 3m VERTICAL
 Job No : 03018AT\03019AT
 Mode : 5745 TX RSE
 Note : 5G WIFI 11N20

	Freq	Cable Loss	Ant Factor	Preamp Factor	Read Level	Level	Limit Line	Over Limit	Remark
	MHz	dB	dB/m	dB	dBuV	dBuV/m	dBuV/m	dB	
1	1256.512	3.76	25.06	61.58	65.25	32.49	68.20	-35.71	peak
2	1556.169	4.12	26.98	61.67	65.40	34.83	74.00	-39.17	peak
3	3168.500	6.23	32.65	61.37	64.31	41.82	68.20	-26.38	peak
4	4405.090	7.14	34.74	61.55	62.79	43.12	68.20	-25.08	peak
5	11490.000	11.94	37.79	62.62	58.78	45.89	74.00	-28.11	peak
6	p17235.000	14.59	43.03	61.65	55.30	51.27	68.20	-16.93	peak



Unless otherwise agreed in writing, this document is issued by the Company subject to its General Conditions of Service printed overleaf, available on request or accessible at <https://www.sgs.com/en/Terms-and-Conditions>. Attention is drawn to the limitation of liability, indemnification and jurisdiction issues defined therein. Any holder of this document is advised that information contained hereon reflects the Company's findings at the time of its intervention only and within the limits of Client's instructions, if any. The Company's sole responsibility is to its Client and this document does not exonerate parties to a transaction from exercising all their rights and obligations under the transaction documents. This document cannot be reproduced except in full, without prior written approval of the Company. Any unauthorized alteration, forgery or falsification of the content or appearance of this document is unlawful and offenders may be prosecuted to the fullest extent of the law. Unless otherwise stated the results shown in this test report refer only to the sample(s) tested and such sample(s) are retained for 30 days only.

Test Mode: 08; Polarity: Horizontal; Modulation:802.11n; Bandwidth:20MHz; Channel:middle

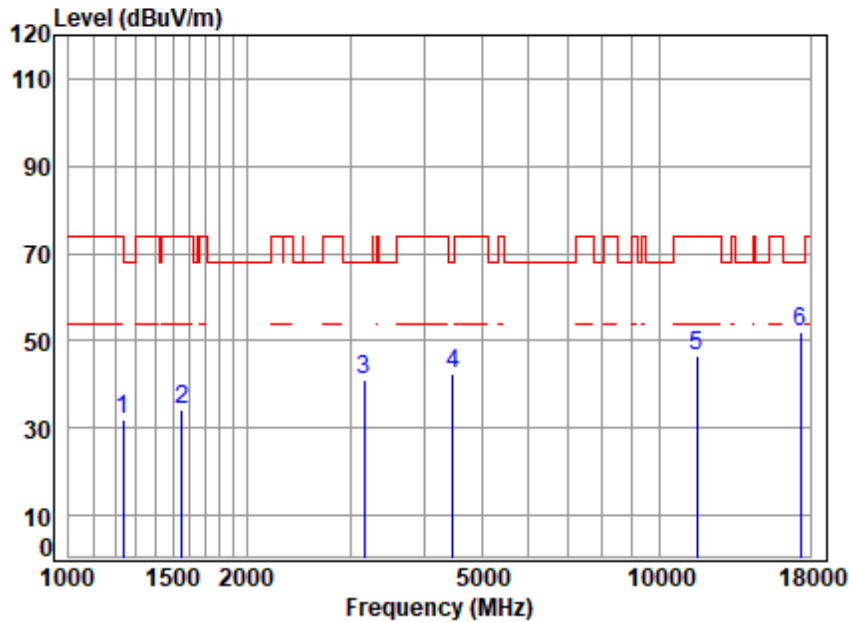

Site : chamber
 Condition: 3m HORIZONTAL
 Job No : 03018AT\03019AT
 Mode : 5785 TX RSE
 Note : 5G WIFI 11N20

	Freq	Cable Loss	Ant Factor	Preamp Factor	Read Level	Level	Limit Line	Over Limit	Remark
	MHz	dB	dB/m	dB	dBuV	dBuV/m	dBuV/m	dB	
1	1238.483	3.73	24.94	61.57	64.74	31.84	74.00	-42.16	peak
2	1556.169	4.12	26.98	61.67	64.76	34.19	74.00	-39.81	peak
3	3159.355	6.22	32.57	61.38	63.81	41.22	68.20	-26.98	peak
4	4469.214	7.22	33.97	61.60	62.89	42.48	68.20	-25.72	peak
5	11570.000	11.95	37.73	62.64	59.49	46.53	74.00	-27.47	peak
6	p17355.000	14.73	43.26	61.53	55.68	52.14	68.20	-16.06	peak



Unless otherwise agreed in writing, this document is issued by the Company subject to its General Conditions of Service printed overleaf, available on request or accessible at <https://www.sgs.com/en/Terms-and-Conditions>. Attention is drawn to the limitation of liability, indemnification and jurisdiction issues defined therein. Any holder of this document is advised that information contained hereon reflects the Company's findings at the time of its intervention only and within the limits of Client's instructions, if any. The Company's sole responsibility is to its Client and this document does not exonerate parties to a transaction from exercising all their rights and obligations under the transaction documents. This document cannot be reproduced except in full, without prior written approval of the Company. Any unauthorized alteration, forgery or falsification of the content or appearance of this document is unlawful and offenders may be prosecuted to the fullest extent of the law. Unless otherwise stated the results shown in this test report refer only to the sample(s) tested and such sample(s) are retained for 30 days only.

Test Mode: 08; Polarity: Vertical; Modulation:802.11n; Bandwidth:20MHz; Channel:middle

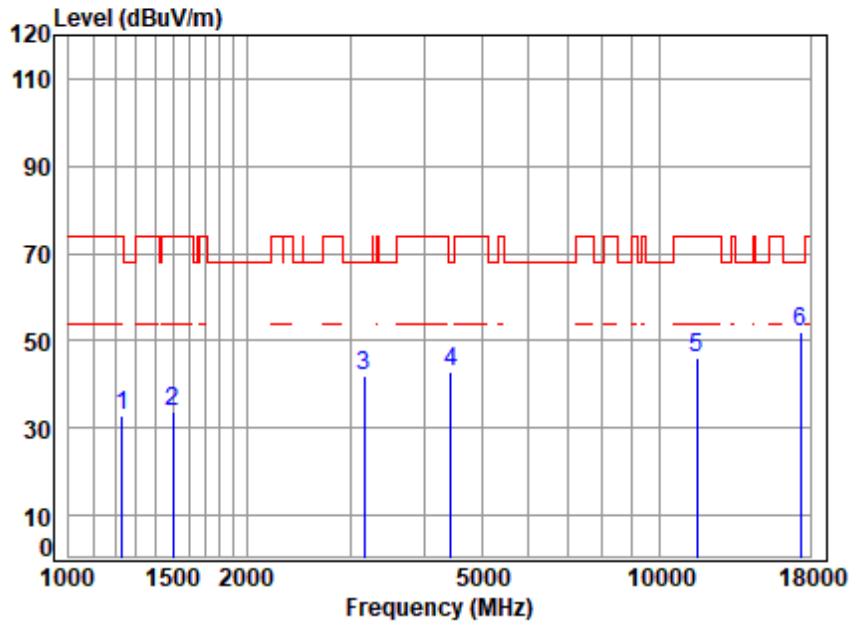

Site : chamber
 Condition: 3m VERTICAL
 Job No : 03018AT\03019AT
 Mode : 5785 TX RSE
 Note : 5G WIFI 11N20

	Freq	Cable Loss	Ant Factor	Preamp Factor	Read Level	Level	Limit Line	Over Limit	Remark
	MHz	dB	dB/m	dB	dBuV	dBuV/m	dBuV/m	dB	
1	1231.345	3.72	24.84	61.57	66.08	33.07	74.00	-40.93	peak
2	1503.119	4.04	26.81	61.66	64.55	33.74	74.00	-40.26	peak
3	3168.500	6.23	32.65	61.37	64.42	41.93	68.20	-26.27	peak
4	4443.453	7.19	34.28	61.58	62.97	42.86	68.20	-25.34	peak
5	11570.000	11.95	37.73	62.64	58.95	45.99	74.00	-28.01	peak
6	p17355.000	14.73	43.26	61.53	55.40	51.86	68.20	-16.34	peak



Unless otherwise agreed in writing, this document is issued by the Company subject to its General Conditions of Service printed overleaf, available on request or accessible at <https://www.sgs.com/en/Terms-and-Conditions>. Attention is drawn to the limitation of liability, indemnification and jurisdiction issues defined therein. Any holder of this document is advised that information contained hereon reflects the Company's findings at the time of its intervention only and within the limits of Client's instructions, if any. The Company's sole responsibility is to its Client and this document does not exonerate parties to a transaction from exercising all their rights and obligations under the transaction documents. This document cannot be reproduced except in full, without prior written approval of the Company. Any unauthorized alteration, forgery or falsification of the content or appearance of this document is unlawful and offenders may be prosecuted to the fullest extent of the law. Unless otherwise stated the results shown in this test report refer only to the sample(s) tested and such sample(s) are retained for 30 days only.

Test Mode: 08; Polarity: Horizontal; Modulation:802.11n; Bandwidth:20MHz; Channel:High

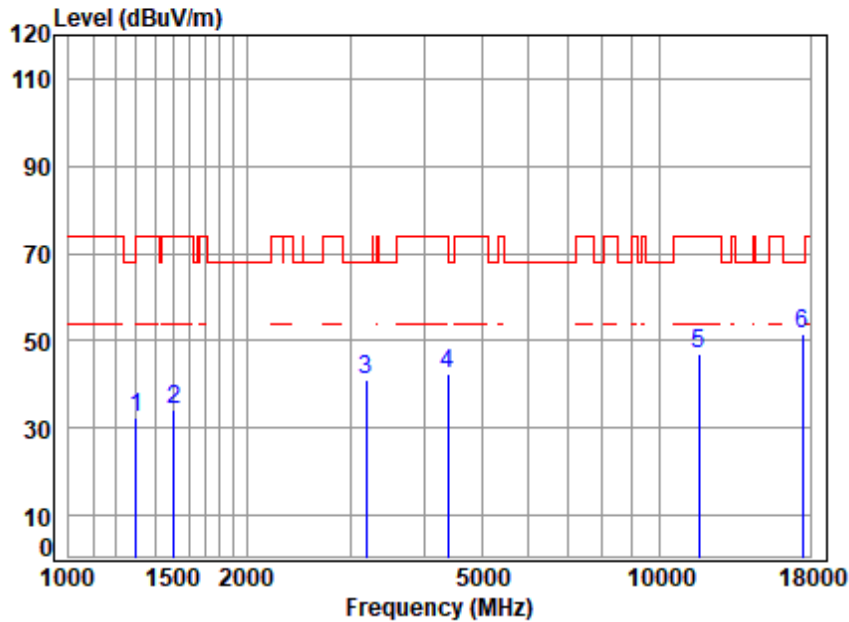

Site : chamber
 Condition: 3m HORIZONTAL
 Job No : 03018AT\03019AT
 Mode : 5825 TX RSE
 Note : 5G WIFI 11N20

	Freq	Cable Loss	Ant Factor	Preamp Factor	Read Level	Level	Limit Line	Over Limit	Remark
	MHz	dB	dB/m	dB	dBuV	dBuV/m	dBuV/m	dB	
1	1300.858	3.81	24.79	61.59	65.25	32.26	74.00	-41.74	peak
2	1507.470	4.05	26.83	61.66	64.91	34.13	74.00	-39.87	peak
3	3186.869	6.25	32.79	61.37	63.62	41.29	68.20	-26.91	peak
4	4379.699	7.11	34.64	61.52	62.12	42.35	74.00	-31.65	peak
5	11650.000	11.95	37.80	62.65	59.95	47.05	74.00	-26.95	peak
6	p17475.000	14.86	43.40	61.41	54.79	51.64	68.20	-16.56	peak



Unless otherwise agreed in writing, this document is issued by the Company subject to its General Conditions of Service printed overleaf, available on request or accessible at <https://www.sgs.com/en/Terms-and-Conditions>. Attention is drawn to the limitation of liability, indemnification and jurisdiction issues defined therein. Any holder of this document is advised that information contained hereon reflects the Company's findings at the time of its intervention only and within the limits of Client's instructions, if any. The Company's sole responsibility is to its Client and this document does not exonerate parties to a transaction from exercising all their rights and obligations under the transaction documents. This document cannot be reproduced except in full, without prior written approval of the Company. Any unauthorized alteration, forgery or falsification of the content or appearance of this document is unlawful and offenders may be prosecuted to the fullest extent of the law. Unless otherwise stated the results shown in this test report refer only to the sample(s) tested and such sample(s) are retained for 30 days only.

Test Mode: 08; Polarity: Vertical; Modulation:802.11n; Bandwidth:20MHz; Channel:High

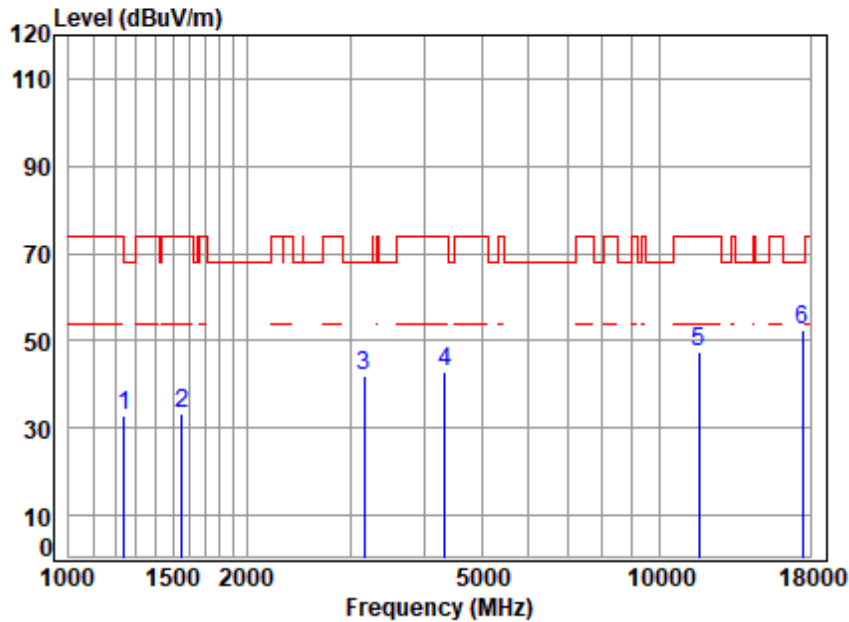

Site : chamber
 Condition: 3m VERTICAL
 Job No : 03018AT\03019AT
 Mode : 5825 TX RSE
 Note : 5G WIFI 11N20

	Freq	Cable Loss	Ant Factor	Preamp Factor	Read Level	Level	Limit Line	Over Limit	Remark
	MHz	dB	dB/m	dB	dBuV	dBuV/m	dBuV/m	dB	
1	1242.068	3.74	24.99	61.57	65.89	33.05	68.20	-35.15	peak
2	1556.169	4.12	26.98	61.67	64.10	33.53	74.00	-40.47	peak
3	3159.355	6.22	32.57	61.38	64.58	41.99	68.20	-26.21	peak
4	4329.354	7.05	34.23	61.48	63.06	42.86	74.00	-31.14	peak
5	11650.000	11.95	37.80	62.65	60.17	47.27	74.00	-26.73	peak
6	p17475.000	14.86	43.40	61.41	55.67	52.52	68.20	-15.68	peak



Unless otherwise agreed in writing, this document is issued by the Company subject to its General Conditions of Service printed overleaf, available on request or accessible at <https://www.sgs.com/en/Terms-and-Conditions>. Attention is drawn to the limitation of liability, indemnification and jurisdiction issues defined therein. Any holder of this document is advised that information contained hereon reflects the Company's findings at the time of its intervention only and within the limits of Client's instructions, if any. The Company's sole responsibility is to its Client and this document does not exonerate parties to a transaction from exercising all their rights and obligations under the transaction documents. This document cannot be reproduced except in full, without prior written approval of the Company. Any unauthorized alteration, forgery or falsification of the content or appearance of this document is unlawful and offenders may be prosecuted to the fullest extent of the law. Unless otherwise stated the results shown in this test report refer only to the sample(s) tested and such sample(s) are retained for 30 days only.

Test Mode: 08; Polarity: Horizontal; Modulation:802.11n; Bandwidth:40MHz; Channel:Low

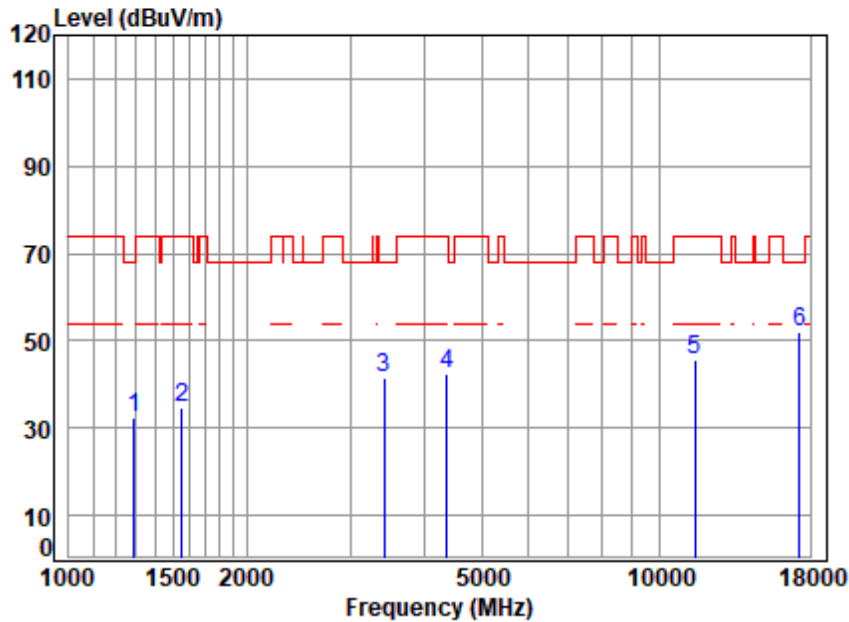

Site : chamber
 Condition: 3m HORIZONTAL
 Job No : 03018AT\03019AT
 Mode : 5755 TX RSE
 Note : 5G WIFI 11N40

	Freq	Cable Loss	Ant Factor	Preamp Factor	Read Level	Level	Limit Line	Over Limit	Remark
	MHz	dB	dB/m	dB	dBuV	dBuV/m	dBuV/m	dB	
1	1289.627	3.80	24.86	61.59	65.34	32.41	68.20	-35.79	peak
2	1551.677	4.12	26.99	61.67	65.41	34.85	74.00	-39.15	peak
3	3425.675	6.46	32.09	61.30	64.32	41.57	68.20	-26.63	peak
4	4367.058	7.10	34.54	61.51	62.26	42.39	74.00	-31.61	peak
5	11510.000	11.95	37.79	62.62	58.72	45.84	74.00	-28.16	peak
6	p17265.000	14.62	43.06	61.62	56.14	52.20	68.20	-16.00	peak



Unless otherwise agreed in writing, this document is issued by the Company subject to its General Conditions of Service printed overleaf, available on request or accessible at <https://www.sgs.com/en/Terms-and-Conditions>. Attention is drawn to the limitation of liability, indemnification and jurisdiction issues defined therein. Any holder of this document is advised that information contained hereon reflects the Company's findings at the time of its intervention only and within the limits of Client's instructions, if any. The Company's sole responsibility is to its Client and this document does not exonerate parties to a transaction from exercising all their rights and obligations under the transaction documents. This document cannot be reproduced except in full, without prior written approval of the Company. Any unauthorized alteration, forgery or falsification of the content or appearance of this document is unlawful and offenders may be prosecuted to the fullest extent of the law. Unless otherwise stated the results shown in this test report refer only to the sample(s) tested and such sample(s) are retained for 30 days only.

Test Mode: 08; Polarity: Vertical; Modulation:802.11n; Bandwidth:40MHz; Channel:Low

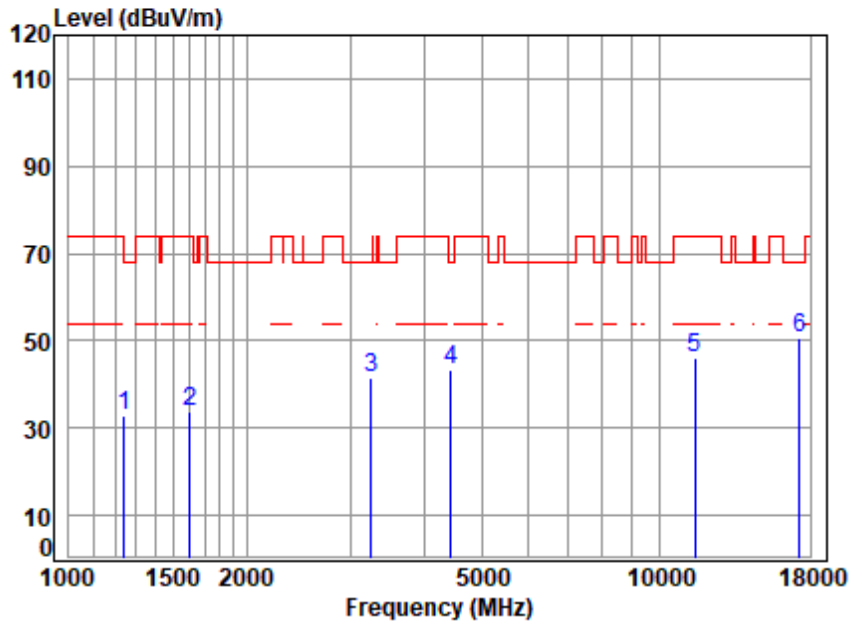

Site : chamber
 Condition: 3m VERTICAL
 Job No : 03018AT\03019AT
 Mode : 5755 TX RSE
 Note : 5G WIFI 11N40

	Freq	Cable Loss	Ant Factor	Preamp Factor	Read Level	Level	Limit Line	Over Limit	Remark
	MHz	dB	dB/m	dB	dBuV	dBuV/m	dBuV/m	dB	
1	1242.068	3.74	24.99	61.57	65.69	32.85	68.20	-35.35	peak
2	1601.804	4.19	26.78	61.69	64.61	33.89	74.00	-40.11	peak
3	3252.005	6.31	32.06	61.35	64.46	41.48	68.20	-26.72	peak
4	4443.453	7.19	34.28	61.58	63.35	43.24	68.20	-24.96	peak
5	11510.000	11.95	37.79	62.62	59.14	46.26	74.00	-27.74	peak
6	p17265.000	14.62	43.06	61.62	54.71	50.77	68.20	-17.43	peak



Unless otherwise agreed in writing, this document is issued by the Company subject to its General Conditions of Service printed overleaf, available on request or accessible at <https://www.sgs.com/en/Terms-and-Conditions>. Attention is drawn to the limitation of liability, indemnification and jurisdiction issues defined therein. Any holder of this document is advised that information contained hereon reflects the Company's findings at the time of its intervention only and within the limits of Client's instructions, if any. The Company's sole responsibility is to its Client and this document does not exonerate parties to a transaction from exercising all their rights and obligations under the transaction documents. This document cannot be reproduced except in full, without prior written approval of the Company. Any unauthorized alteration, forgery or falsification of the content or appearance of this document is unlawful and offenders may be prosecuted to the fullest extent of the law. Unless otherwise stated the results shown in this test report refer only to the sample(s) tested and such sample(s) are retained for 30 days only.

Test Mode: 08; Polarity: Horizontal; Modulation:802.11n; Bandwidth:40MHz; Channel:High

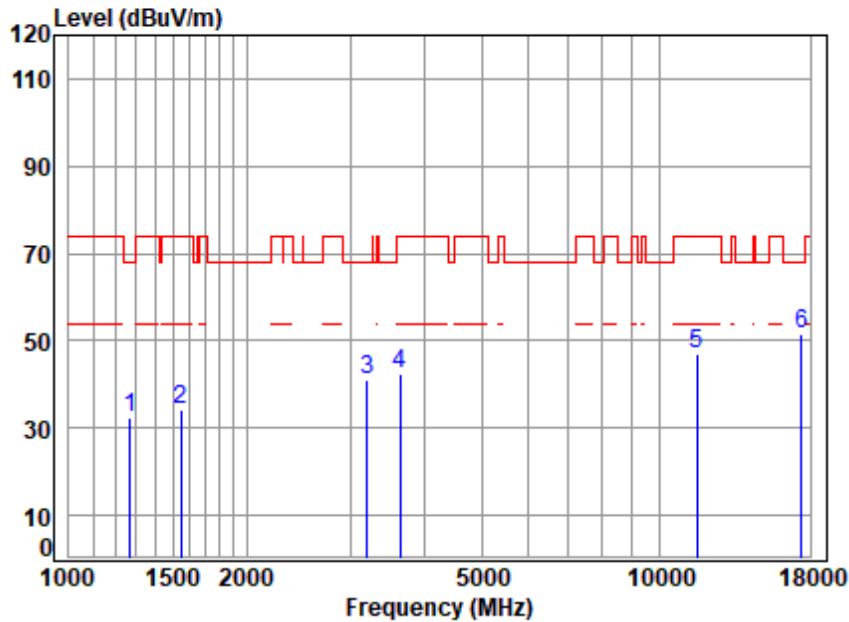

Site : chamber
 Condition: 3m HORIZONTAL
 Job No : 03018AT\03019AT
 Mode : 5795 TX RSE
 Note : 5G WIFI 11N40

	Freq	Cable Loss	Ant Factor	Preamp Factor	Read Level	Level	Limit Line	Over Limit	Remark
	MHz	dB	dB/m	dB	dBuV	dBuV/m	dBuV/m	dB	
1	1271.123	3.77	24.97	61.58	65.13	32.29	68.20	-35.91	peak
2	1547.199	4.11	26.99	61.67	65.00	34.43	74.00	-39.57	peak
3	3196.094	6.25	32.87	61.36	63.52	41.28	68.20	-26.92	peak
4	3640.045	6.56	32.58	61.25	64.70	42.59	74.00	-31.41	peak
5	11590.000	11.95	37.71	62.64	60.01	47.03	74.00	-26.97	peak
6	p17385.000	14.76	43.35	61.50	55.13	51.74	68.20	-16.46	peak



Unless otherwise agreed in writing, this document is issued by the Company subject to its General Conditions of Service printed overleaf, available on request or accessible at <https://www.sgs.com/en/Terms-and-Conditions>. Attention is drawn to the limitation of liability, indemnification and jurisdiction issues defined therein. Any holder of this document is advised that information contained hereon reflects the Company's findings at the time of its intervention only and within the limits of Client's instructions, if any. The Company's sole responsibility is to its Client and this document does not exonerate parties to a transaction from exercising all their rights and obligations under the transaction documents. This document cannot be reproduced except in full, without prior written approval of the Company. Any unauthorized alteration, forgery or falsification of the content or appearance of this document is unlawful and offenders may be prosecuted to the fullest extent of the law. Unless otherwise stated the results shown in this test report refer only to the sample(s) tested and such sample(s) are retained for 30 days only.

Test Mode: 08; Polarity: Vertical; Modulation:802.11n; Bandwidth:40MHz; Channel:High

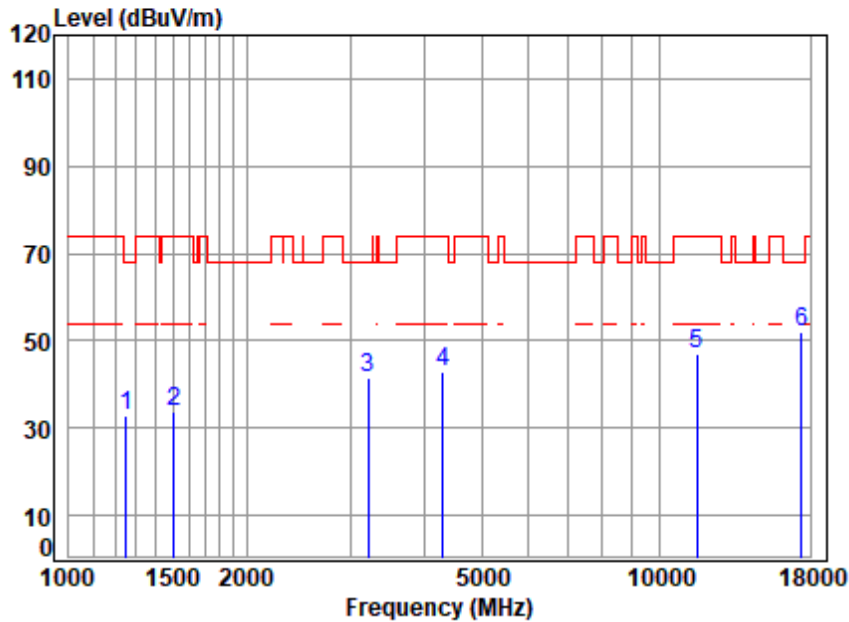

Site : chamber
 Condition: 3m VERTICAL
 Job No : 03018AT\03019AT
 Mode : 5795 TX RSE
 Note : 5G WIFI 11N40

	Freq	Cable Loss	Ant Factor	Preamp Factor	Read Level	Level	Limit Line	Over Limit	Remark
	MHz	dB	dB/m	dB	dBuV	dBuV/m	dBuV/m	dB	
1	1249.269	3.75	25.09	61.57	65.47	32.74	68.20	-35.46	peak
2	1507.470	4.05	26.83	61.66	64.73	33.95	74.00	-40.05	peak
3	3214.623	6.27	32.67	61.36	64.09	41.67	68.20	-26.53	peak
4	4304.400	7.02	34.04	61.46	63.20	42.80	74.00	-31.20	peak
5	11590.000	11.95	37.71	62.64	59.90	46.92	74.00	-27.08	peak
6	p17385.000	14.76	43.35	61.50	55.31	51.92	68.20	-16.28	peak



Unless otherwise agreed in writing, this document is issued by the Company subject to its General Conditions of Service printed overleaf, available on request or accessible at <https://www.sgs.com/en/Terms-and-Conditions>. Attention is drawn to the limitation of liability, indemnification and jurisdiction issues defined therein. Any holder of this document is advised that information contained hereon reflects the Company's findings at the time of its intervention only and within the limits of Client's instructions, if any. The Company's sole responsibility is to its Client and this document does not exonerate parties to a transaction from exercising all their rights and obligations under the transaction documents. This document cannot be reproduced except in full, without prior written approval of the Company. Any unauthorized alteration, forgery or falsification of the content or appearance of this document is unlawful and offenders may be prosecuted to the fullest extent of the law. Unless otherwise stated the results shown in this test report refer only to the sample(s) tested and such sample(s) are retained for 30 days only.

Test Mode: 08; Polarity: Horizontal; Modulation:802.11 ax(Full RU0); Bandwidth:20MHz; Channel:Low

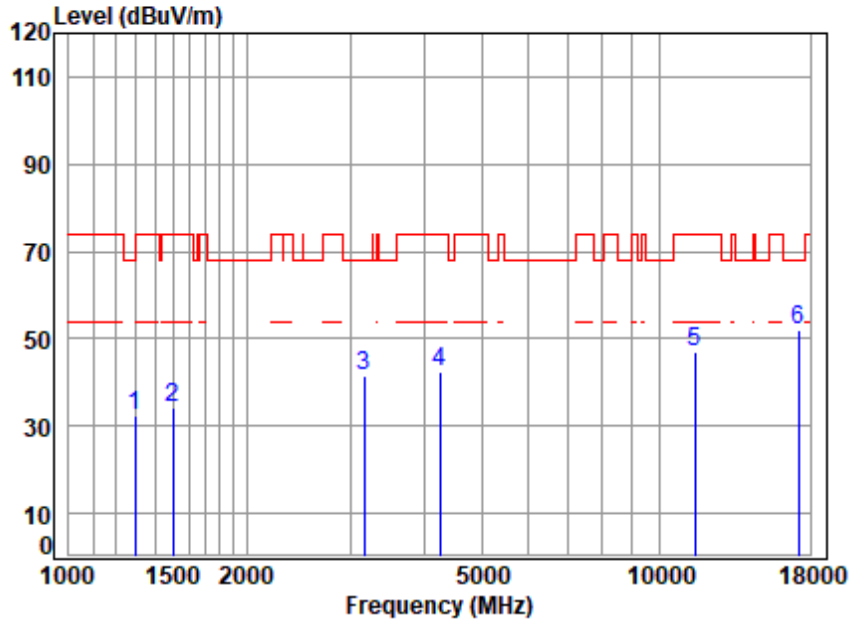

Site : chamber
 Condition: 3m HORIZONTAL
 Job No : 03018AT\03019AT
 Mode : 5745 TX RSE
 Note : 5G WIFI 11AX20

	Freq	Cable Loss	Ant Factor	Preamp Factor	Read Level	Level	Limit Line	Over Limit	Remark
	MHz	dB	dB/m	dB	dBuV	dBuV/m	dBuV/m	dB	
1	1293.359	3.80	24.84	61.59	65.46	32.51	68.20	-35.69	peak
2	1503.119	4.04	26.81	61.66	65.19	34.38	74.00	-39.62	peak
3	3168.500	6.23	32.65	61.37	63.98	41.49	68.20	-26.71	peak
4	4242.641	6.95	33.80	61.40	62.99	42.34	74.00	-31.66	peak
5	11490.000	11.94	37.79	62.62	59.67	46.78	74.00	-27.22	peak
6	p17235.000	14.59	43.03	61.65	56.02	51.99	68.20	-16.21	peak



Unless otherwise agreed in writing, this document is issued by the Company subject to its General Conditions of Service printed overleaf, available on request or accessible at <https://www.sgs.com/en/Terms-and-Conditions>. Attention is drawn to the limitation of liability, indemnification and jurisdiction issues defined therein. Any holder of this document is advised that information contained hereon reflects the Company's findings at the time of its intervention only and within the limits of Client's instructions, if any. The Company's sole responsibility is to its Client and this document does not exonerate parties to a transaction from exercising all their rights and obligations under the transaction documents. This document cannot be reproduced except in full, without prior written approval of the Company. Any unauthorized alteration, forgery or falsification of the content or appearance of this document is unlawful and offenders may be prosecuted to the fullest extent of the law. Unless otherwise stated the results shown in this test report refer only to the sample(s) tested and such sample(s) are retained for 30 days only.

Test Mode: 08; Polarity: Vertical; Modulation:802.11ax(Full RU0); Bandwidth:20MHz; Channel:Low

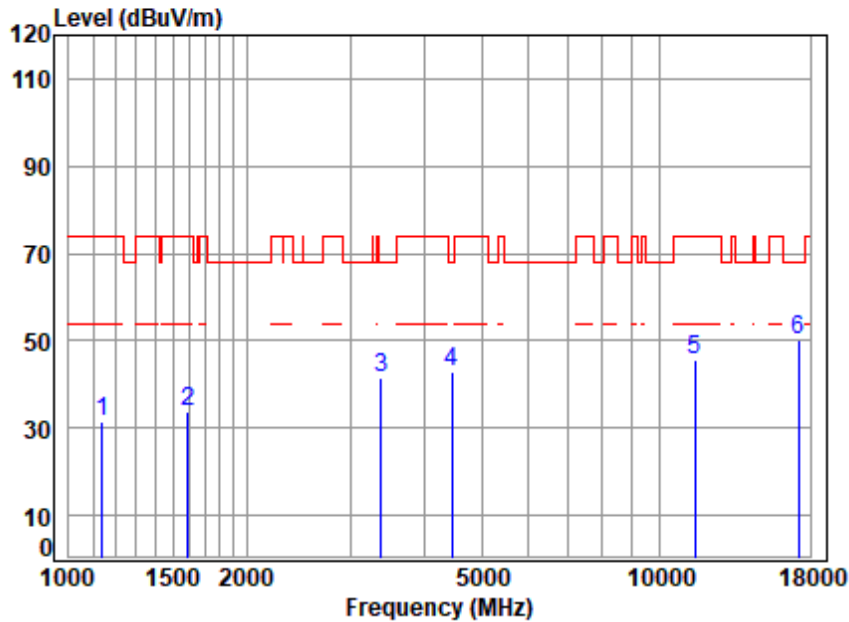

Site : chamber
 Condition: 3m VERTICAL
 Job No : 03018AT\03019AT
 Mode : 5745 TX RSE
 Note : 5G WIFI 11AX20

	Freq	Cable Loss	Ant Factor	Preamp Factor	Read Level	Level	Limit Line	Over Limit	Remark
	MHz	dB	dB/m	dB	dBuV	dBuV/m	dBuV/m	dB	
1	1138.904	3.60	23.86	61.53	65.71	31.64	74.00	-42.36	peak
2	1592.571	4.18	26.83	61.68	64.26	33.59	74.00	-40.41	peak
3	3376.523	6.42	32.26	61.32	63.99	41.35	68.20	-26.85	peak
4	4456.315	7.20	34.12	61.59	63.09	42.82	68.20	-25.38	peak
5	11490.000	11.94	37.79	62.62	58.55	45.66	74.00	-28.34	peak
6	p17235.000	14.59	43.03	61.65	54.25	50.22	68.20	-17.98	peak



Unless otherwise agreed in writing, this document is issued by the Company subject to its General Conditions of Service printed overleaf, available on request or accessible at <https://www.sgs.com/en/Terms-and-Conditions>. Attention is drawn to the limitation of liability, indemnification and jurisdiction issues defined therein. Any holder of this document is advised that information contained hereon reflects the Company's findings at the time of its intervention only and within the limits of Client's instructions, if any. The Company's sole responsibility is to its Client and this document does not exonerate parties to a transaction from exercising all their rights and obligations under the transaction documents. This document cannot be reproduced except in full, without prior written approval of the Company. Any unauthorized alteration, forgery or falsification of the content or appearance of this document is unlawful and offenders may be prosecuted to the fullest extent of the law. Unless otherwise stated the results shown in this test report refer only to the sample(s) tested and such sample(s) are retained for 30 days only.

Test Mode: 08; Polarity: Horizontal; Modulation:802.11ax(Full RU0); Bandwidth:20MHz; Channel:middle

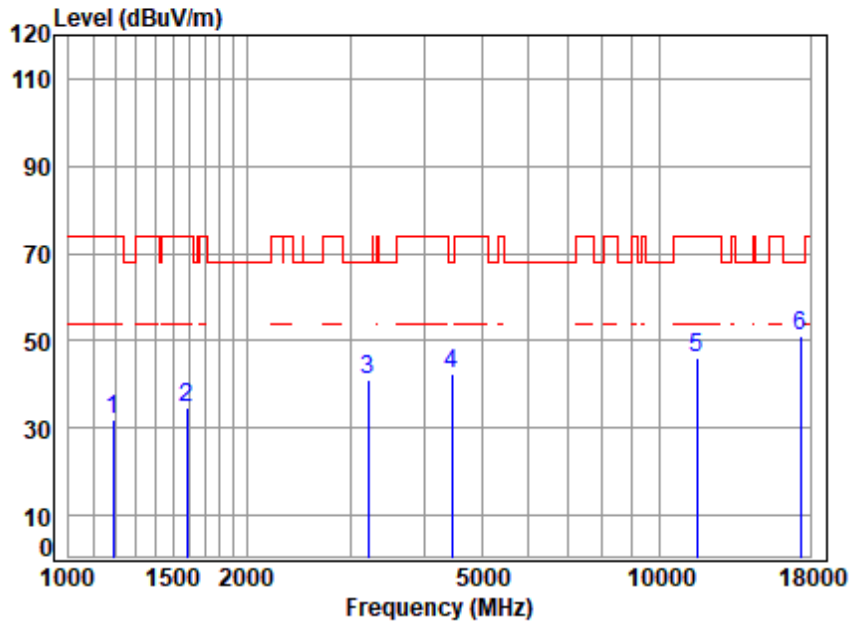

Site : chamber
 Condition: 3m HORIZONTAL
 Job No : 03018AT\03019AT
 Mode : 5785 TX RSE
 Note : 5G WIFI 11AX20

	Cable	Ant	Preamp	Read	Limit	Over		
Freq	Loss	Factor	Factor	Level	Level	Line	Limit	Remark
MHz	dB	dB/m	dB	dBuV	dBuV/m	dBuV/m	dB	
1	1189.368	3.67	24.29	61.55	65.54	31.95	74.00	-42.05 peak
2	1583.392	4.16	26.87	61.68	65.47	34.82	74.00	-39.18 peak
3	3214.623	6.27	32.67	61.36	63.50	41.08	68.20	-27.12 peak
4	4456.315	7.20	34.12	61.59	62.89	42.62	68.20	-25.58 peak
5	11570.000	11.95	37.73	62.64	59.06	46.10	74.00	-27.90 peak
6	p17355.000	14.73	43.26	61.53	54.43	50.89	68.20	-17.31 peak



Unless otherwise agreed in writing, this document is issued by the Company subject to its General Conditions of Service printed overleaf, available on request or accessible at <https://www.sgs.com/en/Terms-and-Conditions>. Attention is drawn to the limitation of liability, indemnification and jurisdiction issues defined therein. Any holder of this document is advised that information contained hereon reflects the Company's findings at the time of its intervention only and within the limits of Client's instructions, if any. The Company's sole responsibility is to its Client and this document does not exonerate parties to a transaction from exercising all their rights and obligations under the transaction documents. This document cannot be reproduced except in full, without prior written approval of the Company. Any unauthorized alteration, forgery or falsification of the content or appearance of this document is unlawful and offenders may be prosecuted to the fullest extent of the law. Unless otherwise stated the results shown in this test report refer only to the sample(s) tested and such sample(s) are retained for 30 days only.

Test Mode: 08; Polarity: Vertical; Modulation:802.11ax(Full RU0); Bandwidth:20MHz; Channel:middle

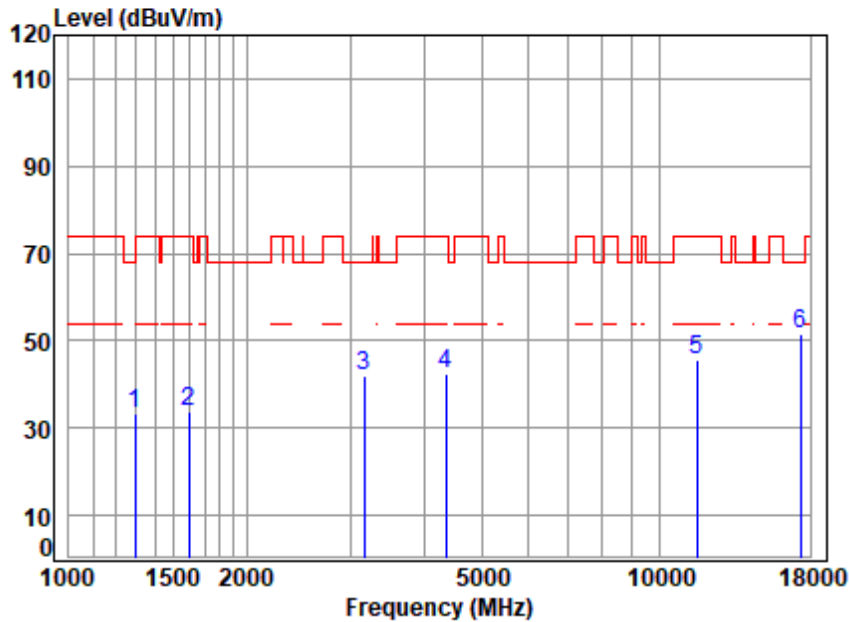

Site : chamber
 Condition: 3m VERTICAL
 Job No : 03018AT\03019AT
 Mode : 5785 TX RSE
 Note : 5G WIFI 11AX20

	Freq	Cable Loss	Ant Factor	Preamp Factor	Read Level	Level	Limit Line	Over Limit	Remark
	MHz	dB	dB/m	dB	dBuV	dBuV/m	dBuV/m	dB	
1	1297.103	3.81	24.82	61.59	66.42	33.46	68.20	-34.74	peak
2	1597.181	4.18	26.81	61.69	64.66	33.96	74.00	-40.04	peak
3	3159.355	6.22	32.57	61.38	64.37	41.78	68.20	-26.42	peak
4	4354.454	7.08	34.44	61.50	62.54	42.56	74.00	-31.44	peak
5	11570.000	11.95	37.73	62.64	58.75	45.79	74.00	-28.21	peak
6	p17355.000	14.73	43.26	61.53	55.12	51.58	68.20	-16.62	peak



Unless otherwise agreed in writing, this document is issued by the Company subject to its General Conditions of Service printed overleaf, available on request or accessible at <https://www.sgs.com/en/Terms-and-Conditions>. Attention is drawn to the limitation of liability, indemnification and jurisdiction issues defined therein. Any holder of this document is advised that information contained hereon reflects the Company's findings at the time of its intervention only and within the limits of Client's instructions, if any. The Company's sole responsibility is to its Client and this document does not exonerate parties to a transaction from exercising all their rights and obligations under the transaction documents. This document cannot be reproduced except in full, without prior written approval of the Company. Any unauthorized alteration, forgery or falsification of the content or appearance of this document is unlawful and offenders may be prosecuted to the fullest extent of the law. Unless otherwise stated the results shown in this test report refer only to the sample(s) tested and such sample(s) are retained for 30 days only.

Test Mode: 08; Polarity: Horizontal; Modulation:802.11ax(Full RU0); Bandwidth:20MHz; Channel:High

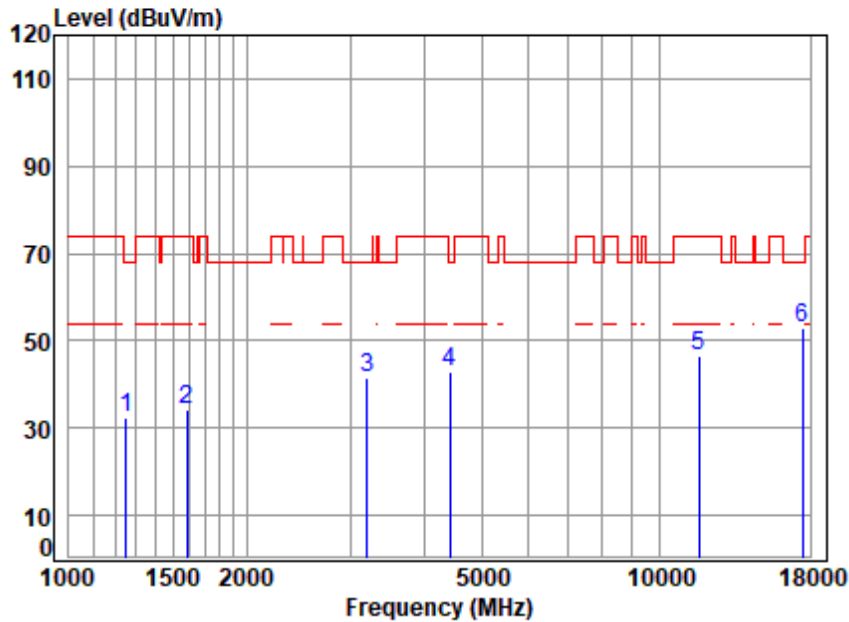

Site : chamber
 Condition: 3m HORIZONTAL
 Job No : 03018AT\03019AT
 Mode : 5825 TX RSE
 Note : 5G WIFI 11AX20

	Freq	Cable Loss	Ant Factor	Preamp Factor	Read Level	Level	Limit Line	Over Limit	Remark
	MHz	dB	dB/m	dB	dBuV	dBuV/m	dBuV/m	dB	
1	1252.885	3.75	25.08	61.57	65.23	32.49	68.20	-35.71	peak
2	1587.975	4.17	26.85	61.68	65.03	34.37	74.00	-39.63	peak
3	3196.094	6.25	32.87	61.36	63.70	41.46	68.20	-26.74	peak
4	4417.841	7.16	34.59	61.56	62.64	42.83	68.20	-25.37	peak
5	11650.000	11.95	37.80	62.65	59.67	46.77	74.00	-27.23	peak
6	p17475.000	14.86	43.40	61.41	56.22	53.07	68.20	-15.13	peak



Unless otherwise agreed in writing, this document is issued by the Company subject to its General Conditions of Service printed overleaf, available on request or accessible at <https://www.sgs.com/en/Terms-and-Conditions>. Attention is drawn to the limitation of liability, indemnification and jurisdiction issues defined therein. Any holder of this document is advised that information contained hereon reflects the Company's findings at the time of its intervention only and within the limits of Client's instructions, if any. The Company's sole responsibility is to its Client and this document does not exonerate parties to a transaction from exercising all their rights and obligations under the transaction documents. This document cannot be reproduced except in full, without prior written approval of the Company. Any unauthorized alteration, forgery or falsification of the content or appearance of this document is unlawful and offenders may be prosecuted to the fullest extent of the law. Unless otherwise stated the results shown in this test report refer only to the sample(s) tested and such sample(s) are retained for 30 days only.

Test Mode: 08; Polarity: Vertical; Modulation:802.11ax(Full RU0); Bandwidth:20MHz; Channel:High

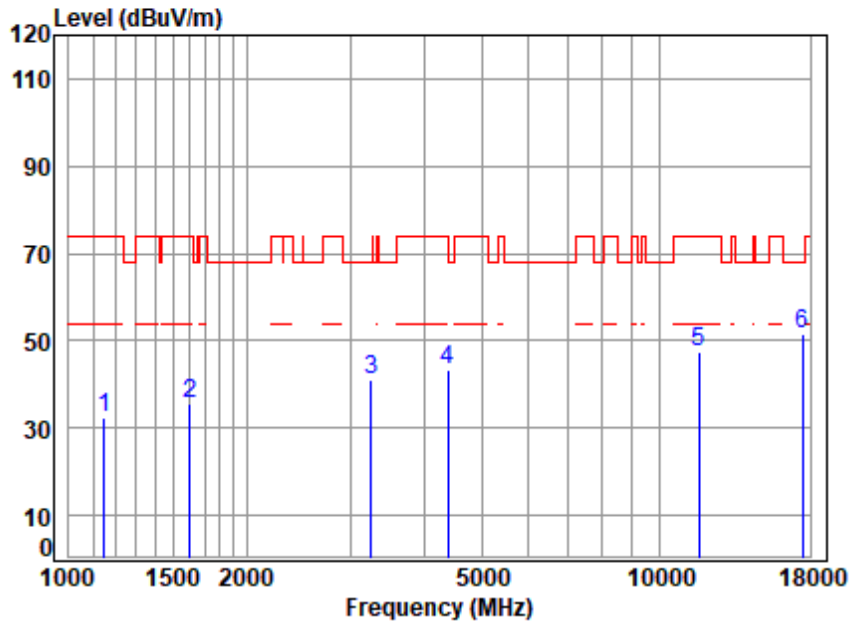

Site : chamber
 Condition: 3m VERTICAL
 Job No : 03018AT\03019AT
 Mode : 5825 TX RSE
 Note : 5G WIFI 11AX20

	Freq	Cable Loss	Ant Factor	Preamp Factor	Read Level	Limit Level	Over Limit	Remark
	MHz	dB	dB/m	dB	dBuV	dBuV/m	dBuV/m	dB
1	1148.823	3.61	23.90	61.53	66.48	74.00	-41.54	peak
2	1606.441	4.19	26.74	61.69	66.57	74.00	-38.19	peak
3	3252.005	6.31	32.06	61.35	64.12	68.20	-27.06	peak
4	4392.376	7.13	34.74	61.53	62.95	74.00	-30.71	peak
5	11650.000	11.95	37.80	62.65	60.13	74.00	-26.77	peak
6	p17475.000	14.86	43.40	61.41	54.61	68.20	-16.74	peak



Unless otherwise agreed in writing, this document is issued by the Company subject to its General Conditions of Service printed overleaf, available on request or accessible at <https://www.sgs.com/en/Terms-and-Conditions>. Attention is drawn to the limitation of liability, indemnification and jurisdiction issues defined therein. Any holder of this document is advised that information contained hereon reflects the Company's findings at the time of its intervention only and within the limits of Client's instructions, if any. The Company's sole responsibility is to its Client and this document does not exonerate parties to a transaction from exercising all their rights and obligations under the transaction documents. This document cannot be reproduced except in full, without prior written approval of the Company. Any unauthorized alteration, forgery or falsification of the content or appearance of this document is unlawful and offenders may be prosecuted to the fullest extent of the law. Unless otherwise stated the results shown in this test report refer only to the sample(s) tested and such sample(s) are retained for 30 days only.

Test Mode: 08; Polarity: Horizontal; Modulation:802.11 ax(Full RU0); Bandwidth:40MHz; Channel:Low

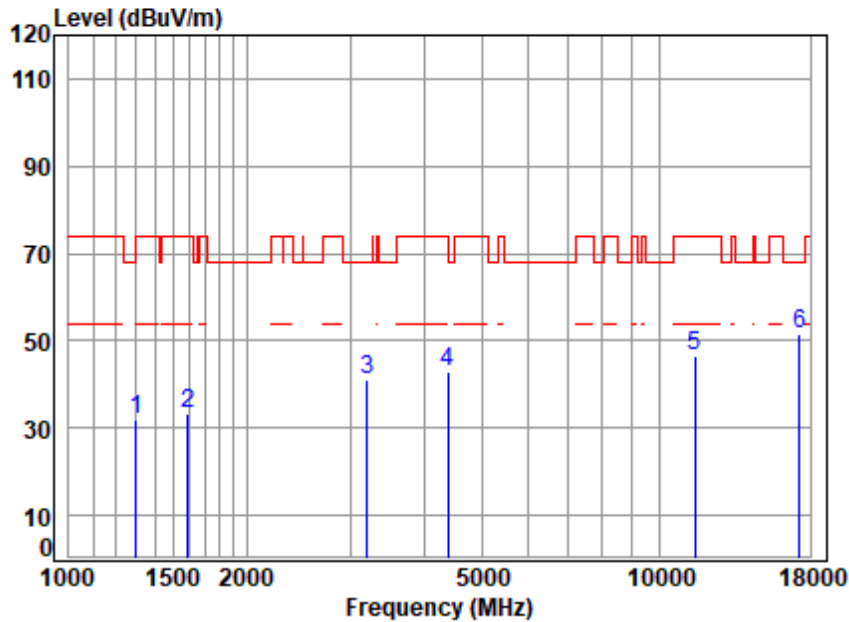

Site : chamber
 Condition: 3m HORIZONTAL
 Job No : 03018AT\03019AT
 Mode : 5755 TX RSE
 Note : 5G WIFI 11AX40

	Freq	Cable Loss	Ant Factor	Preamp Factor	Read Level	Level	Limit Line	Over Limit	Remark
	MHz	dB	dB/m	dB	dBuV	dBuV/m	dBuV/m	dB	
1	1300.858	3.81	24.79	61.59	65.08	32.09	74.00	-41.91	peak
2	1592.571	4.18	26.83	61.68	64.02	33.35	74.00	-40.65	peak
3	3196.094	6.25	32.87	61.36	63.42	41.18	68.20	-27.02	peak
4	4379.699	7.11	34.64	61.52	62.52	42.75	74.00	-31.25	peak
5	11510.000	11.95	37.79	62.62	59.24	46.36	74.00	-27.64	peak
6	p17265.000	14.62	43.06	61.62	55.69	51.75	68.20	-16.45	peak



Unless otherwise agreed in writing, this document is issued by the Company subject to its General Conditions of Service printed overleaf, available on request or accessible at <https://www.sgs.com/en/Terms-and-Conditions>. Attention is drawn to the limitation of liability, indemnification and jurisdiction issues defined therein. Any holder of this document is advised that information contained hereon reflects the Company's findings at the time of its intervention only and within the limits of Client's instructions, if any. The Company's sole responsibility is to its Client and this document does not exonerate parties to a transaction from exercising all their rights and obligations under the transaction documents. This document cannot be reproduced except in full, without prior written approval of the Company. Any unauthorized alteration, forgery or falsification of the content or appearance of this document is unlawful and offenders may be prosecuted to the fullest extent of the law. Unless otherwise stated the results shown in this test report refer only to the sample(s) tested and such sample(s) are retained for 30 days only.

Test Mode: 08; Polarity: Vertical; Modulation:802.11ax(Full RU0); Bandwidth:40MHz; Channel:Low

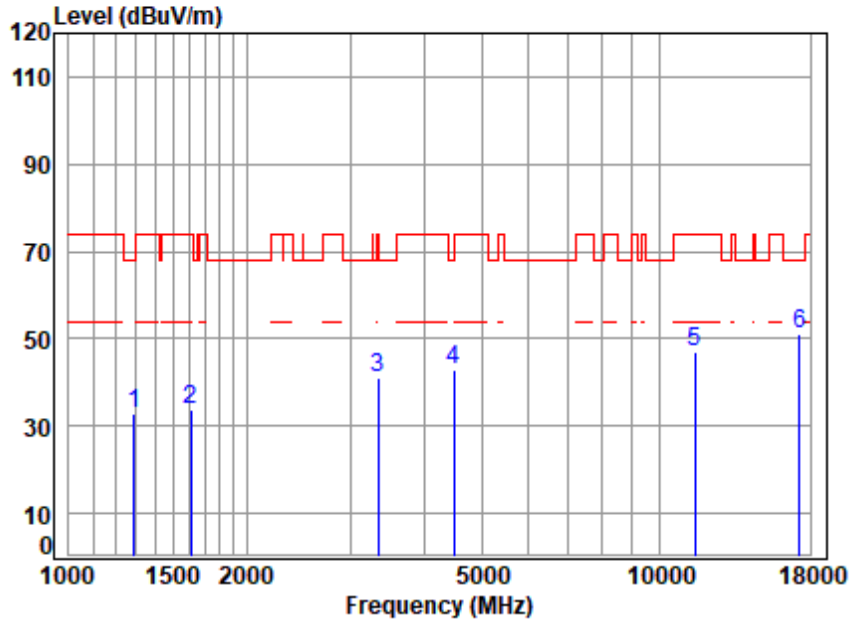

Site : chamber
 Condition: 3m VERTICAL
 Job No : 03018AT\03019AT
 Mode : 5755 TX RSE
 Note : 5G WIFI 11AX40

	Freq	Cable Loss	Ant Factor	Preamp Factor	Read Level	Level	Limit Line	Over Limit	Remark
	MHz	dB	dB/m	dB	dBuV	dBuV/m	dBuV/m	dB	
1	1289.627	3.80	24.86	61.59	65.56	32.63	68.20	-35.57	peak
2	1611.091	4.20	26.69	61.69	64.69	33.89	74.00	-40.11	peak
3	3347.371	6.39	32.05	61.32	64.10	41.22	74.00	-32.78	peak
4	4482.150	7.23	33.81	61.61	63.27	42.70	68.20	-25.50	peak
5	11510.000	11.95	37.79	62.62	59.87	46.99	74.00	-27.01	peak
6	p17265.000	14.62	43.06	61.62	55.10	51.16	68.20	-17.04	peak



Unless otherwise agreed in writing, this document is issued by the Company subject to its General Conditions of Service printed overleaf, available on request or accessible at <https://www.sgs.com/en/Terms-and-Conditions>. Attention is drawn to the limitation of liability, indemnification and jurisdiction issues defined therein. Any holder of this document is advised that information contained hereon reflects the Company's findings at the time of its intervention only and within the limits of Client's instructions, if any. The Company's sole responsibility is to its Client and this document does not exonerate parties to a transaction from exercising all their rights and obligations under the transaction documents. This document cannot be reproduced except in full, without prior written approval of the Company. Any unauthorized alteration, forgery or falsification of the content or appearance of this document is unlawful and offenders may be prosecuted to the fullest extent of the law. Unless otherwise stated the results shown in this test report refer only to the sample(s) tested and such sample(s) are retained for 30 days only.

Test Mode: 08; Polarity: Horizontal; Modulation:802.11ax(Full RU0); Bandwidth:40MHz; Channel:High

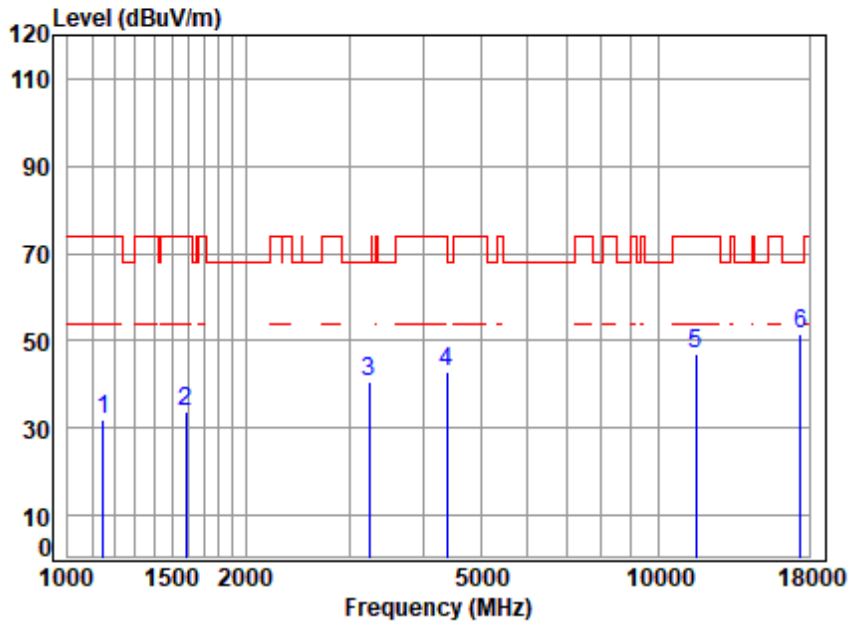

Site : chamber
 Condition: 3m HORIZONTAL
 Job No : 03018AT\03019AT
 Mode : 5795 TX RSE
 Note : 5G WIFI 11AX40

	Cable	Ant	Preamp	Read	Limit	Over		
Freq	Loss	Factor	Factor	Level	Level	Line	Limit	Remark
MHz	dB	dB/m	dB	dBuV	dBuV/m	dBuV/m	dB	
1	1148.823	3.61	23.90	61.53	66.08	32.06	74.00	-41.94 peak
2	1587.975	4.17	26.85	61.68	64.57	33.91	74.00	-40.09 peak
3	3242.619	6.30	32.22	61.35	63.35	40.52	68.20	-27.68 peak
4	4392.376	7.13	34.74	61.53	62.68	43.02	74.00	-30.98 peak
5	11590.000	11.95	37.71	62.64	59.91	46.93	74.00	-27.07 peak
6	p17385.000	14.76	43.35	61.50	54.96	51.57	68.20	-16.63 peak



Unless otherwise agreed in writing, this document is issued by the Company subject to its General Conditions of Service printed overleaf, available on request or accessible at <https://www.sgs.com/en/Terms-and-Conditions>. Attention is drawn to the limitation of liability, indemnification and jurisdiction issues defined therein. Any holder of this document is advised that information contained hereon reflects the Company's findings at the time of its intervention only and within the limits of Client's instructions, if any. The Company's sole responsibility is to its Client and this document does not exonerate parties to a transaction from exercising all their rights and obligations under the transaction documents. This document cannot be reproduced except in full, without prior written approval of the Company. Any unauthorized alteration, forgery or falsification of the content or appearance of this document is unlawful and offenders may be prosecuted to the fullest extent of the law. Unless otherwise stated the results shown in this test report refer only to the sample(s) tested and such sample(s) are retained for 30 days only.

Test Mode: 08; Polarity: Vertical; Modulation:802.11ax(Full RU0); Bandwidth:40MHz; Channel:High

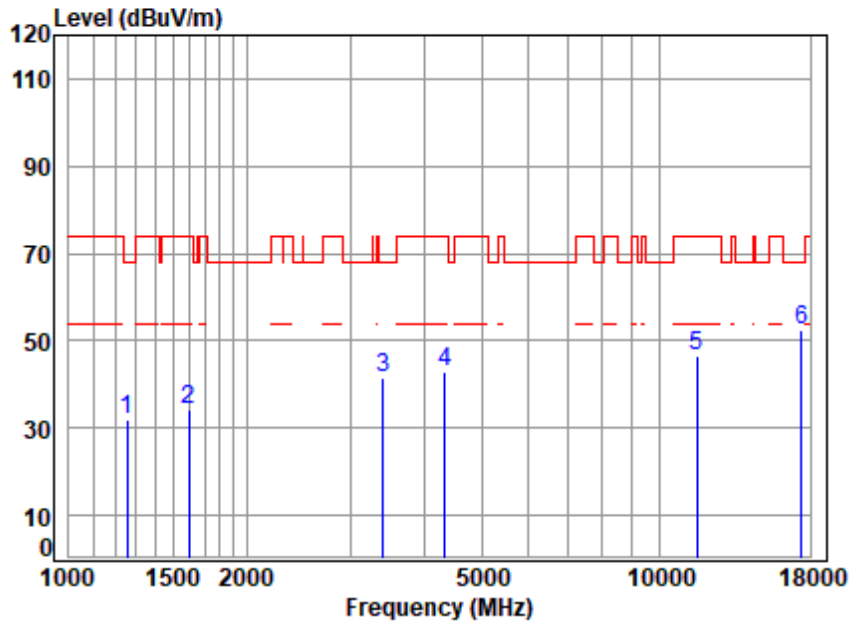

Site : chamber
 Condition: 3m VERTICAL
 Job No : 03018AT\03019AT
 Mode : 5795 TX RSE
 Note : 5G WIFI 11AX40

	Freq	Cable Loss	Ant Factor	Preamp Factor	Read Level	Level	Limit Line	Over Limit	Remark
	MHz	dB	dB/m	dB	dBuV	dBuV/m	dBuV/m	dB	
1	1256.512	3.76	25.06	61.58	64.86	32.10	68.20	-36.10	peak
2	1597.181	4.18	26.81	61.69	65.12	34.42	74.00	-39.58	peak
3	3405.929	6.44	32.33	61.31	63.88	41.34	68.20	-26.86	peak
4	4341.886	7.07	34.34	61.49	63.09	43.01	74.00	-30.99	peak
5	11590.000	11.95	37.71	62.64	59.63	46.65	74.00	-27.35	peak
6	p17385.000	14.76	43.35	61.50	55.66	52.27	68.20	-15.93	peak



Unless otherwise agreed in writing, this document is issued by the Company subject to its General Conditions of Service printed overleaf, available on request or accessible at <https://www.sgs.com/en/Terms-and-Conditions>. Attention is drawn to the limitation of liability, indemnification and jurisdiction issues defined therein. Any holder of this document is advised that information contained hereon reflects the Company's findings at the time of its intervention only and within the limits of Client's instructions, if any. The Company's sole responsibility is to its Client and this document does not exonerate parties to a transaction from exercising all their rights and obligations under the transaction documents. This document cannot be reproduced except in full, without prior written approval of the Company. Any unauthorized alteration, forgery or falsification of the content or appearance of this document is unlawful and offenders may be prosecuted to the fullest extent of the law. Unless otherwise stated the results shown in this test report refer only to the sample(s) tested and such sample(s) are retained for 30 days only.

Test Mode: 08; Polarity: Horizontal; Modulation:802.11ax(Full RU0); Bandwidth:80MHz; Channel:middle

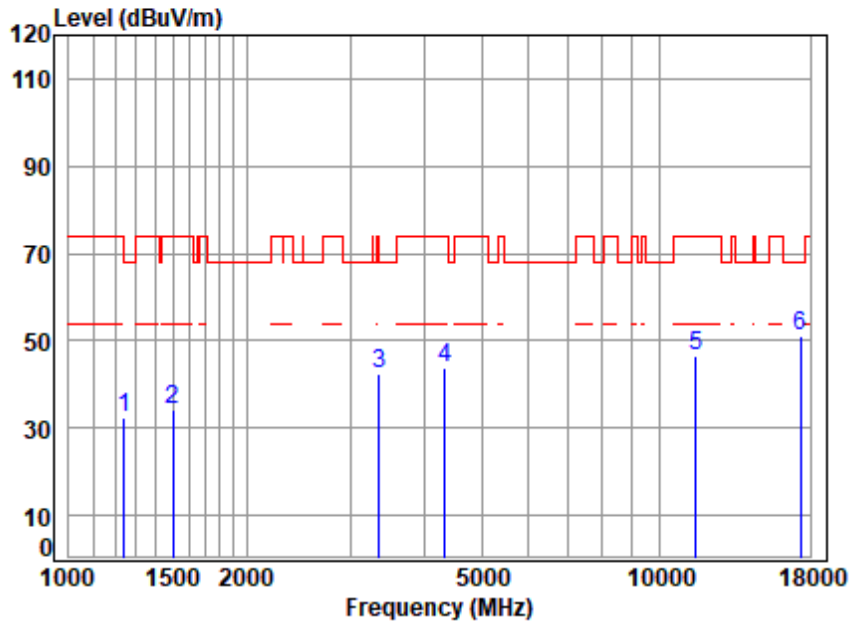

Site : chamber
 Condition: 3m HORIZONTAL
 Job No : 03018AT\03019AT
 Mode : 5775 TX RSE
 Note : 5G WIFI 11AX80

	Freq	Cable Loss	Ant Factor	Preamp Factor	Read Level	Level	Limit Line	Over Limit	Remark
	MHz	dB	dB/m	dB	dBuV	dBuV/m	dBuV/m	dB	
1	1242.068	3.74	24.99	61.57	65.05	32.21	68.20	-35.99	peak
2	1503.119	4.04	26.81	61.66	64.93	34.12	74.00	-39.88	peak
3	3357.061	6.40	32.14	61.32	65.04	42.26	74.00	-31.74	peak
4	4341.886	7.07	34.34	61.49	64.08	44.00	74.00	-30.00	peak
5	11550.000	11.95	37.75	62.63	59.63	46.70	74.00	-27.30	peak
6	p17325.000	14.69	43.17	61.56	54.88	51.18	68.20	-17.02	peak



Unless otherwise agreed in writing, this document is issued by the Company subject to its General Conditions of Service printed overleaf, available on request or accessible at <https://www.sgs.com/en/Terms-and-Conditions>. Attention is drawn to the limitation of liability, indemnification and jurisdiction issues defined therein. Any holder of this document is advised that information contained hereon reflects the Company's findings at the time of its intervention only and within the limits of Client's instructions, if any. The Company's sole responsibility is to its Client and this document does not exonerate parties to a transaction from exercising all their rights and obligations under the transaction documents. This document cannot be reproduced except in full, without prior written approval of the Company. Any unauthorized alteration, forgery or falsification of the content or appearance of this document is unlawful and offenders may be prosecuted to the fullest extent of the law. Unless otherwise stated the results shown in this test report refer only to the sample(s) tested and such sample(s) are retained for 30 days only.

Test Mode: 08; Polarity: Vertical; Modulation:802.11ax(Full RU0); Bandwidth:80MHz; Channel:middle

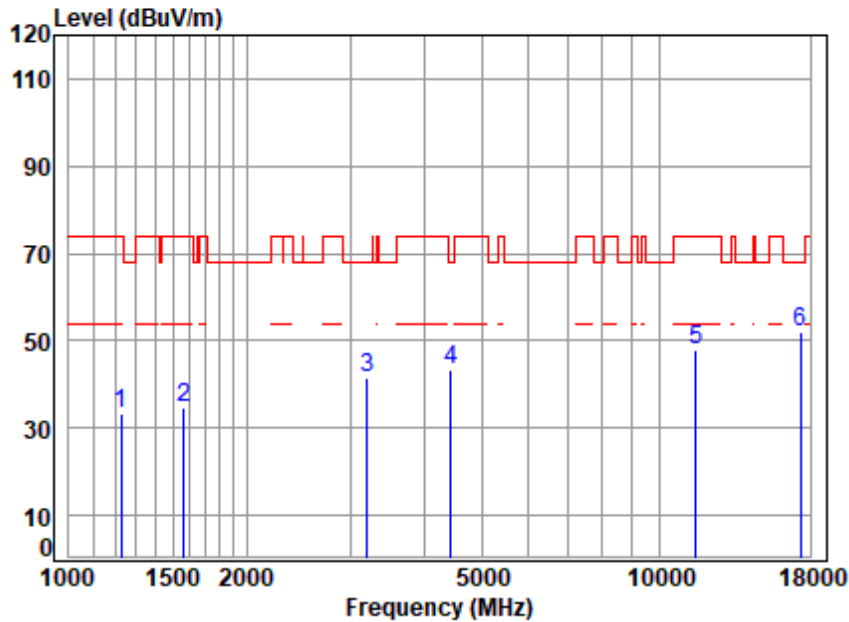

Site : chamber
 Condition: 3m VERTICAL
 Job No : 03018AT\03019AT
 Mode : 5775 TX RSE
 Note : 5G WIFI 11AX80

	Freq	Cable Loss	Ant Factor	Preamp Factor	Read Level	Limit Level	Over Limit	Remark
	MHz	dB	dB/m	dB	dBuV	dBuV/m	dBuV/m	dB
1	1227.791	3.72	24.79	61.56	66.46	33.41	74.00	-40.59 peak
2	1565.191	4.14	26.94	61.68	65.18	34.58	74.00	-39.42 peak
3	3196.094	6.25	32.87	61.36	63.65	41.41	68.20	-26.79 peak
4	4430.628	7.17	34.43	61.57	63.09	43.12	68.20	-25.08 peak
5	11550.000	11.95	37.75	62.63	60.62	47.69	74.00	-26.31 peak
6	p17325.000	14.69	43.17	61.56	55.64	51.94	68.20	-16.26 peak



Unless otherwise agreed in writing, this document is issued by the Company subject to its General Conditions of Service printed overleaf, available on request or accessible at <https://www.sgs.com/en/Terms-and-Conditions>. Attention is drawn to the limitation of liability, indemnification and jurisdiction issues defined therein. Any holder of this document is advised that information contained hereon reflects the Company's findings at the time of its intervention only and within the limits of Client's instructions, if any. The Company's sole responsibility is to its Client and this document does not exonerate parties to a transaction from exercising all their rights and obligations under the transaction documents. This document cannot be reproduced except in full, without prior written approval of the Company. Any unauthorized alteration, forgery or falsification of the content or appearance of this document is unlawful and offenders may be prosecuted to the fullest extent of the law. Unless otherwise stated the results shown in this test report refer only to the sample(s) tested and such sample(s) are retained for 30 days only.

7.5 Radiated Emissions which fall in the restricted bands

Test Requirement 47 CFR Part 15, Subpart C 15.209 & Subpart E 15.407(b)

Test Method: KDB 789033 D02 II G

Measurement Distance: 3m

Limit:

Frequency(MHz)	Field strength(microvolts/meter)	Measurement distance(meters)
0.009-0.490	2400/F(kHz)	300
0.490-1.705	24000/F(kHz)	30
1.705-30.0	30	30
30-88	100	3
88-216	150	3
216-960	200	3
Above 960	500	3

*(1) For transmitters operating in the 5.15-5.25 GHz band: All emissions outside of the 5.15-5.35 GHz band shall not exceed an e.i.r.p. of -27 dBm/MHz.

(2) For transmitters operating in the 5.25-5.35 GHz band: All emissions outside of the 5.15-5.35 GHz band shall not exceed an e.i.r.p. of -27 dBm/MHz.

(3) For transmitters operating in the 5.47-5.725 GHz band: All emissions outside of the 5.47-5.725 GHz band shall not exceed an e.i.r.p. of -27 dBm/MHz.

(4) For transmitters operating in the 5.725-5.85 GHz band:

(i) All emissions shall be limited to a level of -27 dBm/MHz at 75 MHz or more above or below the band edge increasing linearly to 10 dBm/MHz at 25 MHz above or below the band edge, and from 25 MHz above or below the band edge increasing linearly to a level of 15.6 dBm/MHz at 5 MHz above or below the band edge, and from 5 MHz above or below the band edge increasing linearly to a level of 27 dBm/MHz at the band edge.

Remark: The emission limits shown in the above table are based on measurements employing a CISPR quasi-peak detector except for the frequency bands 9-90kHz, 110-490kHz and above 1000 MHz. Radiated emission limits in these three bands are based on measurements employing an average detector, the peak field strength of any emission shall not exceed the maximum permitted average limits specified above by more than 20 dB under any condition of modulation.



Unless otherwise agreed in writing, this document is issued by the Company subject to its General Conditions of Service printed overleaf, available on request or accessible at <https://www.sgs.com/en/Terms-and-Conditions>. Attention is drawn to the limitation of liability, indemnification and jurisdiction issues defined therein. Any holder of this document is advised that information contained hereon reflects the Company's findings at the time of its intervention only and within the limits of Client's instructions, if any. The Company's sole responsibility is to its Client and this document does not exonerate parties to a transaction from exercising all their rights and obligations under the transaction documents. This document cannot be reproduced except in full, without prior written approval of the Company. Any unauthorized alteration, forgery or falsification of the content or appearance of this document is unlawful and offenders may be prosecuted to the fullest extent of the law. Unless otherwise stated the results shown in this test report refer only to the sample(s) tested and such sample(s) are retained for 30 days only.

Attention: To check the authenticity of testing /inspection report & certificate, please contact us at telephone: (86-755) 8307 1443, or email: CN.Doccheck@sgs.com

7.5.1 E.U.T. Operation

Operating Environment:

Temperature: 23.6 °C Humidity: 66.2 % RH Atmospheric Pressure: 1020 mbar

7.5.2 Test Mode Description

Pre-scan / Final test	Mode Code	Description
Final test	05	TX mode (U-NII-1)_Keep the EUT in continuously transmitting mode with all modulation types. All data rates for each modulation type have been tested and found the data rate @ 6Mbps is the worst case of IEEE 802.11a; data rate @ MCS0 is the worst case of IEEE 802.11n(HT20); data rate @ MCS0 is the worst case of IEEE 802.11n(HT40); data rate @ MCS0 is the worst case of IEEE 802.11ac(VHT20); data rate @ MCS0 is the worst case of IEEE 802.11ac(VHT40); data rate @ MCS0 is the worst case of IEEE 802.11ac(VHT80), data rate @ MCS0 is the worst case of IEEE 802.11ax(HEW20); data rate @ MCS0 is the worst case of IEEE 802.11ax(HEW40); data rate @ MCS0 is the worst case of IEEE 802.11ax(HEW80), final test modes are considering the modulation and worse data rates. Only the data of worst case is recorded in the report.
Final test	06	TX mode (U-NII-2A)_Keep the EUT in continuously transmitting mode with all modulation types. All data rates for each modulation type have been tested and found the data rate @ 6Mbps is the worst case of IEEE 802.11a; data rate @ MCS0 is the worst case of IEEE 802.11n(HT20); data rate @ MCS0 is the worst case of IEEE 802.11n(HT40); data rate @ MCS0 is the worst case of IEEE 802.11ac(VHT20); data rate @ MCS0 is the worst case of IEEE 802.11ac(VHT40); data rate @ MCS0 is the worst case of IEEE 802.11ac(VHT80), data rate @ MCS0 is the worst case of IEEE 802.11ax(HEW20); data rate @ MCS0 is the worst case of IEEE 802.11ax(HEW40); data rate @ MCS0 is the worst case of IEEE 802.11ax(HEW80), final test modes are considering the modulation and worse data rates. Only the data of worst case is recorded in the report.
Final test	07	TX mode (U-NII-2C)_Keep the EUT in continuously transmitting mode with all modulation types. All data rates for each modulation type have been tested and found the data rate @ 6Mbps is the worst case of IEEE 802.11a; data rate @ MCS0 is the worst case of IEEE 802.11n(HT20); data rate @ MCS0 is the worst case of IEEE 802.11n(HT40); data rate @ MCS0 is the worst case of IEEE 802.11ac(VHT20); data rate @ MCS0 is the worst case of IEEE 802.11ac(VHT40); data rate @ MCS0 is the worst case of IEEE 802.11ac(VHT80) , data rate @ MCS0 is the worst case of IEEE 802.11ax(HEW20); data rate @ MCS0 is the worst case of IEEE 802.11ax(HEW40); data rate @ MCS0 is the worst case of IEEE 802.11ax(HEW80). Only the data of worst case is recorded in the report.



Unless otherwise agreed in writing, this document is issued by the Company subject to its General Conditions of Service printed overleaf, available on request or accessible at <https://www.sgs.com/en/Terms-and-Conditions>. Attention is drawn to the limitation of liability, indemnification and jurisdiction issues defined therein. Any holder of this document is advised that information contained hereon reflects the Company's findings at the time of its intervention only and within the limits of Client's instructions, if any. The Company's sole responsibility is to its Client and this document does not exonerate parties to a transaction from exercising all their rights and obligations under the transaction documents. This document cannot be reproduced except in full, without prior written approval of the Company. Any unauthorized alteration, forgery or falsification of the content or appearance of this document is unlawful and offenders may be prosecuted to the fullest extent of the law. Unless otherwise stated the results shown in this test report refer only to the sample(s) tested and such sample(s) are retained for 30 days only.

Attention: To check the authenticity of testing /inspection report & certificate, please contact us at telephone: (86-755) 8307 1443, or email: CN.Doccheck@sgs.com
 No.1 Workshop, M-10, Middle Section, Science & Technology Park, Nanshan District, Shenzhen, Guangdong, China 518057 t (86-755) 26012053 f (86-755) 26710594 www.sgs.com.cn
 中国·广东·深圳市南山区科技园中区M-10栋1号厂房 邮编: 518057 t (86-755) 26012053 f (86-755) 26710594 sgs.china@sgs.com

Final test	08	<p>TX mode (U-NII-3)_Keep the EUT in continuously transmitting mode with all modulation types. All data rates for each modulation type have been tested and found the data rate @ 6Mbps is the worst case of IEEE 802.11a; data rate @ MCS0 is the worst case of IEEE 802.11n(HT20); data rate @ MCS0 is the worst case of IEEE 802.11n(HT40); data rate @ MCS0 is the worst case of IEEE 802.11ac(VHT20); data rate @ MCS0 is the worst case of IEEE 802.11ac(VHT40); data rate @ MCS0 is the worst case of IEEE 802.11ac(VHT80); data rate @ MCS0 is the worst case of IEEE 802.11ax(HEW20); data rate @ MCS0 is the worst case of IEEE 802.11ax(HEW40); data rate @ MCS0 is the worst case of IEEE 802.11ax(HEW80), final test modes are considering the modulation and worse data rates. Only the data of worst case is recorded in the report.</p>
------------	----	---------------------------------------------------------------------------------------------------------------------------------------------------------------------------------------------------------------------------------------------------------------------------------------------------------------------------------------------------------------------------------------------------------------------------------------------------------------------------------------------------------------------------------------------------------------------------------------------------------------------------------------------------------------------------------------------------------------------------------------------------------------------------------------------------------------------------------------------------------

7.5.3 Test Setup Diagram

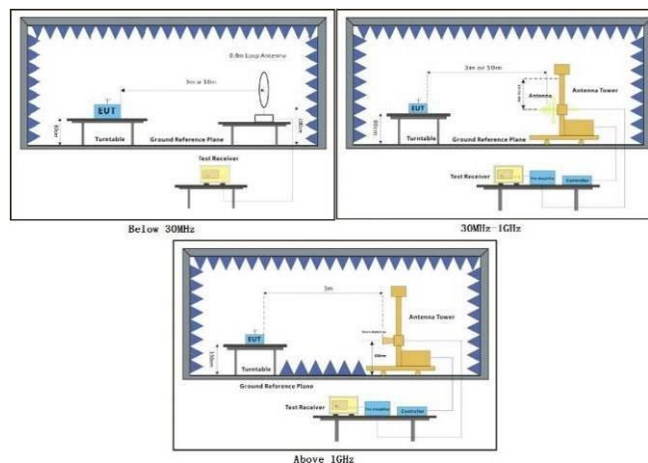

Unless otherwise agreed in writing, this document is issued by the Company subject to its General Conditions of Service printed overleaf, available on request or accessible at <https://www.sgs.com/en/Terms-and-Conditions>. Attention is drawn to the limitation of liability, indemnification and jurisdiction issues defined therein. Any holder of this document is advised that information contained hereon reflects the Company's findings at the time of its intervention only and within the limits of Client's instructions, if any. The Company's sole responsibility is to its Client and this document does not exonerate parties to a transaction from exercising all their rights and obligations under the transaction documents. This document cannot be reproduced except in full, without prior written approval of the Company. Any unauthorized alteration, forgery or falsification of the content or appearance of this document is unlawful and offenders may be prosecuted to the fullest extent of the law. Unless otherwise stated the results shown in this test report refer only to the sample(s) tested and such sample(s) are retained for 30 days only.

Attention: To check the authenticity of testing /inspection report & certificate, please contact us at telephone: (86-755) 8307 1443, or email: CN.Doccheck@sgs.com

7.5.4 Measurement Procedure and Data

- a. For below 1GHz, the EUT was placed on the top of a rotating table 0.8 meters above the ground at a 3 or 10 meter semi-anechoic chamber. The table was rotated 360 degrees to determine the position of the highest radiation.
 - b. For above 1GHz, the EUT was placed on the top of a rotating table 1.5 meters above the ground at a 3 meter fully-anechoic chamber. The table was rotated 360 degrees to determine the position of the highest radiation.
 - c. The EUT was set 3 or 10 meters away from the interference-receiving antenna, which was mounted on the top of a variable-height antenna tower.
 - d. The antenna height is varied from one meter to four meters above the ground to determine the maximum value of the field strength. Both horizontal and vertical polarizations of the antenna are set to make the measurement.
 - e. For each suspected emission, the EUT was arranged to its worst case and then the antenna was tuned to heights from 1 meter to 4 meters (for the test frequency of below 30MHz, the antenna was tuned to heights 1 meter) and the rotatable table was turned from 0 degrees to 360 degrees to find the maximum reading.
 - f. The test-receiver system was set to Peak Detect Function and Specified Bandwidth with Maximum Hold Mode.
 - g. If the emission level of the EUT in peak mode was 10dB lower than the limit specified, then testing could be stopped and the peak values of the EUT would be reported. Otherwise the emissions that did not have 10dB margin would be re-tested one by one using peak, quasi-peak or average method as specified and then reported in a data sheet.
 - h. Test the EUT in the lowest channel, the middle channel, the Highest channel.
 - i. The radiation measurements are performed in X, Y, Z axis positioning for Transmitting mode, and found the X axis positioning which it is the worst case.
 - j. Repeat above procedures until all frequencies measured was complete.
- Remark: Level= Read Level+ Cable Loss+ Antenna Factor- Preamp Factor



Unless otherwise agreed in writing, this document is issued by the Company subject to its General Conditions of Service printed overleaf, available on request or accessible at <https://www.sgs.com/en/Terms-and-Conditions>. Attention is drawn to the limitation of liability, indemnification and jurisdiction issues defined therein. Any holder of this document is advised that information contained hereon reflects the Company's findings at the time of its intervention only and within the limits of Client's instructions, if any. The Company's sole responsibility is to its Client and this document does not exonerate parties to a transaction from exercising all their rights and obligations under the transaction documents. This document cannot be reproduced except in full, without prior written approval of the Company. Any unauthorized alteration, forgery or falsification of the content or appearance of this document is unlawful and offenders may be prosecuted to the fullest extent of the law. Unless otherwise stated the results shown in this test report refer only to the sample(s) tested and such sample(s) are retained for 30 days only.

Attention: To check the authenticity of testing /inspection report & certificate, please contact us at telephone: (86-755) 8307 1443, or email: CN.Doccheck@sgs.com

Test Mode: 05; Polarity: Horizontal; Modulation:802.11a; Bandwidth:20MHz; Channel:Low

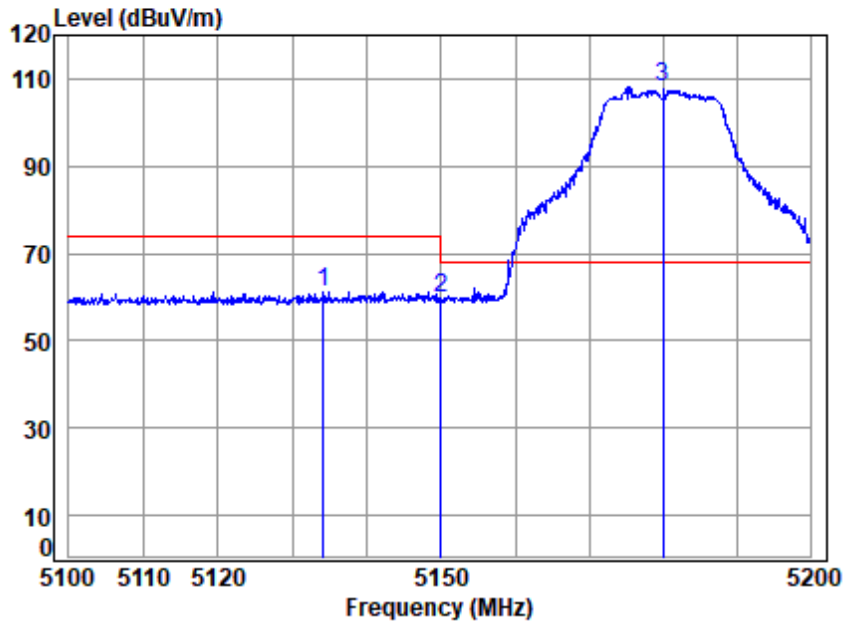

Site : chamber
 Condition: 3m HORIZONTAL
 Job No : 03018AT\03019AT
 Mode : 5180 Band edge
 : 5G WIFI 11A

		Cable	Ant	Preamp	Read	Limit	Over	
Freq	Loss	Factor	Factor	Factor	Level	Level	Line	Limit Remark
MHz	dB	dB/m	dB	dB	dBuV	dBuV/m	dBuV/m	dB
1	5134.181	18.81	33.93	35.32	43.87	61.29	74.00	-12.71 peak
2	5149.980	18.83	33.90	35.31	42.26	59.68	74.00	-14.32 peak
3 p	5180.000	18.88	33.96	35.29	90.60	108.15	68.20	39.95 peak



Unless otherwise agreed in writing, this document is issued by the Company subject to its General Conditions of Service printed overleaf, available on request or accessible at <https://www.sgs.com/en/Terms-and-Conditions>. Attention is drawn to the limitation of liability, indemnification and jurisdiction issues defined therein. Any holder of this document is advised that information contained hereon reflects the Company's findings at the time of its intervention only and within the limits of Client's instructions, if any. The Company's sole responsibility is to its Client and this document does not exonerate parties to a transaction from exercising all their rights and obligations under the transaction documents. This document cannot be reproduced except in full, without prior written approval of the Company. Any unauthorized alteration, forgery or falsification of the content or appearance of this document is unlawful and offenders may be prosecuted to the fullest extent of the law. Unless otherwise stated the results shown in this test report refer only to the sample(s) tested and such sample(s) are retained for 30 days only.

Test Mode: 05; Polarity: Horizontal; Modulation:802.11a; Bandwidth:20MHz; Channel:Low

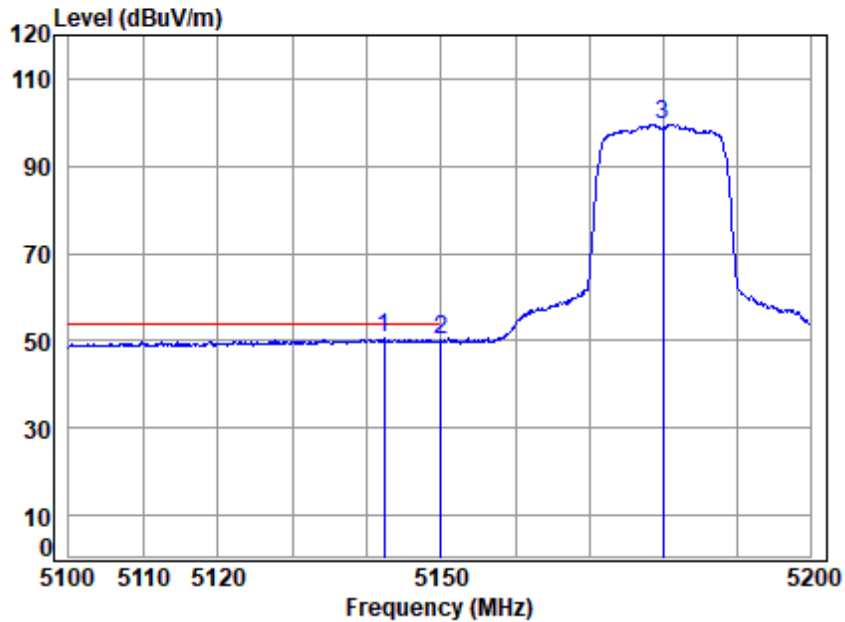

Site : chamber
 Condition: 3m HORIZONTAL
 Job No : 03018AT\03019AT
 Mode : 5180 Band edge
 : 5G WIFI 11A

		Cable	Ant	Preamp	Read	Limit	Over	
Freq	Loss	Factor	Factor	Factor	Level	Level	Line	Limit Remark
MHz	dB	dB/m	dB	dB	dBuV	dBuV/m	dBuV/m	dB
1 q 5142.363	18.82	33.92	35.31	33.04	50.47	54.00	-3.53	Average
2 5149.980	18.83	33.90	35.31	32.61	50.03	54.00	-3.97	Average
3 5180.000	18.88	33.96	35.29	82.05	99.60	-----	-----	Average



Unless otherwise agreed in writing, this document is issued by the Company subject to its General Conditions of Service printed overleaf, available on request or accessible at <https://www.sgs.com/en/Terms-and-Conditions>. Attention is drawn to the limitation of liability, indemnification and jurisdiction issues defined therein. Any holder of this document is advised that information contained hereon reflects the Company's findings at the time of its intervention only and within the limits of Client's instructions, if any. The Company's sole responsibility is to its Client and this document does not exonerate parties to a transaction from exercising all their rights and obligations under the transaction documents. This document cannot be reproduced except in full, without prior written approval of the Company. Any unauthorized alteration, forgery or falsification of the content or appearance of this document is unlawful and offenders may be prosecuted to the fullest extent of the law. Unless otherwise stated the results shown in this test report refer only to the sample(s) tested and such sample(s) are retained for 30 days only.

Test Mode: 05; Polarity: Vertical; Modulation:802.11a; Bandwidth:20MHz; Channel:Low

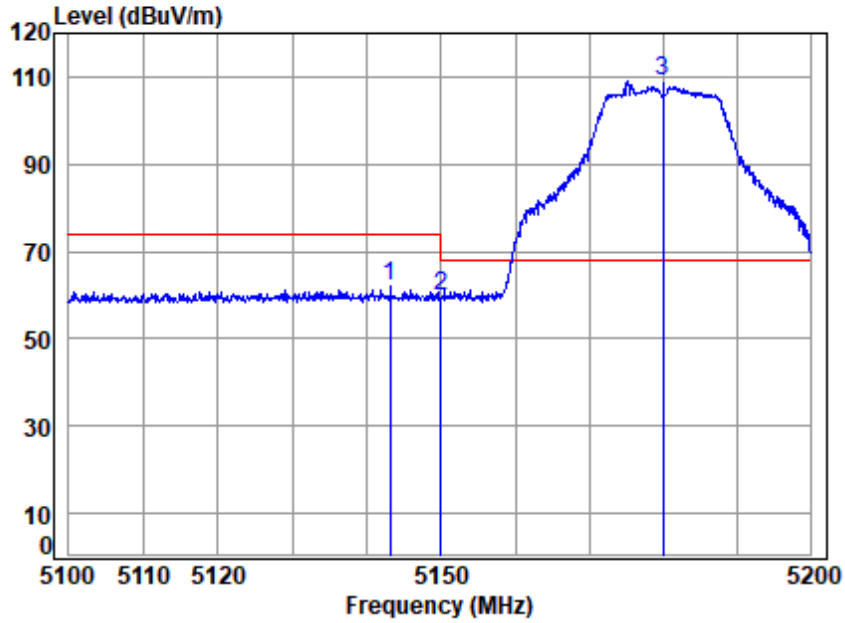

Site : chamber
 Condition: 3m VERTICAL
 Job No : 03018AT\03019AT
 Mode : 5180 Band edge
 : 5G WIFI 11A

	Cable	Ant	Preamp	Read	Limit	Over		
Freq	Loss	Factor	Factor	Level	Level	Line	Limit	Remark
MHz	dB	dB/m	dB	dBuV	dBuV/m	dBuV/m	dB	
1	5143.162	18.82	33.91	35.31	44.47	61.89	74.00	-12.11 Peak
2	5149.980	18.83	33.90	35.31	42.41	59.83	74.00	-14.17 Peak
3 p	5180.000	18.88	33.96	35.29	91.42	108.97	68.20	40.77 Peak



Unless otherwise agreed in writing, this document is issued by the Company subject to its General Conditions of Service printed overleaf, available on request or accessible at <https://www.sgs.com/en/Terms-and-Conditions>. Attention is drawn to the limitation of liability, indemnification and jurisdiction issues defined therein. Any holder of this document is advised that information contained hereon reflects the Company's findings at the time of its intervention only and within the limits of Client's instructions, if any. The Company's sole responsibility is to its Client and this document does not exonerate parties to a transaction from exercising all their rights and obligations under the transaction documents. This document cannot be reproduced except in full, without prior written approval of the Company. Any unauthorized alteration, forgery or falsification of the content or appearance of this document is unlawful and offenders may be prosecuted to the fullest extent of the law. Unless otherwise stated the results shown in this test report refer only to the sample(s) tested and such sample(s) are retained for 30 days only.

Test Mode: 05; Polarity: Vertical; Modulation:802.11a; Bandwidth:20MHz; Channel:Low

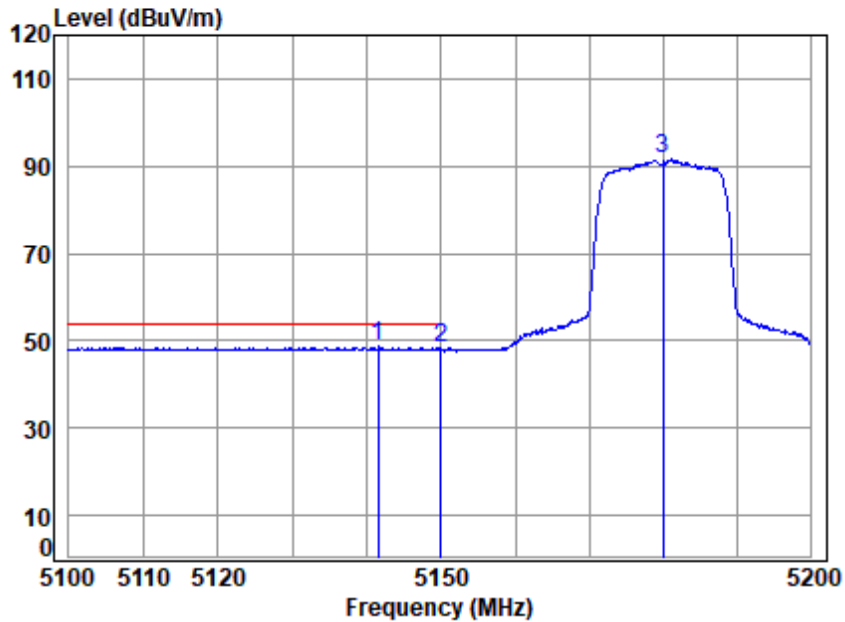

Site : chamber
 Condition: 3m VERTICAL
 Job No : 03018AT\03019AT
 Mode : 5180 Band edge
 : 5G WIFI 11A

		Cable	Ant	Preamp	Read	Limit	Over		
	Freq	Loss	Factor	Factor	Level	Level	Line	Limit	Remark
	MHz	dB	dB/m	dB	dBuV	dBuV/m	dBuV/m	dB	
1	q 5141.564	18.82	33.92	35.31	31.19	48.62	54.00	-5.38	Average
2	5149.980	18.83	33.90	35.31	30.84	48.26	54.00	-5.74	Average
3	5180.000	18.88	33.96	35.29	73.98	91.53	-----	-----	Average



Unless otherwise agreed in writing, this document is issued by the Company subject to its General Conditions of Service printed overleaf, available on request or accessible at <https://www.sgs.com/en/Terms-and-Conditions>. Attention is drawn to the limitation of liability, indemnification and jurisdiction issues defined therein. Any holder of this document is advised that information contained hereon reflects the Company's findings at the time of its intervention only and within the limits of Client's instructions, if any. The Company's sole responsibility is to its Client and this document does not exonerate parties to a transaction from exercising all their rights and obligations under the transaction documents. This document cannot be reproduced except in full, without prior written approval of the Company. Any unauthorized alteration, forgery or falsification of the content or appearance of this document is unlawful and offenders may be prosecuted to the fullest extent of the law. Unless otherwise stated the results shown in this test report refer only to the sample(s) tested and such sample(s) are retained for 30 days only.

Test Mode: 05; Polarity: Horizontal; Modulation:802.11a; Bandwidth:20MHz; Channel:High

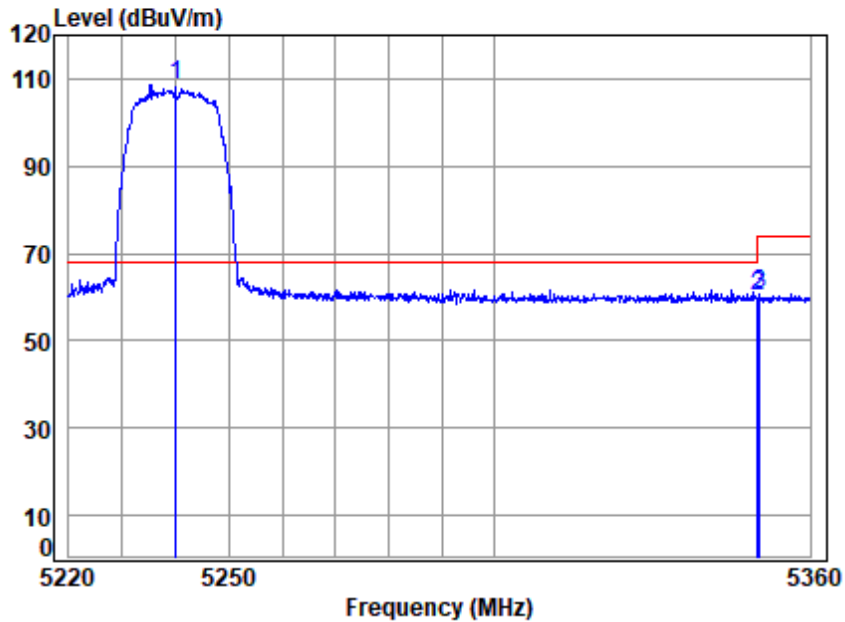

Site : chamber
 Condition: 3m HORIZONTAL
 Job No : 03018AT\03019AT
 Mode : 5240 Band edge
 : 5G WIFI 11A

	Freq	Cable Loss	Ant Factor	Preamp Factor	Read Level	Limit Level	Over Limit	Remark
	MHz	dB	dB/m	dB	dBuV	dBuV/m	dBuV/m	dB
1 p	5240.000	18.96	34.08	35.26	90.86	108.64	68.20	40.44 peak
2	5350.020	19.11	34.40	35.21	42.11	60.41	74.00	-13.59 peak
3	5350.362	19.11	34.40	35.21	42.43	60.73	74.00	-13.27 peak



Test Mode: 05; Polarity: Horizontal; Modulation:802.11a; Bandwidth:20MHz; Channel:High

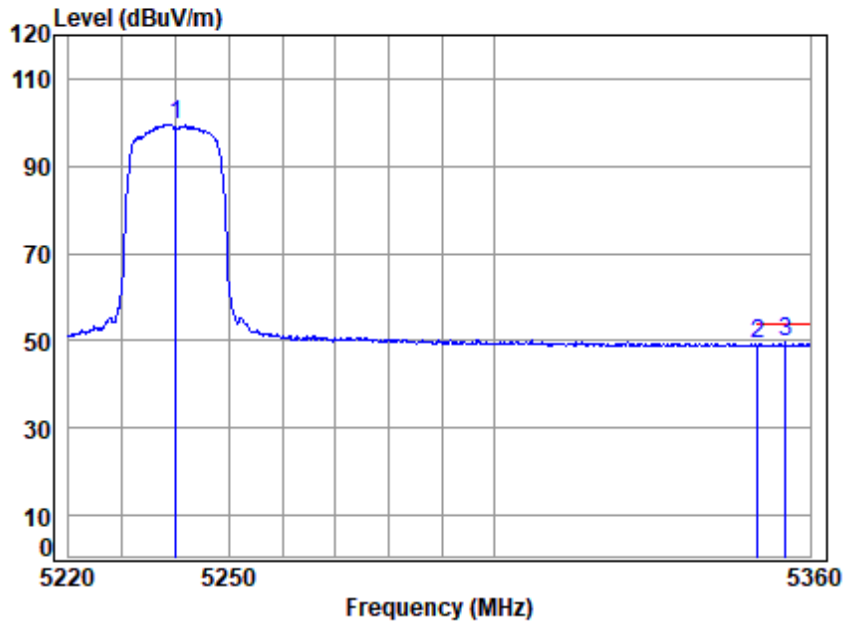

Site : chamber
 Condition: 3m HORIZONTAL
 Job No : 03018AT\03019AT
 Mode : 5240 Band edge
 : 5G WIFI 11A

	Freq	Cable Loss	Ant Factor	Preamp Factor	Read Level	Limit Level	Limit Line	Over Limit	Remark
	MHz	dB	dB/m	dB	dBuV	dBuV/m	dBuV/m	dB	
1	5240.000	18.96	34.08	35.26	81.85	99.63	-----	-----	Average
2	5350.020	19.11	34.40	35.21	30.86	49.16	54.00	-4.84	Average
3 q	5355.321	19.12	34.42	35.21	31.40	49.73	54.00	-4.27	Average



Unless otherwise agreed in writing, this document is issued by the Company subject to its General Conditions of Service printed overleaf, available on request or accessible at <https://www.sgs.com/en/Terms-and-Conditions>. Attention is drawn to the limitation of liability, indemnification and jurisdiction issues defined therein. Any holder of this document is advised that information contained hereon reflects the Company's findings at the time of its intervention only and within the limits of Client's instructions, if any. The Company's sole responsibility is to its Client and this document does not exonerate parties to a transaction from exercising all their rights and obligations under the transaction documents. This document cannot be reproduced except in full, without prior written approval of the Company. Any unauthorized alteration, forgery or falsification of the content or appearance of this document is unlawful and offenders may be prosecuted to the fullest extent of the law. Unless otherwise stated the results shown in this test report refer only to the sample(s) tested and such sample(s) are retained for 30 days only.

Test Mode: 05; Polarity: Vertical; Modulation:802.11a; Bandwidth:20MHz; Channel:High

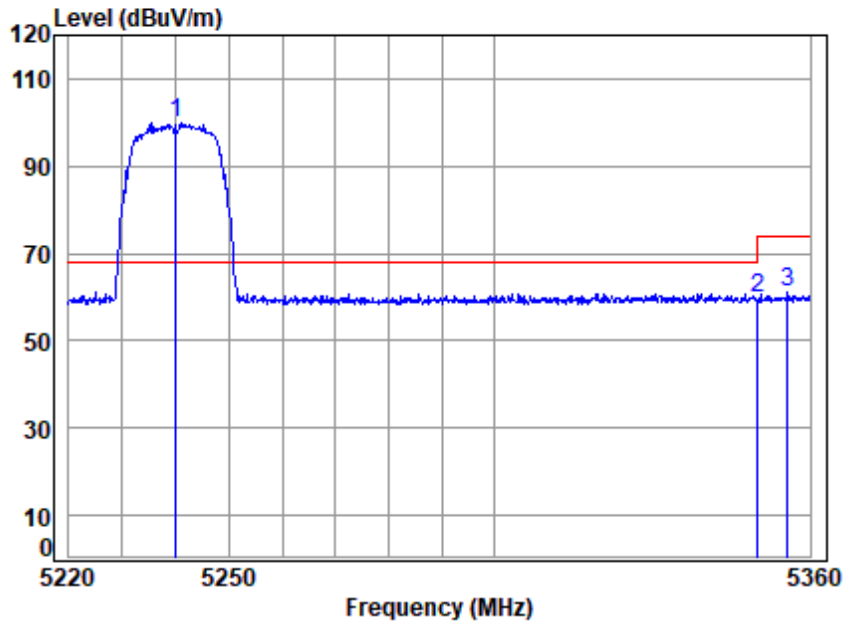

Site : chamber
 Condition: 3m VERTICAL
 Job No : 03018AT\03019AT
 Mode : 5240 Band edge
 : 5G WIFI 11A

		Cable	Ant	Preamp	Read	Limit	Over	
	Freq	Loss	Factor	Factor	Level	Level	Line	Limit Remark
	MHz	dB	dB/m	dB	dBuV	dBuV/m	dBuV/m	dB
1 p	5240.000	18.96	34.08	35.26	82.03	99.81	68.20	31.61 Peak
2	5350.020	19.11	34.40	35.21	41.39	59.69	74.00	-14.31 Peak
3	5355.746	19.12	34.42	35.21	42.60	60.93	74.00	-13.07 Peak



Test Mode: 05; Polarity: Vertical; Modulation:802.11a; Bandwidth:20MHz; Channel:High

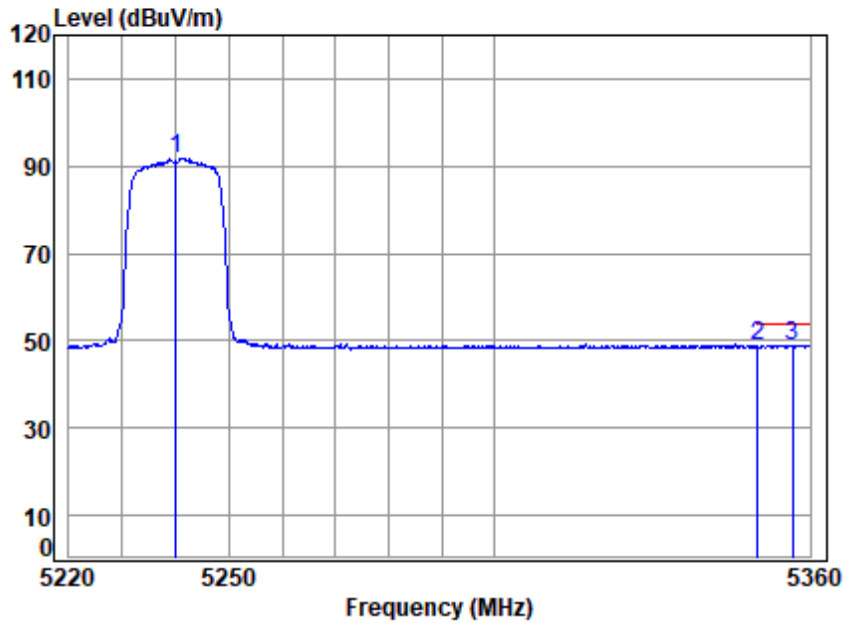

Site : chamber
 Condition: 3m VERTICAL
 Job No : 03018AT\03019AT
 Mode : 5240 Band edge
 : 5G WIFI 11A

	Freq	Cable Loss	Ant Factor	Preamp Factor	Read Level	Level	Limit Line	Over Limit	Remark
	MHz	dB	dB/m	dB	dBuV	dBuV/m	dBuV/m	dB	
1	5240.000	18.96	34.08	35.26	73.97	91.75	-----	-----	Average
2	5350.020	19.11	34.40	35.21	30.44	48.74	54.00	-5.26	Average
3 q	5356.596	19.12	34.43	35.20	30.56	48.91	54.00	-5.09	Average



Unless otherwise agreed in writing, this document is issued by the Company subject to its General Conditions of Service printed overleaf, available on request or accessible at <https://www.sgs.com/en/Terms-and-Conditions>. Attention is drawn to the limitation of liability, indemnification and jurisdiction issues defined therein. Any holder of this document is advised that information contained hereon reflects the Company's findings at the time of its intervention only and within the limits of Client's instructions, if any. The Company's sole responsibility is to its Client and this document does not exonerate parties to a transaction from exercising all their rights and obligations under the transaction documents. This document cannot be reproduced except in full, without prior written approval of the Company. Any unauthorized alteration, forgery or falsification of the content or appearance of this document is unlawful and offenders may be prosecuted to the fullest extent of the law. Unless otherwise stated the results shown in this test report refer only to the sample(s) tested and such sample(s) are retained for 30 days only.

Test Mode: 05; Polarity: Horizontal; Modulation:802.11ac; Bandwidth:20MHz; Channel:Low

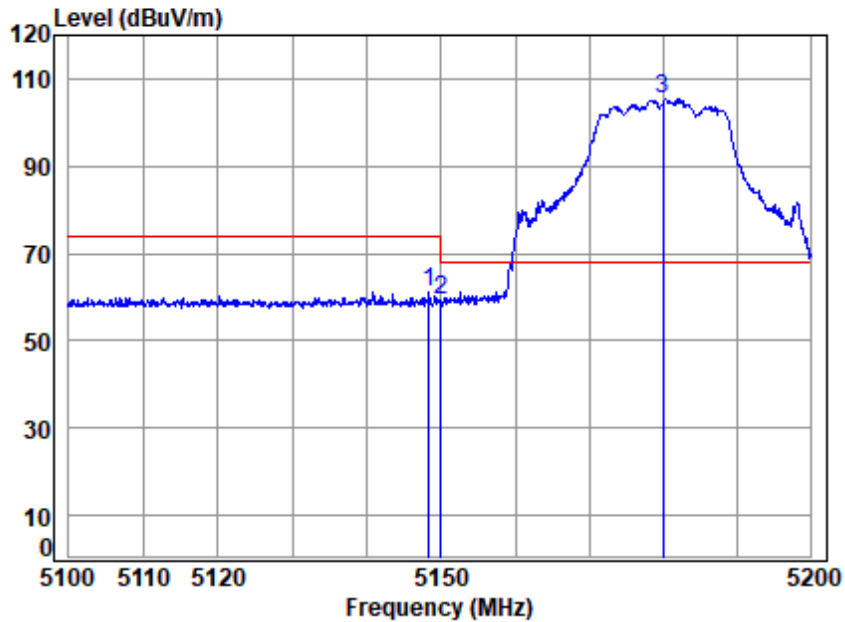

Site : chamber
 Condition: 3m HORIZONTAL
 Job No : 03018AT\03019AT
 Mode : 5180 Band edge
 : 5G WIFI 11AC20

		Cable	Ant	Preamp	Read	Limit	Over	
Freq	Loss	Factor	Factor	Factor	Level	Level	Line	Limit Remark
MHz	dB	dB/m	dB	dB	dBuV	dBuV/m	dBuV/m	dB
1	5148.357	18.83	33.90	31.28	39.59	61.04	74.00	-12.96 peak
2	5149.980	18.83	33.90	31.28	37.93	59.38	74.00	-14.62 peak
3 p	5180.000	18.88	33.96	31.30	83.79	105.33	68.20	37.13 peak



Unless otherwise agreed in writing, this document is issued by the Company subject to its General Conditions of Service printed overleaf, available on request or accessible at <https://www.sgs.com/en/Terms-and-Conditions>. Attention is drawn to the limitation of liability, indemnification and jurisdiction issues defined therein. Any holder of this document is advised that information contained hereon reflects the Company's findings at the time of its intervention only and within the limits of Client's instructions, if any. The Company's sole responsibility is to its Client and this document does not exonerate parties to a transaction from exercising all their rights and obligations under the transaction documents. This document cannot be reproduced except in full, without prior written approval of the Company. Any unauthorized alteration, forgery or falsification of the content or appearance of this document is unlawful and offenders may be prosecuted to the fullest extent of the law. Unless otherwise stated the results shown in this test report refer only to the sample(s) tested and such sample(s) are retained for 30 days only.

Test Mode: 05; Polarity: Horizontal; Modulation:802.11ac; Bandwidth:20MHz; Channel:Low

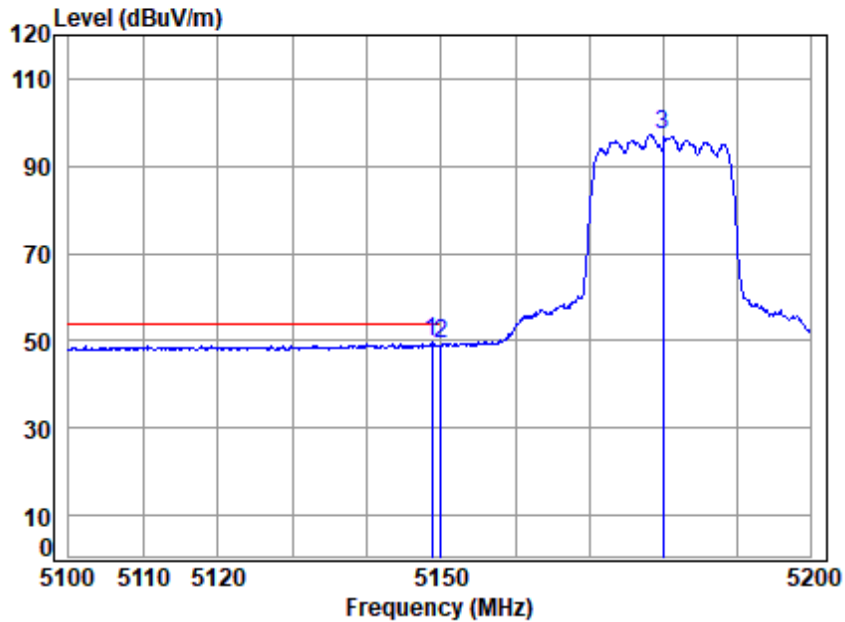

Site : chamber
 Condition: 3m HORIZONTAL
 Job No : 03018AT\03019AT
 Mode : 5180 Band edge
 : 5G WIFI 11AC20

		Cable	Ant	Preamp	Read	Limit	Over		
	Freq	Loss	Factor	Factor	Level	Level	Line	Limit	Remark
	MHz	dB	dB/m	dB	dBuV	dBuV/m	dBuV/m	dB	
1	q 5148.757	18.83	33.90	31.28	28.27	49.72	54.00	-4.28	Average
2	5149.980	18.83	33.90	31.28	27.80	49.25	54.00	-4.75	Average
3	5180.000	18.88	33.96	31.30	75.85	97.39	-----	-----	Average



Unless otherwise agreed in writing, this document is issued by the Company subject to its General Conditions of Service printed overleaf, available on request or accessible at <https://www.sgs.com/en/Terms-and-Conditions>. Attention is drawn to the limitation of liability, indemnification and jurisdiction issues defined therein. Any holder of this document is advised that information contained hereon reflects the Company's findings at the time of its intervention only and within the limits of Client's instructions, if any. The Company's sole responsibility is to its Client and this document does not exonerate parties to a transaction from exercising all their rights and obligations under the transaction documents. This document cannot be reproduced except in full, without prior written approval of the Company. Any unauthorized alteration, forgery or falsification of the content or appearance of this document is unlawful and offenders may be prosecuted to the fullest extent of the law. Unless otherwise stated the results shown in this test report refer only to the sample(s) tested and such sample(s) are retained for 30 days only.

Test Mode: 05; Polarity: Vertical; Modulation:802.11ac; Bandwidth:20MHz; Channel:Low

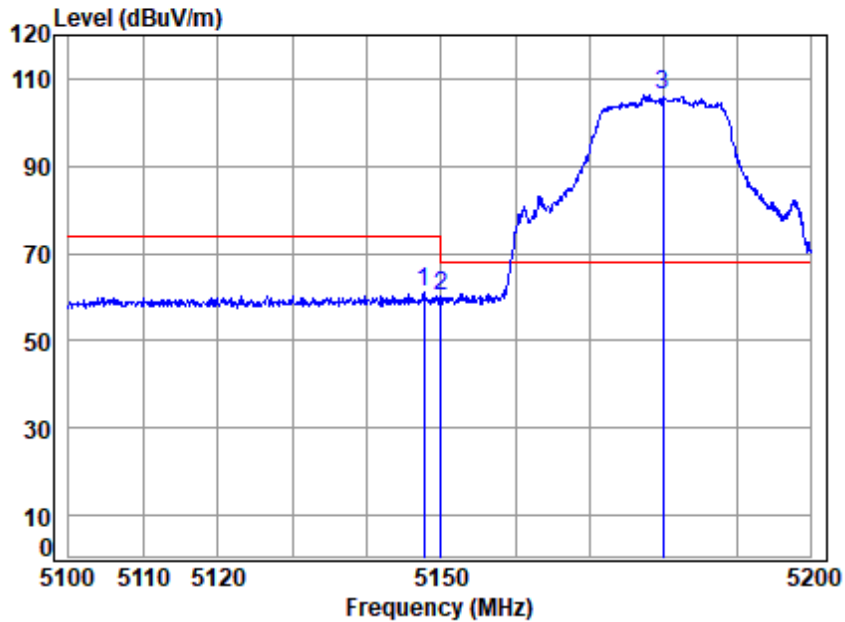

Site : chamber
 Condition: 3m VERTICAL
 Job No : 03018AT\03019AT
 Mode : 5180 Band edge
 : 5G WIFI 11AC20

	Freq	Cable Loss	Ant Factor	Preamp Factor	Read Level	Limit Level	Over Limit	Remark
	MHz	dB	dB/m	dB	dBuV	dBuV/m	dBuV/m	dB
1	5147.658	18.83	33.90	31.28	39.87	61.32	74.00	-12.68 Peak
2	5149.980	18.83	33.90	31.28	38.57	60.02	74.00	-13.98 Peak
3 p	5180.000	18.88	33.96	31.30	84.86	106.40	68.20	38.20 Peak



Unless otherwise agreed in writing, this document is issued by the Company subject to its General Conditions of Service printed overleaf, available on request or accessible at <https://www.sgs.com/en/Terms-and-Conditions>. Attention is drawn to the limitation of liability, indemnification and jurisdiction issues defined therein. Any holder of this document is advised that information contained hereon reflects the Company's findings at the time of its intervention only and within the limits of Client's instructions, if any. The Company's sole responsibility is to its Client and this document does not exonerate parties to a transaction from exercising all their rights and obligations under the transaction documents. This document cannot be reproduced except in full, without prior written approval of the Company. Any unauthorized alteration, forgery or falsification of the content or appearance of this document is unlawful and offenders may be prosecuted to the fullest extent of the law. Unless otherwise stated the results shown in this test report refer only to the sample(s) tested and such sample(s) are retained for 30 days only.

Test Mode: 05; Polarity: Vertical; Modulation:802.11ac; Bandwidth:20MHz; Channel:Low

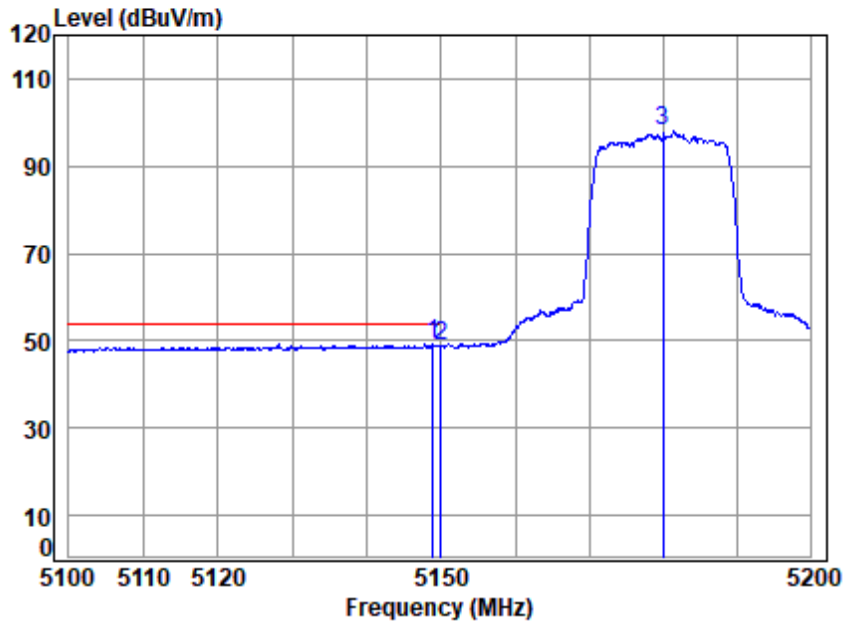

Site : chamber
 Condition: 3m VERTICAL
 Job No : 03018AT\03019AT
 Mode : 5180 Band edge
 : 5G WIFI 11AC20

		Cable	Ant	Preamp	Read	Limit	Over		
	Freq	Loss	Factor	Factor	Level	Level	Line	Limit	Remark
	MHz	dB	dB/m	dB	dBuV	dBuV/m	dBuV/m	dB	
1	q 5148.857	18.83	33.90	31.28	27.69	49.14	54.00	-4.86	Average
2	5149.980	18.83	33.90	31.28	27.60	49.05	54.00	-4.95	Average
3	5180.000	18.88	33.96	31.30	76.34	97.88	-----	-----	Average



Unless otherwise agreed in writing, this document is issued by the Company subject to its General Conditions of Service printed overleaf, available on request or accessible at <https://www.sgs.com/en/Terms-and-Conditions>. Attention is drawn to the limitation of liability, indemnification and jurisdiction issues defined therein. Any holder of this document is advised that information contained hereon reflects the Company's findings at the time of its intervention only and within the limits of Client's instructions, if any. The Company's sole responsibility is to its Client and this document does not exonerate parties to a transaction from exercising all their rights and obligations under the transaction documents. This document cannot be reproduced except in full, without prior written approval of the Company. Any unauthorized alteration, forgery or falsification of the content or appearance of this document is unlawful and offenders may be prosecuted to the fullest extent of the law. Unless otherwise stated the results shown in this test report refer only to the sample(s) tested and such sample(s) are retained for 30 days only.

Test Mode: 05; Polarity: Horizontal; Modulation:802.11ac; Bandwidth:20MHz; Channel:High

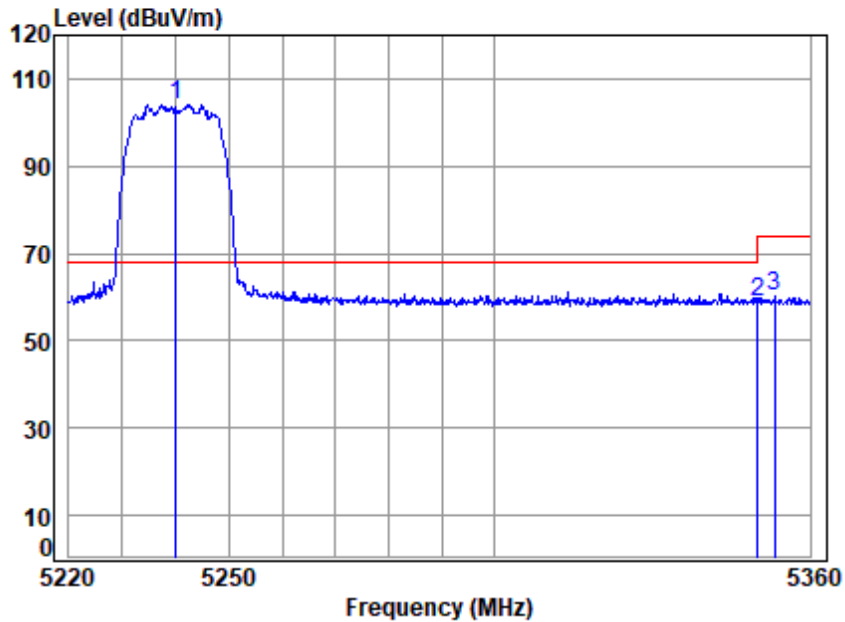

Site : chamber
 Condition: 3m HORIZONTAL
 Job No : 03018AT\03019AT
 Mode : 5240 Band edge
 : 5G WIFI 11AC20

	Freq	Cable Loss	Ant Factor	Preamp Factor	Read Level	Limit Level	Over Limit	Remark
	MHz	dB	dB/m	dB	dBuV	dBuV/m	dBuV/m	dB
1 p	5240.000	18.96	34.08	31.33	82.32	104.03	68.20	35.83 peak
2	5350.020	19.11	34.40	31.39	36.80	58.92	74.00	-15.08 peak
3	5353.195	19.11	34.41	31.39	38.22	60.35	74.00	-13.65 peak



Unless otherwise agreed in writing, this document is issued by the Company subject to its General Conditions of Service printed overleaf, available on request or accessible at <https://www.sgs.com/en/Terms-and-Conditions>. Attention is drawn to the limitation of liability, indemnification and jurisdiction issues defined therein. Any holder of this document is advised that information contained hereon reflects the Company's findings at the time of its intervention only and within the limits of Client's instructions, if any. The Company's sole responsibility is to its Client and this document does not exonerate parties to a transaction from exercising all their rights and obligations under the transaction documents. This document cannot be reproduced except in full, without prior written approval of the Company. Any unauthorized alteration, forgery or falsification of the content or appearance of this document is unlawful and offenders may be prosecuted to the fullest extent of the law. Unless otherwise stated the results shown in this test report refer only to the sample(s) tested and such sample(s) are retained for 30 days only.

Test Mode: 05; Polarity: Horizontal; Modulation:802.11ac; Bandwidth:20MHz; Channel:High

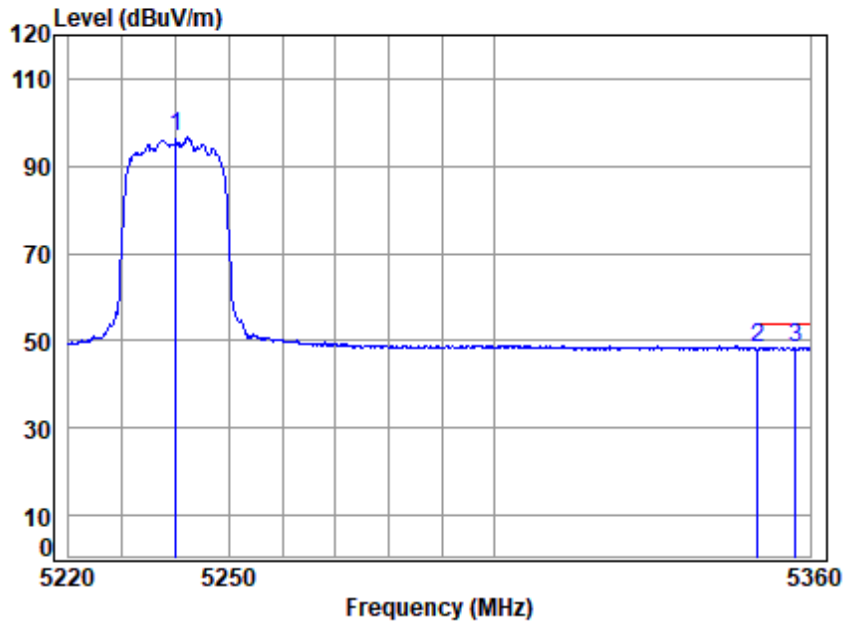

Site : chamber
 Condition: 3m HORIZONTAL
 Job No : 03018AT\03019AT
 Mode : 5240 Band edge
 : 5G WIFI 11AC20

	Freq	Cable Loss	Ant Factor	Preamp Factor	Read Level	Limit Level	Limit Line	Over Limit	Remark
	MHz	dB	dB/m	dB	dBuV	dBuV/m	dBuV/m	dB	
1	5240.000	18.96	34.08	31.33	74.84	96.55	-----	-----	Average
2	5350.020	19.11	34.40	31.39	26.13	48.25	54.00	-5.75	Average
3 q	5357.164	19.12	34.43	31.39	26.31	48.47	54.00	-5.53	Average



Unless otherwise agreed in writing, this document is issued by the Company subject to its General Conditions of Service printed overleaf, available on request or accessible at <https://www.sgs.com/en/Terms-and-Conditions>. Attention is drawn to the limitation of liability, indemnification and jurisdiction issues defined therein. Any holder of this document is advised that information contained hereon reflects the Company's findings at the time of its intervention only and within the limits of Client's instructions, if any. The Company's sole responsibility is to its Client and this document does not exonerate parties to a transaction from exercising all their rights and obligations under the transaction documents. This document cannot be reproduced except in full, without prior written approval of the Company. Any unauthorized alteration, forgery or falsification of the content or appearance of this document is unlawful and offenders may be prosecuted to the fullest extent of the law. Unless otherwise stated the results shown in this test report refer only to the sample(s) tested and such sample(s) are retained for 30 days only.

Test Mode: 05; Polarity: Vertical; Modulation:802.11ac; Bandwidth:20MHz; Channel:High

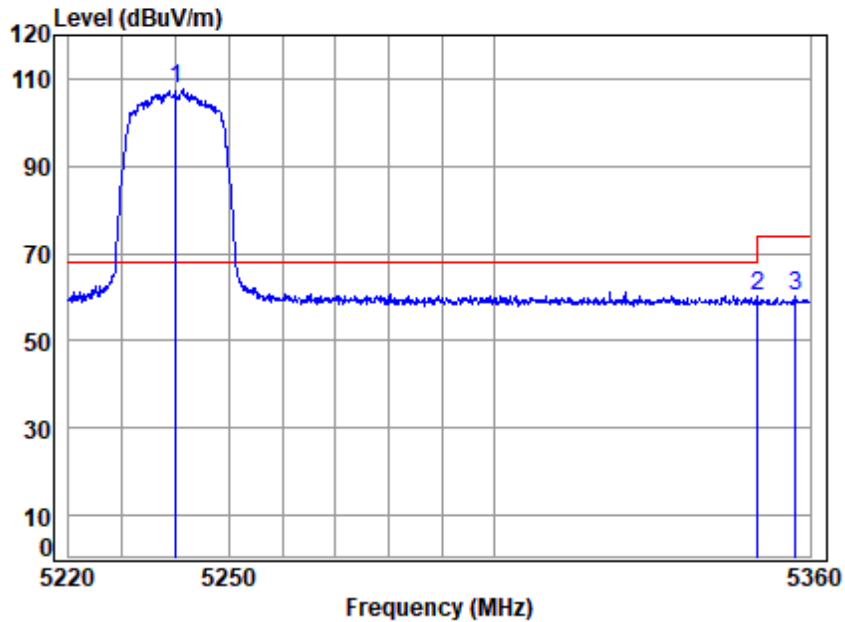

Site : chamber
 Condition: 3m VERTICAL
 Job No : 03018AT\03019AT
 Mode : 5240 Band edge
 : 5G WIFI 11AC20

	Freq	Cable Loss	Ant Factor	Preamp Factor	Read Level	Limit Level	Over Limit	Remark
	MHz	dB	dB/m	dB	dBuV	dBuV/m	dBuV/m	dB
1 p	5240.000	18.96	34.08	31.33	85.78	107.49	68.20	39.29 Peak
2	5350.020	19.11	34.40	31.39	37.98	60.10	74.00	-13.90 Peak
3	5357.164	19.12	34.43	31.39	37.97	60.13	74.00	-13.87 Peak



Test Mode: 05; Polarity: Vertical; Modulation:802.11ac; Bandwidth:20MHz; Channel:High

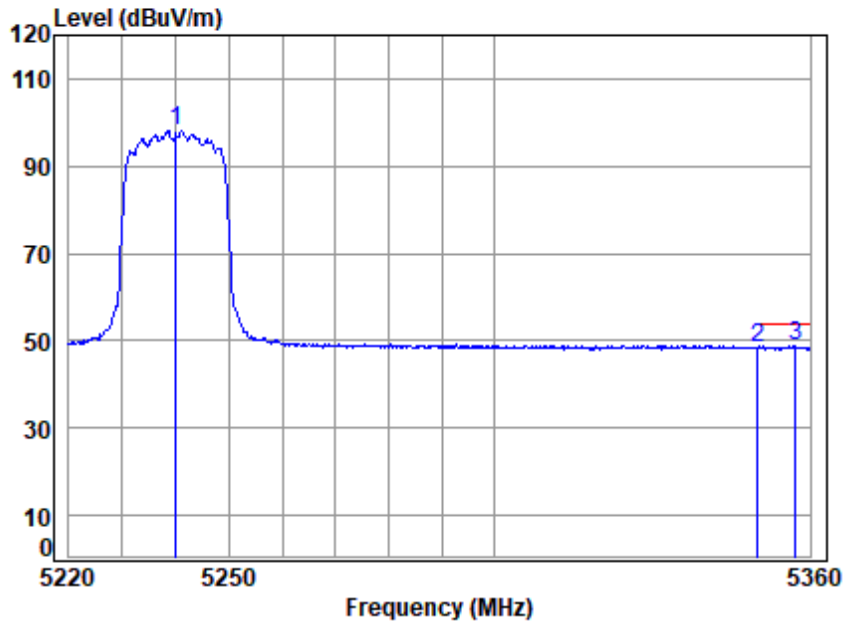

Site : chamber
 Condition: 3m VERTICAL
 Job No : 03018AT\03019AT
 Mode : 5240 Band edge
 : 5G WIFI 11AC20

	Freq	Cable Loss	Ant Factor	Preamp Factor	Read Level	Limit Level	Over Line	Over Limit	Remark
	MHz	dB	dB/m	dB	dBuV	dBuV/m	dBuV/m	dB	
1	5240.000	18.96	34.08	31.33	76.61	98.32	-----	-----	Average
2	5350.020	19.11	34.40	31.39	26.34	48.46	54.00	-5.54	Average
3 q	5357.164	19.12	34.43	31.39	26.84	49.00	54.00	-5.00	Average



Unless otherwise agreed in writing, this document is issued by the Company subject to its General Conditions of Service printed overleaf, available on request or accessible at <https://www.sgs.com/en/Terms-and-Conditions>. Attention is drawn to the limitation of liability, indemnification and jurisdiction issues defined therein. Any holder of this document is advised that information contained hereon reflects the Company's findings at the time of its intervention only and within the limits of Client's instructions, if any. The Company's sole responsibility is to its Client and this document does not exonerate parties to a transaction from exercising all their rights and obligations under the transaction documents. This document cannot be reproduced except in full, without prior written approval of the Company. Any unauthorized alteration, forgery or falsification of the content or appearance of this document is unlawful and offenders may be prosecuted to the fullest extent of the law. Unless otherwise stated the results shown in this test report refer only to the sample(s) tested and such sample(s) are retained for 30 days only.

Test Mode: 05; Polarity: Horizontal; Modulation:802.11ac; Bandwidth:40MHz; Channel:Low

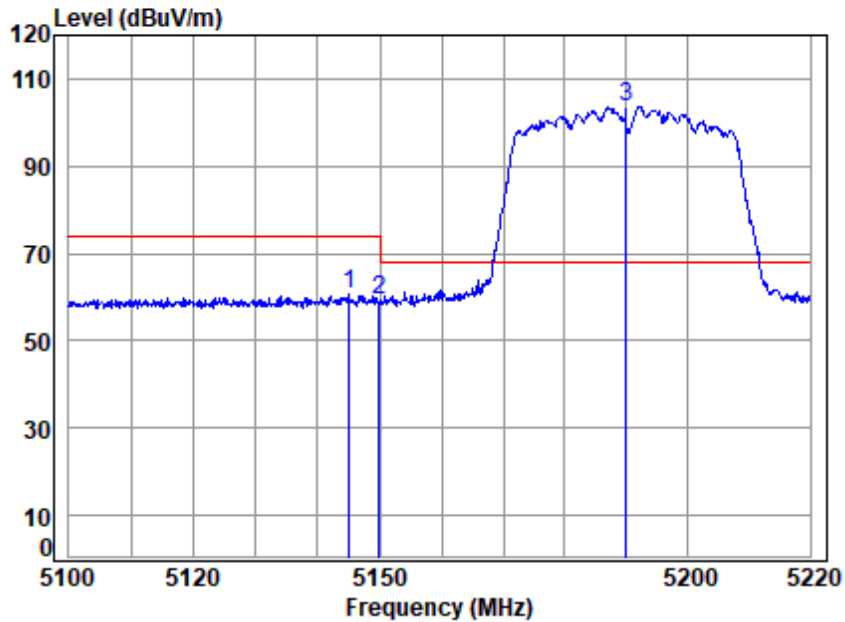

Site : chamber
 Condition: 3m HORIZONTAL
 Job No : 03018AT\03019AT
 Mode : 5190 Band edge
 : 5G WIFI 11AC40

	Cable	Ant	Preamp	Read	Limit	Over		
Freq	Loss	Factor	Factor	Level	Level	Line	Limit	Remark
MHz	dB	dB/m	dB	dBuV	dBuV/m	dBuV/m	dB	
1	5145.152	18.83	33.91	31.28	39.45	60.91	74.00	-13.09 peak
2	5149.980	18.83	33.90	31.28	37.92	59.37	74.00	-14.63 peak
3 p	5190.000	18.89	33.98	31.30	82.03	103.60	68.20	35.40 peak



Unless otherwise agreed in writing, this document is issued by the Company subject to its General Conditions of Service printed overleaf, available on request or accessible at <https://www.sgs.com/en/Terms-and-Conditions>. Attention is drawn to the limitation of liability, indemnification and jurisdiction issues defined therein. Any holder of this document is advised that information contained hereon reflects the Company's findings at the time of its intervention only and within the limits of Client's instructions, if any. The Company's sole responsibility is to its Client and this document does not exonerate parties to a transaction from exercising all their rights and obligations under the transaction documents. This document cannot be reproduced except in full, without prior written approval of the Company. Any unauthorized alteration, forgery or falsification of the content or appearance of this document is unlawful and offenders may be prosecuted to the fullest extent of the law. Unless otherwise stated the results shown in this test report refer only to the sample(s) tested and such sample(s) are retained for 30 days only.

Test Mode: 05; Polarity: Horizontal; Modulation:802.11ac; Bandwidth:40MHz; Channel:Low

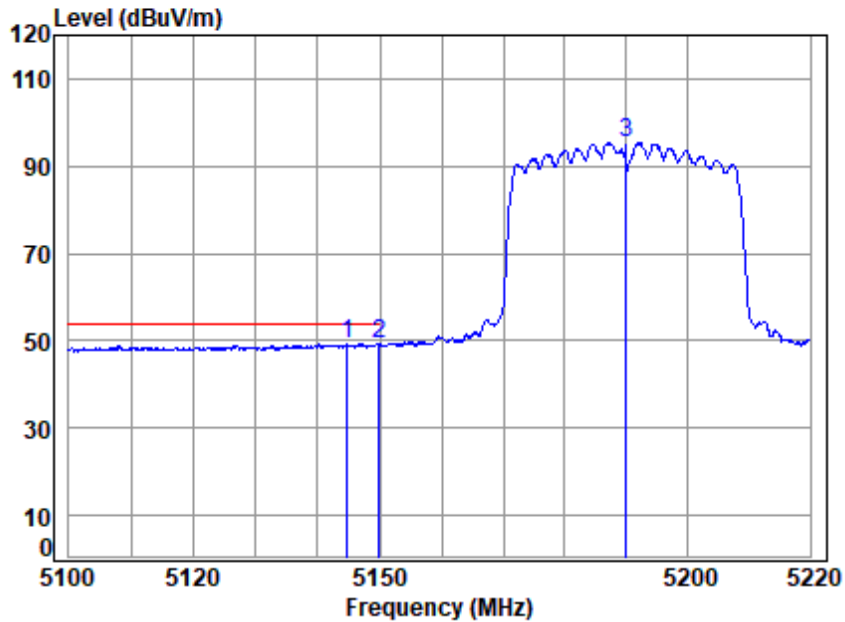

Site : chamber
 Condition: 3m HORIZONTAL
 Job No : 03018AT\03019AT
 Mode : 5190 Band edge
 : 5G WIFI 11AC40

		Cable	Ant	Preamp	Read	Limit	Over	
Freq	Loss	Factor	Factor	Factor	Level	Line	Limit	Remark
MHz	dB	dB/m	dB	dB	dBuV	dBuV/m	dBuV/m	dB
1 q	5144.793	18.83	33.91	31.28	28.03	49.49	54.00	-4.51 Average
2	5149.980	18.83	33.90	31.28	27.77	49.22	54.00	-4.78 Average
3	5190.000	18.89	33.98	31.30	73.67	95.24	-----	----- Average



Unless otherwise agreed in writing, this document is issued by the Company subject to its General Conditions of Service printed overleaf, available on request or accessible at <https://www.sgs.com/en/Terms-and-Conditions>. Attention is drawn to the limitation of liability, indemnification and jurisdiction issues defined therein. Any holder of this document is advised that information contained hereon reflects the Company's findings at the time of its intervention only and within the limits of Client's instructions, if any. The Company's sole responsibility is to its Client and this document does not exonerate parties to a transaction from exercising all their rights and obligations under the transaction documents. This document cannot be reproduced except in full, without prior written approval of the Company. Any unauthorized alteration, forgery or falsification of the content or appearance of this document is unlawful and offenders may be prosecuted to the fullest extent of the law. Unless otherwise stated the results shown in this test report refer only to the sample(s) tested and such sample(s) are retained for 30 days only.

Test Mode: 05; Polarity: Vertical; Modulation:802.11ac; Bandwidth:40MHz; Channel:Low

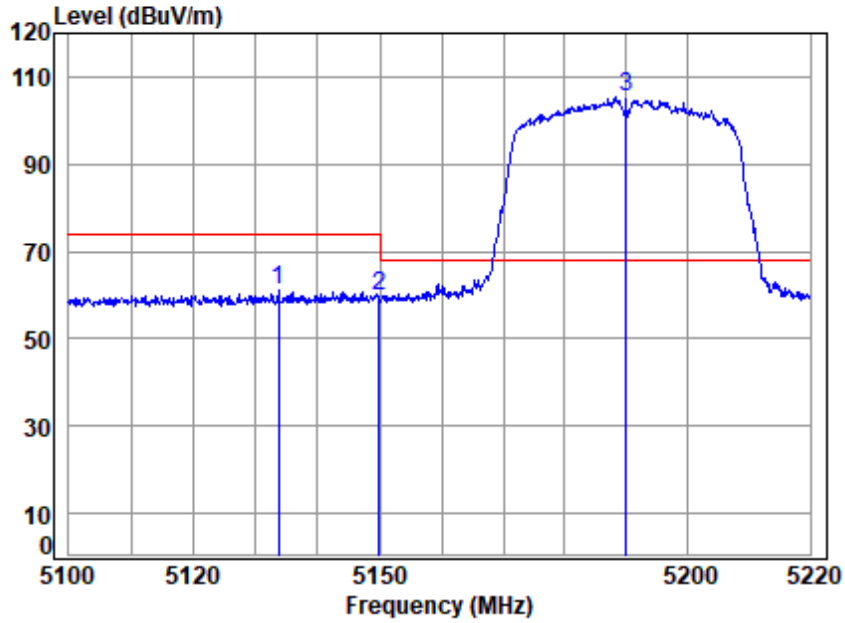

Site : chamber
 Condition: 3m VERTICAL
 Job No : 03018AT\03019AT
 Mode : 5190 Band edge
 : 5G WIFI 11AC40

	Cable	Ant	Preamp	Read	Limit	Over	
Freq	Loss	Factor	Factor	Level	Level	Line	Limit Remark
MHz	dB	dB/m	dB	dBuV	dBuV/m	dBuV/m	dB
1	5133.677	18.81	33.93	31.27	39.51	60.98	74.00 -13.02 Peak
2	5149.980	18.83	33.90	31.28	38.11	59.56	74.00 -14.44 Peak
3 p	5190.000	18.89	33.98	31.30	83.69	105.26	68.20 37.06 Peak



Unless otherwise agreed in writing, this document is issued by the Company subject to its General Conditions of Service printed overleaf, available on request or accessible at <https://www.sgs.com/en/Terms-and-Conditions>. Attention is drawn to the limitation of liability, indemnification and jurisdiction issues defined therein. Any holder of this document is advised that information contained hereon reflects the Company's findings at the time of its intervention only and within the limits of Client's instructions, if any. The Company's sole responsibility is to its Client and this document does not exonerate parties to a transaction from exercising all their rights and obligations under the transaction documents. This document cannot be reproduced except in full, without prior written approval of the Company. Any unauthorized alteration, forgery or falsification of the content or appearance of this document is unlawful and offenders may be prosecuted to the fullest extent of the law. Unless otherwise stated the results shown in this test report refer only to the sample(s) tested and such sample(s) are retained for 30 days only.

Test Mode: 05; Polarity: Vertical; Modulation:802.11ac; Bandwidth:40MHz; Channel:Low

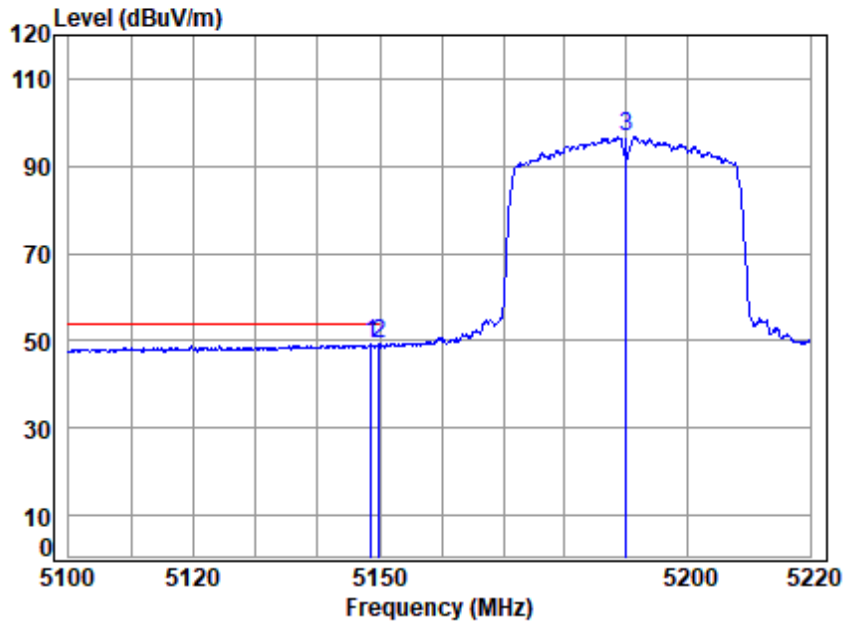

Site : chamber
 Condition: 3m VERTICAL
 Job No : 03018AT\03019AT
 Mode : 5190 Band edge
 : 5G WIFI 11AC40

	Freq	Cable Loss	Ant Factor	Preamp Factor	Read Level	Level	Limit Line	Over Limit	Remark
	MHz	dB	dB/m	dB	dBuV	dBuV/m	dBuV/m	dB	
1	5148.623	18.83	33.90	31.28	27.64	49.09	54.00	-4.91	Average
2 q	5149.980	18.83	33.90	31.28	27.74	49.19	54.00	-4.81	Average
3	5190.000	18.89	33.98	31.30	75.13	96.70	-----	-----	Average



Unless otherwise agreed in writing, this document is issued by the Company subject to its General Conditions of Service printed overleaf, available on request or accessible at <https://www.sgs.com/en/Terms-and-Conditions>. Attention is drawn to the limitation of liability, indemnification and jurisdiction issues defined therein. Any holder of this document is advised that information contained hereon reflects the Company's findings at the time of its intervention only and within the limits of Client's instructions, if any. The Company's sole responsibility is to its Client and this document does not exonerate parties to a transaction from exercising all their rights and obligations under the transaction documents. This document cannot be reproduced except in full, without prior written approval of the Company. Any unauthorized alteration, forgery or falsification of the content or appearance of this document is unlawful and offenders may be prosecuted to the fullest extent of the law. Unless otherwise stated the results shown in this test report refer only to the sample(s) tested and such sample(s) are retained for 30 days only.

Test Mode: 05; Polarity: Horizontal; Modulation:802.11ac; Bandwidth:40MHz; Channel:High

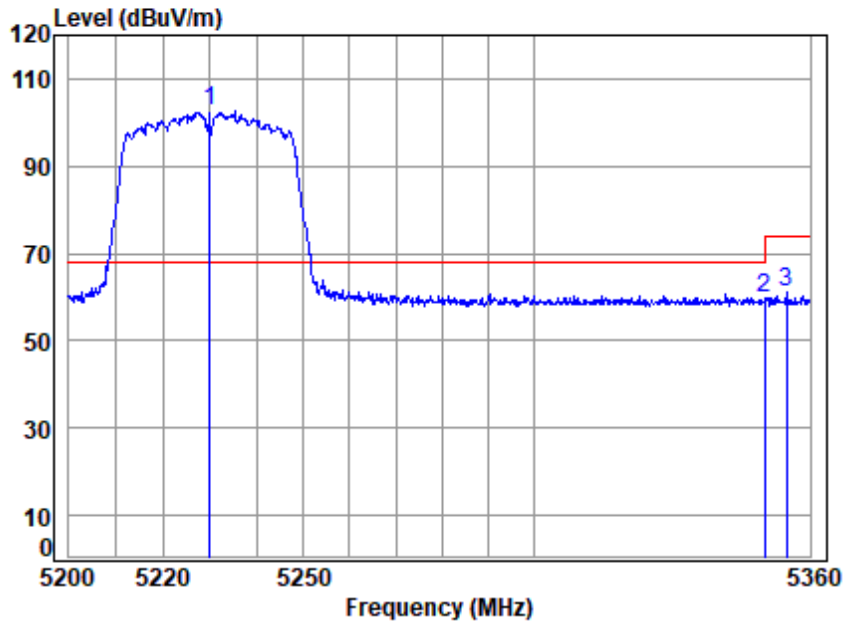

Site : chamber
 Condition: 3m HORIZONTAL
 Job No : 03018AT\03019AT
 Mode : 5230 Band edge
 : 5G WIFI 11AC40

	Cable	Ant	Preamp	Read	Limit	Over		
Freq	Loss	Factor	Factor	Level	Level	Line	Limit	Remark
MHz	dB	dB/m	dB	dBuV	dBuV/m	dBuV/m	dB	
1 p 5230.000	18.95	34.06	31.32	80.78	102.47	68.20	34.27	peak
2 5350.020	19.11	34.40	31.39	37.57	59.69	74.00	-14.31	peak
3 5354.805	19.12	34.42	31.39	38.88	61.03	74.00	-12.97	peak



Test Mode: 05; Polarity: Horizontal; Modulation:802.11ac; Bandwidth:40MHz; Channel:High

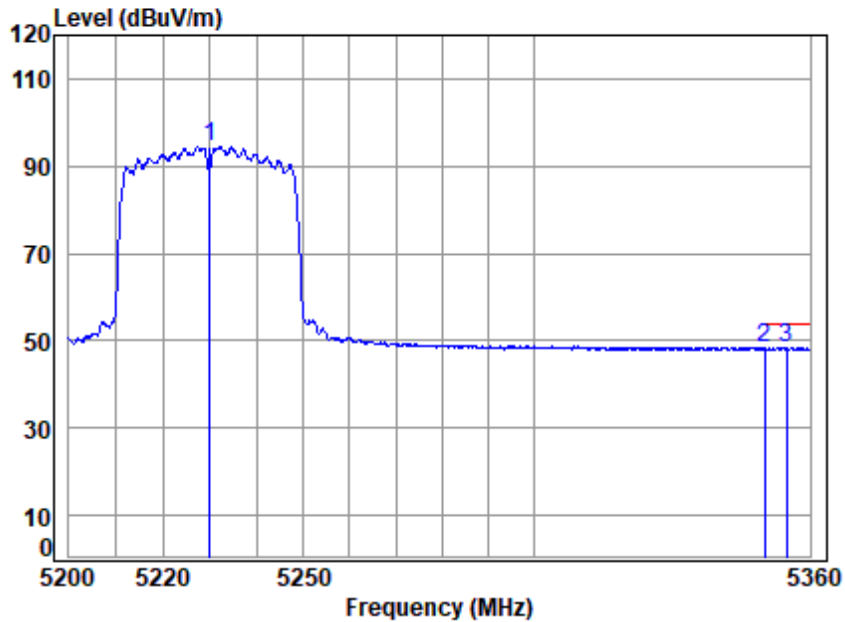

Site : chamber
 Condition: 3m HORIZONTAL
 Job No : 03018AT\03019AT
 Mode : 5230 Band edge
 : 5G WIFI 11AC40

	Freq	Cable Loss	Ant Factor	Preamp Factor	Read Level	Limit Level	Limit Line	Over Limit	Remark
	MHz	dB	dB/m	dB	dBuV	dBuV/m	dBuV/m	dB	
1	5230.000	18.95	34.06	31.32	72.98	94.67	-----	-----	Average
2	5350.020	19.11	34.40	31.39	26.06	48.18	54.00	-5.82	Average
3 q	5354.805	19.12	34.42	31.39	26.37	48.52	54.00	-5.48	Average



Unless otherwise agreed in writing, this document is issued by the Company subject to its General Conditions of Service printed overleaf, available on request or accessible at <https://www.sgs.com/en/Terms-and-Conditions>. Attention is drawn to the limitation of liability, indemnification and jurisdiction issues defined therein. Any holder of this document is advised that information contained hereon reflects the Company's findings at the time of its intervention only and within the limits of Client's instructions, if any. The Company's sole responsibility is to its Client and this document does not exonerate parties to a transaction from exercising all their rights and obligations under the transaction documents. This document cannot be reproduced except in full, without prior written approval of the Company. Any unauthorized alteration, forgery or falsification of the content or appearance of this document is unlawful and offenders may be prosecuted to the fullest extent of the law. Unless otherwise stated the results shown in this test report refer only to the sample(s) tested and such sample(s) are retained for 30 days only.

Test Mode: 05; Polarity: Vertical; Modulation:802.11ac; Bandwidth:40MHz; Channel:High

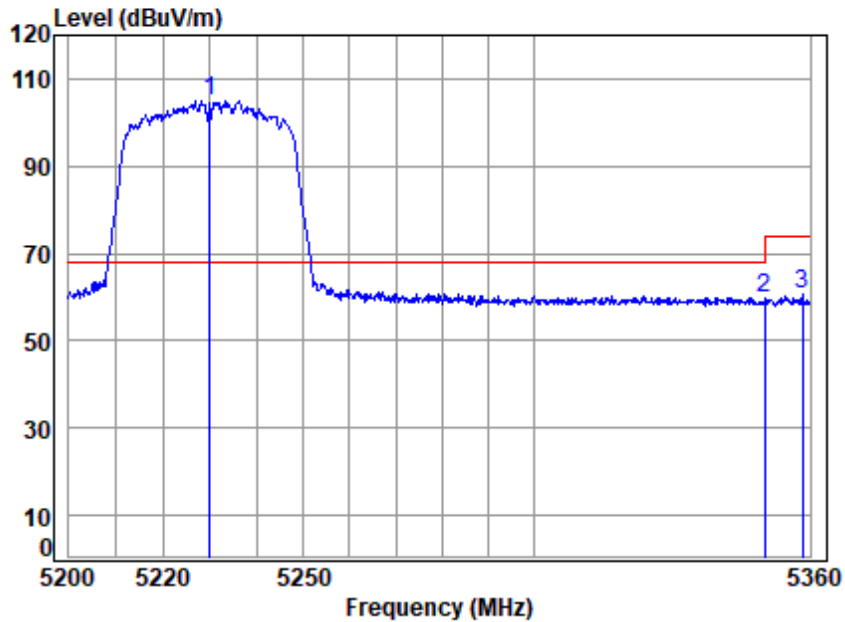

Site : chamber
 Condition: 3m VERTICAL
 Job No : 03018AT\03019AT
 Mode : 5230 Band edge
 : 5G WIFI 11AC40

		Cable	Ant	Preamp	Read	Limit	Over	
	Freq	Loss	Factor	Factor	Level	Line	Limit	Remark
	MHz	dB	dB/m	dB	dBuV	dBuV/m	dBuV/m	dB
1 p	5230.000	18.95	34.06	31.32	83.44	105.13	68.20	36.93 Peak
2	5350.020	19.11	34.40	31.39	37.60	59.72	74.00	-14.28 Peak
3	5358.376	19.12	34.43	31.39	38.39	60.55	74.00	-13.45 Peak



Unless otherwise agreed in writing, this document is issued by the Company subject to its General Conditions of Service printed overleaf, available on request or accessible at <https://www.sgs.com/en/Terms-and-Conditions>. Attention is drawn to the limitation of liability, indemnification and jurisdiction issues defined therein. Any holder of this document is advised that information contained hereon reflects the Company's findings at the time of its intervention only and within the limits of Client's instructions, if any. The Company's sole responsibility is to its Client and this document does not exonerate parties to a transaction from exercising all their rights and obligations under the transaction documents. This document cannot be reproduced except in full, without prior written approval of the Company. Any unauthorized alteration, forgery or falsification of the content or appearance of this document is unlawful and offenders may be prosecuted to the fullest extent of the law. Unless otherwise stated the results shown in this test report refer only to the sample(s) tested and such sample(s) are retained for 30 days only.

Test Mode: 05; Polarity: Vertical; Modulation:802.11ac; Bandwidth:40MHz; Channel:High

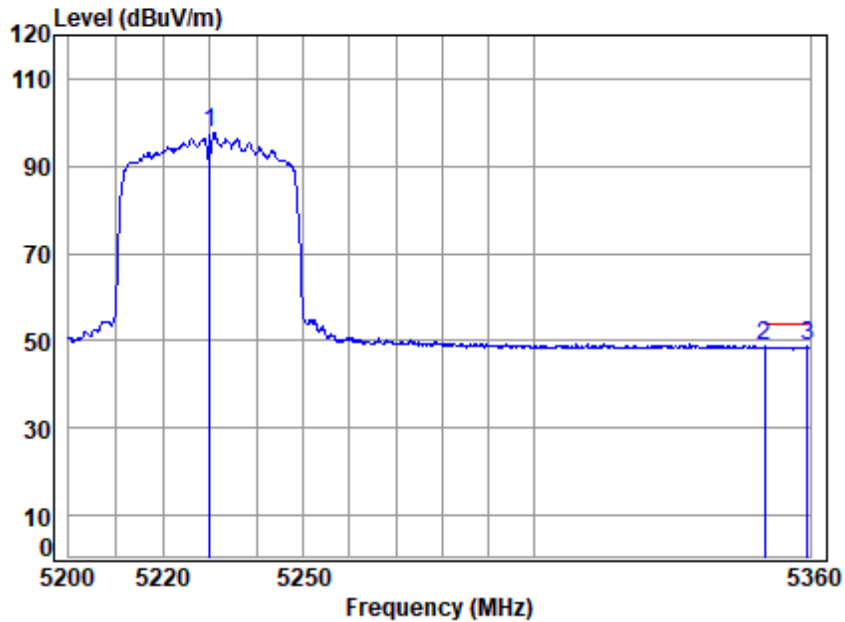

Site : chamber
 Condition: 3m VERTICAL
 Job No : 03018AT\03019AT
 Mode : 5230 Band edge
 : 5G WIFI 11AC40

	Freq	Cable Loss	Ant Factor	Preamp Factor	Read Level	Limit Level	Limit Line	Over Limit	Remark
	MHz	dB	dB/m	dB	dBuV	dBuV/m	dBuV/m	dB	
1	5230.000	18.95	34.06	31.32	76.03	97.72	-----	-----	Average
2	5350.020	19.11	34.40	31.39	26.51	48.63	54.00	-5.37	Average
3 q	5359.350	19.12	34.44	31.39	26.53	48.70	54.00	-5.30	Average



Unless otherwise agreed in writing, this document is issued by the Company subject to its General Conditions of Service printed overleaf, available on request or accessible at <https://www.sgs.com/en/Terms-and-Conditions>. Attention is drawn to the limitation of liability, indemnification and jurisdiction issues defined therein. Any holder of this document is advised that information contained hereon reflects the Company's findings at the time of its intervention only and within the limits of Client's instructions, if any. The Company's sole responsibility is to its Client and this document does not exonerate parties to a transaction from exercising all their rights and obligations under the transaction documents. This document cannot be reproduced except in full, without prior written approval of the Company. Any unauthorized alteration, forgery or falsification of the content or appearance of this document is unlawful and offenders may be prosecuted to the fullest extent of the law. Unless otherwise stated the results shown in this test report refer only to the sample(s) tested and such sample(s) are retained for 30 days only.

Attention: To check the authenticity of testing /inspection report & certificate, please contact us at telephone: (86-755) 8307 1443, or email: CN.Doccheck@sgs.com
 No.1 Workshop, M-10, Middle Section, Science & Technology Park, Nanshan District, Shenzhen, Guangdong, China 518057 t (86-755) 26012053 f (86-755) 26710594 www.sgs.com.cn
 中国·广东·深圳市南山区科技园中区M-10栋1号厂房 邮编: 518057 t (86-755) 26012053 f (86-755) 26710594 sgs.china@sgs.com

Test Mode: 05; Polarity: Horizontal; Modulation:802.11ac; Bandwidth:80MHz; Channel:middle

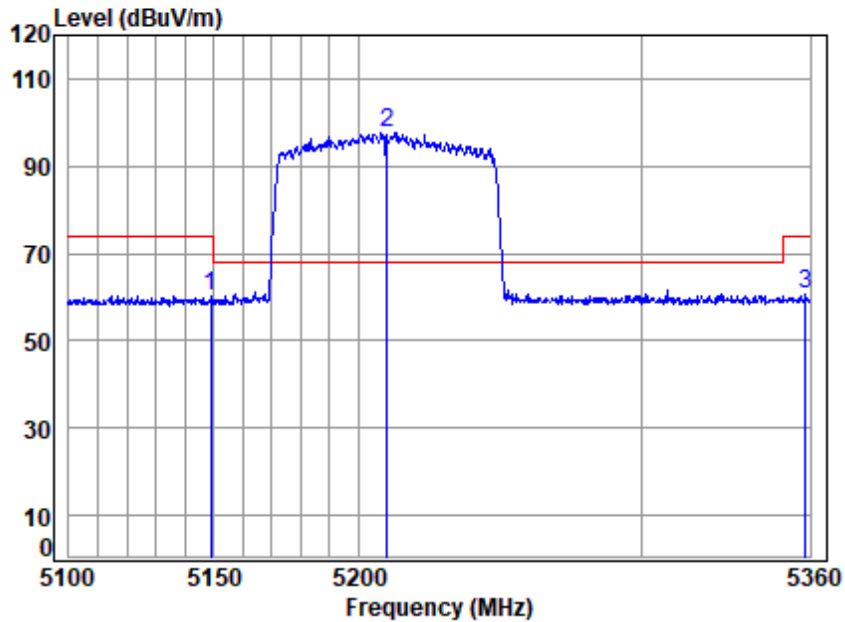

Site : chamber
 Condition: 3m HORIZONTAL
 Job No : 03018AT\03019AT
 Mode : 5210 Band edge
 : 5G WIFI 11AC80

	Freq	Cable Loss	Ant Factor	Preamp Factor	Read Level	Limit Level	Over Line	Remark
	MHz	dB	dB/m	dB	dBuV	dBuV/m	dBuV/m	dB
1	5148.667	18.83	33.90	35.31	42.79	60.21	74.00	-13.79 peak
2 p	5210.000	18.92	34.02	35.28	80.02	97.68	68.20	29.48 peak
3	5358.401	19.12	34.43	35.20	42.27	60.62	74.00	-13.38 peak



Unless otherwise agreed in writing, this document is issued by the Company subject to its General Conditions of Service printed overleaf, available on request or accessible at <https://www.sgs.com/en/Terms-and-Conditions>. Attention is drawn to the limitation of liability, indemnification and jurisdiction issues defined therein. Any holder of this document is advised that information contained hereon reflects the Company's findings at the time of its intervention only and within the limits of Client's instructions, if any. The Company's sole responsibility is to its Client and this document does not exonerate parties to a transaction from exercising all their rights and obligations under the transaction documents. This document cannot be reproduced except in full, without prior written approval of the Company. Any unauthorized alteration, forgery or falsification of the content or appearance of this document is unlawful and offenders may be prosecuted to the fullest extent of the law. Unless otherwise stated the results shown in this test report refer only to the sample(s) tested and such sample(s) are retained for 30 days only.

Test Mode: 05; Polarity: Horizontal; Modulation:802.11ac; Bandwidth:80MHz; Channel:middle

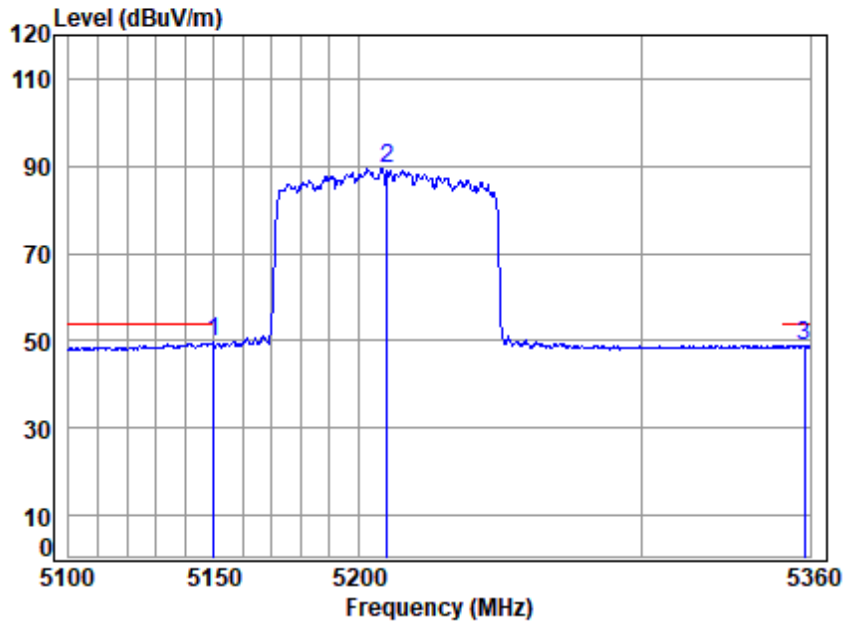

Site : chamber
 Condition: 3m HORIZONTAL
 Job No : 03018AT\03019AT
 Mode : 5210 Band edge
 : 5G WIFI 11AC80

		Cable	Ant	Preamp	Read	Limit	Over	
Freq	Loss	Factor	Factor	Factor	Level	Level	Line	Limit Remark
MHz	dB	dB/m	dB	dB	dBuV	dBuV/m	dBuV/m	dB
1 q 5149.690	18.83	33.90	35.31	32.09	49.51	54.00	-4.49	Average
2 5210.000	18.92	34.02	35.28	71.66	89.32	-----	-----	Average
3 5357.868	19.12	34.43	35.20	30.62	48.97	54.00	-5.03	Average



Unless otherwise agreed in writing, this document is issued by the Company subject to its General Conditions of Service printed overleaf, available on request or accessible at <https://www.sgs.com/en/Terms-and-Conditions>. Attention is drawn to the limitation of liability, indemnification and jurisdiction issues defined therein. Any holder of this document is advised that information contained hereon reflects the Company's findings at the time of its intervention only and within the limits of Client's instructions, if any. The Company's sole responsibility is to its Client and this document does not exonerate parties to a transaction from exercising all their rights and obligations under the transaction documents. This document cannot be reproduced except in full, without prior written approval of the Company. Any unauthorized alteration, forgery or falsification of the content or appearance of this document is unlawful and offenders may be prosecuted to the fullest extent of the law. Unless otherwise stated the results shown in this test report refer only to the sample(s) tested and such sample(s) are retained for 30 days only.

Test Mode: 05; Polarity: Vertical; Modulation:802.11ac; Bandwidth:80MHz; Channel:middle

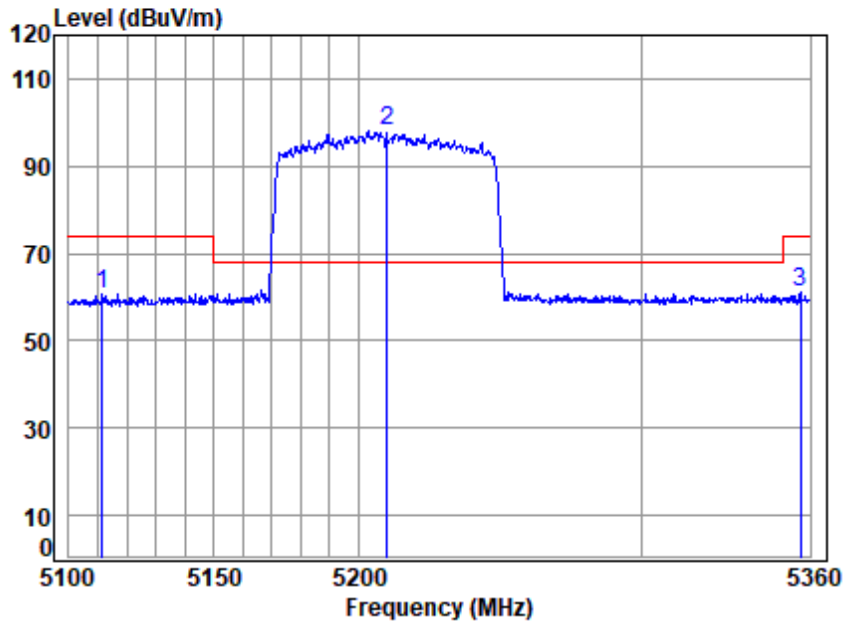

Site : chamber
 Condition: 3m VERTICAL
 Job No : 03018AT\03019AT
 Mode : 5210 Band edge
 : 5G WIFI 11AC80

	Freq	Cable Loss	Ant Factor	Preamp Factor	Read Level	Limit Level	Over Line	Remark
	MHz	dB	dB/m	dB	dBuV	dBuV/m	dBuV/m	dB
1	5111.424	18.78	33.98	35.33	43.39	60.82	74.00	-13.18 Peak
2 p	5210.000	18.92	34.02	35.28	80.39	98.05	68.20	29.85 Peak
3	5356.537	19.12	34.43	35.20	42.77	61.12	74.00	-12.88 Peak



Unless otherwise agreed in writing, this document is issued by the Company subject to its General Conditions of Service printed overleaf, available on request or accessible at <https://www.sgs.com/en/Terms-and-Conditions>. Attention is drawn to the limitation of liability, indemnification and jurisdiction issues defined therein. Any holder of this document is advised that information contained hereon reflects the Company's findings at the time of its intervention only and within the limits of Client's instructions, if any. The Company's sole responsibility is to its Client and this document does not exonerate parties to a transaction from exercising all their rights and obligations under the transaction documents. This document cannot be reproduced except in full, without prior written approval of the Company. Any unauthorized alteration, forgery or falsification of the content or appearance of this document is unlawful and offenders may be prosecuted to the fullest extent of the law. Unless otherwise stated the results shown in this test report refer only to the sample(s) tested and such sample(s) are retained for 30 days only.

Test Mode: 05; Polarity: Vertical; Modulation:802.11ac; Bandwidth:80MHz; Channel:middle

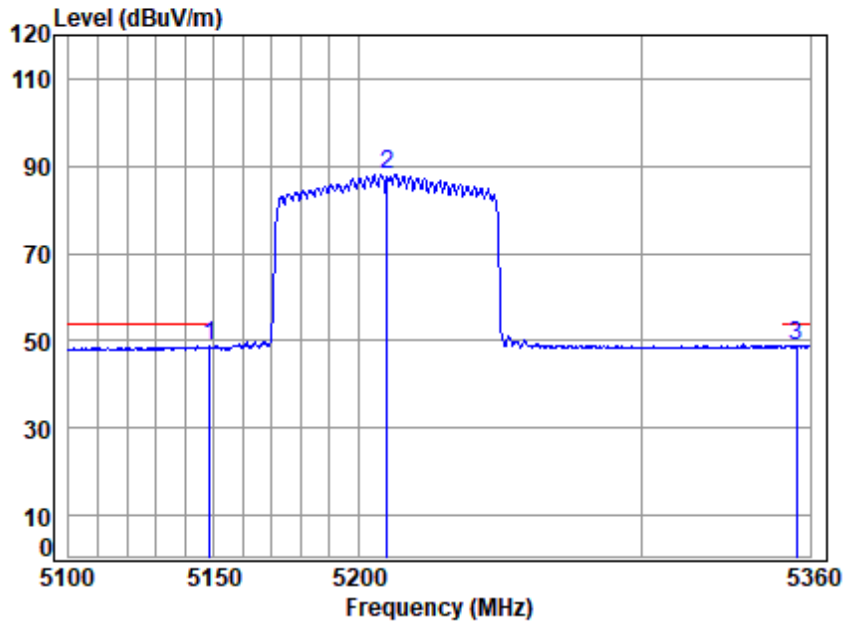

Site : chamber
 Condition: 3m VERTICAL
 Job No : 03018AT\03019AT
 Mode : 5210 Band edge
 : 5G WIFI 11AC80

	Freq	Cable Loss	Ant Factor	Preamp Factor	Read Level	Limit Level	Over Limit	Remark
	MHz	dB	dB/m	dB	dBuV	dBuV/m	dBuV/m	dB
1	5148.410	18.83	33.90	35.31	31.34	48.76	54.00	-5.24 Average
2	5210.000	18.92	34.02	35.28	70.36	88.02	-----	----- Average
3 q	5355.205	19.12	34.42	35.21	30.68	49.01	54.00	-4.99 Average



Unless otherwise agreed in writing, this document is issued by the Company subject to its General Conditions of Service printed overleaf, available on request or accessible at <https://www.sgs.com/en/Terms-and-Conditions>. Attention is drawn to the limitation of liability, indemnification and jurisdiction issues defined therein. Any holder of this document is advised that information contained hereon reflects the Company's findings at the time of its intervention only and within the limits of Client's instructions, if any. The Company's sole responsibility is to its Client and this document does not exonerate parties to a transaction from exercising all their rights and obligations under the transaction documents. This document cannot be reproduced except in full, without prior written approval of the Company. Any unauthorized alteration, forgery or falsification of the content or appearance of this document is unlawful and offenders may be prosecuted to the fullest extent of the law. Unless otherwise stated the results shown in this test report refer only to the sample(s) tested and such sample(s) are retained for 30 days only.

Attention: To check the authenticity of testing /inspection report & certificate, please contact us at telephone: (86-755) 8307 1443, or email: CN.Doccheck@sgs.com
 No.1 Workshop, M-10, Middle Section, Science & Technology Park, Nanshan District, Shenzhen, Guangdong, China 518057 t (86-755) 26012053 f (86-755) 26710594 www.sgs.com.cn
 中国·广东·深圳市南山区科技园中区M-10栋1号厂房 邮编: 518057 t (86-755) 26012053 f (86-755) 26710594 sgs.china@sgs.com

Test Mode: 05; Polarity: Horizontal; Modulation:802.11 ax(Full RU0); Bandwidth:20MHz; Channel:Low

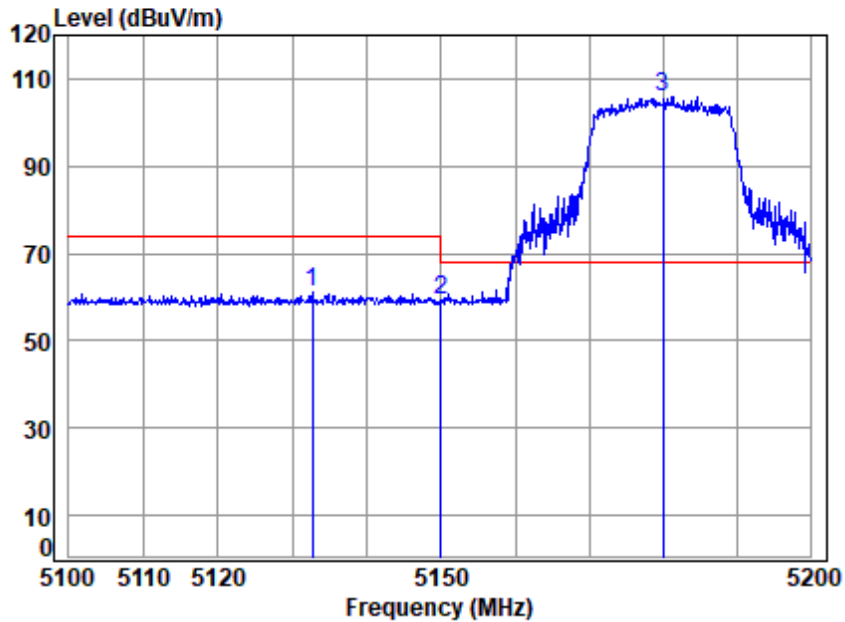

Site : chamber
 Condition: 3m HORIZONTAL
 Job No : 03018AT\03019AT
 Mode : 5180 Band edge
 : 5G WIFI 11AX20

	Cable	Ant	Preamp	Read	Limit	Over		
Freq	Loss	Factor	Factor	Level	Level	Line	Limit	Remark
MHz	dB	dB/m	dB	dBuV	dBuV/m	dBuV/m	dB	
1	5132.686	18.81	33.93	35.32	43.51	60.93	74.00	-13.07 peak
2	5149.980	18.83	33.90	35.31	42.11	59.53	74.00	-14.47 peak
3 p	5180.000	18.88	33.96	35.29	88.38	105.93	68.20	37.73 peak



Unless otherwise agreed in writing, this document is issued by the Company subject to its General Conditions of Service printed overleaf, available on request or accessible at <https://www.sgs.com/en/Terms-and-Conditions>. Attention is drawn to the limitation of liability, indemnification and jurisdiction issues defined therein. Any holder of this document is advised that information contained hereon reflects the Company's findings at the time of its intervention only and within the limits of Client's instructions, if any. The Company's sole responsibility is to its Client and this document does not exonerate parties to a transaction from exercising all their rights and obligations under the transaction documents. This document cannot be reproduced except in full, without prior written approval of the Company. Any unauthorized alteration, forgery or falsification of the content or appearance of this document is unlawful and offenders may be prosecuted to the fullest extent of the law. Unless otherwise stated the results shown in this test report refer only to the sample(s) tested and such sample(s) are retained for 30 days only.

Test Mode: 05; Polarity: Horizontal; Modulation:802.11 ax(Full RU0); Bandwidth:20MHz; Channel:Low

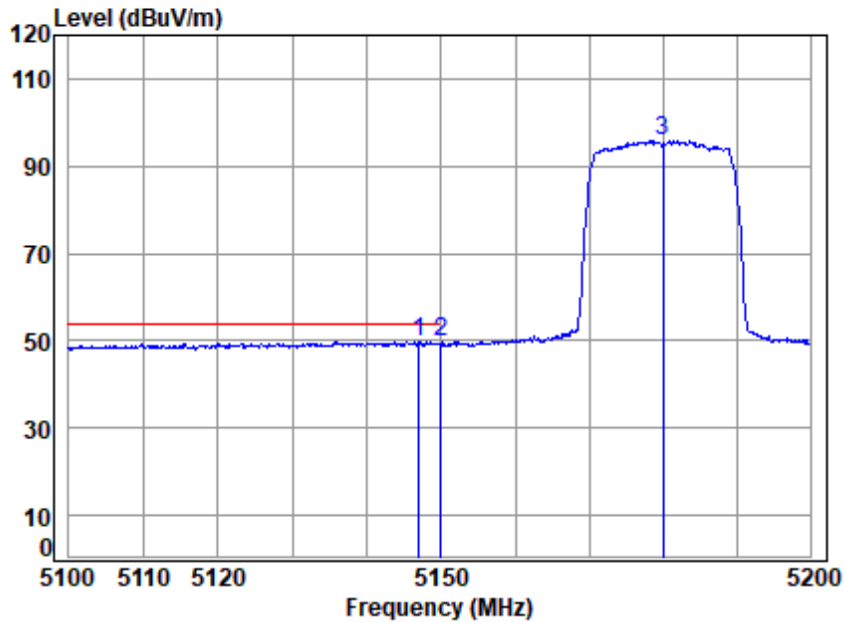

Site : chamber
 Condition: 3m HORIZONTAL
 Job No : 03018AT\03019AT
 Mode : 5180 Band edge
 : 5G WIFI 11AX20

		Cable	Ant	Preamp	Read	Limit	Over		
	Freq	Loss	Factor	Factor	Level	Level	Line	Limit	Remark
	MHz	dB	dB/m	dB	dBuV	dBuV/m	dBuV/m	dB	
1	q 5147.058	18.83	33.91	35.31	32.41	49.84	54.00	-4.16	Average
2	5149.980	18.83	33.90	35.31	32.19	49.61	54.00	-4.39	Average
3	5180.000	18.88	33.96	35.29	78.33	95.88	-----	-----	Average



Unless otherwise agreed in writing, this document is issued by the Company subject to its General Conditions of Service printed overleaf, available on request or accessible at <https://www.sgs.com/en/Terms-and-Conditions>. Attention is drawn to the limitation of liability, indemnification and jurisdiction issues defined therein. Any holder of this document is advised that information contained hereon reflects the Company's findings at the time of its intervention only and within the limits of Client's instructions, if any. The Company's sole responsibility is to its Client and this document does not exonerate parties to a transaction from exercising all their rights and obligations under the transaction documents. This document cannot be reproduced except in full, without prior written approval of the Company. Any unauthorized alteration, forgery or falsification of the content or appearance of this document is unlawful and offenders may be prosecuted to the fullest extent of the law. Unless otherwise stated the results shown in this test report refer only to the sample(s) tested and such sample(s) are retained for 30 days only.

Test Mode: 05; Polarity: Vertical; Modulation:802.11ax(Full RU0); Bandwidth:20MHz; Channel:Low

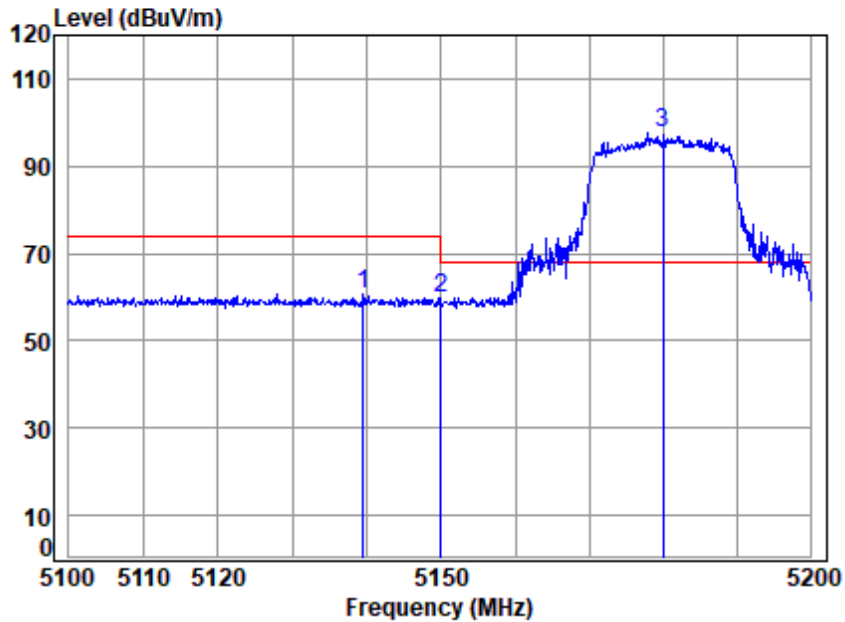

Site : chamber
 Condition: 3m VERTICAL
 Job No : 03018AT\03019AT
 Mode : 5180 Band edge
 : 5G WIFI 11AX20

	Cable	Ant	Preamp	Read	Limit	Over		
Freq	Loss	Factor	Factor	Level	Level	Line	Limit	
MHz	dB	dB/m	dB	dBuV	dBuV/m	dBuV/m	dB	
1	5139.468	18.82	33.92	35.32	43.16	60.58	74.00	-13.42 Peak
2	5149.980	18.83	33.90	35.31	42.37	59.79	74.00	-14.21 Peak
3 p	5180.000	18.88	33.96	35.29	80.18	97.73	68.20	29.53 Peak



Unless otherwise agreed in writing, this document is issued by the Company subject to its General Conditions of Service printed overleaf, available on request or accessible at <https://www.sgs.com/en/Terms-and-Conditions>. Attention is drawn to the limitation of liability, indemnification and jurisdiction issues defined therein. Any holder of this document is advised that information contained hereon reflects the Company's findings at the time of its intervention only and within the limits of Client's instructions, if any. The Company's sole responsibility is to its Client and this document does not exonerate parties to a transaction from exercising all their rights and obligations under the transaction documents. This document cannot be reproduced except in full, without prior written approval of the Company. Any unauthorized alteration, forgery or falsification of the content or appearance of this document is unlawful and offenders may be prosecuted to the fullest extent of the law. Unless otherwise stated the results shown in this test report refer only to the sample(s) tested and such sample(s) are retained for 30 days only.

Test Mode: 05; Polarity: Vertical; Modulation:802.11ax(Full RU0); Bandwidth:20MHz; Channel:Low

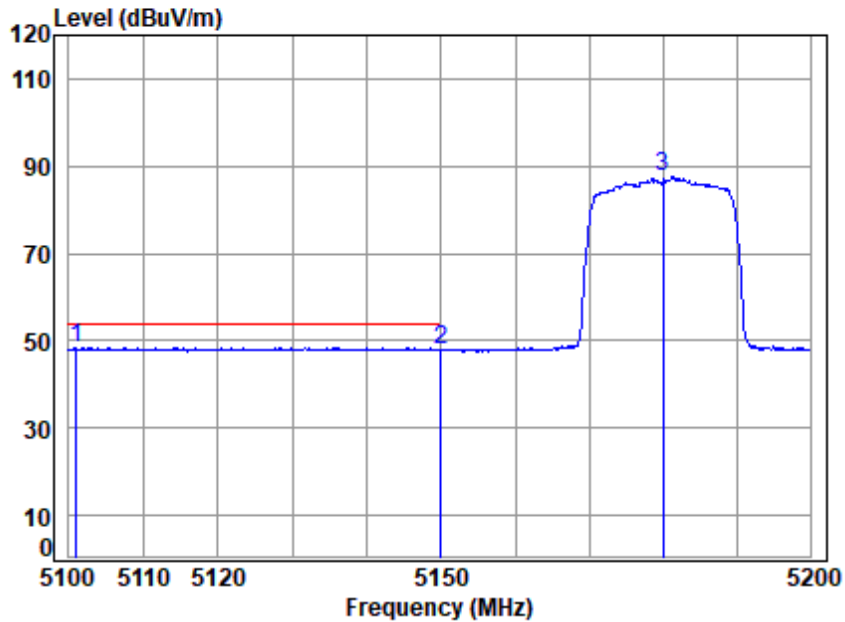

Site : chamber
 Condition: 3m VERTICAL
 Job No : 03018AT\03019AT
 Mode : 5180 Band edge
 : 5G WIFI 11AX20

		Cable	Ant	Preamp	Read	Limit	Over	
Freq	Loss	Factor	Factor	Factor	Level	Level	Line	Limit Remark
MHz	dB	dB/m	dB	dB	dBuV	dBuV/m	dBuV/m	dB
1 q 5100.990	18.76	34.00	35.34	31.04	48.46	54.00	-5.54	Average
2 5149.980	18.83	33.90	35.31	30.70	48.12	54.00	-5.88	Average
3 5180.000	18.88	33.96	35.29	69.90	87.45	-----	-----	Average



Unless otherwise agreed in writing, this document is issued by the Company subject to its General Conditions of Service printed overleaf, available on request or accessible at <https://www.sgs.com/en/Terms-and-Conditions>. Attention is drawn to the limitation of liability, indemnification and jurisdiction issues defined therein. Any holder of this document is advised that information contained hereon reflects the Company's findings at the time of its intervention only and within the limits of Client's instructions, if any. The Company's sole responsibility is to its Client and this document does not exonerate parties to a transaction from exercising all their rights and obligations under the transaction documents. This document cannot be reproduced except in full, without prior written approval of the Company. Any unauthorized alteration, forgery or falsification of the content or appearance of this document is unlawful and offenders may be prosecuted to the fullest extent of the law. Unless otherwise stated the results shown in this test report refer only to the sample(s) tested and such sample(s) are retained for 30 days only.

Test Mode: 05; Polarity: Horizontal; Modulation:802.11ax(Full RU0); Bandwidth:20MHz; Channel:High

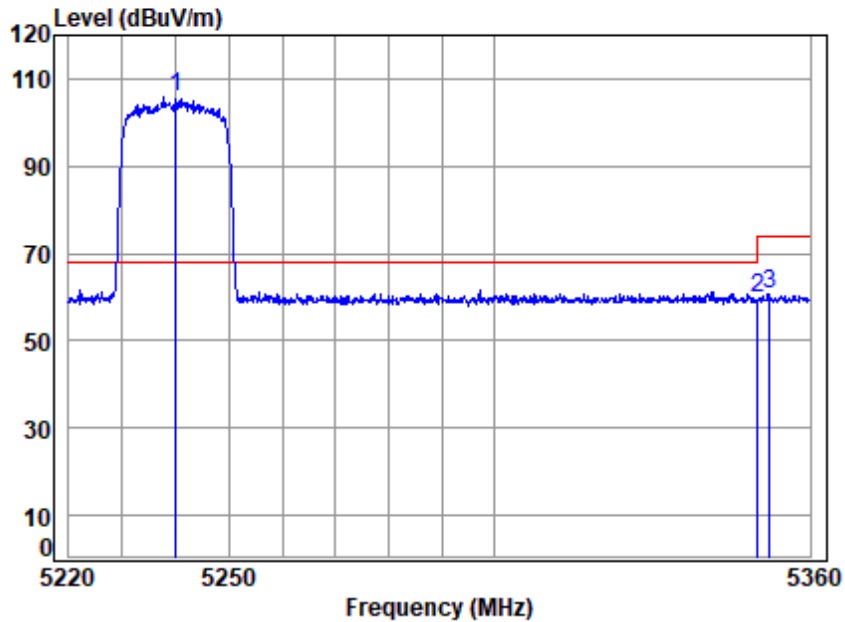

Site : chamber
 Condition: 3m HORIZONTAL
 Job No : 03018AT\03019AT
 Mode : 5240 Band edge
 : 5G WIFI 11AX20

	Freq	Cable Loss	Ant Factor	Preamp Factor	Read Level	Limit Level	Over Limit	Remark
	MHz	dB	dB/m	dB	dBuV	dBuV/m	dBuV/m	dB
1 p	5240.000	18.96	34.08	35.26	87.88	105.66	68.20	37.46 peak
2	5350.020	19.11	34.40	35.21	41.58	59.88	74.00	-14.12 peak
3	5352.345	19.11	34.41	35.21	42.34	60.65	74.00	-13.35 peak



Unless otherwise agreed in writing, this document is issued by the Company subject to its General Conditions of Service printed overleaf, available on request or accessible at <https://www.sgs.com/en/Terms-and-Conditions>. Attention is drawn to the limitation of liability, indemnification and jurisdiction issues defined therein. Any holder of this document is advised that information contained hereon reflects the Company's findings at the time of its intervention only and within the limits of Client's instructions, if any. The Company's sole responsibility is to its Client and this document does not exonerate parties to a transaction from exercising all their rights and obligations under the transaction documents. This document cannot be reproduced except in full, without prior written approval of the Company. Any unauthorized alteration, forgery or falsification of the content or appearance of this document is unlawful and offenders may be prosecuted to the fullest extent of the law. Unless otherwise stated the results shown in this test report refer only to the sample(s) tested and such sample(s) are retained for 30 days only.

Test Mode: 05; Polarity: Horizontal; Modulation:802.11ax(Full RU0); Bandwidth:20MHz; Channel:High

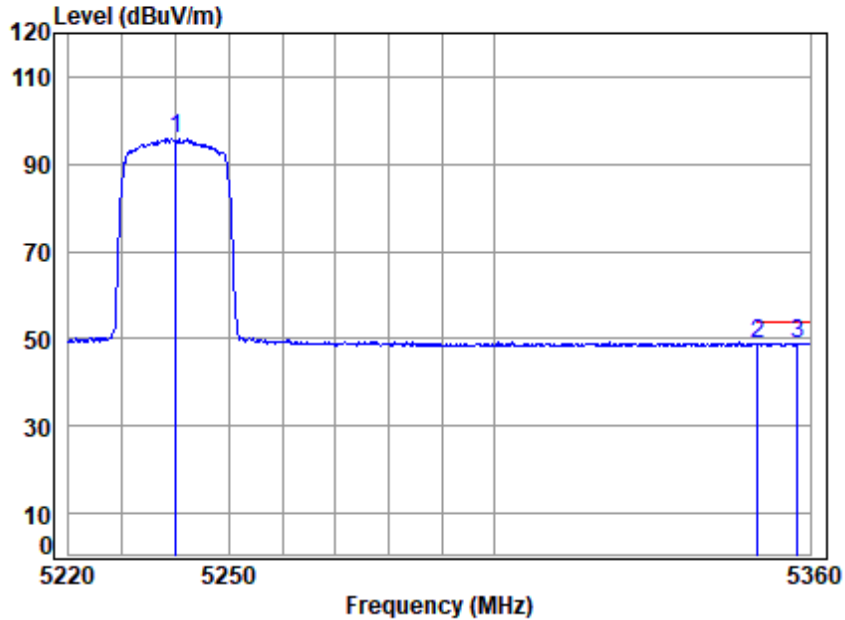

Site : chamber
 Condition: 3m HORIZONTAL
 Job No : 03018AT\03019AT
 Mode : 5240 Band edge
 : 5G WIFI 11AX20

	Freq	Cable Loss	Ant Factor	Preamp Factor	Read Level	Limit Level	Over Limit	Remark
	MHz	dB	dB/m	dB	dBuV	dBuV/m	dBuV/m	dB
1	5240.000	18.96	34.08	35.26	78.25	96.03	-----	Average
2	5350.020	19.11	34.40	35.21	30.48	48.78	54.00	-5.22 Average
3 q	5357.589	19.12	34.43	35.20	30.58	48.93	54.00	-5.07 Average



Unless otherwise agreed in writing, this document is issued by the Company subject to its General Conditions of Service printed overleaf, available on request or accessible at <https://www.sgs.com/en/Terms-and-Conditions>. Attention is drawn to the limitation of liability, indemnification and jurisdiction issues defined therein. Any holder of this document is advised that information contained hereon reflects the Company's findings at the time of its intervention only and within the limits of Client's instructions, if any. The Company's sole responsibility is to its Client and this document does not exonerate parties to a transaction from exercising all their rights and obligations under the transaction documents. This document cannot be reproduced except in full, without prior written approval of the Company. Any unauthorized alteration, forgery or falsification of the content or appearance of this document is unlawful and offenders may be prosecuted to the fullest extent of the law. Unless otherwise stated the results shown in this test report refer only to the sample(s) tested and such sample(s) are retained for 30 days only.

Test Mode: 05; Polarity: Vertical; Modulation:802.11ax(Full RU0); Bandwidth:20MHz; Channel:High

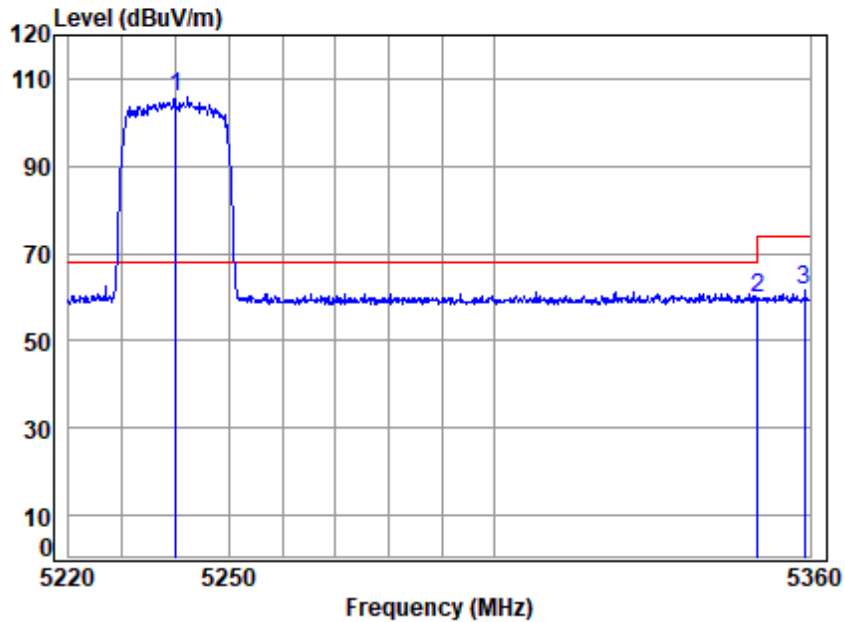

Site : chamber
 Condition: 3m VERTICAL
 Job No : 03018AT\03019AT
 Mode : 5240 Band edge
 : 5G WIFI 11AX20

	Freq	Cable Loss	Ant Factor	Preamp Factor	Read Level	Limit Level	Over Line	Over Limit	Remark
	MHz	dB	dB/m	dB	dBuV	dBuV/m	dBuV/m	dB	
1 p	5240.000	18.96	34.08	35.26	88.00	105.78	68.20	37.58	Peak
2	5350.020	19.11	34.40	35.21	41.55	59.85	74.00	-14.15	Peak
3	5359.007	19.12	34.44	35.20	43.15	61.51	74.00	-12.49	Peak



Unless otherwise agreed in writing, this document is issued by the Company subject to its General Conditions of Service printed overleaf, available on request or accessible at <https://www.sgs.com/en/Terms-and-Conditions>. Attention is drawn to the limitation of liability, indemnification and jurisdiction issues defined therein. Any holder of this document is advised that information contained hereon reflects the Company's findings at the time of its intervention only and within the limits of Client's instructions, if any. The Company's sole responsibility is to its Client and this document does not exonerate parties to a transaction from exercising all their rights and obligations under the transaction documents. This document cannot be reproduced except in full, without prior written approval of the Company. Any unauthorized alteration, forgery or falsification of the content or appearance of this document is unlawful and offenders may be prosecuted to the fullest extent of the law. Unless otherwise stated the results shown in this test report refer only to the sample(s) tested and such sample(s) are retained for 30 days only.

Test Mode: 05; Polarity: Vertical; Modulation:802.11ax(Full RU0); Bandwidth:20MHz; Channel:High

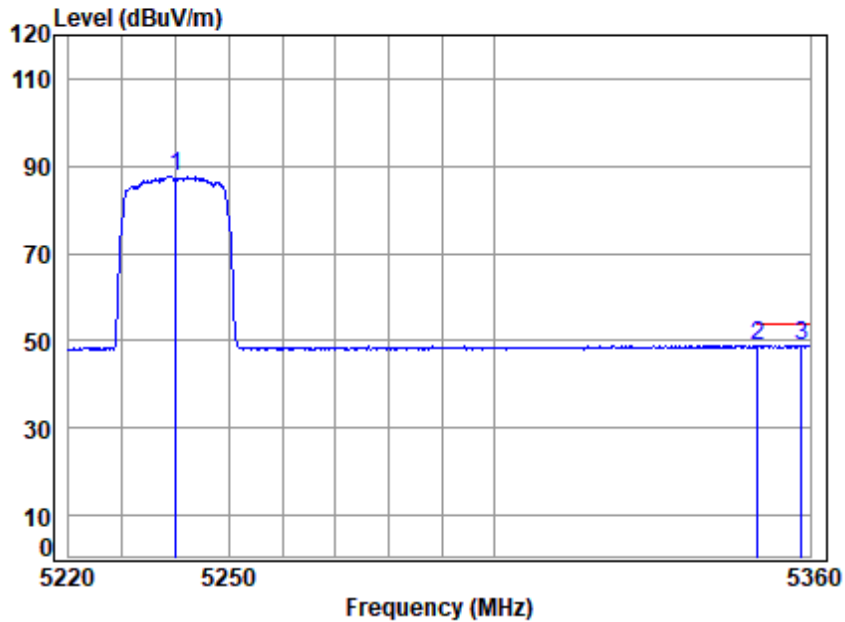

Site : chamber
 Condition: 3m VERTICAL
 Job No : 03018AT\03019AT
 Mode : 5240 Band edge
 : 5G WIFI 11AX20

	Freq	Cable Loss	Ant Factor	Preamp Factor	Read Level	Limit Level	Over Line	Over Limit	Remark
	MHz	dB	dB/m	dB	dBuV	dBuV/m	dBuV/m	dB	
1	5240.000	18.96	34.08	35.26	69.89	87.67	-----	-----	Average
2	5350.020	19.11	34.40	35.21	30.48	48.78	54.00	-5.22	Average
3 q	5358.440	19.12	34.43	35.20	30.67	49.02	54.00	-4.98	Average



Unless otherwise agreed in writing, this document is issued by the Company subject to its General Conditions of Service printed overleaf, available on request or accessible at <https://www.sgs.com/en/Terms-and-Conditions>. Attention is drawn to the limitation of liability, indemnification and jurisdiction issues defined therein. Any holder of this document is advised that information contained hereon reflects the Company's findings at the time of its intervention only and within the limits of Client's instructions, if any. The Company's sole responsibility is to its Client and this document does not exonerate parties to a transaction from exercising all their rights and obligations under the transaction documents. This document cannot be reproduced except in full, without prior written approval of the Company. Any unauthorized alteration, forgery or falsification of the content or appearance of this document is unlawful and offenders may be prosecuted to the fullest extent of the law. Unless otherwise stated the results shown in this test report refer only to the sample(s) tested and such sample(s) are retained for 30 days only.

Test Mode: 05; Polarity: Horizontal; Modulation:802.11ax(26 RU0); Bandwidth:20MHz; Channel:Low

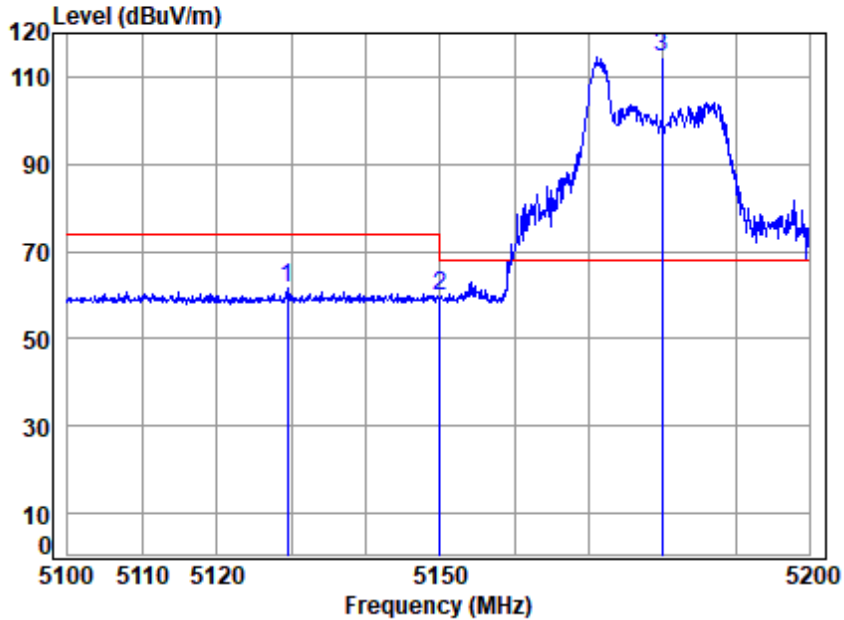

Site : chamber
 Condition: 3m HORIZONTAL
 Job No : 03018AT\03019AT
 Mode : 5180 Band edge

: 5G WIFI 11AX20 Partial RU
 Cable Ant Preamp Read Limit Over
 Freq Loss Factor Factor Level Level Line Limit Remark

	MHz	dB	dB/m	dB	dBuV	dBuV/m	dBuV/m	dB	
1	5129.398	18.80	33.94	35.32	44.16	61.58	74.00	-12.42	peak
2	5149.980	18.83	33.90	35.31	42.40	59.82	74.00	-14.18	peak
3 p	5180.000	18.88	33.96	35.29	97.11	114.66	68.20	46.46	peak



Unless otherwise agreed in writing, this document is issued by the Company subject to its General Conditions of Service printed overleaf, available on request or accessible at <https://www.sgs.com/en/Terms-and-Conditions>. Attention is drawn to the limitation of liability, indemnification and jurisdiction issues defined therein. Any holder of this document is advised that information contained hereon reflects the Company's findings at the time of its intervention only and within the limits of Client's instructions, if any. The Company's sole responsibility is to its Client and this document does not exonerate parties to a transaction from exercising all their rights and obligations under the transaction documents. This document cannot be reproduced except in full, without prior written approval of the Company. Any unauthorized alteration, forgery or falsification of the content or appearance of this document is unlawful and offenders may be prosecuted to the fullest extent of the law. Unless otherwise stated the results shown in this test report refer only to the sample(s) tested and such sample(s) are retained for 30 days only.

Test Mode: 05; Polarity: Horizontal; Modulation:802.11ax(26 RU0); Bandwidth:20MHz; Channel:Low

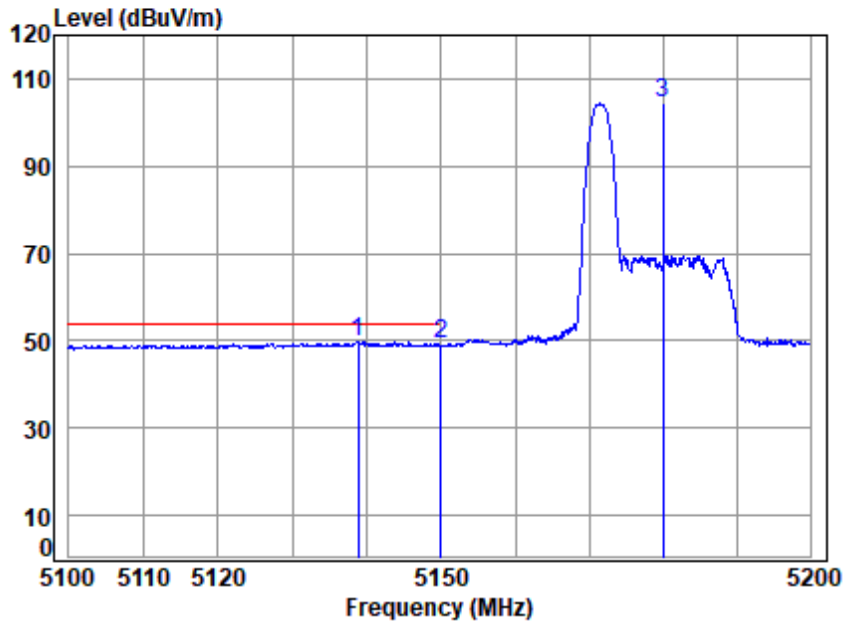

Site : chamber
 Condition: 3m HORIZONTAL
 Job No : 03018AT\03019AT
 Mode : 5180 Band edge

: 5G WIFI 11AX20 Partial RU
 Cable Ant Preamp Read Limit Over
 Freq Loss Factor Factor Level Level Line Limit Remark

	MHz	dB	dB/m	dB	dBuV	dBuV/m	dBuV/m	dB	
1 q	5138.769	18.82	33.92	35.32	32.51	49.93	54.00	-4.07	Average
2	5149.980	18.83	33.90	35.31	31.63	49.05	54.00	-4.95	Average
3	5180.000	18.88	33.96	35.29	86.99	104.54	-----	-----	Average



Unless otherwise agreed in writing, this document is issued by the Company subject to its General Conditions of Service printed overleaf, available on request or accessible at <https://www.sgs.com/en/Terms-and-Conditions>. Attention is drawn to the limitation of liability, indemnification and jurisdiction issues defined therein. Any holder of this document is advised that information contained hereon reflects the Company's findings at the time of its intervention only and within the limits of Client's instructions, if any. The Company's sole responsibility is to its Client and this document does not exonerate parties to a transaction from exercising all their rights and obligations under the transaction documents. This document cannot be reproduced except in full, without prior written approval of the Company. Any unauthorized alteration, forgery or falsification of the content or appearance of this document is unlawful and offenders may be prosecuted to the fullest extent of the law. Unless otherwise stated the results shown in this test report refer only to the sample(s) tested and such sample(s) are retained for 30 days only.

Test Mode: 05; Polarity: Vertical; Modulation:802.11ax(26 RU0); Bandwidth:20MHz; Channel:Low

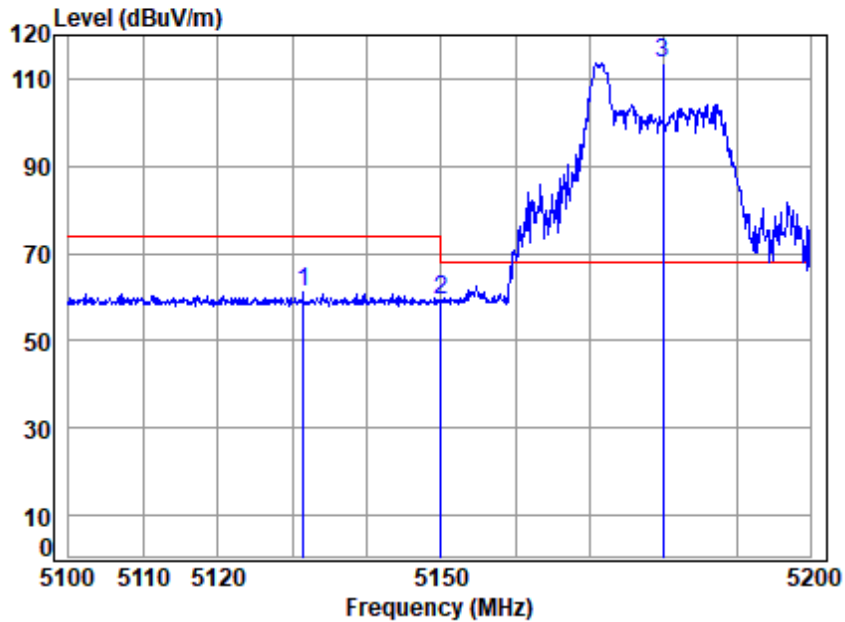

Site : chamber
 Condition: 3m VERTICAL
 Job No : 03018AT\03019AT
 Mode : 5180 Band edge
 : 5G WIFI 11AX20 Partial RU

	Cable	Ant	Preamp	Read	Limit	Over		
Freq	Loss	Factor	Factor	Level	Level	Line	Limit	Remark
MHz	dB	dB/m	dB	dBuV	dBuV/m	dBuV/m	dB	
1	5131.391	18.81	33.94	35.32	43.72	61.15	74.00	-12.85 Peak
2	5149.980	18.83	33.90	35.31	41.93	59.35	74.00	-14.65 Peak
3 p	5180.000	18.88	33.96	35.29	96.11	113.66	68.20	45.46 Peak



Unless otherwise agreed in writing, this document is issued by the Company subject to its General Conditions of Service printed overleaf, available on request or accessible at <https://www.sgs.com/en/Terms-and-Conditions>. Attention is drawn to the limitation of liability, indemnification and jurisdiction issues defined therein. Any holder of this document is advised that information contained hereon reflects the Company's findings at the time of its intervention only and within the limits of Client's instructions, if any. The Company's sole responsibility is to its Client and this document does not exonerate parties to a transaction from exercising all their rights and obligations under the transaction documents. This document cannot be reproduced except in full, without prior written approval of the Company. Any unauthorized alteration, forgery or falsification of the content or appearance of this document is unlawful and offenders may be prosecuted to the fullest extent of the law. Unless otherwise stated the results shown in this test report refer only to the sample(s) tested and such sample(s) are retained for 30 days only.

Test Mode: 05; Polarity: Vertical; Modulation:802.11ax(26 RU0); Bandwidth:20MHz; Channel:Low

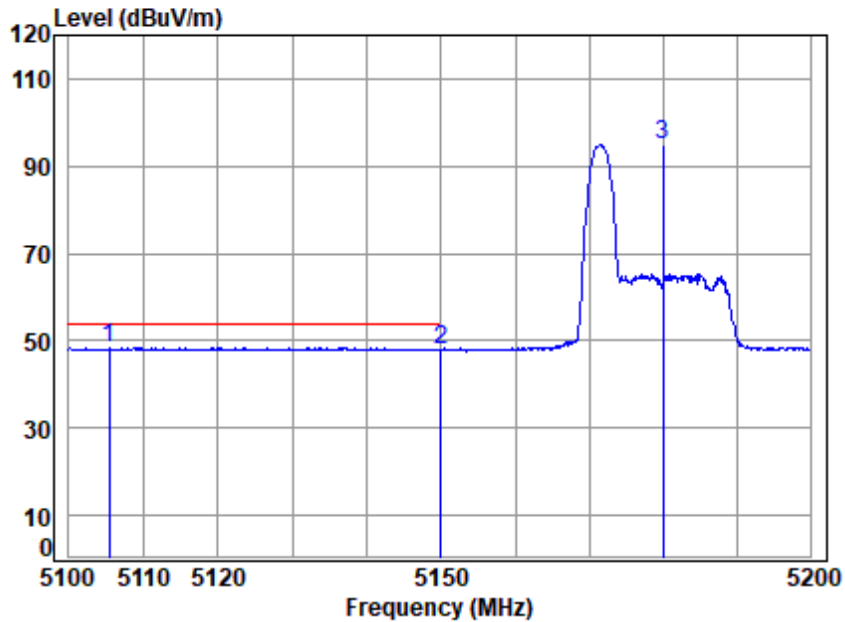

Site : chamber
 Condition: 3m VERTICAL
 Job No : 03018AT\03019AT
 Mode : 5180 Band edge
 : 5G WIFI 11AX20 Partial RU

		Cable	Ant	Preamp	Read	Limit	Over		
Freq	Loss	Factor	Factor	Factor	Level	Level	Line	Limit	Remark
MHz	dB	dB/m	dB	dB	dBuV	dBuV/m	dBuV/m	dB	
1 q 5105.351	18.77	33.99	35.33	30.94	48.37	54.00	-5.63	Average	
2 5149.980	18.83	33.90	35.31	30.62	48.04	54.00	-5.96	Average	
3 5180.000	18.88	33.96	35.29	77.47	95.02	-----	-----	Average	



Unless otherwise agreed in writing, this document is issued by the Company subject to its General Conditions of Service printed overleaf, available on request or accessible at <https://www.sgs.com/en/Terms-and-Conditions>. Attention is drawn to the limitation of liability, indemnification and jurisdiction issues defined therein. Any holder of this document is advised that information contained hereon reflects the Company's findings at the time of its intervention only and within the limits of Client's instructions, if any. The Company's sole responsibility is to its Client and this document does not exonerate parties to a transaction from exercising all their rights and obligations under the transaction documents. This document cannot be reproduced except in full, without prior written approval of the Company. Any unauthorized alteration, forgery or falsification of the content or appearance of this document is unlawful and offenders may be prosecuted to the fullest extent of the law. Unless otherwise stated the results shown in this test report refer only to the sample(s) tested and such sample(s) are retained for 30 days only.

Test Mode: 05; Polarity: Horizontal; Modulation:802.11ax(26 RU0); Bandwidth:20MHz; Channel:High

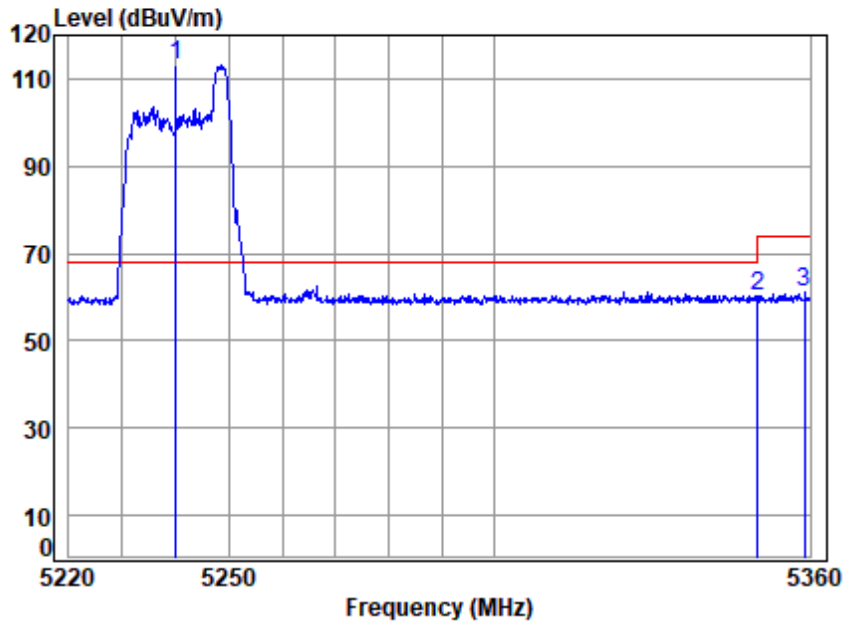

Site	: chamber						
Condition:	3m HORIZONTAL						
Job No	: 03018AT\03019AT						
Mode	: 5240 Band edge						
	: 5G WIFI 11AX20 Partial RU						
	Cable	Ant	Preamp	Read	Limit	Over	
Freq	Loss	Factor	Factor	Level	Level	Line	Limit Remark
	dB	dB/m	dB	dBuV	dBuV/m	dBuV/m	dB
1 p	18.96	34.08	35.26	95.27	113.05	68.20	44.85 peak
2	19.11	34.40	35.21	41.85	60.15	74.00	-13.85 peak
3	19.12	34.44	35.20	42.63	60.99	74.00	-13.01 peak



Unless otherwise agreed in writing, this document is issued by the Company subject to its General Conditions of Service printed overleaf, available on request or accessible at <https://www.sgs.com/en/Terms-and-Conditions>. Attention is drawn to the limitation of liability, indemnification and jurisdiction issues defined therein. Any holder of this document is advised that information contained hereon reflects the Company's findings at the time of its intervention only and within the limits of Client's instructions, if any. The Company's sole responsibility is to its Client and this document does not exonerate parties to a transaction from exercising all their rights and obligations under the transaction documents. This document cannot be reproduced except in full, without prior written approval of the Company. Any unauthorized alteration, forgery or falsification of the content or appearance of this document is unlawful and offenders may be prosecuted to the fullest extent of the law. Unless otherwise stated the results shown in this test report refer only to the sample(s) tested and such sample(s) are retained for 30 days only.

Test Mode: 05; Polarity: Horizontal; Modulation:802.11ax(26 RU0); Bandwidth:20MHz; Channel:High

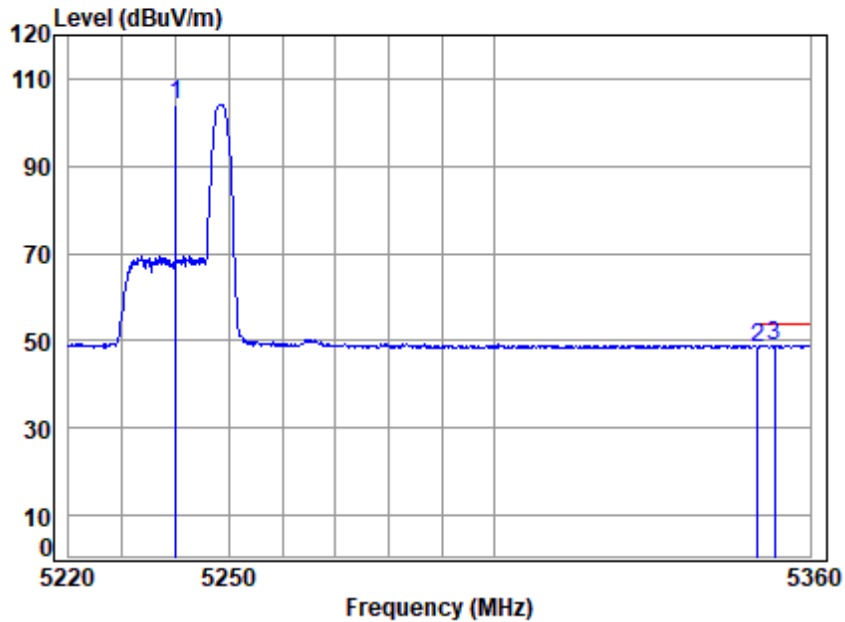

Site : chamber
 Condition: 3m HORIZONTAL
 Job No : 03018AT\03019AT
 Mode : 5240 Band edge
 : 5G WIFI 11AX20 Partial RU

	Freq	Cable Loss	Ant Factor	Preamp Factor	Read Level	Limit Level	Over Line	Over Limit	Remark
	MHz	dB	dB/m	dB	dBuV	dBuV/m	dBuV/m	dB	
1	5240.000	18.96	34.08	35.26	86.47	104.25	-----	-----	Average
2	5350.020	19.11	34.40	35.21	30.25	48.55	54.00	-5.45	Average
3 q	5353.195	19.11	34.41	35.21	30.71	49.02	54.00	-4.98	Average



Unless otherwise agreed in writing, this document is issued by the Company subject to its General Conditions of Service printed overleaf, available on request or accessible at <https://www.sgs.com/en/Terms-and-Conditions>. Attention is drawn to the limitation of liability, indemnification and jurisdiction issues defined therein. Any holder of this document is advised that information contained hereon reflects the Company's findings at the time of its intervention only and within the limits of Client's instructions, if any. The Company's sole responsibility is to its Client and this document does not exonerate parties to a transaction from exercising all their rights and obligations under the transaction documents. This document cannot be reproduced except in full, without prior written approval of the Company. Any unauthorized alteration, forgery or falsification of the content or appearance of this document is unlawful and offenders may be prosecuted to the fullest extent of the law. Unless otherwise stated the results shown in this test report refer only to the sample(s) tested and such sample(s) are retained for 30 days only.

Test Mode: 05; Polarity: Vertical; Modulation:802.11ax(26 RU0); Bandwidth:20MHz; Channel:High

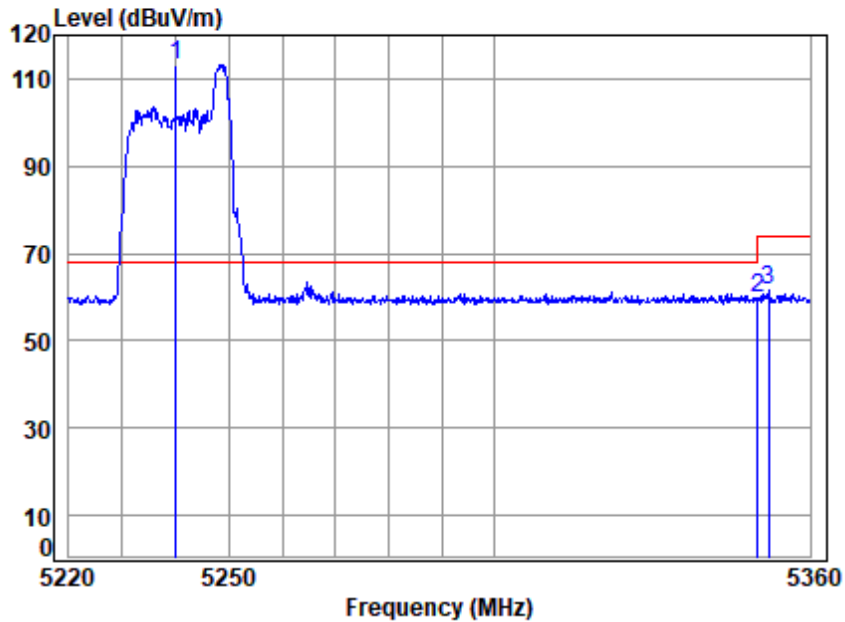

Site : chamber
 Condition: 3m VERTICAL
 Job No : 03018AT\03019AT
 Mode : 5240 Band edge
 : 5G WIFI 11AX20 Partial RU

	Cable	Ant	Preamp	Read	Limit	Over	
Freq	Loss	Factor	Factor	Level	Level	Line	Limit Remark
MHz	dB	dB/m	dB	dBuV	dBuV/m	dBuV/m	dB
1 p 5240.000	18.96	34.08	35.26	95.46	113.24	68.20	45.04 Peak
2 5350.020	19.11	34.40	35.21	41.33	59.63	74.00	-14.37 Peak
3 5352.062	19.11	34.41	35.21	43.16	61.47	74.00	-12.53 Peak



Unless otherwise agreed in writing, this document is issued by the Company subject to its General Conditions of Service printed overleaf, available on request or accessible at <https://www.sgs.com/en/Terms-and-Conditions>. Attention is drawn to the limitation of liability, indemnification and jurisdiction issues defined therein. Any holder of this document is advised that information contained hereon reflects the Company's findings at the time of its intervention only and within the limits of Client's instructions, if any. The Company's sole responsibility is to its Client and this document does not exonerate parties to a transaction from exercising all their rights and obligations under the transaction documents. This document cannot be reproduced except in full, without prior written approval of the Company. Any unauthorized alteration, forgery or falsification of the content or appearance of this document is unlawful and offenders may be prosecuted to the fullest extent of the law. Unless otherwise stated the results shown in this test report refer only to the sample(s) tested and such sample(s) are retained for 30 days only.

Attention: To check the authenticity of testing /inspection report & certificate, please contact us at telephone: (86-755) 8307 1443, or email: CN.Doccheck@sgs.com

SGS-CSTC Standards Technical Services Co., Ltd. Shenzhen Branch
 No.1 Workshop, M-10, Middle Section, Science & Technology Park, Nanshan District, Shenzhen, Guangdong, China 518057 t (86-755) 26012053 f (86-755) 26710594 www.sgs.com.cn
 中国·广东·深圳市南山区科技园中区M-10栋1号厂房 邮编: 518057 t (86-755) 26012053 f (86-755) 26710594 sgs.china@sgs.com

Test Mode: 05; Polarity: Vertical; Modulation:802.11ax(26 RU0); Bandwidth:20MHz; Channel:High

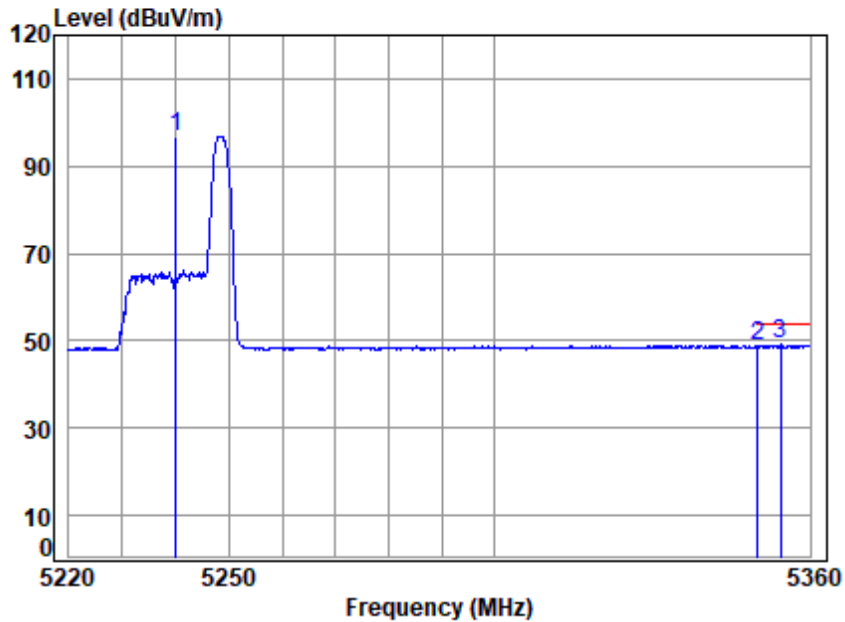

Site : chamber
 Condition: 3m VERTICAL
 Job No : 03018AT\03019AT
 Mode : 5240 Band edge

: 5G WIFI 11AX20 Partial RU
 Cable Ant Preamp Read Limit Over
 Freq Loss Factor Factor Level Level Line Limit Remark

	MHz	dB	dB/m	dB	dBuV	dBuV/m	dBuV/m	dB	
1	5240.000	18.96	34.08	35.26	78.97	96.75	-----	-----	Average
2	5350.020	19.11	34.40	35.21	30.40	48.70	54.00	-5.30	Average
3 q	5354.329	19.12	34.42	35.21	30.79	49.12	54.00	-4.88	Average



Unless otherwise agreed in writing, this document is issued by the Company subject to its General Conditions of Service printed overleaf, available on request or accessible at <https://www.sgs.com/en/Terms-and-Conditions>. Attention is drawn to the limitation of liability, indemnification and jurisdiction issues defined therein. Any holder of this document is advised that information contained hereon reflects the Company's findings at the time of its intervention only and within the limits of Client's instructions, if any. The Company's sole responsibility is to its Client and this document does not exonerate parties to a transaction from exercising all their rights and obligations under the transaction documents. This document cannot be reproduced except in full, without prior written approval of the Company. Any unauthorized alteration, forgery or falsification of the content or appearance of this document is unlawful and offenders may be prosecuted to the fullest extent of the law. Unless otherwise stated the results shown in this test report refer only to the sample(s) tested and such sample(s) are retained for 30 days only.

Test Mode: 06; Polarity: Horizontal; Modulation:802.11a; Bandwidth:20MHz; Channel:Low

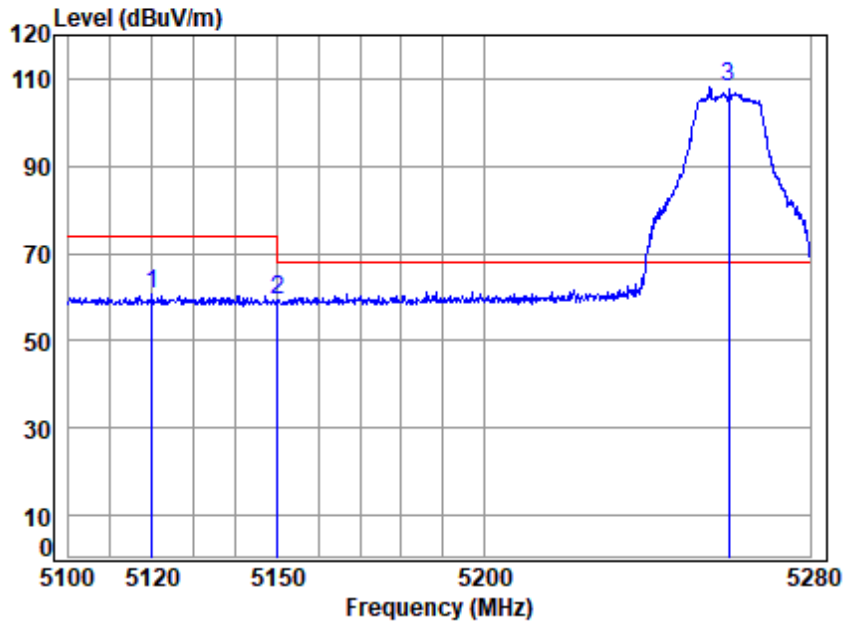

Site : chamber
 Condition: 3m HORIZONTAL
 Job No : 03018AT\03019AT
 Mode : 5260 Band edge
 : 5G WIFI 11A

	Freq	Cable Loss	Ant Factor	Preamp Factor	Read Level	Limit Level	Over Limit	Remark
	MHz	dB	dB/m	dB	dBuV	dBuV/m	dBuV/m	dB
1	5120.028	18.79	33.96	35.33	43.45	60.87	74.00	-13.13 peak
2	5149.980	18.83	33.90	35.31	41.87	59.29	74.00	-14.71 peak
3 p	5260.000	18.99	34.12	35.25	90.13	107.99	68.20	39.79 peak



Unless otherwise agreed in writing, this document is issued by the Company subject to its General Conditions of Service printed overleaf, available on request or accessible at <https://www.sgs.com/en/Terms-and-Conditions>. Attention is drawn to the limitation of liability, indemnification and jurisdiction issues defined therein. Any holder of this document is advised that information contained hereon reflects the Company's findings at the time of its intervention only and within the limits of Client's instructions, if any. The Company's sole responsibility is to its Client and this document does not exonerate parties to a transaction from exercising all their rights and obligations under the transaction documents. This document cannot be reproduced except in full, without prior written approval of the Company. Any unauthorized alteration, forgery or falsification of the content or appearance of this document is unlawful and offenders may be prosecuted to the fullest extent of the law. Unless otherwise stated the results shown in this test report refer only to the sample(s) tested and such sample(s) are retained for 30 days only.

Test Mode: 06; Polarity: Horizontal; Modulation:802.11a; Bandwidth:20MHz; Channel:Low

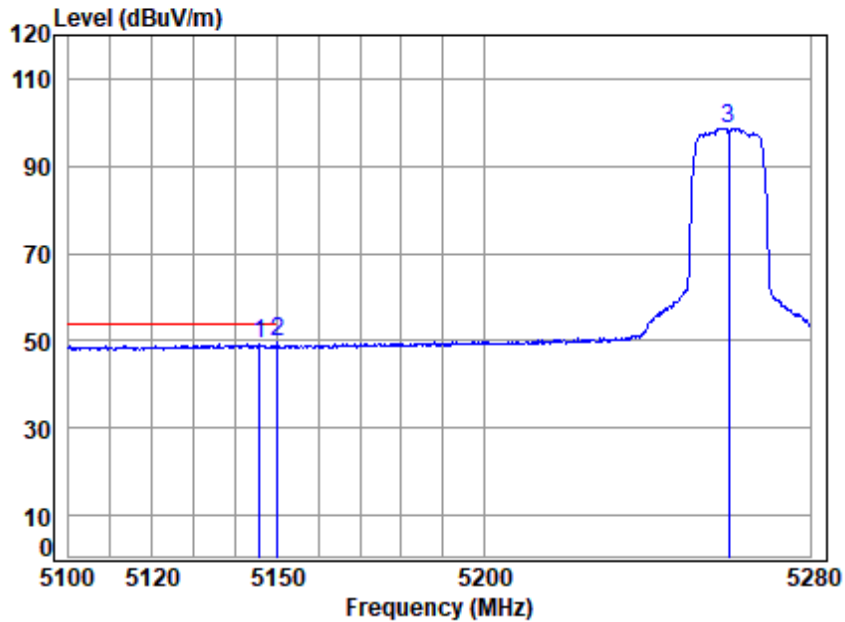

Site : chamber
 Condition: 3m HORIZONTAL
 Job No : 03018AT\03019AT
 Mode : 5260 Band edge
 : 5G WIFI 11A

	Freq	Cable Loss	Ant Factor	Preamp Factor	Read Level	Limit Level	Over Limit	Remark
	MHz	dB	dB/m	dB	dBuV	dBuV/m	dBuV/m	dB
1	5145.666	18.83	33.91	35.31	31.66	49.09	54.00	-4.91 Average
2 q	5149.980	18.83	33.90	35.31	32.23	49.65	54.00	-4.35 Average
3	5260.000	18.99	34.12	35.25	80.90	98.76	-----	----- Average



Unless otherwise agreed in writing, this document is issued by the Company subject to its General Conditions of Service printed overleaf, available on request or accessible at <https://www.sgs.com/en/Terms-and-Conditions>. Attention is drawn to the limitation of liability, indemnification and jurisdiction issues defined therein. Any holder of this document is advised that information contained hereon reflects the Company's findings at the time of its intervention only and within the limits of Client's instructions, if any. The Company's sole responsibility is to its Client and this document does not exonerate parties to a transaction from exercising all their rights and obligations under the transaction documents. This document cannot be reproduced except in full, without prior written approval of the Company. Any unauthorized alteration, forgery or falsification of the content or appearance of this document is unlawful and offenders may be prosecuted to the fullest extent of the law. Unless otherwise stated the results shown in this test report refer only to the sample(s) tested and such sample(s) are retained for 30 days only.

Test Mode: 06; Polarity: Vertical; Modulation:802.11a; Bandwidth:20MHz; Channel:Low

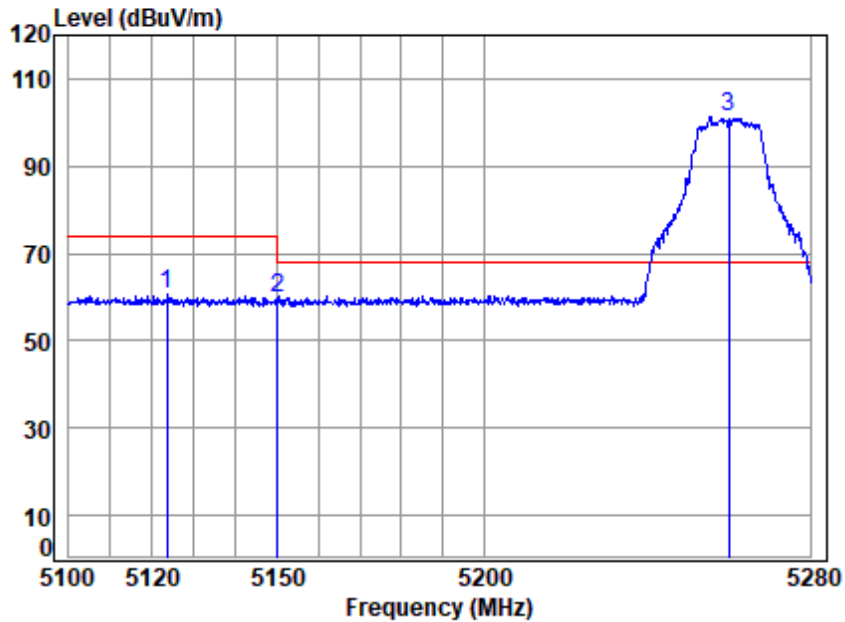

Site : chamber
 Condition: 3m VERTICAL
 Job No : 03018AT\03019AT
 Mode : 5260 Band edge
 : 5G WIFI 11A

	Freq	Cable Loss	Ant Factor	Preamp Factor	Read Level	Limit Level	Over Line	Remark
	MHz	dB	dB/m	dB	dBuV	dBuV/m	dBuV/m	dB
1	5123.582	18.80	33.95	35.32	43.37	60.80	74.00	-13.20 Peak
2	5149.980	18.83	33.90	35.31	42.26	59.68	74.00	-14.32 Peak
3 p	5260.000	18.99	34.12	35.25	83.63	101.49	68.20	33.29 Peak



Unless otherwise agreed in writing, this document is issued by the Company subject to its General Conditions of Service printed overleaf, available on request or accessible at <https://www.sgs.com/en/Terms-and-Conditions>. Attention is drawn to the limitation of liability, indemnification and jurisdiction issues defined therein. Any holder of this document is advised that information contained hereon reflects the Company's findings at the time of its intervention only and within the limits of Client's instructions, if any. The Company's sole responsibility is to its Client and this document does not exonerate parties to a transaction from exercising all their rights and obligations under the transaction documents. This document cannot be reproduced except in full, without prior written approval of the Company. Any unauthorized alteration, forgery or falsification of the content or appearance of this document is unlawful and offenders may be prosecuted to the fullest extent of the law. Unless otherwise stated the results shown in this test report refer only to the sample(s) tested and such sample(s) are retained for 30 days only.

Test Mode: 06; Polarity: Vertical; Modulation:802.11a; Bandwidth:20MHz; Channel:Low

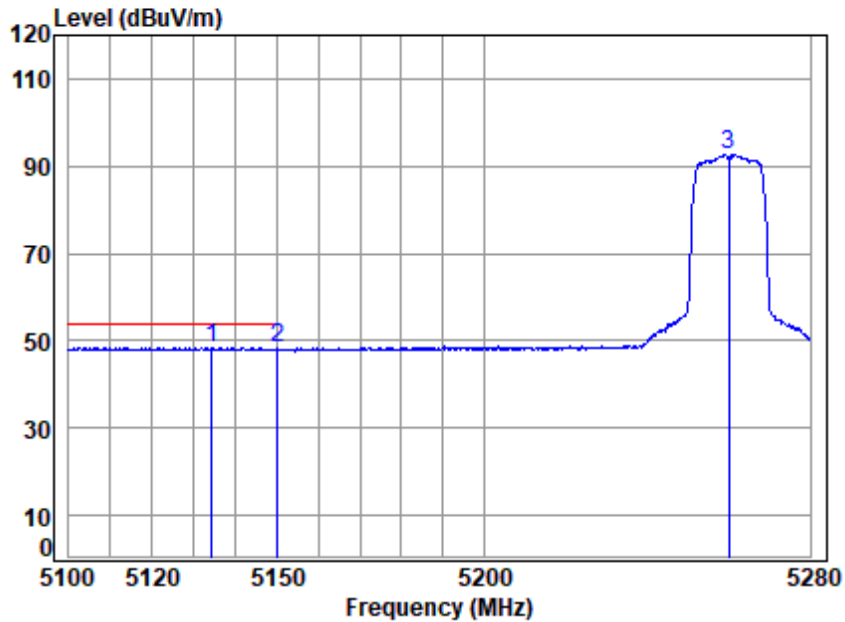

Site : chamber
 Condition: 3m VERTICAL
 Job No : 03018AT\03019AT
 Mode : 5260 Band edge
 : 5G WIFI 11A

		Cable	Ant	Preamp	Read	Limit	Over		
	Freq	Loss	Factor	Factor	Level	Level	Line	Limit	Remark
	MHz	dB	dB/m	dB	dBuV	dBuV/m	dBuV/m	dB	
1	q 5134.255	18.81	33.93	35.32	31.11	48.53	54.00	-5.47	Average
2	5149.980	18.83	33.90	35.31	30.82	48.24	54.00	-5.76	Average
3	5260.000	18.99	34.12	35.25	74.67	92.53	-----	-----	Average



Unless otherwise agreed in writing, this document is issued by the Company subject to its General Conditions of Service printed overleaf, available on request or accessible at <https://www.sgs.com/en/Terms-and-Conditions>. Attention is drawn to the limitation of liability, indemnification and jurisdiction issues defined therein. Any holder of this document is advised that information contained hereon reflects the Company's findings at the time of its intervention only and within the limits of Client's instructions, if any. The Company's sole responsibility is to its Client and this document does not exonerate parties to a transaction from exercising all their rights and obligations under the transaction documents. This document cannot be reproduced except in full, without prior written approval of the Company. Any unauthorized alteration, forgery or falsification of the content or appearance of this document is unlawful and offenders may be prosecuted to the fullest extent of the law. Unless otherwise stated the results shown in this test report refer only to the sample(s) tested and such sample(s) are retained for 30 days only.

Test Mode: 06; Polarity: Horizontal; Modulation:802.11a; Bandwidth:20MHz; Channel:High

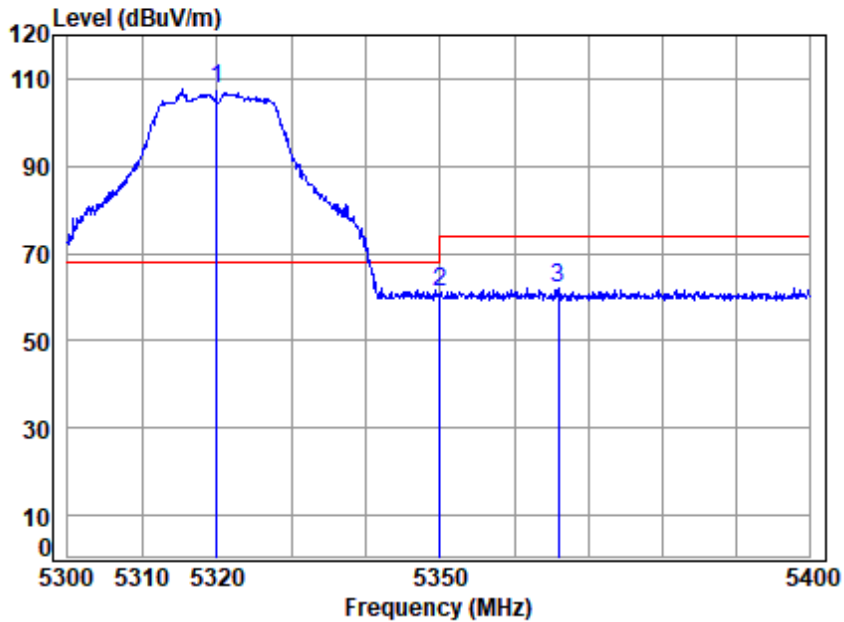

Site : chamber
 Condition: 3m HORIZONTAL
 Job No : 03018AT\03019AT
 Mode : 5320 Band edge
 : 5G WIFI 11A

		Cable	Ant	Preamp	Read	Limit	Over	
Freq	Loss	Factor	Factor	Factor	Level	Line	Limit	Remark
MHz	dB	dB/m	dB	dBuV	dBuV/m	dBuV/m	dB	
1 p 5320.000	19.07	34.28	35.22	89.36	107.49	68.20	39.29	peak
2 5350.020	19.11	34.40	35.21	43.00	61.30	74.00	-12.70	peak
3 5365.991	19.13	34.46	35.20	43.72	62.11	74.00	-11.89	peak



Unless otherwise agreed in writing, this document is issued by the Company subject to its General Conditions of Service printed overleaf, available on request or accessible at <https://www.sgs.com/en/Terms-and-Conditions>. Attention is drawn to the limitation of liability, indemnification and jurisdiction issues defined therein. Any holder of this document is advised that information contained hereon reflects the Company's findings at the time of its intervention only and within the limits of Client's instructions, if any. The Company's sole responsibility is to its Client and this document does not exonerate parties to a transaction from exercising all their rights and obligations under the transaction documents. This document cannot be reproduced except in full, without prior written approval of the Company. Any unauthorized alteration, forgery or falsification of the content or appearance of this document is unlawful and offenders may be prosecuted to the fullest extent of the law. Unless otherwise stated the results shown in this test report refer only to the sample(s) tested and such sample(s) are retained for 30 days only.

Test Mode: 06; Polarity: Horizontal; Modulation:802.11a; Bandwidth:20MHz; Channel:High

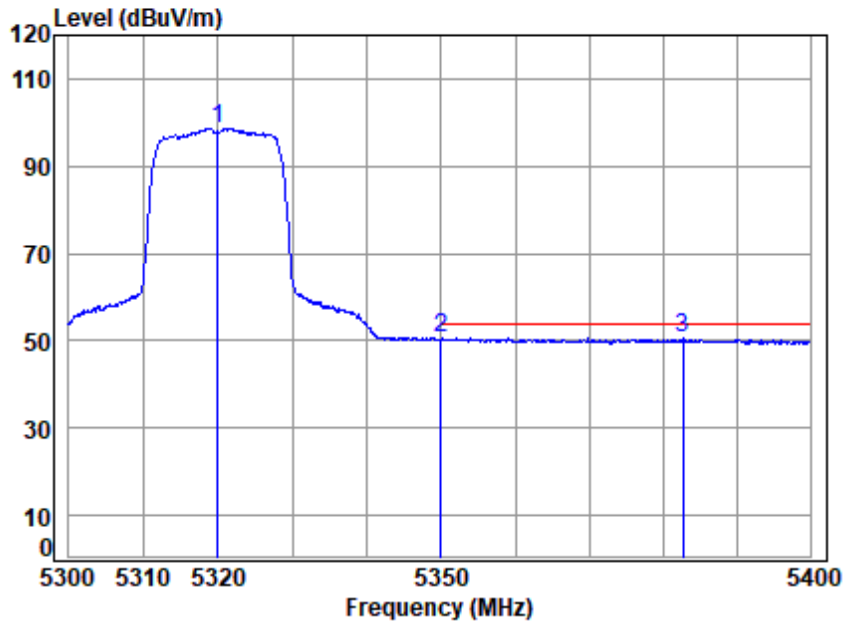

Site : chamber
 Condition: 3m HORIZONTAL
 Job No : 03018AT\03019AT
 Mode : 5320 Band edge
 : 5G WIFI 11A

		Cable	Ant	Preamp	Read	Limit	Over	
Freq	Loss	Factor	Factor	Factor	Level	Level	Line	Limit Remark
MHz	dB	dB/m	dB	dB	dBuV	dBuV/m	dBuV/m	dB
1	5320.000	19.07	34.28	35.22	80.46	98.59	-----	----- Average
2	5350.020	19.11	34.40	35.21	32.17	50.47	54.00	-3.53 Average
3 q	5382.767	19.15	34.53	35.19	32.03	50.52	54.00	-3.48 Average



Unless otherwise agreed in writing, this document is issued by the Company subject to its General Conditions of Service printed overleaf, available on request or accessible at <https://www.sgs.com/en/Terms-and-Conditions>. Attention is drawn to the limitation of liability, indemnification and jurisdiction issues defined therein. Any holder of this document is advised that information contained hereon reflects the Company's findings at the time of its intervention only and within the limits of Client's instructions, if any. The Company's sole responsibility is to its Client and this document does not exonerate parties to a transaction from exercising all their rights and obligations under the transaction documents. This document cannot be reproduced except in full, without prior written approval of the Company. Any unauthorized alteration, forgery or falsification of the content or appearance of this document is unlawful and offenders may be prosecuted to the fullest extent of the law. Unless otherwise stated the results shown in this test report refer only to the sample(s) tested and such sample(s) are retained for 30 days only.

Test Mode: 06; Polarity: Vertical; Modulation:802.11a; Bandwidth:20MHz; Channel:High

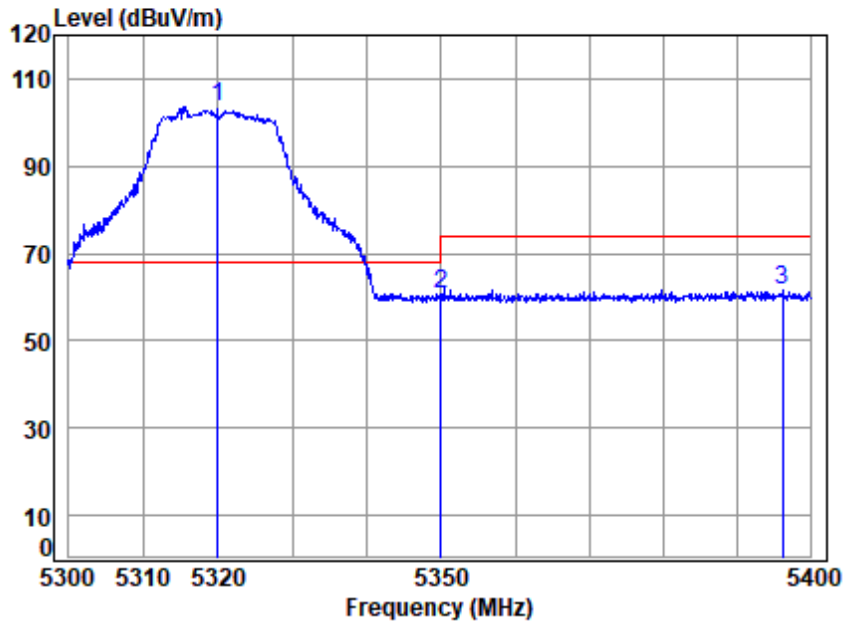

Site : chamber
 Condition: 3m VERTICAL
 Job No : 03018AT\03019AT
 Mode : 5320 Band edge
 : 5G WIFI 11A

		Cable	Ant	Preamp	Read	Limit	Over	
Freq	Loss	Factor	Factor	Factor	Level	Level	Line	Limit Remark
MHz	dB	dB/m	dB	dB	dBuV	dBuV/m	dBuV/m	dB
1 p 5320.000	19.07	34.28	35.22	85.54	103.67	68.20	35.47	Peak
2 5350.020	19.11	34.40	35.21	42.17	60.47	74.00	-13.53	Peak
3 5396.267	19.17	34.59	35.19	43.15	61.72	74.00	-12.28	Peak



Unless otherwise agreed in writing, this document is issued by the Company subject to its General Conditions of Service printed overleaf, available on request or accessible at <https://www.sgs.com/en/Terms-and-Conditions>. Attention is drawn to the limitation of liability, indemnification and jurisdiction issues defined therein. Any holder of this document is advised that information contained hereon reflects the Company's findings at the time of its intervention only and within the limits of Client's instructions, if any. The Company's sole responsibility is to its Client and this document does not exonerate parties to a transaction from exercising all their rights and obligations under the transaction documents. This document cannot be reproduced except in full, without prior written approval of the Company. Any unauthorized alteration, forgery or falsification of the content or appearance of this document is unlawful and offenders may be prosecuted to the fullest extent of the law. Unless otherwise stated the results shown in this test report refer only to the sample(s) tested and such sample(s) are retained for 30 days only.

Test Mode: 06; Polarity: Vertical; Modulation:802.11a; Bandwidth:20MHz; Channel:High

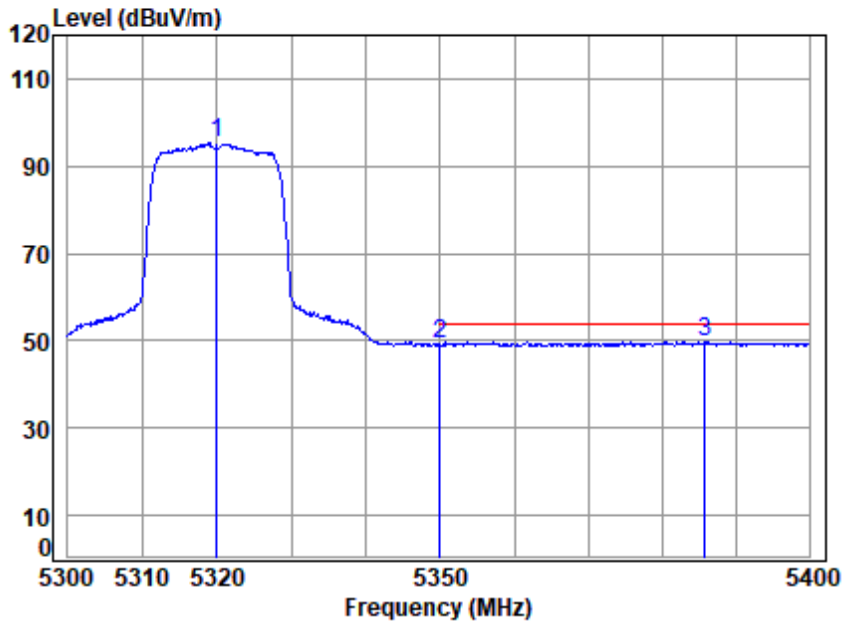

Site : chamber
 Condition: 3m VERTICAL
 Job No : 03018AT\03019AT
 Mode : 5320 Band edge
 : 5G WIFI 11A

	Freq	Cable Loss	Ant Factor	Preamp Factor	Read Level	Limit Level	Over Line	Over Limit	Remark
	MHz	dB	dB/m	dB	dBuV	dBuV/m	dBuV/m	dB	
1	5320.000	19.07	34.28	35.22	77.15	95.28	-----	-----	Average
2	5350.020	19.11	34.40	35.21	31.09	49.39	54.00	-4.61	Average
3 q	5385.887	19.16	34.54	35.19	31.23	49.74	54.00	-4.26	Average



Test Mode: 06; Polarity: Horizontal; Modulation:802.11ac; Bandwidth:20MHz; Channel:Low

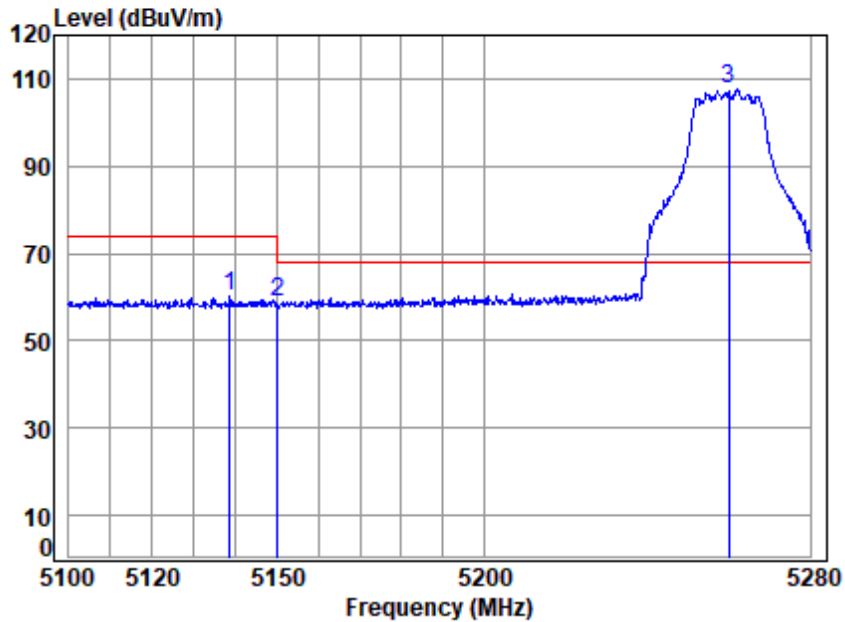

Site : chamber
 Condition: 3m HORIZONTAL
 Job No : 03018AT\03019AT
 Mode : 5260 Band edge
 : 5G WIFI 11AC20

	Cable	Ant	Preamp	Read	Limit	Over		
Freq	Loss	Factor	Factor	Level	Level	Line	Limit	Remark
MHz	dB	dB/m	dB	dBuV	dBuV/m	dBuV/m	dB	
1	5138.531	18.82	33.92	31.27	38.81	60.28	74.00	-13.72 peak
2	5149.980	18.83	33.90	31.28	37.28	58.73	74.00	-15.27 peak
3 p	5260.000	18.99	34.12	31.34	85.76	107.53	68.20	39.33 peak



Unless otherwise agreed in writing, this document is issued by the Company subject to its General Conditions of Service printed overleaf, available on request or accessible at <https://www.sgs.com/en/Terms-and-Conditions>. Attention is drawn to the limitation of liability, indemnification and jurisdiction issues defined therein. Any holder of this document is advised that information contained hereon reflects the Company's findings at the time of its intervention only and within the limits of Client's instructions, if any. The Company's sole responsibility is to its Client and this document does not exonerate parties to a transaction from exercising all their rights and obligations under the transaction documents. This document cannot be reproduced except in full, without prior written approval of the Company. Any unauthorized alteration, forgery or falsification of the content or appearance of this document is unlawful and offenders may be prosecuted to the fullest extent of the law. Unless otherwise stated the results shown in this test report refer only to the sample(s) tested and such sample(s) are retained for 30 days only.

Test Mode: 06; Polarity: Horizontal; Modulation:802.11ac; Bandwidth:20MHz; Channel:Low

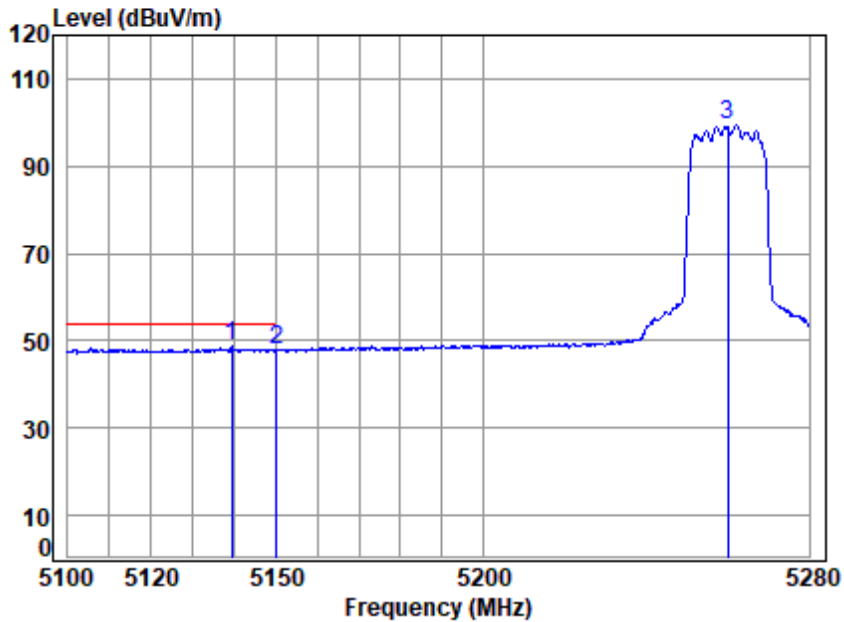

Site : chamber
 Condition: 3m HORIZONTAL
 Job No : 03018AT\03019AT
 Mode : 5260 Band edge
 : 5G WIFI 11AC20

		Cable	Ant	Preamp	Read	Limit	Over	
Freq	Loss	Factor	Factor	Factor	Level	Line	Limit	Remark
MHz	dB	dB/m	dB	dB	dBuV	dBuV/m	dBuV/m	dB
1 q 5139.244	18.82	33.92	31.28	27.14	48.60	54.00	-5.40	Average
2 5149.980	18.83	33.90	31.28	26.37	47.82	54.00	-6.18	Average
3 5260.000	18.99	34.12	31.34	77.72	99.49	-----	-----	Average



Unless otherwise agreed in writing, this document is issued by the Company subject to its General Conditions of Service printed overleaf, available on request or accessible at <https://www.sgs.com/en/Terms-and-Conditions>. Attention is drawn to the limitation of liability, indemnification and jurisdiction issues defined therein. Any holder of this document is advised that information contained hereon reflects the Company's findings at the time of its intervention only and within the limits of Client's instructions, if any. The Company's sole responsibility is to its Client and this document does not exonerate parties to a transaction from exercising all their rights and obligations under the transaction documents. This document cannot be reproduced except in full, without prior written approval of the Company. Any unauthorized alteration, forgery or falsification of the content or appearance of this document is unlawful and offenders may be prosecuted to the fullest extent of the law. Unless otherwise stated the results shown in this test report refer only to the sample(s) tested and such sample(s) are retained for 30 days only.

Test Mode: 06; Polarity: Vertical; Modulation:802.11ac; Bandwidth:20MHz; Channel:Low

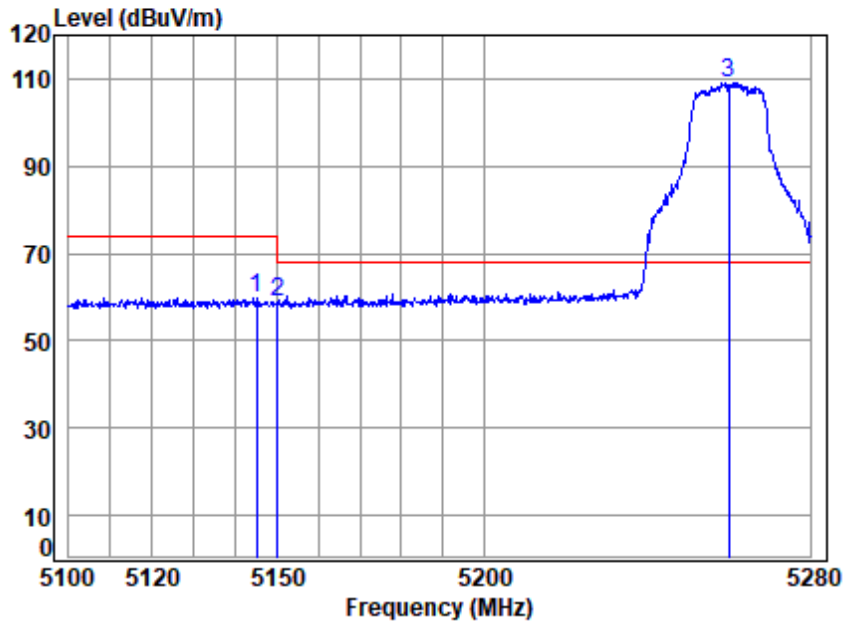

Site : chamber
 Condition: 3m VERTICAL
 Job No : 03018AT\03019AT
 Mode : 5260 Band edge
 : 5G WIFI 11AC20

	Freq	Cable Loss	Ant Factor	Preamp Factor	Read Level	Limit Level	Over Line	Remark
	MHz	dB	dB/m	dB	dBuV	dBuV/m	dBuV/m	dB
1	5144.952	18.83	33.91	31.28	38.34	59.80	74.00	-14.20 Peak
2	5149.980	18.83	33.90	31.28	37.37	58.82	74.00	-15.18 Peak
3 p	5260.000	18.99	34.12	31.34	87.33	109.10	68.20	40.90 Peak



Unless otherwise agreed in writing, this document is issued by the Company subject to its General Conditions of Service printed overleaf, available on request or accessible at <https://www.sgs.com/en/Terms-and-Conditions>. Attention is drawn to the limitation of liability, indemnification and jurisdiction issues defined therein. Any holder of this document is advised that information contained hereon reflects the Company's findings at the time of its intervention only and within the limits of Client's instructions, if any. The Company's sole responsibility is to its Client and this document does not exonerate parties to a transaction from exercising all their rights and obligations under the transaction documents. This document cannot be reproduced except in full, without prior written approval of the Company. Any unauthorized alteration, forgery or falsification of the content or appearance of this document is unlawful and offenders may be prosecuted to the fullest extent of the law. Unless otherwise stated the results shown in this test report refer only to the sample(s) tested and such sample(s) are retained for 30 days only.

Test Mode: 06; Polarity: Vertical; Modulation:802.11ac; Bandwidth:20MHz; Channel:Low

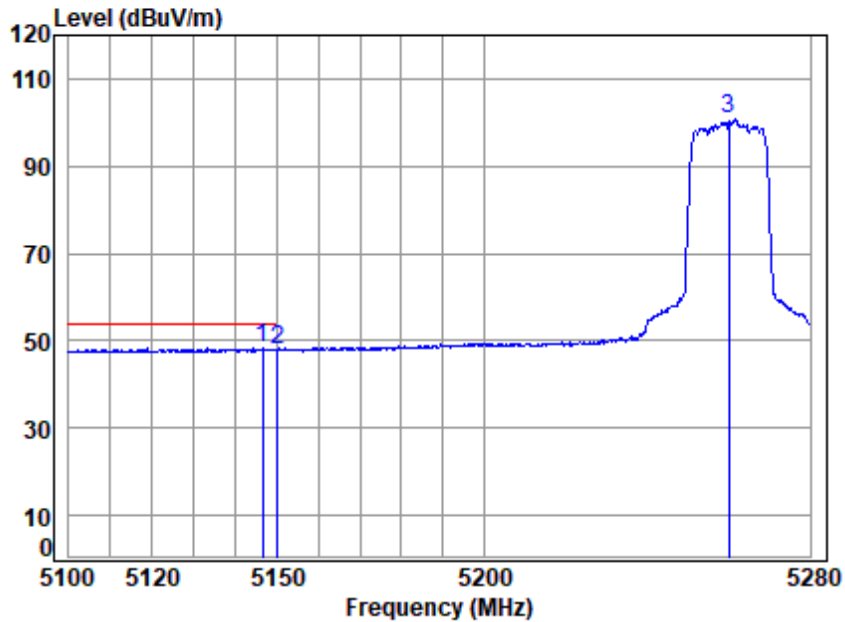

Site : chamber
 Condition: 3m VERTICAL
 Job No : 03018AT\03019AT
 Mode : 5260 Band edge
 : 5G WIFI 11AC20

		Cable	Ant	Preamp	Read	Limit	Over		
	Freq	Loss	Factor	Factor	Level	Line	Limit	Remark	
	MHz	dB	dB/m	dB	dBuV	dBuV/m	dBuV/m	dB	
1	q 5146.558	18.83	33.91	31.28	26.97	48.43	54.00	-5.57	Average
2	5149.980	18.83	33.90	31.28	26.54	47.99	54.00	-6.01	Average
3	5260.000	18.99	34.12	31.34	78.98	100.75	-----	-----	Average



Unless otherwise agreed in writing, this document is issued by the Company subject to its General Conditions of Service printed overleaf, available on request or accessible at <https://www.sgs.com/en/Terms-and-Conditions>. Attention is drawn to the limitation of liability, indemnification and jurisdiction issues defined therein. Any holder of this document is advised that information contained hereon reflects the Company's findings at the time of its intervention only and within the limits of Client's instructions, if any. The Company's sole responsibility is to its Client and this document does not exonerate parties to a transaction from exercising all their rights and obligations under the transaction documents. This document cannot be reproduced except in full, without prior written approval of the Company. Any unauthorized alteration, forgery or falsification of the content or appearance of this document is unlawful and offenders may be prosecuted to the fullest extent of the law. Unless otherwise stated the results shown in this test report refer only to the sample(s) tested and such sample(s) are retained for 30 days only.

Test Mode: 06; Polarity: Horizontal; Modulation:802.11ac; Bandwidth:20MHz; Channel:High

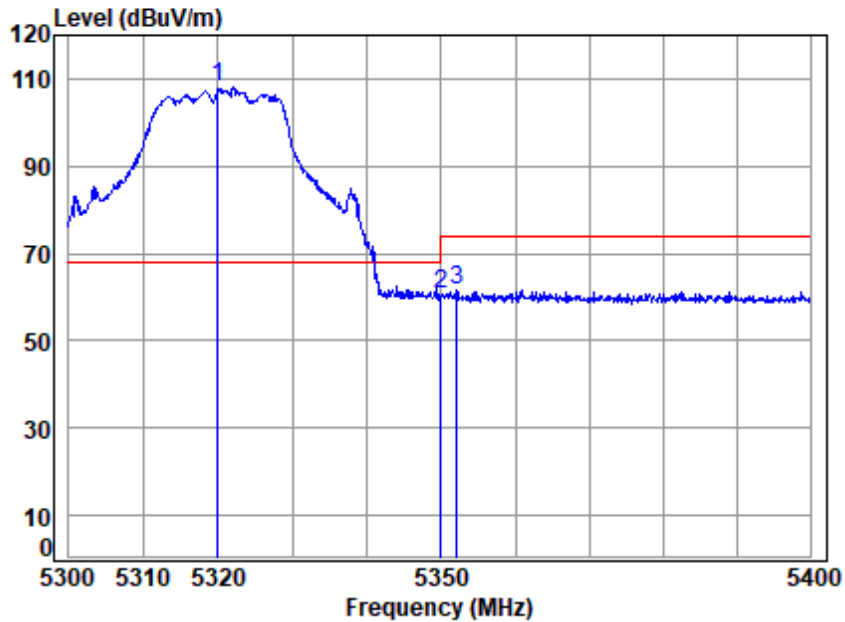

Site : chamber
 Condition: 3m HORIZONTAL
 Job No : 03018AT\03019AT
 Mode : 5320 Band edge
 : 5G WIFI 11AC20

		Cable	Ant	Preamp	Read	Limit	Over	
Freq	Loss	Factor	Factor	Factor	Level	Level	Line	Limit Remark
MHz	dB	dB/m	dB	dB	dBuV	dBuV/m	dBuV/m	dB
1 p 5320.000	19.07	34.28	31.37	85.93	107.91	68.20	39.71	peak
2 5350.020	19.11	34.40	31.39	38.36	60.48	74.00	-13.52	peak
3 5352.067	19.11	34.41	31.39	39.37	61.50	74.00	-12.50	peak



Unless otherwise agreed in writing, this document is issued by the Company subject to its General Conditions of Service printed overleaf, available on request or accessible at <https://www.sgs.com/en/Terms-and-Conditions>. Attention is drawn to the limitation of liability, indemnification and jurisdiction issues defined therein. Any holder of this document is advised that information contained hereon reflects the Company's findings at the time of its intervention only and within the limits of Client's instructions, if any. The Company's sole responsibility is to its Client and this document does not exonerate parties to a transaction from exercising all their rights and obligations under the transaction documents. This document cannot be reproduced except in full, without prior written approval of the Company. Any unauthorized alteration, forgery or falsification of the content or appearance of this document is unlawful and offenders may be prosecuted to the fullest extent of the law. Unless otherwise stated the results shown in this test report refer only to the sample(s) tested and such sample(s) are retained for 30 days only.

Test Mode: 06; Polarity: Horizontal; Modulation:802.11ac; Bandwidth:20MHz; Channel:High

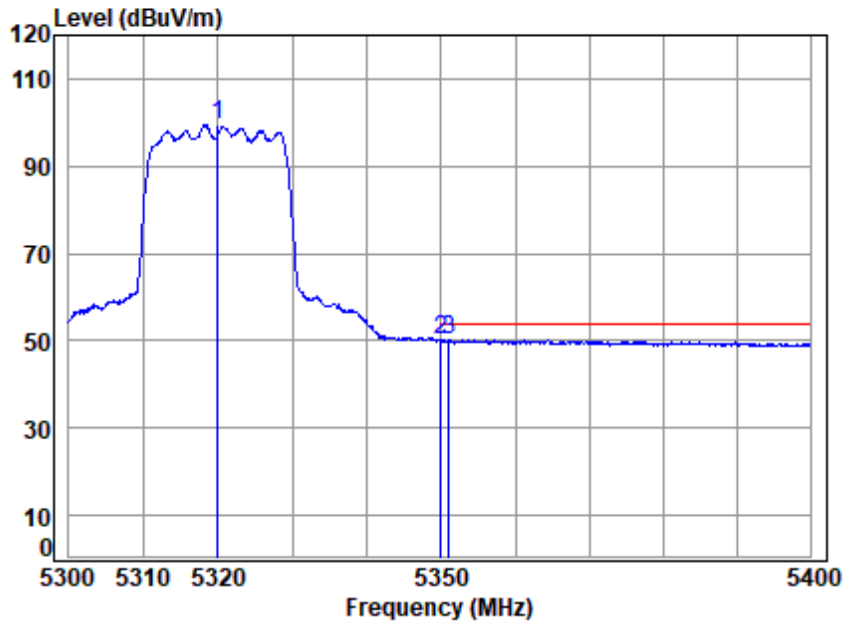

Site : chamber
 Condition: 3m HORIZONTAL
 Job No : 03018AT\03019AT
 Mode : 5320 Band edge
 : 5G WIFI 11AC20

	Freq	Cable Loss	Ant Factor	Preamp Factor	Read Level	Limit Level	Over Limit	Remark
	MHz	dB	dB/m	dB	dBuV	dBuV/m	dBuV/m	dB
1	5320.000	19.07	34.28	31.37	77.32	99.30	-----	Average
2	5350.020	19.11	34.40	31.39	28.10	50.22	54.00	-3.78 Average
3 q	5351.066	19.11	34.40	31.39	28.23	50.35	54.00	-3.65 Average



Unless otherwise agreed in writing, this document is issued by the Company subject to its General Conditions of Service printed overleaf, available on request or accessible at <https://www.sgs.com/en/Terms-and-Conditions>. Attention is drawn to the limitation of liability, indemnification and jurisdiction issues defined therein. Any holder of this document is advised that information contained hereon reflects the Company's findings at the time of its intervention only and within the limits of Client's instructions, if any. The Company's sole responsibility is to its Client and this document does not exonerate parties to a transaction from exercising all their rights and obligations under the transaction documents. This document cannot be reproduced except in full, without prior written approval of the Company. Any unauthorized alteration, forgery or falsification of the content or appearance of this document is unlawful and offenders may be prosecuted to the fullest extent of the law. Unless otherwise stated the results shown in this test report refer only to the sample(s) tested and such sample(s) are retained for 30 days only.

Test Mode: 06; Polarity: Vertical; Modulation:802.11ac; Bandwidth:20MHz; Channel:High

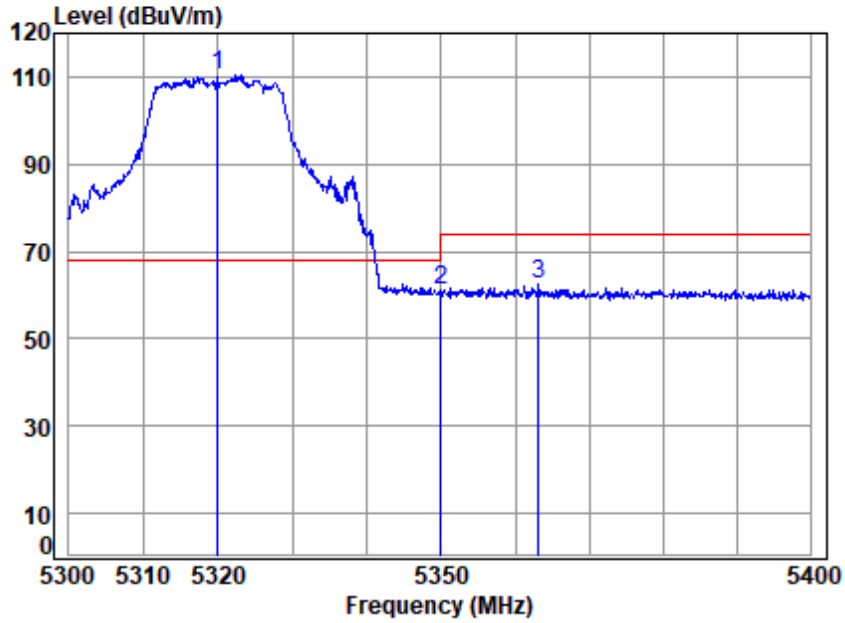

Site : chamber
 Condition: 3m VERTICAL
 Job No : 03018AT\03019AT
 Mode : 5320 Band edge
 : 5G WIFI 11AC20

		Cable	Ant	Preamp	Read	Limit	Over	
	Freq	Loss	Factor	Factor	Level	Line	Limit	Remark
	MHz	dB	dB/m	dB	dBuV	dBuV/m	dBuV/m	dB
1 p	5320.000	19.07	34.28	31.37	88.48	110.46	68.20	42.26 Peak
2	5350.020	19.11	34.40	31.39	39.06	61.18	74.00	-12.82 Peak
3	5363.183	19.13	34.45	31.39	40.36	62.55	74.00	-11.45 Peak



Unless otherwise agreed in writing, this document is issued by the Company subject to its General Conditions of Service printed overleaf, available on request or accessible at <https://www.sgs.com/en/Terms-and-Conditions>. Attention is drawn to the limitation of liability, indemnification and jurisdiction issues defined therein. Any holder of this document is advised that information contained hereon reflects the Company's findings at the time of its intervention only and within the limits of Client's instructions, if any. The Company's sole responsibility is to its Client and this document does not exonerate parties to a transaction from exercising all their rights and obligations under the transaction documents. This document cannot be reproduced except in full, without prior written approval of the Company. Any unauthorized alteration, forgery or falsification of the content or appearance of this document is unlawful and offenders may be prosecuted to the fullest extent of the law. Unless otherwise stated the results shown in this test report refer only to the sample(s) tested and such sample(s) are retained for 30 days only.

Test Mode: 06; Polarity: Vertical; Modulation:802.11ac; Bandwidth:20MHz; Channel:High

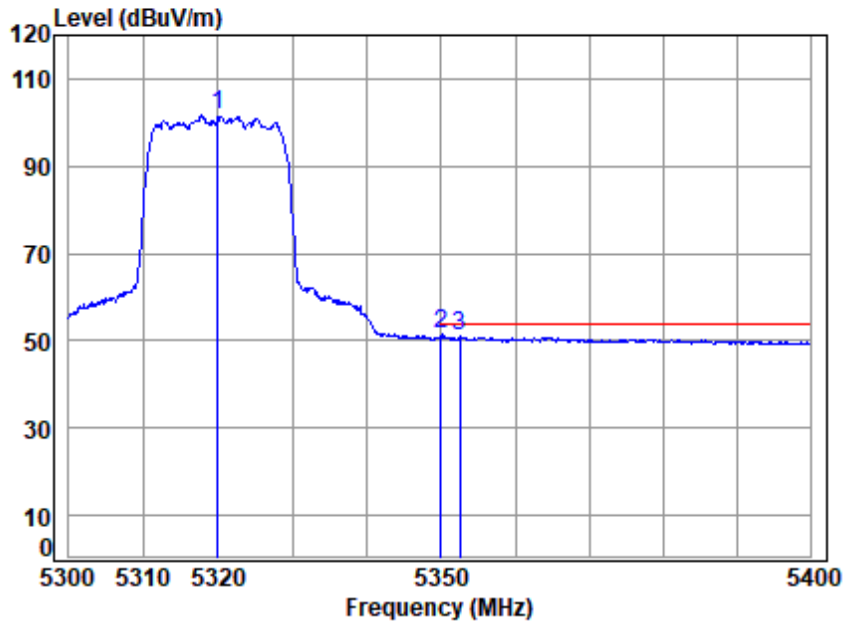

Site : chamber
 Condition: 3m VERTICAL
 Job No : 03018AT\03019AT
 Mode : 5320 Band edge
 : 5G WIFI 11AC20

		Cable	Ant	Preamp	Read	Limit	Over	
Freq	Loss	Factor	Factor	Factor	Level	Level	Line	Limit Remark
MHz	dB	dB/m	dB	dBuV	dBuV/m	dBuV/m	dB	
1	5320.000	19.07	34.28	31.37	79.57	101.55	-----	----- Average
2	q 5350.020	19.11	34.40	31.39	29.26	51.38	54.00	-2.62 Average
3	5352.567	19.11	34.41	31.39	28.75	50.88	54.00	-3.12 Average



Unless otherwise agreed in writing, this document is issued by the Company subject to its General Conditions of Service printed overleaf, available on request or accessible at <https://www.sgs.com/en/Terms-and-Conditions>. Attention is drawn to the limitation of liability, indemnification and jurisdiction issues defined therein. Any holder of this document is advised that information contained hereon reflects the Company's findings at the time of its intervention only and within the limits of Client's instructions, if any. The Company's sole responsibility is to its Client and this document does not exonerate parties to a transaction from exercising all their rights and obligations under the transaction documents. This document cannot be reproduced except in full, without prior written approval of the Company. Any unauthorized alteration, forgery or falsification of the content or appearance of this document is unlawful and offenders may be prosecuted to the fullest extent of the law. Unless otherwise stated the results shown in this test report refer only to the sample(s) tested and such sample(s) are retained for 30 days only.

Test Mode: 06; Polarity: Horizontal; Modulation:802.11ac; Bandwidth:40MHz; Channel:Low

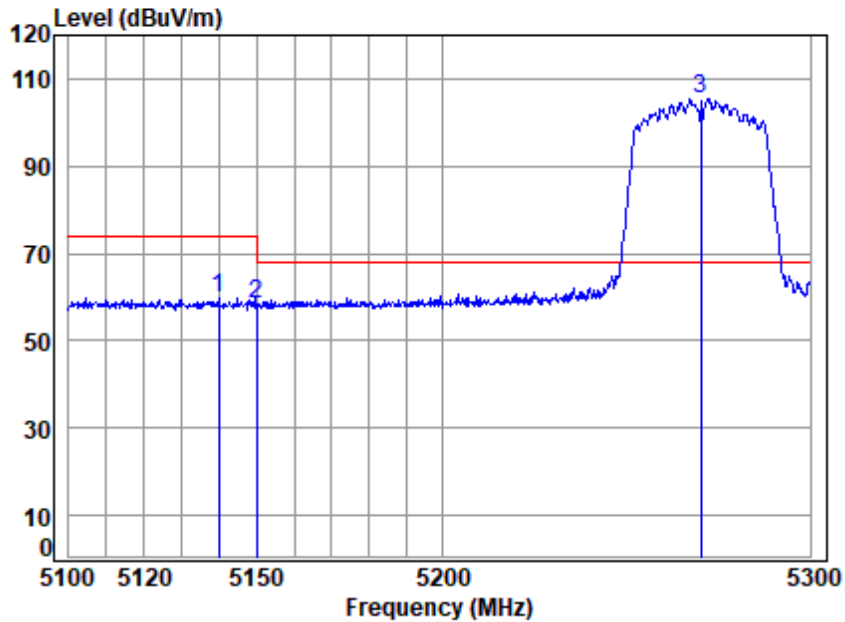

Site : chamber
 Condition: 3m HORIZONTAL
 Job No : 03018AT\03019AT
 Mode : 5270 Band edge
 : 5G WIFI 11AC40

	Freq	Cable Loss	Ant Factor	Preamp Factor	Read Level	Level	Limit Line	Over Limit	Remark
	MHz	dB	dB/m	dB	dBuV	dBuV/m	dBuV/m	dB	
1	5139.782	18.82	33.92	31.28	38.52	59.98	74.00	-14.02	peak
2	5149.980	18.83	33.90	31.28	36.84	58.29	74.00	-15.71	peak
3 p	5270.000	19.00	34.14	31.34	83.69	105.49	68.20	37.29	peak



Unless otherwise agreed in writing, this document is issued by the Company subject to its General Conditions of Service printed overleaf, available on request or accessible at <https://www.sgs.com/en/Terms-and-Conditions>. Attention is drawn to the limitation of liability, indemnification and jurisdiction issues defined therein. Any holder of this document is advised that information contained hereon reflects the Company's findings at the time of its intervention only and within the limits of Client's instructions, if any. The Company's sole responsibility is to its Client and this document does not exonerate parties to a transaction from exercising all their rights and obligations under the transaction documents. This document cannot be reproduced except in full, without prior written approval of the Company. Any unauthorized alteration, forgery or falsification of the content or appearance of this document is unlawful and offenders may be prosecuted to the fullest extent of the law. Unless otherwise stated the results shown in this test report refer only to the sample(s) tested and such sample(s) are retained for 30 days only.

Test Mode: 06; Polarity: Horizontal; Modulation:802.11ac; Bandwidth:40MHz; Channel:Low

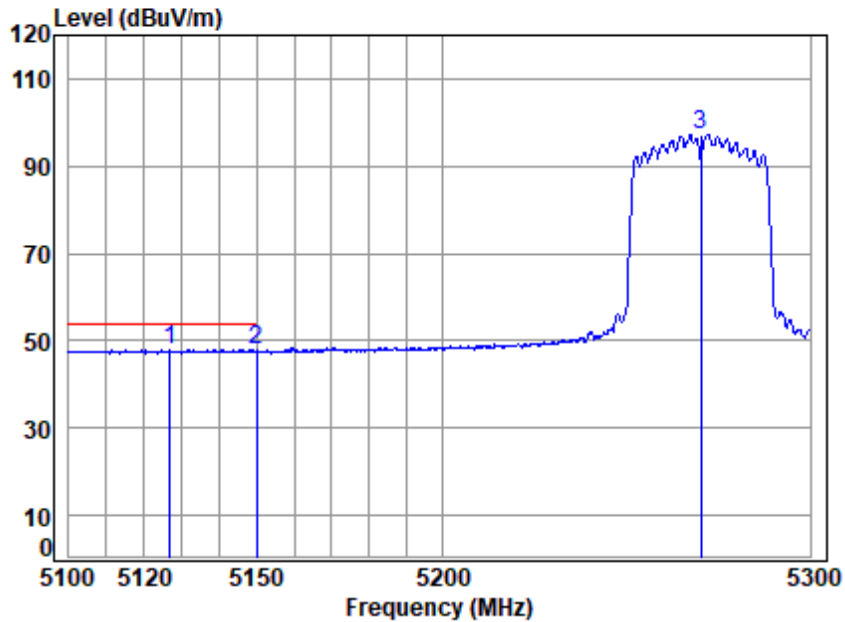

Site : chamber
 Condition: 3m HORIZONTAL
 Job No : 03018AT\03019AT
 Mode : 5270 Band edge
 : 5G WIFI 11AC40

		Cable	Ant	Preamp	Read	Limit	Over	
Freq	Loss	Factor	Factor	Factor	Level	Line	Limit	Remark
MHz	dB	dB/m	dB	dB	dBuV	dBuV/m	dBuV/m	dB
1 q	5126.750	18.80	33.95	31.27	26.43	47.91	54.00	-6.09 Average
2	5149.980	18.83	33.90	31.28	26.37	47.82	54.00	-6.18 Average
3	5270.000	19.00	34.14	31.34	75.43	97.23	-----	----- Average



Unless otherwise agreed in writing, this document is issued by the Company subject to its General Conditions of Service printed overleaf, available on request or accessible at <https://www.sgs.com/en/Terms-and-Conditions>. Attention is drawn to the limitation of liability, indemnification and jurisdiction issues defined therein. Any holder of this document is advised that information contained hereon reflects the Company's findings at the time of its intervention only and within the limits of Client's instructions, if any. The Company's sole responsibility is to its Client and this document does not exonerate parties to a transaction from exercising all their rights and obligations under the transaction documents. This document cannot be reproduced except in full, without prior written approval of the Company. Any unauthorized alteration, forgery or falsification of the content or appearance of this document is unlawful and offenders may be prosecuted to the fullest extent of the law. Unless otherwise stated the results shown in this test report refer only to the sample(s) tested and such sample(s) are retained for 30 days only.

Test Mode: 06; Polarity: Vertical; Modulation:802.11ac; Bandwidth:40MHz; Channel:Low

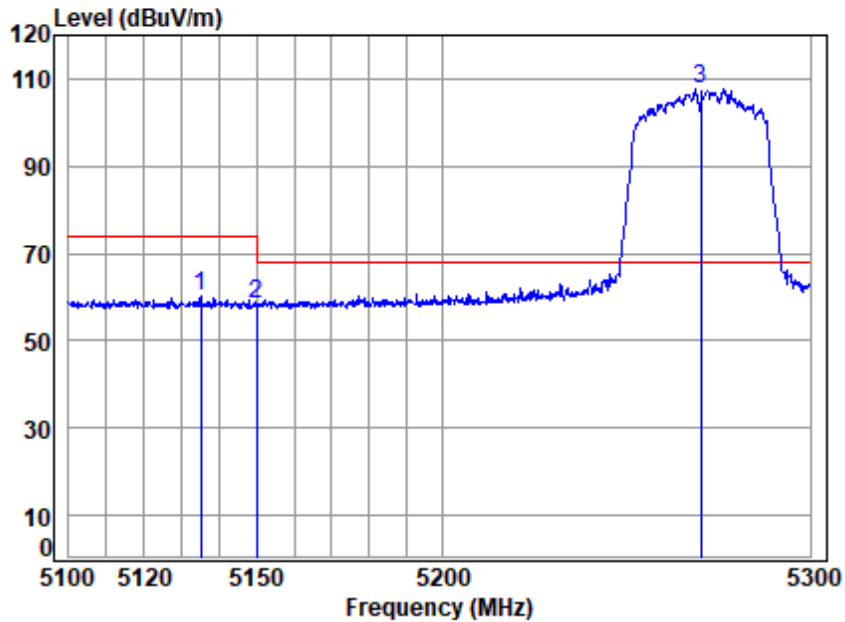

Site : chamber
 Condition: 3m VERTICAL
 Job No : 03018AT\03019AT
 Mode : 5270 Band edge
 : 5G WIFI 11AC40

	Cable	Ant	Preamp	Read	Limit	Over		
Freq	Loss	Factor	Factor	Level	Level	Line	Limit	Remark
MHz	dB	dB/m	dB	dBuV	dBuV/m	dBuV/m	dB	
1	5135.040	18.81	33.93	31.27	38.60	60.07	74.00	-13.93 Peak
2	5149.980	18.83	33.90	31.28	37.09	58.54	74.00	-15.46 Peak
3 p	5270.000	19.00	34.14	31.34	85.83	107.63	68.20	39.43 Peak



Unless otherwise agreed in writing, this document is issued by the Company subject to its General Conditions of Service printed overleaf, available on request or accessible at <https://www.sgs.com/en/Terms-and-Conditions>. Attention is drawn to the limitation of liability, indemnification and jurisdiction issues defined therein. Any holder of this document is advised that information contained hereon reflects the Company's findings at the time of its intervention only and within the limits of Client's instructions, if any. The Company's sole responsibility is to its Client and this document does not exonerate parties to a transaction from exercising all their rights and obligations under the transaction documents. This document cannot be reproduced except in full, without prior written approval of the Company. Any unauthorized alteration, forgery or falsification of the content or appearance of this document is unlawful and offenders may be prosecuted to the fullest extent of the law. Unless otherwise stated the results shown in this test report refer only to the sample(s) tested and such sample(s) are retained for 30 days only.

Test Mode: 06; Polarity: Vertical; Modulation:802.11ac; Bandwidth:40MHz; Channel:Low

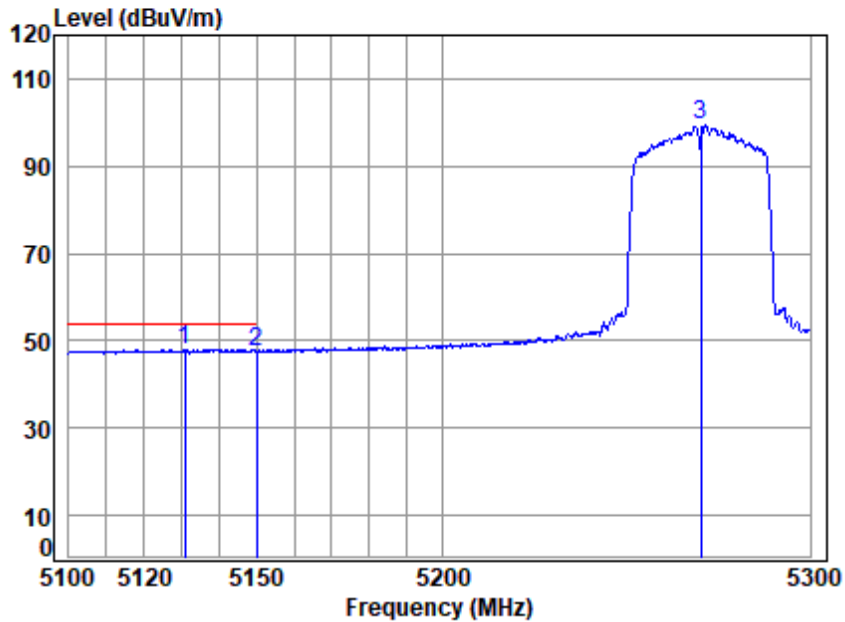

Site : chamber
 Condition: 3m VERTICAL
 Job No : 03018AT\03019AT
 Mode : 5270 Band edge
 : 5G WIFI 11AC40

		Cable	Ant	Preamp	Read	Limit	Over	
Freq	Loss	Factor	Factor	Factor	Level	Line	Limit	Remark
MHz	dB	dB/m	dB	dB	dBuV	dBuV/m	dB	
1 q	5130.893	18.81	33.94	31.27	26.57	48.05	54.00	-5.95 Average
2	5149.980	18.83	33.90	31.28	26.11	47.56	54.00	-6.44 Average
3	5270.000	19.00	34.14	31.34	77.58	99.38	-----	----- Average



Unless otherwise agreed in writing, this document is issued by the Company subject to its General Conditions of Service printed overleaf, available on request or accessible at <https://www.sgs.com/en/Terms-and-Conditions>. Attention is drawn to the limitation of liability, indemnification and jurisdiction issues defined therein. Any holder of this document is advised that information contained hereon reflects the Company's findings at the time of its intervention only and within the limits of Client's instructions, if any. The Company's sole responsibility is to its Client and this document does not exonerate parties to a transaction from exercising all their rights and obligations under the transaction documents. This document cannot be reproduced except in full, without prior written approval of the Company. Any unauthorized alteration, forgery or falsification of the content or appearance of this document is unlawful and offenders may be prosecuted to the fullest extent of the law. Unless otherwise stated the results shown in this test report refer only to the sample(s) tested and such sample(s) are retained for 30 days only.

Test Mode: 06; Polarity: Horizontal; Modulation:802.11ac; Bandwidth:40MHz; Channel:High

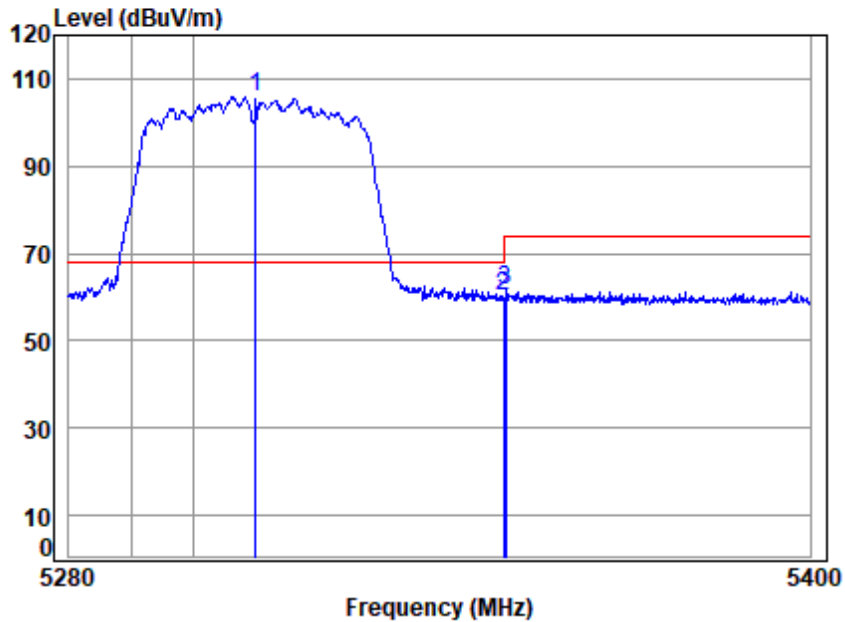

Site : chamber
 Condition: 3m HORIZONTAL
 Job No : 03018AT\03019AT
 Mode : 5310 Band edge
 : 5G WIFI 11AC40

		Cable	Ant	Preamp	Read	Limit	Over	
Freq	Loss	Factor	Factor	Factor	Level	Level	Line	Limit Remark
MHz	dB	dB/m	dB	dB	dBuV	dBuV/m	dBuV/m	dB
1 p 5310.000	19.06	34.24	31.36	83.78	105.72	68.20	37.52	peak
2 5350.020	19.11	34.40	31.39	38.10	60.22	74.00	-13.78	peak
3 5350.474	19.11	34.40	31.39	39.53	61.65	74.00	-12.35	peak



Unless otherwise agreed in writing, this document is issued by the Company subject to its General Conditions of Service printed overleaf, available on request or accessible at <https://www.sgs.com/en/Terms-and-Conditions>. Attention is drawn to the limitation of liability, indemnification and jurisdiction issues defined therein. Any holder of this document is advised that information contained hereon reflects the Company's findings at the time of its intervention only and within the limits of Client's instructions, if any. The Company's sole responsibility is to its Client and this document does not exonerate parties to a transaction from exercising all their rights and obligations under the transaction documents. This document cannot be reproduced except in full, without prior written approval of the Company. Any unauthorized alteration, forgery or falsification of the content or appearance of this document is unlawful and offenders may be prosecuted to the fullest extent of the law. Unless otherwise stated the results shown in this test report refer only to the sample(s) tested and such sample(s) are retained for 30 days only.

Test Mode: 06; Polarity: Horizontal; Modulation:802.11ac; Bandwidth:40MHz; Channel:High

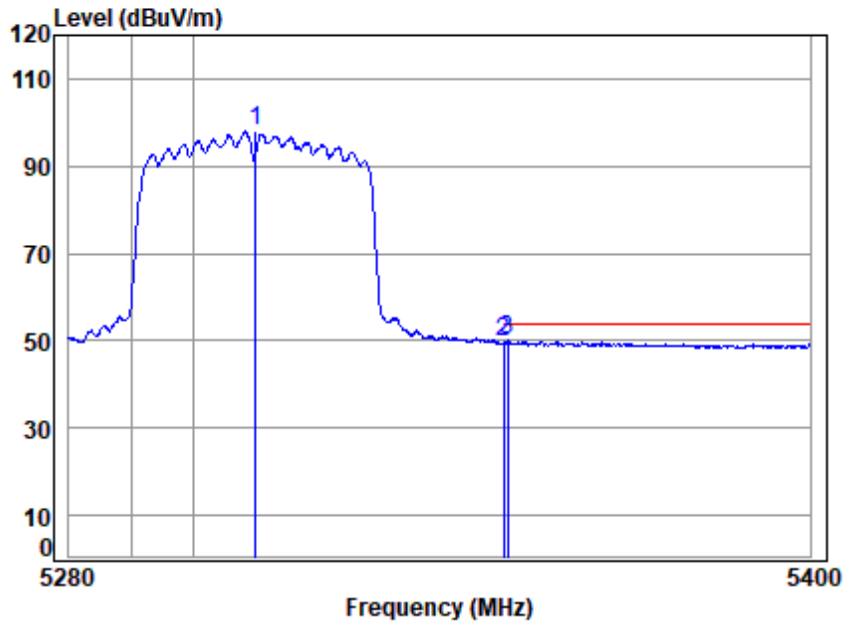

Site : chamber
 Condition: 3m HORIZONTAL
 Job No : 03018AT\03019AT
 Mode : 5310 Band edge
 : 5G WIFI 11AC40

	Freq	Cable Loss	Ant Factor	Preamp Factor	Read Level	Limit Level	Over Limit	Remark
	MHz	dB	dB/m	dB	dBuV	dBuV/m	dBuV/m	dB
1	5310.000	19.06	34.24	31.36	75.96	97.90	-----	Average
2	5350.020	19.11	34.40	31.39	27.62	49.74	54.00	-4.26 Average
3 q	5350.714	19.11	34.40	31.39	27.97	50.09	54.00	-3.91 Average



Unless otherwise agreed in writing, this document is issued by the Company subject to its General Conditions of Service printed overleaf, available on request or accessible at <https://www.sgs.com/en/Terms-and-Conditions>. Attention is drawn to the limitation of liability, indemnification and jurisdiction issues defined therein. Any holder of this document is advised that information contained hereon reflects the Company's findings at the time of its intervention only and within the limits of Client's instructions, if any. The Company's sole responsibility is to its Client and this document does not exonerate parties to a transaction from exercising all their rights and obligations under the transaction documents. This document cannot be reproduced except in full, without prior written approval of the Company. Any unauthorized alteration, forgery or falsification of the content or appearance of this document is unlawful and offenders may be prosecuted to the fullest extent of the law. Unless otherwise stated the results shown in this test report refer only to the sample(s) tested and such sample(s) are retained for 30 days only.

Test Mode: 06; Polarity: Vertical; Modulation:802.11ac; Bandwidth:40MHz; Channel:High

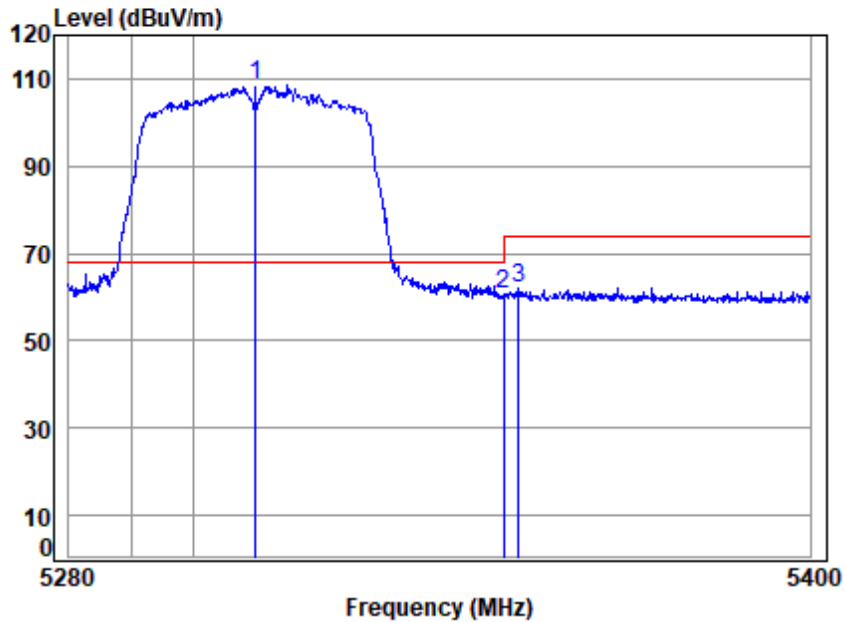

Site : chamber
 Condition: 3m VERTICAL
 Job No : 03018AT\03019AT
 Mode : 5310 Band edge
 : 5G WIFI 11AC40

		Cable	Ant	Preamp	Read	Limit	Over	
Freq	Loss	Factor	Factor	Factor	Level	Line	Limit	Remark
MHz	dB	dB/m	dB	dB	dBuV	dBuV/m	dBuV/m	dB
1 p 5310.000	19.06	34.24	31.36	86.82	108.76	68.20	40.56	Peak
2 5350.020	19.11	34.40	31.39	38.62	60.74	74.00	-13.26	Peak
3 5352.518	19.11	34.41	31.39	40.00	62.13	74.00	-11.87	Peak



Test Mode: 06; Polarity: Vertical; Modulation:802.11ac; Bandwidth:40MHz; Channel:High

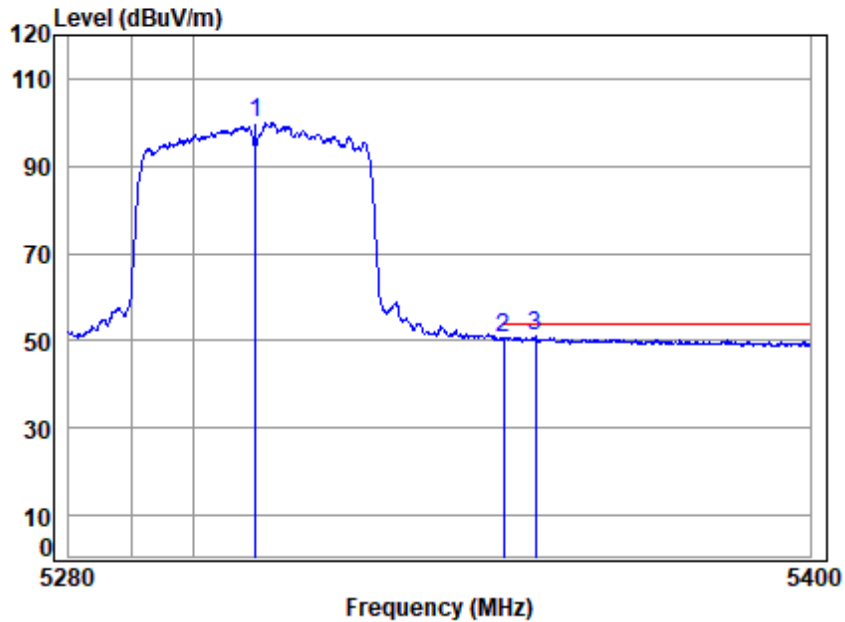

Site : chamber
 Condition: 3m VERTICAL
 Job No : 03018AT\03019AT
 Mode : 5310 Band edge
 : 5G WIFI 11AC40

	Freq	Cable Loss	Ant Factor	Preamp Factor	Read Level	Level	Limit Line	Over Limit	Remark
	MHz	dB	dB/m	dB	dBuV	dBuV/m	dBuV/m	dB	
1	5310.000	19.06	34.24	31.36	77.89	99.83	-----	-----	Average
2	5350.020	19.11	34.40	31.39	28.56	50.68	54.00	-3.32	Average
3 q	5355.285	19.12	34.42	31.39	28.85	51.00	54.00	-3.00	Average



Unless otherwise agreed in writing, this document is issued by the Company subject to its General Conditions of Service printed overleaf, available on request or accessible at <https://www.sgs.com/en/Terms-and-Conditions>. Attention is drawn to the limitation of liability, indemnification and jurisdiction issues defined therein. Any holder of this document is advised that information contained hereon reflects the Company's findings at the time of its intervention only and within the limits of Client's instructions, if any. The Company's sole responsibility is to its Client and this document does not exonerate parties to a transaction from exercising all their rights and obligations under the transaction documents. This document cannot be reproduced except in full, without prior written approval of the Company. Any unauthorized alteration, forgery or falsification of the content or appearance of this document is unlawful and offenders may be prosecuted to the fullest extent of the law. Unless otherwise stated the results shown in this test report refer only to the sample(s) tested and such sample(s) are retained for 30 days only.

Attention: To check the authenticity of testing /inspection report & certificate, please contact us at telephone: (86-755) 8307 1443, or email: CN.Doccheck@sgs.com
 No.1 Workshop, M-10, Middle Section, Science & Technology Park, Nanshan District, Shenzhen, Guangdong, China 518057 t (86-755) 26012053 f (86-755) 26710594 www.sgsgroup.com.cn
 中国·广东·深圳市南山区科技园中区M-10栋1号厂房 邮编: 518057 t (86-755) 26012053 f (86-755) 26710594 sgs.china@sgs.com

Test Mode: 06; Polarity: Horizontal; Modulation:802.11ac; Bandwidth:80MHz; Channel:middle

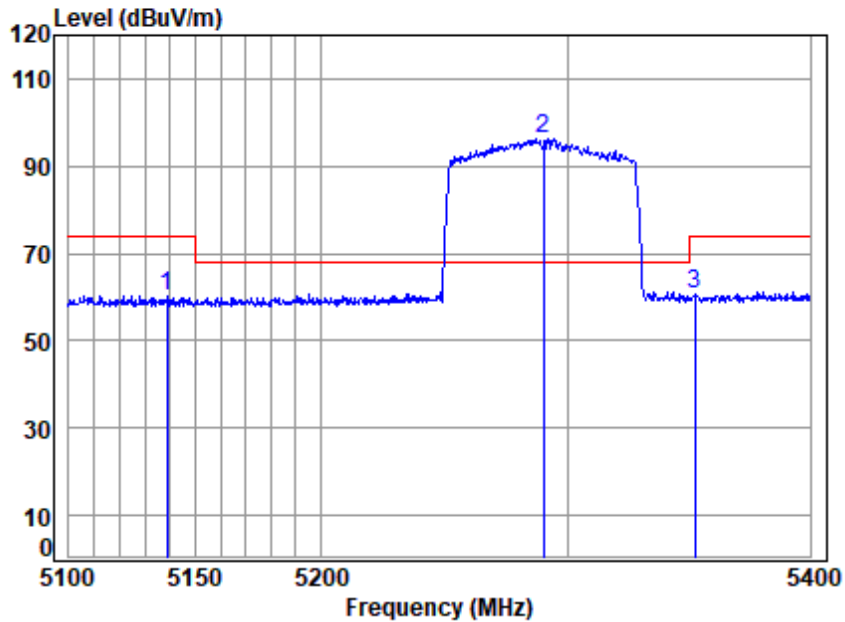

Site : chamber
 Condition: 3m HORIZONTAL
 Job No : 03018AT\03019AT
 Mode : 5290 Band edge
 : 5G WIFI 11AC80

	Cable	Ant	Preamp	Read	Limit	Over	
Freq	Loss	Factor	Factor	Level	Level	Line	Limit Remark
MHz	dB	dB/m	dB	dBuV	dBuV/m	dBuV/m	dB
1	5138.625	18.82	33.92	35.32	42.97	60.39	74.00 -13.61 peak
2 p	5290.000	19.03	34.18	35.24	78.37	96.34	68.20 28.14 peak
3	5352.064	19.11	34.41	35.21	42.29	60.60	74.00 -13.40 peak



Unless otherwise agreed in writing, this document is issued by the Company subject to its General Conditions of Service printed overleaf, available on request or accessible at <https://www.sgs.com/en/Terms-and-Conditions>. Attention is drawn to the limitation of liability, indemnification and jurisdiction issues defined therein. Any holder of this document is advised that information contained hereon reflects the Company's findings at the time of its intervention only and within the limits of Client's instructions, if any. The Company's sole responsibility is to its Client and this document does not exonerate parties to a transaction from exercising all their rights and obligations under the transaction documents. This document cannot be reproduced except in full, without prior written approval of the Company. Any unauthorized alteration, forgery or falsification of the content or appearance of this document is unlawful and offenders may be prosecuted to the fullest extent of the law. Unless otherwise stated the results shown in this test report refer only to the sample(s) tested and such sample(s) are retained for 30 days only.

Test Mode: 06; Polarity: Horizontal; Modulation:802.11ac; Bandwidth:80MHz; Channel:middle

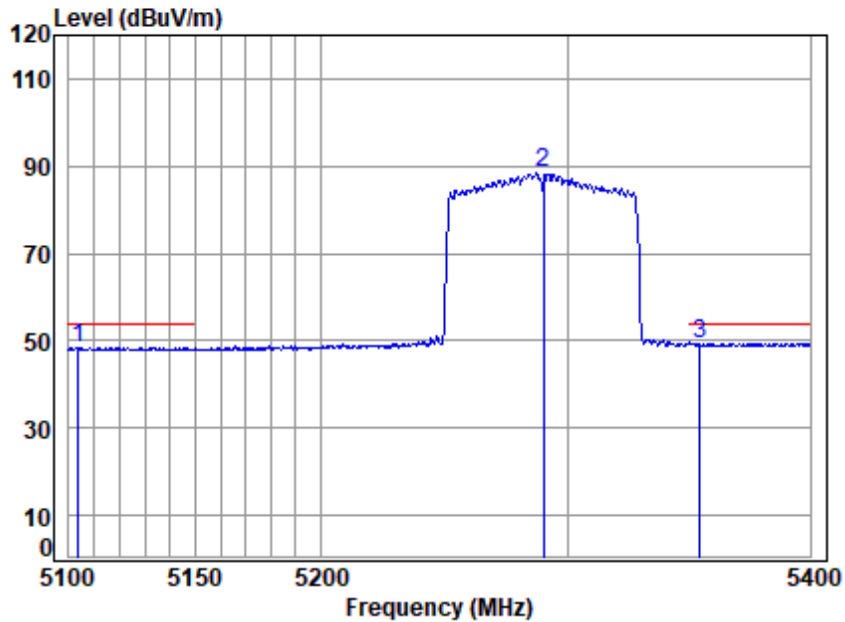

Site : chamber
 Condition: 3m HORIZONTAL
 Job No : 03018AT\03019AT
 Mode : 5290 Band edge
 : 5G WIFI 11AC80

	Freq	Cable Loss	Ant Factor	Preamp Factor	Read Level	Limit Level	Over Limit	Remark
	MHz	dB	dB/m	dB	dBuV	dBuV/m	dBuV/m	dB
1	5103.791	18.77	33.99	35.33	31.04	54.00	-5.53	Average
2	5290.000	19.03	34.18	35.24	70.50	88.47	-----	Average
3 q	5354.512	19.12	34.42	35.21	31.06	54.00	-4.61	Average



Unless otherwise agreed in writing, this document is issued by the Company subject to its General Conditions of Service printed overleaf, available on request or accessible at <https://www.sgs.com/en/Terms-and-Conditions>. Attention is drawn to the limitation of liability, indemnification and jurisdiction issues defined therein. Any holder of this document is advised that information contained hereon reflects the Company's findings at the time of its intervention only and within the limits of Client's instructions, if any. The Company's sole responsibility is to its Client and this document does not exonerate parties to a transaction from exercising all their rights and obligations under the transaction documents. This document cannot be reproduced except in full, without prior written approval of the Company. Any unauthorized alteration, forgery or falsification of the content or appearance of this document is unlawful and offenders may be prosecuted to the fullest extent of the law. Unless otherwise stated the results shown in this test report refer only to the sample(s) tested and such sample(s) are retained for 30 days only.

Test Mode: 06; Polarity: Vertical; Modulation:802.11ac; Bandwidth:80MHz; Channel:middle

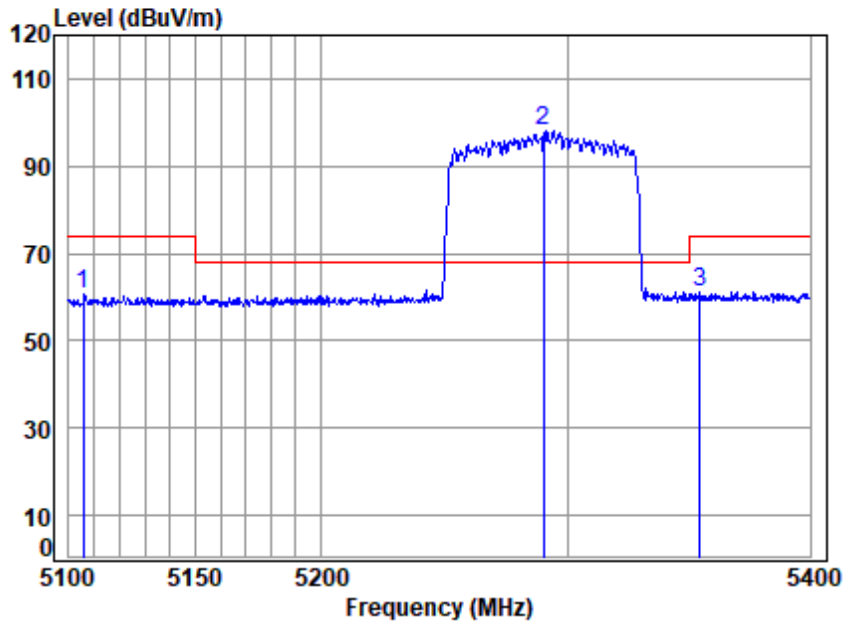

Site : chamber
 Condition: 3m VERTICAL
 Job No : 03018AT\03019AT
 Mode : 5290 Band edge
 : 5G WIFI 11AC80

	Freq	Cable Loss	Ant Factor	Preamp Factor	Read Level	Limit Level	Over Line	Remark
	MHz	dB	dB/m	dB	dBuV	dBuV/m	dBuV/m	dB
1	5105.833	18.77	33.99	35.33	43.04	60.47	74.00	-13.53 Peak
2 p	5290.000	19.03	34.18	35.24	80.13	98.10	68.20	29.90 Peak
3	5354.512	19.12	34.42	35.21	42.88	61.21	74.00	-12.79 Peak



Unless otherwise agreed in writing, this document is issued by the Company subject to its General Conditions of Service printed overleaf, available on request or accessible at <https://www.sgs.com/en/Terms-and-Conditions>. Attention is drawn to the limitation of liability, indemnification and jurisdiction issues defined therein. Any holder of this document is advised that information contained hereon reflects the Company's findings at the time of its intervention only and within the limits of Client's instructions, if any. The Company's sole responsibility is to its Client and this document does not exonerate parties to a transaction from exercising all their rights and obligations under the transaction documents. This document cannot be reproduced except in full, without prior written approval of the Company. Any unauthorized alteration, forgery or falsification of the content or appearance of this document is unlawful and offenders may be prosecuted to the fullest extent of the law. Unless otherwise stated the results shown in this test report refer only to the sample(s) tested and such sample(s) are retained for 30 days only.

Test Mode: 06; Polarity: Vertical; Modulation:802.11ac; Bandwidth:80MHz; Channel:middle

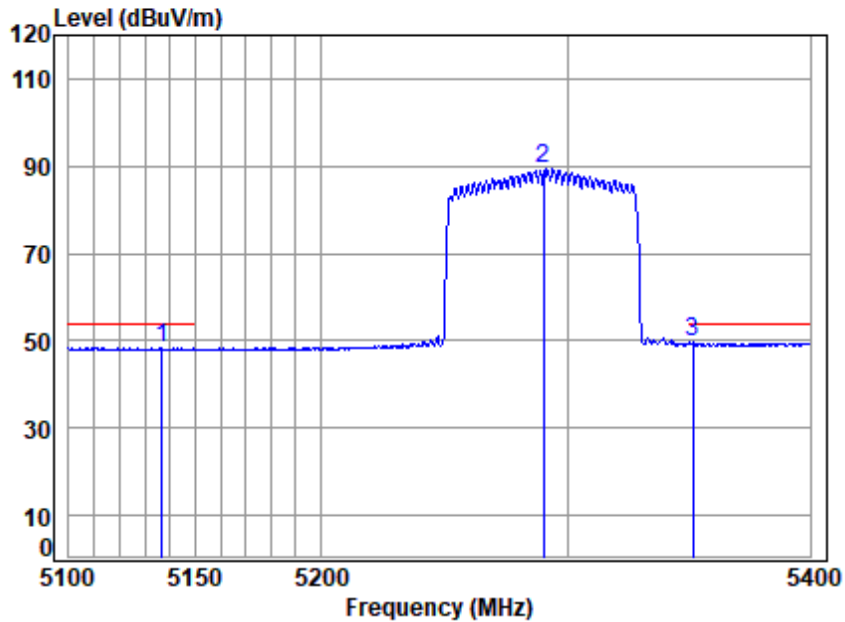

Site : chamber
 Condition: 3m VERTICAL
 Job No : 03018AT\03019AT
 Mode : 5290 Band edge
 : 5G WIFI 11AC80

	Freq	Cable Loss	Ant Factor	Preamp Factor	Read Level	Limit Level	Over Limit	Remark
	MHz	dB	dB/m	dB	dBuV	dBuV/m	dBuV/m	dB
1	5136.863	18.82	33.93	35.32	30.93	48.36	54.00	-5.64 Average
2	5290.000	19.03	34.18	35.24	71.39	89.36	-----	----- Average
3 q	5351.452	19.11	34.41	35.21	31.32	49.63	54.00	-4.37 Average



Unless otherwise agreed in writing, this document is issued by the Company subject to its General Conditions of Service printed overleaf, available on request or accessible at <https://www.sgs.com/en/Terms-and-Conditions>. Attention is drawn to the limitation of liability, indemnification and jurisdiction issues defined therein. Any holder of this document is advised that information contained hereon reflects the Company's findings at the time of its intervention only and within the limits of Client's instructions, if any. The Company's sole responsibility is to its Client and this document does not exonerate parties to a transaction from exercising all their rights and obligations under the transaction documents. This document cannot be reproduced except in full, without prior written approval of the Company. Any unauthorized alteration, forgery or falsification of the content or appearance of this document is unlawful and offenders may be prosecuted to the fullest extent of the law. Unless otherwise stated the results shown in this test report refer only to the sample(s) tested and such sample(s) are retained for 30 days only.

Test Mode: 06; Polarity: Horizontal; Modulation:802.11 ax(Full RU0); Bandwidth:20MHz; Channel:Low

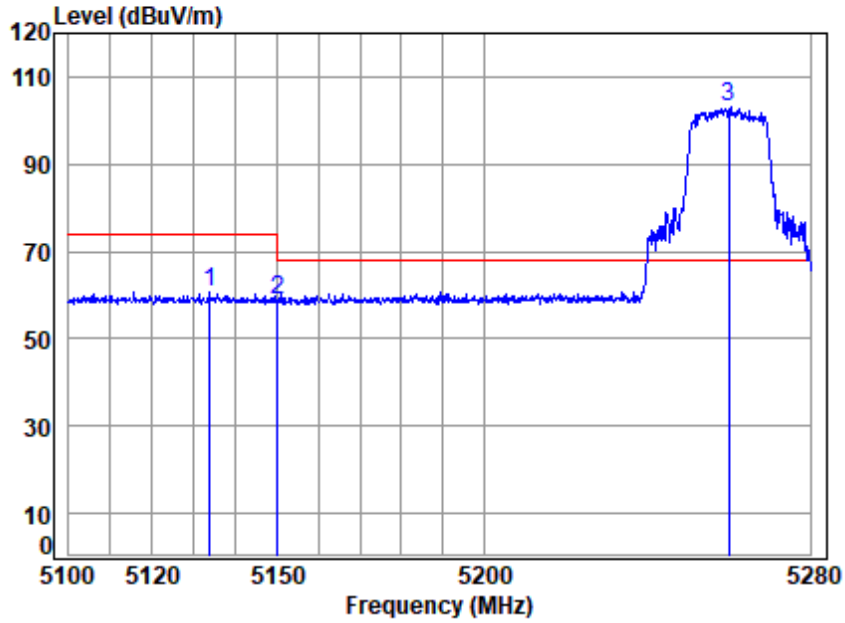

Site : chamber
 Condition: 3m HORIZONTAL
 Job No : 03018AT\03019AT
 Mode : 5260 Band edge
 : 5G WIFI 11AX20

	Cable	Ant	Preamp	Read	Limit	Over	
Freq	Loss	Factor	Factor	Level	Level	Line	Limit Remark
MHz	dB	dB/m	dB	dBuV	dBuV/m	dBuV/m	dB
1	5133.721	18.81	33.93	35.32	43.28	60.70	74.00 -13.30 peak
2	5149.980	18.83	33.90	35.31	41.52	58.94	74.00 -15.06 peak
3 p	5260.000	18.99	34.12	35.25	85.28	103.14	68.20 34.94 peak



Unless otherwise agreed in writing, this document is issued by the Company subject to its General Conditions of Service printed overleaf, available on request or accessible at <https://www.sgs.com/en/Terms-and-Conditions>. Attention is drawn to the limitation of liability, indemnification and jurisdiction issues defined therein. Any holder of this document is advised that information contained hereon reflects the Company's findings at the time of its intervention only and within the limits of Client's instructions, if any. The Company's sole responsibility is to its Client and this document does not exonerate parties to a transaction from exercising all their rights and obligations under the transaction documents. This document cannot be reproduced except in full, without prior written approval of the Company. Any unauthorized alteration, forgery or falsification of the content or appearance of this document is unlawful and offenders may be prosecuted to the fullest extent of the law. Unless otherwise stated the results shown in this test report refer only to the sample(s) tested and such sample(s) are retained for 30 days only.

Test Mode: 06; Polarity: Horizontal; Modulation:802.11 ax(Full RU0); Bandwidth:20MHz; Channel:Low

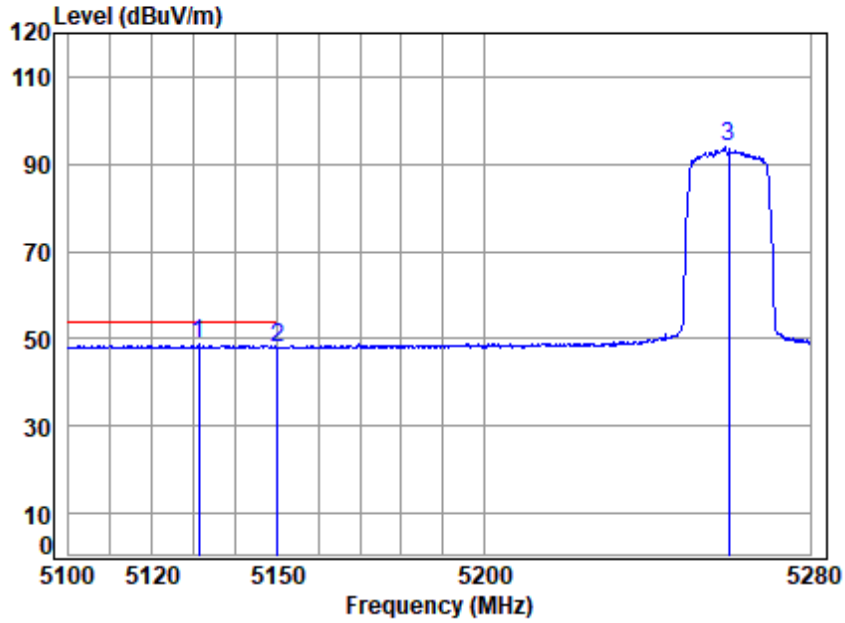

Site : chamber
 Condition: 3m HORIZONTAL
 Job No : 03018AT\03019AT
 Mode : 5260 Band edge
 : 5G WIFI 11AX20

		Cable	Ant	Preamp	Read	Limit	Over		
	Freq	Loss	Factor	Factor	Level	Level	Line	Limit	Remark
	MHz	dB	dB/m	dB	dBuV	dBuV/m	dBuV/m	dB	
1	q 5131.229	18.81	33.94	35.32	31.18	48.61	54.00	-5.39	Average
2	5149.980	18.83	33.90	35.31	30.64	48.06	54.00	-5.94	Average
3	5260.000	18.99	34.12	35.25	76.02	93.88	-----	-----	Average



Test Mode: 06; Polarity: Vertical; Modulation:802.11ax(Full RU0); Bandwidth:20MHz; Channel:Low

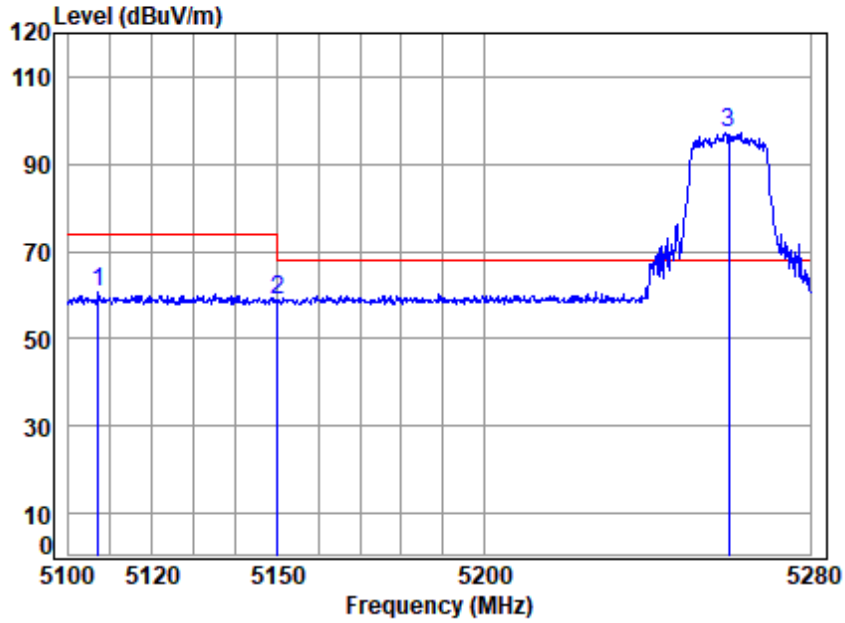

Site : chamber
 Condition: 3m VERTICAL
 Job No : 03018AT\03019AT
 Mode : 5260 Band edge
 : 5G WIFI 11AX20

	Cable	Ant	Preamp	Read	Limit	Over		
Freq	Loss	Factor	Factor	Level	Level	Line	Limit	Remark
MHz	dB	dB/m	dB	dBuV	dBuV/m	dBuV/m	dB	
1	5107.081	18.77	33.99	35.33	43.13	60.56	74.00	-13.44 Peak
2	5149.980	18.83	33.90	35.31	41.60	59.02	74.00	-14.98 Peak
3 p	5260.000	18.99	34.12	35.25	79.23	97.09	68.20	28.89 Peak



Unless otherwise agreed in writing, this document is issued by the Company subject to its General Conditions of Service printed overleaf, available on request or accessible at <https://www.sgs.com/en/Terms-and-Conditions>. Attention is drawn to the limitation of liability, indemnification and jurisdiction issues defined therein. Any holder of this document is advised that information contained hereon reflects the Company's findings at the time of its intervention only and within the limits of Client's instructions, if any. The Company's sole responsibility is to its Client and this document does not exonerate parties to a transaction from exercising all their rights and obligations under the transaction documents. This document cannot be reproduced except in full, without prior written approval of the Company. Any unauthorized alteration, forgery or falsification of the content or appearance of this document is unlawful and offenders may be prosecuted to the fullest extent of the law. Unless otherwise stated the results shown in this test report refer only to the sample(s) tested and such sample(s) are retained for 30 days only.

Test Mode: 06; Polarity: Vertical; Modulation:802.11ax(Full RU0); Bandwidth:20MHz; Channel:Low

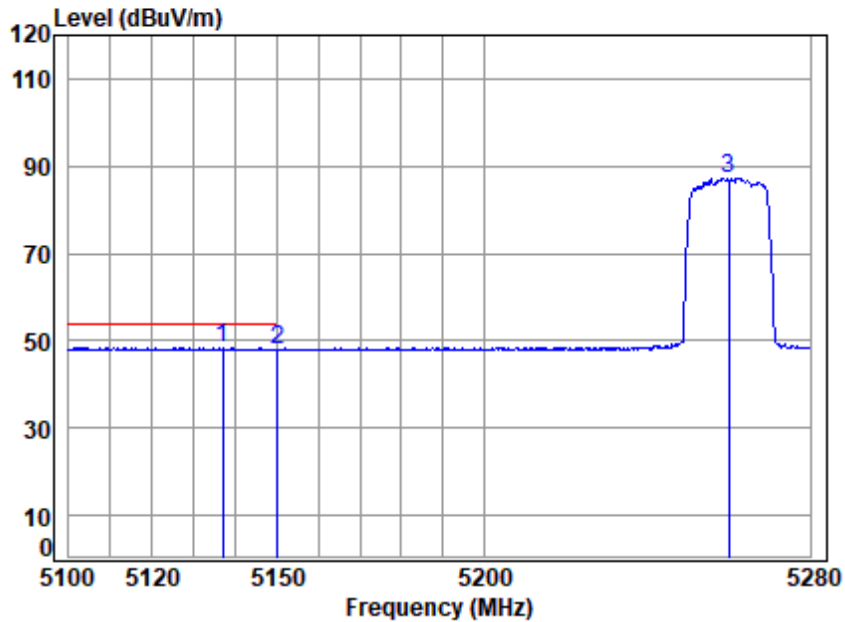

Site : chamber
 Condition: 3m VERTICAL
 Job No : 03018AT\03019AT
 Mode : 5260 Band edge
 : 5G WIFI 11AX20

		Cable	Ant	Preamp	Read	Limit	Over	
Freq	Loss	Factor	Factor	Factor	Level	Level	Line	Limit Remark
MHz	dB	dB/m	dB	dB	dBuV	dBuV/m	dBuV/m	dB
1 q	5136.927	18.82	33.93	35.32	30.97	48.40	54.00	-5.60 Average
2	5149.980	18.83	33.90	35.31	30.65	48.07	54.00	-5.93 Average
3	5260.000	18.99	34.12	35.25	69.52	87.38	-----	----- Average



Unless otherwise agreed in writing, this document is issued by the Company subject to its General Conditions of Service printed overleaf, available on request or accessible at <https://www.sgs.com/en/Terms-and-Conditions>. Attention is drawn to the limitation of liability, indemnification and jurisdiction issues defined therein. Any holder of this document is advised that information contained hereon reflects the Company's findings at the time of its intervention only and within the limits of Client's instructions, if any. The Company's sole responsibility is to its Client and this document does not exonerate parties to a transaction from exercising all their rights and obligations under the transaction documents. This document cannot be reproduced except in full, without prior written approval of the Company. Any unauthorized alteration, forgery or falsification of the content or appearance of this document is unlawful and offenders may be prosecuted to the fullest extent of the law. Unless otherwise stated the results shown in this test report refer only to the sample(s) tested and such sample(s) are retained for 30 days only.

Test Mode: 06; Polarity: Horizontal; Modulation:802.11ax(Full RU0); Bandwidth:20MHz; Channel:High

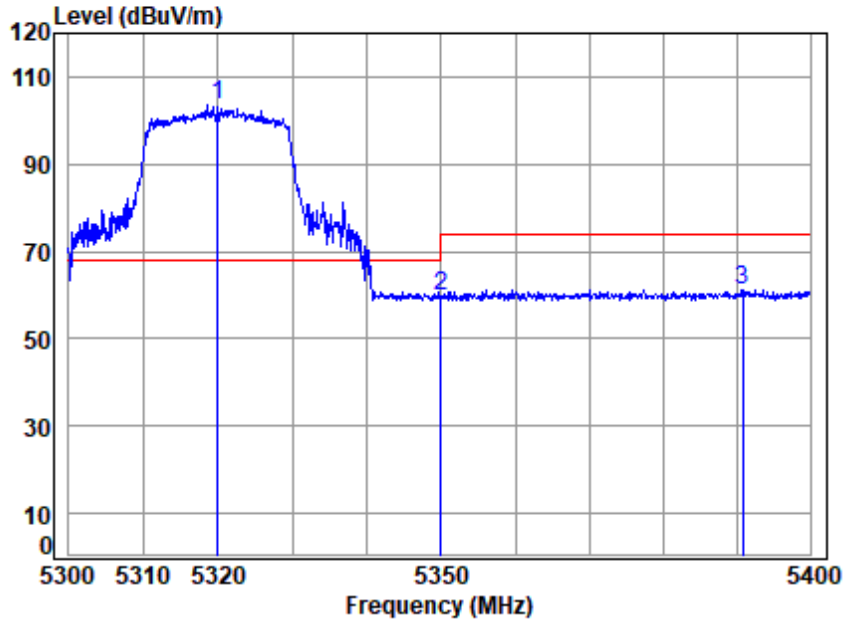

Site : chamber
 Condition: 3m HORIZONTAL
 Job No : 03018AT\03019AT
 Mode : 5320 Band edge
 : 5G WIFI 11AX20

	Freq	Cable Loss	Ant Factor	Preamp Factor	Read Level	Limit Level	Over Limit	Remark
	MHz	dB	dB/m	dB	dBuV	dBuV/m	dBuV/m	dB
1 p	5320.000	19.07	34.28	35.22	85.24	103.37	68.20	35.17 peak
2	5350.020	19.11	34.40	35.21	41.57	59.87	74.00	-14.13 peak
3	5390.822	19.16	34.56	35.19	42.84	61.37	74.00	-12.63 peak



Unless otherwise agreed in writing, this document is issued by the Company subject to its General Conditions of Service printed overleaf, available on request or accessible at <https://www.sgs.com/en/Terms-and-Conditions>. Attention is drawn to the limitation of liability, indemnification and jurisdiction issues defined therein. Any holder of this document is advised that information contained hereon reflects the Company's findings at the time of its intervention only and within the limits of Client's instructions, if any. The Company's sole responsibility is to its Client and this document does not exonerate parties to a transaction from exercising all their rights and obligations under the transaction documents. This document cannot be reproduced except in full, without prior written approval of the Company. Any unauthorized alteration, forgery or falsification of the content or appearance of this document is unlawful and offenders may be prosecuted to the fullest extent of the law. Unless otherwise stated the results shown in this test report refer only to the sample(s) tested and such sample(s) are retained for 30 days only.

Test Mode: 06; Polarity: Horizontal; Modulation:802.11ax(Full RU0); Bandwidth:20MHz; Channel:High

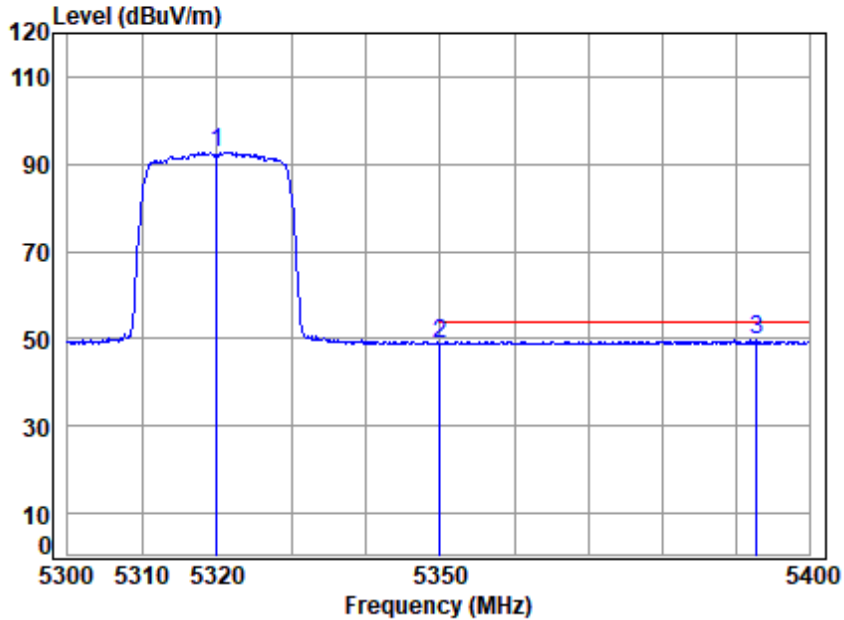

Site : chamber
 Condition: 3m HORIZONTAL
 Job No : 03018AT\03019AT
 Mode : 5320 Band edge
 : 5G WIFI 11AX20

	Freq	Cable Loss	Ant Factor	Preamp Factor	Read Level	Limit Level	Over Limit	Remark
	MHz	dB	dB/m	dB	dBuV	dBuV/m	dBuV/m	dB
1	5320.000	19.07	34.28	35.22	74.58	92.71	-----	Average
2	5350.020	19.11	34.40	35.21	30.68	48.98	54.00	-5.02 Average
3 q	5392.838	19.17	34.57	35.19	30.99	49.54	54.00	-4.46 Average



Unless otherwise agreed in writing, this document is issued by the Company subject to its General Conditions of Service printed overleaf, available on request or accessible at <https://www.sgs.com/en/Terms-and-Conditions>. Attention is drawn to the limitation of liability, indemnification and jurisdiction issues defined therein. Any holder of this document is advised that information contained hereon reflects the Company's findings at the time of its intervention only and within the limits of Client's instructions, if any. The Company's sole responsibility is to its Client and this document does not exonerate parties to a transaction from exercising all their rights and obligations under the transaction documents. This document cannot be reproduced except in full, without prior written approval of the Company. Any unauthorized alteration, forgery or falsification of the content or appearance of this document is unlawful and offenders may be prosecuted to the fullest extent of the law. Unless otherwise stated the results shown in this test report refer only to the sample(s) tested and such sample(s) are retained for 30 days only.

Test Mode: 06; Polarity: Vertical; Modulation:802.11ax(Full RU0); Bandwidth:20MHz; Channel:High

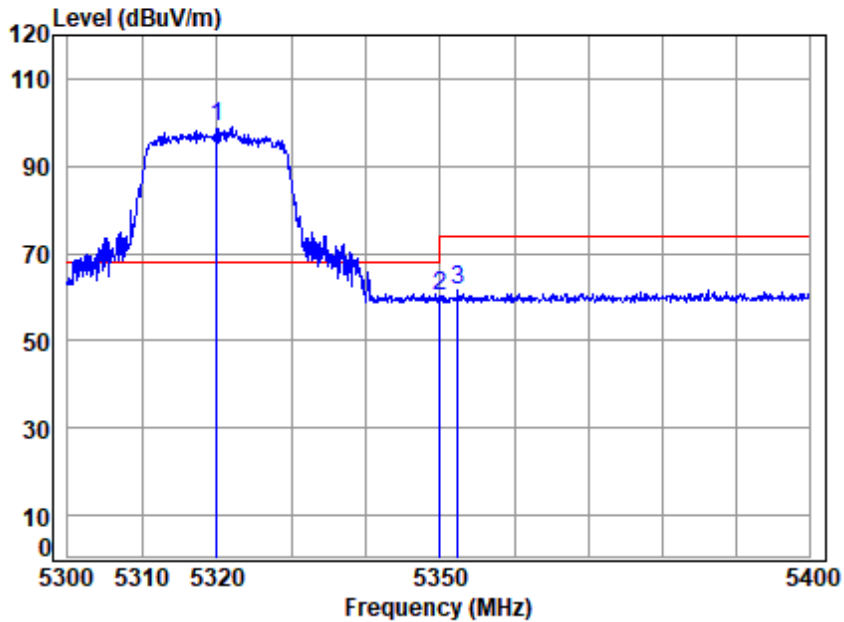

Site : chamber
 Condition: 3m VERTICAL
 Job No : 03018AT\03019AT
 Mode : 5320 Band edge
 : 5G WIFI 11AX20

		Cable	Ant	Preamp	Read	Limit	Over	
Freq	Loss	Factor	Factor	Factor	Level	Level	Line	Limit Remark
MHz	dB	dB/m	dB	dB	dBuV	dBuV/m	dBuV/m	dB
1 p 5320.000	19.07	34.28	35.22	80.69	98.82	68.20	30.62	Peak
2 5350.020	19.11	34.40	35.21	42.07	60.37	74.00	-13.63	Peak
3 5352.367	19.11	34.41	35.21	43.37	61.68	74.00	-12.32	Peak



Unless otherwise agreed in writing, this document is issued by the Company subject to its General Conditions of Service printed overleaf, available on request or accessible at <https://www.sgs.com/en/Terms-and-Conditions>. Attention is drawn to the limitation of liability, indemnification and jurisdiction issues defined therein. Any holder of this document is advised that information contained hereon reflects the Company's findings at the time of its intervention only and within the limits of Client's instructions, if any. The Company's sole responsibility is to its Client and this document does not exonerate parties to a transaction from exercising all their rights and obligations under the transaction documents. This document cannot be reproduced except in full, without prior written approval of the Company. Any unauthorized alteration, forgery or falsification of the content or appearance of this document is unlawful and offenders may be prosecuted to the fullest extent of the law. Unless otherwise stated the results shown in this test report refer only to the sample(s) tested and such sample(s) are retained for 30 days only.

Test Mode: 06; Polarity: Vertical; Modulation:802.11ax(Full RU0); Bandwidth:20MHz; Channel:High

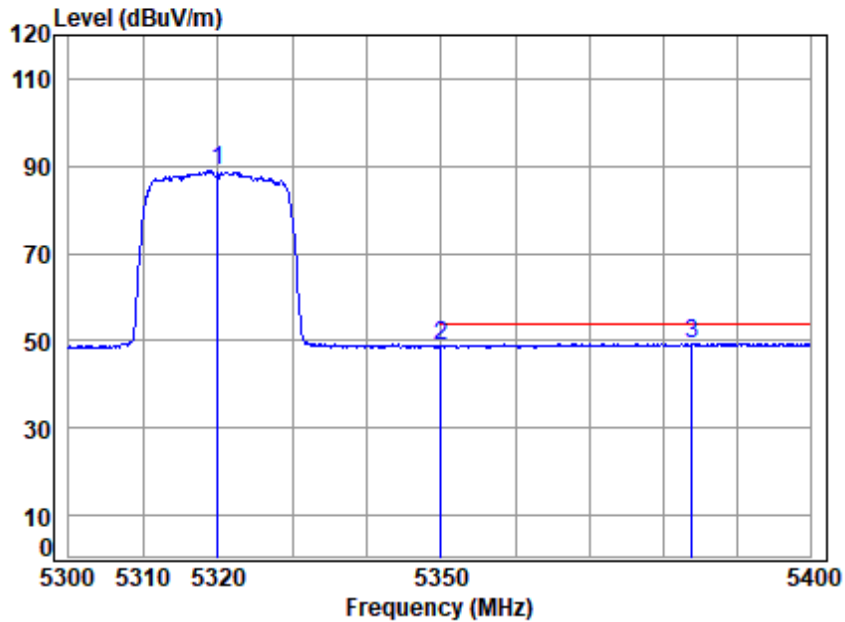

Site : chamber
 Condition: 3m VERTICAL
 Job No : 03018AT\03019AT
 Mode : 5320 Band edge
 : 5G WIFI 11AX20

	Freq	Cable Loss	Ant Factor	Preamp Factor	Read Level	Limit Level	Over Limit	Remark
	MHz	dB	dB/m	dB	dBuV	dBuV/m	dBuV/m	dB
1	5320.000	19.07	34.28	35.22	70.65	88.78	-----	Average
2	5350.020	19.11	34.40	35.21	30.59	48.89	54.00	-5.11 Average
3 q	5383.975	19.16	34.54	35.19	30.95	49.46	54.00	-4.54 Average



Unless otherwise agreed in writing, this document is issued by the Company subject to its General Conditions of Service printed overleaf, available on request or accessible at <https://www.sgs.com/en/Terms-and-Conditions>. Attention is drawn to the limitation of liability, indemnification and jurisdiction issues defined therein. Any holder of this document is advised that information contained hereon reflects the Company's findings at the time of its intervention only and within the limits of Client's instructions, if any. The Company's sole responsibility is to its Client and this document does not exonerate parties to a transaction from exercising all their rights and obligations under the transaction documents. This document cannot be reproduced except in full, without prior written approval of the Company. Any unauthorized alteration, forgery or falsification of the content or appearance of this document is unlawful and offenders may be prosecuted to the fullest extent of the law. Unless otherwise stated the results shown in this test report refer only to the sample(s) tested and such sample(s) are retained for 30 days only.

Test Mode: 06; Polarity: Horizontal; Modulation:802.11ax(26 RU0); Bandwidth:20MHz; Channel:Low

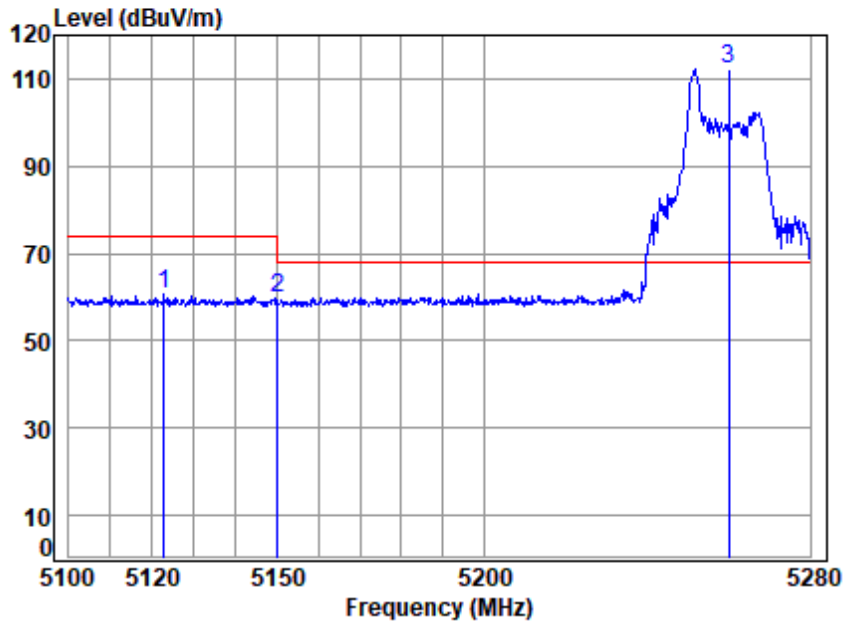

Site	: chamber							
Condition:	3m HORIZONTAL							
Job No	: 03018AT\03019AT							
Mode	: 5260 Band edge							
	: 5G WIFI 11AX20 Partial RU							
	Cable	Ant	Preamp	Read		Limit	Over	
Freq	Loss	Factor	Factor	Level	Level	Line	Limit	Remark
	dB	dB/m	dB	dBuV	dBuV/m	dBuV/m	dB	
1	18.80	33.95	35.32	43.13	60.56	74.00	-13.44	peak
2	18.83	33.90	35.31	42.54	59.96	74.00	-14.04	peak
3 p	18.99	34.12	35.25	94.22	112.08	68.20	43.88	peak



Unless otherwise agreed in writing, this document is issued by the Company subject to its General Conditions of Service printed overleaf, available on request or accessible at <https://www.sgs.com/en/Terms-and-Conditions>. Attention is drawn to the limitation of liability, indemnification and jurisdiction issues defined therein. Any holder of this document is advised that information contained hereon reflects the Company's findings at the time of its intervention only and within the limits of Client's instructions, if any. The Company's sole responsibility is to its Client and this document does not exonerate parties to a transaction from exercising all their rights and obligations under the transaction documents. This document cannot be reproduced except in full, without prior written approval of the Company. Any unauthorized alteration, forgery or falsification of the content or appearance of this document is unlawful and offenders may be prosecuted to the fullest extent of the law. Unless otherwise stated the results shown in this test report refer only to the sample(s) tested and such sample(s) are retained for 30 days only.

Test Mode: 06; Polarity: Horizontal; Modulation:802.11ax(26 RU0); Bandwidth:20MHz; Channel:Low

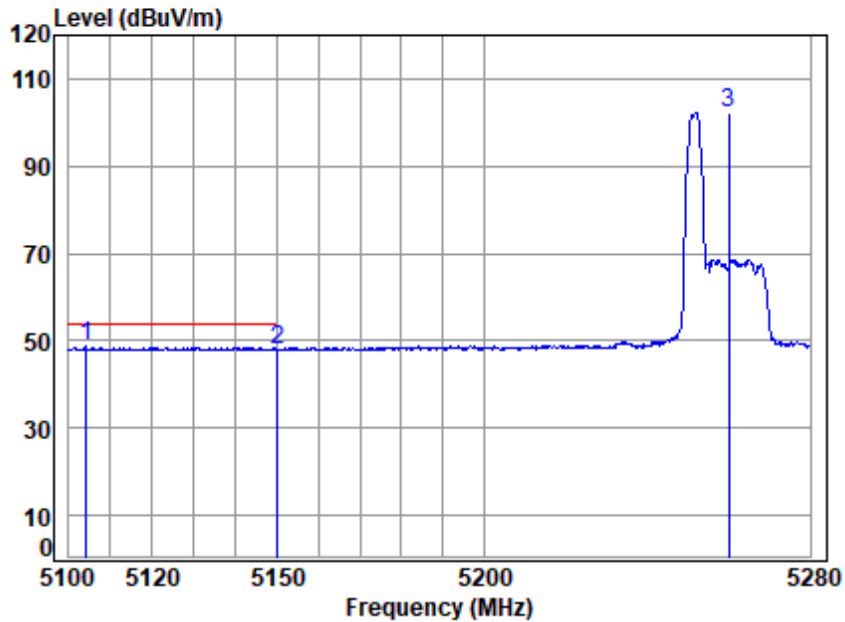

Site : chamber
 Condition: 3m HORIZONTAL
 Job No : 03018AT\03019AT
 Mode : 5260 Band edge
 : 5G WIFI 11AX20 Partial RU

	Cable	Ant	Preamp	Read	Limit	Over		
Freq	Loss	Factor	Factor	Level	Level	Line	Limit	Remark
MHz	dB	dB/m	dB	dBuV	dBuV/m	dBuV/m	dB	
1 q 5104.070	18.77	33.99	35.33	31.21	48.64	54.00	-5.36	Average
2 5149.980	18.83	33.90	35.31	30.69	48.11	54.00	-5.89	Average
3 5260.000	18.99	34.12	35.25	84.56	102.42	-----	-----	Average



Unless otherwise agreed in writing, this document is issued by the Company subject to its General Conditions of Service printed overleaf, available on request or accessible at <https://www.sgs.com/en/Terms-and-Conditions>. Attention is drawn to the limitation of liability, indemnification and jurisdiction issues defined therein. Any holder of this document is advised that information contained hereon reflects the Company's findings at the time of its intervention only and within the limits of Client's instructions, if any. The Company's sole responsibility is to its Client and this document does not exonerate parties to a transaction from exercising all their rights and obligations under the transaction documents. This document cannot be reproduced except in full, without prior written approval of the Company. Any unauthorized alteration, forgery or falsification of the content or appearance of this document is unlawful and offenders may be prosecuted to the fullest extent of the law. Unless otherwise stated the results shown in this test report refer only to the sample(s) tested and such sample(s) are retained for 30 days only.

Test Mode: 06; Polarity: Vertical; Modulation:802.11ax(26 RU0); Bandwidth:20MHz; Channel:Low

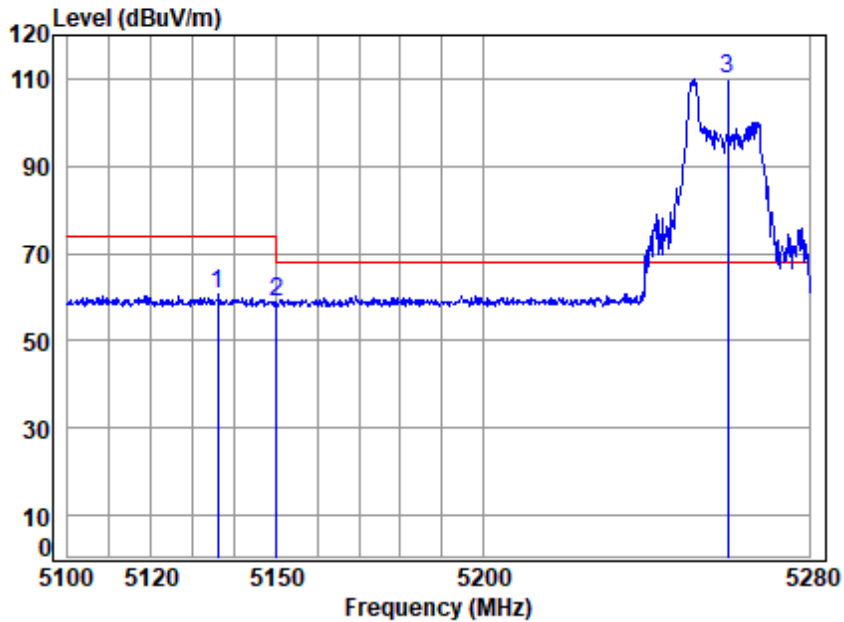

Site	: chamber						
Condition:	3m VERTICAL						
Job No	: 03018AT\03019AT						
Mode	: 5260 Band edge						
	: 5G WIFI 11AX20 Partial RU						
	Cable	Ant	Preamp	Read	Limit	Over	
Freq	Loss	Factor	Factor	Level	Level	Line	Limit Remark
	dB	dB/m	dB	dBuV	dBuV/m	dBuV/m	dB
1	18.81	33.93	35.32	43.11	60.53	74.00	-13.47 Peak
2	18.83	33.90	35.31	41.66	59.08	74.00	-14.92 Peak
3 p	18.99	34.12	35.25	91.94	109.80	68.20	41.60 Peak



Unless otherwise agreed in writing, this document is issued by the Company subject to its General Conditions of Service printed overleaf, available on request or accessible at <https://www.sgs.com/en/Terms-and-Conditions>. Attention is drawn to the limitation of liability, indemnification and jurisdiction issues defined therein. Any holder of this document is advised that information contained hereon reflects the Company's findings at the time of its intervention only and within the limits of Client's instructions, if any. The Company's sole responsibility is to its Client and this document does not exonerate parties to a transaction from exercising all their rights and obligations under the transaction documents. This document cannot be reproduced except in full, without prior written approval of the Company. Any unauthorized alteration, forgery or falsification of the content or appearance of this document is unlawful and offenders may be prosecuted to the fullest extent of the law. Unless otherwise stated the results shown in this test report refer only to the sample(s) tested and such sample(s) are retained for 30 days only.

Attention: To check the authenticity of testing /inspection report & certificate, please contact us at telephone: (86-755) 8307 1443, or email: CN.Doccheck@sgs.com
 No.1 Workshop, M-10, Middle Section, Science & Technology Park, Nanshan District, Shenzhen, Guangdong, China 518057 t (86-755) 26012053 f (86-755) 26710594 www.sgs.com.cn
 中国·广东·深圳市南山区科技园中区M-10栋1号厂房 邮编: 518057 t (86-755) 26012053 f (86-755) 26710594 sgs.china@sgs.com

Test Mode: 06; Polarity: Vertical; Modulation:802.11ax(26 RU0); Bandwidth:20MHz; Channel:Low

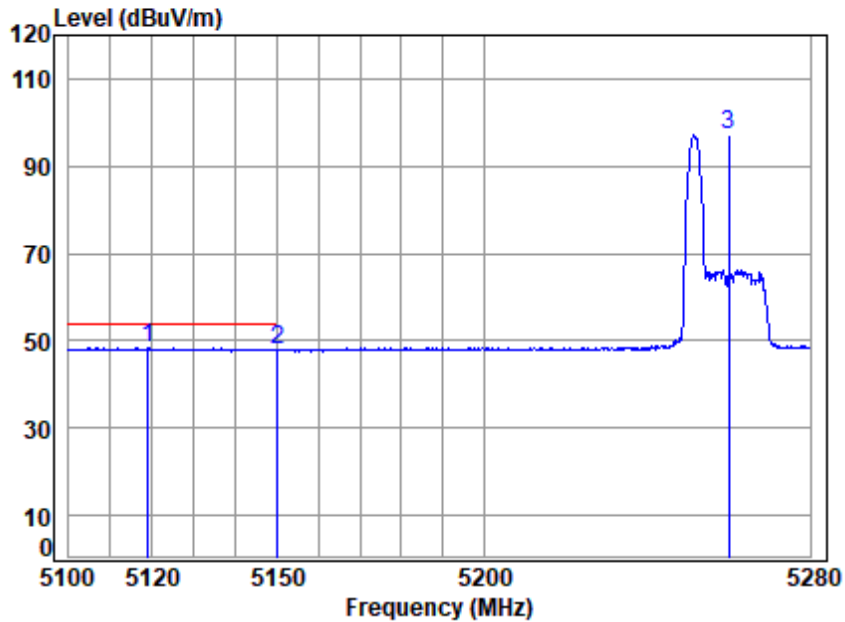

Site : chamber
 Condition: 3m VERTICAL
 Job No : 03018AT\03019AT
 Mode : 5260 Band edge
 : 5G WIFI 11AX20 Partial RU

	Cable	Ant	Preamp	Read	Limit	Over		
Freq	Loss	Factor	Factor	Level	Level	Line	Limit	Remark
MHz	dB	dB/m	dB	dBuV	dBuV/m	dBuV/m	dB	
1 q 5118.963	18.79	33.96	35.33	30.98	48.40	54.00	-5.60	Average
2 5149.980	18.83	33.90	35.31	30.57	47.99	54.00	-6.01	Average
3 5260.000	18.99	34.12	35.25	79.12	96.98	-----	-----	Average



Unless otherwise agreed in writing, this document is issued by the Company subject to its General Conditions of Service printed overleaf, available on request or accessible at <https://www.sgs.com/en/Terms-and-Conditions>. Attention is drawn to the limitation of liability, indemnification and jurisdiction issues defined therein. Any holder of this document is advised that information contained hereon reflects the Company's findings at the time of its intervention only and within the limits of Client's instructions, if any. The Company's sole responsibility is to its Client and this document does not exonerate parties to a transaction from exercising all their rights and obligations under the transaction documents. This document cannot be reproduced except in full, without prior written approval of the Company. Any unauthorized alteration, forgery or falsification of the content or appearance of this document is unlawful and offenders may be prosecuted to the fullest extent of the law. Unless otherwise stated the results shown in this test report refer only to the sample(s) tested and such sample(s) are retained for 30 days only.

Test Mode: 06; Polarity: Horizontal; Modulation:802.11ax(26 RU0); Bandwidth:20MHz; Channel:High

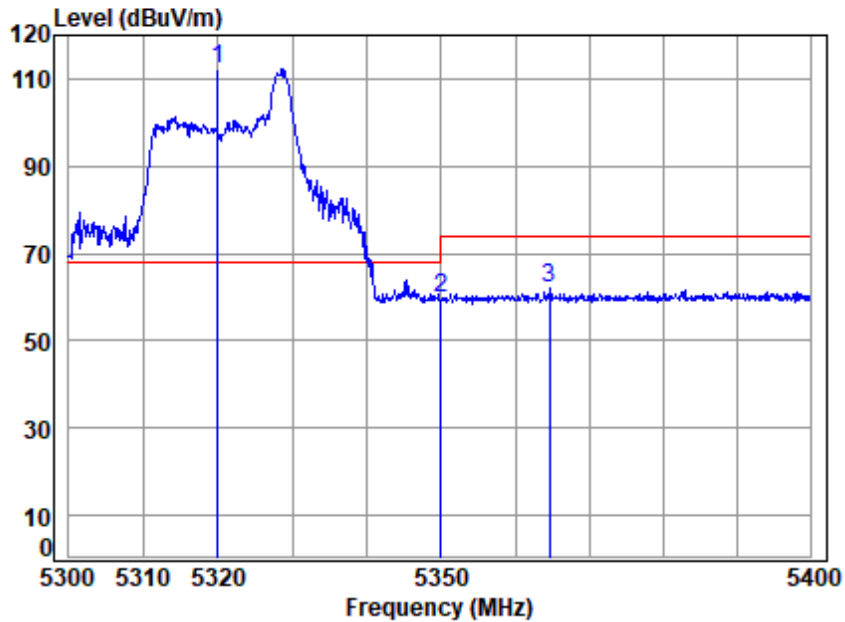

Site	: chamber						
Condition:	3m HORIZONTAL						
Job No	: 03018AT\03019AT						
Mode	: 5320 Band edge						
	: 5G WIFI 11AX20 Partial RU						
	Cable	Ant	Preamp	Read	Limit	Over	
Freq	Loss	Factor	Factor	Level	Level	Line	Limit
	dB	dB/m	dB	dBuV	dBuV/m	dBuV/m	dB
1 p	19.07	34.28	35.22	93.98	112.11	68.20	43.91
2	19.11	34.40	35.21	41.68	59.98	74.00	-14.02
3	19.13	34.46	35.20	43.57	61.96	74.00	-12.04
							peak
							peak
							peak



Unless otherwise agreed in writing, this document is issued by the Company subject to its General Conditions of Service printed overleaf, available on request or accessible at <https://www.sgs.com/en/Terms-and-Conditions>. Attention is drawn to the limitation of liability, indemnification and jurisdiction issues defined therein. Any holder of this document is advised that information contained hereon reflects the Company's findings at the time of its intervention only and within the limits of Client's instructions, if any. The Company's sole responsibility is to its Client and this document does not exonerate parties to a transaction from exercising all their rights and obligations under the transaction documents. This document cannot be reproduced except in full, without prior written approval of the Company. Any unauthorized alteration, forgery or falsification of the content or appearance of this document is unlawful and offenders may be prosecuted to the fullest extent of the law. Unless otherwise stated the results shown in this test report refer only to the sample(s) tested and such sample(s) are retained for 30 days only.

Test Mode: 06; Polarity: Horizontal; Modulation:802.11ax(26 RU0); Bandwidth:20MHz; Channel:High

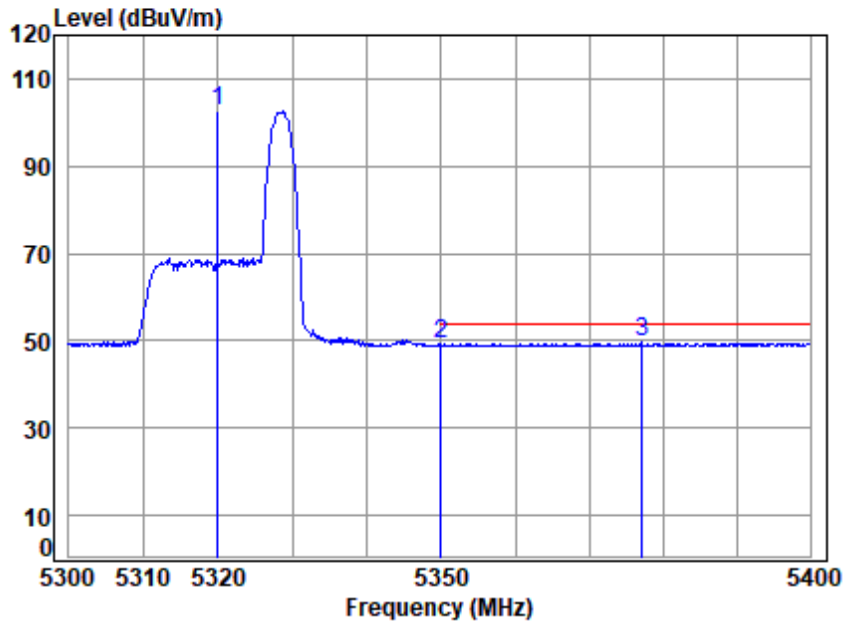

Site : chamber
 Condition: 3m HORIZONTAL
 Job No : 03018AT\03019AT
 Mode : 5320 Band edge

: 5G WIFI 11AX20 Partial RU
 Cable Ant Preamp Read Limit Over
 Freq Loss Factor Factor Level Level Line Limit Remark

	MHz	dB	dB/m	dB	dBuV	dBuV/m	dBuV/m	dB	
1	5320.000	19.07	34.28	35.22	84.31	102.44	-----	-----	Average
2	5350.020	19.11	34.40	35.21	30.75	49.05	54.00	-4.95	Average
3 q	5377.136	19.15	34.51	35.19	31.04	49.51	54.00	-4.49	Average



Unless otherwise agreed in writing, this document is issued by the Company subject to its General Conditions of Service printed overleaf, available on request or accessible at <https://www.sgs.com/en/Terms-and-Conditions>. Attention is drawn to the limitation of liability, indemnification and jurisdiction issues defined therein. Any holder of this document is advised that information contained hereon reflects the Company's findings at the time of its intervention only and within the limits of Client's instructions, if any. The Company's sole responsibility is to its Client and this document does not exonerate parties to a transaction from exercising all their rights and obligations under the transaction documents. This document cannot be reproduced except in full, without prior written approval of the Company. Any unauthorized alteration, forgery or falsification of the content or appearance of this document is unlawful and offenders may be prosecuted to the fullest extent of the law. Unless otherwise stated the results shown in this test report refer only to the sample(s) tested and such sample(s) are retained for 30 days only.

Test Mode: 06; Polarity: Vertical; Modulation:802.11ax(26 RU0); Bandwidth:20MHz; Channel:High

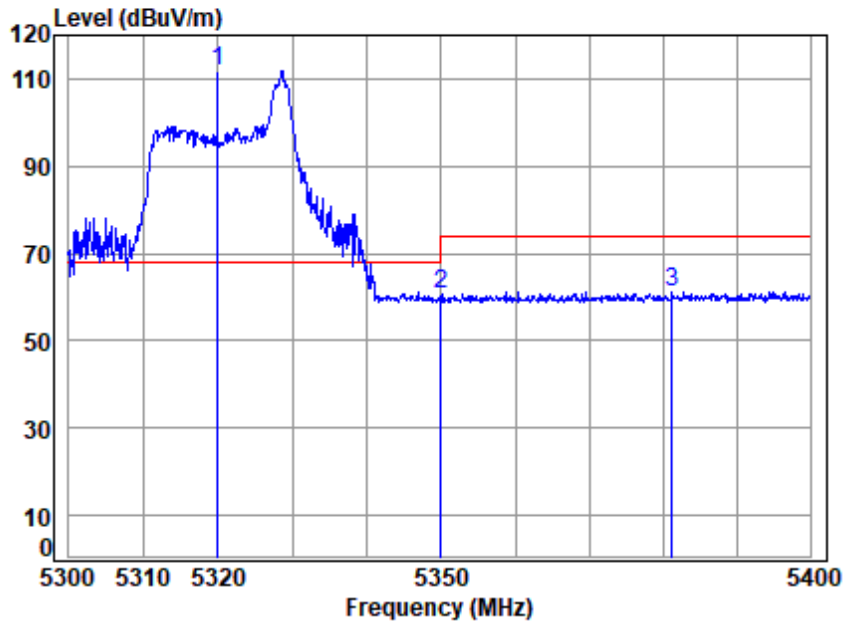

Site	: chamber						
Condition:	3m VERTICAL						
Job No	: 03018AT\03019AT						
Mode	: 5320 Band edge						
	: 5G WIFI 11AX20 Partial RU						
	Cable	Ant	Preamp	Read	Limit	Over	
Freq	Loss Factor	Factor	Factor	Level	Level	Line	Limit Remark
	dB	dB/m	dB	dBuV	dBuV/m	dBuV/m	dB
1 p	5320.000	19.07	34.28	35.22	93.48	111.61	68.20 43.41 Peak
2	5350.020	19.11	34.40	35.21	42.35	60.65	74.00 -13.35 Peak
3	5381.258	19.15	34.53	35.19	42.63	61.12	74.00 -12.88 Peak



Unless otherwise agreed in writing, this document is issued by the Company subject to its General Conditions of Service printed overleaf, available on request or accessible at <https://www.sgs.com/en/Terms-and-Conditions>. Attention is drawn to the limitation of liability, indemnification and jurisdiction issues defined therein. Any holder of this document is advised that information contained hereon reflects the Company's findings at the time of its intervention only and within the limits of Client's instructions, if any. The Company's sole responsibility is to its Client and this document does not exonerate parties to a transaction from exercising all their rights and obligations under the transaction documents. This document cannot be reproduced except in full, without prior written approval of the Company. Any unauthorized alteration, forgery or falsification of the content or appearance of this document is unlawful and offenders may be prosecuted to the fullest extent of the law. Unless otherwise stated the results shown in this test report refer only to the sample(s) tested and such sample(s) are retained for 30 days only.

Test Mode: 06; Polarity: Vertical; Modulation:802.11ax(26 RU0); Bandwidth:20MHz; Channel:High

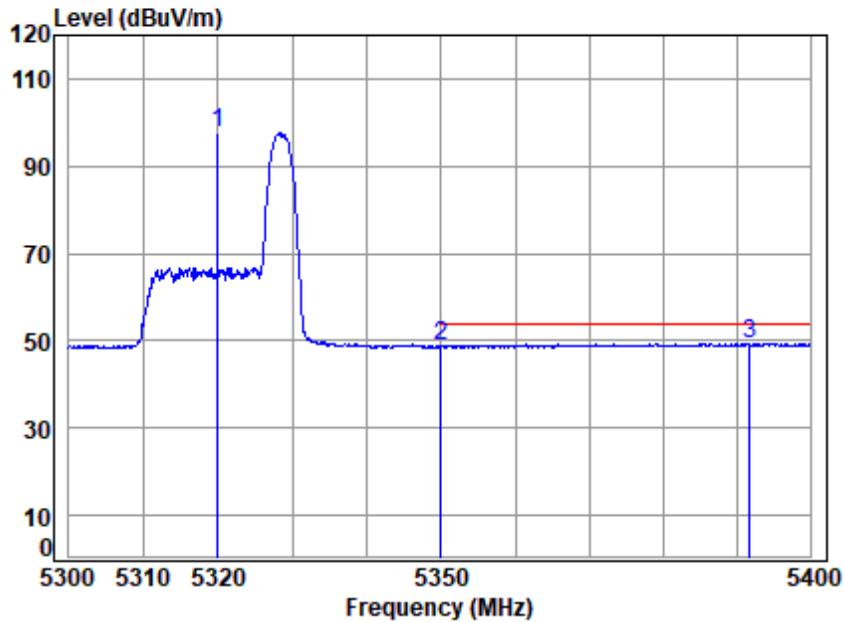

Site : chamber
 Condition: 3m VERTICAL
 Job No : 03018AT\03019AT
 Mode : 5320 Band edge
 : 5G WIFI 11AX20 Partial RU

Freq	Cable Loss	Ant Factor	Preamp Factor	Read Level	Limit Level	Limit Line	Over Limit	Remark
MHz	dB	dB/m	dB	dBuV	dBuV/m	dBuV/m	dB	

Freq	Cable Loss	Ant Factor	Preamp Factor	Read Level	Limit Level	Limit Line	Over Limit	Remark
MHz	dB	dB/m	dB	dBuV	dBuV/m	dBuV/m	dB	
1 5320.000	19.07	34.28	35.22	79.71	97.84	-----	-----	Average
2 5350.020	19.11	34.40	35.21	30.45	48.75	54.00	-5.25	Average
3 q 5391.729	19.17	34.57	35.19	30.93	49.48	54.00	-4.52	Average



Unless otherwise agreed in writing, this document is issued by the Company subject to its General Conditions of Service printed overleaf, available on request or accessible at <https://www.sgs.com/en/Terms-and-Conditions>. Attention is drawn to the limitation of liability, indemnification and jurisdiction issues defined therein. Any holder of this document is advised that information contained hereon reflects the Company's findings at the time of its intervention only and within the limits of Client's instructions, if any. The Company's sole responsibility is to its Client and this document does not exonerate parties to a transaction from exercising all their rights and obligations under the transaction documents. This document cannot be reproduced except in full, without prior written approval of the Company. Any unauthorized alteration, forgery or falsification of the content or appearance of this document is unlawful and offenders may be prosecuted to the fullest extent of the law. Unless otherwise stated the results shown in this test report refer only to the sample(s) tested and such sample(s) are retained for 30 days only.

Test Mode: 07; Polarity: Horizontal; Modulation:802.11a; Bandwidth:20MHz; Channel:Low

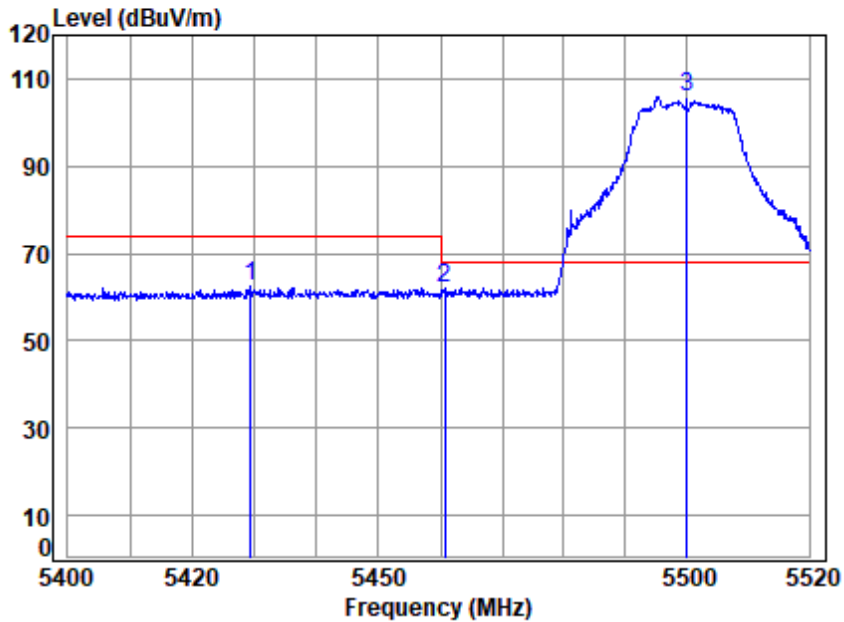

Site : chamber
 Condition: 3m HORIZONTAL
 Job No : 03018AT\03019AT
 Mode : 5500 Band edge
 : 5G WIFI 11A

	Cable	Ant	Preamp	Read	Limit	Over		
Freq	Loss	Factor	Factor	Level	Level	Line	Limit	Remark
MHz	dB	dB/m	dB	dBuV	dBuV/m	dBuV/m	dB	
1	5429.395	19.22	34.66	35.17	43.64	62.35	74.00	-11.65 peak
2	5460.750	19.26	34.66	35.15	43.41	62.18	68.20	-6.02 peak
3 p	5500.000	19.31	34.50	35.13	87.13	105.81	68.20	37.61 peak



Unless otherwise agreed in writing, this document is issued by the Company subject to its General Conditions of Service printed overleaf, available on request or accessible at <https://www.sgs.com/en/Terms-and-Conditions>. Attention is drawn to the limitation of liability, indemnification and jurisdiction issues defined therein. Any holder of this document is advised that information contained hereon reflects the Company's findings at the time of its intervention only and within the limits of Client's instructions, if any. The Company's sole responsibility is to its Client and this document does not exonerate parties to a transaction from exercising all their rights and obligations under the transaction documents. This document cannot be reproduced except in full, without prior written approval of the Company. Any unauthorized alteration, forgery or falsification of the content or appearance of this document is unlawful and offenders may be prosecuted to the fullest extent of the law. Unless otherwise stated the results shown in this test report refer only to the sample(s) tested and such sample(s) are retained for 30 days only.

Test Mode: 07; Polarity: Horizontal; Modulation:802.11a; Bandwidth:20MHz; Channel:Low

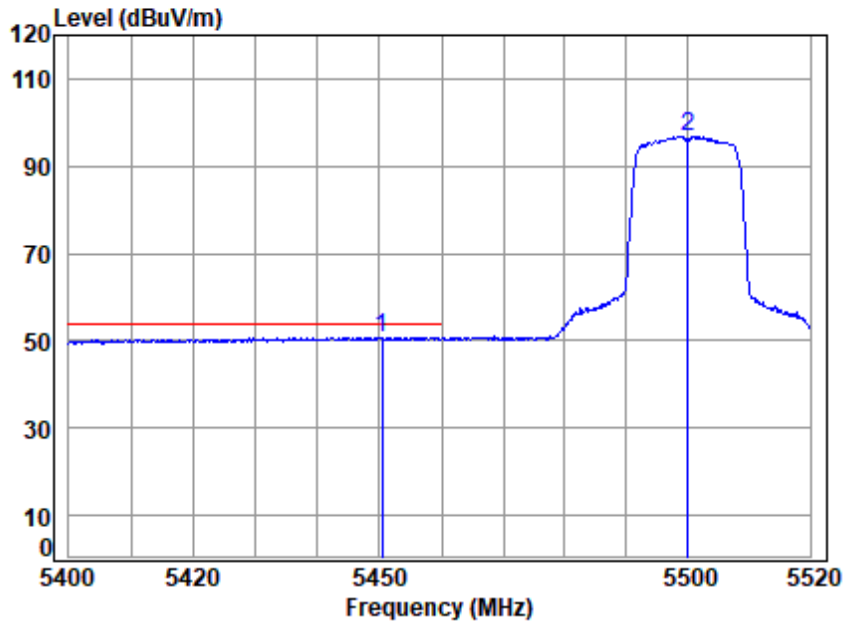

Site : chamber
 Condition: 3m HORIZONTAL
 Job No : 03018AT\03019AT
 Mode : 5500 Band edge
 : 5G WIFI 11A

		Cable	Ant	Preamp	Read	Limit	Over		
	Freq	Loss	Factor	Factor	Level	Level	Line	Limit	Remark
	MHz	dB	dB/m	dB	dBuV	dBuV/m	dBuV/m	dB	
1	q 5450.438	19.24	34.70	35.16	32.09	50.87	54.00	-3.13	Average
2	5500.000	19.31	34.50	35.13	78.21	96.89	-----	-----	Average



Unless otherwise agreed in writing, this document is issued by the Company subject to its General Conditions of Service printed overleaf, available on request or accessible at <https://www.sgs.com/en/Terms-and-Conditions>. Attention is drawn to the limitation of liability, indemnification and jurisdiction issues defined therein. Any holder of this document is advised that information contained hereon reflects the Company's findings at the time of its intervention only and within the limits of Client's instructions, if any. The Company's sole responsibility is to its Client and this document does not exonerate parties to a transaction from exercising all their rights and obligations under the transaction documents. This document cannot be reproduced except in full, without prior written approval of the Company. Any unauthorized alteration, forgery or falsification of the content or appearance of this document is unlawful and offenders may be prosecuted to the fullest extent of the law. Unless otherwise stated the results shown in this test report refer only to the sample(s) tested and such sample(s) are retained for 30 days only.

Test Mode: 07; Polarity: Vertical; Modulation:802.11a; Bandwidth:20MHz; Channel:Low

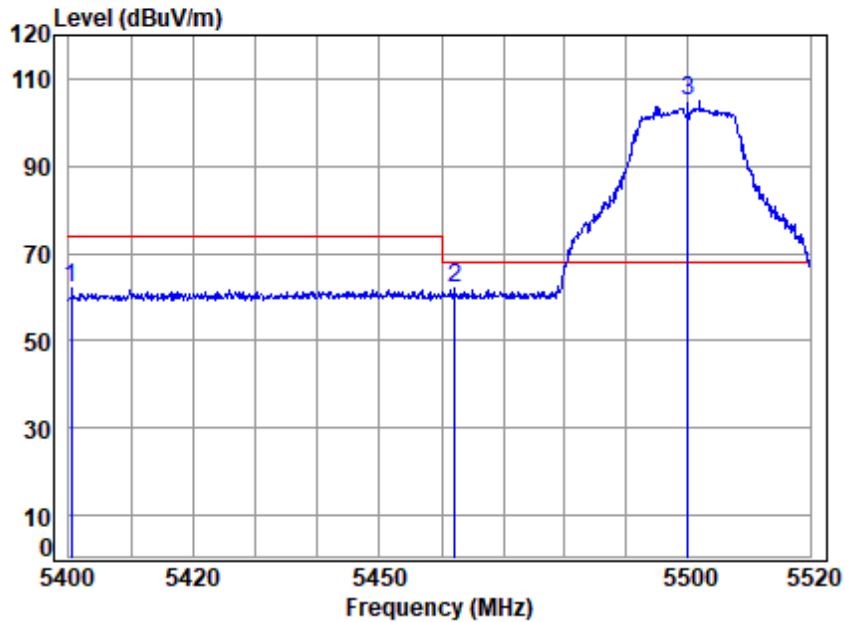

Site : chamber
 Condition: 3m VERTICAL
 Job No : 03018AT\03019AT
 Mode : 5500 Band edge
 : 5G WIFI 11A

	Cable	Ant	Preamp	Read	Limit	Over	
Freq	Loss	Factor	Factor	Level	Level	Line	Limit Remark
MHz	dB	dB/m	dB	dBuV	dBuV/m	dBuV/m	dB
1	19.18	34.60	35.18	43.41	62.01	74.00	-11.99 Peak
2	19.26	34.65	35.15	43.13	61.89	68.20	-6.31 peak
3 p	19.31	34.50	35.13	86.06	104.74	68.20	36.54 Peak



Unless otherwise agreed in writing, this document is issued by the Company subject to its General Conditions of Service printed overleaf, available on request or accessible at <https://www.sgs.com/en/Terms-and-Conditions>. Attention is drawn to the limitation of liability, indemnification and jurisdiction issues defined therein. Any holder of this document is advised that information contained hereon reflects the Company's findings at the time of its intervention only and within the limits of Client's instructions, if any. The Company's sole responsibility is to its Client and this document does not exonerate parties to a transaction from exercising all their rights and obligations under the transaction documents. This document cannot be reproduced except in full, without prior written approval of the Company. Any unauthorized alteration, forgery or falsification of the content or appearance of this document is unlawful and offenders may be prosecuted to the fullest extent of the law. Unless otherwise stated the results shown in this test report refer only to the sample(s) tested and such sample(s) are retained for 30 days only.

Test Mode: 07; Polarity: Vertical; Modulation:802.11a; Bandwidth:20MHz; Channel:Low

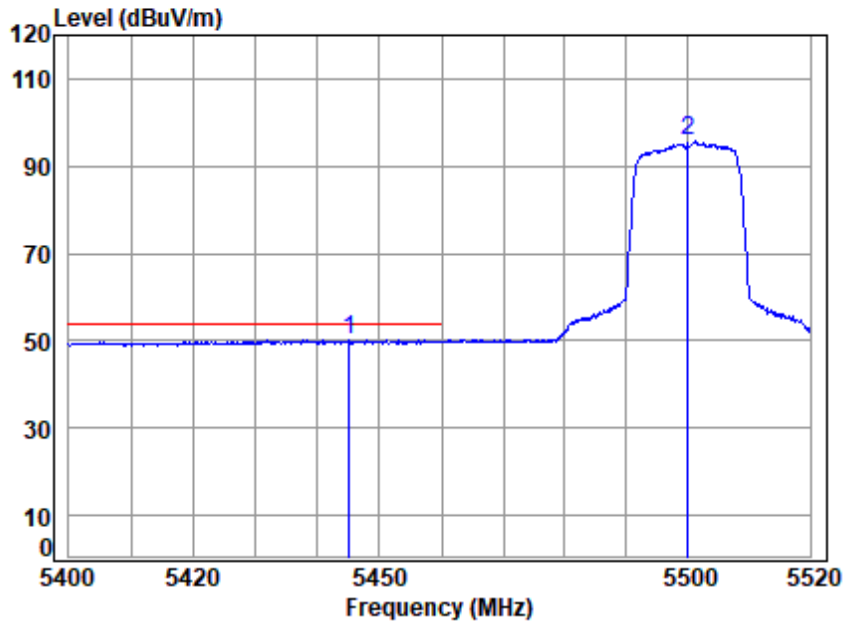

Site : chamber
 Condition: 3m VERTICAL
 Job No : 03018AT\03019AT
 Mode : 5500 Band edge
 : 5G WIFI 11A

		Cable	Ant	Preamp	Read	Limit	Over	
Freq	Loss	Factor	Factor	Factor	Level	Level	Line	Limit Remark
MHz	dB	dB/m	dB	dB	dBuV	dBuV/m	dBuV/m	dB
1 q 5445.170	19.24	34.69	35.16	31.58	50.35	54.00	-3.65	Average
2 5500.000	19.31	34.50	35.13	77.07	95.75	-----	-----	Average



Unless otherwise agreed in writing, this document is issued by the Company subject to its General Conditions of Service printed overleaf, available on request or accessible at <https://www.sgs.com/en/Terms-and-Conditions>. Attention is drawn to the limitation of liability, indemnification and jurisdiction issues defined therein. Any holder of this document is advised that information contained hereon reflects the Company's findings at the time of its intervention only and within the limits of Client's instructions, if any. The Company's sole responsibility is to its Client and this document does not exonerate parties to a transaction from exercising all their rights and obligations under the transaction documents. This document cannot be reproduced except in full, without prior written approval of the Company. Any unauthorized alteration, forgery or falsification of the content or appearance of this document is unlawful and offenders may be prosecuted to the fullest extent of the law. Unless otherwise stated the results shown in this test report refer only to the sample(s) tested and such sample(s) are retained for 30 days only.

Test Mode: 07; Polarity: Horizontal; Modulation:802.11a; Bandwidth:20MHz; Channel:High

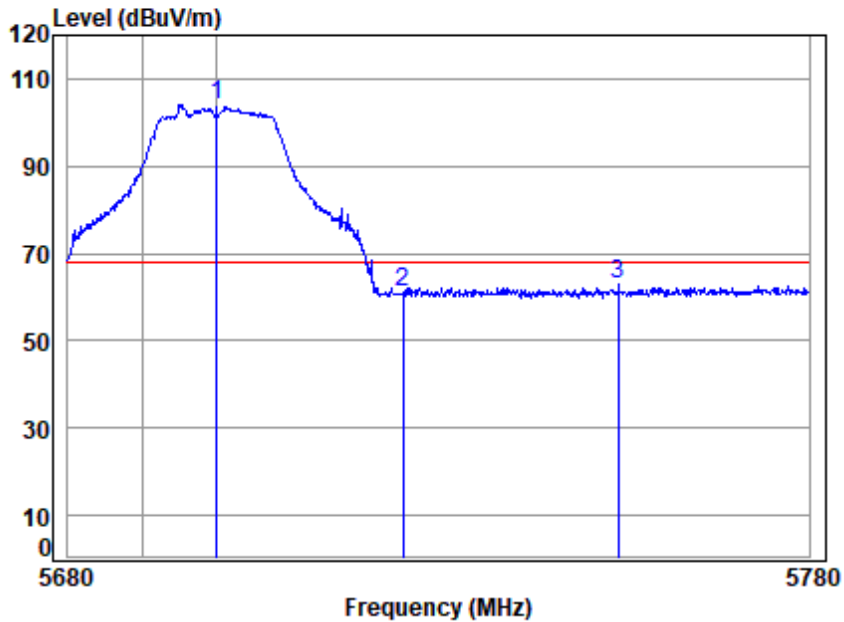

Site : chamber
 Condition: 3m HORIZONTAL
 Job No : 03018AT\03019AT
 Mode : 5700 Band edge
 : 5G WIFI 11A

	Freq	Cable Loss	Ant Factor	Preamp Factor	Read Level	Limit Level	Over Limit	Remark
	MHz	dB	dB/m	dB	dBuV	dBuV/m	dBuV/m	dB
1 p	5700.000	19.44	34.30	35.04	85.29	103.99	68.20	35.79 peak
2	5725.000	19.46	34.25	35.03	42.30	60.98	68.20	-7.22 peak
3	5754.133	19.48	34.21	35.01	44.33	63.01	68.20	-5.19 peak



Unless otherwise agreed in writing, this document is issued by the Company subject to its General Conditions of Service printed overleaf, available on request or accessible at <https://www.sgs.com/en/Terms-and-Conditions>. Attention is drawn to the limitation of liability, indemnification and jurisdiction issues defined therein. Any holder of this document is advised that information contained hereon reflects the Company's findings at the time of its intervention only and within the limits of Client's instructions, if any. The Company's sole responsibility is to its Client and this document does not exonerate parties to a transaction from exercising all their rights and obligations under the transaction documents. This document cannot be reproduced except in full, without prior written approval of the Company. Any unauthorized alteration, forgery or falsification of the content or appearance of this document is unlawful and offenders may be prosecuted to the fullest extent of the law. Unless otherwise stated the results shown in this test report refer only to the sample(s) tested and such sample(s) are retained for 30 days only.

Test Mode: 07; Polarity: Vertical; Modulation:802.11a; Bandwidth:20MHz; Channel:High

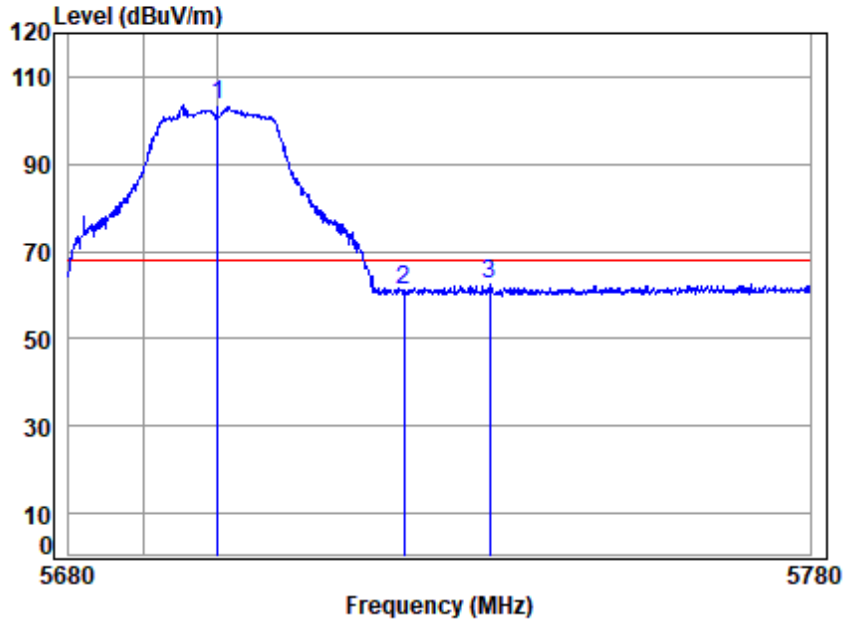

Site : chamber
 Condition: 3m VERTICAL
 Job No : 03018AT\03019AT
 Mode : 5700 Band edge
 : 5G WIFI 11A

	Freq	Cable Loss	Ant Factor	Preamp Factor	Read Level	Limit Level	Over Limit	Remark
	MHz	dB	dB/m	dB	dBuV	dBuV/m	dBuV/m	dB
1 p	5700.000	19.44	34.30	35.04	84.66	103.36	68.20	35.16 Peak
2	5725.000	19.46	34.25	35.03	42.61	61.29	68.20	-6.91 Peak
3	5736.586	19.46	34.23	35.02	43.62	62.29	68.20	-5.91 Peak



Unless otherwise agreed in writing, this document is issued by the Company subject to its General Conditions of Service printed overleaf, available on request or accessible at <https://www.sgs.com/en/Terms-and-Conditions>. Attention is drawn to the limitation of liability, indemnification and jurisdiction issues defined therein. Any holder of this document is advised that information contained hereon reflects the Company's findings at the time of its intervention only and within the limits of Client's instructions, if any. The Company's sole responsibility is to its Client and this document does not exonerate parties to a transaction from exercising all their rights and obligations under the transaction documents. This document cannot be reproduced except in full, without prior written approval of the Company. Any unauthorized alteration, forgery or falsification of the content or appearance of this document is unlawful and offenders may be prosecuted to the fullest extent of the law. Unless otherwise stated the results shown in this test report refer only to the sample(s) tested and such sample(s) are retained for 30 days only.

Test Mode: 07; Polarity: Horizontal; Modulation:802.11ac; Bandwidth:20MHz; Channel:Low

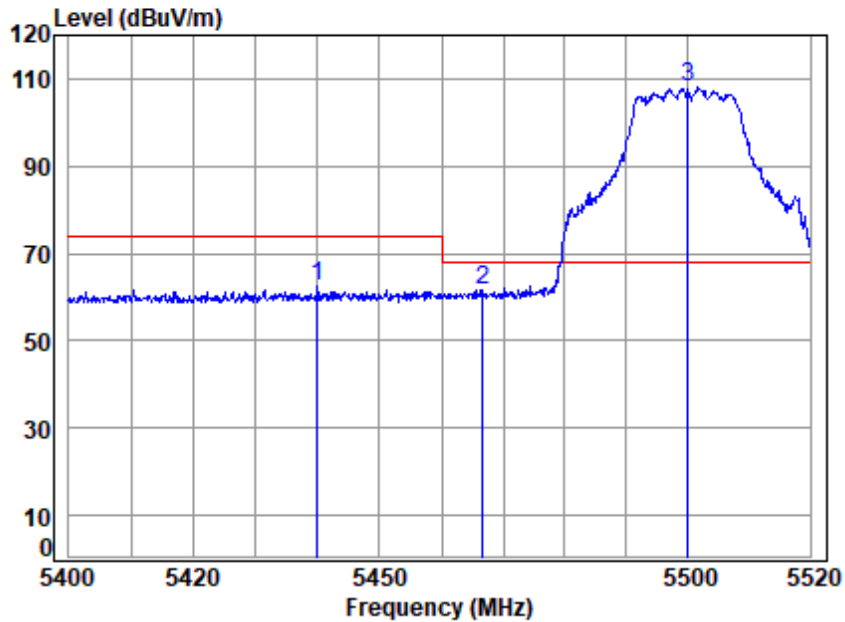

Site : chamber
 Condition: 3m HORIZONTAL
 Job No : 03018AT\03019AT
 Mode : 5500 Band edge
 : 5G WIFI 11AC20

	Cable	Ant	Preamp	Read	Limit	Over		
Freq	Loss	Factor	Factor	Level	Level	Line	Limit	Remark
MHz	dB	dB/m	dB	dBuV	dBuV/m	dBuV/m	dB	
1	5440.026	19.23	34.68	31.43	40.12	62.60	74.00	-11.40 peak
2	5466.755	19.27	34.63	31.44	39.30	61.76	68.20	-6.44 peak
3 p	5500.000	19.31	34.50	31.46	85.86	108.21	68.20	40.01 peak



Unless otherwise agreed in writing, this document is issued by the Company subject to its General Conditions of Service printed overleaf, available on request or accessible at <https://www.sgs.com/en/Terms-and-Conditions>. Attention is drawn to the limitation of liability, indemnification and jurisdiction issues defined therein. Any holder of this document is advised that information contained hereon reflects the Company's findings at the time of its intervention only and within the limits of Client's instructions, if any. The Company's sole responsibility is to its Client and this document does not exonerate parties to a transaction from exercising all their rights and obligations under the transaction documents. This document cannot be reproduced except in full, without prior written approval of the Company. Any unauthorized alteration, forgery or falsification of the content or appearance of this document is unlawful and offenders may be prosecuted to the fullest extent of the law. Unless otherwise stated the results shown in this test report refer only to the sample(s) tested and such sample(s) are retained for 30 days only.

Test Mode: 07; Polarity: Horizontal; Modulation:802.11ac; Bandwidth:20MHz; Channel:Low

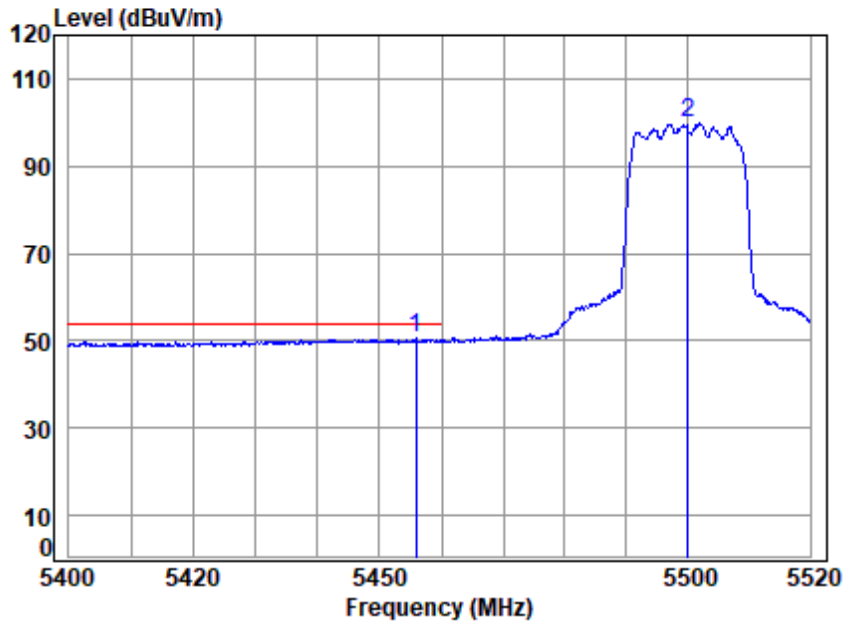

Site : chamber
 Condition: 3m HORIZONTAL
 Job No : 03018AT\03019AT
 Mode : 5500 Band edge
 : 5G WIFI 11AC20

		Cable	Ant	Preamp	Read	Limit	Over		
	Freq	Loss	Factor	Factor	Level	Level	Line	Limit	Remark
	MHz	dB	dB/m	dB	dBuV	dBuV/m	dBuV/m	dB	
1	q 5455.832	19.25	34.68	31.44	27.99	50.48	54.00	-3.52	Average
2	5500.000	19.31	34.50	31.46	77.36	99.71	-----	-----	Average



Test Mode: 07; Polarity: Vertical; Modulation:802.11ac; Bandwidth:20MHz; Channel:Low

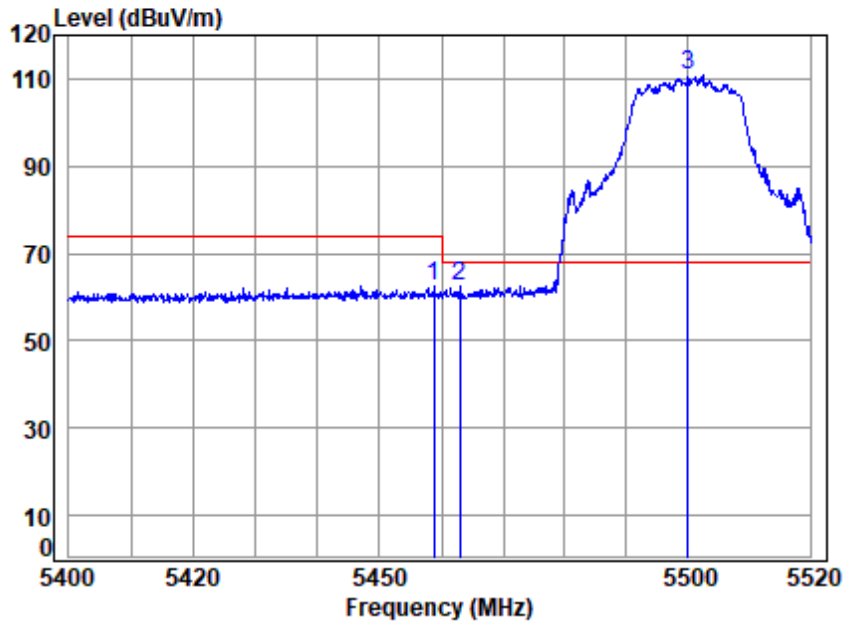

Site : chamber
 Condition: 3m VERTICAL
 Job No : 03018AT\03019AT
 Mode : 5500 Band edge
 : 5G WIFI 11AC20

		Cable	Ant	Preamp	Read	Limit	Over	
Freq	Loss	Factor	Factor	Factor	Level	Level	Line	Limit Remark
MHz	dB	dB/m	dB	dB	dBuV	dBuV/m	dBuV/m	dB
1	5458.710	19.26	34.67	31.44	40.02	62.51	74.00	-11.49 Peak
2	5463.031	19.26	34.65	31.44	40.17	62.64	68.20	-5.56 peak
3 p	5500.000	19.31	34.50	31.46	88.48	110.83	68.20	42.63 Peak



Unless otherwise agreed in writing, this document is issued by the Company subject to its General Conditions of Service printed overleaf, available on request or accessible at <https://www.sgs.com/en/Terms-and-Conditions>. Attention is drawn to the limitation of liability, indemnification and jurisdiction issues defined therein. Any holder of this document is advised that information contained hereon reflects the Company's findings at the time of its intervention only and within the limits of Client's instructions, if any. The Company's sole responsibility is to its Client and this document does not exonerate parties to a transaction from exercising all their rights and obligations under the transaction documents. This document cannot be reproduced except in full, without prior written approval of the Company. Any unauthorized alteration, forgery or falsification of the content or appearance of this document is unlawful and offenders may be prosecuted to the fullest extent of the law. Unless otherwise stated the results shown in this test report refer only to the sample(s) tested and such sample(s) are retained for 30 days only.

Test Mode: 07; Polarity: Vertical; Modulation:802.11ac; Bandwidth:20MHz; Channel:Low

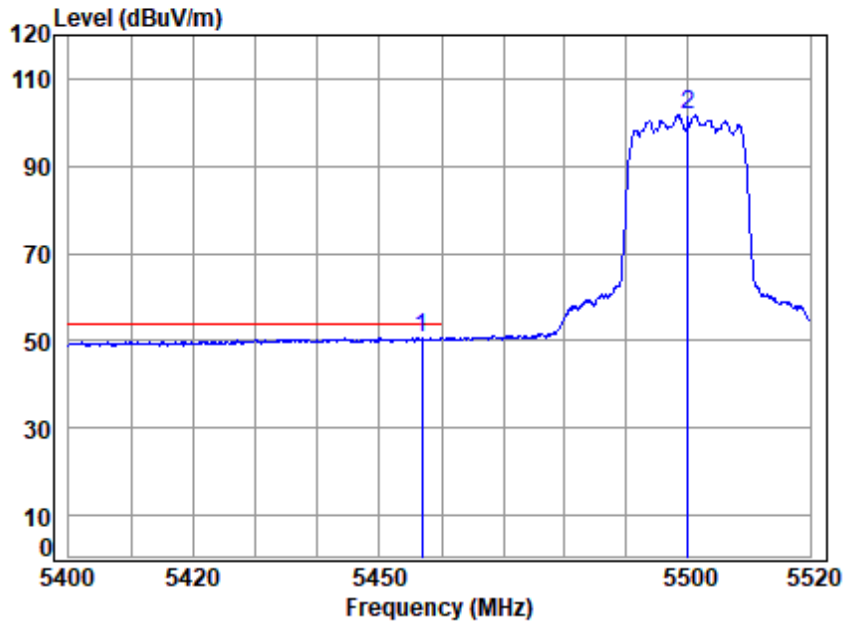

Site : chamber
 Condition: 3m VERTICAL
 Job No : 03018AT\03019AT
 Mode : 5500 Band edge
 : 5G WIFI 11AC20

		Cable	Ant	Preamp	Read	Limit	Over		
	Freq	Loss	Factor	Factor	Level	Line	Limit	Remark	
	MHz	dB	dB/m	dB	dBuV	dBuV/m	dBuV/m	dB	
1	q 5456.911	19.25	34.67	31.44	28.34	50.82	54.00	-3.18	Average
2	5500.000	19.31	34.50	31.46	79.48	101.83	-----	-----	Average



Unless otherwise agreed in writing, this document is issued by the Company subject to its General Conditions of Service printed overleaf, available on request or accessible at <https://www.sgs.com/en/Terms-and-Conditions>. Attention is drawn to the limitation of liability, indemnification and jurisdiction issues defined therein. Any holder of this document is advised that information contained hereon reflects the Company's findings at the time of its intervention only and within the limits of Client's instructions, if any. The Company's sole responsibility is to its Client and this document does not exonerate parties to a transaction from exercising all their rights and obligations under the transaction documents. This document cannot be reproduced except in full, without prior written approval of the Company. Any unauthorized alteration, forgery or falsification of the content or appearance of this document is unlawful and offenders may be prosecuted to the fullest extent of the law. Unless otherwise stated the results shown in this test report refer only to the sample(s) tested and such sample(s) are retained for 30 days only.

Test Mode: 07; Polarity: Horizontal; Modulation:802.11ac; Bandwidth:20MHz; Channel:High

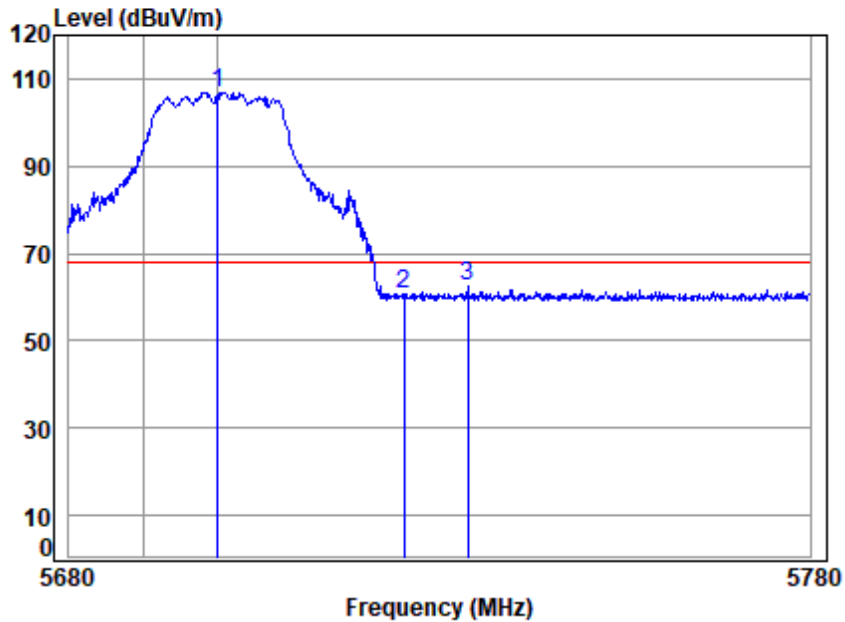

Site : chamber
 Condition: 3m HORIZONTAL
 Job No : 03018AT\03019AT
 Mode : 5700 Band edge
 : 5G WIFI 11AC20

	Freq	Cable Loss	Ant Factor	Preamp Factor	Read Level	Limit Line	Over Limit	Remark
	MHz	dB	dB/m	dB	dBuV	dBuV/m	dB	
1 p	5700.000	19.44	34.30	31.56	84.75	68.20	38.73	peak
2	5725.000	19.46	34.25	31.57	38.63	68.20	-7.43	peak
3	5733.583	19.46	34.23	31.58	40.28	68.20	-5.81	peak



Unless otherwise agreed in writing, this document is issued by the Company subject to its General Conditions of Service printed overleaf, available on request or accessible at <https://www.sgs.com/en/Terms-and-Conditions>. Attention is drawn to the limitation of liability, indemnification and jurisdiction issues defined therein. Any holder of this document is advised that information contained hereon reflects the Company's findings at the time of its intervention only and within the limits of Client's instructions, if any. The Company's sole responsibility is to its Client and this document does not exonerate parties to a transaction from exercising all their rights and obligations under the transaction documents. This document cannot be reproduced except in full, without prior written approval of the Company. Any unauthorized alteration, forgery or falsification of the content or appearance of this document is unlawful and offenders may be prosecuted to the fullest extent of the law. Unless otherwise stated the results shown in this test report refer only to the sample(s) tested and such sample(s) are retained for 30 days only.

Test Mode: 07; Polarity: Vertical; Modulation:802.11ac; Bandwidth:20MHz; Channel:High

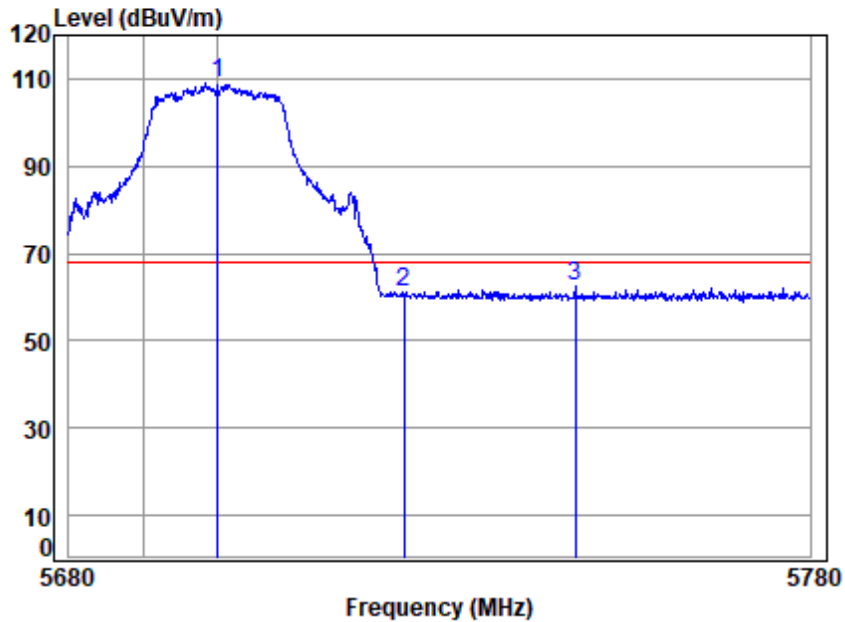

Site : chamber
 Condition: 3m VERTICAL
 Job No : 03018AT\03019AT
 Mode : 5700 Band edge
 : 5G WIFI 11AC20

	Cable	Ant	Preamp	Read	Limit	Over	
Freq	Loss	Factor	Factor	Level	Level	Line	Limit Remark
MHz	dB	dB/m	dB	dBuV	dBuV/m	dBuV/m	dB
1 p 5700.000	19.44	34.30	31.56	86.71	108.89	68.20	40.69 Peak
2 5725.000	19.46	34.25	31.57	39.12	61.26	68.20	-6.94 Peak
3 5748.111	19.47	34.20	31.58	40.24	62.33	68.20	-5.87 Peak



Unless otherwise agreed in writing, this document is issued by the Company subject to its General Conditions of Service printed overleaf, available on request or accessible at <https://www.sgs.com/en/Terms-and-Conditions>. Attention is drawn to the limitation of liability, indemnification and jurisdiction issues defined therein. Any holder of this document is advised that information contained hereon reflects the Company's findings at the time of its intervention only and within the limits of Client's instructions, if any. The Company's sole responsibility is to its Client and this document does not exonerate parties to a transaction from exercising all their rights and obligations under the transaction documents. This document cannot be reproduced except in full, without prior written approval of the Company. Any unauthorized alteration, forgery or falsification of the content or appearance of this document is unlawful and offenders may be prosecuted to the fullest extent of the law. Unless otherwise stated the results shown in this test report refer only to the sample(s) tested and such sample(s) are retained for 30 days only.

Test Mode: 07; Polarity: Horizontal; Modulation:802.11ac; Bandwidth:40MHz; Channel:Low

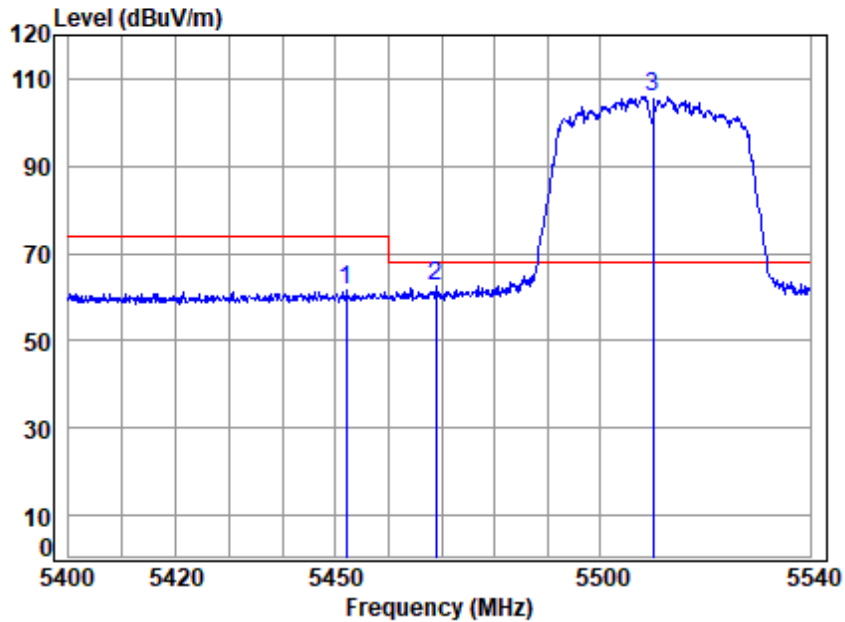

Site : chamber
 Condition: 3m HORIZONTAL
 Job No : 03018AT\03019AT
 Mode : 5510 Band edge
 : 5G WIFI 11AC40

	Cable	Ant	Preamp	Read	Limit	Over		
Freq	Loss	Factor	Factor	Level	Level	Line	Limit	Remark
MHz	dB	dB/m	dB	dBuV	dBuV/m	dBuV/m	dB	
1	5452.081	19.25	34.69	31.44	39.14	61.64	74.00	-12.36 peak
2	5468.852	19.27	34.62	31.45	40.14	62.58	68.20	-5.62 peak
3 p	5510.000	19.32	34.54	31.47	83.38	105.77	68.20	37.57 peak



Unless otherwise agreed in writing, this document is issued by the Company subject to its General Conditions of Service printed overleaf, available on request or accessible at <https://www.sgs.com/en/Terms-and-Conditions>. Attention is drawn to the limitation of liability, indemnification and jurisdiction issues defined therein. Any holder of this document is advised that information contained hereon reflects the Company's findings at the time of its intervention only and within the limits of Client's instructions, if any. The Company's sole responsibility is to its Client and this document does not exonerate parties to a transaction from exercising all their rights and obligations under the transaction documents. This document cannot be reproduced except in full, without prior written approval of the Company. Any unauthorized alteration, forgery or falsification of the content or appearance of this document is unlawful and offenders may be prosecuted to the fullest extent of the law. Unless otherwise stated the results shown in this test report refer only to the sample(s) tested and such sample(s) are retained for 30 days only.

Attention: To check the authenticity of testing /inspection report & certificate, please contact us at telephone: (86-755) 8307 1443, or email: CN.Doccheck@sgs.com
 No.1 Workshop, M-10, Middle Section, Science & Technology Park, Nanshan District, Shenzhen, Guangdong, China 518057 t (86-755) 26012053 f (86-755) 26710594 www.sgs.com.cn
 中国·广东·深圳市南山区科技园中区M-10栋1号厂房 邮编: 518057 t (86-755) 26012053 f (86-755) 26710594 sgs.china@sgs.com

Test Mode: 07; Polarity: Horizontal; Modulation:802.11ac; Bandwidth:40MHz; Channel:Low

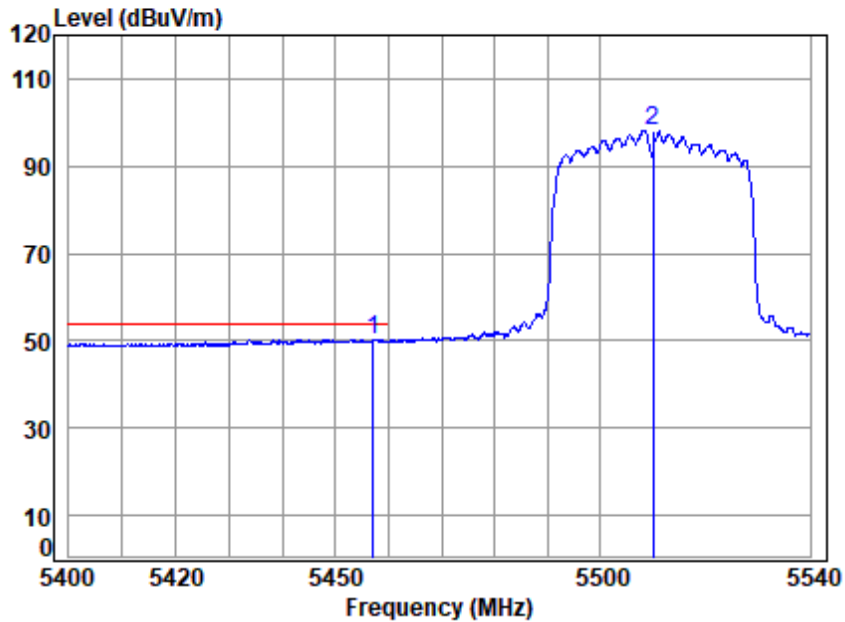

Site : chamber
 Condition: 3m HORIZONTAL
 Job No : 03018AT\03019AT
 Mode : 5510 Band edge
 : 5G WIFI 11AC40

		Cable	Ant	Preamp	Read	Limit	Over		
	Freq	Loss	Factor	Factor	Level	Level	Line	Limit	Remark
	MHz	dB	dB/m	dB	dBuV	dBuV/m	dBuV/m	dB	
1 q	5457.106	19.25	34.67	31.44	27.88	50.36	54.00	-3.64	Average
2	5510.000	19.32	34.54	31.47	75.90	98.29	-----	-----	Average



Unless otherwise agreed in writing, this document is issued by the Company subject to its General Conditions of Service printed overleaf, available on request or accessible at <https://www.sgs.com/en/Terms-and-Conditions>. Attention is drawn to the limitation of liability, indemnification and jurisdiction issues defined therein. Any holder of this document is advised that information contained hereon reflects the Company's findings at the time of its intervention only and within the limits of Client's instructions, if any. The Company's sole responsibility is to its Client and this document does not exonerate parties to a transaction from exercising all their rights and obligations under the transaction documents. This document cannot be reproduced except in full, without prior written approval of the Company. Any unauthorized alteration, forgery or falsification of the content or appearance of this document is unlawful and offenders may be prosecuted to the fullest extent of the law. Unless otherwise stated the results shown in this test report refer only to the sample(s) tested and such sample(s) are retained for 30 days only.

Test Mode: 07; Polarity: Vertical; Modulation:802.11ac; Bandwidth:40MHz; Channel:Low

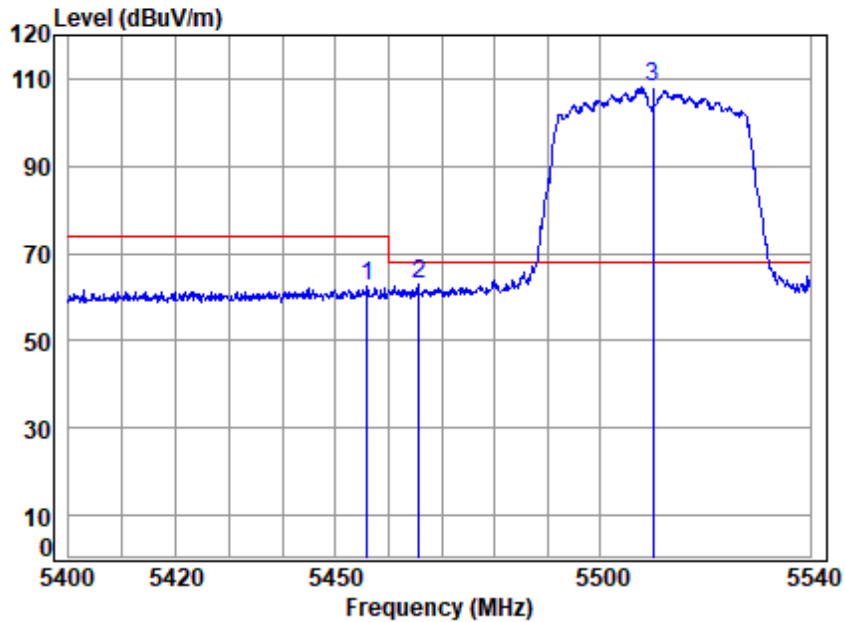

Site : chamber
 Condition: 3m VERTICAL
 Job No : 03018AT\03019AT
 Mode : 5510 Band edge
 : 5G WIFI 11AC40

	Freq	Cable Loss	Ant Factor	Preamp Factor	Read Level	Limit Level	Over Limit	Remark
	MHz	dB	dB/m	dB	dBuV	dBuV/m	dBuV/m	dB
1	5455.989	19.25	34.68	31.44	40.12	62.61	74.00	-11.39 Peak
2	5465.634	19.26	34.64	31.44	40.44	62.90	68.20	-5.30 peak
3 p	5510.000	19.32	34.54	31.47	85.66	108.05	68.20	39.85 Peak



Unless otherwise agreed in writing, this document is issued by the Company subject to its General Conditions of Service printed overleaf, available on request or accessible at <https://www.sgs.com/en/Terms-and-Conditions>. Attention is drawn to the limitation of liability, indemnification and jurisdiction issues defined therein. Any holder of this document is advised that information contained hereon reflects the Company's findings at the time of its intervention only and within the limits of Client's instructions, if any. The Company's sole responsibility is to its Client and this document does not exonerate parties to a transaction from exercising all their rights and obligations under the transaction documents. This document cannot be reproduced except in full, without prior written approval of the Company. Any unauthorized alteration, forgery or falsification of the content or appearance of this document is unlawful and offenders may be prosecuted to the fullest extent of the law. Unless otherwise stated the results shown in this test report refer only to the sample(s) tested and such sample(s) are retained for 30 days only.

Test Mode: 07; Polarity: Vertical; Modulation:802.11ac; Bandwidth:40MHz; Channel:Low

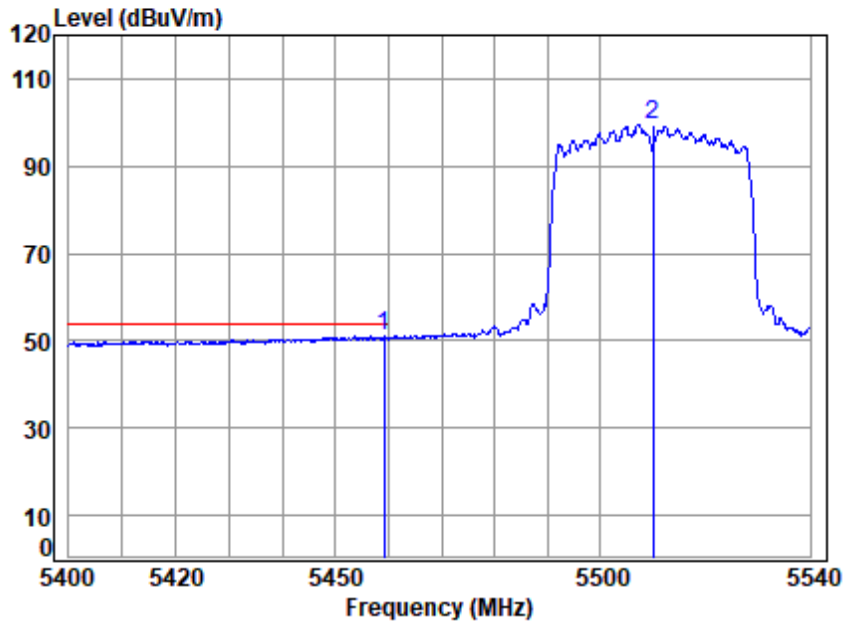

Site : chamber
 Condition: 3m VERTICAL
 Job No : 03018AT\03019AT
 Mode : 5510 Band edge
 : 5G WIFI 11AC40

		Cable	Ant	Preamp	Read	Limit	Over		
	Freq	Loss	Factor	Factor	Level	Level	Line	Limit	Remark
	MHz	dB	dB/m	dB	dBuV	dBuV/m	dBuV/m	dB	
1	q 5459.063	19.26	34.66	31.44	28.44	50.92	54.00	-3.08	Average
2	5510.000	19.32	34.54	31.47	77.17	99.56	-----	-----	Average



Unless otherwise agreed in writing, this document is issued by the Company subject to its General Conditions of Service printed overleaf, available on request or accessible at <https://www.sgs.com/en/Terms-and-Conditions>. Attention is drawn to the limitation of liability, indemnification and jurisdiction issues defined therein. Any holder of this document is advised that information contained hereon reflects the Company's findings at the time of its intervention only and within the limits of Client's instructions, if any. The Company's sole responsibility is to its Client and this document does not exonerate parties to a transaction from exercising all their rights and obligations under the transaction documents. This document cannot be reproduced except in full, without prior written approval of the Company. Any unauthorized alteration, forgery or falsification of the content or appearance of this document is unlawful and offenders may be prosecuted to the fullest extent of the law. Unless otherwise stated the results shown in this test report refer only to the sample(s) tested and such sample(s) are retained for 30 days only.

Test Mode: 07; Polarity: Horizontal; Modulation:802.11ac; Bandwidth:40MHz; Channel:High

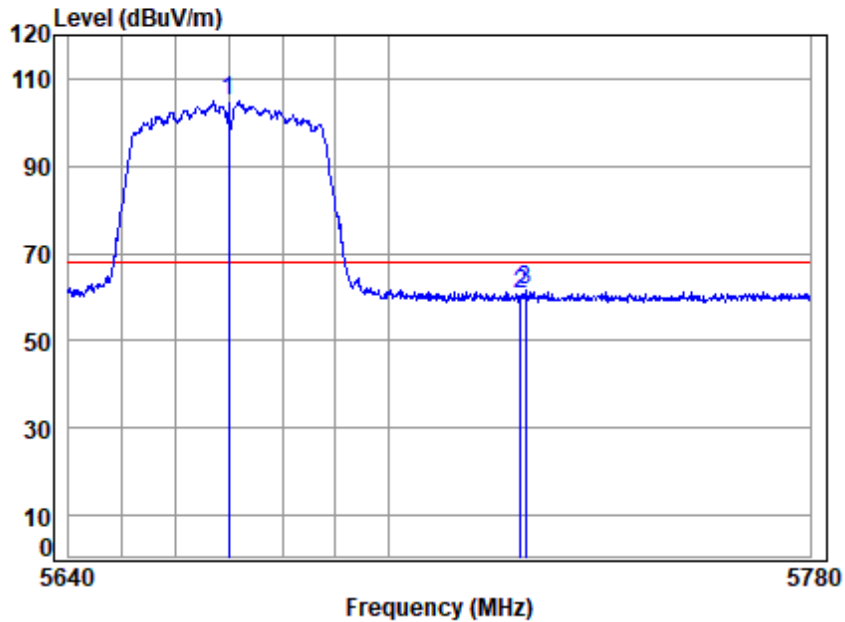

Site : chamber
 Condition: 3m HORIZONTAL
 Job No : 03018AT\03019AT
 Mode : 5670 Band edge
 : 5G WIFI 11AC40

		Cable	Ant	Preamp	Read	Limit	Over	
	Freq	Loss	Factor	Factor	Level	Line	Limit	Remark
	MHz	dB	dB/m	dB	dBuV	dBuV/m	dBuV/m	dB
1 p	5670.000	19.42	34.36	31.54	82.52	104.76	68.20	36.56 peak
2	5725.000	19.46	34.25	31.57	38.35	60.49	68.20	-7.71 peak
3	5725.833	19.46	34.25	31.57	39.45	61.59	68.20	-6.61 peak



Unless otherwise agreed in writing, this document is issued by the Company subject to its General Conditions of Service printed overleaf, available on request or accessible at <https://www.sgs.com/en/Terms-and-Conditions>. Attention is drawn to the limitation of liability, indemnification and jurisdiction issues defined therein. Any holder of this document is advised that information contained hereon reflects the Company's findings at the time of its intervention only and within the limits of Client's instructions, if any. The Company's sole responsibility is to its Client and this document does not exonerate parties to a transaction from exercising all their rights and obligations under the transaction documents. This document cannot be reproduced except in full, without prior written approval of the Company. Any unauthorized alteration, forgery or falsification of the content or appearance of this document is unlawful and offenders may be prosecuted to the fullest extent of the law. Unless otherwise stated the results shown in this test report refer only to the sample(s) tested and such sample(s) are retained for 30 days only.

Test Mode: 07; Polarity: Vertical; Modulation:802.11ac; Bandwidth:40MHz; Channel:High

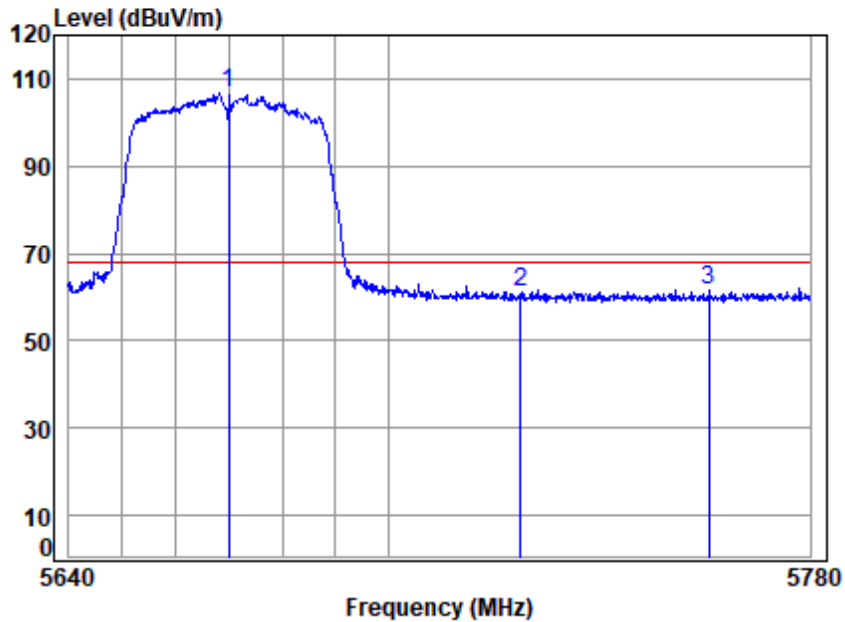

Site : chamber
 Condition: 3m VERTICAL
 Job No : 03018AT\03019AT
 Mode : 5670 Band edge
 : 5G WIFI 11AC40

	Freq	Cable Loss	Ant Factor	Preamp Factor	Read Level	Limit Level	Over Limit	Remark
	MHz	dB	dB/m	dB	dBuV	dBuV/m	dBuV/m	dB
1 p	5670.000	19.42	34.36	31.54	84.66	106.90	68.20	38.70 Peak
2	5725.000	19.46	34.25	31.57	38.79	60.93	68.20	-7.27 Peak
3	5760.617	19.48	34.22	31.59	39.59	61.70	68.20	-6.50 Peak



Unless otherwise agreed in writing, this document is issued by the Company subject to its General Conditions of Service printed overleaf, available on request or accessible at <https://www.sgs.com/en/Terms-and-Conditions>. Attention is drawn to the limitation of liability, indemnification and jurisdiction issues defined therein. Any holder of this document is advised that information contained hereon reflects the Company's findings at the time of its intervention only and within the limits of Client's instructions, if any. The Company's sole responsibility is to its Client and this document does not exonerate parties to a transaction from exercising all their rights and obligations under the transaction documents. This document cannot be reproduced except in full, without prior written approval of the Company. Any unauthorized alteration, forgery or falsification of the content or appearance of this document is unlawful and offenders may be prosecuted to the fullest extent of the law. Unless otherwise stated the results shown in this test report refer only to the sample(s) tested and such sample(s) are retained for 30 days only.

Test Mode: 07; Polarity: Horizontal; Modulation:802.11ac; Bandwidth:80MHz; Channel:Low

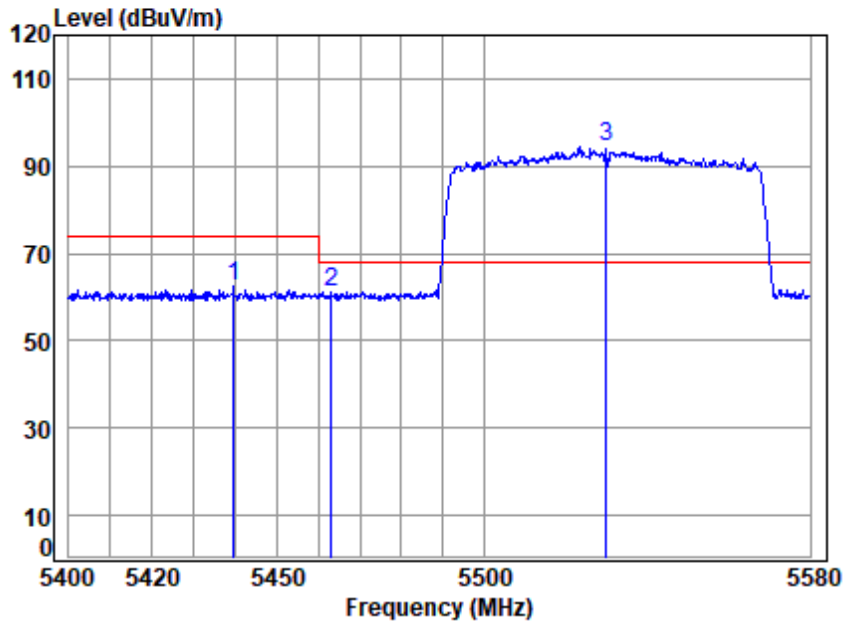

Site : chamber
 Condition: 3m HORIZONTAL
 Job No : 03018AT\03019AT
 Mode : 5530 Band edge
 : 5G WIFI 11AC80

	Cable	Ant	Preamp	Read	Limit	Over		
Freq	Loss	Factor	Factor	Level	Level	Line	Limit	Remark
MHz	dB	dB/m	dB	dBuV	dBuV/m	dBuV/m	dB	
1	5439.452	19.23	34.68	35.16	43.90	62.65	74.00	-11.35 peak
2	5463.046	19.26	34.65	35.15	42.51	61.27	68.20	-6.93 peak
3 p	5530.000	19.33	34.62	35.12	75.52	94.35	68.20	26.15 peak



Test Mode: 07; Polarity: Horizontal; Modulation:802.11ac; Bandwidth:80MHz; Channel:Low

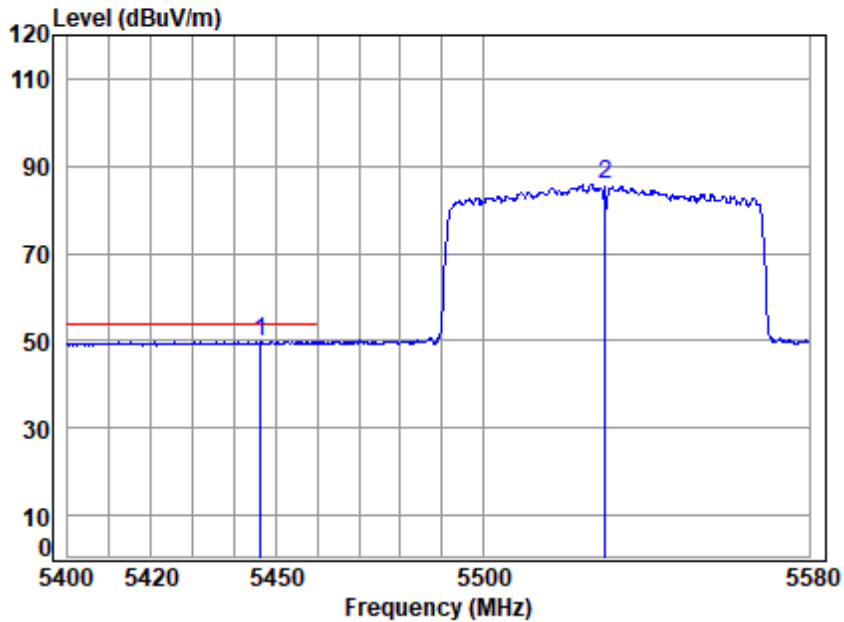

Site : chamber
 Condition: 3m HORIZONTAL
 Job No : 03018AT\03019AT
 Mode : 5530 Band edge
 : 5G WIFI 11AC80

		Cable	Ant	Preamp	Read	Limit	Over		
	Freq	Loss	Factor	Factor	Level	Line	Limit	Remark	
	MHz	dB	dB/m	dB	dBuV	dBuV/m	dBuV/m	dB	
1	q 5446.234	19.24	34.69	35.16	31.12	49.89	54.00	-4.11	Average
2	5530.000	19.33	34.62	35.12	66.95	85.78	-----	-----	Average



Unless otherwise agreed in writing, this document is issued by the Company subject to its General Conditions of Service printed overleaf, available on request or accessible at <https://www.sgs.com/en/Terms-and-Conditions>. Attention is drawn to the limitation of liability, indemnification and jurisdiction issues defined therein. Any holder of this document is advised that information contained hereon reflects the Company's findings at the time of its intervention only and within the limits of Client's instructions, if any. The Company's sole responsibility is to its Client and this document does not exonerate parties to a transaction from exercising all their rights and obligations under the transaction documents. This document cannot be reproduced except in full, without prior written approval of the Company. Any unauthorized alteration, forgery or falsification of the content or appearance of this document is unlawful and offenders may be prosecuted to the fullest extent of the law. Unless otherwise stated the results shown in this test report refer only to the sample(s) tested and such sample(s) are retained for 30 days only.

Test Mode: 07; Polarity: Vertical; Modulation:802.11ac; Bandwidth:80MHz; Channel:Low

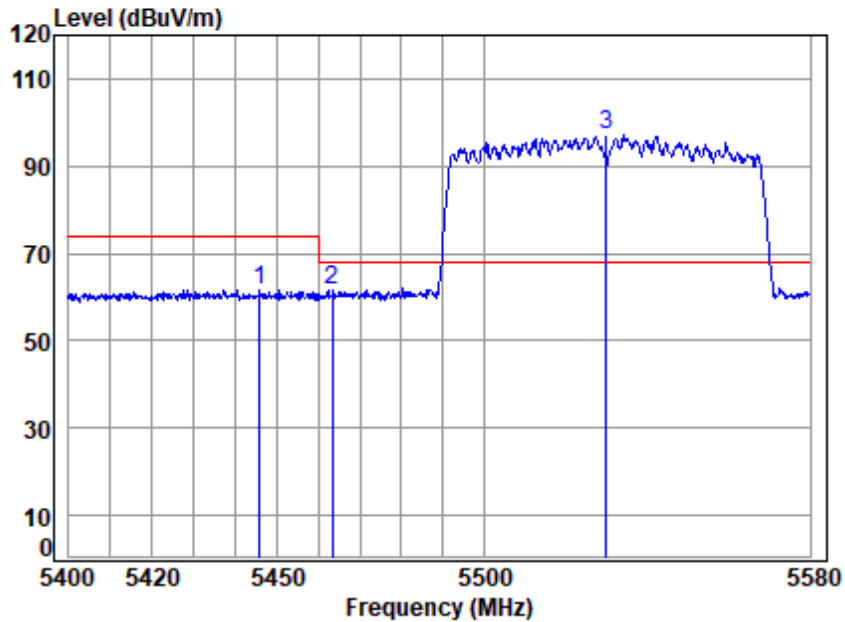

Site : chamber
 Condition: 3m VERTICAL
 Job No : 03018AT\03019AT
 Mode : 5530 Band edge
 : 5G WIFI 11AC80

	Cable	Ant	Preamp	Read	Limit	Over		
Freq	Loss	Factor	Factor	Level	Level	Line	Limit	Remark
MHz	dB	dB/m	dB	dBuV	dBuV/m	dBuV/m	dB	
1	5445.876	19.24	34.69	35.16	42.77	61.54	74.00	-12.46 Peak
2	5463.404	19.26	34.65	35.15	42.87	61.63	68.20	-6.57 peak
3 p	5530.000	19.33	34.62	35.12	78.27	97.10	68.20	28.90 Peak



Unless otherwise agreed in writing, this document is issued by the Company subject to its General Conditions of Service printed overleaf, available on request or accessible at <https://www.sgs.com/en/Terms-and-Conditions>. Attention is drawn to the limitation of liability, indemnification and jurisdiction issues defined therein. Any holder of this document is advised that information contained hereon reflects the Company's findings at the time of its intervention only and within the limits of Client's instructions, if any. The Company's sole responsibility is to its Client and this document does not exonerate parties to a transaction from exercising all their rights and obligations under the transaction documents. This document cannot be reproduced except in full, without prior written approval of the Company. Any unauthorized alteration, forgery or falsification of the content or appearance of this document is unlawful and offenders may be prosecuted to the fullest extent of the law. Unless otherwise stated the results shown in this test report refer only to the sample(s) tested and such sample(s) are retained for 30 days only.

Test Mode: 07; Polarity: Vertical; Modulation:802.11ac; Bandwidth:80MHz; Channel:Low

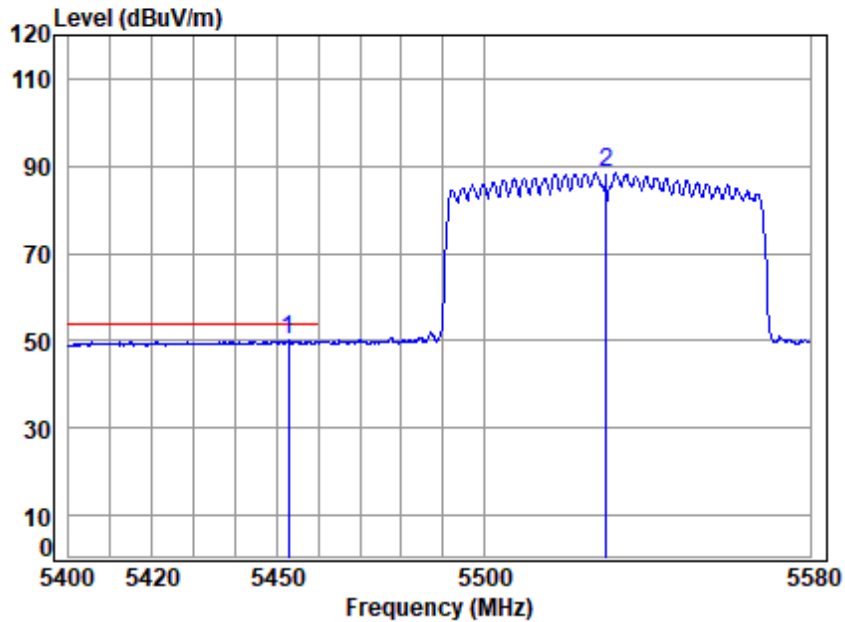

Site : chamber
 Condition: 3m VERTICAL
 Job No : 03018AT\03019AT
 Mode : 5530 Band edge
 : 5G WIFI 11AC80

		Cable	Ant	Preamp	Read	Limit	Over		
Freq	Loss	Factor	Factor	Factor	Level	Level	Line	Limit	Remark
MHz	dB	dB/m	dB	dB	dBuV	dBuV/m	dBuV/m	dB	
1 q 5452.667	19.25	34.69	35.16	31.29	50.07	54.00	-3.93		Average
2 5530.000	19.33	34.62	35.12	69.77	88.60	-----	-----		Average



Unless otherwise agreed in writing, this document is issued by the Company subject to its General Conditions of Service printed overleaf, available on request or accessible at <https://www.sgs.com/en/Terms-and-Conditions>. Attention is drawn to the limitation of liability, indemnification and jurisdiction issues defined therein. Any holder of this document is advised that information contained hereon reflects the Company's findings at the time of its intervention only and within the limits of Client's instructions, if any. The Company's sole responsibility is to its Client and this document does not exonerate parties to a transaction from exercising all their rights and obligations under the transaction documents. This document cannot be reproduced except in full, without prior written approval of the Company. Any unauthorized alteration, forgery or falsification of the content or appearance of this document is unlawful and offenders may be prosecuted to the fullest extent of the law. Unless otherwise stated the results shown in this test report refer only to the sample(s) tested and such sample(s) are retained for 30 days only.

Test Mode: 07; Polarity: Horizontal; Modulation:802.11ac; Bandwidth:80MHz; Channel:High

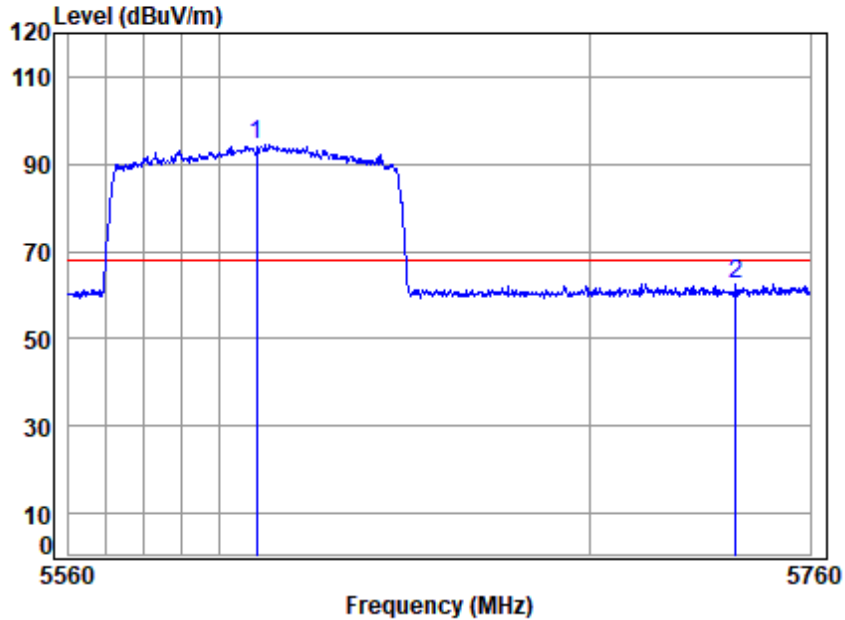

Site : chamber
 Condition: 3m HORIZONTAL
 Job No : 03018AT\03019AT
 Mode : 5610 Band edge
 : 5G WIFI 11AC80

		Cable	Ant	Preamp	Read	Limit	Over	
Freq	Loss	Factor	Factor	Factor	Level	Line	Limit	Remark
MHz	dB	dB/m	dB	dBuV	dBuV/m	dBuV/m	dB	
1 p 5610.000	19.38	34.64	35.08	75.50	94.44	68.20	26.24	peak
2 5739.681	19.47	34.22	35.02	43.90	62.57	68.20	-5.63	peak



Unless otherwise agreed in writing, this document is issued by the Company subject to its General Conditions of Service printed overleaf, available on request or accessible at <https://www.sgs.com/en/Terms-and-Conditions>. Attention is drawn to the limitation of liability, indemnification and jurisdiction issues defined therein. Any holder of this document is advised that information contained hereon reflects the Company's findings at the time of its intervention only and within the limits of Client's instructions, if any. The Company's sole responsibility is to its Client and this document does not exonerate parties to a transaction from exercising all their rights and obligations under the transaction documents. This document cannot be reproduced except in full, without prior written approval of the Company. Any unauthorized alteration, forgery or falsification of the content or appearance of this document is unlawful and offenders may be prosecuted to the fullest extent of the law. Unless otherwise stated the results shown in this test report refer only to the sample(s) tested and such sample(s) are retained for 30 days only.

Test Mode: 07; Polarity: Vertical; Modulation:802.11ac; Bandwidth:80MHz; Channel:High

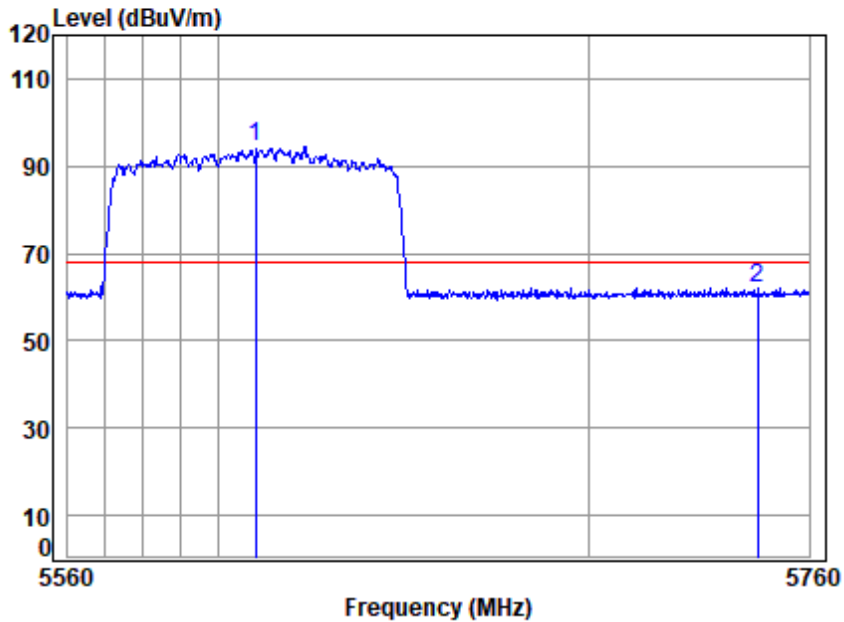

Site : chamber
 Condition: 3m VERTICAL
 Job No : 03018AT\03019AT
 Mode : 5610 Band edge
 : 5G WIFI 11AC80

		Cable	Ant	Preamp	Read	Limit	Over	
Freq		Loss	Factor	Factor	Level	Level	Line	Limit Remark
MHz		dB	dB/m	dB	dBuV	dBuV/m	dBuV/m	dB
1 p	5610.000	19.38	34.64	35.08	75.41	94.35	68.20	26.15 Peak
2	5745.972	19.47	34.21	35.02	43.49	62.15	68.20	-6.05 Peak



Test Mode: 07; Polarity: Horizontal; Modulation:802.11 ax(Full RU0); Bandwidth:20MHz; Channel:Low

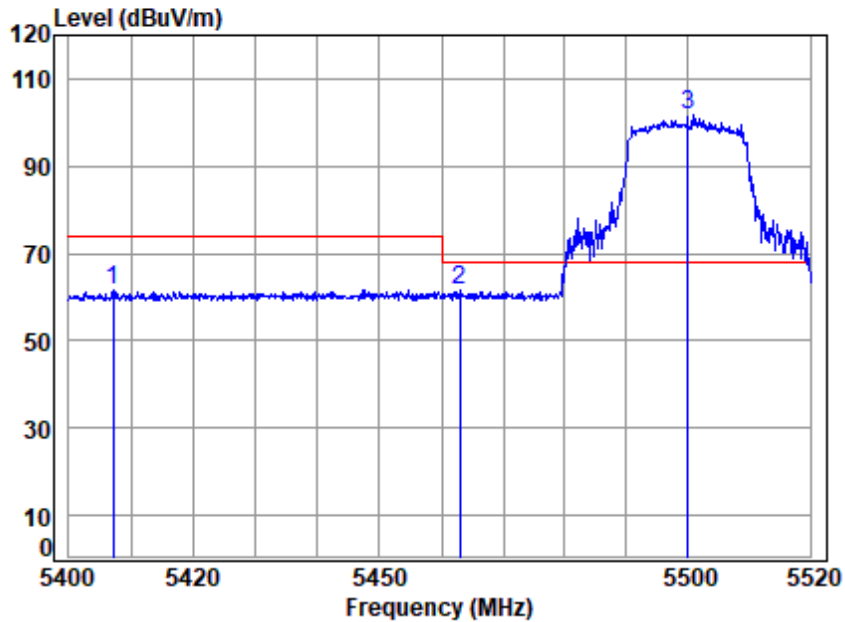

Site : chamber
 Condition: 3m HORIZONTAL
 Job No : 03018AT\03019AT
 Mode : 5500 Band edge
 : 5G WIFI 11AX20

	Freq	Cable Loss	Ant Factor	Preamp Factor	Read Level	Level	Limit Line	Over Limit	Remark
	MHz	dB	dB/m	dB	dBuV	dBuV/m	dBuV/m	dB	
1	5407.126	19.19	34.61	35.18	42.96	61.58	74.00	-12.42	peak
2	5462.911	19.26	34.65	35.15	42.68	61.44	68.20	-6.76	peak
3 p	5500.000	19.31	34.50	35.13	83.03	101.71	68.20	33.51	peak



Unless otherwise agreed in writing, this document is issued by the Company subject to its General Conditions of Service printed overleaf, available on request or accessible at <https://www.sgs.com/en/Terms-and-Conditions>. Attention is drawn to the limitation of liability, indemnification and jurisdiction issues defined therein. Any holder of this document is advised that information contained hereon reflects the Company's findings at the time of its intervention only and within the limits of Client's instructions, if any. The Company's sole responsibility is to its Client and this document does not exonerate parties to a transaction from exercising all their rights and obligations under the transaction documents. This document cannot be reproduced except in full, without prior written approval of the Company. Any unauthorized alteration, forgery or falsification of the content or appearance of this document is unlawful and offenders may be prosecuted to the fullest extent of the law. Unless otherwise stated the results shown in this test report refer only to the sample(s) tested and such sample(s) are retained for 30 days only.

Test Mode: 07; Polarity: Horizontal; Modulation:802.11 ax(Full RU0); Bandwidth:20MHz; Channel:Low

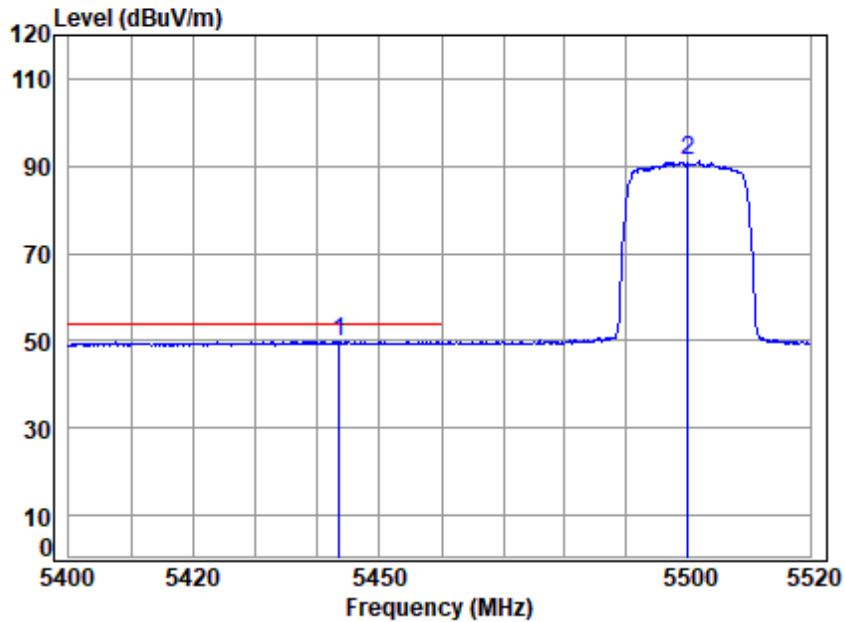

Site : chamber
 Condition: 3m HORIZONTAL
 Job No : 03018AT\03019AT
 Mode : 5500 Band edge
 : 5G WIFI 11AX20

		Cable	Ant	Preamp	Read	Limit	Over		
	Freq	Loss	Factor	Factor	Level	Line	Limit	Remark	
	MHz	dB	dB/m	dB	dBuV	dBuV/m	dBuV/m	dB	
1	q 5443.495	19.24	34.69	35.16	31.15	49.92	54.00	-4.08	Average
2	5500.000	19.31	34.50	35.13	72.70	91.38	-----	-----	Average



Unless otherwise agreed in writing, this document is issued by the Company subject to its General Conditions of Service printed overleaf, available on request or accessible at <https://www.sgs.com/en/Terms-and-Conditions>. Attention is drawn to the limitation of liability, indemnification and jurisdiction issues defined therein. Any holder of this document is advised that information contained hereon reflects the Company's findings at the time of its intervention only and within the limits of Client's instructions, if any. The Company's sole responsibility is to its Client and this document does not exonerate parties to a transaction from exercising all their rights and obligations under the transaction documents. This document cannot be reproduced except in full, without prior written approval of the Company. Any unauthorized alteration, forgery or falsification of the content or appearance of this document is unlawful and offenders may be prosecuted to the fullest extent of the law. Unless otherwise stated the results shown in this test report refer only to the sample(s) tested and such sample(s) are retained for 30 days only.

Test Mode: 07; Polarity: Vertical; Modulation:802.11ax(Full RU0); Bandwidth:20MHz; Channel:Low

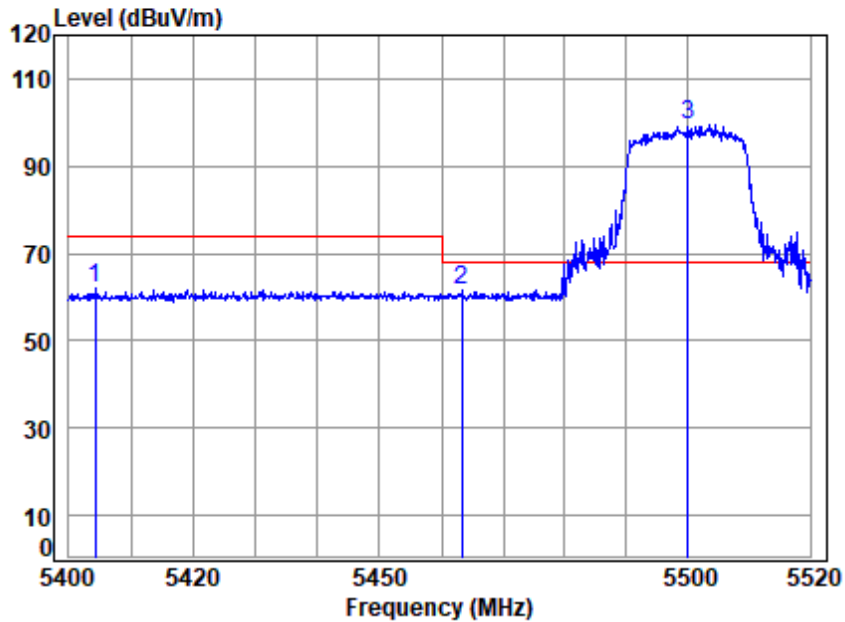

Site : chamber
 Condition: 3m VERTICAL
 Job No : 03018AT\03019AT
 Mode : 5500 Band edge
 : 5G WIFI 11AX20

	Freq	Cable Loss	Ant Factor	Preamp Factor	Read Level	Level	Limit Line	Over Limit	Remark
	MHz	dB	dB/m	dB	dBuV	dBuV/m	dBuV/m	dB	
1	5404.274	19.18	34.61	35.18	43.38	61.99	74.00	-12.01	Peak
2	5463.271	19.26	34.65	35.15	42.63	61.39	68.20	-6.81	peak
3 p	5500.000	19.31	34.50	35.13	80.88	99.56	68.20	31.36	Peak



Unless otherwise agreed in writing, this document is issued by the Company subject to its General Conditions of Service printed overleaf, available on request or accessible at <https://www.sgs.com/en/Terms-and-Conditions>. Attention is drawn to the limitation of liability, indemnification and jurisdiction issues defined therein. Any holder of this document is advised that information contained hereon reflects the Company's findings at the time of its intervention only and within the limits of Client's instructions, if any. The Company's sole responsibility is to its Client and this document does not exonerate parties to a transaction from exercising all their rights and obligations under the transaction documents. This document cannot be reproduced except in full, without prior written approval of the Company. Any unauthorized alteration, forgery or falsification of the content or appearance of this document is unlawful and offenders may be prosecuted to the fullest extent of the law. Unless otherwise stated the results shown in this test report refer only to the sample(s) tested and such sample(s) are retained for 30 days only.

Test Mode: 07; Polarity: Vertical; Modulation:802.11ax(Full RU0); Bandwidth:20MHz; Channel:Low

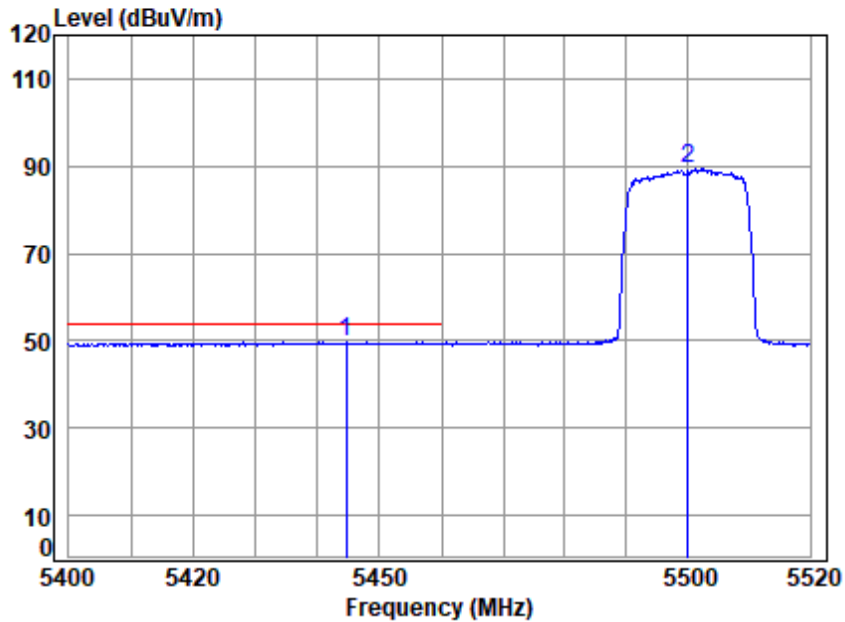

Site : chamber
 Condition: 3m VERTICAL
 Job No : 03018AT\03019AT
 Mode : 5500 Band edge
 : 5G WIFI 11AX20

		Cable	Ant	Preamp	Read	Limit	Over	
Freq	Loss	Factor	Factor	Factor	Level	Line	Limit	Remark
MHz	dB	dB/m	dB	dB	dBuV	dBuV/m	dB	
1 q 5444.691	19.24	34.69	35.16	30.91	49.68	54.00	-4.32	Average
2 5500.000	19.31	34.50	35.13	70.88	89.56	-----	-----	Average



Unless otherwise agreed in writing, this document is issued by the Company subject to its General Conditions of Service printed overleaf, available on request or accessible at <https://www.sgs.com/en/Terms-and-Conditions>. Attention is drawn to the limitation of liability, indemnification and jurisdiction issues defined therein. Any holder of this document is advised that information contained hereon reflects the Company's findings at the time of its intervention only and within the limits of Client's instructions, if any. The Company's sole responsibility is to its Client and this document does not exonerate parties to a transaction from exercising all their rights and obligations under the transaction documents. This document cannot be reproduced except in full, without prior written approval of the Company. Any unauthorized alteration, forgery or falsification of the content or appearance of this document is unlawful and offenders may be prosecuted to the fullest extent of the law. Unless otherwise stated the results shown in this test report refer only to the sample(s) tested and such sample(s) are retained for 30 days only.

Test Mode: 07; Polarity: Horizontal; Modulation:802.11ax(Full RU0); Bandwidth:20MHz; Channel:High

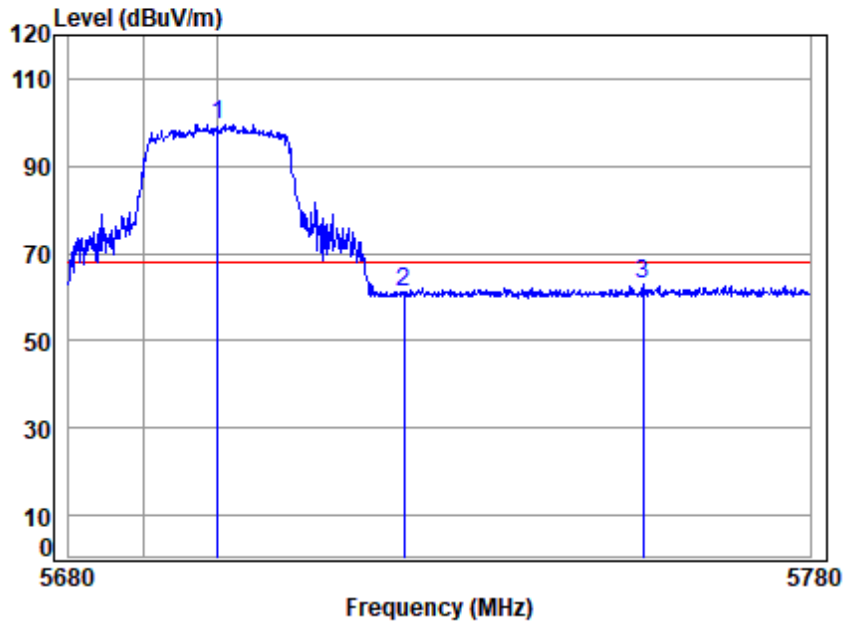

Site : chamber
 Condition: 3m HORIZONTAL
 Job No : 03018AT\03019AT
 Mode : 5700 Band edge
 : 5G WIFI 11AX20

	Freq	Cable Loss	Ant Factor	Preamp Factor	Read Level	Limit Level	Over Limit	Remark
	MHz	dB	dB/m	dB	dBuV	dBuV/m	dBuV/m	dB
1 p	5700.000	19.44	34.30	35.04	80.76	99.46	68.20	31.26 peak
2	5725.000	19.46	34.25	35.03	42.66	61.34	68.20	-6.86 peak
3	5757.348	19.48	34.21	35.01	44.15	62.83	68.20	-5.37 peak



Unless otherwise agreed in writing, this document is issued by the Company subject to its General Conditions of Service printed overleaf, available on request or accessible at <https://www.sgs.com/en/Terms-and-Conditions>. Attention is drawn to the limitation of liability, indemnification and jurisdiction issues defined therein. Any holder of this document is advised that information contained hereon reflects the Company's findings at the time of its intervention only and within the limits of Client's instructions, if any. The Company's sole responsibility is to its Client and this document does not exonerate parties to a transaction from exercising all their rights and obligations under the transaction documents. This document cannot be reproduced except in full, without prior written approval of the Company. Any unauthorized alteration, forgery or falsification of the content or appearance of this document is unlawful and offenders may be prosecuted to the fullest extent of the law. Unless otherwise stated the results shown in this test report refer only to the sample(s) tested and such sample(s) are retained for 30 days only.

Test Mode: 07; Polarity: Vertical; Modulation:802.11ax(Full RU0); Bandwidth:20MHz; Channel:High

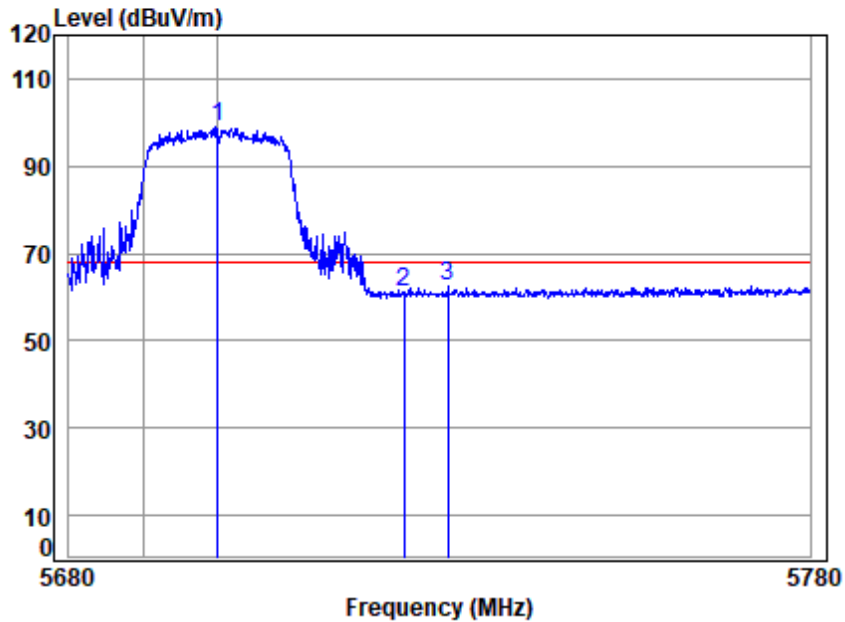

Site : chamber
 Condition: 3m VERTICAL
 Job No : 03018AT\03019AT
 Mode : 5700 Band edge
 : 5G WIFI 11AX20

	Freq	Cable Loss	Ant Factor	Preamp Factor	Read Level	Limit Level	Over Limit	Remark
	MHz	dB	dB/m	dB	dBuV	dBuV/m	dBuV/m	dB
1 p	5700.000	19.44	34.30	35.04	80.12	98.82	68.20	30.62 Peak
2	5725.000	19.46	34.25	35.03	42.43	61.11	68.20	-7.09 Peak
3	5730.882	19.46	34.24	35.02	43.62	62.30	68.20	-5.90 Peak



Unless otherwise agreed in writing, this document is issued by the Company subject to its General Conditions of Service printed overleaf, available on request or accessible at <https://www.sgs.com/en/Terms-and-Conditions>. Attention is drawn to the limitation of liability, indemnification and jurisdiction issues defined therein. Any holder of this document is advised that information contained hereon reflects the Company's findings at the time of its intervention only and within the limits of Client's instructions, if any. The Company's sole responsibility is to its Client and this document does not exonerate parties to a transaction from exercising all their rights and obligations under the transaction documents. This document cannot be reproduced except in full, without prior written approval of the Company. Any unauthorized alteration, forgery or falsification of the content or appearance of this document is unlawful and offenders may be prosecuted to the fullest extent of the law. Unless otherwise stated the results shown in this test report refer only to the sample(s) tested and such sample(s) are retained for 30 days only.

Test Mode: 07; Polarity: Horizontal; Modulation:802.11ax(26 RU0); Bandwidth:20MHz; Channel:Low

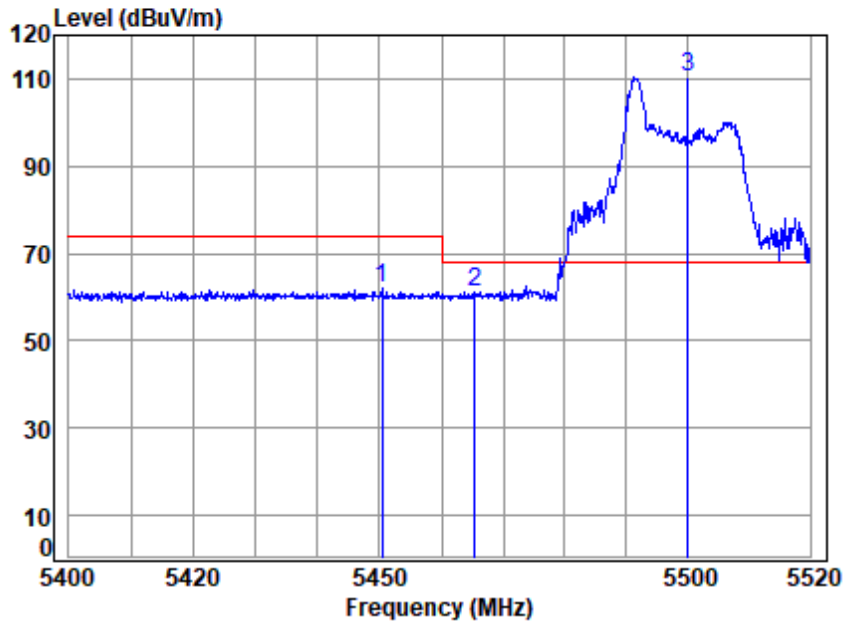

Site	: chamber							
Condition:	3m HORIZONTAL							
Job No	: 03018AT\03019AT							
Mode	: 5500 Band edge							
	: 5G WIFI 11AX20 Partial RU							
	Cable	Ant	Preamp	Read		Limit	Over	
Freq	Loss	Factor	Factor	Level	Level	Line	Limit	Remark
	dB	dB/m	dB	dBuV	dBuV/m	dBuV/m	dB	
1	19.24	34.70	35.16	43.32	62.10	74.00	-11.90	peak
2	19.26	34.64	35.15	42.54	61.29	68.20	-6.91	peak
3 p	19.31	34.50	35.13	91.66	110.34	68.20	42.14	peak



Unless otherwise agreed in writing, this document is issued by the Company subject to its General Conditions of Service printed overleaf, available on request or accessible at <https://www.sgs.com/en/Terms-and-Conditions>. Attention is drawn to the limitation of liability, indemnification and jurisdiction issues defined therein. Any holder of this document is advised that information contained hereon reflects the Company's findings at the time of its intervention only and within the limits of Client's instructions, if any. The Company's sole responsibility is to its Client and this document does not exonerate parties to a transaction from exercising all their rights and obligations under the transaction documents. This document cannot be reproduced except in full, without prior written approval of the Company. Any unauthorized alteration, forgery or falsification of the content or appearance of this document is unlawful and offenders may be prosecuted to the fullest extent of the law. Unless otherwise stated the results shown in this test report refer only to the sample(s) tested and such sample(s) are retained for 30 days only.

Test Mode: 07; Polarity: Horizontal; Modulation:802.11ax(26 RU0); Bandwidth:20MHz; Channel:Low

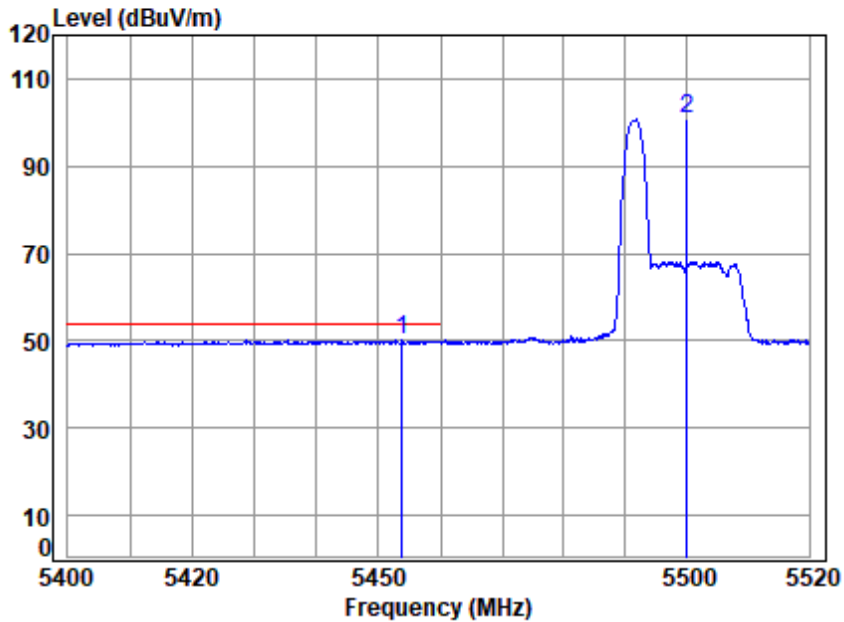

Site : chamber
 Condition: 3m HORIZONTAL
 Job No : 03018AT\03019AT
 Mode : 5500 Band edge
 : 5G WIFI 11AX20 Partial RU

	Cable	Ant	Preamp	Read	Limit	Over		
Freq	Loss	Factor	Factor	Level	Level	Line	Limit	Remark
MHz	dB	dB/m	dB	dBuV	dBuV/m	dBuV/m	dB	
1 q 5453.793	19.25	34.68	35.16	31.39	50.16	54.00	-3.84	Average
2 5500.000	19.31	34.50	35.13	81.95	100.63	-----	-----	Average



Unless otherwise agreed in writing, this document is issued by the Company subject to its General Conditions of Service printed overleaf, available on request or accessible at <https://www.sgs.com/en/Terms-and-Conditions>. Attention is drawn to the limitation of liability, indemnification and jurisdiction issues defined therein. Any holder of this document is advised that information contained hereon reflects the Company's findings at the time of its intervention only and within the limits of Client's instructions, if any. The Company's sole responsibility is to its Client and this document does not exonerate parties to a transaction from exercising all their rights and obligations under the transaction documents. This document cannot be reproduced except in full, without prior written approval of the Company. Any unauthorized alteration, forgery or falsification of the content or appearance of this document is unlawful and offenders may be prosecuted to the fullest extent of the law. Unless otherwise stated the results shown in this test report refer only to the sample(s) tested and such sample(s) are retained for 30 days only.

Test Mode: 07; Polarity: Vertical; Modulation:802.11ax(26 RU0); Bandwidth:20MHz; Channel:Low

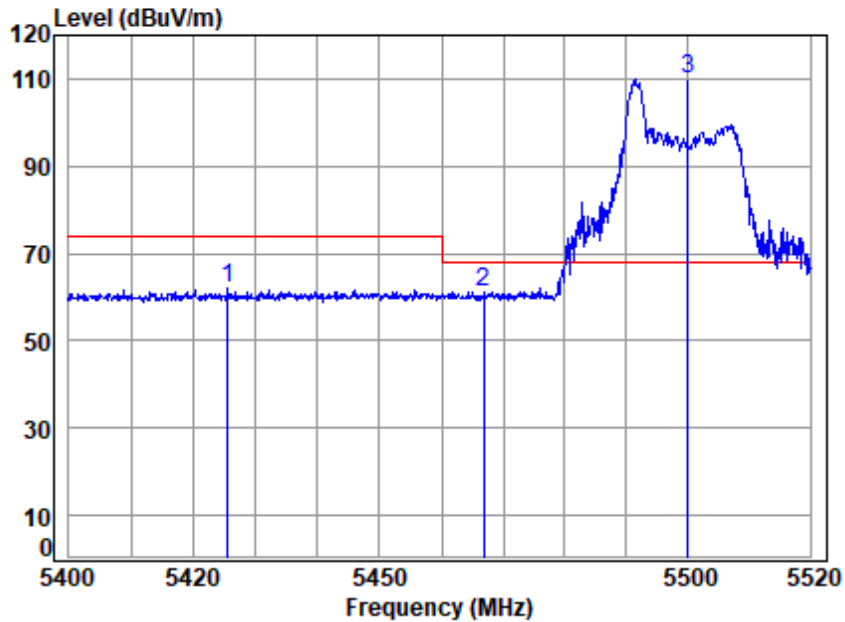

Site	: chamber							
Condition:	3m VERTICAL							
Job No	: 03018AT\03019AT							
Mode	: 5500 Band edge							
	: 5G WIFI 11AX20 Partial RU							
	Cable	Ant	Preamp	Read		Limit	Over	
Freq	Loss	Factor	Factor	Level	Level	Line	Limit	Remark
	dB	dB/m	dB	dBuV	dBuV/m	dBuV/m	dB	
1	19.21	34.65	35.17	43.19	61.88	74.00	-12.12	Peak
2	19.27	34.63	35.15	42.47	61.22	68.20	-6.98	peak
3 p	19.31	34.50	35.13	91.12	109.80	68.20	41.60	Peak



Unless otherwise agreed in writing, this document is issued by the Company subject to its General Conditions of Service printed overleaf, available on request or accessible at <https://www.sgs.com/en/Terms-and-Conditions>. Attention is drawn to the limitation of liability, indemnification and jurisdiction issues defined therein. Any holder of this document is advised that information contained hereon reflects the Company's findings at the time of its intervention only and within the limits of Client's instructions, if any. The Company's sole responsibility is to its Client and this document does not exonerate parties to a transaction from exercising all their rights and obligations under the transaction documents. This document cannot be reproduced except in full, without prior written approval of the Company. Any unauthorized alteration, forgery or falsification of the content or appearance of this document is unlawful and offenders may be prosecuted to the fullest extent of the law. Unless otherwise stated the results shown in this test report refer only to the sample(s) tested and such sample(s) are retained for 30 days only.

Test Mode: 07; Polarity: Vertical; Modulation:802.11ax(26 RU0); Bandwidth:20MHz; Channel:Low

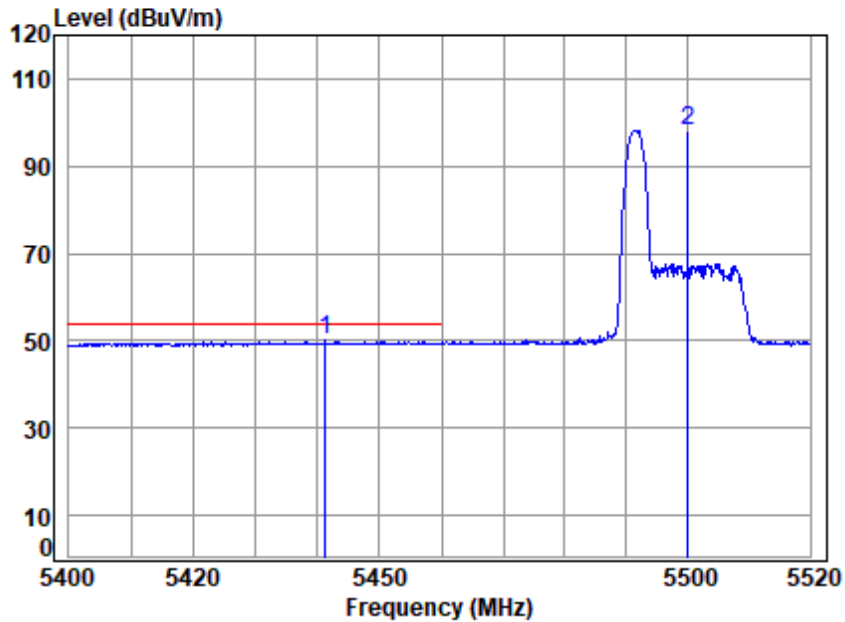

Site : chamber
 Condition: 3m VERTICAL
 Job No : 03018AT\03019AT
 Mode : 5500 Band edge
 : 5G WIFI 11AX20 Partial RU

	Cable	Ant	Preamp	Read	Limit	Over		
Freq	Loss	Factor	Factor	Level	Level	Line	Limit	Remark
MHz	dB	dB/m	dB	dBuV	dBuV/m	dBuV/m	dB	
1 q 5441.222	19.23	34.68	35.16	31.36	50.11	54.00	-3.89	Average
2 5500.000	19.31	34.50	35.13	79.59	98.27	-----	-----	Average



Unless otherwise agreed in writing, this document is issued by the Company subject to its General Conditions of Service printed overleaf, available on request or accessible at <https://www.sgs.com/en/Terms-and-Conditions>. Attention is drawn to the limitation of liability, indemnification and jurisdiction issues defined therein. Any holder of this document is advised that information contained hereon reflects the Company's findings at the time of its intervention only and within the limits of Client's instructions, if any. The Company's sole responsibility is to its Client and this document does not exonerate parties to a transaction from exercising all their rights and obligations under the transaction documents. This document cannot be reproduced except in full, without prior written approval of the Company. Any unauthorized alteration, forgery or falsification of the content or appearance of this document is unlawful and offenders may be prosecuted to the fullest extent of the law. Unless otherwise stated the results shown in this test report refer only to the sample(s) tested and such sample(s) are retained for 30 days only.

Test Mode: 07; Polarity: Horizontal; Modulation:802.11ax(26 RU0); Bandwidth:20MHz; Channel:High

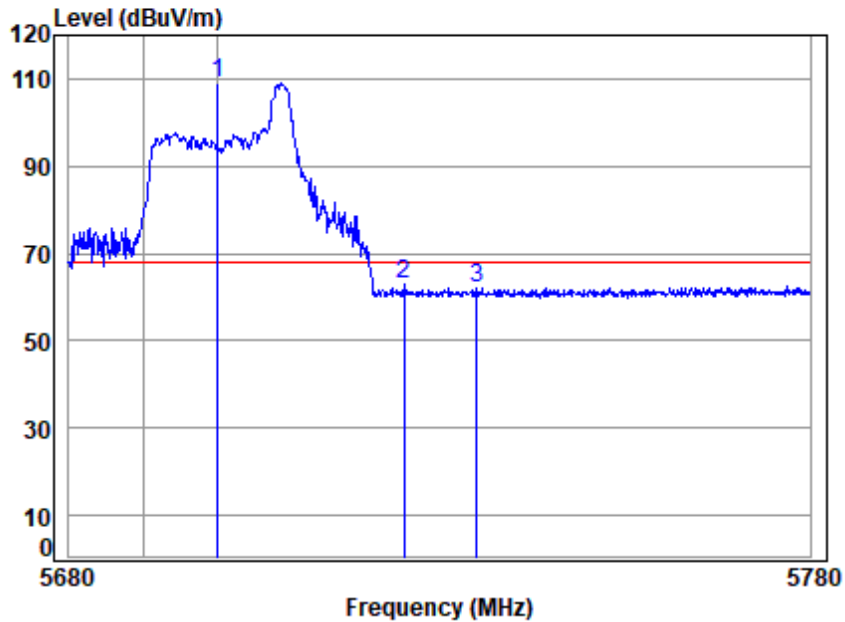

Site	: chamber						
Condition:	3m HORIZONTAL						
Job No	: 03018AT\03019AT						
Mode	: 5700 Band edge						
	: 5G WIFI 11AX20 Partial RU						
	Cable	Ant	Preamp	Read	Limit	Over	
Freq	Loss	Factor	Factor	Level	Level	Line	Limit Remark
	dB	dB/m	dB	dBuV	dBuV/m	dBuV/m	dB
1 p	19.44	34.30	35.04	90.18	108.88	68.20	40.68 peak
2	19.46	34.25	35.03	44.08	62.76	68.20	-5.44 peak
3	19.46	34.23	35.02	43.54	62.21	68.20	-5.99 peak



Unless otherwise agreed in writing, this document is issued by the Company subject to its General Conditions of Service printed overleaf, available on request or accessible at <https://www.sgs.com/en/Terms-and-Conditions>. Attention is drawn to the limitation of liability, indemnification and jurisdiction issues defined therein. Any holder of this document is advised that information contained hereon reflects the Company's findings at the time of its intervention only and within the limits of Client's instructions, if any. The Company's sole responsibility is to its Client and this document does not exonerate parties to a transaction from exercising all their rights and obligations under the transaction documents. This document cannot be reproduced except in full, without prior written approval of the Company. Any unauthorized alteration, forgery or falsification of the content or appearance of this document is unlawful and offenders may be prosecuted to the fullest extent of the law. Unless otherwise stated the results shown in this test report refer only to the sample(s) tested and such sample(s) are retained for 30 days only.

Test Mode: 07; Polarity: Vertical; Modulation:802.11ax(26 RU0); Bandwidth:20MHz; Channel:High

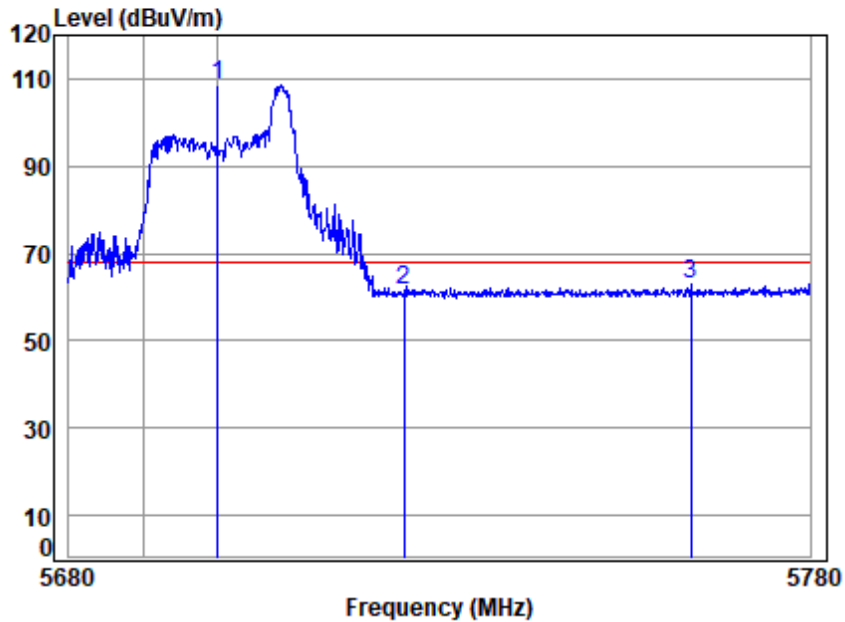

Site	: chamber						
Condition:	3m VERTICAL						
Job No	: 03018AT\03019AT						
Mode	: 5700 Band edge						
	: 5G WIFI 11AX20 Partial RU						
	Cable	Ant	Preamp	Read	Limit	Over	
Freq	Loss	Factor	Factor	Level	Level	Line	Limit Remark
	dB	dB/m	dB	dBuV	dBuV/m	dBuV/m	dB
1 p	19.44	34.30	35.04	89.81	108.51	68.20	40.31 Peak
2	19.46	34.25	35.03	43.11	61.79	68.20	-6.41 Peak
3	19.48	34.23	35.01	44.17	62.87	68.20	-5.33 Peak



Unless otherwise agreed in writing, this document is issued by the Company subject to its General Conditions of Service printed overleaf, available on request or accessible at <https://www.sgs.com/en/Terms-and-Conditions>. Attention is drawn to the limitation of liability, indemnification and jurisdiction issues defined therein. Any holder of this document is advised that information contained hereon reflects the Company's findings at the time of its intervention only and within the limits of Client's instructions, if any. The Company's sole responsibility is to its Client and this document does not exonerate parties to a transaction from exercising all their rights and obligations under the transaction documents. This document cannot be reproduced except in full, without prior written approval of the Company. Any unauthorized alteration, forgery or falsification of the content or appearance of this document is unlawful and offenders may be prosecuted to the fullest extent of the law. Unless otherwise stated the results shown in this test report refer only to the sample(s) tested and such sample(s) are retained for 30 days only.

Test Mode: 08; Polarity: Horizontal; Modulation:802.11a; Bandwidth:20MHz; Channel:Low

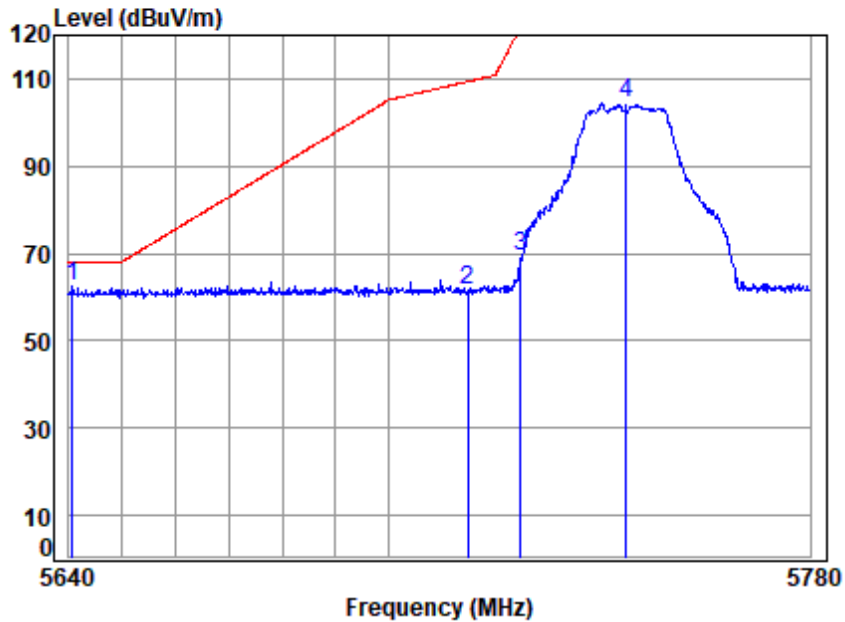

Site : chamber
 Condition: 3m HORIZONTAL
 Job No : 03018AT\03019AT
 Mode : 5745 Band edge
 : 5G WIFI 11A

		Cable	Ant	Preamp	Read	Limit	Over	
	Freq	Loss	Factor	Factor	Level	Line	Limit	Remark
	MHz	dB	dB/m	dB	dBuV	dBuV/m	dBuV/m	dB
1 p	5640.691	19.40	34.46	35.07	43.65	62.44	68.20	-5.76 peak
2	5715.000	19.45	34.27	35.03	42.73	61.42	109.40	-47.98 peak
3	5725.000	19.46	34.25	35.03	50.68	69.36	122.20	-52.84 peak
4	5745.000	19.47	34.21	35.02	85.90	104.56	-----	----- peak



Unless otherwise agreed in writing, this document is issued by the Company subject to its General Conditions of Service printed overleaf, available on request or accessible at <https://www.sgs.com/en/Terms-and-Conditions>. Attention is drawn to the limitation of liability, indemnification and jurisdiction issues defined therein. Any holder of this document is advised that information contained hereon reflects the Company's findings at the time of its intervention only and within the limits of Client's instructions, if any. The Company's sole responsibility is to its Client and this document does not exonerate parties to a transaction from exercising all their rights and obligations under the transaction documents. This document cannot be reproduced except in full, without prior written approval of the Company. Any unauthorized alteration, forgery or falsification of the content or appearance of this document is unlawful and offenders may be prosecuted to the fullest extent of the law. Unless otherwise stated the results shown in this test report refer only to the sample(s) tested and such sample(s) are retained for 30 days only.

Test Mode: 08; Polarity: Vertical; Modulation:802.11a; Bandwidth:20MHz; Channel:Low

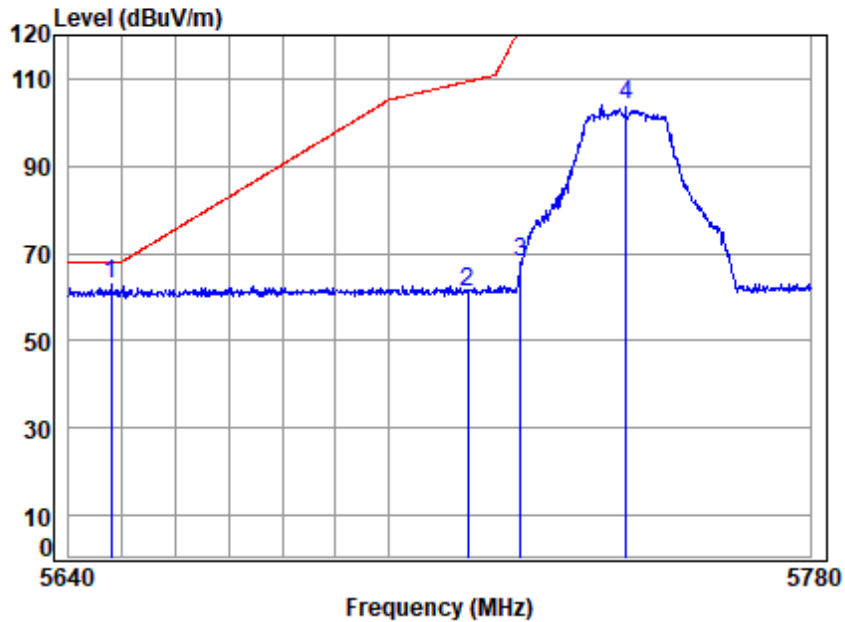

Site : chamber
 Condition: 3m VERTICAL
 Job No : 03018AT\03019AT
 Mode : 5745 Band edge
 : 5G WIFI 11A

		Cable	Ant	Preamp	Read	Limit	Over	
	Freq	Loss	Factor	Factor	Level	Line	Limit	Remark
	MHz	dB	dB/m	dB	dBuV	dBuV/m	dBuV/m	dB
1 p	5647.888	19.41	34.41	35.06	44.02	62.78	68.20	-5.42 peak
2	5715.000	19.45	34.27	35.03	42.61	61.30	109.40	-48.10 peak
3	5725.000	19.46	34.25	35.03	49.21	67.89	122.20	-54.31 peak
4	5745.000	19.47	34.21	35.02	85.37	104.03	-----	----- peak



Unless otherwise agreed in writing, this document is issued by the Company subject to its General Conditions of Service printed overleaf, available on request or accessible at <https://www.sgs.com/en/Terms-and-Conditions>. Attention is drawn to the limitation of liability, indemnification and jurisdiction issues defined therein. Any holder of this document is advised that information contained hereon reflects the Company's findings at the time of its intervention only and within the limits of Client's instructions, if any. The Company's sole responsibility is to its Client and this document does not exonerate parties to a transaction from exercising all their rights and obligations under the transaction documents. This document cannot be reproduced except in full, without prior written approval of the Company. Any unauthorized alteration, forgery or falsification of the content or appearance of this document is unlawful and offenders may be prosecuted to the fullest extent of the law. Unless otherwise stated the results shown in this test report refer only to the sample(s) tested and such sample(s) are retained for 30 days only.

Test Mode: 08; Polarity: Horizontal; Modulation:802.11a; Bandwidth:20MHz; Channel:High

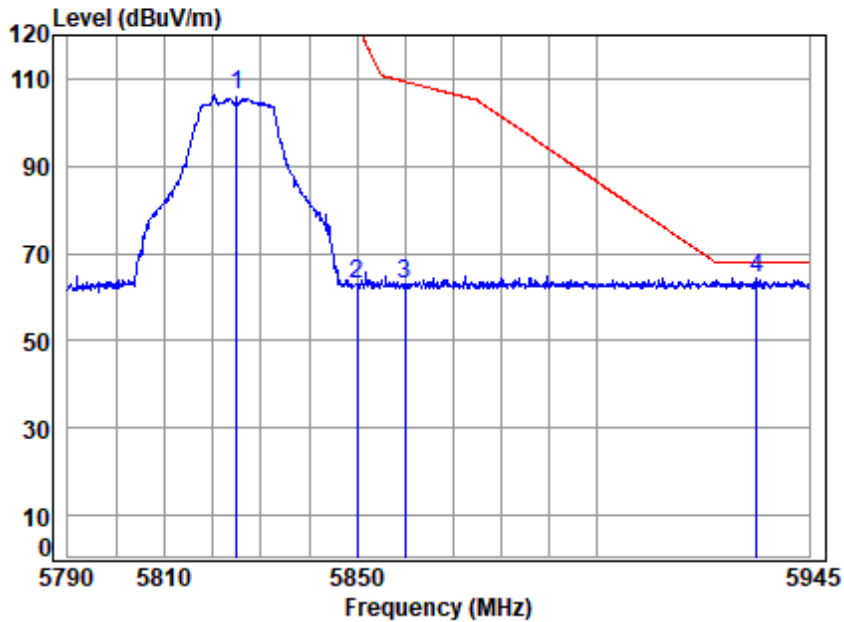

Site : chamber
 Condition: 3m HORIZONTAL
 Job No : 03018AT\03019AT
 Mode : 5825 Band edge
 : 5G WIFI 11A

	Freq	Cable Loss	Ant Factor	Preamp Factor	Read Level	Limit Level	Limit Line	Over Limit	Remark
	MHz	dB	dB/m	dB	dBuV	dBuV/m	dBuV/m	dB	
1	5825.000	19.52	34.35	34.98	87.38	106.27	-----	-----	peak
2	5850.000	19.54	34.40	34.97	43.78	62.75	122.20	-59.45	peak
3	5860.000	19.54	34.44	34.96	43.77	62.79	109.40	-46.61	peak
4 p	5933.859	19.59	34.67	34.93	44.98	64.31	68.20	-3.89	peak



Unless otherwise agreed in writing, this document is issued by the Company subject to its General Conditions of Service printed overleaf, available on request or accessible at <https://www.sgs.com/en/Terms-and-Conditions>. Attention is drawn to the limitation of liability, indemnification and jurisdiction issues defined therein. Any holder of this document is advised that information contained hereon reflects the Company's findings at the time of its intervention only and within the limits of Client's instructions, if any. The Company's sole responsibility is to its Client and this document does not exonerate parties to a transaction from exercising all their rights and obligations under the transaction documents. This document cannot be reproduced except in full, without prior written approval of the Company. Any unauthorized alteration, forgery or falsification of the content or appearance of this document is unlawful and offenders may be prosecuted to the fullest extent of the law. Unless otherwise stated the results shown in this test report refer only to the sample(s) tested and such sample(s) are retained for 30 days only.

Test Mode: 08; Polarity: Vertical; Modulation:802.11a; Bandwidth:20MHz; Channel:High

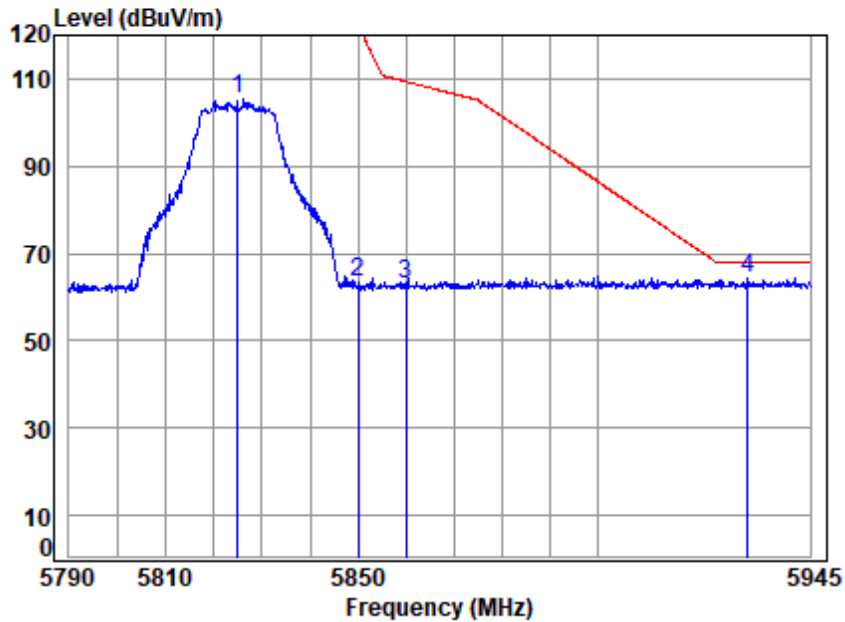

Site : chamber
 Condition: 3m VERTICAL
 Job No : 03018AT\03019AT
 Mode : 5825 Band edge
 : 5G WIFI 11A

	Freq	Cable Loss	Ant Factor	Preamp Factor	Read Level	Limit Level	Limit Line	Over Limit	Remark
	MHz	dB	dB/m	dB	dBuV	dBuV/m	dBuV/m	dB	
1	5825.000	19.52	34.35	34.98	86.34	105.23	-----	-----	peak
2	5850.000	19.54	34.40	34.97	44.55	63.52	122.20	-58.68	peak
3	5860.000	19.54	34.44	34.96	43.92	62.94	109.40	-46.46	peak
4 p	5931.822	19.59	34.66	34.93	45.03	64.35	68.20	-3.85	peak



Unless otherwise agreed in writing, this document is issued by the Company subject to its General Conditions of Service printed overleaf, available on request or accessible at <https://www.sgs.com/en/Terms-and-Conditions>. Attention is drawn to the limitation of liability, indemnification and jurisdiction issues defined therein. Any holder of this document is advised that information contained hereon reflects the Company's findings at the time of its intervention only and within the limits of Client's instructions, if any. The Company's sole responsibility is to its Client and this document does not exonerate parties to a transaction from exercising all their rights and obligations under the transaction documents. This document cannot be reproduced except in full, without prior written approval of the Company. Any unauthorized alteration, forgery or falsification of the content or appearance of this document is unlawful and offenders may be prosecuted to the fullest extent of the law. Unless otherwise stated the results shown in this test report refer only to the sample(s) tested and such sample(s) are retained for 30 days only.

Test Mode: 08; Polarity: Horizontal; Modulation:802.11ac; Bandwidth:20MHz; Channel:Low

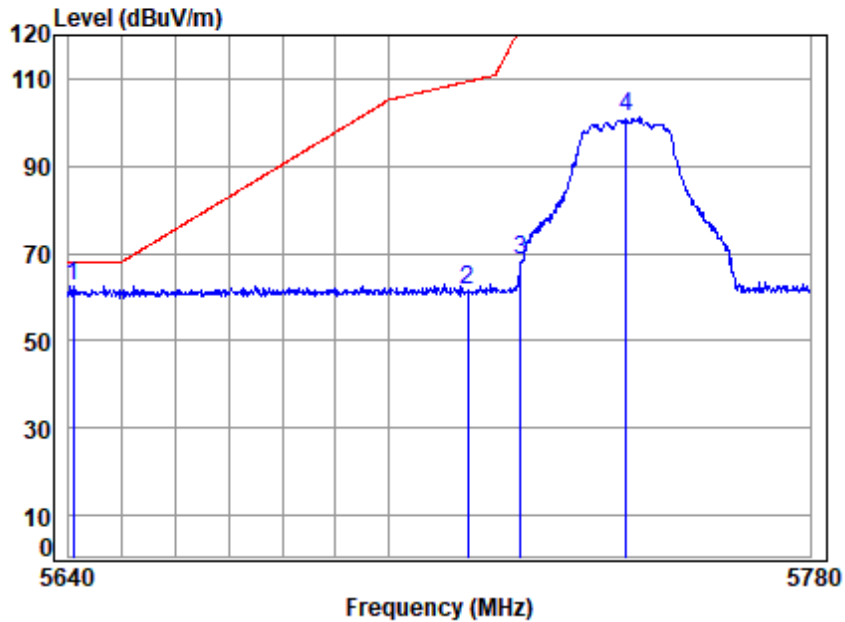

Site : chamber
 Condition: 3m HORIZONTAL
 Job No : 03018AT\03019AT
 Mode : 5745 Band edge
 : 5G WIFI 11AC20

		Cable	Ant	Preamp	Read	Limit	Over	
	Freq	Loss	Factor	Factor	Level	Line	Limit	Remark
	MHz	dB	dB/m	dB	dBuV	dBuV/m	dBuV/m	dB
1 p	5640.830	19.40	34.46	35.07	43.70	62.49	68.20	-5.71 peak
2	5715.000	19.45	34.27	35.03	42.71	61.40	109.40	-48.00 peak
3	5725.000	19.46	34.25	35.03	49.80	68.48	122.20	-53.72 peak
4	5745.000	19.47	34.21	35.02	82.75	101.41	-----	----- peak



Unless otherwise agreed in writing, this document is issued by the Company subject to its General Conditions of Service printed overleaf, available on request or accessible at <https://www.sgs.com/en/Terms-and-Conditions>. Attention is drawn to the limitation of liability, indemnification and jurisdiction issues defined therein. Any holder of this document is advised that information contained hereon reflects the Company's findings at the time of its intervention only and within the limits of Client's instructions, if any. The Company's sole responsibility is to its Client and this document does not exonerate parties to a transaction from exercising all their rights and obligations under the transaction documents. This document cannot be reproduced except in full, without prior written approval of the Company. Any unauthorized alteration, forgery or falsification of the content or appearance of this document is unlawful and offenders may be prosecuted to the fullest extent of the law. Unless otherwise stated the results shown in this test report refer only to the sample(s) tested and such sample(s) are retained for 30 days only.

Test Mode: 08; Polarity: Vertical; Modulation:802.11ac; Bandwidth:20MHz; Channel:Low

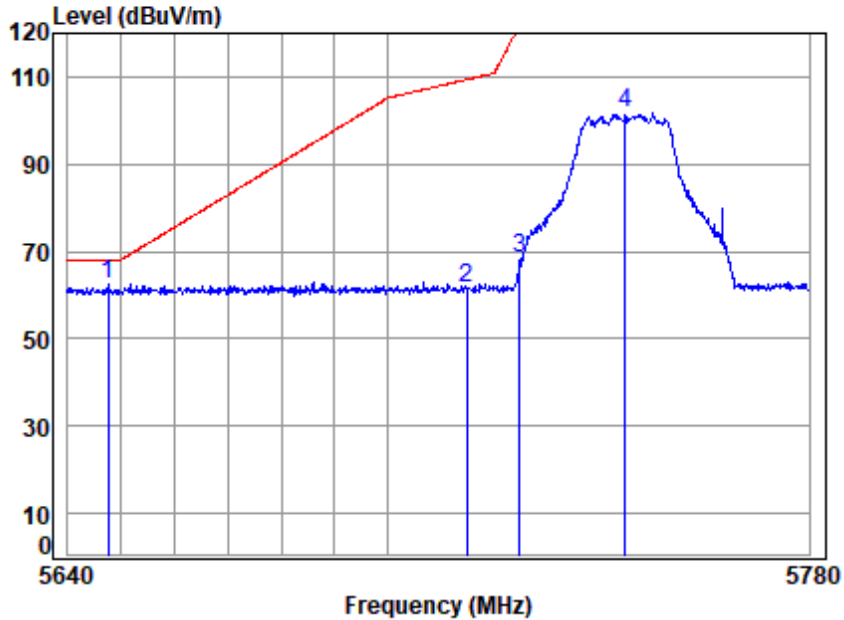

Site : chamber
 Condition: 3m VERTICAL
 Job No : 03018AT\03019AT
 Mode : 5745 Band edge
 : 5G WIFI 11AC20

	Freq	Cable Loss	Ant Factor	Preamp Factor	Read Level	Limit Level	Limit Line	Over Limit	Remark
	MHz	dB	dB/m	dB	dBuV	dBuV/m	dBuV/m	dB	
1 p	5647.611	19.41	34.41	35.06	43.68	62.44	68.20	-5.76	peak
2	5715.000	19.45	34.27	35.03	42.70	61.39	109.40	-48.01	peak
3	5725.000	19.46	34.25	35.03	49.68	68.36	122.20	-53.84	peak
4	5745.000	19.47	34.21	35.02	83.30	101.96	-----	-----	peak



Unless otherwise agreed in writing, this document is issued by the Company subject to its General Conditions of Service printed overleaf, available on request or accessible at <https://www.sgs.com/en/Terms-and-Conditions>. Attention is drawn to the limitation of liability, indemnification and jurisdiction issues defined therein. Any holder of this document is advised that information contained hereon reflects the Company's findings at the time of its intervention only and within the limits of Client's instructions, if any. The Company's sole responsibility is to its Client and this document does not exonerate parties to a transaction from exercising all their rights and obligations under the transaction documents. This document cannot be reproduced except in full, without prior written approval of the Company. Any unauthorized alteration, forgery or falsification of the content or appearance of this document is unlawful and offenders may be prosecuted to the fullest extent of the law. Unless otherwise stated the results shown in this test report refer only to the sample(s) tested and such sample(s) are retained for 30 days only.

Test Mode: 08; Polarity: Horizontal; Modulation:802.11ac; Bandwidth:20MHz; Channel:High

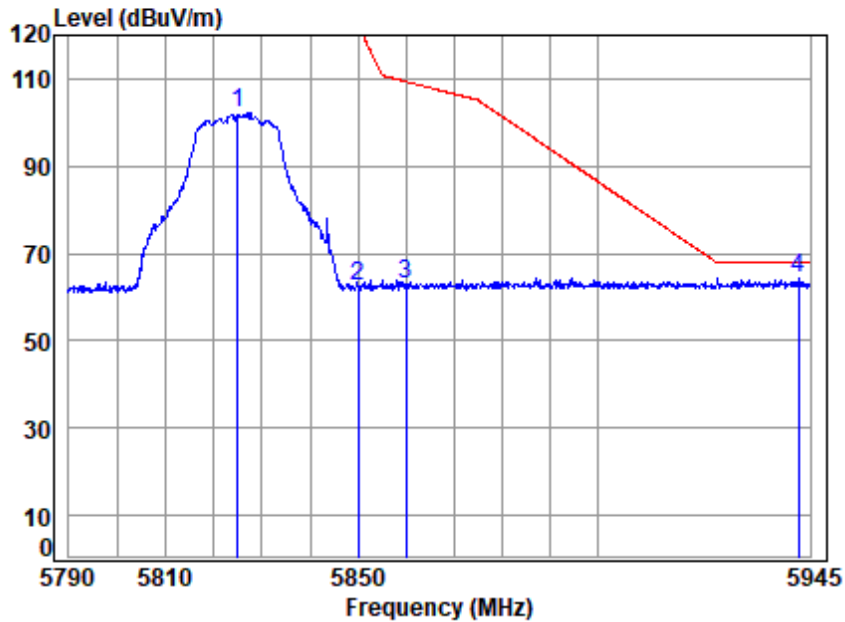

Site : chamber
 Condition: 3m HORIZONTAL
 Job No : 03018AT\03019AT
 Mode : 5825 Band edge
 : 5G WIFI 11AC20

	Freq	Cable Loss	Ant Factor	Preamp Factor	Read Level	Limit Level	Limit Line	Over Limit	Remark
	MHz	dB	dB/m	dB	dBuV	dBuV/m	dBuV/m	dB	
1	5825.000	19.52	34.35	34.98	83.41	102.30	-----	-----	peak
2	5850.000	19.54	34.40	34.97	43.37	62.34	122.20	-59.86	peak
3	5860.000	19.54	34.44	34.96	43.98	63.00	109.40	-46.40	peak
4 p	5942.488	19.59	34.68	34.93	44.86	64.20	68.20	-4.00	peak



Unless otherwise agreed in writing, this document is issued by the Company subject to its General Conditions of Service printed overleaf, available on request or accessible at <https://www.sgs.com/en/Terms-and-Conditions>. Attention is drawn to the limitation of liability, indemnification and jurisdiction issues defined therein. Any holder of this document is advised that information contained hereon reflects the Company's findings at the time of its intervention only and within the limits of Client's instructions, if any. The Company's sole responsibility is to its Client and this document does not exonerate parties to a transaction from exercising all their rights and obligations under the transaction documents. This document cannot be reproduced except in full, without prior written approval of the Company. Any unauthorized alteration, forgery or falsification of the content or appearance of this document is unlawful and offenders may be prosecuted to the fullest extent of the law. Unless otherwise stated the results shown in this test report refer only to the sample(s) tested and such sample(s) are retained for 30 days only.

Test Mode: 08; Polarity: Vertical; Modulation:802.11ac; Bandwidth:20MHz; Channel:High

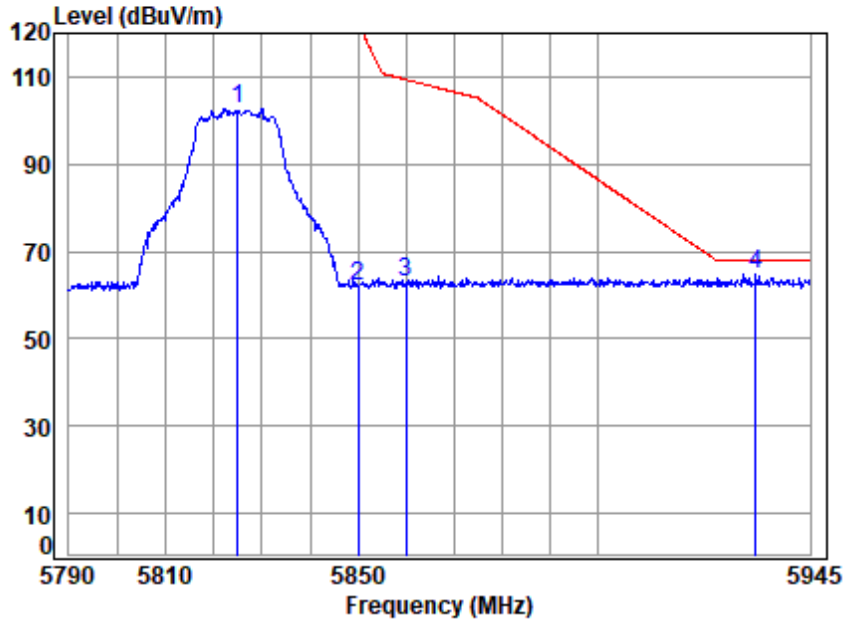

Site : chamber
 Condition: 3m VERTICAL
 Job No : 03018AT\03019AT
 Mode : 5825 Band edge
 : 5G WIFI 11AC20

	Freq	Cable Loss	Ant Factor	Preamp Factor	Read Level	Limit Level	Limit Line	Over Limit	Remark
	MHz	dB	dB/m	dB	dBuV	dBuV/m	dBuV/m	dB	
1	5825.000	19.52	34.35	34.98	83.81	102.70	-----	-----	peak
2	5850.000	19.54	34.40	34.97	42.89	61.86	122.20	-60.34	peak
3	5860.000	19.54	34.44	34.96	44.04	63.06	109.40	-46.34	peak
4 p	5933.546	19.59	34.67	34.93	45.52	64.85	68.20	-3.35	peak



Unless otherwise agreed in writing, this document is issued by the Company subject to its General Conditions of Service printed overleaf, available on request or accessible at <https://www.sgs.com/en/Terms-and-Conditions>. Attention is drawn to the limitation of liability, indemnification and jurisdiction issues defined therein. Any holder of this document is advised that information contained hereon reflects the Company's findings at the time of its intervention only and within the limits of Client's instructions, if any. The Company's sole responsibility is to its Client and this document does not exonerate parties to a transaction from exercising all their rights and obligations under the transaction documents. This document cannot be reproduced except in full, without prior written approval of the Company. Any unauthorized alteration, forgery or falsification of the content or appearance of this document is unlawful and offenders may be prosecuted to the fullest extent of the law. Unless otherwise stated the results shown in this test report refer only to the sample(s) tested and such sample(s) are retained for 30 days only.

Test Mode: 08; Polarity: Horizontal; Modulation:802.11ac; Bandwidth:40MHz; Channel:Low

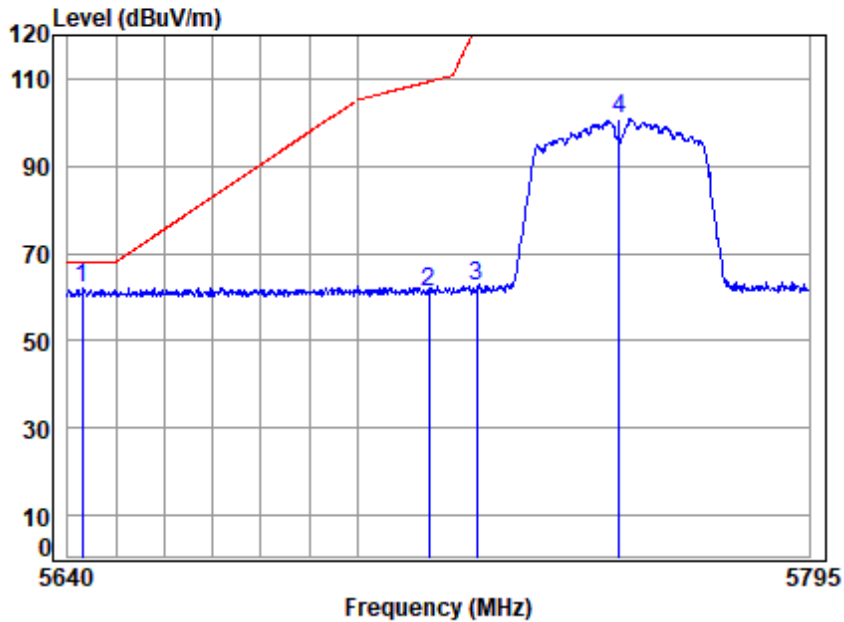

Site : chamber
 Condition: 3m HORIZONTAL
 Job No : 03018AT\03019AT
 Mode : 5755 Band edge
 : 5G WIFI 11AC40

		Cable	Ant	Preamp	Read	Limit	Over	
Freq	Loss	Factor	Factor	Factor	Level	Level	Line	Limit Remark
MHz	dB	dB/m	dB	dB	dBuV	dBuV/m	dBuV/m	dB
1 p 5643.059	19.40	34.44	35.06	43.16	61.94	68.20	-6.26	peak
2 5715.000	19.45	34.27	35.03	42.24	60.93	109.40	-48.47	peak
3 5725.000	19.46	34.25	35.03	44.02	62.70	122.20	-59.50	peak
4 5755.000	19.48	34.21	35.01	82.08	100.76	-----	-----	peak



Unless otherwise agreed in writing, this document is issued by the Company subject to its General Conditions of Service printed overleaf, available on request or accessible at <https://www.sgs.com/en/Terms-and-Conditions>. Attention is drawn to the limitation of liability, indemnification and jurisdiction issues defined therein. Any holder of this document is advised that information contained hereon reflects the Company's findings at the time of its intervention only and within the limits of Client's instructions, if any. The Company's sole responsibility is to its Client and this document does not exonerate parties to a transaction from exercising all their rights and obligations under the transaction documents. This document cannot be reproduced except in full, without prior written approval of the Company. Any unauthorized alteration, forgery or falsification of the content or appearance of this document is unlawful and offenders may be prosecuted to the fullest extent of the law. Unless otherwise stated the results shown in this test report refer only to the sample(s) tested and such sample(s) are retained for 30 days only.

Test Mode: 08; Polarity: Vertical; Modulation:802.11ac; Bandwidth:40MHz; Channel:Low

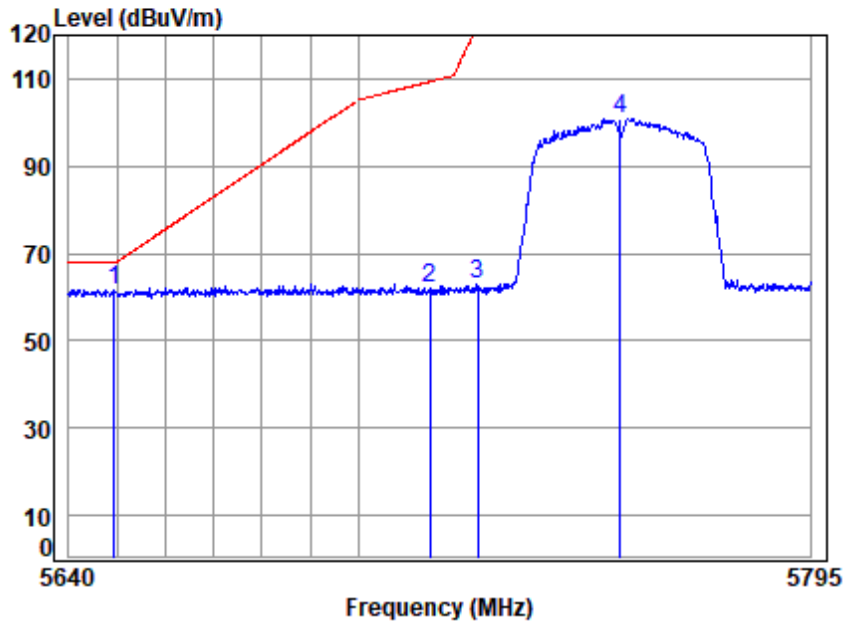

Site : chamber
 Condition: 3m VERTICAL
 Job No : 03018AT\03019AT
 Mode : 5755 Band edge
 : 5G WIFI 11AC40

		Cable	Ant	Preamp	Read	Limit	Over	
Freq	Loss	Factor	Factor	Factor	Level	Line	Limit	Remark
MHz	dB	dB/m	dB	dB	dBuV	dBuV/m	dBuV/m	dB
1 p 5649.335	19.41	34.40	35.06	43.04	61.79	68.20	-6.41	peak
2 5715.000	19.45	34.27	35.03	43.27	61.96	109.40	-47.44	peak
3 5725.000	19.46	34.25	35.03	44.14	62.82	122.20	-59.38	peak
4 5755.000	19.48	34.21	35.01	82.36	101.04	-----	-----	peak



Unless otherwise agreed in writing, this document is issued by the Company subject to its General Conditions of Service printed overleaf, available on request or accessible at <https://www.sgs.com/en/Terms-and-Conditions>. Attention is drawn to the limitation of liability, indemnification and jurisdiction issues defined therein. Any holder of this document is advised that information contained hereon reflects the Company's findings at the time of its intervention only and within the limits of Client's instructions, if any. The Company's sole responsibility is to its Client and this document does not exonerate parties to a transaction from exercising all their rights and obligations under the transaction documents. This document cannot be reproduced except in full, without prior written approval of the Company. Any unauthorized alteration, forgery or falsification of the content or appearance of this document is unlawful and offenders may be prosecuted to the fullest extent of the law. Unless otherwise stated the results shown in this test report refer only to the sample(s) tested and such sample(s) are retained for 30 days only.

Test Mode: 08; Polarity: Horizontal; Modulation:802.11ac; Bandwidth:40MHz; Channel:High

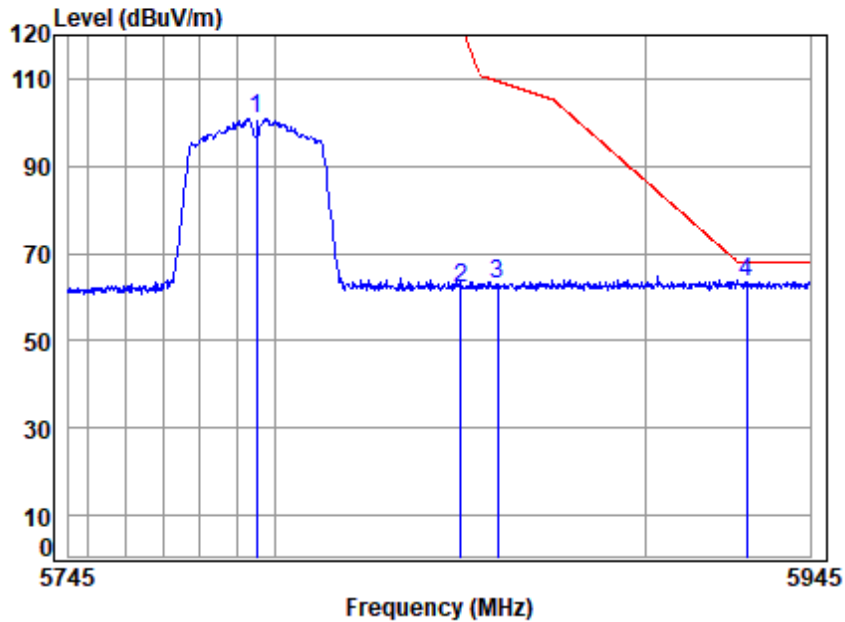

Site : chamber
 Condition: 3m HORIZONTAL
 Job No : 03018AT\03019AT
 Mode : 5795 Band edge
 : 5G WIFI 11AC40

	Freq	Cable Loss	Ant Factor	Preamp Factor	Read Level	Limit Level	Over Limit	Remark
	MHz	dB	dB/m	dB	dBuV	dBuV/m	dBuV/m	dB
1	5795.000	19.50	34.29	34.99	81.97	100.77	-----	peak
2	5850.000	19.54	34.40	34.97	42.93	61.90	122.20	-60.30 peak
3	5860.000	19.54	34.44	34.96	43.81	62.83	109.40	-46.57 peak
4 p	5927.530	19.59	34.66	34.93	44.29	63.61	68.20	-4.59 peak



Unless otherwise agreed in writing, this document is issued by the Company subject to its General Conditions of Service printed overleaf, available on request or accessible at <https://www.sgs.com/en/Terms-and-Conditions>. Attention is drawn to the limitation of liability, indemnification and jurisdiction issues defined therein. Any holder of this document is advised that information contained hereon reflects the Company's findings at the time of its intervention only and within the limits of Client's instructions, if any. The Company's sole responsibility is to its Client and this document does not exonerate parties to a transaction from exercising all their rights and obligations under the transaction documents. This document cannot be reproduced except in full, without prior written approval of the Company. Any unauthorized alteration, forgery or falsification of the content or appearance of this document is unlawful and offenders may be prosecuted to the fullest extent of the law. Unless otherwise stated the results shown in this test report refer only to the sample(s) tested and such sample(s) are retained for 30 days only.

Test Mode: 08; Polarity: Vertical; Modulation:802.11ac; Bandwidth:40MHz; Channel:High

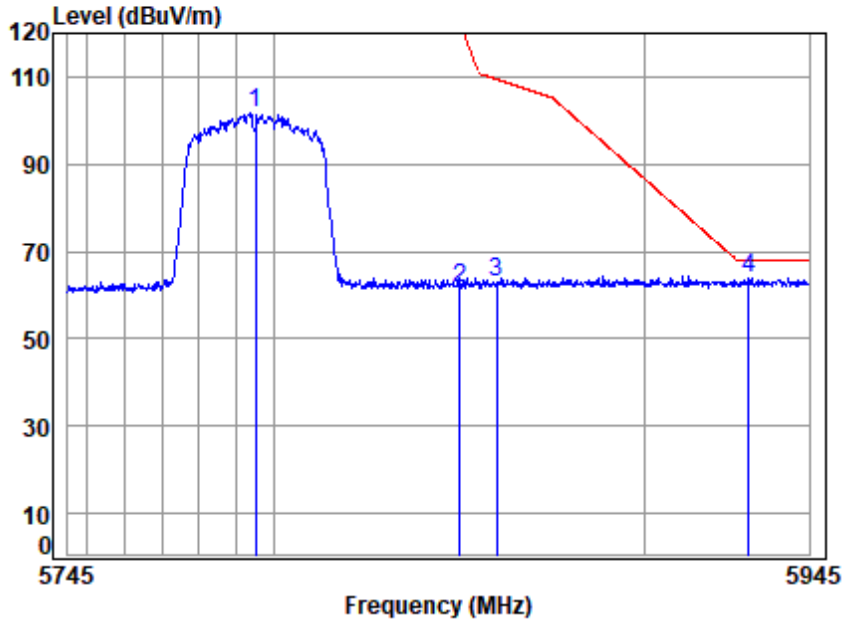

Site : chamber
 Condition: 3m VERTICAL
 Job No : 03018AT\03019AT
 Mode : 5795 Band edge
 : 5G WIFI 11AC40

	Freq	Cable Loss	Ant Factor	Preamp Factor	Read Level	Limit Level	Over Limit	Remark
	MHz	dB	dB/m	dB	dBuV	dBuV/m	dBuV/m	dB
1	5795.000	19.50	34.29	34.99	82.87	101.67	-----	peak
2	5850.000	19.54	34.40	34.97	42.78	61.75	122.20	-60.45 peak
3	5860.000	19.54	34.44	34.96	44.00	63.02	109.40	-46.38 peak
4 p	5928.544	19.59	34.66	34.93	44.60	63.92	68.20	-4.28 peak



Unless otherwise agreed in writing, this document is issued by the Company subject to its General Conditions of Service printed overleaf, available on request or accessible at <https://www.sgs.com/en/Terms-and-Conditions>. Attention is drawn to the limitation of liability, indemnification and jurisdiction issues defined therein. Any holder of this document is advised that information contained hereon reflects the Company's findings at the time of its intervention only and within the limits of Client's instructions, if any. The Company's sole responsibility is to its Client and this document does not exonerate parties to a transaction from exercising all their rights and obligations under the transaction documents. This document cannot be reproduced except in full, without prior written approval of the Company. Any unauthorized alteration, forgery or falsification of the content or appearance of this document is unlawful and offenders may be prosecuted to the fullest extent of the law. Unless otherwise stated the results shown in this test report refer only to the sample(s) tested and such sample(s) are retained for 30 days only.

Test Mode: 08; Polarity: Horizontal; Modulation:802.11ac; Bandwidth:80MHz; Channel:middle

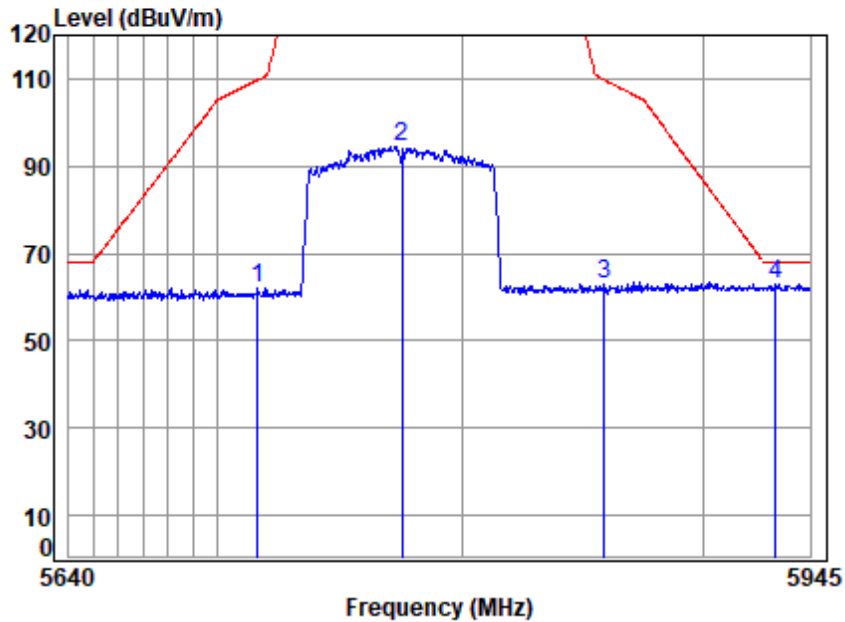

Site : chamber
 Condition: 3m HORIZONTAL
 Job No : 03018AT\03019AT
 Mode : 5775 Band edge
 : 5G WIFI 11AC80

	Cable	Ant	Preamp	Read	Limit	Over		
Freq	Loss	Factor	Factor	Level	Level	Line	Limit	Remark
MHz	dB	dB/m	dB	dBuV	dBuV/m	dBuV/m	dB	
1	5716.256	19.45	34.27	35.03	43.44	62.13	109.75	-47.62 peak
2	5775.000	19.49	34.25	35.00	75.75	94.49	-----	----- peak
3	5858.900	19.54	34.44	34.96	43.95	62.97	109.71	-46.74 peak
4 p	5930.615	19.59	34.66	34.93	43.61	62.93	68.20	-5.27 peak



Unless otherwise agreed in writing, this document is issued by the Company subject to its General Conditions of Service printed overleaf, available on request or accessible at <https://www.sgs.com/en/Terms-and-Conditions>. Attention is drawn to the limitation of liability, indemnification and jurisdiction issues defined therein. Any holder of this document is advised that information contained hereon reflects the Company's findings at the time of its intervention only and within the limits of Client's instructions, if any. The Company's sole responsibility is to its Client and this document does not exonerate parties to a transaction from exercising all their rights and obligations under the transaction documents. This document cannot be reproduced except in full, without prior written approval of the Company. Any unauthorized alteration, forgery or falsification of the content or appearance of this document is unlawful and offenders may be prosecuted to the fullest extent of the law. Unless otherwise stated the results shown in this test report refer only to the sample(s) tested and such sample(s) are retained for 30 days only.

Test Mode: 08; Polarity: Vertical; Modulation:802.11ac; Bandwidth:80MHz; Channel:middle

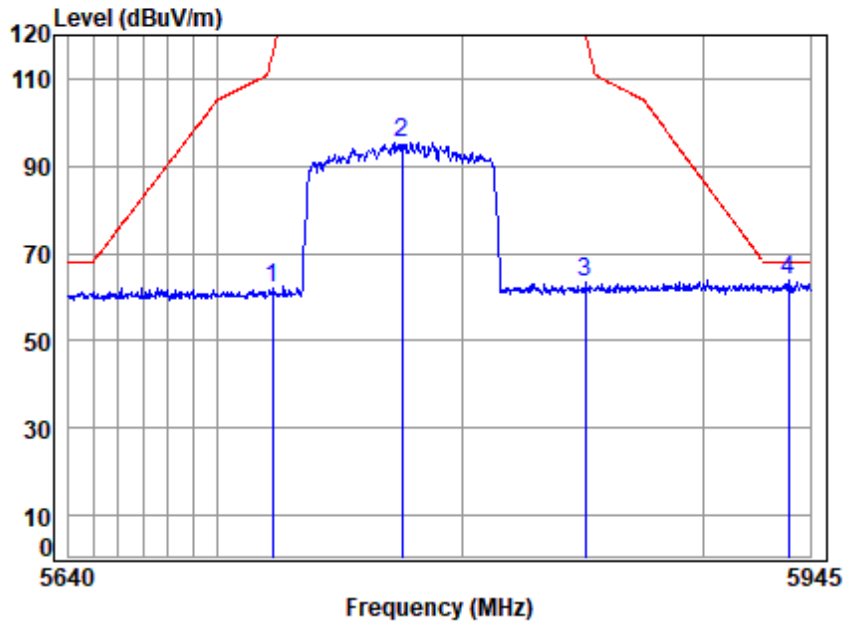

Site : chamber
 Condition: 3m VERTICAL
 Job No : 03018AT\03019AT
 Mode : 5775 Band edge
 : 5G WIFI 11AC80

	Cable	Ant	Preamp	Read	Limit	Over		
Freq	Loss	Factor	Factor	Level	Level	Line	Limit	Remark
MHz	dB	dB/m	dB	dBuV	dBuV/m	dBuV/m	dB	
1	19.46	34.26	35.03	43.22	61.91	116.00	-54.09	peak
2	19.49	34.25	35.00	76.82	95.56	-----	-----	peak
3	19.54	34.40	34.97	44.38	63.35	120.19	-56.84	peak
4 p	19.59	34.67	34.93	44.35	63.68	68.20	-4.52	peak



Unless otherwise agreed in writing, this document is issued by the Company subject to its General Conditions of Service printed overleaf, available on request or accessible at <https://www.sgs.com/en/Terms-and-Conditions>. Attention is drawn to the limitation of liability, indemnification and jurisdiction issues defined therein. Any holder of this document is advised that information contained hereon reflects the Company's findings at the time of its intervention only and within the limits of Client's instructions, if any. The Company's sole responsibility is to its Client and this document does not exonerate parties to a transaction from exercising all their rights and obligations under the transaction documents. This document cannot be reproduced except in full, without prior written approval of the Company. Any unauthorized alteration, forgery or falsification of the content or appearance of this document is unlawful and offenders may be prosecuted to the fullest extent of the law. Unless otherwise stated the results shown in this test report refer only to the sample(s) tested and such sample(s) are retained for 30 days only.

Test Mode: 08; Polarity: Horizontal; Modulation:802.11 ax(Full RU0); Bandwidth:20MHz; Channel:Low

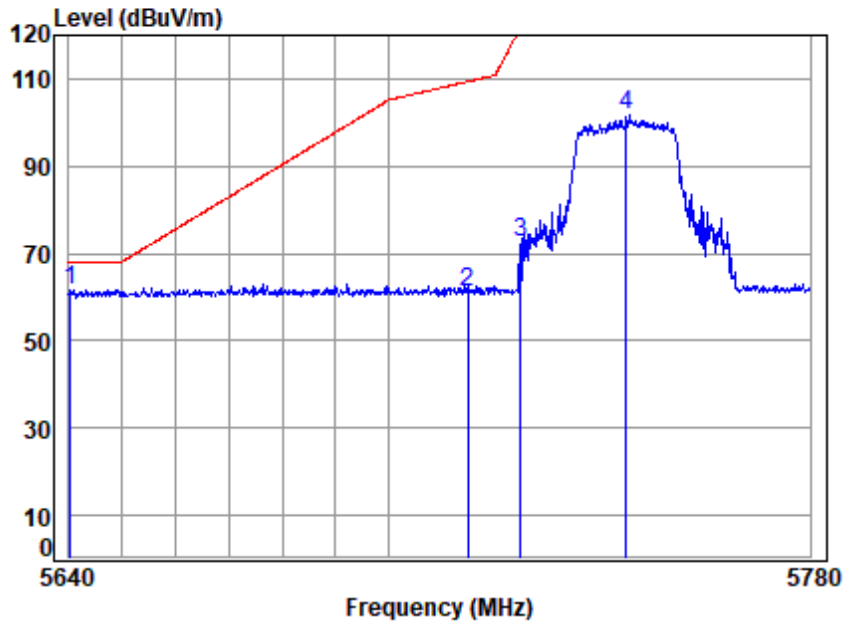

Site : chamber
 Condition: 3m HORIZONTAL
 Job No : 03018AT\03019AT
 Mode : 5745 Band edge
 : 5G WIFI 11AX20

		Cable	Ant	Preamp	Read	Limit	Over	
Freq	Loss	Factor	Factor	Factor	Level	Level	Line	Limit Remark
MHz	dB	dB/m	dB	dB	dBuV	dBuV/m	dBuV/m	dB
1 p 5640.276	19.40	34.46	35.07	42.81	61.60	68.20	-6.60	peak
2 5715.000	19.45	34.27	35.03	42.53	61.22	109.40	-48.18	peak
3 5725.000	19.46	34.25	35.03	53.97	72.65	122.20	-49.55	peak
4 5745.000	19.47	34.21	35.02	83.07	101.73	-----	-----	peak



Unless otherwise agreed in writing, this document is issued by the Company subject to its General Conditions of Service printed overleaf, available on request or accessible at <https://www.sgs.com/en/Terms-and-Conditions>. Attention is drawn to the limitation of liability, indemnification and jurisdiction issues defined therein. Any holder of this document is advised that information contained hereon reflects the Company's findings at the time of its intervention only and within the limits of Client's instructions, if any. The Company's sole responsibility is to its Client and this document does not exonerate parties to a transaction from exercising all their rights and obligations under the transaction documents. This document cannot be reproduced except in full, without prior written approval of the Company. Any unauthorized alteration, forgery or falsification of the content or appearance of this document is unlawful and offenders may be prosecuted to the fullest extent of the law. Unless otherwise stated the results shown in this test report refer only to the sample(s) tested and such sample(s) are retained for 30 days only.

Test Mode: 08; Polarity: Vertical; Modulation:802.11ax(Full RU0); Bandwidth:20MHz; Channel:Low

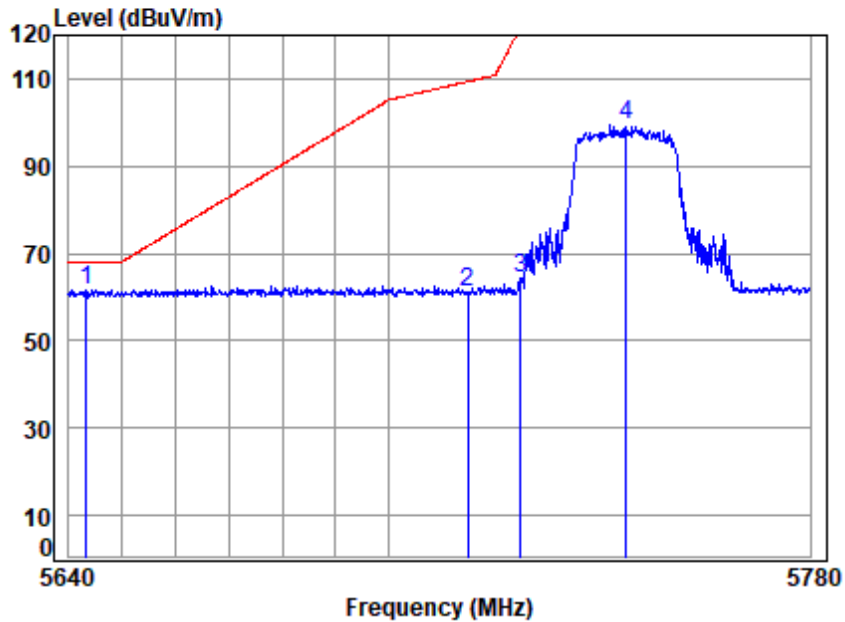

Site : chamber
 Condition: 3m VERTICAL
 Job No : 03018AT\03019AT
 Mode : 5745 Band edge
 : 5G WIFI 11AX20

		Cable	Ant	Preamp	Read	Limit	Over	
	Freq	Loss	Factor	Factor	Level	Level	Line	Limit
	MHz	dB	dB/m	dB	dBuV	dBuV/m	dBuV/m	dB
1 p	5643.182	19.40	34.44	35.06	42.89	61.67	68.20	-6.53 peak
2	5715.000	19.45	34.27	35.03	42.65	61.34	109.40	-48.06 peak
3	5725.000	19.46	34.25	35.03	45.75	64.43	122.20	-57.77 peak
4	5745.000	19.47	34.21	35.02	80.69	99.35	-----	----- peak



Unless otherwise agreed in writing, this document is issued by the Company subject to its General Conditions of Service printed overleaf, available on request or accessible at <https://www.sgs.com/en/Terms-and-Conditions>. Attention is drawn to the limitation of liability, indemnification and jurisdiction issues defined therein. Any holder of this document is advised that information contained hereon reflects the Company's findings at the time of its intervention only and within the limits of Client's instructions, if any. The Company's sole responsibility is to its Client and this document does not exonerate parties to a transaction from exercising all their rights and obligations under the transaction documents. This document cannot be reproduced except in full, without prior written approval of the Company. Any unauthorized alteration, forgery or falsification of the content or appearance of this document is unlawful and offenders may be prosecuted to the fullest extent of the law. Unless otherwise stated the results shown in this test report refer only to the sample(s) tested and such sample(s) are retained for 30 days only.

Test Mode: 08; Polarity: Horizontal; Modulation:802.11ax(Full RU0); Bandwidth:20MHz; Channel:High

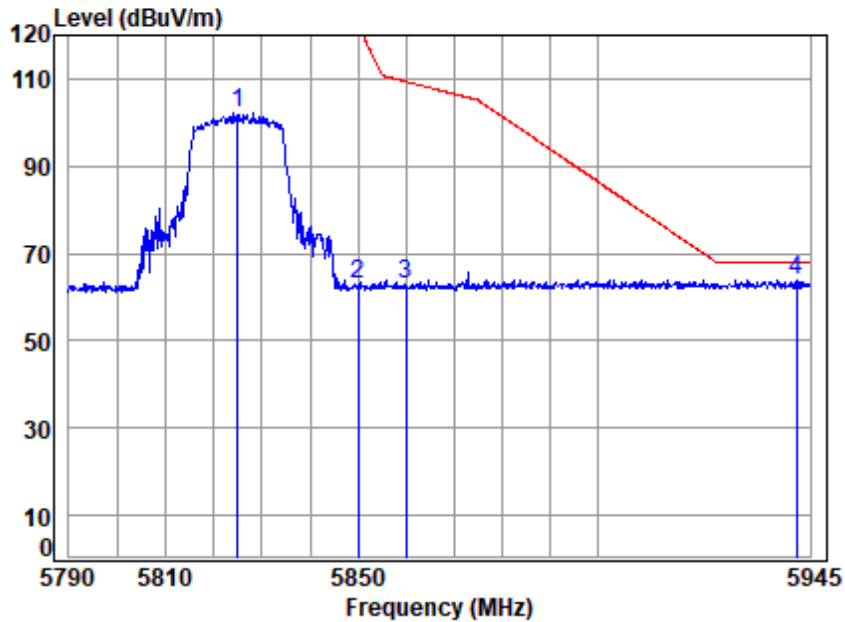

Site : chamber
 Condition: 3m HORIZONTAL
 Job No : 03018AT\03019AT
 Mode : 5825 Band edge
 : 5G WIFI 11AX20

	Freq	Cable Loss	Ant Factor	Preamp Factor	Read Level	Limit Level	Limit Line	Over Limit	Remark
	MHz	dB	dB/m	dB	dBuV	dBuV/m	dBuV/m	dB	
1	5825.000	19.52	34.35	34.98	83.35	102.24	-----	-----	peak
2	5850.000	19.54	34.40	34.97	43.98	62.95	122.20	-59.25	peak
3	5860.000	19.54	34.44	34.96	43.87	62.89	109.40	-46.51	peak
4 p	5942.174	19.59	34.68	34.93	44.65	63.99	68.20	-4.21	peak



Unless otherwise agreed in writing, this document is issued by the Company subject to its General Conditions of Service printed overleaf, available on request or accessible at <https://www.sgs.com/en/Terms-and-Conditions>. Attention is drawn to the limitation of liability, indemnification and jurisdiction issues defined therein. Any holder of this document is advised that information contained hereon reflects the Company's findings at the time of its intervention only and within the limits of Client's instructions, if any. The Company's sole responsibility is to its Client and this document does not exonerate parties to a transaction from exercising all their rights and obligations under the transaction documents. This document cannot be reproduced except in full, without prior written approval of the Company. Any unauthorized alteration, forgery or falsification of the content or appearance of this document is unlawful and offenders may be prosecuted to the fullest extent of the law. Unless otherwise stated the results shown in this test report refer only to the sample(s) tested and such sample(s) are retained for 30 days only.

Test Mode: 08; Polarity: Vertical; Modulation:802.11ax(Full RU0); Bandwidth:20MHz; Channel:High

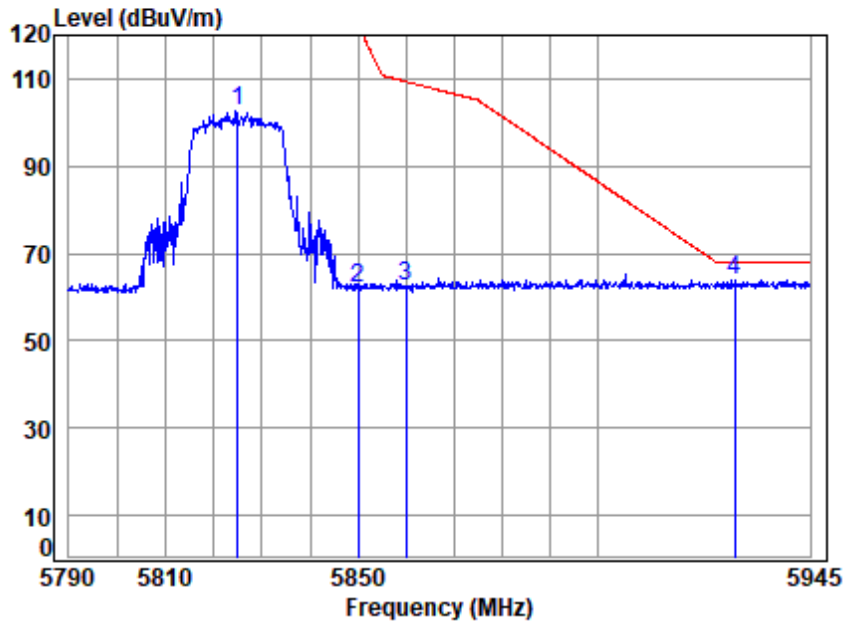

Site : chamber
 Condition: 3m VERTICAL
 Job No : 03018AT\03019AT
 Mode : 5825 Band edge
 : 5G WIFI 11AX20

	Freq	Cable Loss	Ant Factor	Preamp Factor	Read Level	Limit Level	Limit Line	Over Limit	Remark
	MHz	dB	dB/m	dB	dBuV	dBuV/m	dBuV/m	dB	
1	5825.000	19.52	34.35	34.98	83.61	102.50	-----	-----	peak
2	5850.000	19.54	34.40	34.97	43.17	62.14	122.20	-60.06	peak
3	5860.000	19.54	34.44	34.96	43.48	62.50	109.40	-46.90	peak
4 p	5929.002	19.59	34.66	34.93	44.59	63.91	68.20	-4.29	peak



Unless otherwise agreed in writing, this document is issued by the Company subject to its General Conditions of Service printed overleaf, available on request or accessible at <https://www.sgs.com/en/Terms-and-Conditions>. Attention is drawn to the limitation of liability, indemnification and jurisdiction issues defined therein. Any holder of this document is advised that information contained hereon reflects the Company's findings at the time of its intervention only and within the limits of Client's instructions, if any. The Company's sole responsibility is to its Client and this document does not exonerate parties to a transaction from exercising all their rights and obligations under the transaction documents. This document cannot be reproduced except in full, without prior written approval of the Company. Any unauthorized alteration, forgery or falsification of the content or appearance of this document is unlawful and offenders may be prosecuted to the fullest extent of the law. Unless otherwise stated the results shown in this test report refer only to the sample(s) tested and such sample(s) are retained for 30 days only.

Test Mode: 08; Polarity: Horizontal; Modulation:802.11ax(26 RU0); Bandwidth:20MHz; Channel:Low

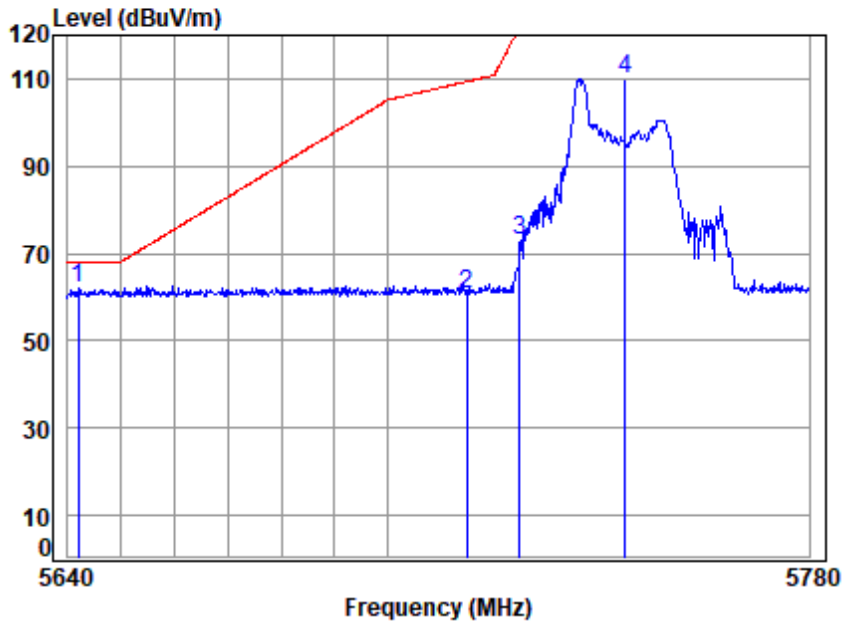

Site	: chamber							
Condition:	3m HORIZONTAL							
Job No	: 03018AT\03019AT							
Mode	: 5745 Band edge							
	: 5G WIFI 11AX20 Partial RU							
	Cable	Ant	Preamp	Read		Limit	Over	
Freq	Loss	Factor	Factor	Level	Level	Line	Limit	Remark
	dB	dB/m	dB	dBuV	dBuV/m	dBuV/m	dB	
1 p	5641.937	19.40	34.45	35.07	43.11	61.89	68.20	-6.31 peak
2	5715.000	19.45	34.27	35.03	42.04	60.73	109.40	-48.67 peak
3	5725.000	19.46	34.25	35.03	54.17	72.85	122.20	-49.35 peak
4	5745.000	19.47	34.21	35.02	91.50	110.16	-----	----- peak



Unless otherwise agreed in writing, this document is issued by the Company subject to its General Conditions of Service printed overleaf, available on request or accessible at <https://www.sgs.com/en/Terms-and-Conditions>. Attention is drawn to the limitation of liability, indemnification and jurisdiction issues defined therein. Any holder of this document is advised that information contained hereon reflects the Company's findings at the time of its intervention only and within the limits of Client's instructions, if any. The Company's sole responsibility is to its Client and this document does not exonerate parties to a transaction from exercising all their rights and obligations under the transaction documents. This document cannot be reproduced except in full, without prior written approval of the Company. Any unauthorized alteration, forgery or falsification of the content or appearance of this document is unlawful and offenders may be prosecuted to the fullest extent of the law. Unless otherwise stated the results shown in this test report refer only to the sample(s) tested and such sample(s) are retained for 30 days only.

Test Mode: 08; Polarity: Vertical; Modulation:802.11ax(26 RU0); Bandwidth:20MHz; Channel:Low

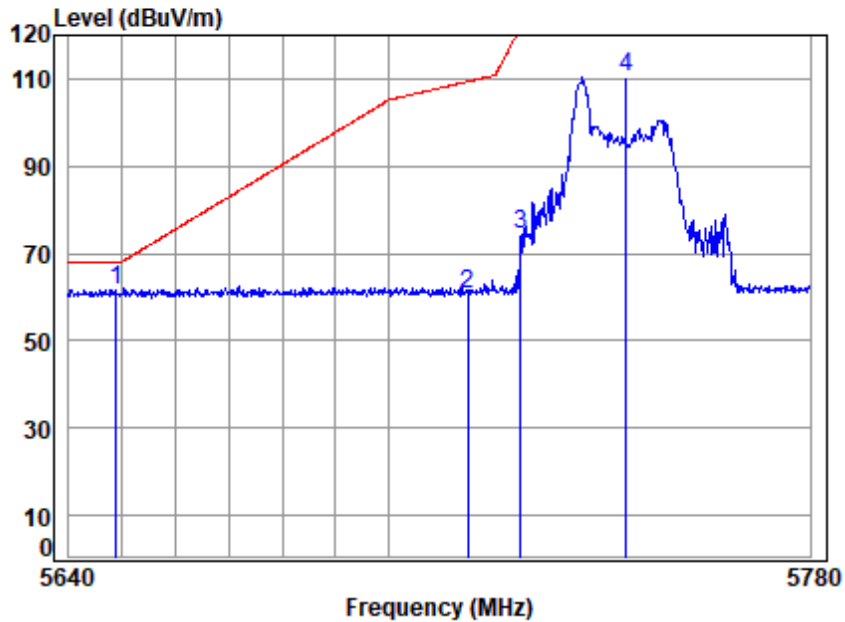

Site : chamber
 Condition: 3m VERTICAL
 Job No : 03018AT\03019AT
 Mode : 5745 Band edge
 : 5G WIFI 11AX20 Partial RU

	Cable	Ant	Preamp	Read	Limit	Over		
Freq	Loss	Factor	Factor	Level	Level	Line	Limit	Remark
MHz	dB	dB/m	dB	dBuV	dBuV/m	dBuV/m	dB	
1 p 5648.857	19.41	34.41	35.06	42.98	61.74	68.20	-6.46	peak
2 5715.000	19.45	34.27	35.03	42.03	60.72	109.40	-48.68	peak
3 5725.000	19.46	34.25	35.03	55.67	74.35	122.20	-47.85	peak
4 5745.000	19.47	34.21	35.02	91.86	110.52	-----	-----	peak



Unless otherwise agreed in writing, this document is issued by the Company subject to its General Conditions of Service printed overleaf, available on request or accessible at <https://www.sgs.com/en/Terms-and-Conditions>. Attention is drawn to the limitation of liability, indemnification and jurisdiction issues defined therein. Any holder of this document is advised that information contained hereon reflects the Company's findings at the time of its intervention only and within the limits of Client's instructions, if any. The Company's sole responsibility is to its Client and this document does not exonerate parties to a transaction from exercising all their rights and obligations under the transaction documents. This document cannot be reproduced except in full, without prior written approval of the Company. Any unauthorized alteration, forgery or falsification of the content or appearance of this document is unlawful and offenders may be prosecuted to the fullest extent of the law. Unless otherwise stated the results shown in this test report refer only to the sample(s) tested and such sample(s) are retained for 30 days only.

Test Mode: 08; Polarity: Horizontal; Modulation:802.11ax(26 RU0); Bandwidth:20MHz; Channel:High

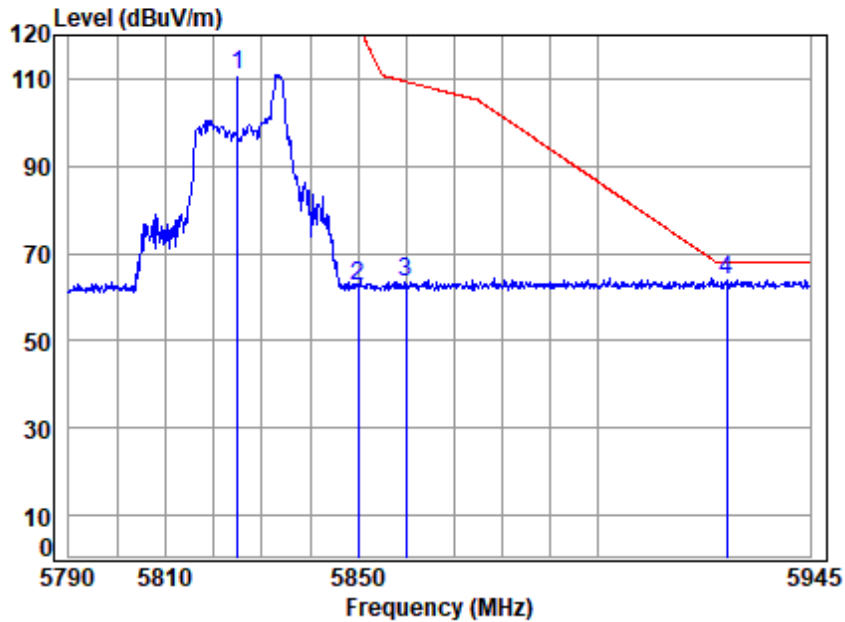

Site	: chamber								
Condition:	3m HORIZONTAL								
Job No	: 03018AT\03019AT								
Mode	: 5825 Band edge								
	: 5G WIFI 11AX20 Partial RU								
	Cable	Ant	Preamp	Read		Limit	Over		
Freq	Loss	Factor	Factor	Level	Level	Line	Limit	Remark	
	dB	dB/m	dB	dBuV	dBuV/m	dBuV/m	dB		
1	19.52	34.35	34.98	92.18	111.07	-----	-----	peak	
2	19.54	34.40	34.97	43.40	62.37	122.20	-59.83	peak	
3	19.54	34.44	34.96	44.30	63.32	109.40	-46.08	peak	
4 p	19.59	34.65	34.93	44.59	63.90	68.20	-4.30	peak	



Unless otherwise agreed in writing, this document is issued by the Company subject to its General Conditions of Service printed overleaf, available on request or accessible at <https://www.sgs.com/en/Terms-and-Conditions>. Attention is drawn to the limitation of liability, indemnification and jurisdiction issues defined therein. Any holder of this document is advised that information contained hereon reflects the Company's findings at the time of its intervention only and within the limits of Client's instructions, if any. The Company's sole responsibility is to its Client and this document does not exonerate parties to a transaction from exercising all their rights and obligations under the transaction documents. This document cannot be reproduced except in full, without prior written approval of the Company. Any unauthorized alteration, forgery or falsification of the content or appearance of this document is unlawful and offenders may be prosecuted to the fullest extent of the law. Unless otherwise stated the results shown in this test report refer only to the sample(s) tested and such sample(s) are retained for 30 days only.

Test Mode: 08; Polarity: Vertical; Modulation:802.11ax(26 RU0); Bandwidth:20MHz; Channel:High

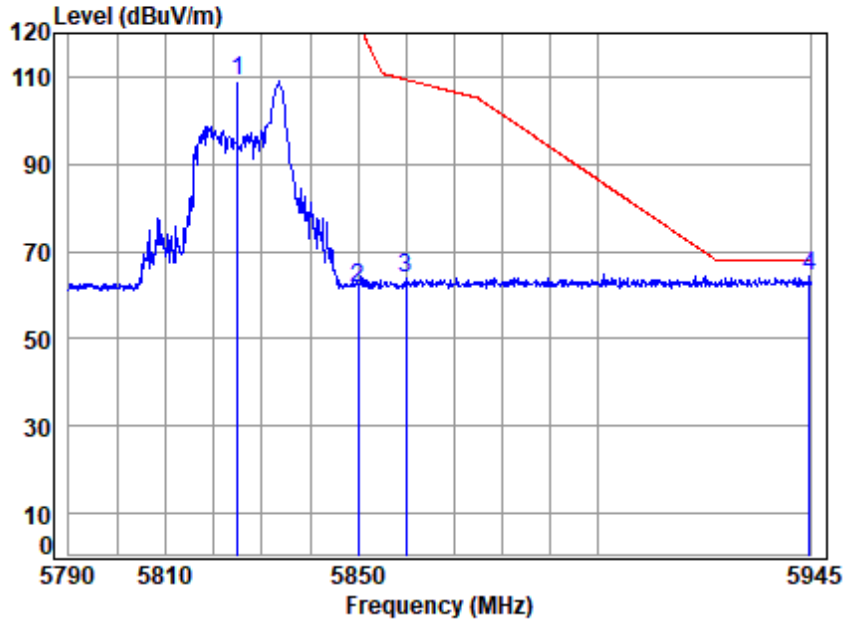

Site : chamber
 Condition: 3m VERTICAL
 Job No : 03018AT\03019AT
 Mode : 5825 Band edge
 : 5G WIFI 11AX20 Partial RU

	Cable	Ant	Preamp	Read	Limit	Over		
Freq	Loss	Factor	Factor	Level	Level	Line	Limit	Remark
MHz	dB	dB/m	dB	dBuV	dBuV/m	dBuV/m	dB	
1	5825.000	19.52	34.35	34.98	90.02	108.91	-----	----- peak
2	5850.000	19.54	34.40	34.97	42.61	61.58	122.20	-60.62 peak
3	5860.000	19.54	34.44	34.96	45.02	64.04	109.40	-45.36 peak
4 p	5944.843	19.60	34.69	34.92	44.80	64.17	68.20	-4.03 peak



Unless otherwise agreed in writing, this document is issued by the Company subject to its General Conditions of Service printed overleaf, available on request or accessible at <https://www.sgs.com/en/Terms-and-Conditions>. Attention is drawn to the limitation of liability, indemnification and jurisdiction issues defined therein. Any holder of this document is advised that information contained hereon reflects the Company's findings at the time of its intervention only and within the limits of Client's instructions, if any. The Company's sole responsibility is to its Client and this document does not exonerate parties to a transaction from exercising all their rights and obligations under the transaction documents. This document cannot be reproduced except in full, without prior written approval of the Company. Any unauthorized alteration, forgery or falsification of the content or appearance of this document is unlawful and offenders may be prosecuted to the fullest extent of the law. Unless otherwise stated the results shown in this test report refer only to the sample(s) tested and such sample(s) are retained for 30 days only.

7.6 Channel Move Time

Test Requirement KDB 905462 D02 Section 5.1
 Test Method: KDB 905462 D02 Section 7.8.3

Limit:

Test item	Limit	Applicability	
		Master Device or client with Radar Detection	Client without Radar Detection
Non-occupancy period	Minimum 30 minutes	Yes	Not required
Channel Availability Check Time	60 seconds	Yes	Not required
Channel Move Time	10 seconds See Note 1.	Yes	Yes
Channel Closing Transmission Time	200 milliseconds + an aggregate of 60 milliseconds over remaining 10 second period. See Notes 1 and 2.	Yes	Yes
U-NII Detection Bandwidth	Minimum 100% of the U-NII 99% transmission power bandwidth. See Note 3.	Yes	Not required

Note 1: Channel Move Time and the Channel Closing Transmission Time should be performed with Radar Type 0. The measurement timing begins at the end of the Radar Type 0 burst.

Note 2: The Channel Closing Transmission Time is comprised of 200 milliseconds starting at the beginning of the Channel Move Time plus any additional intermittent control signals required to facilitate a Channel move (an aggregate of 60 milliseconds) during the remainder of the 10 second period. The aggregate duration of control signals will not count quiet periods in between transmissions.

Note 3: During the U-NII Detection Bandwidth detection test, radar type 0 should be used. For each frequency step the minimum percentage of detection is 90 percent. Measurements are performed with no data traffic.

7.6.1 E.U.T. Operation

Operating Environment:

Temperature: 24.2 °C Humidity: 46.7 % RH Atmospheric Pressure: 1020 mbar



Unless otherwise agreed in writing, this document is issued by the Company subject to its General Conditions of Service printed overleaf, available on request or accessible at <https://www.sgs.com/en/Terms-and-Conditions>. Attention is drawn to the limitation of liability, indemnification and jurisdiction issues defined therein. Any holder of this document is advised that information contained hereon reflects the Company's findings at the time of its intervention only and within the limits of Client's instructions, if any. The Company's sole responsibility is to its Client and this document does not exonerate parties to a transaction from exercising all their rights and obligations under the transaction documents. This document cannot be reproduced except in full, without prior written approval of the Company. Any unauthorized alteration, forgery or falsification of the content or appearance of this document is unlawful and offenders may be prosecuted to the fullest extent of the law. Unless otherwise stated the results shown in this test report refer only to the sample(s) tested and such sample(s) are retained for 30 days only.

7.6.2 Test Mode Description

Pre-scan / Final test	Mode Code	Description
Final test	09	Normal operating_Keep the EUT communication with the companion device.

7.6.3 Test Setup Diagram

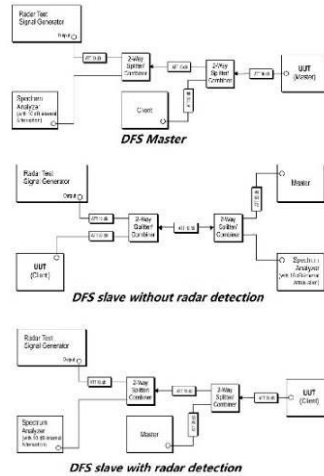

Unless otherwise agreed in writing, this document is issued by the Company subject to its General Conditions of Service printed overleaf, available on request or accessible at <https://www.sgs.com/en/Terms-and-Conditions>. Attention is drawn to the limitation of liability, indemnification and jurisdiction issues defined therein. Any holder of this document is advised that information contained hereon reflects the Company's findings at the time of its intervention only and within the limits of Client's instructions, if any. The Company's sole responsibility is to its Client and this document does not exonerate parties to a transaction from exercising all their rights and obligations under the transaction documents. This document cannot be reproduced except in full, without prior written approval of the Company. Any unauthorized alteration, forgery or falsification of the content or appearance of this document is unlawful and offenders may be prosecuted to the fullest extent of the law. Unless otherwise stated the results shown in this test report refer only to the sample(s) tested and such sample(s) are retained for 30 days only.

Attention: To check the authenticity of testing / inspection report & certificate, please contact us at telephone: (86-755) 8307 1443, or email: CN.Doccheck@sgs.com

7.6.4 Measurement Procedure and Data

- 1) The radar pulse generator is setup to provide a pulse at frequency that the master and client are operating. A type 0 radar pulse with a 1us pulse width and a 1428us PRI is used for the testing.
- 2) The vector signal generator is adjusted to provide the radar burst (18 pulses) at the level of approximately -61dBm at the antenna port of the master device.
- 3) A trigger is provided from the pulse generator to the DFS monitoring system in order to capture the traffic and the occurrence of the radar pulse.
- 4) EUT will associate with the master at channel. The file "iperf.exe" specified by the FCC is streamed from the PC 2 through the master and the client device to the PC 1 and played in full motion video using Media Player Classic Ver. 6.4.8.6 in order to properly load the network for the entire period of the test.
- 5) When radar burst with a level equal to the DFS Detection Threshold +1dB is generated on the operating channel of the U-NII device. At time T0 the radar waveform generator sends a burst of pulse of the radar waveform at Detection Threshold +1dB.
- 6) Observe the transmissions of the EUT at the end of the radar Burst on the Operating Channel. Measure and record the transmissions from the UUT during the observation time (Channel Move Time). One 15 seconds plot is reported for the Short Pulse Radar Type 0. The plot for the Short Pulse Radar Types start at the end of the radar burst. The Channel Move Time will be calculated based on the zoom in 600ms plot of the Short Pulse Radar Type.
- 7) Measurement of the aggregate duration of the Channel Closed Transmission Time method. With the spectrum analyzer set to zero span tuned to the center frequency of the EUT operating channel at the radar simulated frequency, peak detection, and max hold, the dwell time per bin is given by: $Dwell (0.3ms) = S (12000ms) / B (4000)$; where Dwell is the dwell time per spectrum analyzer sampling bin, S is sweep time and B is the number of spectrum analyzer sampling bins. An upper bound of the aggregate duration of the intermittent control signals of Channel Closing Transmission Time is calculated by: $C (ms) = N \times Dwell (0.3ms)$; where C is the Closing Time, N is the number of spectrum analyzer sampling bins (intermittent control signals) showing a U-NII transmission and Dwell is the dwell time per bin.
- 8) Measurement the EUT for more than 30 minutes following the channel move time to verify that no transmission or beacons occur on this channel.

Please Refer to Appendix for Details



Unless otherwise agreed in writing, this document is issued by the Company subject to its General Conditions of Service printed overleaf, available on request or accessible at <https://www.sgs.com/en/Terms-and-Conditions>. Attention is drawn to the limitation of liability, indemnification and jurisdiction issues defined therein. Any holder of this document is advised that information contained hereon reflects the Company's findings at the time of its intervention only and within the limits of Client's instructions, if any. The Company's sole responsibility is to its Client and this document does not exonerate parties to a transaction from exercising all their rights and obligations under the transaction documents. This document cannot be reproduced except in full, without prior written approval of the Company. Any unauthorized alteration, forgery or falsification of the content or appearance of this document is unlawful and offenders may be prosecuted to the fullest extent of the law. Unless otherwise stated the results shown in this test report refer only to the sample(s) tested and such sample(s) are retained for 30 days only.

Attention: To check the authenticity of testing /inspection report & certificate, please contact us at telephone: (86-755) 8307 1443, or email: CN.Doccheck@sgs.com

7.7 Duty Cycle

Test Requirement KDB 789033 D02 II B 1
 Test Method: KDB 789033 II B 1

7.7.1 E.U.T. Operation

Operating Environment:
 Temperature: 24.2 °C Humidity: 46.7 % RH Atmospheric Pressure: 1020 mbar

7.7.2 Test Mode Description

Pre-scan / Final test	Mode Code	Description
Final test	05	TX mode (U-NII-1)_Keep the EUT in continuously transmitting mode with all modulation types. All data rates for each modulation type have been tested and found the data rate @ 6Mbps is the worst case of IEEE 802.11a; data rate @ MCS0 is the worst case of IEEE 802.11n(HT20); data rate @ MCS0 is the worst case of IEEE 802.11n(HT40); data rate @ MCS0 is the worst case of IEEE 802.11ac(VHT20); data rate @ MCS0 is the worst case of IEEE 802.11ac(VHT40); data rate @ MCS0 is the worst case of IEEE 802.11ac(VHT80), data rate @ MCS0 is the worst case of IEEE 802.11ax(HEW20); data rate @ MCS0 is the worst case of IEEE 802.11ax(HEW40); data rate @ MCS0 is the worst case of IEEE 802.11ax(HEW80), final test modes are considering the modulation and worse data rates. Only the data of worst case is recorded in the report.
Final test	06	TX mode (U-NII-2A)_Keep the EUT in continuously transmitting mode with all modulation types. All data rates for each modulation type have been tested and found the data rate @ 6Mbps is the worst case of IEEE 802.11a; data rate @ MCS0 is the worst case of IEEE 802.11n(HT20); data rate @ MCS0 is the worst case of IEEE 802.11n(HT40); data rate @ MCS0 is the worst case of IEEE 802.11ac(VHT20); data rate @ MCS0 is the worst case of IEEE 802.11ac(VHT40); data rate @ MCS0 is the worst case of IEEE 802.11ac(VHT80), data rate @ MCS0 is the worst case of IEEE 802.11ax(HEW20); data rate @ MCS0 is the worst case of IEEE 802.11ax(HEW40); data rate @ MCS0 is the worst case of IEEE 802.11ax(HEW80), final test modes are considering the modulation and worse data rates. Only the data of worst case is recorded in the report.
Final test	07	TX mode (U-NII-2C)_Keep the EUT in continuously transmitting mode with all modulation types.All data rates for each modulation type have been tested and found the data rate @ 6Mbps is the worst case of IEEE 802.11a; data rate @ MCS0 is the worst case of IEEE 802.11n(HT20); data rate @ MCS0 is the worst case of IEEE 802.11n(HT40); data rate @ MCS0 is the worst case of IEEE 802.11ac(VHT20); data rate @ MCS0 is the worst case of IEEE 802.11ac(VHT40); data rate @ MCS0 is the worst case of IEEE 802.11ac(VHT80) , data rate @ MCS0 is the worst case of IEEE 802.11ax(HEW20); data rate @ MCS0 is the worst case of IEEE 802.11ax(HEW40); data rate @ MCS0 is the worst case of IEEE 802.11ax(HEW80). Only the data of worst case is recorded in the report.



Unless otherwise agreed in writing, this document is issued by the Company subject to its General Conditions of Service printed overleaf, available on request or accessible at <https://www.sgs.com/en/Terms-and-Conditions>. Attention is drawn to the limitation of liability, indemnification and jurisdiction issues defined therein. Any holder of this document is advised that information contained hereon reflects the Company's findings at the time of its intervention only and within the limits of Client's instructions, if any. The Company's sole responsibility is to its Client and this document does not exonerate parties to a transaction from exercising all their rights and obligations under the transaction documents. This document cannot be reproduced except in full, without prior written approval of the Company. Any unauthorized alteration, forgery or falsification of the content or appearance of this document is unlawful and offenders may be prosecuted to the fullest extent of the law. Unless otherwise stated the results shown in this test report refer only to the sample(s) tested and such sample(s) are retained for 30 days only.
 Attention: To check the authenticity of testing /inspection report & certificate, please contact us at telephone: (86-755) 8307 1443, or email: CN.Doccheck@sgs.com
 No.1 Workshop, M-10, Middle Section, Science & Technology Park, Nanshan District, Shenzhen, Guangdong, China 518057 t (86-755) 26012053 f (86-755) 26710594 www.sgs.com.cn
 中国·广东·深圳市南山区科技园中区M-10栋1号厂房 邮编: 518057 t (86-755) 26012053 f (86-755) 26710594 sgs.china@sgs.com

Final test	08	TX mode (U-NII-3)_Keep the EUT in continuously transmitting mode with all modulation types. All data rates for each modulation type have been tested and found the data rate @ 6Mbps is the worst case of IEEE 802.11a; data rate @ MCS0 is the worst case of IEEE 802.11n(HT20); data rate @ MCS0 is the worst case of IEEE 802.11n(HT40); data rate @ MCS0 is the worst case of IEEE 802.11ac(VHT20); data rate @ MCS0 is the worst case of IEEE 802.11ac(VHT40); data rate @ MCS0 is the worst case of IEEE 802.11ac(VHT80); data rate @ MCS0 is the worst case of IEEE 802.11ax(HEW20); data rate @ MCS0 is the worst case of IEEE 802.11ax(HEW40); data rate @ MCS0 is the worst case of IEEE 802.11ax(HEW80), final test modes are considering the modulation and worse data rates. Only the data of worst case is recorded in the report.
------------	----	--------------------------------------------------------------------------------------------------------------------------------------------------------------------------------------------------------------------------------------------------------------------------------------------------------------------------------------------------------------------------------------------------------------------------------------------------------------------------------------------------------------------------------------------------------------------------------------------------------------------------------------------------------------------------------------------------------------------------------------------------------------------------------------------------------------------------------------------------

7.7.3 Test Setup Diagram

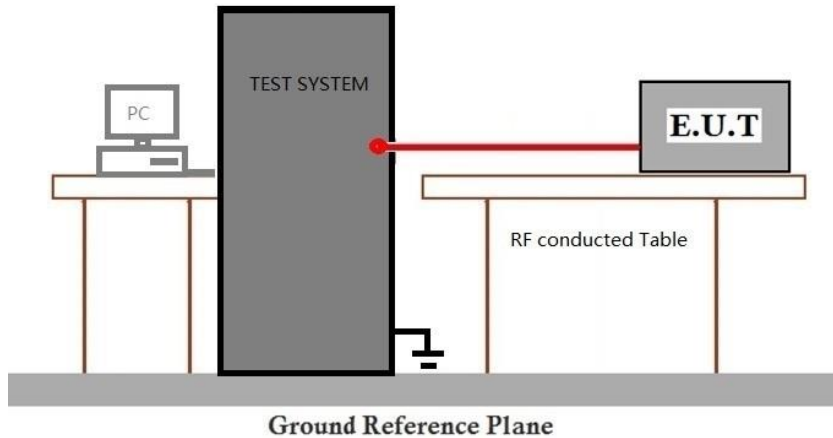

7.7.4 Measurement Procedure and Data

Please Refer to Appendix for Details



Unless otherwise agreed in writing, this document is issued by the Company subject to its General Conditions of Service printed overleaf, available on request or accessible at <https://www.sgs.com/en/Terms-and-Conditions>. Attention is drawn to the limitation of liability, indemnification and jurisdiction issues defined therein. Any holder of this document is advised that information contained hereon reflects the Company's findings at the time of its intervention only and within the limits of Client's instructions, if any. The Company's sole responsibility is to its Client and this document does not exonerate parties to a transaction from exercising all their rights and obligations under the transaction documents. This document cannot be reproduced except in full, without prior written approval of the Company. Any unauthorized alteration, forgery or falsification of the content or appearance of this document is unlawful and offenders may be prosecuted to the fullest extent of the law. Unless otherwise stated the results shown in this test report refer only to the sample(s) tested and such sample(s) are retained for 30 days only.

7.8 99% Bandwidth

Test Requirement N/A
 Test Method: KDB 789033 II D

7.8.1 E.U.T. Operation

Operating Environment:
 Temperature: 24.2 °C Humidity: 46.7 % RH Atmospheric Pressure: 1020 mbar

7.8.2 Test Mode Description

Pre-scan / Final test	Mode Code	Description
Final test	05	TX mode (U-NII-1)_Keep the EUT in continuously transmitting mode with all modulation types. All data rates for each modulation type have been tested and found the data rate @ 6Mbps is the worst case of IEEE 802.11a; data rate @ MCS0 is the worst case of IEEE 802.11n(HT20); data rate @ MCS0 is the worst case of IEEE 802.11n(HT40); data rate @ MCS0 is the worst case of IEEE 802.11ac(VHT20); data rate @ MCS0 is the worst case of IEEE 802.11ac(VHT40); data rate @ MCS0 is the worst case of IEEE 802.11ac(VHT80), data rate @ MCS0 is the worst case of IEEE 802.11ax(HEW20); data rate @ MCS0 is the worst case of IEEE 802.11ax(HEW40); data rate @ MCS0 is the worst case of IEEE 802.11ax(HEW80), final test modes are considering the modulation and worse data rates. Only the data of worst case is recorded in the report.
Final test	06	TX mode (U-NII-2A)_Keep the EUT in continuously transmitting mode with all modulation types. All data rates for each modulation type have been tested and found the data rate @ 6Mbps is the worst case of IEEE 802.11a; data rate @ MCS0 is the worst case of IEEE 802.11n(HT20); data rate @ MCS0 is the worst case of IEEE 802.11n(HT40); data rate @ MCS0 is the worst case of IEEE 802.11ac(VHT20); data rate @ MCS0 is the worst case of IEEE 802.11ac(VHT40); data rate @ MCS0 is the worst case of IEEE 802.11ac(VHT80), data rate @ MCS0 is the worst case of IEEE 802.11ax(HEW20); data rate @ MCS0 is the worst case of IEEE 802.11ax(HEW40); data rate @ MCS0 is the worst case of IEEE 802.11ax(HEW80), final test modes are considering the modulation and worse data rates. Only the data of worst case is recorded in the report.
Final test	07	TX mode (U-NII-2C)_Keep the EUT in continuously transmitting mode with all modulation types. All data rates for each modulation type have been tested and found the data rate @ 6Mbps is the worst case of IEEE 802.11a; data rate @ MCS0 is the worst case of IEEE 802.11n(HT20); data rate @ MCS0 is the worst case of IEEE 802.11n(HT40); data rate @ MCS0 is the worst case of IEEE 802.11ac(VHT20); data rate @ MCS0 is the worst case of IEEE 802.11ac(VHT40); data rate @ MCS0 is the worst case of IEEE 802.11ac(VHT80) , data rate @ MCS0 is the worst case of IEEE 802.11ax(HEW20); data rate @ MCS0 is the worst case of IEEE 802.11ax(HEW40); data rate @ MCS0 is the worst case of IEEE 802.11ax(HEW80). Only the data of worst case is recorded in the report.



Unless otherwise agreed in writing, this document is issued by the Company subject to its General Conditions of Service printed overleaf, available on request or accessible at <https://www.sgs.com/en/Terms-and-Conditions>. Attention is drawn to the limitation of liability, indemnification and jurisdiction issues defined therein. Any holder of this document is advised that information contained hereon reflects the Company's findings at the time of its intervention only and within the limits of Client's instructions, if any. The Company's sole responsibility is to its Client and this document does not exonerate parties to a transaction from exercising all their rights and obligations under the transaction documents. This document cannot be reproduced except in full, without prior written approval of the Company. Any unauthorized alteration, forgery or falsification of the content or appearance of this document is unlawful and offenders may be prosecuted to the fullest extent of the law. Unless otherwise stated the results shown in this test report refer only to the sample(s) tested and such sample(s) are retained for 30 days only.
 Attention: To check the authenticity of testing /inspection report & certificate, please contact us at telephone: (86-755) 8307 1443, or email: CN.Doccheck@sgs.com
 No.1 Workshop, M-10, Middle Section, Science & Technology Park, Nanshan District, Shenzhen, Guangdong, China 518057 t (86-755) 26012053 f (86-755) 26710594 www.sgs.com.cn
 中国·广东·深圳市南山区科技园中区M-10栋1号厂房 邮编: 518057 t (86-755) 26012053 f (86-755) 26710594 sgs.china@sgs.com