

RF Exposure

1. RF Exposure evaluation for the applying transmitter

As shown in the following photo, both main and auxiliary WLAN antennas of the applying laptop PC, IBM ThinkPad R40 Series, are located at the top of display (LCD) bezel. The separation distances between the antennas and the human body are 20cm or more. Therefore the laptop PC can be categorized as a mobile device by FCC CFR 47 Section 2.1091.

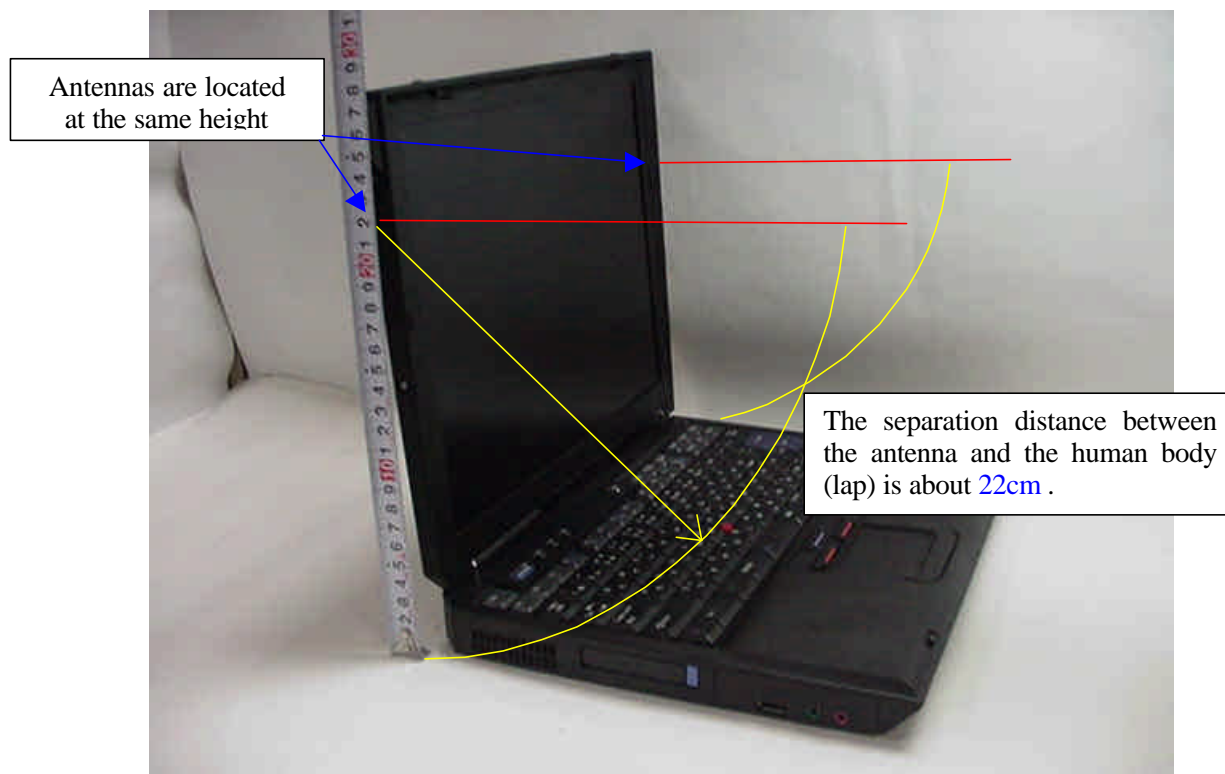

The highest conducted peak output power of the Test Report is 53.7mW (17.3dBm) and the maximum antenna gain is 0.85 dBi (See page 4 of this exhibit.).

Therefore the peak radiated output power(EIRP) is calculated as follows.

$$EIRP = P + G = 17.3 \text{ dBm} + 0.85 \text{ dBi} = 18.15 \text{ dBm} (65.3 \text{ mW})$$

Then, the maximum power density at 20cm distance is calculated as :

$$S = EIRP / (4 \times R^2 \times \pi) = 0.0130 \text{ mW/cm}^2$$

Since the applying laptop PC's WLAN transmitter does not function to emit the radio frequency from both diversity antennas simultaneously, the above value is the maximum RF exposure to the persons and is below the MPE limit (1.0 mW/ cm²). Therefore the laptop PC meets the MPE requirements for general Population/Uncontrolled exposure.

2. RF Exposure evaluation for Bluetooth transmitters

The applying laptop PC (ThinkPad R40 Series) supports three kinds of Bluetooth devices as follows.

	FCC ID	Grantee Name	Product Name	Granted Date	ERP in FCC test report
User's option	PI4BT-ULTRA	TDK Systems Europe Ltd.	Bluetooth Ultraport Module	May/22/2001	1.4 mW
	PI4BT-IBM-PCII		Bluetooth PC Card II	August/21/2001	1.0mW
Built-intype LMA transmitter	ANO20020100MTN	IBM Japan, Ltd.	IBM integrated Bluetooth with 56K Modem	Under being inspected with this application	2.5mW

Interfaces to connect Wireless options

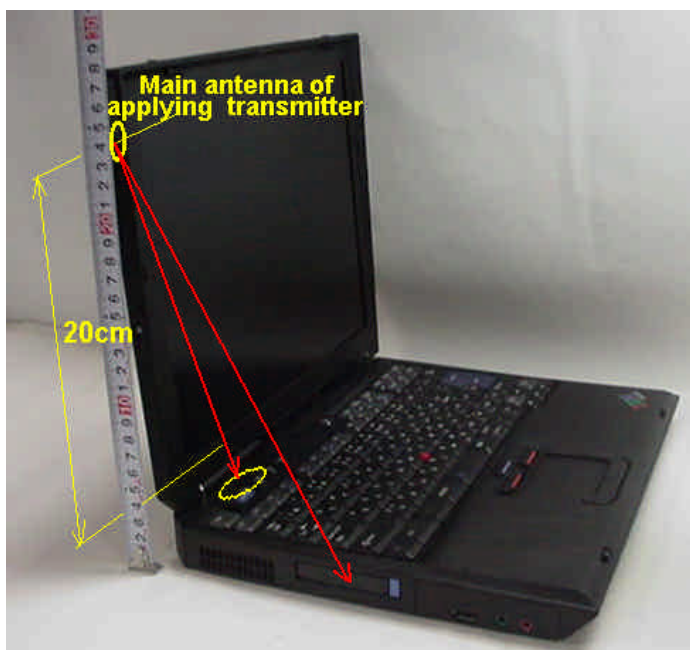

The main and auxiliary antennas of the applying transmitter in the LCD section are assembled apart from each Bluetooth antenna shown in the previous page with 20 cm or more distance.

Therefore the RF exposure evaluation for those Bluetooth transmitters is able to be done independently of the applying antennas. In other word, a collocated SAR testing is not required.

When a customer operates the applying PC on one's lap, the sufficient separation distance (minimum 20cm) between the above Bluetooth antennas and the person's body (lap) can not be maintained.

But the footnote of the Section 3 in Supplement C to OET Bulletin 65 states "¹⁴ If a device, its antenna or other radiating structures are operating at closer than 2.5 cm from a person's body or in contact with the body, SAR evaluation may be necessary when the output is more than 50 – 100 mW, depending on the device operating configurations and exposure conditions."

The total output power of the three Bluetooth transmitters in the previous table does not exceed 5mW. Therefore these transmitters also satisfy the RF exposure evaluation regarding CFR 47 Part 15.247(b)(4) without a SAR compliance test report, and can operate with the applying transmitter simultaneously.

IBM Web site guides to customers about the **grant condition** related to those collaborating transmitter devices. See page 9 of this exhibit.

3. Antenna Gains of applying equipment

3.1 Antenna Specification

Transmission Antenna assembly overview

Designator	Manufacture	Antenna type	Cable type and length	Gain (dBi) Note 1)
3301BZ9078A 15 inch LCD model Main antenna	Hitachi Cable Ltd. (Japan)	Dual Band Inverted F type Antenna	coax 530mm	2400-2500MHz 0.46 dBi (peak)
				5725-5850MHz -0.49 dBi (peak)
3301BZ9079A 15 inch LCD model Auxiliary antenna	Hitachi Cable Ltd. (Japan)	Dual Band Inverted F type Antenna	coax 640mm	2400-2500MHz -1.06 dBi (peak)
				5725-5850MHz -0.12 dBi (peak)
3301BZ9076A 13/14 inch LCD model Main antenna	Hitachi Cable Ltd. (Japan)	Dual Band Inverted F type Antenna	coax 530mm	2400-2500MHz -0.37 dBi (peak)
				5725-5850MHz 0.85 dBi (peak)
3301BZ9077A 13/14 inch LCD model Auxiliary antenna	Hitachi Cable Ltd. (Japan)	Dual Band Inverted F type Antenna	coax 640mm	2400-2500MHz 0.83 dBi (peak)
				5725-5850MHz -0.94 dBi (peak)

Notes:

- 1a. Includes all cable losses.
- 1b. Antenna type should be Omni Directional and have gain of 3.0 dBi or less for IEEE802.11a(5GHz band) and have gain of 2.0 dBi or less for IEEE802.11b(2.4GHz band), regarding the IBM internal specification.

3.2 Radiation characteristic of antennas

3.2.1 2400-2500MHz radiation characteristic of antenna for LCD 15 inch model

Main antenna

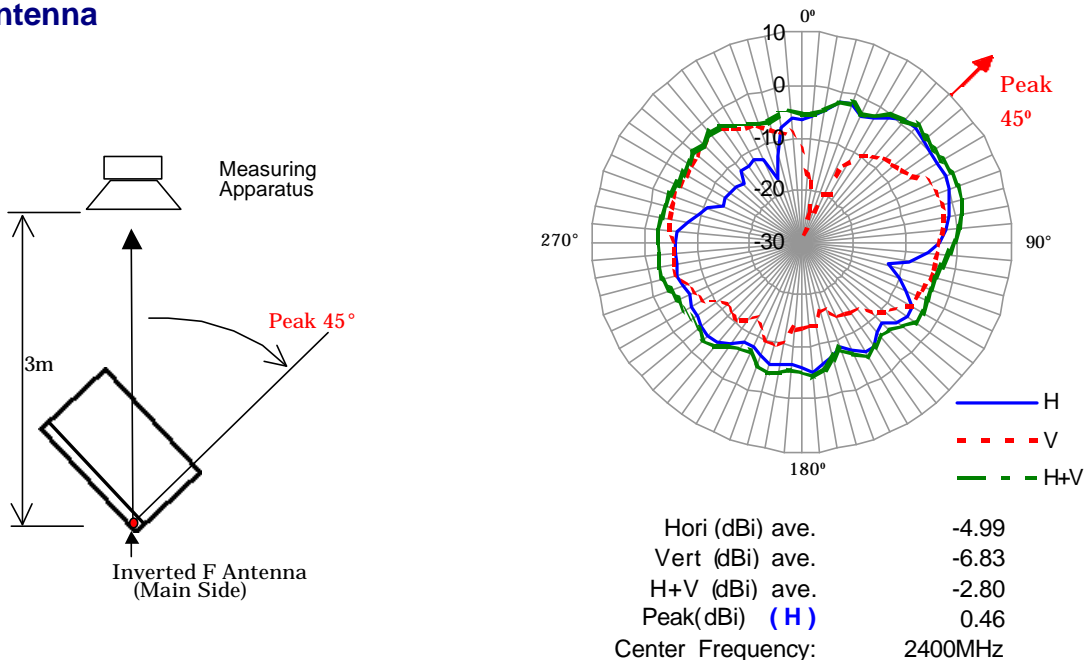

Note1) The measurement was performed at 3 frequencies (2400, 2450, 2500MHz).

Note2) The maximum antenna gain was found around **45 degree** angle from measuring apparatus in **horizontal** polarization at the middle frequency (2400MHz).

Auxiliary antenna

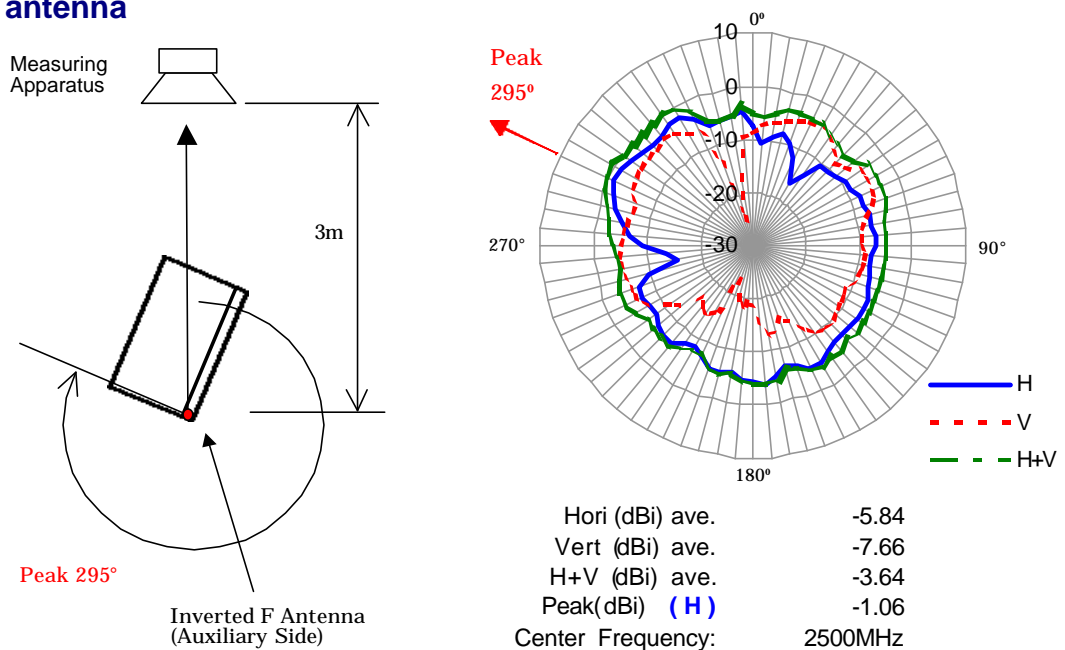

Note1) The measurement was performed at 3 frequencies (2400, 2450, 2500MHz).

Note2) The maximum antenna gain was found around **295 degree** angle from measuring apparatus in **horizontal** polarization at the middle frequency (2500MHz).

3.2.2 2400-2500MHz radiation characteristic of antenna for LCD 13/14 inch model

Main antenna

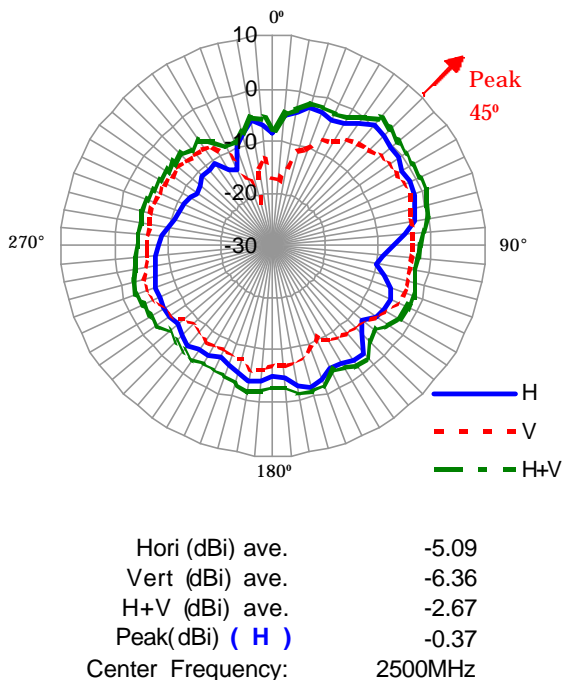
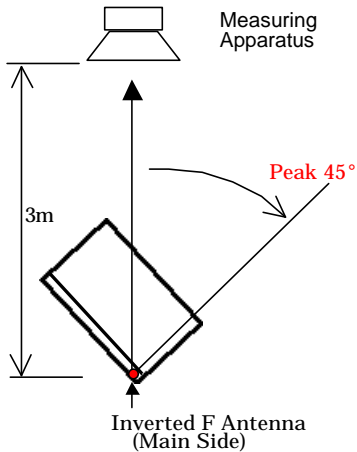

Note1) The measurement was performed at 3 frequencies (2400, 2450, 2500MHz).
 Note2) The maximum antenna gain was found around **45 degree** angle from measuring apparatus in **horizontal** polarization at the middle frequency (2500MHz).

Auxiliary antenna

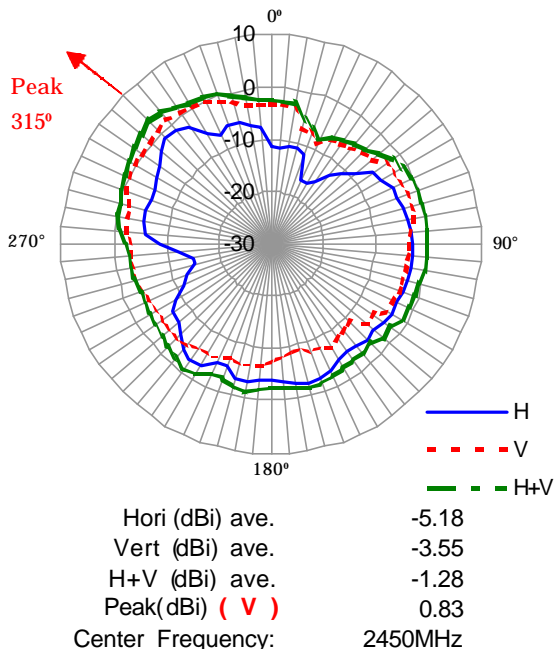
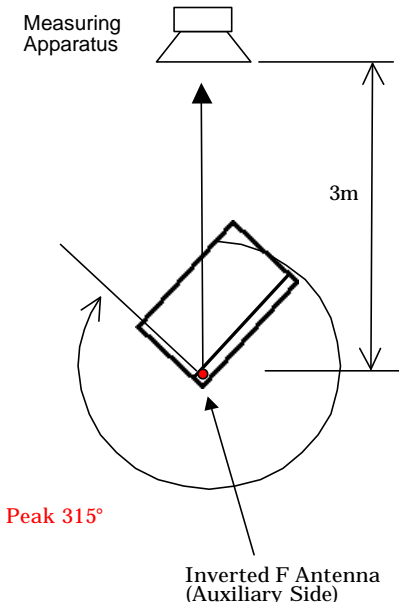

Note1) The measurement was performed at 3 frequencies (2400, 2450, 2500MHz).
 Note2) The maximum antenna gain was found around **315 degree** angle from measuring apparatus in **vertical** polarization at the middle frequency (2450MHz).

3.2.3 5725-5850MHz radiation characteristic of antenna for LCD 15 inch model

Main antenna

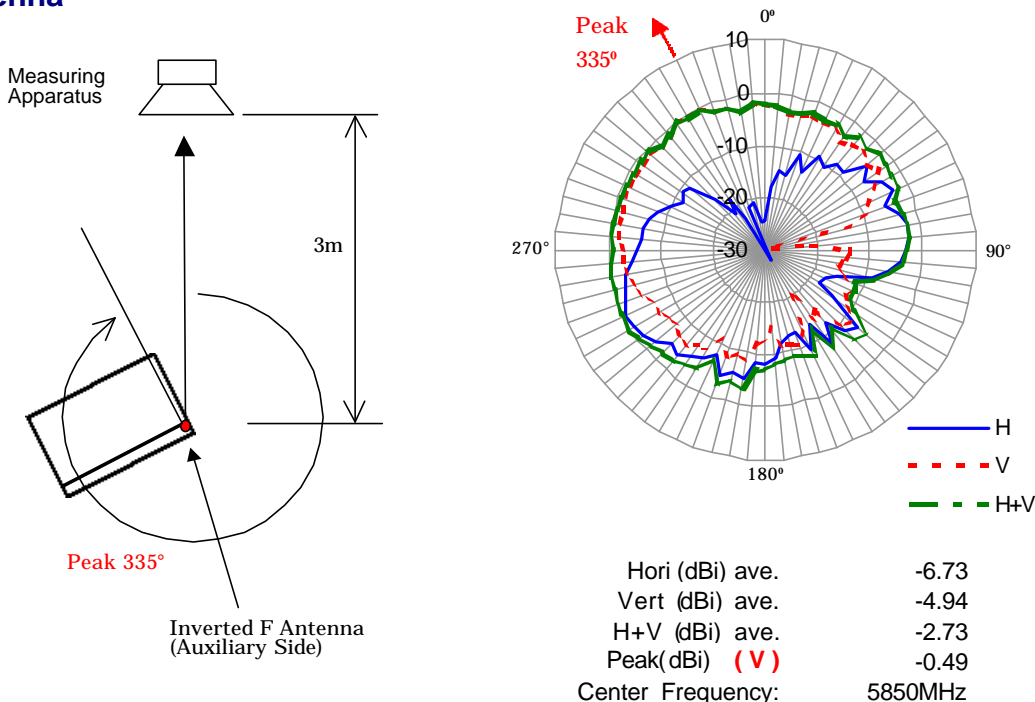

Note1) The measurement was performed at 4 frequencies (5725, 5750, 5800, 5850MHz).
 Note2) The maximum antenna gain was found around **335 degree** angle from measuring apparatus in **vertical** polarization at the middle frequency (5850MHz).

Auxiliary antenna

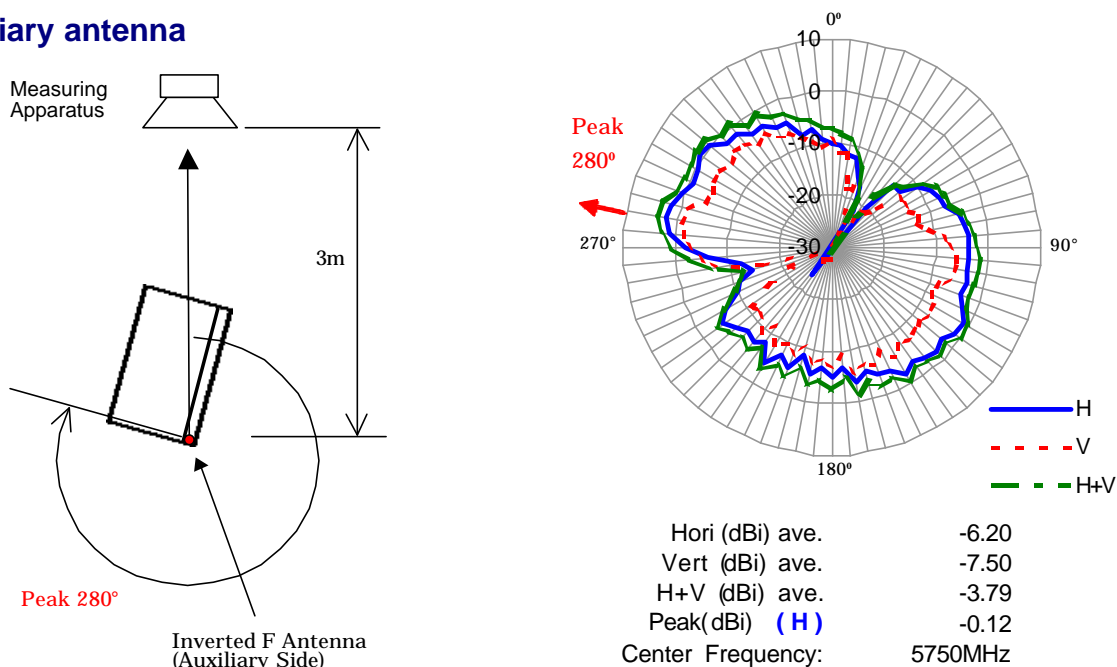

Note1) The measurement was performed at 4 frequencies (5725, 5750, 5800, 5850MHz).
 Note2) The maximum antenna gain was found around **280 degree** angle from measuring apparatus in **horizontal** polarization at the middle frequency (5750MHz).

3.2.4 5725-5850MHz radiation characteristic of antenna for LCD 13/14 inch model

Main antenna

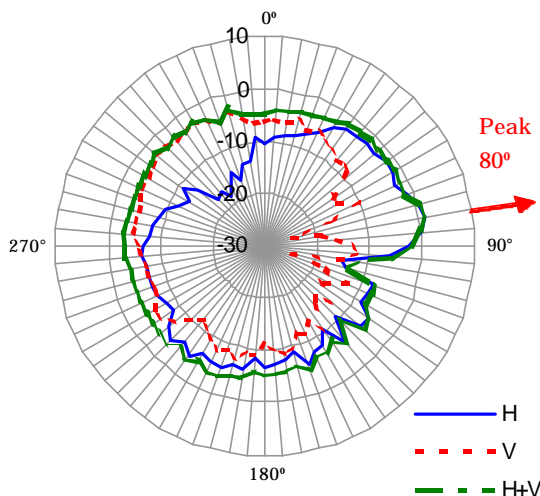
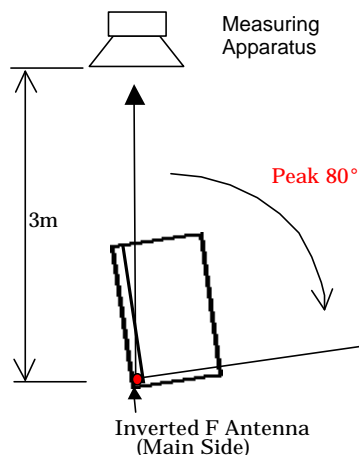

Hori (dBi) ave.	-6.02
Vert (dBi) ave.	-7.50
H+V (dBi) ave.	-3.69
Peak(dBi) (H)	0.85
Center Frequency:	5725MHz

Note1) The measurement was performed at 4 frequencies (5725, 5750, 5800, 5850MHz).
 Note2) The maximum antenna gain was found around **80 degree** angle from measuring apparatus in **horizontal** polarization at the middle frequency (5725MHz).

Auxiliary antenna

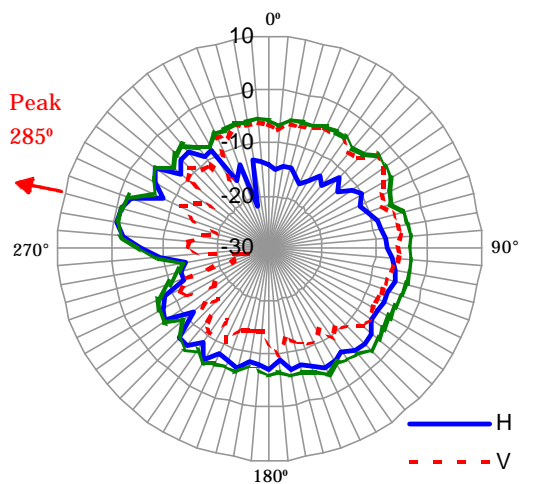
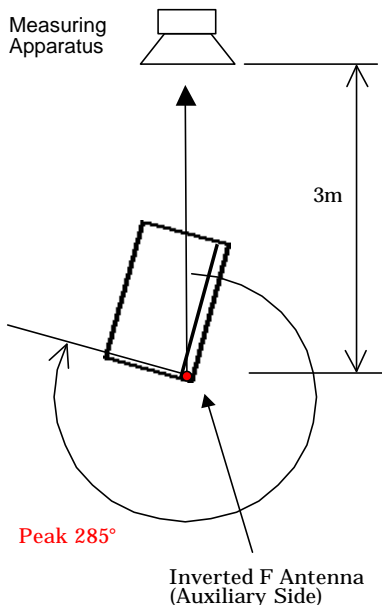

Hori (dBi) ave.	-7.29
Vert (dBi) ave.	-8.39
H+V (dBi) ave.	-4.79
Peak(dBi) (H)	-0.94
Center Frequency:	5725MHz

Note1) The measurement was performed at 4 frequencies (5725, 5750, 5800, 5850MHz).
 Note2) The maximum antenna gain was found around **285 degree** angle from measuring apparatus in **horizontal** polarization at the middle frequency (5725MHz).

4. IBM Web site for user’s guidance concerning the co-located transmitters

Note) The URL is not available until the product announcement.

<http://www.pc.ibm.com/qtechinfo/MIGR-44156.html> (Entrance Page)

The screenshot shows the IBM website interface. At the top, there is a search bar and a navigation menu with links for Home, Products & services, Support & downloads, and My account. Below the navigation, there are buttons for 'Select a language', 'PC support home', 'Login', 'Profile', 'My page', 'Ask an expert', and 'Help'. The main content area is titled 'TP Wireless Systems - Additional RF Option devices receive FCC certification'. It includes sections for 'Applicable countries/regions' (United States), 'Service hints & tips', and 'Affected configurations'. A table lists system units and their FCC IDs, with a sub-table for PC options allowed multiple transmission. The 'Solution' section provides instructions for using Bluetooth options and lists three specific configurations.

System Unit approved products	FCC IDs	PC options allowed multiple transmission		
		#1	#2	#3
ThinkPad R40 Series wireless models	ANO20020300D3L	<input type="radio"/>	<input type="radio"/>	<input type="radio"/>
	Wireless upgradeable model			

Solution
 The supplementary document of ThinkPad’s “Service and Troubleshooting Guide” has the following information in “Wireless regulatory information – USA Federal Communications Commission (FCC)” section:

Please make sure of the following when you use a Bluetooth option or wireless option PC Card in your ThinkPad computer:

1. Visit the IBM site at www.ibm.com/pc/qtechinfo/MIGR-44156.html and confirm the updated list of RF option devices that have been approved to cooperate with the integrated wireless feature.
2. When you use any other RF option device that is not listed on the IBM site, all other wireless features including the integrated transmitter in your ThinkPad computer are required to be turned off.
3. Users are requested to follow the RF Safety instructions on wireless option devices that are included in the RF option device’s user’s manual.

Document id: MIGR-44156
 Last modified: 2002-06-03
 Copyright (C) 2002 IBM Corporation