

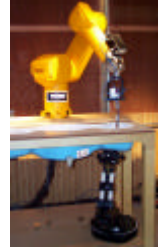

# PCTEST Engineering Laboratory, Inc.

6660-B Dobbin Road • Columbia, MD 21045 • U.S.A.  
TEL (410) 290-6652 • FAX (410) 290-6654  
<http://www.pctestlab.com>



## CERTIFICATE OF COMPLIANCE FCC Part 22 Certification

### UNIDEN ENGINEERING SERVICES

216 John Street

P.O. Box 580

Lake City, SC 29560-0580

Attn: Mr. Jim Haynes, Vice President ~  
Engineering & Regulatory Affairs

Dates of Tests: February 05-07, 2001

Test Report S/N: 22.210202059.AMW

Test Site: PCTEST Lab, Columbia MD

FCC ID

**AMWUH052A**

APPLICANT

**UNIDEN ENGINEERING SERVICES**

Classification:	Non-Broadcast Transmitter Held to Ear (TNE)
FCC Rule Part(s):	§22(H), §2
EUT Type:	Single-Band Analog Panic Phone (AMPS)
Model(s):	ASC911A
Tx Frequency Range:	824.04MHz – 848.97MHz (AMPS)
Rx Frequency Range:	869.04MHz – 893.97MHz (AMPS)
Max. RF Output Power:	0.421W ERP AMPS (26.246 dBm)
Max. SAR Measurement:	1.100 mW/g (1g) AMPS Head SAR; 1.420 mW/g (1g) AMPS Body SAR; 0.773 mW/g (10g) AMPS Hand SAR
Emission Designator(s):	40K0F8W, 40K0F1D

This equipment has been shown to be capable of compliance with the applicable technical standards as indicated in the measurement report and was tested in accordance with the measurement procedures specified in §2.947. (See Test Report)

I attest to the accuracy of data. All measurements reported herein were performed by me or were made under my supervision and are correct to the best of my knowledge and belief. I assume full responsibility for the completeness of these measurements and vouch for the qualifications of all persons taking them.

*PCTEST certifies that no party to this application has been denied the FCC benefits pursuant to Section 5301 of the Anti-Drug Abuse Act of 1988, 21 U.S.C. 862.*

  
Randy Ortanez  
President & Chief Engineer



2 1 0 2 0 2 0 5 9 . A M W

**NVLAP**<sup>®</sup>  
LAB CODE 100431-0

# MEASUREMENT REPORT

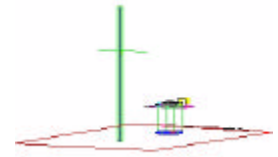
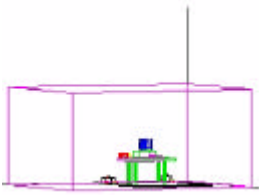

## 1.1 Scope

*Measurement and determination of electromagnetic emissions (EME) of radio frequency devices including intentional and/or unintentional radiators for compliance with the technical rules and regulations of the Federal Communications Commission.*

## §2983(a) General Information

<b>Applicant Name:</b>	<b>UNIDEN ENGINEERING SERVICES</b>
<b>Address:</b>	<b>216 John Street P.O. Box 580 Lake City, SC 29560-0580</b>
<b>Attention:</b>	<b>Mr. Jim Haynes, Vice President ~ Engineering &amp; Regulatory Affairs</b>

- FCC ID: **AMWUH052A**
- Model(s): **ASC911A**
- Quantity: Quantity production is planned
- Emission Designator: 40K0F8W, 40K0F1D
- Tx Freq. Range: 824.04 – 848.97 MHz (AMPS)
- Rx Freq. Range: 869.04 – 893.97 MHz (AMPS)
- Max. RF Power Rating: 0.421 W ERP AMPS (26.246 dBm)
- Battery Pack: 6.0 VDC (x4 AAA Battery Pack)
- FCC Classification(s): Non-Broadcast Transmitter Held to Ear (TNE)
- Equipment (EUT) Type: Single-Band Analog Panic Phone (AMPS)
- Frequency Tolerance:  $\pm 0.00025\%$  (2.5 ppm)
- FCC Rule Part(s): §22(H), §2
- Dates of Tests: February 05-07, 2001
- Place of Tests: PCTEST Lab, Columbia, MD U.S.A.
- Test Report S/N: 22.210202059.AMW



## 2.1 INTRODUCTION

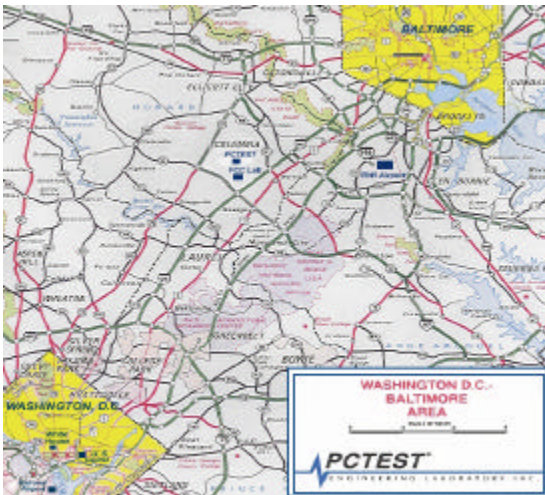

Figure 1. Map of the Greater Baltimore and Metropolitan Washington, D.C. area.

These measurement tests were conducted at **PCTEST Engineering Laboratory, Inc.** facility in New Concept Business Park, Guilford Industrial Park, Columbia, Maryland. The site address is 6660-B Dobbin Road, Columbia, MD 21045. The test site is one of the highest points in the Columbia area with an elevation of 390 feet above mean sea level. The site coordinates are 39° 11'15" N latitude and 76° 49'38" W longitude. The facility is 1.5 miles North of the FCC laboratory, and the ambient signal and ambient signal strength are approximately equal to those of the FCC laboratory. There are no FM or TV transmitters within 15 miles of the site. The detailed description of the measurement facility was found to be in compliance with the requirements of § 2.948 according to ANSI C63.4 on October 19, 1992.

### Measurement Procedure

The radiated and spurious measurements were made outdoors at 3-meter test range (see Figure 2). The equipment under test is placed on the turntable connected to a RF wattmeter and a dummy RF load, and then its power is adjusted to its rated output. A receiving antenna located 2 meters from the turntable picks up any signal radiated from the transmitter. The turntable containing the system was rotated; the receiving antenna height was varied 1 to 4 meters and stopped at the azimuth or height producing the maximum emission. The testing procedure is repeated for both horizontal and vertical polarization of the receiving antenna. The actual radiated signal strength is obtained by substitution method with a signal generator with a calibrated output. The signal generator is adjusted in output until its reading is identical to that obtained when the receiving antenna is connected to the receiver. Signal strength is then read directly from the signal generator.

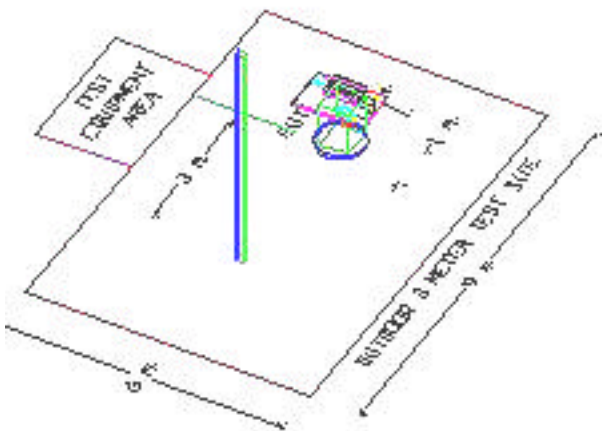

Figure 2. 3-meter Outdoor Test Site

## 3.1 DESCRIPTION OF TESTS

### 3.2 §2.1047(a) Transmitter Audio Frequency Response

The frequency response of the audio modulating circuit over the frequency range 100 – 5000 Hz is measured. The audio signal generator is connected to the audio input circuit/microphone of the EUT. The audio signal input is adjusted to obtain 50% modulation at 1kHz and this point is taken as the 0dB reference. With the input held constant and below the limit at all frequencies, the audio signal generator is varied from 100 to 50 kHz.

### 3.3 §22.915(d) Audio Low Pass Filter Frequency Response

The response in dB relative to 1kHz is measured using the HP8901 a Modulation Analyzer. For the frequency response of the audio low-pass filter, the audio input is connected at the input to the modulation limiter and the modulated stage. The audio output is connected at the output of the modulated stage. The corresponding plots are shown herein.

### 3.4 §2.1047(b) & §22.915(b) Modulation Limiting

The audio signal generator is connected to the audio input circuit/microphone of the EUT. The modulation response is measured for each of the three modulating frequencies (300Hz, 1000 Hz, and 3000Hz), and the input voltage is varied from 30% modulation ( $\pm 3.6$ kHz deviation) to at least 20dB higher than the saturation point. Measurements of modulation and the plots are attached herein. Measurements were performed for ST, SAT, and wide-band data modulations. The corresponding results are shown herein.

Note: ST, SAT, & Wide-Band data were internally generated by the EUT.

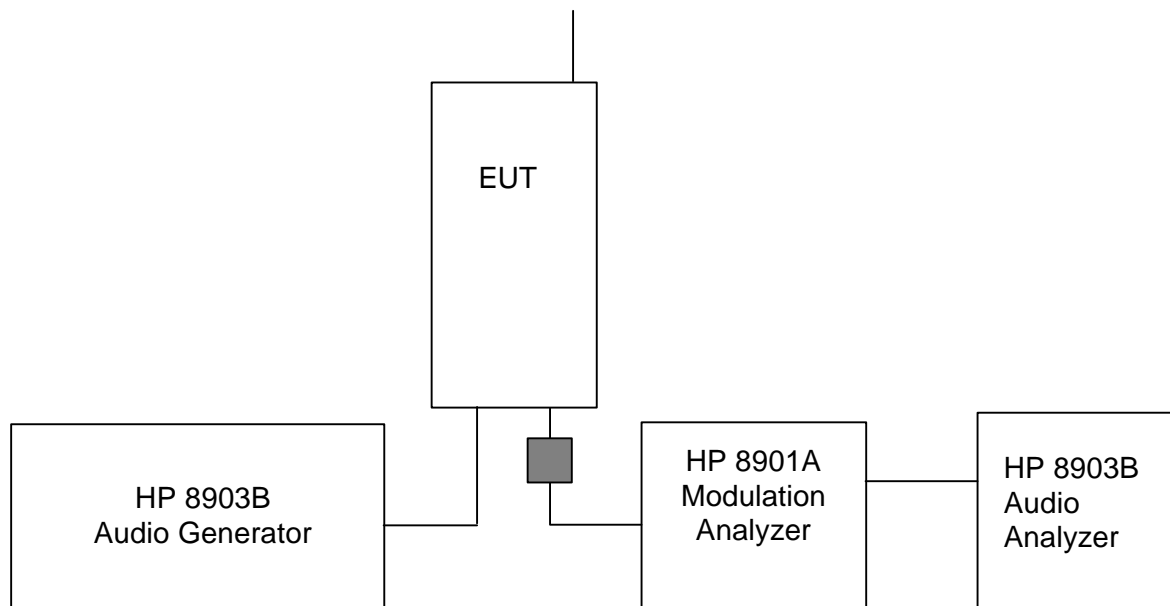

Fig. 3. Transmitter Audio Frequency & Tone Modulation Test Setup.

### **3.5 §2.1053 Radiation Spurious and Harmonic Emissions**

Radiation and harmonic emissions above 1 GHz is measured at out 3-meter indoor site. The EUT is placed on the turntable connected to a dummy load in normal operation using the intended power source. A receiving antenna located 3 meters from the turntable receives any signal radiated from the transmitter and its operating accessories. The antenna is varied from 1 to 4 meters and the polarization is varied (horizontal and vertical) to determine the worst-case emission level. To obtain actual radiated signal strength, a signal generator is adjusted in output until a reading identical to that obtained with the actual transmitter is obtained at the receiver. Signal strength is read directly from the generator and recorded on the attached table.3.8 §24.135 Frequency Stability/Temperature Variation

The frequency stability of the transmitter is measured by:

- a.) **Temperature:** The temperature is varied from -30°C to +60°C using an environmental chamber.
- b.) **Primary Supply Voltage:** The primary supply voltage is varied from 85% to 115% of the voltage normally at the input to the device or at the power supply terminals if cables are not normally supplied.

*Specification – The frequency stability shall be sufficient to ensure that the fundamental emission stays within the authorized frequency block. The frequency stability of the transmitter shall be maintained within - 0.0001 (- 1 ppm) of the center frequency.*

#### **Time Period and Procedure:**

1. The carrier frequency of the transmitter and the individual oscillators is measured at room temperature (25°C to 27°C to provide a reference).
2. The equipment is subjected to an overnight “soak” at -30°C without any power applied.
3. After the overnight “soak” at 30°C (usually 14-16 hours), the equipment is turned on in a “standby” condition for one minute before applying power to the transmitter. Measurement of the carrier frequency of the transmitter and the individual oscillators is made within a three minute interval after applying power to the transmitter.
4. Frequency measurements are made at 10°C interval up to room temperature. At least a period of one and one half-hour is provided to allow stabilization of the equipment at each temperature level.
5. Again the transmitter carrier frequency and the individual oscillators is measured at room temperature to begin measurement of the upper temperature levels.
6. Frequency measurements were made at 10 intervals starting at 30°C up to +50°C allowing at least two hours at each temperature for stabilization. In all measurements the frequency is measured within three minutes after applying power to the transmitter.
7. The artificial load is mounted external to the temperature chamber.

**NOTE: The EUT is tested down to the battery endpoint.**

## 4.1 Test Data

---

### 4.2 Effective Radiated Power Output

A. POWER: **Low (Analog Mode)**

Freq. Tuned (MHz)	LEVEL (dBm)	POL (H/V)	ERP (W)	ERP (dBm)
824.10	-34.120	V	0.00521	7.15
836.52	-34.283	V	0.00520	7.15
848.91	-34.443	V	0.00519	7.14

A. POWER: **High (Analog Mode)**

Freq. Tuned (MHz)	LEVEL (dBm)	POL (H/V)	ERP (W)	ERP (dBm)	BATTERY
824.10	-15.119	V	0.41257	26.155	Standard
836.52	-15.183	V	0.42133	26.246	Standard
848.91	-15.414	V	0.41401	26.170	Standard

**NOTES:**

ERP Measurements by Substitution Method:

The EUT was placed on a wooden turn table 3-meters from the receive antenna. The receive antenna height and turntable rotation was adjusted for the highest reading on the receive spectrum analyzer. A half-wave dipole was substituted in place of the EUT. This dipole antenna was driven by a signal generator and the level of the signal generator was adjusted to obtain the same receive spectrum analyzer reading. This ERP level is recorded. For readings above 1GHz, the above procedure is repeated using horn antennas and the difference between the gain of the horn and an isotropic antenna are taken into consideration.

## 5.1 Test Data (Continued)

### 5.2 § 2.995 FREQUENCY STABILITY (AMPS)

OPERATING FREQUENCY: 836,520,009 Hz  
 CHANNEL: 0384  
 REFERENCE VOLTAGE: 6.0 VDC  
 DEVIATION LIMIT: ± 0.00025 % or 2.5 ppm

VOLTAGE (%)	POWER (VDC)	TEMP (°C)	FREQ. (Hz)	Deviation (%)
100 %	6.00	+ 20 (Ref)	836,520,009	0.000000
100 %		- 30	836,520,419	-0.000049
100 %		- 20	836,520,444	-0.000052
100 %		- 10	836,520,352	-0.000041
100 %		0	836,520,260	-0.000030
100 %		+ 10	836,520,151	-0.000017
100 %		+ 20	836,520,009	0.000000
100 %		+ 25	836,519,875	0.000016
100 %		+ 30	836,519,817	0.000023
100 %		+ 40	836,519,750	0.000031
100 %		+ 50	836,519,708	0.000036
100 %		+ 60	836,519,725	0.000034
85 %		5.10	+ 20	836,520,009
115 %	6.90	+ 20	836,520,009	0.000000
BATT. ENDPOINT	4.50	+ 20	836,520,009	0.000000

## 5.1 Test Data (Continued)

### 5.3 § 2.995 FREQUENCY STABILITY (AMPS)

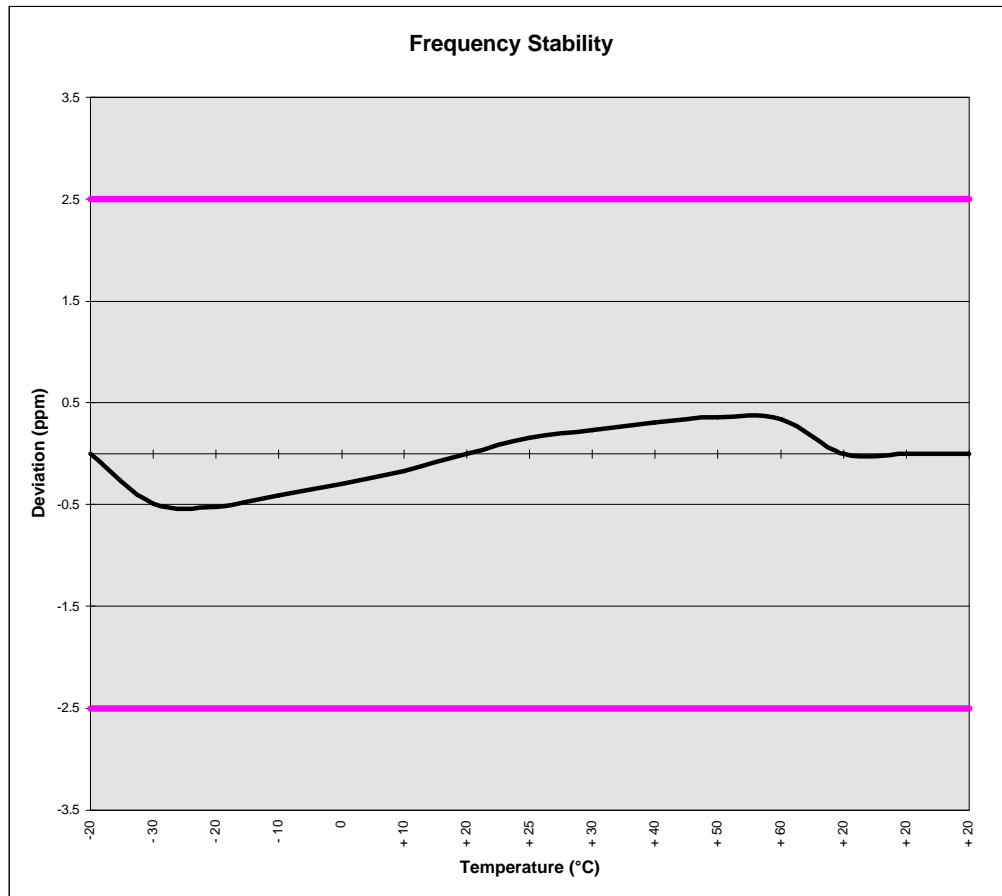



## 6.1 Test Data (Continued)

### 6.2 Radiated Measurements

#### § 2.993 Field Strength of SPURIOUS Radiation (Analog)

OPERATING FREQUENCY: 824.10 MHz  
 CHANNEL: 0993 (Low)  
 MEASURED OUTPUT POWER: 26.246 dBm = 0.422 W  
 MODULATION SIGNAL: ST (Signalling Tone)  
 DISTANCE: 3 meters  
 LIMIT:  $43 + 10 \log_{10} (W) =$  39.26 dBc

FREQ. (MHz)	LEVEL (dBm)	AFCL (dB)	POL (H/V)	F/S ( $\mu$ V/m)	ERP (dBm)	(dBc)
1648.20	-81.210	34.4	V	1022.12	-37.187	63.43
2472.30	-86.459	39.6	V	1016.37	-37.236	63.48
3296.40	-89.899	42.5	V	955.10	-37.776	64.02
4120.50	-110.218	46.1	V	139.35	-54.495	80.74
4944.60	< -130					
5768.70	< -130					

#### NOTES:

- The bandwidth is set per §22.917 (RBW = 1MHz, VBW = 1MHz).
- The spectrum was checked from 25 MHz up to the 10th harmonic.
- All emissions not listed were found to be more than 20dB below the limit.
- < -130dBm is below the floor of the spectrum analyzer.
- The EUT is manipulated through 3 orthogonal axis and the worst-case are reported.
- The EUT is placed 3m. away from the receiving antenna and the ERP is calculated using the formula:

$$\text{ERP (dBm)} = 10 \text{ Log}_{10} \left( \frac{((r(\text{mV/m})/1 \times 10^6)^2 / 49.2/1 \times 10^{-3})}{1} \right)$$

$$\text{ERP (dBm)} = 10 \text{ Log}_{10} \left[ \frac{(3 \times \text{FS}/1 \times 10^6)^2}{(49.2) \times 1000} \right]$$

$$\text{ERP (Watts)} = \frac{(3 \times \text{FS})^2}{49.2}$$

## 6.1 Test Data (Continued)

### 6.3 Radiated Measurements

#### § 2.993 Field Strength of SPURIOUS Radiation (Analog)

OPERATING FREQUENCY: 836.52 MHz  
 CHANNEL: 0384 (Middle)  
 MEASURED OUTPUT POWER: 26.246 dBm = 0.422 W  
 MODULATION SIGNAL: ST (Signalling Tone)  
 DISTANCE: 3 meters  
 LIMIT:  $43 + 10 \log_{10}(W) =$  39.26 dBc

FREQ. (MHz)	LEVEL (dBm)	AFCL (dB)	POL (H/V)	F/S ( $\mu$ V/m)	ERP (dBm)	(dBc)
1673.04	-81.203	34.7	V	1058.89	-36.880	63.13
2509.56	-86.193	39.0	V	978.03	-37.570	63.82
3346.08	-88.925	42.7	V	1093.33	-36.602	62.85
4182.60	-109.219	46.1	V	156.33	-53.496	79.74
5019.12	< -130					
5855.64	< -130					

#### NOTES:

- The bandwidth is set per §22.917 (RBW = 1MHz, VBW = 1MHz).
- The spectrum was checked from 25 MHz up to the 10th harmonic.
- All emissions not listed were found to be more than 20dB below the limit.
- < -130dBm is below the floor of the spectrum analyzer.
- The EUT is manipulated through 3 orthogonal axis and the worst-case are reported.
- The EUT is placed 3m. away from the receiving antenna and the ERP is calculated using the formula:  

$$\text{ERP (dBm)} = 10 \text{ Log}_{10} \left( \frac{(r(\text{mV/m})/1 \times 10^6)^2}{49.2/1 \times 10^{-3}} \right)$$

$$\text{ERP (dBm)} = 10 \text{ Log}_{10} \left[ \frac{(3 \times \text{FS}/1 \times 10^6)^2}{(49.2) \times 1000} \right]$$

$$\text{ERP (Watts)} = \frac{(3 \times \text{FS})^2}{49.2}$$

## 6.1 Test Data (Continued)

### 6.4 Radiated Measurements

#### § 2.993 Field Strength of SPURIOUS Radiation (Analog)

OPERATING FREQUENCY: 848.91 MHz  
 CHANNEL: 0797 (High)  
 MEASURED OUTPUT POWER: 26.246 dBm = 0.422 W  
 MODULATION SIGNAL: ST (Signalling Tone)  
 DISTANCE: 3 meters  
 LIMIT:  $43 + 10 \log_{10} (W) =$  39.26 dBc

FREQ. (MHz)	LEVEL (dBm)	AFCL (dB)	POL (H/V)	F/S ( $\mu$ V/m)	ERP (dBm)	(dBc)
1697.82	-81.058	34.8	V	1089.18	-36.635	62.88
2546.73	-87.162	39.2	V	895.16	-38.339	64.59
3395.64	-89.372	42.9	V	1062.67	-36.849	63.10
4244.55	-110.233	46.1	V	139.11	-54.510	80.76
5093.46	< -130					
5942.37	< -130					

#### NOTES:

- The bandwidth is set per §22.917 (RBW = 1MHz, VBW = 1MHz).
- The spectrum was checked from 25 MHz up to the 10th harmonic.
- All emissions not listed were found to be more than 20dB below the limit.
- < -130dBm is below the floor of the spectrum analyzer.
- The EUT is manipulated through 3 orthogonal axis and the worst-case are reported.
- The EUT is placed 3m. away from the receiving antenna and the ERP is calculated using the formula:

$$\begin{aligned} \text{ERP (dBm)} &= 10 \text{ Log}_{10} \left( \frac{(r(\text{mV/m})/1 \times 10^6)^2}{49.2/1 \times 10^{-3}} \right) \\ \text{ERP (dBm)} &= 10 \text{ Log}_{10} \left[ \frac{(3 \times \text{FS}/1 \times 10^6)^2}{(49.2) \times 1000} \right] \\ \text{ERP (Watts)} &= \frac{(3 \times \text{FS})^2}{49.2} \end{aligned}$$

## 7.1 PLOT(S) OF EMISSIONS

---

## 8.1 TEST EQUIPMENT

8.2 Type	Model	Cal. Due Date	S/N
Microwave Spectrum Analyzer	HP 8566B (100Hz-22GHz)	08/15/01	3638A08713
Microwave Spectrum Analyzer	HP 8566B (100Hz-22GHz)	04/17/01	2542A11898
Spectrum Analyzer/Tracking Gen.	HP 8591A (100Hz-1.8GHz)	08/10/01	3144A02458
Signal Generator*	HP 8640B (500Hz-1GHz)	06/03/01	2232A19558
Signal Generator*	HP 8640B (500Hz-1GHz)	06/03/01	1851A09816
Signal Generator*	Rohde & Schwarz (0.1-1000MHz)	09/11/01	894215/012
Ailtech/Eaton Receiver	NM 37/57A-SL (30-1000MHz)	04/12/01	0792-03271
Ailtech/Eaton Receiver	NM 37/57A (30-1000MHz)	03/11/01	0805-03334
Ailtech/Eaton Receiver	NM17/27A (0.1-32MHz)	09/17/01	0608-03241
Quasi-Peak Adapter	HP 85650A	08/15/01	2043A00301
Ailtech/Eaton Adapter	CCA-7 CISPR/ANSI QP Adapter	03/11/01	0194-04082
Gigatronics Universal Power Meter	8657A		1835256
Gigatronics Power Sensor	80701A (0.05-18GHz)		1833460
Signal Generator	HP 8648D (9kHz-4GHz)		3613A00315
Amplifier Research	5SIG4 (5W, 800MHz-4.2GHz)		22322
Network Analyzer	HP 8753E (30kHz-3GHz)		JP38020182
Audio Analyzer	HP 8903B		3011A09025
Modulation Analyzer	HP 8901A		2432A03467
Power Meter	HP 437B		3125U24437
Power Sensor	HP 8482H (30 $\mu$ W-3W)		2237A02084
Harmonic/Flicker Test System	HP 6841A (IEC 555-2/3)		3531A00115
Broadband Amplifier (2)	HP 8447D		1145A00470, 1937A03348
Broadband Amplifier	HP 8447F		2443A03784
Horn Antenna	EMCO Model 3115 (1-18GHz)		9704-5182
Horn Antenna	EMCO Model 3115 (1-18GHz)		9205-3874
Horn Antenna	EMCO Model 3116 (18-40GHz)		9203-2178
Biconical Antenna (4)	Eaton 94455/Eaton 94455-1/Singer 94455-1/Compliance Design 1295, 1332, 0355		
Log-Spiral Antenna (3)	Ailtech/Eaton 93490-1		0608, 1103, 1104
Roberts Dipoles	Compliance Design (1 set)		
Ailtech Dipoles	DM-105A (1 set)		33448-111
EMCO LISN (6)	3816/2		1079
Microwave Preamplifier 40dB Gain	HP 83017A (0.5-26.5GHz)		3123A00181
Microwave Cables	MicroCoax (1.0-26.5GHz)		
Ailtech/Eaton Receiver	NM37/57A-SL		0792-03271
Spectrum Analyzer	HP 8594A		3051A00187
Spectrum Analyzer (2)	HP 8591A		3034A01395, 3108A02053
Microwave Survey Meter	Holaday Model 1501 (2.450GHz)		80931
Digital Thermometer	Extech Instruments 421305		426966
Attenuator	HP 8495A (0-70dB) DC-4GHz		
Bi-Directional Coax Coupler	Narda 3020A (50-1000MHz)		
Shielded Screen Room	RF Lindgren Model 26-2/2-0		6710 (PCT270)
Shielded Semi-Anechoic Chamber	Ray Proof Model S81		R2437 (PCT278)
Environmental Chamber	Associated Systems Model 1025 (Temperature/Humidity)		PCT285

\* Calibration traceable to the National Institute of Standards and Technology (NIST).

## 9.1 SAMPLE CALCULATIONS

---

### A. ERP Sample Calculation

$$\text{Level } \mu\text{V/m @ 3 meters} = \text{Log } 10^{-1} \frac{(\text{dBm} + 107 + \text{AFCL})}{20}$$

$$\text{Log } 10^{-1} \frac{(-14 + 107 + 31.7)}{20}$$

$$1717908.4 \mu\text{V/m @ 3 meters}$$

Sample Calculation (relative to a dipole)

$$\text{ERP (dBm)} = 10 \text{Log}_{10} \left( \frac{(r(\mu\text{V/m})1 \times 10^6)^2}{49.2/1 \times 10^{-3}} \right)$$

$$\text{ERP (dBm)} = 10 \text{Log}_{10} \left( \frac{(3(1717908.4)1 \times 10^6)^2}{49.2/1 \times 10^{-3}} \right)$$

$$\text{ERP (dBm)} = 27.32$$

## 10.1 CONCLUSION

---

The data collected shows that the **UNIDEN Single-Band Analog (AMPS) Panic Phone FCC ID: AMWUH052A** complies with all the requirements of Parts 2 and Part 22 of the FCC rules.