



Test Report – FCC 15B Unintentional Radiator

Prepared For: Uniden America Corporation

Approved for Release By:

Signature: Bruno Clavier

Name & Title: Bruno Clavier, General Manager

Date of Signature 3/2/2021

This test report shall not be reproduced except in full without the written and signed permission of Timco Engineering Inc. (IIA). This test report relates only to the items tested as identified and is not valid for any subsequent changes or modifications made to the equipment under test.



Table of Contents

1.	CUSTOMER INFORMATION.....	5
1.1	TEST RESULT SUMMARY	5
2.	LOCATION OF TESTING	6
2.1	TEST LABORATORY	6
2.2	TESTING WAS PERFORMED, REVIEWED BY	7
3.	TEST SAMPLE(S) (EUT/DUT).....	8
3.1	DESCRIPTION OF THE EUT.....	8
3.2	CONFIGURATION OF EUT	9
3.3	TEST SETUP OF EUT.....	9
4.	TEST METHODS & APPLICABLE REGULATORY LIMITS.....	10
4.1	TEST METHODS/STANDARDS/GUIDANCE	10
5.	MEASUREMENT UNCERTAINTY.....	10
6.	ENVIRONMENTAL CONDITIONS	10
7.	LIST OF TEST EQUIPMENT AND TEST FACILITY.....	11
8.	TEST RESULTS	12
8.1	RADIATED EMISSIONS.....	13
8.1.1	Scanning Receiver Function, 30 MHz to 200 MHz, Horizontal Polarity Plot.....	14
8.1.2	Scanning Receiver Function, 30 MHz to 200 MHz, Horizontal Polarity Table.....	15
8.1.3	Scanning Receiver Function, 30 MHz to 200 MHz, Vertical Polarity Plot.....	16
8.1.4	Scanning Receiver Function, 30 MHz to 200 MHz, Vertical Polarity Table.....	17
8.1.5	Scanning Receiver Function, 200 MHz to 1000 MHz, Horizontal Polarity Plot.....	18
8.1.6	Scanning Receiver Function, 200 MHz to 1000 MHz, Horizontal Polarity Table.....	19
8.1.7	Scanning Receiver Function, 200 MHz to 1000 MHz, Vertical Polarity Plot.....	20
8.1.8	Scanning Receiver Function, 200 MHz to 1000 MHz, Vertical Polarity Table	21
8.1.9	Scanning Receiver Function, above 1000 MHz, Horizontal Polarity Plot.....	22
8.1.10	Scanning Receiver Function, above 1000 MHz, Horizontal Polarity Table.....	23
8.1.11	Scanning Receiver Function, above 1000 MHz, Vertical Polarity Plot	24
8.1.12	Scanning Receiver Function, above 1000 MHz, Vertical Polarity Table	25
8.1.13	25MHz, 30 MHz to 200 MHz, Horizontal Polarity Plot.....	26
8.1.14	25MHz, 30 MHz to 200 MHz, Horizontal Polarity Table.....	27
8.1.15	25MHz, 30 MHz to 200 MHz, Vertical Polarity Plot	28
8.1.16	25MHz, 30 MHz to 200 MHz, Vertical Polarity Table	29
8.1.17	25MHz, 200 MHz to 1000 MHz, Horizontal Polarity Plot	30
8.1.18	25MHz, 200 MHz to 1000 MHz, Horizontal Polarity Table	31
8.1.19	25MHz, 200 MHz to 1000 MHz, Vertical Polarity Plot.....	32
8.1.20	25MHz, 200 MHz to 1000 MHz, Vertical Polarity Table.....	33
8.1.21	54MHz, 30 MHz to 200 MHz, Horizontal Polarity Plot	34
8.1.22	54MHz, 30 MHz to 200 MHz, Horizontal Polarity Table	35
8.1.23	54MHz, 30 MHz to 200 MHz, Vertical Polarity Plot.....	36



8.1.24	54MHz, 30 MHz to 200 MHz, Vertical Polarity Table	37
8.1.25	54MHz, 200 MHz to 1000 MHz, Horizontal Polarity Plot	38
8.1.26	54MHz, 200 MHz to 1000 MHz, Horizontal Polarity Table	39
8.1.27	54MHz, 200 MHz to 1000 MHz, Vertical Polarity Plot	40
8.1.28	54MHz, 200 MHz to 1000 MHz, Vertical Polarity Table	41
8.1.29	108MHz, 30 MHz to 200 MHz, Horizontal Polarity Plot	42
8.1.30	108MHz, 30 MHz to 200 MHz, Horizontal Polarity Table	43
8.1.31	108MHz, 30 MHz to 200 MHz, Vertical Polarity Plot	44
8.1.32	108MHz, 30 MHz to 200 MHz, Vertical Polarity Table	45
8.1.33	108MHz, 200 MHz to 1000 MHz, Horizontal Polarity Plot	46
8.1.34	108MHz, 200 MHz to 1000 MHz, Horizontal Polarity Table	47
8.1.35	108MHz, 200 MHz to 1000 MHz, Vertical Polarity Plot	48
8.1.36	108MHz, 200 MHz to 1000 MHz, Vertical Polarity Table	49
8.1.37	108MHz, above 1000 MHz, Horizontal Polarity Plot	50
8.1.38	108MHz, above 1000 MHz, Horizontal Polarity Table	51
8.1.39	108MHz, above 1000 MHz, Vertical Polarity Plot	52
8.1.40	108MHz, above 1000 MHz, Vertical Polarity Table	53
8.1.41	174MHz, 30 MHz to 200 MHz, Horizontal Polarity Plot	54
8.1.42	174MHz, 30 MHz to 200 MHz, Horizontal Polarity Table	55
8.1.43	174MHz, 30 MHz to 200 MHz, Vertical Polarity Plot	56
8.1.44	174MHz, 30 MHz to 200 MHz, Vertical Polarity Table	57
8.1.45	174MHz, 200 MHz to 1000 MHz, Horizontal Polarity Plot	58
8.1.46	174MHz, 200 MHz to 1000 MHz, Horizontal Polarity Table	59
8.1.47	174MHz, 200 MHz to 1000 MHz, Vertical Polarity Plot	60
8.1.48	174MHz, 200 MHz to 1000 MHz, Vertical Polarity Table	61
8.1.49	174MHz, above 1000 MHz, Horizontal Polarity Plot	62
8.1.50	174MHz, above 1000 MHz, Horizontal Polarity Table	63
8.1.51	174MHz, above 1000 MHz, Vertical Polarity Plot	64
8.1.52	174MHz, above 1000 MHz, Vertical Polarity Table	65
8.1.53	406MHz, 30 MHz to 200 MHz, Horizontal Polarity Plot	66
8.1.54	406MHz, 30 MHz to 200 MHz, Horizontal Polarity Table	67
8.1.55	406MHz, 30 MHz to 200 MHz, Vertical Polarity Plot	68
8.1.56	406MHz, 30 MHz to 200 MHz, Vertical Polarity Table	69
8.1.57	406MHz, 200 MHz to 1000 MHz, Horizontal Polarity Plot	70
8.1.58	406MHz, 200 MHz to 1000 MHz, Horizontal Polarity Table	71
8.1.59	406MHz, 200 MHz to 1000 MHz, Vertical Polarity Plot	72
8.1.60	406MHz, 200 MHz to 1000 MHz, Vertical Polarity Table	73
8.1.61	406MHz, above 1000 MHz, Horizontal Polarity Plot	74
8.1.62	406MHz, above 1000 MHz, Horizontal Polarity Table	75
8.1.63	406MHz, above 1000 MHz, Vertical Polarity Plot	76
8.1.64	406MHz, above 1000 MHz, Vertical Polarity Table	77
8.1.65	512MHz, 30 MHz to 200 MHz, Horizontal Polarity Plot	78
8.1.66	512MHz, 30 MHz to 200 MHz, Horizontal Polarity Table	79
8.1.67	512MHz, 30 MHz to 200 MHz, Vertical Polarity Plot	80
8.1.68	512MHz, 30 MHz to 200 MHz, Vertical Polarity Table	81
8.1.69	512MHz, 200 MHz to 1000 MHz, Horizontal Polarity Plot	82



8.1.70	512MHz, 200 MHz to 1000 MHz, Horizontal Polarity Table	83
8.1.71	512MHz, 200 MHz to 1000 MHz, Vertical Polarity Plot	84
8.1.72	512MHz, 200 MHz to 1000 MHz, Vertical Polarity Table	85
8.1.73	512MHz, above 1000 MHz, Horizontal Polarity Plot	86
8.1.74	512MHz, above 1000 MHz, Horizontal Polarity Table	87
8.1.75	512MHz, above 1000 MHz, Vertical Polarity Plot	88
8.1.76	512MHz, above 1000 MHz, Vertical Polarity Table	89
8.2	CONDUCTED EMISSIONS.....	90
8.2.1	Scanning, Line 1 Plot	91
8.2.2	Scanning, Line 2 Plot	92
8.2.3	Scanning, Line 2 Table	93
8.2.4	25MHz, Line 1 Plot	94
8.2.5	25MHz, Line 1 Table	95
8.2.6	25MHz, Line 2 Plot	96
8.2.7	25MHz, Line 2 Table	97
8.2.8	54MHz, Line 1 Plot	98
8.2.9	54MHz, Line 1 Table	99
8.2.10	54MHz, Line 2 Plot	100
8.2.11	54MHz, Line 2 Table	101
8.2.12	108MHz, Line 1 Plot	102
8.2.13	108MHz, Line 1 Table	103
8.2.14	108MHz, Line 2 Plot	104
8.2.15	108MHz, Line 2 Table	105
8.2.16	174MHz, Line 1 Plot	106
8.2.17	174MHz, Line 1 Table	107
8.2.18	174MHz, Line 2 Plot	108
8.2.19	174MHz, Line 2 Table	109
8.2.20	406MHz, Line 1 Plot	110
8.2.21	406MHz, Line 1 Table	111
8.2.22	406MHz, Line 2 Plot	112
8.2.1	406MHz, Line 2 Table	113
8.2.2	512MHz, Line 1 Plot	114
8.2.3	512MHz, Line 1 Table	115
8.2.4	512MHz, Line 2 Plot	116
8.2.5	512MHz, Line 2 Table	117
9.	ANNEX-A - PHOTOGRAPHS OF THE EUT.....	118
10.	ANNEX-B – TEST SETUP PHOTOGRAPHS.....	118
11.	HISTORY OF TEST REPORT CHANGES	118



Timco Engineering, Inc., an IIA Company
 849 NW State Road 45, Newberry, Florida 32669
 (352) 472-5500 / testing@timcoengr.com

1. Customer Information

Applicant: Uniden America Corporation
Address: 6225 N State Highway 161
 Suite 300
 Irving, TX 75038

Technical Contact: Steve Roby
Telephone: 817-858-8624
Email address: SRoby@uniden.com

1.1 Test Result Summary

The following test procedure was used ANSI C63.4-2014. Full test results are available in this report.

No additions to the test methods were needed. There were no deviations, or exclusions from the test methods. No test results are from external providers or from the customer. The test results relate only to the items tested. Timco does not offer opinions and interpretations, only a pass/fail statement.

Clauses	Description of the Requirements	Result (Pass, Fail or N/A)
Applicable Clauses from FCC 15 B		
15.107	Conducted Emission Limits	Pass
15.111 (a)	Receiver Conducted Power	NA
15.121	38 dB Rejection	NA ⁽²⁾
15.109	Radiated Emission Limits	Pass

Notes:

- 1) EUT is not intended for connection with AC Mains.
- 2) Manufacturer provided attestation letter, no test required.



Timco Engineering, Inc., an IIA Company
849 NW State Road 45, Newberry, Florida 32669
(352) 472-5500 / testing@timcoengr.com

2. Location of Testing

2.1 Test Laboratory

Timco Engineering Inc. is a subsidiary of Industrial Inspection & Analysis, Inc. ("IIA"). Testing was performed at Timco's permanent laboratory located at 849 NW State Road 45, Newberry, Florida 32669

FCC test firm # 578780

FCC Designation # US1070

FCC site registration is under A2LA certificate # 0955.01

ISED Canada test site registration # 2056A

EU Notified Body # 1177

For all designations see A2LA scope # 0955.01



Timco Engineering, Inc., an IIA Company
 849 NW State Road 45, Newberry, Florida 32669
 (352) 472-5500 / testing@timcoengr.com

2.2 Testing was performed, reviewed by

Dates of Testing: 3/2/2021 – 3/2/2021

Signature:  _____

Name & Title: Franklin Rose, EMC Specialist

Date of Signature 3/2/2021

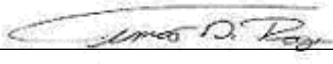
Signature:  _____

Sr. EMC Engineer
 EMC-003838-NE



Name & Title: Tim Royer, EMC Engineer

Date of Signature 3/2/2021



3. Test Sample(s) (EUT/DUT)

The test sample was received: 3/2/2021

3.1 Description of the EUT

A description as well as unambiguous identification of the EUT(s) tested. Where more than one sample is required for technical reasons (such as the use of connected units for the purpose of conducted output power testing where the product units will have integral antennas), each specific test shall identify which unit was tested.

Identification	
FCC ID:	AMWUB375
Brief Description	Digital Scanning Receiver
Type of Modular	N/A
Model(s) #	BCD536HP
Firmware version	N/A
Software version	N/A
Serial Number	N/A

Technical Characteristics	
Technology	Digital Scanning Receiver
Frequency Range	25 – 1300 MHz
RF O/P Power (Max.)	N/A
Modulation	N/A
Bandwidth & Emission Class	N/A
Number of Channels	N/A
Duty Cycle	N/A
Antenna Connector	N/A
Voltage Rating (AC or Batt.)	AC

Antenna Characteristics			
Antenna	Frequency Range	Mode / BW	Antenna Gain
1	n/a	n/a	0 dBi
2			



3.2 Configuration of EUT

Band	Mode	Number of Ant.
	Receive	1

Operating conditions during Testing:

No modifications of the device under test (including firmware, specific software settings, and input/output signal levels to the EUT).

Peripherals used during Testing:

No peripherals used.

3.3 Test Setup of EUT

Equipment, antenna, and cable arrangement. The setup of the equipment and cable or wire placement on the test site that produces the highest radiated and the highest ac power-line conducted emissions shall be shown clearly and described. Information on the orientation of portable equipment during testing shall be included. Drawings or photographs may be used for this purpose.

Test Setups are included in the test report.



4. Test methods & Applicable Regulatory Limits

4.1 Test methods/Standards/Guidance

The measurement was performed as per FCC 15B. Full test results are available in this report.

Limits and Regulatory Limits:

- 1) FCC 15B

5. Measurement Uncertainty

Parameter	Uncertainty (dB)
Conducted Emissions	1.42
Radiated Emissions (30 – 200 MHz)	5.49
Radiated Emissions (200 – 1000 MHz)	5.79
Radiated Emissions (1 GHz – 18 GHz)	4.37

The uncertainties provided in this table represent an expanded uncertainty expressed at approximately the 95% confidence level using a coverage factor of K=2.

6. Environmental Conditions

Temperature & Humidity

Measurements performed at the test site did not exceed the following:

Parameter	Measurement
Temperature	23 C +/- 5%
Humidity	55% +/- 5%
Barometric Pressure	30.05 in Hg

Note: Specific environmental conditions that are applicable to a specific test are available in the test result section.



7. List of Test Equipment and Test Facility

The test equipment used identified by type, manufacturer, serial number, or other identification and the date on which the next calibration or service check is due.

Description of the firmware or software used to operate EUT for testing purposes.

A complete list of all test equipment used shall be included with the test report. The manufacturer’s model and serial numbers, and date of last calibration, and calibration interval shall be included. Measurement cable loss, measuring instrument bandwidth and detector function, video bandwidth, if appropriate, and antenna factors shall also be included where applicable.

List of Test Equipment

Device	Manufacturer	Model	SN #	Current Cal	Cal Due
Active Loop	ETS-Lindgren	6502	00062529	10/20/20	10/20/2023
Biconical 1057	Eaton	94455-1	1057	10/16/20	10/16/2023
Log-Periodic 1243	Eaton	96005	1243	4/20/18	4/19/2021
Double-Ridged Horn/ETS Horn 1	ETS-Lindgren	3117	00035923	2/25/20	2/24/2023
Double-Ridged Horn/ETS Horn 2	ETS-Lindgren	3117	00041534	10/14/20	10/14/2023
Double-Ridged Horn 18-40 GHz	EMCO	3116	9011-2145	10/19/20	10/19/2023
CHAMBER	Panashield	3M	N/A	3/12/19	3/11/2021
Pre-amp	RF-LAMBDA	RLNA00M45GA	NA	2/27/19	2/26/2022
EMI Test Receiver R&S ESU 40	Rohde & Schwarz	ESU 40	100320	8/28/18	8/27/2021
LISN (Primary)	Electro-Metrics	ANS-25/2	225363	9/16/20	9/16/2023



Timco Engineering, Inc., an IIA Company
849 NW State Road 45, Newberry, Florida 32669
(352) 472-5500 / testing@timcoengr.com

8. Test Results

The results of the test are usually indicated in the form of tables, spectrum analyzer plots, charts, sample calculations, as appropriate for each test procedure.

A description and/or a block diagram of the test setup is usually provided.

The measurement results, along with the appropriate limits for comparison, may be presented in tabular or graphical form. In addition, any variation in the measurement environment may be reported if applicable (e.g., a significant change of temperature that could affect the cable loss and amplifier response).

Units of measurement

Unless noted otherwise in the referenced standard, the measurements of ac power-line conducted emissions and conducted power output will be reported in units of dB μ V. Unless noted otherwise in the referenced standard, the measurements of radiated emissions will be reported in units of decibels, referenced to one microvolt per meter (dB μ V/m) for electric fields, or to one ampere per meter (dBA/m) for magnetic fields, at the distance specified in the appropriate standards or requirements. The measurements of antenna-conducted power for receivers may be reported in units of dB μ V if the impedance of the measuring instrument is also reported. Otherwise, antenna-conducted power will be reported in units of decibels referenced to one milliwatt (dBm). All formulas for data conversions and conversion factors, if used, will be included in this measurement report.

8.1 Radiated Emissions

Limits from FCC 15.109 and test procedure from ANSI C63.4-2014.

Radiated Test Setup, 30 – 1000 MHz

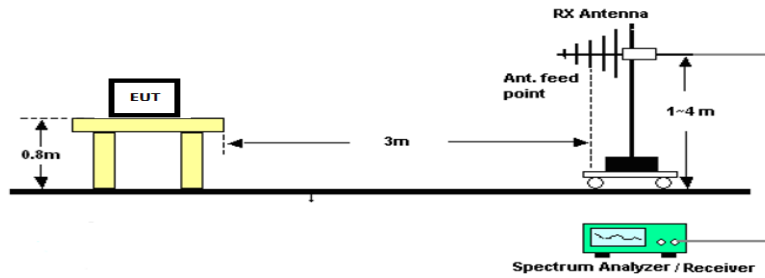

Radiated Test Setup, Above 1000 MHz

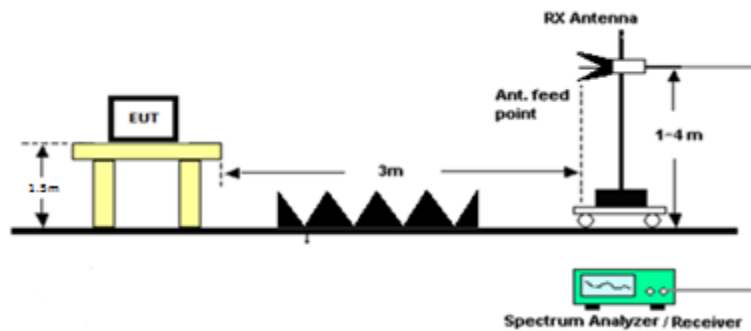

8.1.1 Scanning Receiver Function, 30 MHz to 200 MHz, Horizontal Polarity Plot



02 Mar 21 14:46

Test Spec CISPR 22 Radiated Disturbances

Polarity

Vertical

Stepped Scan (1 Range)

Scan Start: 30 MHz
 Scan Stop: 200 MHz
 Detector: Trace 1: MAX PEAK
 Transducer: TDS_01

Start Frequency	Stop Frequency	Step Size	Res BW	Meas Time	RF Atten	Preamp	Input
30.000000 MHz	200.000000 MHz	40.00 kHz	120.00 kHz	50 μs	Auto	20 dB	INPUT1

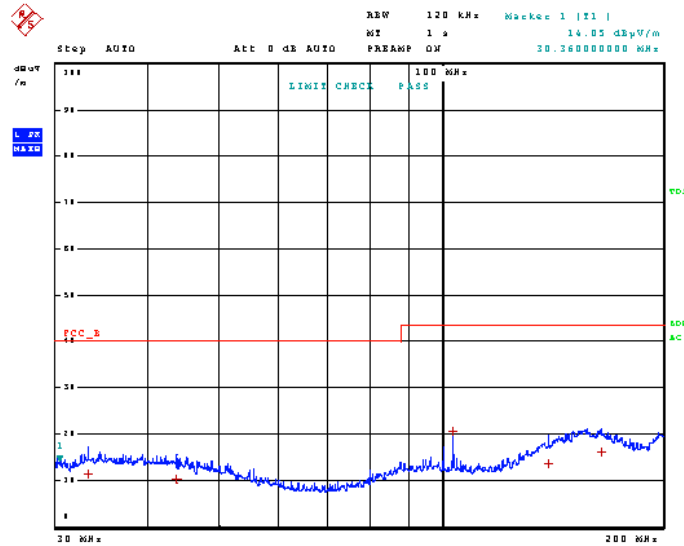



8.1.2 Scanning Receiver Function, 30 MHz to 200 MHz, Horizontal Polarity Table

02.Mar 21 14:46

Test Spec CISPR 22 Radiated Disturbances

Polarity

Vertical

Final Measurement

Meas Time: 1 s
Margin: 25 dB
Subranges: 5

Trace	Frequency	Level (dB μ V/m)	Detector	Delta Limit/dB
1	33.120000000 MHz	11.55	Quasi Peak	-28.45
1	43.720000000 MHz	10.29	Quasi Peak	-29.71
1	103.720000000 MHz	20.68	Quasi Peak	-22.82
1	139.800000000 MHz	13.61	Quasi Peak	-29.89
1	164.400000000 MHz	16.04	Quasi Peak	-27.46

Page 2 of 2

8.1.3 Scanning Receiver Function, 30 MHz to 200 MHz, Vertical Polarity Plot



02 Mar 21 14:48

Test Spec CISPR 22 Radiated Disturbances

Polarity

Vertical

Stepped Scan (1 Range)

Scan Start: 30 MHz
 Scan Stop: 200 MHz
 Detector: Trace 1: MAX PEAK
 Transducer: TDS_01

Start Frequency	Stop Frequency	Step Size	Res BW	Meas Time	RF Atten	Preamp	Input
30.000000 MHz	200.000000 MHz	40.00 kHz	120.00 kHz	50 µs	Auto	20 dB	INPUT1

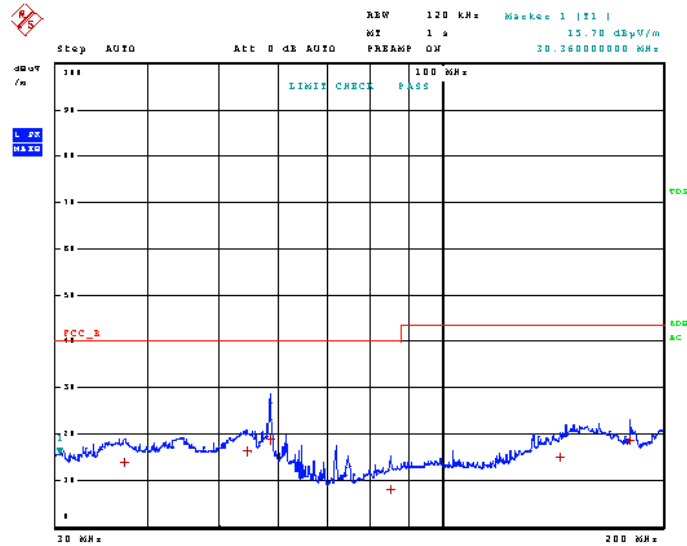



8.1.4 Scanning Receiver Function, 30 MHz to 200 MHz, Vertical Polarity Table

02.Mar 21 14:48

Test Spec CISPR 22 Radiated Disturbances

Polarity

Vertical

Final Measurement

Meas Time: 1 s
 Margin: 25 dB
 Subranges: 6

Trace	Frequency	Level (dBµV/m)	Detector	Delta Limit/dB
1	37.120000000 MHz	13.98	Quasi Peak	-26.02
1	54.360000000 MHz	16.31	Quasi Peak	-23.69
1	58.560000000 MHz	18.76	Quasi Peak	-21.24
1	85.400000000 MHz	8.06	Quasi Peak	-31.94
1	145.080000000 MHz	14.95	Quasi Peak	-28.55
1	180.320000000 MHz	18.65	Quasi Peak	-24.85

8.1.5 Scanning Receiver Function, 200 MHz to 1000 MHz, Horizontal Polarity Plot



02 Mar 21 14:54

Test Spec CISPR 22 Radiated Disturbances

Polarity

Horizontal

Time Domain Scan (1 Range)

Scan Start: 200 MHz
 Scan Stop: 1 GHz
 Detector: Trace 1: MAX PEAK
 Transducer: TDS_01

Start Frequency	Stop Frequency	Step Size	Res BW	Meas Time	RF Atten	Preamp	Input
200.000000 MHz	1.000000 GHz	30.00 kHz	120.00 kHz	50 µs	Auto	20 dB	INPUT1

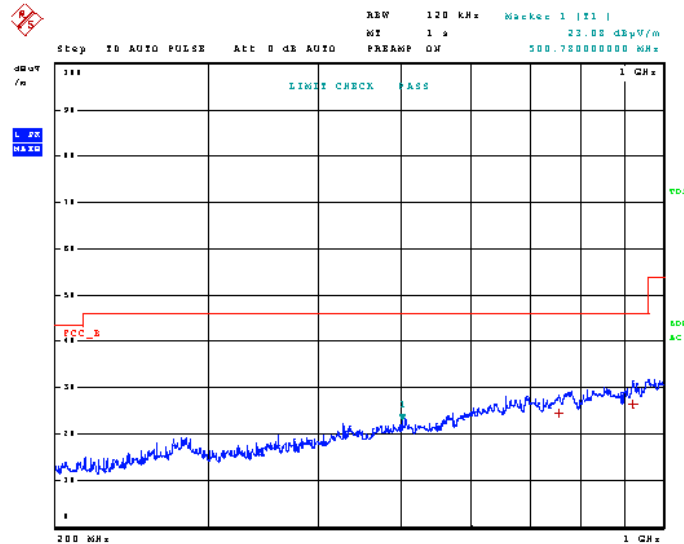

Page 1 of 2



8.1.6 Scanning Receiver Function, 200 MHz to 1000 MHz, Horizontal Polarity Table

02.Mar 21 14:54

Test Spec CISPR 22 Radiated Disturbances

Polarity
Horizontal

Final Measurement

Meas Time: 1 s
Margin: 20 dB
Subranges: 2

Trace	Frequency	Level (dB μ V/m)	Detector	Delta Limit/dB
1	758.120000000 MHz	24.43	Quasi Peak	-21.57
1	922.190000000 MHz	26.37	Quasi Peak	-19.63



8.1.7 Scanning Receiver Function, 200 MHz to 1000 MHz, Vertical Polarity Plot



02 Mar 21 14:53

Test Spec CISPR 22 Radiated Disturbances

Polarity

Horizontal

Time Domain Scan (1 Range)

Scan Start: 200 MHz
Scan Stop: 1 GHz
Detector: Trace 1: MAX PEAK
Transducer: TDS_01

Start Frequency	Stop Frequency	Step Size	Res BW	Meas Time	RF Atten	Preamp	Input
200.000000 MHz	1.000000 GHz	30.00 kHz	120.00 kHz	50 μ s	Auto	20 dB	INPUT1

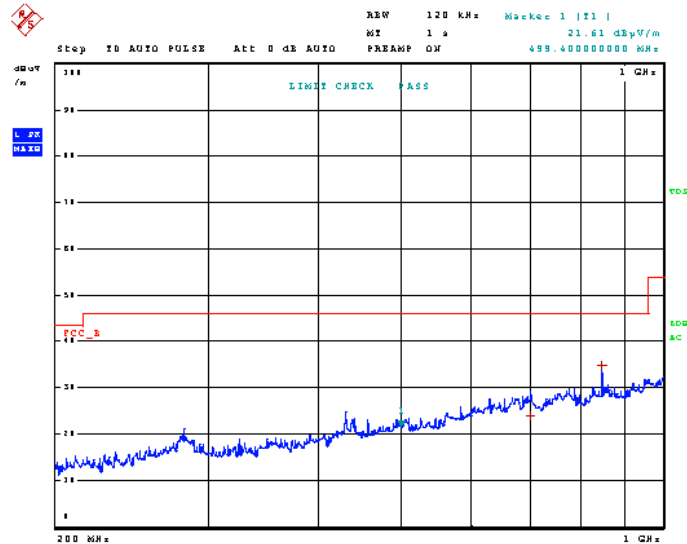



8.1.8 Scanning Receiver Function, 200 MHz to 1000 MHz, Vertical Polarity Table

02.Mar 21 14:53

Test Spec CISPR 22 Radiated Disturbances

Polarity
Horizontal

Final Measurement

Meas Time: 1 s
Margin: 20 dB
Subranges: 2

Trace	Frequency	Level (dB μ V/m)	Detector	Delta Limit/dB
1	702.860000000 MHz	23.84	Quasi Peak	-22.16
1	850.490000000 MHz	34.75	Quasi Peak	-11.25



8.1.9 Scanning Receiver Function, above 1000 MHz, Horizontal Polarity Plot

02.Mar 21 19:51

Time Domain Scan (1 Range)

Scan Start: 1 GHz
 Scan Stop: 12.5 GHz
 Detector: Trace 1: MAX PEAK Trace 2: MAX PEAK
 Transducer: TDS_05

Start Frequency	Stop Frequency	Step Size	Res BW	Meas Time	RF Atten	Preamp	Input
1.000000 GHz	12.500000 GHz	250.00 kHz	1.00 MHz	100 μ s	Auto	35 dB	INPUT1

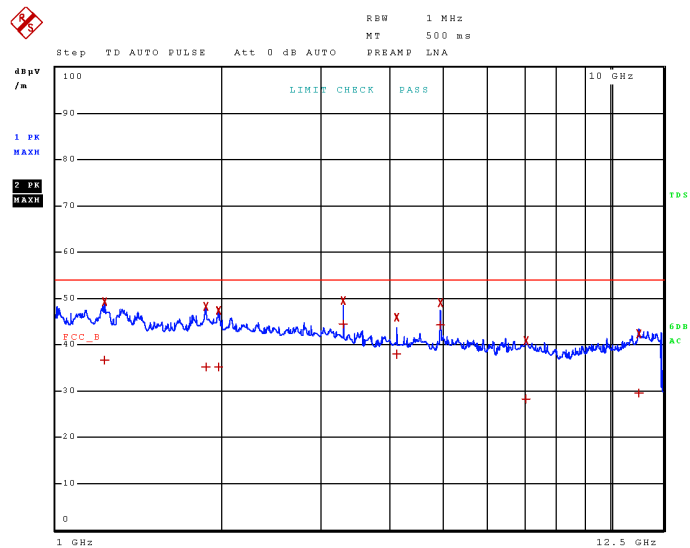



8.1.10 Scanning Receiver Function, above 1000 MHz, Horizontal Polarity Table

02.Mar 21 19:51

Final Measurement

Meas Time: 500 ms
 Margin: 40 dB
 Subranges: 16

Trace	Frequency	Level (dBµV/m)	Detector	Delta Limit/dB
1	1.225000000 GHz	36.73	CISPR Averag	-17.27
2	1.225000000 GHz	49.29	Max Peak	
1	1.864000000 GHz	35.23	CISPR Averag	-18.77
2	1.864000000 GHz	48.23	Max Peak	
1	1.963000000 GHz	35.28	CISPR Averag	-18.72
2	1.963000000 GHz	47.44	Max Peak	
1	3.294500000 GHz	44.50	CISPR Averag	-9.50
2	3.294500000 GHz	49.38	Max Peak	
1	4.118000000 GHz	37.86	CISPR Averag	-16.14
2	4.118000000 GHz	46.01	Max Peak	
1	4.941500000 GHz	44.16	CISPR Averag	-9.84
2	4.941500000 GHz	48.98	Max Peak	
1	7.071250000 GHz	28.24	CISPR Averag	-25.76
2	7.071250000 GHz	40.89	Max Peak	
1	11.318750000 GHz	29.61	CISPR Averag	-24.39
2	11.318750000 GHz	42.28	Max Peak	



8.1.11 Scanning Receiver Function, above 1000 MHz, Vertical Polarity Plot

02.Mar 21 19:52

Time Domain Scan (1 Range)

Scan Start: 1 GHz
 Scan Stop: 12.5 GHz
 Detector: Trace 1: MAX PEAK Trace 2: MAX PEAK
 Transducer: TDS_05

Start Frequency	Stop Frequency	Step Size	Res BW	Meas Time	RF Atten	Preamp	Input
1.000000 GHz	12.500000 GHz	250.00 kHz	1.00 MHz	100 μ s	Auto	35 dB	INPUT1

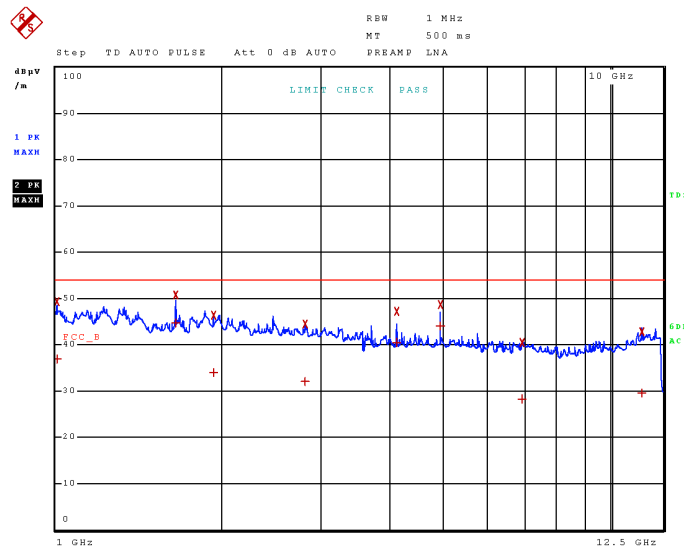



8.1.12 Scanning Receiver Function, above 1000 MHz, Vertical Polarity Table

02.Mar 21 19:52

Final Measurement

Meas Time: 500 ms
 Margin: 40 dB
 Subranges: 16

Trace	Frequency	Level (dBµV/m)	Detector	Delta Limit/dB
1	1.005000000 GHz	36.94	CISPR Averag	-17.06
2	1.005000000 GHz	49.19	Max Peak	
1	1.647250000 GHz	44.71	CISPR Averag	-9.29
2	1.647250000 GHz	50.66	Max Peak	
1	1.927000000 GHz	33.82	CISPR Averag	-20.18
2	1.927000000 GHz	46.37	Max Peak	
1	2.815500000 GHz	31.96	CISPR Averag	-22.04
2	2.815500000 GHz	44.48	Max Peak	
1	4.118000000 GHz	40.42	CISPR Averag	-13.58
2	4.118000000 GHz	47.09	Max Peak	
1	4.941500000 GHz	44.08	CISPR Averag	-9.92
2	4.941500000 GHz	48.70	Max Peak	
1	6.955500000 GHz	28.20	CISPR Averag	-25.80
2	6.955500000 GHz	40.35	Max Peak	
1	11.425500000 GHz	29.54	CISPR Averag	-24.46
2	11.425500000 GHz	42.73	Max Peak	

8.1.13 25MHz, 30 MHz to 200 MHz, Horizontal Polarity Plot



02 Mar 21 14:24

Test Spec CISPR 22 Radiated Disturbances

Polarity

Vertical

Stepped Scan (1 Range)

Scan Start: 30 MHz
 Scan Stop: 200 MHz
 Detector: Trace 1: MAX PEAK
 Transducer: TDS_01

Start Frequency	Stop Frequency	Step Size	Res BW	Meas Time	RF Atten	Preamp	Input
30.000000 MHz	200.000000 MHz	40.00 kHz	120.00 kHz	50 µs	Auto	20 dB	INPUT1

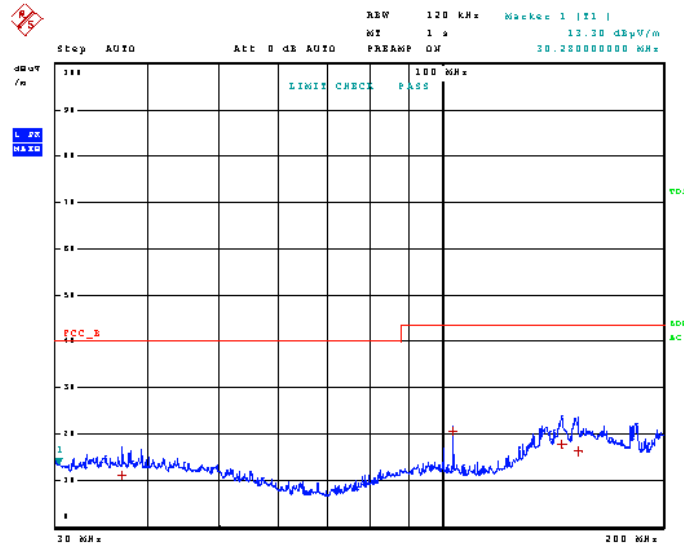



8.1.14 25MHz, 30 MHz to 200 MHz, Horizontal Polarity Table

02.Mar 21 14:24

Test Spec CISPR 22 Radiated Disturbances

Polarity

Vertical

Final Measurement

Meas Time: 1 s
 Margin: 25 dB
 Subranges: 4

Trace	Frequency	Level (dBµV/m)	Detector	Delta Limit/dB
1	36.880000000 MHz	11.02	Quasi Peak	-28.98
1	103.760000000 MHz	20.67	Quasi Peak	-22.83
1	145.640000000 MHz	17.84	Quasi Peak	-25.66
1	152.800000000 MHz	16.30	Quasi Peak	-27.20

8.1.15 25MHz, 30 MHz to 200 MHz, Vertical Polarity Plot



02 Mar 21 14:26

Test Spec CISPR 22 Radiated Disturbances

Polarity

Vertical

Stepped Scan (1 Range)

Scan Start: 30 MHz
 Scan Stop: 200 MHz
 Detector: Trace 1: MAX PEAK
 Transducer: TDS_01

Start Frequency	Stop Frequency	Step Size	Res BW	Meas Time	RF Atten	Preamp	Input
30.000000 MHz	200.000000 MHz	40.00 kHz	120.00 kHz	50 μ s	Auto	20 dB	INPUT1

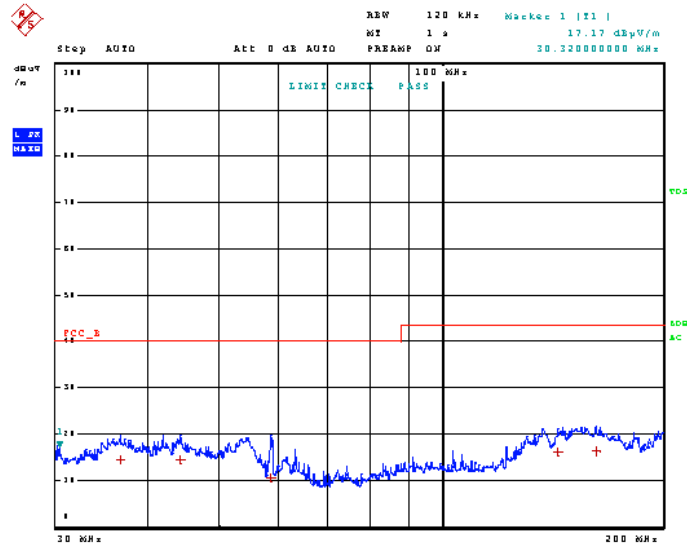



8.1.16 25MHz, 30 MHz to 200 MHz, Vertical Polarity Table

02.Mar 21 14:26

Test Spec CISPR 22 Radiated Disturbances

Polarity

Vertical

Final Measurement

Meas Time: 1 s
Margin: 25 dB
Subranges: 5

Trace	Frequency	Level (dB μ V/m)	Detector	Delta Limit/dB
1	36.640000000 MHz	14.29	Quasi Peak	-25.71
1	44.240000000 MHz	14.49	Quasi Peak	-25.51
1	58.720000000 MHz	10.56	Quasi Peak	-29.44
1	143.800000000 MHz	16.12	Quasi Peak	-27.38
1	162.200000000 MHz	16.18	Quasi Peak	-27.32



8.1.17 25MHz, 200 MHz to 1000 MHz, Horizontal Polarity Plot



02 Mar 21 14:24

Test Spec CISPR 22 Radiated Disturbances

Polarity

Vertical

Stepped Scan (1 Range)

Scan Start: 30 MHz
 Scan Stop: 200 MHz
 Detector: Trace 1: MAX PEAK
 Transducer: TDS_01

Start Frequency	Stop Frequency	Step Size	Res BW	Meas Time	RF Atten	Preamp	Input
30.000000 MHz	200.000000 MHz	40.00 kHz	120.00 kHz	50 μ s	Auto	20 dB	INPUT1

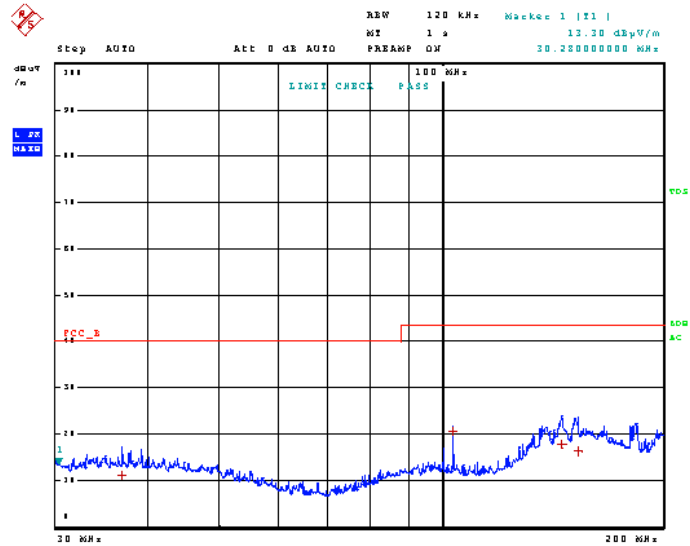



8.1.18 25MHz, 200 MHz to 1000 MHz, Horizontal Polarity Table

02.Mar 21 14:24

Test Spec CISPR 22 Radiated Disturbances

Polarity

Vertical

Final Measurement

Meas Time: 1 s
 Margin: 25 dB
 Subranges: 4

Trace	Frequency	Level (dBµV/m)	Detector	Delta Limit/dB
1	36.880000000 MHz	11.02	Quasi Peak	-28.98
1	103.760000000 MHz	20.67	Quasi Peak	-22.83
1	145.640000000 MHz	17.84	Quasi Peak	-25.66
1	152.800000000 MHz	16.30	Quasi Peak	-27.20

8.1.19 25MHz, 200 MHz to 1000 MHz, Vertical Polarity Plot



02 Mar 21 14:26

Test Spec CISPR 22 Radiated Disturbances

Polarity

Vertical

Stepped Scan (1 Range)

Scan Start: 30 MHz
 Scan Stop: 200 MHz
 Detector: Trace 1: MAX PEAK
 Transducer: TDS_01

Start Frequency	Stop Frequency	Step Size	Res BW	Meas Time	RF Atten	Preamp	Input
30.000000 MHz	200.000000 MHz	40.00 kHz	120.00 kHz	50 µs	Auto	20 dB	INPUT1

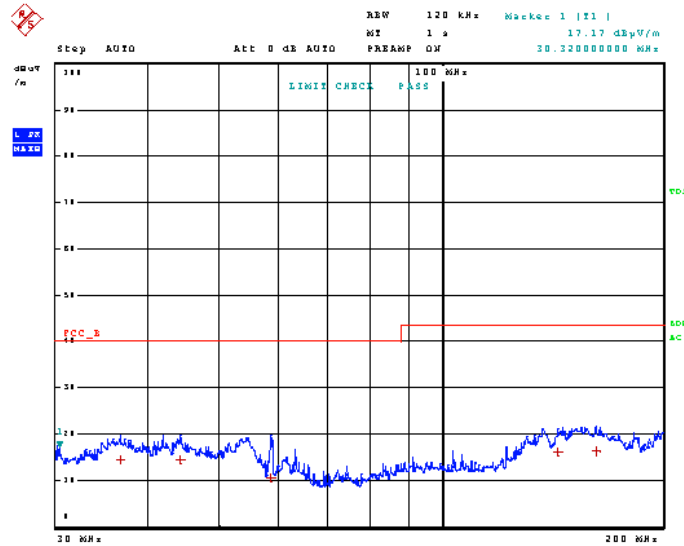



8.1.20 25MHz, 200 MHz to 1000 MHz, Vertical Polarity Table

02.Mar 21 14:26

Test Spec CISPR 22 Radiated Disturbances

Polarity

Vertical

Final Measurement

Meas Time: 1 s
Margin: 25 dB
Subranges: 5

Trace	Frequency	Level (dB μ V/m)	Detector	Delta Limit/dB
1	36.640000000 MHz	14.29	Quasi Peak	-25.71
1	44.240000000 MHz	14.49	Quasi Peak	-25.51
1	58.720000000 MHz	10.56	Quasi Peak	-29.44
1	143.800000000 MHz	16.12	Quasi Peak	-27.38
1	162.200000000 MHz	16.18	Quasi Peak	-27.32

8.1.21 54MHz, 30 MHz to 200 MHz, Horizontal Polarity Plot



02 Mar 21 14:24

Test Spec CISPR 22 Radiated Disturbances

Polarity

Vertical

Stepped Scan (1 Range)

Scan Start: 30 MHz
 Scan Stop: 200 MHz
 Detector: Trace 1: MAX PEAK
 Transducer: TDS_01

Start Frequency	Stop Frequency	Step Size	Res BW	Meas Time	RF Atten	Preamp	Input
30.000000 MHz	200.000000 MHz	40.00 kHz	120.00 kHz	50 μ s	Auto	20 dB	INPUT1

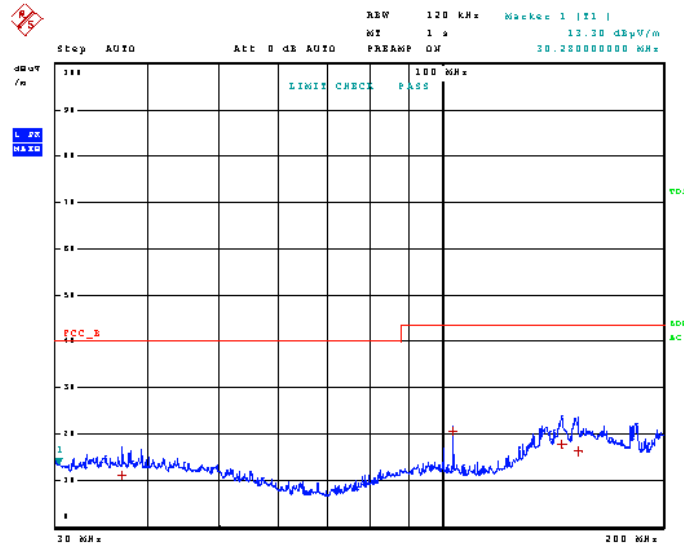



8.1.22 54MHz, 30 MHz to 200 MHz, Horizontal Polarity Table

02.Mar 21 14:24

Test Spec CISPR 22 Radiated Disturbances

Polarity

Vertical

Final Measurement

Meas Time: 1 s
 Margin: 25 dB
 Subranges: 4

Trace	Frequency	Level (dBµV/m)	Detector	Delta Limit/dB
1	36.880000000 MHz	11.02	Quasi Peak	-28.98
1	103.760000000 MHz	20.67	Quasi Peak	-22.83
1	145.640000000 MHz	17.84	Quasi Peak	-25.66
1	152.800000000 MHz	16.30	Quasi Peak	-27.20

8.1.23 54MHz, 30 MHz to 200 MHz, Vertical Polarity Plot



02 Mar 21 14:26

Test Spec CISPR 22 Radiated Disturbances

Polarity

Vertical

Stepped Scan (1 Range)

Scan Start: 30 MHz
 Scan Stop: 200 MHz
 Detector: Trace 1: MAX PEAK
 Transducer: TDS_01

Start Frequency	Stop Frequency	Step Size	Res BW	Meas Time	RF Atten	Preamp	Input
30.000000 MHz	200.000000 MHz	40.00 kHz	120.00 kHz	50 μ s	Auto	20 dB	INPUT1

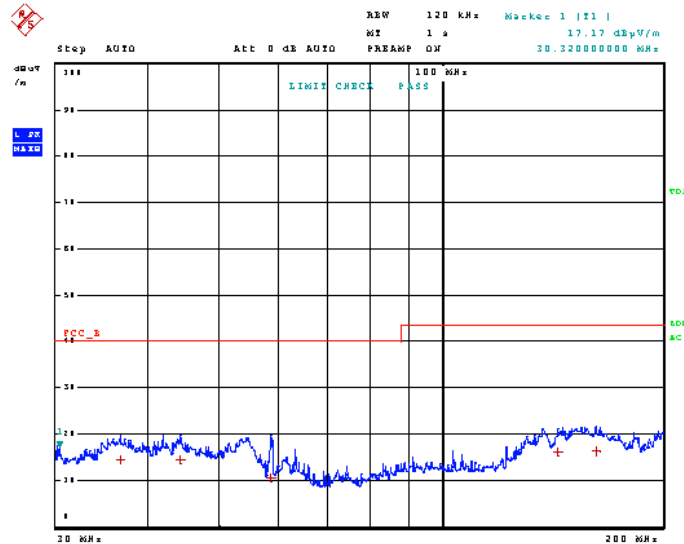



8.1.24 54MHz, 30 MHz to 200 MHz, Vertical Polarity Table

02.Mar 21 14:26

Test Spec CISPR 22 Radiated Disturbances

Polarity

Vertical

Final Measurement

Meas Time: 1 s
Margin: 25 dB
Subranges: 5

Trace	Frequency	Level (dB μ V/m)	Detector	Delta Limit/dB
1	36.640000000 MHz	14.29	Quasi Peak	-25.71
1	44.240000000 MHz	14.49	Quasi Peak	-25.51
1	58.720000000 MHz	10.56	Quasi Peak	-29.44
1	143.800000000 MHz	16.12	Quasi Peak	-27.38
1	162.200000000 MHz	16.18	Quasi Peak	-27.32

8.1.25 54MHz, 200 MHz to 1000 MHz, Horizontal Polarity Plot



02 Mar 21 15:05

Test Spec CISPR 22 Radiated Disturbances

Polarity

Horizontal

Time Domain Scan (1 Range)

Scan Start: 200 MHz
 Scan Stop: 1 GHz
 Detector: Trace 1: MAX PEAK
 Transducer: TDS_01

Start Frequency	Stop Frequency	Step Size	Res BW	Meas Time	RF Atten	Preamp	Input
200.000000 MHz	1.000000 GHz	30.00 kHz	120.00 kHz	50 μ s	Auto	20 dB	INPUT1

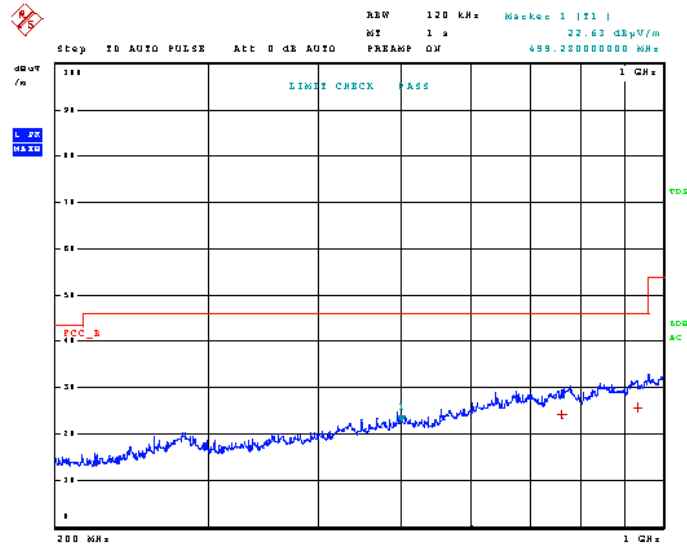



8.1.26 54MHz, 200 MHz to 1000 MHz, Horizontal Polarity Table

02.Mar 21 15:05

Test Spec CISPR 22 Radiated Disturbances

Polarity
Horizontal

Final Measurement

Meas Time: 1 s
Margin: 20 dB
Subranges: 2

Trace	Frequency	Level (dB μ V/m)	Detector	Delta Limit/dB
1	764.120000000 MHz	24.23	Quasi Peak	-21.77
1	936.110000000 MHz	25.71	Quasi Peak	-20.29

8.1.27 54MHz, 200 MHz to 1000 MHz, Vertical Polarity Plot



02 Mar 21 15:06

Test Spec CISPR 22 Radiated Disturbances

Polarity

Horizontal

Time Domain Scan (1 Range)

Scan Start: 200 MHz
 Scan Stop: 1 GHz
 Detector: Trace 1: MAX PEAK
 Transducer: TDS_01

Start Frequency	Stop Frequency	Step Size	Res BW	Meas Time	RF Atten	Preamp	Input
200.000000 MHz	1.000000 GHz	30.00 kHz	120.00 kHz	50 μ s	Auto	20 dB	INPUT1

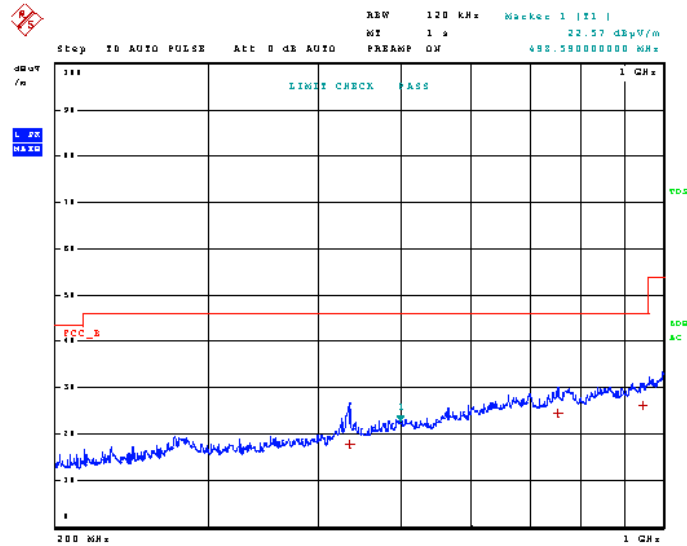



8.1.28 54MHz, 200 MHz to 1000 MHz, Vertical Polarity Table

02.Mar 21 15:06

Test Spec CISPR 22 Radiated Disturbances

Polarity

Horizontal

Final Measurement

Meas Time: 1 s
Margin: 20 dB
Subranges: 3

Trace	Frequency	Level (dB μ V/m)	Detector	Delta Limit/dB
1	436.070000000 MHz	17.75	Quasi Peak	-28.25
1	756.680000000 MHz	24.41	Quasi Peak	-21.59
1	947.900000000 MHz	26.15	Quasi Peak	-19.85

8.1.29 108MHz, 30 MHz to 200 MHz, Horizontal Polarity Plot



02 Mar 21 14:30

Test Spec CISPR 22 Radiated Disturbances

Polarity

Vertical

Stepped Scan (1 Range)

Scan Start: 30 MHz
 Scan Stop: 200 MHz
 Detector: Trace 1: MAX PEAK
 Transducer: TDS_01

Start Frequency	Stop Frequency	Step Size	Res BW	Meas Time	RF Atten	Preamp	Input
30.000000 MHz	200.000000 MHz	40.00 kHz	120.00 kHz	50 μs	Auto	20 dB	INPUT1

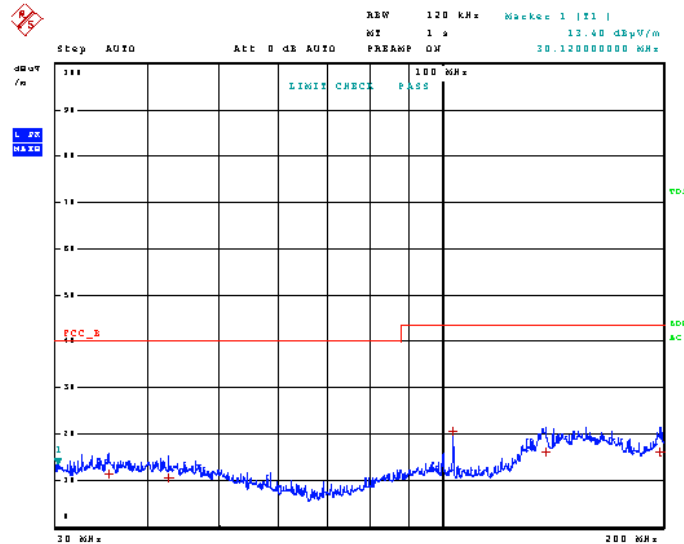



8.1.30 108MHz, 30 MHz to 200 MHz, Horizontal Polarity Table

02.Mar 21 14:30

Test Spec CISPR 22 Radiated Disturbances

Polarity

Vertical

Final Measurement

Meas Time: 1 s
Margin: 25 dB
Subranges: 5

Trace	Frequency	Level (dB μ V/m)	Detector	Delta Limit/dB
1	35.320000000 MHz	11.40	Quasi Peak	-28.60
1	42.600000000 MHz	10.59	Quasi Peak	-29.41
1	103.680000000 MHz	20.69	Quasi Peak	-22.81
1	138.560000000 MHz	16.16	Quasi Peak	-27.34
1	198.080000000 MHz	16.06	Quasi Peak	-27.44

Page 2 of 2

8.1.31 108MHz, 30 MHz to 200 MHz, Vertical Polarity Plot



02 Mar 21 14:31

Test Spec CISPR 22 Radiated Disturbances

Polarity

Vertical

Stepped Scan (1 Range)

Scan Start: 30 MHz
 Scan Stop: 200 MHz
 Detector: Trace 1: MAX PEAK
 Transducer: TDS_01

Start Frequency	Stop Frequency	Step Size	Res BW	Meas Time	RF Atten	Preamp	Input
30.000000 MHz	200.000000 MHz	40.00 kHz	120.00 kHz	50 μ s	Auto	20 dB	INPUT1

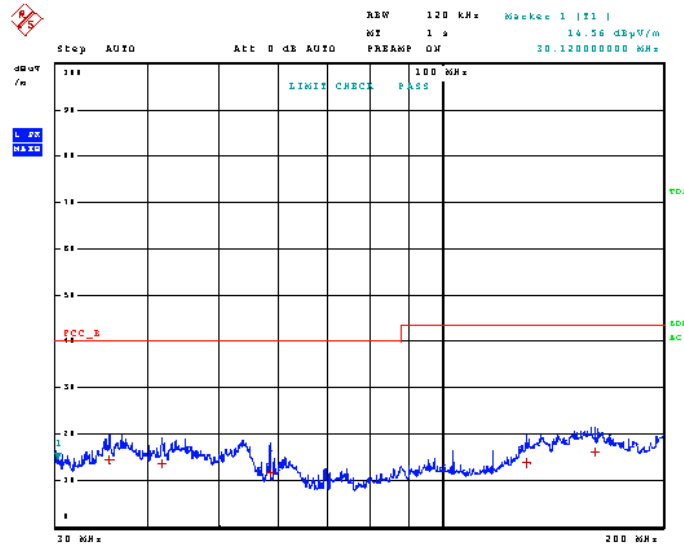



8.1.32 108MHz, 30 MHz to 200 MHz, Vertical Polarity Table

02.Mar 21 14:31

Test Spec CISPR 22 Radiated Disturbances

Polarity

Vertical

Final Measurement

Meas Time: 1 s
Margin: 25 dB
Subranges: 5

Trace	Frequency	Level (dB μ V/m)	Detector	Delta Limit/dB
1	35.400000000 MHz	14.46	Quasi Peak	-25.54
1	41.720000000 MHz	13.62	Quasi Peak	-26.38
1	58.600000000 MHz	11.60	Quasi Peak	-28.40
1	130.120000000 MHz	13.80	Quasi Peak	-29.70
1	161.640000000 MHz	16.00	Quasi Peak	-27.50

8.1.33 108MHz, 200 MHz to 1000 MHz, Horizontal Polarity Plot



02 Mar 21 15:10

Test Spec CISPR 22 Radiated Disturbances

Polarity

Horizontal

Time Domain Scan (1 Range)

Scan Start: 200 MHz
 Scan Stop: 1 GHz
 Detector: Trace 1: MAX PEAK
 Transducer: TDS_01

Start Frequency	Stop Frequency	Step Size	Res BW	Meas Time	RF Atten	Preamp	Input
200.000000 MHz	1.000000 GHz	30.00 kHz	120.00 kHz	50 µs	Auto	20 dB	INPUT1

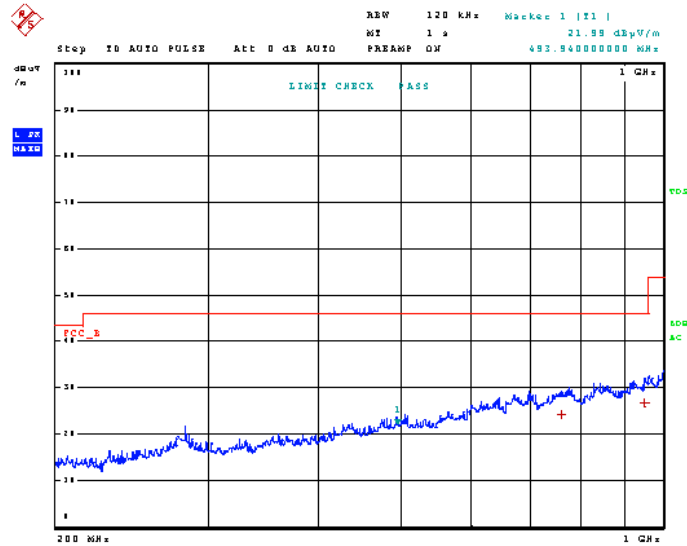



8.1.34 108MHz, 200 MHz to 1000 MHz, Horizontal Polarity Table

02.Mar 21 15:10

Test Spec CISPR 22 Radiated Disturbances

Polarity
Horizontal

Final Measurement

Meas Time: 1 s
Margin: 20 dB
Subranges: 2

Trace	Frequency	Level (dB μ V/m)	Detector	Delta Limit/dB
1	762.770000000 MHz	24.25	Quasi Peak	-21.75
1	953.000000000 MHz	26.84	Quasi Peak	-19.16



8.1.35 108MHz, 200 MHz to 1000 MHz, Vertical Polarity Plot



02 Mar 21 15:18

Test Spec CISPR 22 Radiated Disturbances

Polarity

Horizontal

Time Domain Scan (1 Range)

Scan Start: 200 MHz
 Scan Stop: 1 GHz
 Detector: Trace 1: MAX PEAK
 Transducer: TDS_01

Start Frequency	Stop Frequency	Step Size	Res BW	Meas Time	RF Atten	Preamp	Input
200.000000 MHz	1.000000 GHz	30.00 kHz	120.00 kHz	50 μ s	Auto	20 dB	INPUT1

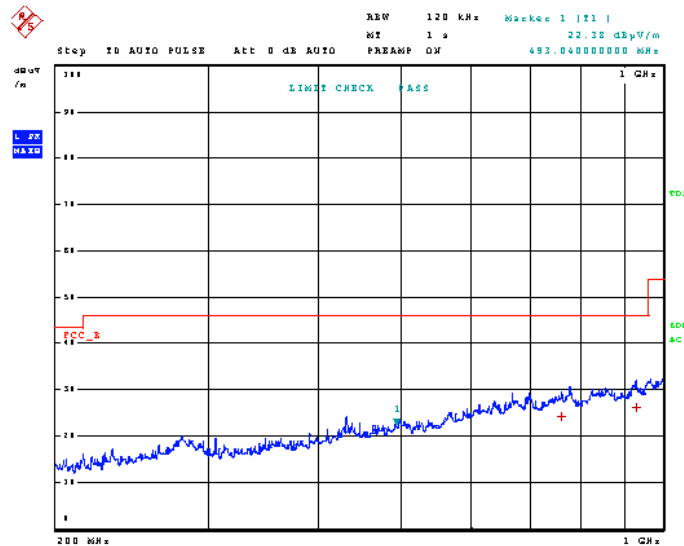



8.1.36 108MHz, 200 MHz to 1000 MHz, Vertical Polarity Table

02.Mar 21 15:18

Test Spec CISPR 22 Radiated Disturbances

Polarity

Horizontal

Final Measurement

Meas Time: 1 s

Margin: 20 dB

Subranges: 2

Trace	Frequency	Level (dB μ V/m)	Detector	Delta Limit/dB
1	762.860000000 MHz	24.26	Quasi Peak	-21.74
1	930.890000000 MHz	26.24	Quasi Peak	-19.76



8.1.37 108MHz, above 1000 MHz, Horizontal Polarity Plot

02.Mar 21 19:34

Time Domain Scan (1 Range)

Scan Start: 1 GHz
 Scan Stop: 12.5 GHz
 Detector: Trace 1: MAX PEAK Trace 2: MAX PEAK
 Transducer: TDS_05

Start Frequency	Stop Frequency	Step Size	Res BW	Meas Time	RF Atten	Preamp	Input
1.000000 GHz	12.500000 GHz	250.00 kHz	1.00 MHz	100 μ s	Auto	35 dB	INPUT1

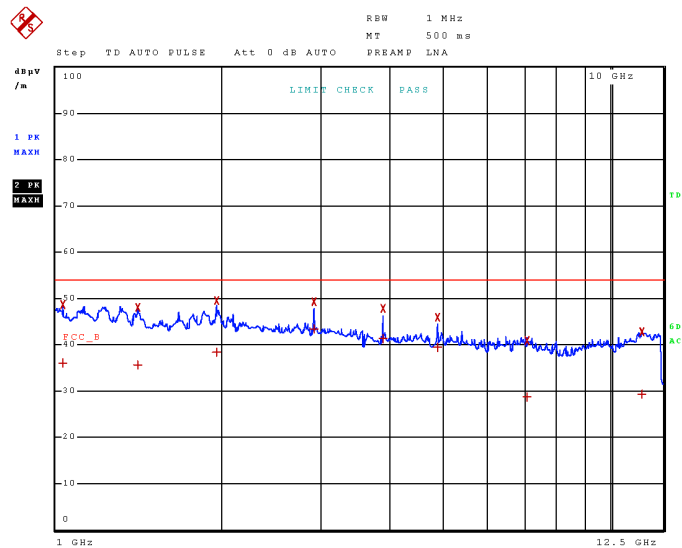



8.1.38 108MHz, above 1000 MHz, Horizontal Polarity Table

02.Mar 21 19:34

Final Measurement

Meas Time: 500 ms
Margin: 40 dB
Subranges: 16

Trace	Frequency	Level (dB μ V/m)	Detector	Delta Limit/dB
1	1.027000000 GHz	35.98	CISPR Averag	-18.02
2	1.027000000 GHz	48.56	Max Peak	
1	1.403500000 GHz	35.55	CISPR Averag	-18.45
2	1.403500000 GHz	47.99	Max Peak	
1	1.951750000 GHz	38.35	CISPR Averag	-15.65
2	1.951750000 GHz	49.42	Max Peak	
1	2.927000000 GHz	43.36	CISPR Averag	-10.64
2	2.927000000 GHz	49.27	Max Peak	
1	3.903000000 GHz	41.26	CISPR Averag	-12.74
2	3.903000000 GHz	47.78	Max Peak	
1	4.878500000 GHz	39.41	CISPR Averag	-14.59
2	4.878500000 GHz	45.99	Max Peak	
1	7.098750000 GHz	28.60	CISPR Averag	-25.40
2	7.098750000 GHz	40.89	Max Peak	
1	11.441750000 GHz	29.35	CISPR Averag	-24.65
2	11.441750000 GHz	42.85	Max Peak	



8.1.39 108MHz, above 1000 MHz, Vertical Polarity Plot

02.Mar 21 19:38

Time Domain Scan (1 Range)

Scan Start: 1 GHz
 Scan Stop: 12.5 GHz
 Detector: Trace 1: MAX PEAK Trace 2: MAX PEAK
 Transducer: TDS_05

Start Frequency	Stop Frequency	Step Size	Res BW	Meas Time	RF Atten	Preamp	Input
1.000000 GHz	12.500000 GHz	250.00 kHz	1.00 MHz	100 µs	Auto	35 dB	INPUT1

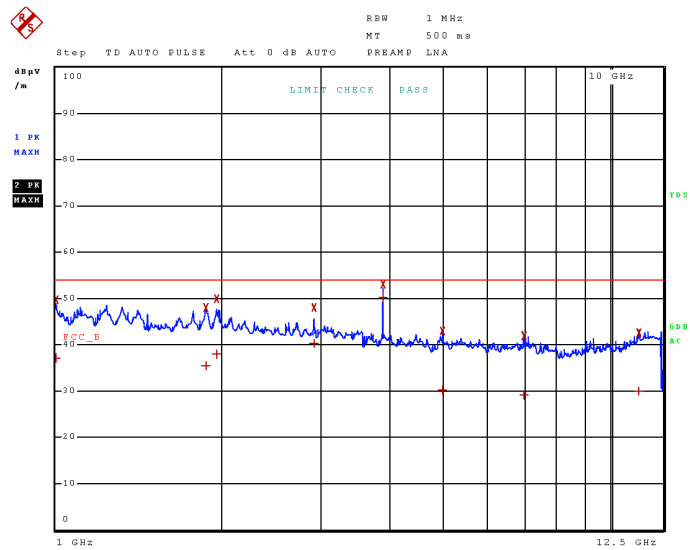



8.1.40 108MHz, above 1000 MHz, Vertical Polarity Table

02.Mar 21 19:38

Final Measurement

Meas Time: 500 ms
 Margin: 40 dB
 Subranges: 16

Trace	Frequency	Level (dBµV/m)	Detector	Delta Limit/dB
1	1.000500000 GHz	37.04	CISPR Averag	-16.96
2	1.000500000 GHz	49.73	Max Peak	
1	1.867250000 GHz	35.32	CISPR Averag	-18.68
2	1.867250000 GHz	47.96	Max Peak	
1	1.951750000 GHz	37.98	CISPR Averag	-16.02
2	1.951750000 GHz	49.82	Max Peak	
1	2.927250000 GHz	40.32	CISPR Averag	-13.68
2	2.927250000 GHz	47.93	Max Peak	
1	3.902750000 GHz	50.06	CISPR Averag	-3.94
2	3.902750000 GHz	53.08	Max Peak	
1	4.995250000 GHz	30.07	CISPR Averag	-23.93
2	4.995250000 GHz	42.94	Max Peak	
1	6.998750000 GHz	29.17	CISPR Averag	-24.83
2	6.998750000 GHz	41.89	Max Peak	
1	11.300750000 GHz	29.97	CISPR Averag	-24.03
2	11.300750000 GHz	42.55	Max Peak	

8.1.41 174MHz, 30 MHz to 200 MHz, Horizontal Polarity Plot



02.Mar 21 14:33

Test Spec CISPR 22 Radiated Disturbances

Polarity

Vertical

Stepped Scan (1 Range)

Scan Start: 30 MHz
 Scan Stop: 200 MHz
 Detector: Trace 1: MAX PEAK
 Transducer: TDS_01

Start Frequency	Stop Frequency	Step Size	Res BW	Meas Time	RF Atten	Preamp	Input
30.000000 MHz	200.000000 MHz	40.00 kHz	120.00 kHz	50 µs	Auto	20 dB	INPUT1

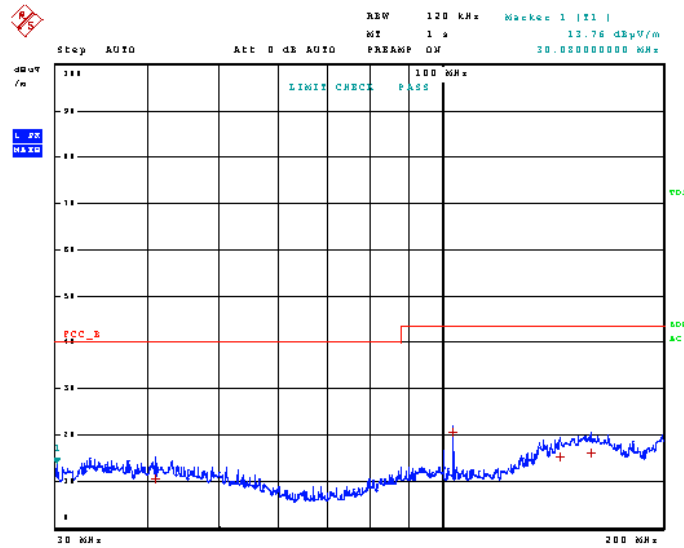



8.1.42 174MHz, 30 MHz to 200 MHz, Horizontal Polarity Table

02.Mar 21 14:33

Test Spec CISPR 22 Radiated Disturbances

Polarity

Vertical

Final Measurement

Meas Time: 1 s
Margin: 25 dB
Subranges: 4

Trace	Frequency	Level (dB μ V/m)	Detector	Delta Limit/dB
1	40.880000000 MHz	10.60	Quasi Peak	-29.40
1	103.640000000 MHz	20.50	Quasi Peak	-23.00
1	144.720000000 MHz	15.28	Quasi Peak	-28.22
1	159.760000000 MHz	16.14	Quasi Peak	-27.36

Page 2 of 2

8.1.43 174MHz, 30 MHz to 200 MHz, Vertical Polarity Plot



02 Mar 21 14:32

Test Spec CISPR 22 Radiated Disturbances

Polarity

Vertical

Stepped Scan (1 Range)

Scan Start: 30 MHz
 Scan Stop: 200 MHz
 Detector: Trace 1: MAX PEAK
 Transducer: TDS_01

Start Frequency	Stop Frequency	Step Size	Res BW	Meas Time	RF Atten	Preamp	Input
30.000000 MHz	200.000000 MHz	40.00 kHz	120.00 kHz	50 μ s	Auto	20 dB	INPUT1

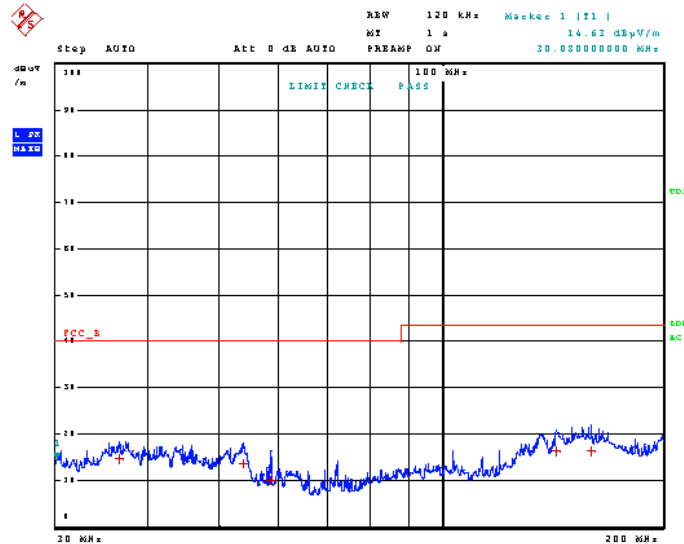



8.1.44 174MHz, 30 MHz to 200 MHz, Vertical Polarity Table

02.Mar 21 14:32

Test Spec CISPR 22 Radiated Disturbances

Polarity

Vertical

Final Measurement

Meas Time: 1 s
Margin: 25 dB
Subranges: 5

Trace	Frequency	Level (dB μ V/m)	Detector	Delta Limit/dB
1	36.520000000 MHz	14.58	Quasi Peak	-25.42
1	53.840000000 MHz	13.56	Quasi Peak	-26.44
1	58.680000000 MHz	9.95	Quasi Peak	-30.05
1	143.280000000 MHz	16.31	Quasi Peak	-27.19
1	159.640000000 MHz	16.25	Quasi Peak	-27.25

8.1.45 174MHz, 200 MHz to 1000 MHz, Horizontal Polarity Plot



02 Mar 21 15:19

Test Spec CISPR 22 Radiated Disturbances

Polarity

Horizontal

Time Domain Scan (1 Range)

Scan Start: 200 MHz
 Scan Stop: 1 GHz
 Detector: Trace 1: MAX PEAK
 Transducer: TDS_01

Start Frequency	Stop Frequency	Step Size	Res BW	Meas Time	RF Atten	Preamp	Input
200.000000 MHz	1.000000 GHz	30.00 kHz	120.00 kHz	50 μ s	Auto	20 dB	INPUT1

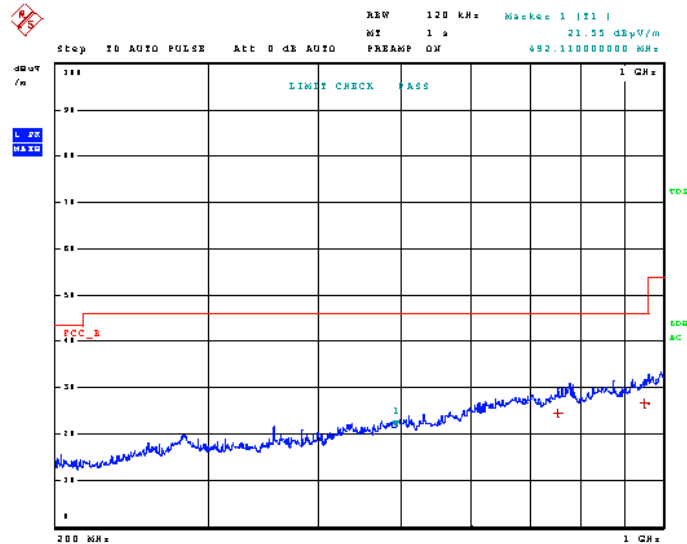



8.1.46 174MHz, 200 MHz to 1000 MHz, Horizontal Polarity Table

02.Mar 21 15:19

Test Spec CISPR 22 Radiated Disturbances

Polarity
Horizontal

Final Measurement

Meas Time: 1 s
Margin: 20 dB
Subranges: 2

Trace	Frequency	Level (dB μ V/m)	Detector	Delta Limit/dB
1	756.230000000 MHz	24.43	Quasi Peak	-21.57
1	951.560000000 MHz	26.64	Quasi Peak	-19.36

8.1.47 174MHz, 200 MHz to 1000 MHz, Vertical Polarity Plot



02 Mar 21 15:19

Test Spec CISPR 22 Radiated Disturbances

Polarity

Horizontal

Time Domain Scan (1 Range)

Scan Start: 200 MHz
 Scan Stop: 1 GHz
 Detector: Trace 1: MAX PEAK
 Transducer: TDS_01

Start Frequency	Stop Frequency	Step Size	Res BW	Meas Time	RF Atten	Preamp	Input
200.000000 MHz	1.000000 GHz	30.00 kHz	120.00 kHz	50 μ s	Auto	20 dB	INPUT1

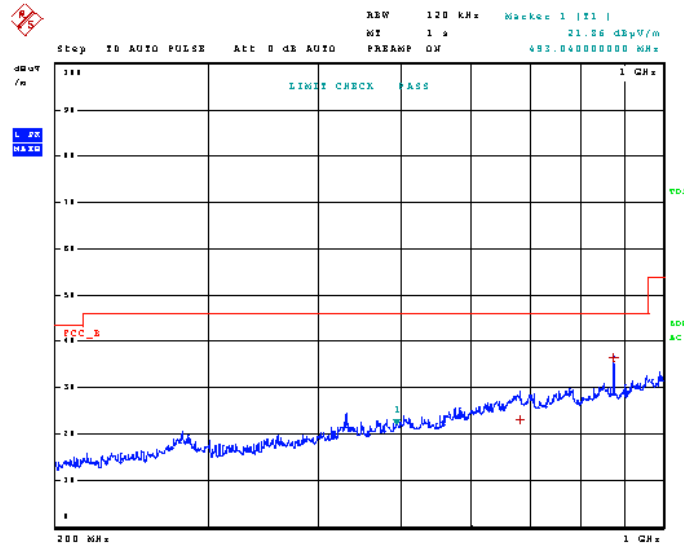



8.1.48 174MHz, 200 MHz to 1000 MHz, Vertical Polarity Table

02.Mar 21 15:19

Test Spec CISPR 22 Radiated Disturbances

Polarity
Horizontal

Final Measurement

Meas Time: 1 s
Margin: 20 dB
Subranges: 2

Trace	Frequency	Level (dB μ V/m)	Detector	Delta Limit/dB
1	685.010000000 MHz	22.91	Quasi Peak	-23.09
1	877.550000000 MHz	36.39	Quasi Peak	-9.61



8.1.49 174MHz, above 1000 MHz, Horizontal Polarity Plot

02.Mar 21 19:40

Time Domain Scan (1 Range)

Scan Start: 1 GHz
 Scan Stop: 12.5 GHz
 Detector: Trace 1: MAX PEAK Trace 2: MAX PEAK
 Transducer: TDS_05

Start Frequency	Stop Frequency	Step Size	Res BW	Meas Time	RF Atten	Preamp	Input
1.000000 GHz	12.500000 GHz	250.00 kHz	1.00 MHz	100 μ s	Auto	35 dB	INPUT1

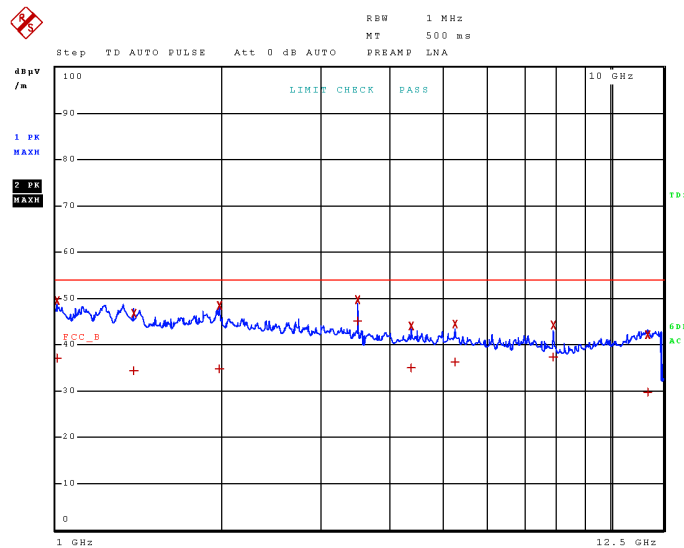



8.1.50 174MHz, above 1000 MHz, Horizontal Polarity Table

02.Mar 21 19:40

Final Measurement

Meas Time: 500 ms
 Margin: 40 dB
 Subranges: 16

Trace	Frequency	Level (dBµV/m)	Detector	Delta Limit/dB
1	1.005500000 GHz	36.98	CISPR Averag	-17.02
2	1.005500000 GHz	49.52	Max Peak	
1	1.381250000 GHz	34.37	CISPR Averag	-19.63
2	1.381250000 GHz	46.81	Max Peak	
1	1.975250000 GHz	34.83	CISPR Averag	-19.17
2	1.975250000 GHz	48.36	Max Peak	
1	3.510250000 GHz	44.98	CISPR Averag	-9.02
2	3.510250000 GHz	49.71	Max Peak	
1	4.387750000 GHz	34.96	CISPR Averag	-19.04
2	4.387750000 GHz	44.04	Max Peak	
1	5.265250000 GHz	36.32	CISPR Averag	-17.68
2	5.265250000 GHz	44.49	Max Peak	
1	7.898000000 GHz	37.34	CISPR Averag	-16.66
2	7.898000000 GHz	44.16	Max Peak	
1	11.718500000 GHz	29.76	CISPR Averag	-24.24
2	11.718500000 GHz	42.15	Max Peak	



8.1.51 174MHz, above 1000 MHz, Vertical Polarity Plot

02.Mar 21 19:39

Time Domain Scan (1 Range)

Scan Start: 1 GHz
Scan Stop: 12.5 GHz
Detector: Trace 1: MAX PEAK Trace 2: MAX PEAK
Transducer: TDS_05

Start Frequency	Stop Frequency	Step Size	Res BW	Meas Time	RF Atten	Preamp	Input
1.000000 GHz	12.500000 GHz	250.00 kHz	1.00 MHz	100 μ s	Auto	35 dB	INPUT1

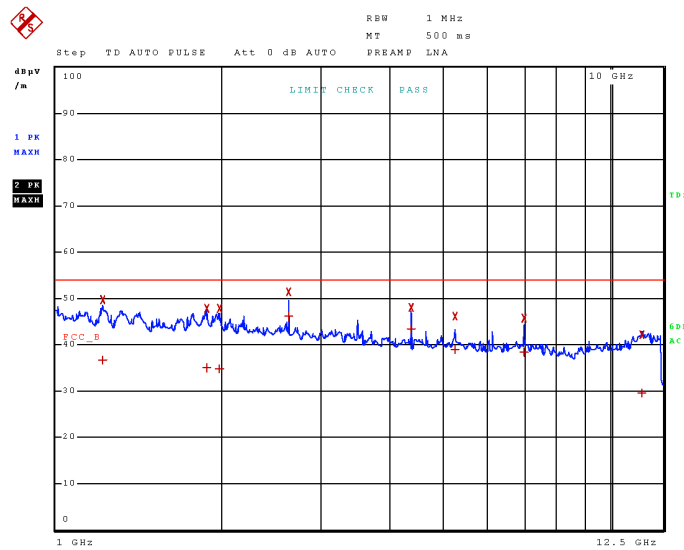



8.1.52 174MHz, above 1000 MHz, Vertical Polarity Table

02.Mar 21 19:39

Final Measurement

Meas Time: 500 ms
Margin: 40 dB
Subranges: 16

Trace	Frequency	Level (dBµV/m)	Detector	Delta Limit/dB
1	1.214250000 GHz	36.67	CISPR Averag	-17.33
2	1.214250000 GHz	49.71	Max Peak	
1	1.872000000 GHz	35.03	CISPR Averag	-18.97
2	1.872000000 GHz	47.72	Max Peak	
1	1.975750000 GHz	34.77	CISPR Averag	-19.23
2	1.975750000 GHz	47.83	Max Peak	
1	2.632750000 GHz	46.16	CISPR Averag	-7.84
2	2.632750000 GHz	51.30	Max Peak	
1	4.387750000 GHz	43.46	CISPR Averag	-10.54
2	4.387750000 GHz	48.02	Max Peak	
1	5.265250000 GHz	38.95	CISPR Averag	-15.05
2	5.265250000 GHz	46.06	Max Peak	
1	7.020500000 GHz	38.25	CISPR Averag	-15.75
2	7.020500000 GHz	45.70	Max Peak	
1	11.421500000 GHz	29.60	CISPR Averag	-24.40
2	11.421500000 GHz	42.22	Max Peak	

8.1.53 406MHz, 30 MHz to 200 MHz, Horizontal Polarity Plot



02.Mar 21 14:34

Test Spec CISPR 22 Radiated Disturbances

Polarity

Vertical

Stepped Scan (1 Range)

Scan Start: 30 MHz
 Scan Stop: 200 MHz
 Detector: Trace 1: MAX PEAK
 Transducer: TDS_01

Start Frequency	Stop Frequency	Step Size	Res BW	Meas Time	RF Atten	Preamp	Input
30.000000 MHz	200.000000 MHz	40.00 kHz	120.00 kHz	50 µs	Auto	20 dB	INPUT1

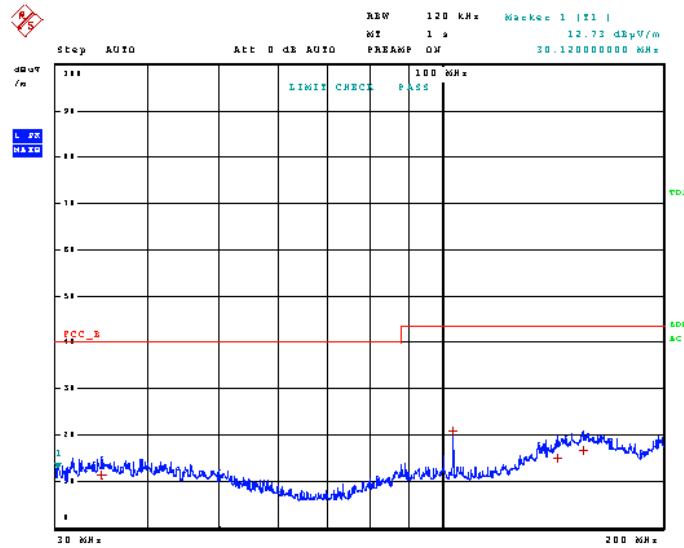



8.1.54 406MHz, 30 MHz to 200 MHz, Horizontal Polarity Table

02.Mar 21 14:34

Test Spec CISPR 22 Radiated Disturbances

Polarity

Vertical

Final Measurement

Meas Time: 1 s
Margin: 25 dB
Subranges: 4

Trace	Frequency	Level (dB μ V/m)	Detector	Delta Limit/dB
1	34.560000000 MHz	11.45	Quasi Peak	-28.55
1	103.680000000 MHz	20.81	Quasi Peak	-22.69
1	143.400000000 MHz	15.01	Quasi Peak	-28.49
1	156.040000000 MHz	16.61	Quasi Peak	-26.89

8.1.55 406MHz, 30 MHz to 200 MHz, Vertical Polarity Plot



02 Mar 21 14:35

Test Spec CISPR 22 Radiated Disturbances

Polarity

Vertical

Stepped Scan (1 Range)

Scan Start: 30 MHz
 Scan Stop: 200 MHz
 Detector: Trace 1: MAX PEAK
 Transducer: TDS_01

Start Frequency	Stop Frequency	Step Size	Res BW	Meas Time	RF Atten	Preamp	Input
30.000000 MHz	200.000000 MHz	40.00 kHz	120.00 kHz	50 μ s	Auto	20 dB	INPUT1

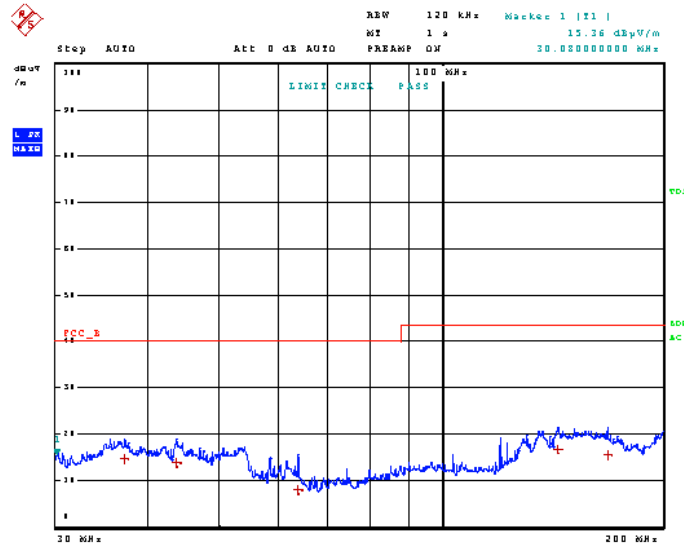



8.1.56 406MHz, 30 MHz to 200 MHz, Vertical Polarity Table

02.Mar 21 14:35

Test Spec CISPR 22 Radiated Disturbances

Polarity

Vertical

Final Measurement

Meas Time: 1 s
Margin: 25 dB
Subranges: 5

Trace	Frequency	Level (dB μ V/m)	Detector	Delta Limit/dB
1	37.120000000 MHz	14.67	Quasi Peak	-25.33
1	43.680000000 MHz	13.85	Quasi Peak	-26.15
1	63.960000000 MHz	7.90	Quasi Peak	-32.10
1	144.080000000 MHz	16.65	Quasi Peak	-26.85
1	168.360000000 MHz	15.37	Quasi Peak	-28.13



8.1.57 406MHz, 200 MHz to 1000 MHz, Horizontal Polarity Plot



02 Mar 21 15:23

Test Spec CISPR 22 Radiated Disturbances

Polarity

Horizontal

Time Domain Scan (1 Range)

Scan Start: 200 MHz
 Scan Stop: 1 GHz
 Detector: Trace 1: MAX PEAK
 Transducer: TDS_01

Start Frequency	Stop Frequency	Step Size	Res BW	Meas Time	RF Atten	Preamp	Input
200.000000 MHz	1.000000 GHz	30.00 kHz	120.00 kHz	50 µs	Auto	20 dB	INPUT1

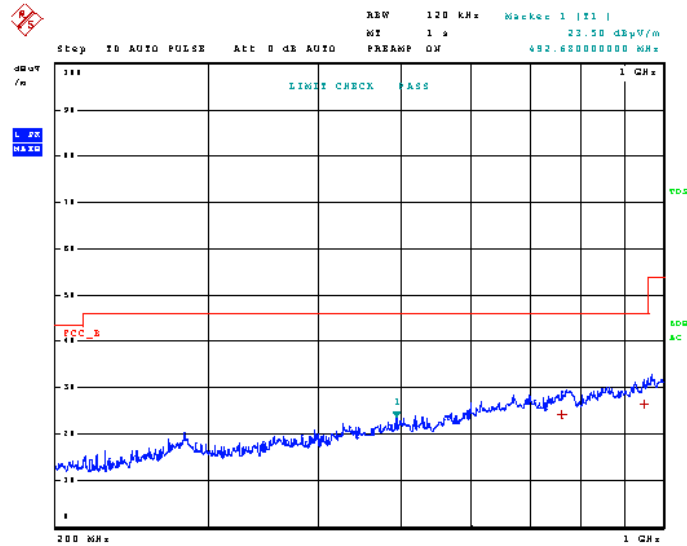



8.1.58 406MHz, 200 MHz to 1000 MHz, Horizontal Polarity Table

02.Mar 21 15:23

Test Spec CISPR 22 Radiated Disturbances

Polarity
Horizontal

Final Measurement

Meas Time: 1 s
Margin: 20 dB
Subranges: 2

Trace	Frequency	Level (dB μ V/m)	Detector	Delta Limit/dB
1	763.820000000 MHz	24.26	Quasi Peak	-21.74
1	949.130000000 MHz	26.31	Quasi Peak	-19.69

8.1.59 406MHz, 200 MHz to 1000 MHz, Vertical Polarity Plot



02 Mar 21 15:24

Test Spec CISPR 22 Radiated Disturbances

Polarity

Horizontal

Time Domain Scan (1 Range)

Scan Start: 200 MHz
 Scan Stop: 1 GHz
 Detector: Trace 1: MAX PEAK
 Transducer: TDS_01

Start Frequency	Stop Frequency	Step Size	Res BW	Meas Time	RF Atten	Preamp	Input
200.000000 MHz	1.000000 GHz	30.00 kHz	120.00 kHz	50 µs	Auto	20 dB	INPUT1

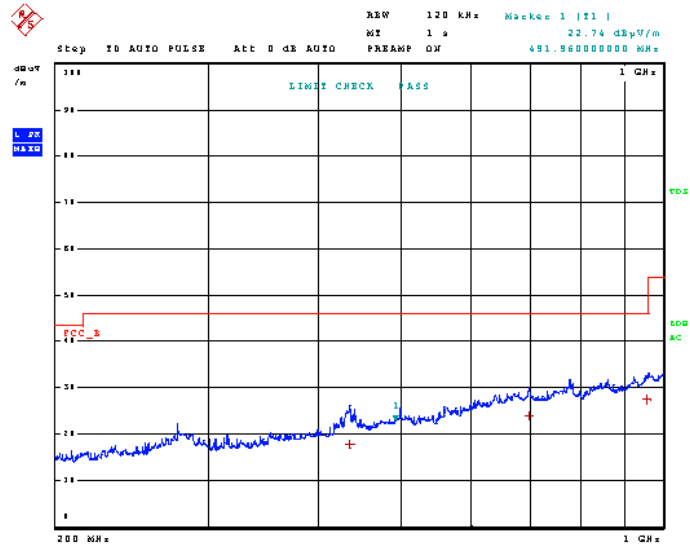



8.1.60 406MHz, 200 MHz to 1000 MHz, Vertical Polarity Table

02.Mar 21 15:24

Test Spec CISPR 22 Radiated Disturbances

Polarity
Horizontal

Final Measurement

Meas Time: 1 s
Margin: 20 dB
Subranges: 3

Trace	Frequency	Level (dB μ V/m)	Detector	Delta Limit/dB
1	436.250000000 MHz	17.80	Quasi Peak	-28.20
1	699.800000000 MHz	23.97	Quasi Peak	-22.03
1	957.110000000 MHz	27.34	Quasi Peak	-18.66



8.1.61 406MHz, above 1000 MHz, Horizontal Polarity Plot

02.Mar 21 19:42

Time Domain Scan (1 Range)

Scan Start: 1 GHz
 Scan Stop: 12.5 GHz
 Detector: Trace 1: MAX PEAK Trace 2: MAX PEAK
 Transducer: TDS_05

Start Frequency	Stop Frequency	Step Size	Res BW	Meas Time	RF Atten	Preamp	Input
1.000000 GHz	12.500000 GHz	250.00 kHz	1.00 MHz	100 μ s	Auto	35 dB	INPUT1

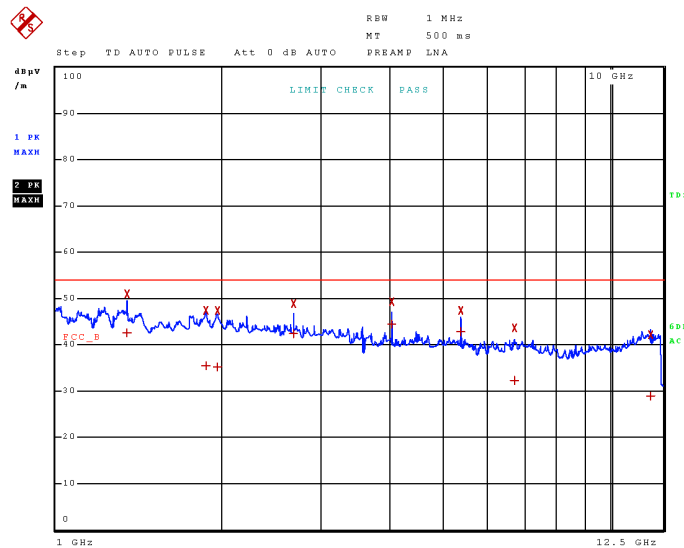



8.1.62 406MHz, above 1000 MHz, Horizontal Polarity Table

02.Mar 21 19:42

Final Measurement

Meas Time: 500 ms
 Margin: 40 dB
 Subranges: 16

Trace	Frequency	Level (dBµV/m)	Detector	Delta Limit/dB
1	1.344750000 GHz	42.46	CISPR Averag	-11.54
2	1.344750000 GHz	51.03	Max Peak	
1	1.867000000 GHz	35.32	CISPR Averag	-18.68
2	1.867000000 GHz	47.43	Max Peak	
1	1.957250000 GHz	35.12	CISPR Averag	-18.88
2	1.957250000 GHz	47.34	Max Peak	
1	2.689750000 GHz	42.43	CISPR Averag	-11.57
2	2.689750000 GHz	48.87	Max Peak	
1	4.034500000 GHz	44.34	CISPR Averag	-9.66
2	4.034500000 GHz	49.22	Max Peak	
1	5.379500000 GHz	42.66	CISPR Averag	-11.34
2	5.379500000 GHz	47.47	Max Peak	
1	6.724250000 GHz	32.28	CISPR Averag	-21.72
2	6.724250000 GHz	43.55	Max Peak	
1	11.861000000 GHz	28.98	CISPR Averag	-25.02
2	11.861000000 GHz	42.07	Max Peak	



8.1.63 406MHz, above 1000 MHz, Vertical Polarity Plot

02.Mar 21 19:45

Time Domain Scan (1 Range)

Scan Start: 1 GHz
 Scan Stop: 12.5 GHz
 Detector: Trace 1: MAX PEAK Trace 2: MAX PEAK
 Transducer: TDS_05

Start Frequency	Stop Frequency	Step Size	Res BW	Meas Time	RF Atten	Preamp	Input
1.000000 GHz	12.500000 GHz	250.00 kHz	1.00 MHz	100 μ s	Auto	35 dB	INPUT1

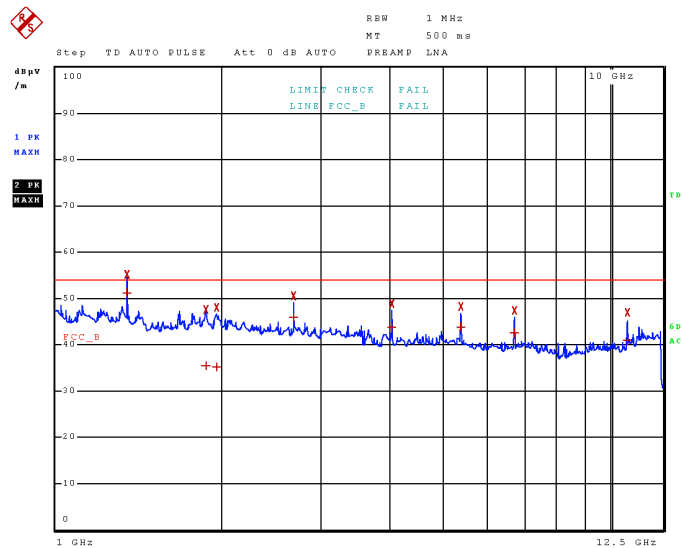



8.1.64 406MHz, above 1000 MHz, Vertical Polarity Table

02.Mar 21 19:45

Final Measurement

Meas Time: 500 ms
Margin: 40 dB
Subranges: 16

Trace	Frequency	Level (dB μ V/m)	Detector	Delta Limit/dB
1	1.344750000 GHz	51.13	CISPR Averag	-2.87
2	1.344750000 GHz	55.23	Max Peak	
1	1.866250000 GHz	35.31	CISPR Averag	-18.69
2	1.866250000 GHz	47.52	Max Peak	
1	1.951000000 GHz	35.18	CISPR Averag	-18.82
2	1.951000000 GHz	48.01	Max Peak	
1	2.689750000 GHz	45.87	CISPR Averag	-8.13
2	2.689750000 GHz	50.58	Max Peak	
1	4.034500000 GHz	43.89	CISPR Averag	-10.11
2	4.034500000 GHz	48.84	Max Peak	
1	5.379500000 GHz	43.81	CISPR Averag	-10.19
2	5.379500000 GHz	48.11	Max Peak	
1	6.724250000 GHz	42.52	CISPR Averag	-11.48
2	6.724250000 GHz	47.47	Max Peak	
1	10.758750000 GHz	40.93	CISPR Averag	-13.07
2	10.758750000 GHz	46.89	Max Peak	



8.1.65 512MHz, 30 MHz to 200 MHz, Horizontal Polarity Plot



02.Mar 21 14:42

Test Spec CISPR 22 Radiated Disturbances

Polarity

Vertical

Stepped Scan (1 Range)

Scan Start: 30 MHz
 Scan Stop: 200 MHz
 Detector: Trace 1: MAX PEAK
 Transducer: TDS_01

Start Frequency	Stop Frequency	Step Size	Res BW	Meas Time	RF Atten	Preamp	Input
30.000000 MHz	200.000000 MHz	40.00 kHz	120.00 kHz	50 µs	Auto	20 dB	INPUT1

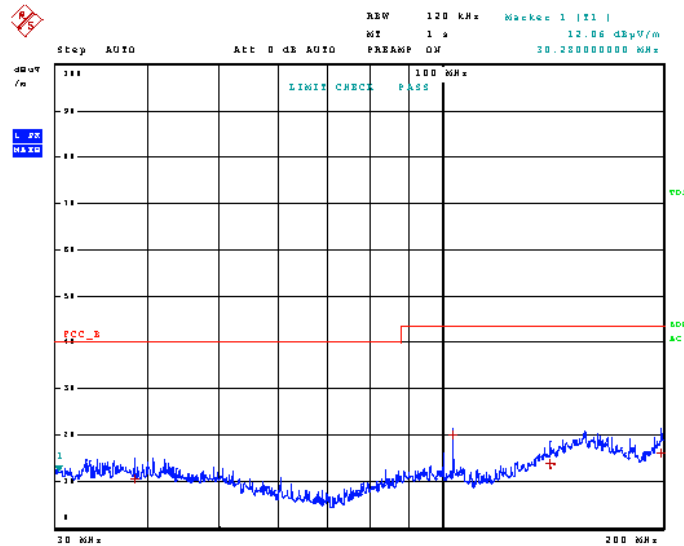



8.1.66 512MHz, 30 MHz to 200 MHz, Horizontal Polarity Table

02.Mar 21 14:42

Test Spec CISPR 22 Radiated Disturbances

Polarity

Vertical

Final Measurement

Meas Time: 1 s
Margin: 25 dB
Subranges: 4

Trace	Frequency	Level (dB μ V/m)	Detector	Delta Limit/dB
1	38.280000000 MHz	10.71	Quasi Peak	-29.29
1	103.640000000 MHz	20.16	Quasi Peak	-23.34
1	140.600000000 MHz	13.80	Quasi Peak	-29.70
1	198.760000000 MHz	16.09	Quasi Peak	-27.41

8.1.67 512MHz, 30 MHz to 200 MHz, Vertical Polarity Plot



02 Mar 21 14:36

Test Spec CISPR 22 Radiated Disturbances

Polarity

Vertical

Stepped Scan (1 Range)

Scan Start: 30 MHz
 Scan Stop: 200 MHz
 Detector: Trace 1: MAX PEAK
 Transducer: TDS_01

Start Frequency	Stop Frequency	Step Size	Res BW	Meas Time	RF Atten	Preamp	Input
30.000000 MHz	200.000000 MHz	40.00 kHz	120.00 kHz	50 µs	Auto	20 dB	INPUT1

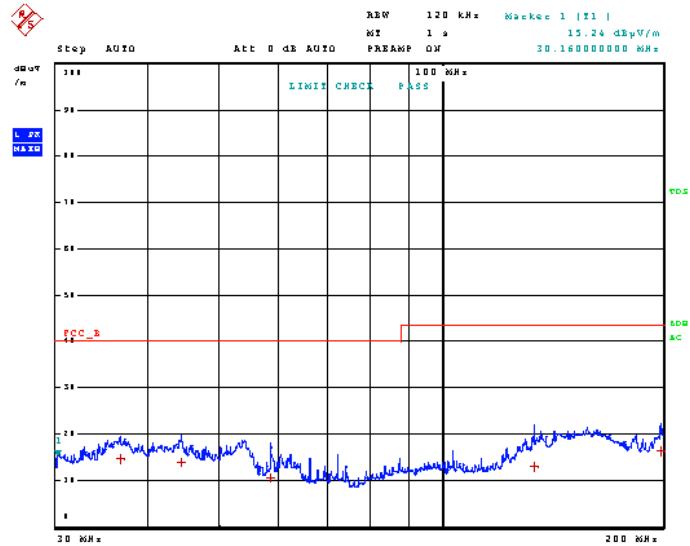



8.1.68 512MHz, 30 MHz to 200 MHz, Vertical Polarity Table

02.Mar 21 14:36

Test Spec CISPR 22 Radiated Disturbances

Polarity

Vertical

Final Measurement

Meas Time: 1 s
Margin: 25 dB
Subranges: 5

Trace	Frequency	Level (dB μ V/m)	Detector	Delta Limit/dB
1	36.680000000 MHz	14.61	Quasi Peak	-25.39
1	44.400000000 MHz	13.90	Quasi Peak	-26.10
1	58.440000000 MHz	10.70	Quasi Peak	-29.30
1	133.480000000 MHz	13.02	Quasi Peak	-30.48
1	198.800000000 MHz	16.19	Quasi Peak	-27.31

8.1.69 512MHz, 200 MHz to 1000 MHz, Horizontal Polarity Plot



02 Mar 21 15:34

Test Spec CISPR 22 Radiated Disturbances

Polarity

Horizontal

Time Domain Scan (1 Range)

Scan Start: 200 MHz
 Scan Stop: 1 GHz
 Detector: Trace 1: MAX PEAK
 Transducer: TDS_01

Start Frequency	Stop Frequency	Step Size	Res BW	Meas Time	RF Atten	Preamp	Input
200.000000 MHz	1.000000 GHz	30.00 kHz	120.00 kHz	50 μ s	Auto	20 dB	INPUT1

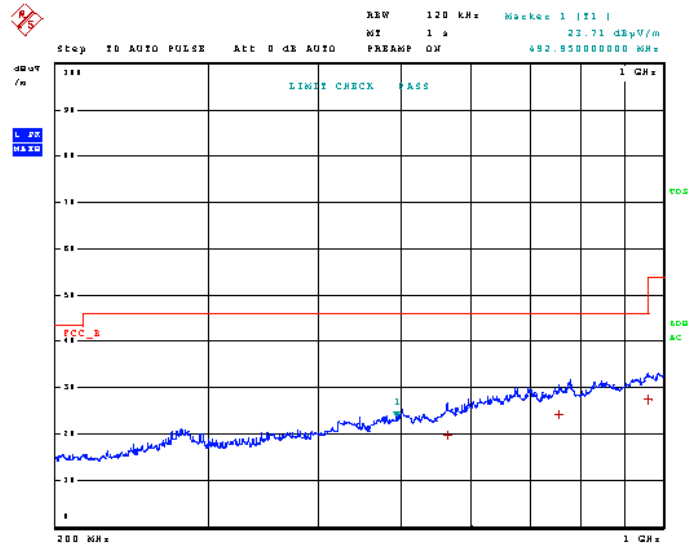



8.1.70 512MHz, 200 MHz to 1000 MHz, Horizontal Polarity Table

02.Mar 21 15:34

Test Spec CISPR 22 Radiated Disturbances

Polarity
Horizontal

Final Measurement

Meas Time: 1 s
Margin: 20 dB
Subranges: 3

Trace	Frequency	Level (dB μ V/m)	Detector	Delta Limit/dB
1	563.450000000 MHz	19.92	Quasi Peak	-26.08
1	758.510000000 MHz	24.33	Quasi Peak	-21.67
1	959.090000000 MHz	27.47	Quasi Peak	-18.53

8.1.71 512MHz, 200 MHz to 1000 MHz, Vertical Polarity Plot



02 Mar 21 15:26

Test Spec CISPR 22 Radiated Disturbances

Polarity

Horizontal

Time Domain Scan (1 Range)

Scan Start: 200 MHz
 Scan Stop: 1 GHz
 Detector: Trace 1: MAX PEAK
 Transducer: TDS_01

Start Frequency	Stop Frequency	Step Size	Res BW	Meas Time	RF Atten	Preamp	Input
200.000000 MHz	1.000000 GHz	30.00 kHz	120.00 kHz	50 µs	Auto	20 dB	INPUT1

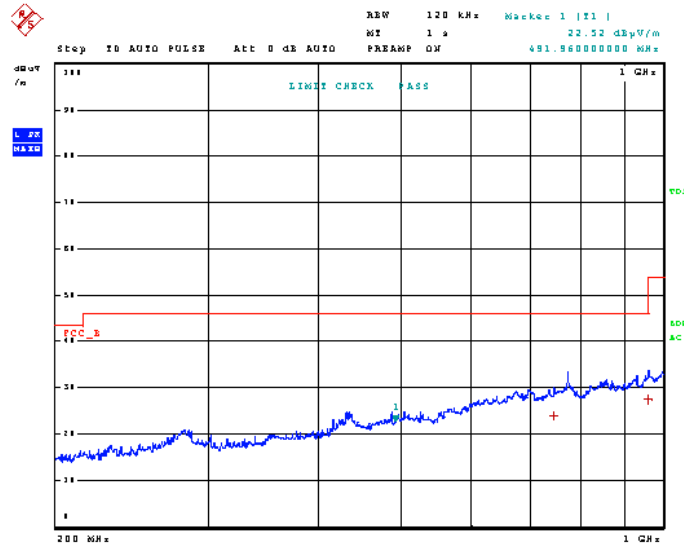



8.1.72 512MHz, 200 MHz to 1000 MHz, Vertical Polarity Table

02.Mar 21 15:26

Test Spec CISPR 22 Radiated Disturbances

Polarity

Horizontal

Final Measurement

Meas Time: 1 s
Margin: 20 dB
Subranges: 2

Trace	Frequency	Level (dB μ V/m)	Detector	Delta Limit/dB
1	746.450000000 MHz	23.85	Quasi Peak	-22.15
1	958.880000000 MHz	27.52	Quasi Peak	-18.48



8.1.73 512MHz, above 1000 MHz, Horizontal Polarity Plot

02.Mar 21 19:47

Time Domain Scan (1 Range)

Scan Start: 1 GHz
 Scan Stop: 12.5 GHz
 Detector: Trace 1: MAX PEAK Trace 2: MAX PEAK
 Transducer: TDS_05

Start Frequency	Stop Frequency	Step Size	Res BW	Meas Time	RF Atten	Preamp	Input
1.000000 GHz	12.500000 GHz	250.00 kHz	1.00 MHz	100 μ s	Auto	35 dB	INPUT1

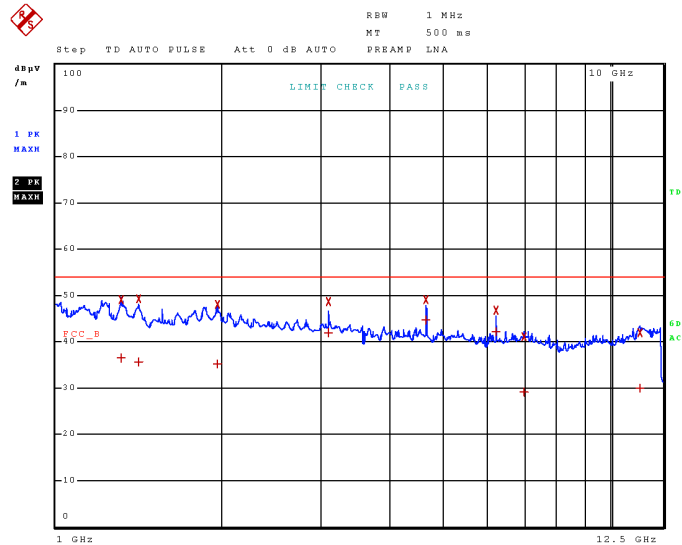



8.1.74 512MHz, above 1000 MHz, Horizontal Polarity Table

02.Mar 21 19:47

Final Measurement

Meas Time: 500 ms
 Margin: 40 dB
 Subranges: 16

Trace	Frequency	Level (dBµV/m)	Detector	Delta Limit/dB
1	1.311000000 GHz	36.37	CISPR Averag	-17.63
2	1.311000000 GHz	49.11	Max Peak	
1	1.408000000 GHz	35.51	CISPR Averag	-18.49
2	1.408000000 GHz	49.29	Max Peak	
1	1.959250000 GHz	35.20	CISPR Averag	-18.80
2	1.959250000 GHz	47.91	Max Peak	
1	3.109750000 GHz	42.00	CISPR Averag	-12.00
2	3.109750000 GHz	48.59	Max Peak	
1	4.664750000 GHz	44.70	CISPR Averag	-9.30
2	4.664750000 GHz	49.13	Max Peak	
1	6.219750000 GHz	42.09	CISPR Averag	-11.91
2	6.219750000 GHz	46.82	Max Peak	
1	6.998000000 GHz	29.16	CISPR Averag	-24.84
2	6.998000000 GHz	41.10	Max Peak	
1	11.320750000 GHz	29.87	CISPR Averag	-24.13
2	11.320750000 GHz	41.93	Max Peak	



8.1.75 512MHz, above 1000 MHz, Vertical Polarity Plot

02.Mar 21 19:46

Time Domain Scan (1 Range)

Scan Start: 1 GHz
 Scan Stop: 12.5 GHz
 Detector: Trace 1: MAX PEAK Trace 2: MAX PEAK
 Transducer: TDS_05

Start Frequency	Stop Frequency	Step Size	Res BW	Meas Time	RF Atten	Preamp	Input
1.000000 GHz	12.500000 GHz	250.00 kHz	1.00 MHz	100 μ s	Auto	35 dB	INPUT1

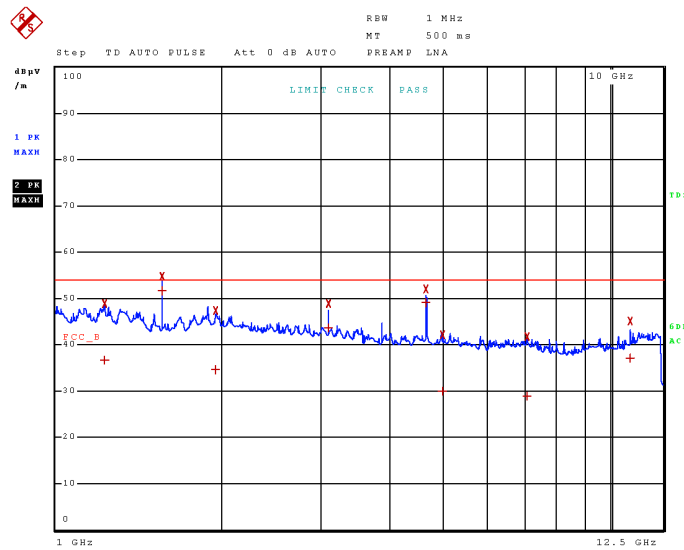



8.1.76 512MHz, above 1000 MHz, Vertical Polarity Table

02.Mar 21 19:46

Final Measurement

Meas Time: 500 ms
Margin: 40 dB
Subranges: 16

Trace	Frequency	Level (dBµV/m)	Detector	Delta Limit/dB
1	1.224750000 GHz	36.73	CISPR Averag	-17.27
2	1.224750000 GHz	48.81	Max Peak	
1	1.555000000 GHz	51.65	CISPR Averag	-2.35
2	1.555000000 GHz	54.78	Max Peak	
1	1.939000000 GHz	34.63	CISPR Averag	-19.37
2	1.939000000 GHz	47.33	Max Peak	
1	3.110000000 GHz	43.55	CISPR Averag	-10.45
2	3.110000000 GHz	48.94	Max Peak	
1	4.664750000 GHz	49.08	CISPR Averag	-4.92
2	4.664750000 GHz	51.97	Max Peak	
1	4.994500000 GHz	29.98	CISPR Averag	-24.02
2	4.994500000 GHz	42.22	Max Peak	
1	7.104500000 GHz	28.80	CISPR Averag	-25.20
2	7.104500000 GHz	41.60	Max Peak	
1	10.884500000 GHz	37.17	CISPR Averag	-16.83
2	10.884500000 GHz	44.98	Max Peak	

8.2 Conducted Emissions

Limits from FCC 15.107 and test procedure from ANSI C63.4-2014.

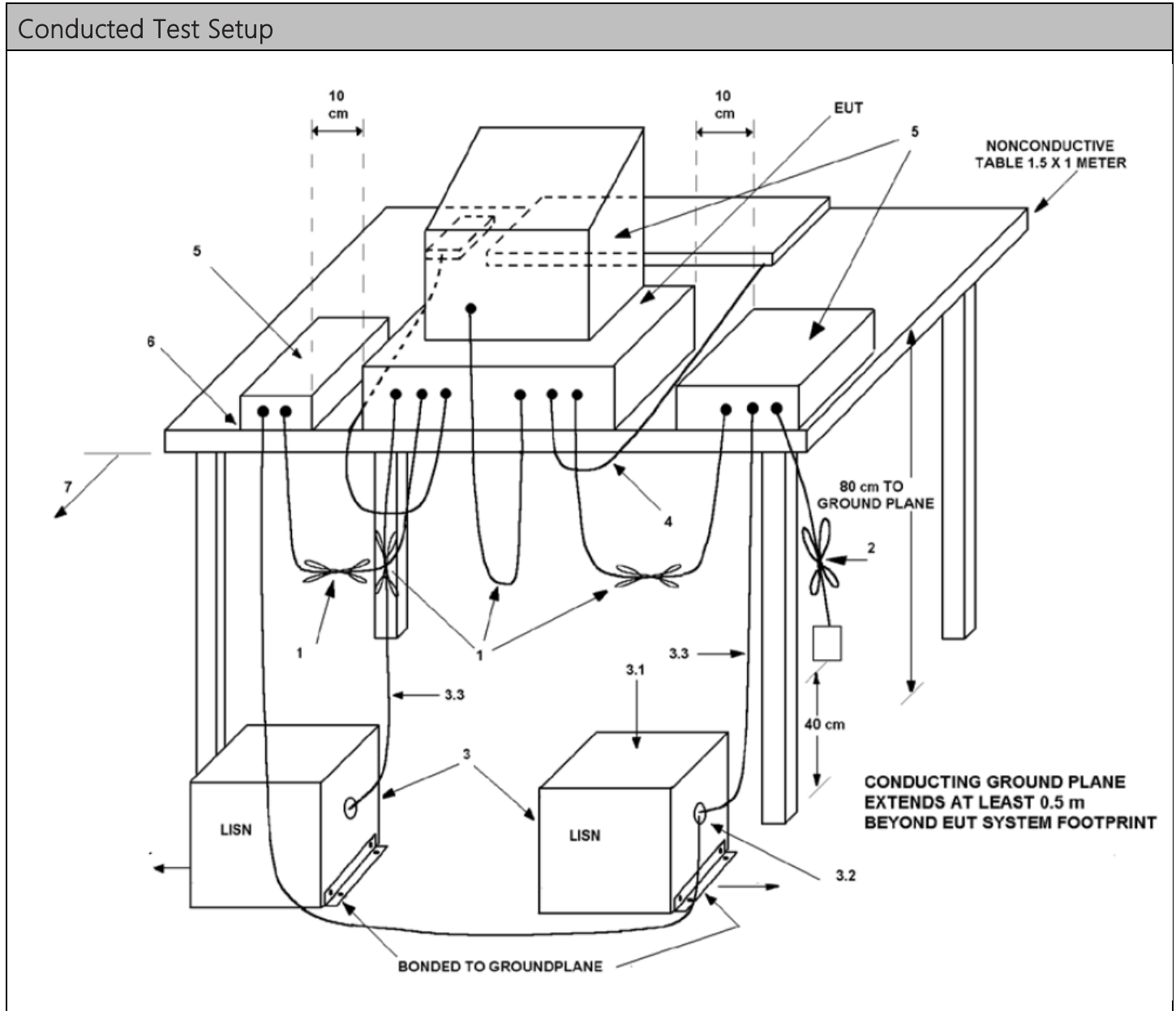



8.2.1 Scanning, Line 1 Plot

01.Mar 21 18:22

Time Domain Scan (1 Range)

Scan Start: 150 kHz
 Scan Stop: 30 MHz
 Detector: Trace 1: MAX PEAK Trace 2: Average
 Transducer: tdf_20

Start Frequency	Stop Frequency	Step Size	Res BW	Meas Time	RF Atten	Preamp	Input
150.000000 kHz	30.000000 MHz	2.25 kHz	9.00 kHz	500 ms	Auto	0 dB	INPUT2

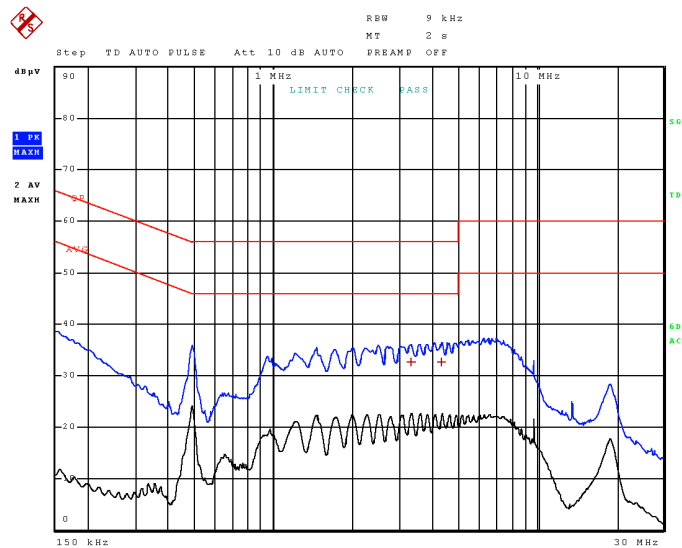

Final Measurement

Meas Time: 2 s
 Margin: 20 dB
 Subranges: 2

Trace	Frequency	Level (dBμV)	Detector	Delta Limit/dB
1	3.318000000 MHz	32.58	Quasi Peak	-23.42
1	4.341750000 MHz	32.58	Quasi Peak	-23.42



8.2.2 Scanning, Line 2 Plot

01.Mar 21 18:27

Time Domain Scan (1 Range)

Scan Start: 150 kHz
Scan Stop: 30 MHz
Detector: Trace 1: MAX PEAK Trace 2: Average
Transducer: tdf_20

Start Frequency	Stop Frequency	Step Size	Res BW	Meas Time	RF Atten	Preamp	Input
150.000000 kHz	30.000000 MHz	2.25 kHz	9.00 kHz	500 ms	Auto	0 dB	INPUT2

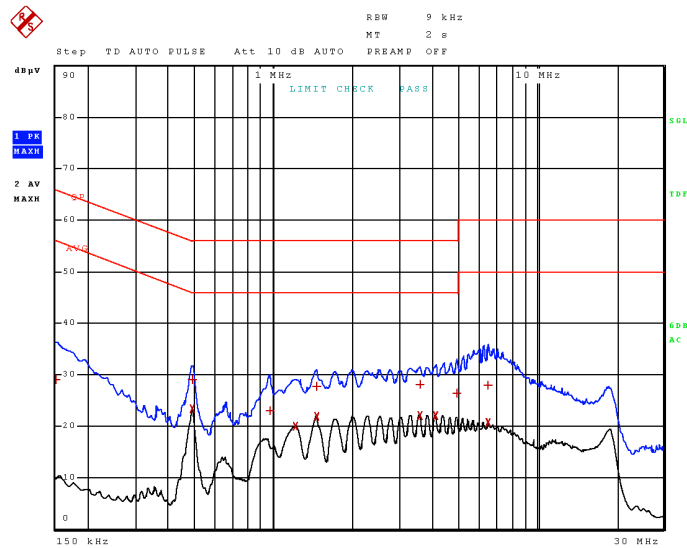

Page 1 of 2



8.2.3 Scanning, Line 2 Table

01.Mar 21 18:27

Final Measurement

Meas Time: 2 s
 Margin: 30 dB
 Subranges: 13

Trace	Frequency	Level (dBµV)	Detector	Delta Limit/dB
1	150.00000000 kHz	28.94	Quasi Peak	-37.06
1	492.00000000 kHz	29.08	Quasi Peak	-27.06
2	492.00000000 kHz	23.40	Average	-22.74
1	969.00000000 kHz	22.92	Quasi Peak	-33.08
2	1.21200000 MHz	19.91	Average	-26.09
2	1.45275000 MHz	21.75	Average	-24.25
1	1.45725000 MHz	27.71	Quasi Peak	-28.29
2	3.58350000 MHz	22.08	Average	-23.92
1	3.59025000 MHz	28.00	Quasi Peak	-28.00
2	4.10775000 MHz	22.05	Average	-23.95
1	4.96950000 MHz	26.47	Quasi Peak	-29.53
2	6.50400000 MHz	20.76	Average	-29.24
1	6.51975000 MHz	27.84	Quasi Peak	-32.16

Transducer Table

Name: tdf_20
 Interpolation: LIN
 Comment: ANS 25/2 Primary LISN IL Line 1 + Coax Cable IL

Frequency	Factor (dB)
150.00 kHz	0.19
170.00 kHz	0.17
200.00 kHz	0.16
250.00 kHz	0.13
300.00 kHz	0.12
350.00 kHz	0.12
400.00 kHz	0.11
500.00 kHz	0.12
600.00 kHz	0.12
700.00 kHz	0.11
800.00 kHz	0.13
900.00 kHz	0.12
1.00 MHz	0.21
1.20 MHz	0.22
1.50 MHz	0.28
2.00 MHz	0.37
2.50 MHz	0.41
3.00 MHz	0.59
4.00 MHz	0.40
5.00 MHz	0.47
7.00 MHz	0.63
10.00 MHz	0.88
15.00 MHz	1.08
20.00 MHz	1.01
30.00 MHz	1.80



8.2.4 25MHz, Line 1 Plot

01.Mar 21 18:35

Time Domain Scan (1 Range)

Scan Start: 150 kHz
Scan Stop: 30 MHz
Detector: Trace 1: MAX PEAK Trace 2: Average
Transducer: tdf_20

Start Frequency	Stop Frequency	Step Size	Res BW	Meas Time	RF Atten	Preamp	Input
150.000000 kHz	30.000000 MHz	2.25 kHz	9.00 kHz	500 ms	Auto	0 dB	INPUT2

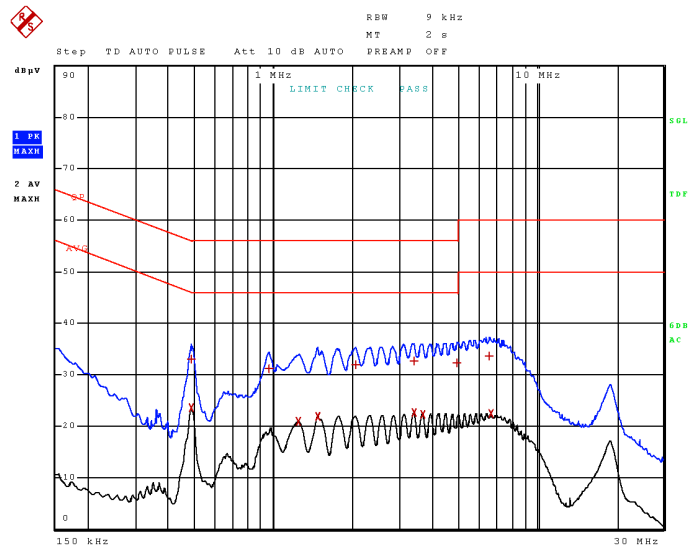



8.2.5 25MHz, Line 1 Table

01.Mar 21 18:35

Final Measurement

Meas Time: 2 s
 Margin: 30 dB
 Subranges: 12

Trace	Frequency	Level (dBμV)	Detector	Delta Limit/dB
1	487.500000000 kHz	32.92	Quasi Peak	-23.29
2	487.500000000 kHz	23.58	Average	-22.63
1	957.750000000 kHz	31.07	Quasi Peak	-24.93
2	1.241250000 MHz	20.83	Average	-25.17
2	1.470750000 MHz	21.87	Average	-24.13
1	2.042250000 MHz	31.90	Quasi Peak	-24.10
1	3.401250000 MHz	32.54	Quasi Peak	-23.46
2	3.403500000 MHz	22.57	Average	-23.43
2	3.666750000 MHz	22.28	Average	-23.72
1	4.967250000 MHz	32.32	Quasi Peak	-23.68
1	6.587250000 MHz	33.48	Quasi Peak	-26.52
2	6.686250000 MHz	22.33	Average	-27.67

Transducer Table

Name: tdf_20
 Interpolation: LIN
 Comment: ANS 25/2 Primary LISN IL Line 1 + Coax Cable IL

Frequency	Factor (dB)
150.00 kHz	0.19
170.00 kHz	0.17
200.00 kHz	0.16
250.00 kHz	0.13
300.00 kHz	0.12
350.00 kHz	0.12
400.00 kHz	0.11
500.00 kHz	0.12
600.00 kHz	0.12
700.00 kHz	0.11
800.00 kHz	0.13
900.00 kHz	0.12
1.00 MHz	0.21
1.20 MHz	0.22
1.50 MHz	0.28
2.00 MHz	0.37
2.50 MHz	0.41
3.00 MHz	0.59
4.00 MHz	0.40
5.00 MHz	0.47
7.00 MHz	0.63
10.00 MHz	0.88
15.00 MHz	1.08
20.00 MHz	1.01
30.00 MHz	1.80



8.2.6 25MHz, Line 2 Plot

01.Mar 21 18:32

Time Domain Scan (1 Range)

Scan Start: 150 kHz
Scan Stop: 30 MHz
Detector: Trace 1: MAX PEAK Trace 2: Average
Transducer: tdf_20

Start Frequency	Stop Frequency	Step Size	Res BW	Meas Time	RF Atten	Preamp	Input
150.000000 kHz	30.000000 MHz	2.25 kHz	9.00 kHz	500 ms	Auto	0 dB	INPUT2

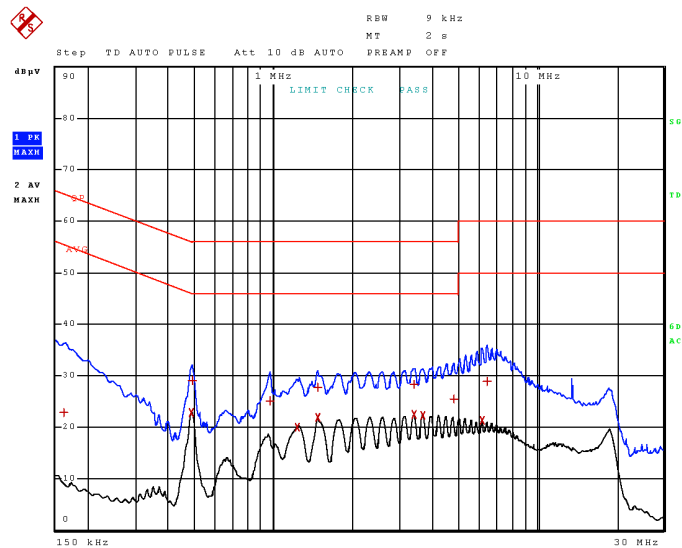



8.2.7 25MHz, Line 2 Table

01.Mar 21 18:32

Final Measurement

Meas Time: 2 s
 Margin: 30 dB
 Subranges: 13

Trace	Frequency	Level (dBµV)	Detector	Delta Limit/dB
1	161.250000000 kHz	22.84	Quasi Peak	-42.56
2	487.500000000 kHz	22.85	Average	-23.36
1	489.750000000 kHz	29.04	Quasi Peak	-27.13
1	966.750000000 kHz	25.11	Quasi Peak	-30.89
2	1.234500000 MHz	19.97	Average	-26.03
1	1.464000000 MHz	27.71	Quasi Peak	-28.29
2	1.470750000 MHz	21.76	Average	-24.24
1	3.396750000 MHz	28.22	Quasi Peak	-27.78
2	3.401250000 MHz	22.48	Average	-23.52
2	3.675750000 MHz	22.27	Average	-23.73
1	4.834500000 MHz	25.40	Quasi Peak	-30.60
2	6.164250000 MHz	21.26	Average	-28.74
1	6.441000000 MHz	28.84	Quasi Peak	-31.16

Transducer Table

Name: tdf_20
 Interpolation: LIN
 Comment: ANS 25/2 Primary LISN IL Line 1 + Coax Cable IL

Frequency	Factor (dB)
150.00 kHz	0.19
170.00 kHz	0.17
200.00 kHz	0.16
250.00 kHz	0.13
300.00 kHz	0.12
350.00 kHz	0.12
400.00 kHz	0.11
500.00 kHz	0.12
600.00 kHz	0.12
700.00 kHz	0.11
800.00 kHz	0.13
900.00 kHz	0.12
1.00 MHz	0.21
1.20 MHz	0.22
1.50 MHz	0.28
2.00 MHz	0.37
2.50 MHz	0.41
3.00 MHz	0.59
4.00 MHz	0.40
5.00 MHz	0.47
7.00 MHz	0.63
10.00 MHz	0.88
15.00 MHz	1.08
20.00 MHz	1.01
30.00 MHz	1.80



8.2.8 54MHz, Line 1 Plot

01.Mar 21 18:37

Time Domain Scan (1 Range)

Scan Start: 150 kHz
Scan Stop: 30 MHz
Detector: Trace 1: MAX PEAK Trace 2: Average
Transducer: tdf_20

Start Frequency	Stop Frequency	Step Size	Res BW	Meas Time	RF Atten	Preamp	Input
150.000000 kHz	30.000000 MHz	2.25 kHz	9.00 kHz	500 ms	Auto	0 dB	INPUT2

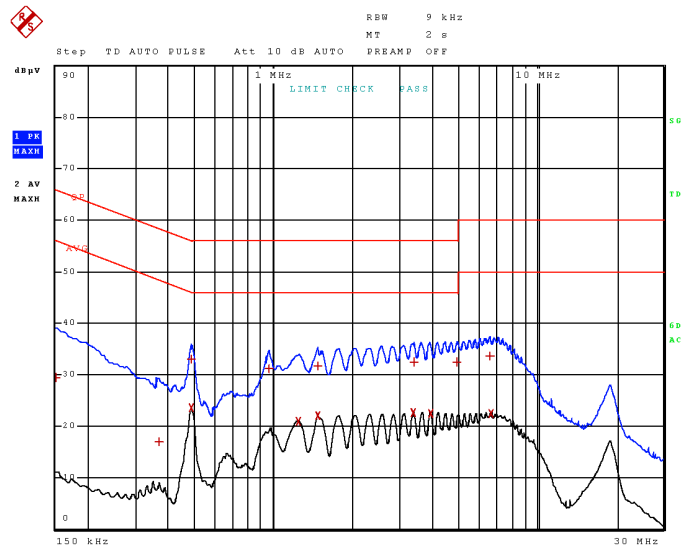



8.2.9 54MHz, Line 1 Table

01.Mar 21 18:37

Final Measurement

Meas Time: 2 s
 Margin: 30 dB
 Subranges: 14

Trace	Frequency	Level (dBµV)	Detector	Delta Limit/dB
1	150.00000000 kHz	29.49	Quasi Peak	-36.51
1	366.00000000 kHz	16.87	Quasi Peak	-41.72
1	487.50000000 kHz	32.96	Quasi Peak	-23.25
2	487.50000000 kHz	23.57	Average	-22.64
1	957.75000000 kHz	31.09	Quasi Peak	-24.91
2	1.239000000 MHz	20.91	Average	-25.09
1	1.468500000 MHz	31.76	Quasi Peak	-24.24
2	1.470750000 MHz	22.02	Average	-23.98
2	3.392250000 MHz	22.56	Average	-23.44
1	3.401250000 MHz	32.49	Quasi Peak	-23.51
2	3.941250000 MHz	22.39	Average	-23.61
1	4.947000000 MHz	32.49	Quasi Peak	-23.51
1	6.600750000 MHz	33.55	Quasi Peak	-26.45
2	6.675000000 MHz	22.43	Average	-27.57

Transducer Table

Name: tdf_20
 Interpolation: LIN
 Comment: ANS 25/2 Primary LISN IL Line 1 + Coax Cable IL

Frequency	Factor (dB)
150.00 kHz	0.19
170.00 kHz	0.17
200.00 kHz	0.16
250.00 kHz	0.13
300.00 kHz	0.12
350.00 kHz	0.12
400.00 kHz	0.11
500.00 kHz	0.12
600.00 kHz	0.12
700.00 kHz	0.11
800.00 kHz	0.13
900.00 kHz	0.12
1.00 MHz	0.21
1.20 MHz	0.22
1.50 MHz	0.28
2.00 MHz	0.37
2.50 MHz	0.41
3.00 MHz	0.59
4.00 MHz	0.40
5.00 MHz	0.47
7.00 MHz	0.63
10.00 MHz	0.88
15.00 MHz	1.08
20.00 MHz	1.01
30.00 MHz	1.80



8.2.10 54MHz, Line 2 Plot

01.Mar 21 18:40

Time Domain Scan (1 Range)

Scan Start: 150 kHz
Scan Stop: 30 MHz
Detector: Trace 1: MAX PEAK Trace 2: Average
Transducer: tdf_20

Start Frequency	Stop Frequency	Step Size	Res BW	Meas Time	RF Atten	Preamp	Input
150.000000 kHz	30.000000 MHz	2.25 kHz	9.00 kHz	500 ms	Auto	0 dB	INPUT2

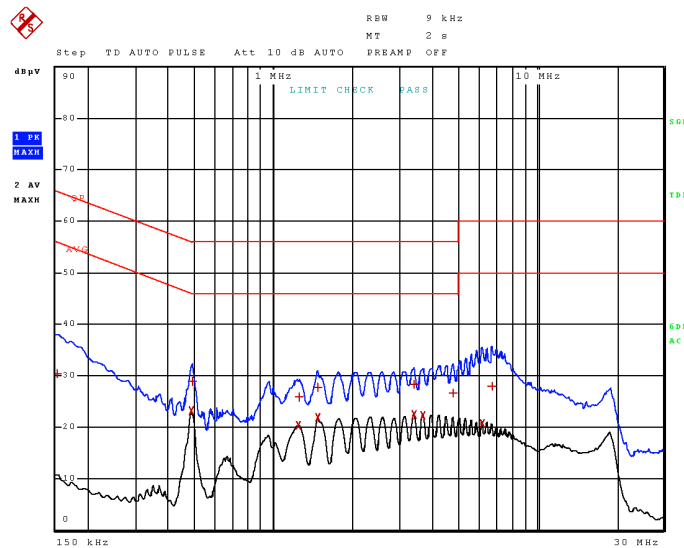



8.2.11 54MHz, Line 2 Table

01.Mar 21 18:40

Final Measurement

Meas Time: 2 s
 Margin: 30 dB
 Subranges: 13

Trace	Frequency	Level (dBµV)	Detector	Delta Limit/dB
1	152.250000000 kHz	30.36	Quasi Peak	-35.52
2	487.500000000 kHz	23.10	Average	-23.11
1	492.000000000 kHz	28.80	Quasi Peak	-27.33
2	1.243500000 MHz	20.23	Average	-25.77
1	1.245750000 MHz	25.84	Quasi Peak	-30.16
1	1.466250000 MHz	27.78	Quasi Peak	-28.22
2	1.470750000 MHz	21.82	Average	-24.18
1	3.396750000 MHz	28.28	Quasi Peak	-27.72
2	3.412500000 MHz	22.45	Average	-23.55
2	3.689250000 MHz	22.22	Average	-23.78
1	4.805250000 MHz	26.54	Quasi Peak	-29.46
2	6.162000000 MHz	20.73	Average	-29.27
1	6.713250000 MHz	27.89	Quasi Peak	-32.11

Transducer Table

Name: tdf_20
 Interpolation: LIN
 Comment: ANS 25/2 Primary LISN IL Line 1 + Coax Cable IL

Frequency	Factor (dB)
150.00 kHz	0.19
170.00 kHz	0.17
200.00 kHz	0.16
250.00 kHz	0.13
300.00 kHz	0.12
350.00 kHz	0.12
400.00 kHz	0.11
500.00 kHz	0.12
600.00 kHz	0.12
700.00 kHz	0.11
800.00 kHz	0.13
900.00 kHz	0.12
1.00 MHz	0.21
1.20 MHz	0.22
1.50 MHz	0.28
2.00 MHz	0.37
2.50 MHz	0.41
3.00 MHz	0.59
4.00 MHz	0.40
5.00 MHz	0.47
7.00 MHz	0.63
10.00 MHz	0.88
15.00 MHz	1.08
20.00 MHz	1.01
30.00 MHz	1.80



8.2.12 108MHz, Line 1 Plot

01.Mar 21 18:45

Time Domain Scan (1 Range)

Scan Start: 150 kHz
 Scan Stop: 30 MHz
 Detector: Trace 1: MAX PEAK Trace 2: Average
 Transducer: tdf_20

Start Frequency	Stop Frequency	Step Size	Res BW	Meas Time	RF Atten	Preamp	Input
150.000000 kHz	30.000000 MHz	2.25 kHz	9.00 kHz	500 ms	Auto	0 dB	INPUT2

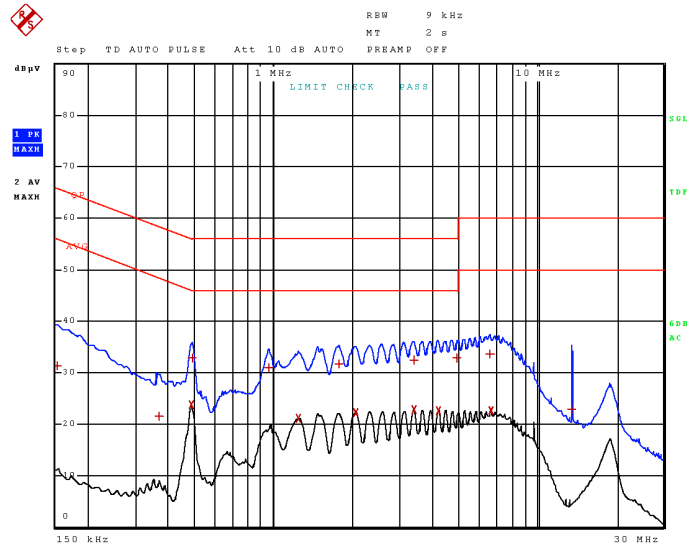



8.2.13 108MHz, Line 1 Table

01.Mar 21 18:45

Final Measurement

Meas Time: 2 s
 Margin: 30 dB
 Subranges: 15

Trace	Frequency	Level (dBµV)	Detector	Delta Limit/dB
1	152.250000000 kHz	31.30	Quasi Peak	-34.58
1	368.250000000 kHz	21.38	Quasi Peak	-37.16
2	487.500000000 kHz	23.75	Average	-22.46
1	489.750000000 kHz	32.86	Quasi Peak	-23.31
1	962.250000000 kHz	30.94	Quasi Peak	-25.06
2	1.243500000 MHz	21.11	Average	-24.89
1	1.767750000 MHz	31.67	Quasi Peak	-24.33
2	2.042250000 MHz	22.14	Average	-23.86
2	3.399000000 MHz	22.70	Average	-23.30
1	3.410250000 MHz	32.49	Quasi Peak	-23.51
2	4.233750000 MHz	22.55	Average	-23.45
1	4.998750000 MHz	32.77	Quasi Peak	-23.23
1	6.641250000 MHz	33.49	Quasi Peak	-26.51
2	6.666000000 MHz	22.51	Average	-27.49
1	13.560000000 MHz	22.78	Quasi Peak	-37.22

Transducer Table

Name: tdf_20
 Interpolation: LIN
 Comment: ANS 25/2 Primary LISN IL Line 1 + Coax Cable IL

Frequency	Factor (dB)
150.00 kHz	0.19
170.00 kHz	0.17
200.00 kHz	0.16
250.00 kHz	0.13
300.00 kHz	0.12
350.00 kHz	0.12
400.00 kHz	0.11
500.00 kHz	0.12
600.00 kHz	0.12
700.00 kHz	0.11
800.00 kHz	0.13
900.00 kHz	0.12
1.00 MHz	0.21
1.20 MHz	0.22
1.50 MHz	0.28
2.00 MHz	0.37
2.50 MHz	0.41
3.00 MHz	0.59
4.00 MHz	0.40
5.00 MHz	0.47
7.00 MHz	0.63
10.00 MHz	0.88
15.00 MHz	1.08
20.00 MHz	1.01
30.00 MHz	1.80



8.2.14 108MHz, Line 2 Plot

01.Mar 21 18:42

Time Domain Scan (1 Range)

Scan Start: 150 kHz
Scan Stop: 30 MHz
Detector: Trace 1: MAX PEAK Trace 2: Average
Transducer: tdf_20

Start Frequency	Stop Frequency	Step Size	Res BW	Meas Time	RF Atten	Preamp	Input
150.000000 kHz	30.000000 MHz	2.25 kHz	9.00 kHz	500 ms	Auto	0 dB	INPUT2

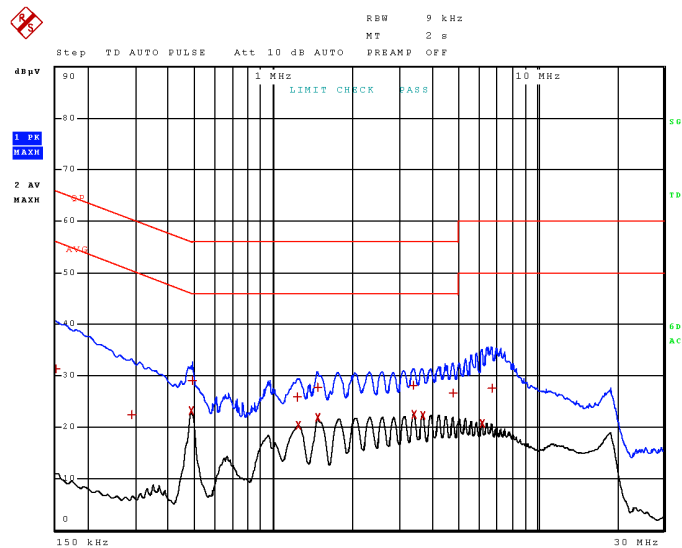



8.2.15 108MHz, Line 2 Table

01.Mar 21 18:42

Final Measurement

Meas Time: 2 s
 Margin: 30 dB
 Subranges: 14

Trace	Frequency	Level (dBµV)	Detector	Delta Limit/dB
1	150.00000000 kHz	31.35	Quasi Peak	-34.65
1	289.50000000 kHz	22.47	Quasi Peak	-38.07
2	487.50000000 kHz	23.10	Average	-23.11
1	489.75000000 kHz	28.95	Quasi Peak	-27.22
1	1.225500000 MHz	25.79	Quasi Peak	-30.21
2	1.243500000 MHz	20.38	Average	-25.62
1	1.468500000 MHz	27.61	Quasi Peak	-28.39
2	1.470750000 MHz	21.77	Average	-24.23
1	3.378750000 MHz	28.03	Quasi Peak	-27.97
2	3.399000000 MHz	22.43	Average	-23.57
2	3.684750000 MHz	22.30	Average	-23.70
1	4.805250000 MHz	26.60	Quasi Peak	-29.40
2	6.159750000 MHz	20.71	Average	-29.29
1	6.720000000 MHz	27.44	Quasi Peak	-32.56

Transducer Table

Name: tdf_20
 Interpolation: LIN
 Comment: ANS 25/2 Primary LISN IL Line 1 + Coax Cable IL

Frequency	Factor (dB)
150.00 kHz	0.19
170.00 kHz	0.17
200.00 kHz	0.16
250.00 kHz	0.13
300.00 kHz	0.12
350.00 kHz	0.12
400.00 kHz	0.11
500.00 kHz	0.12
600.00 kHz	0.12
700.00 kHz	0.11
800.00 kHz	0.13
900.00 kHz	0.12
1.00 MHz	0.21
1.20 MHz	0.22
1.50 MHz	0.28
2.00 MHz	0.37
2.50 MHz	0.41
3.00 MHz	0.59
4.00 MHz	0.40
5.00 MHz	0.47
7.00 MHz	0.63
10.00 MHz	0.88
15.00 MHz	1.08
20.00 MHz	1.01
30.00 MHz	1.80



8.2.16 174MHz, Line 1 Plot

01.Mar.21 18:47

Time Domain Scan (1 Range)

Scan Start: 150 kHz
Scan Stop: 30 MHz
Detector: Trace 1: MAX PEAK Trace 2: Average
Transducer: tdf_20

Start Frequency	Stop Frequency	Step Size	Res BW	Meas Time	RF Atten	Preamp	Input
150.000000 kHz	30.000000 MHz	2.25 kHz	9.00 kHz	500 ms	Auto	0 dB	INPUT2

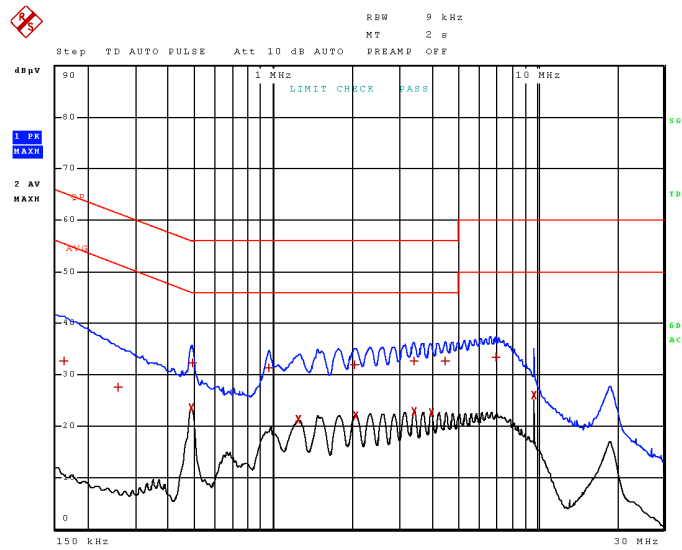



8.2.17 174MHz, Line 1 Table

01.Mar 21 18:47

Final Measurement

Meas Time: 2 s
 Margin: 30 dB
 Subranges: 14

Trace	Frequency	Level (dBµV)	Detector	Delta Limit/dB
1	161.250000000 kHz	32.64	Quasi Peak	-32.76
1	255.750000000 kHz	27.45	Quasi Peak	-34.11
2	487.500000000 kHz	23.46	Average	-22.75
1	492.000000000 kHz	32.29	Quasi Peak	-23.85
1	964.500000000 kHz	31.22	Quasi Peak	-24.78
2	1.243500000 MHz	21.19	Average	-24.81
1	2.033250000 MHz	31.95	Quasi Peak	-24.05
2	2.046750000 MHz	22.08	Average	-23.92
1	3.414750000 MHz	32.68	Quasi Peak	-23.32
2	3.414750000 MHz	22.73	Average	-23.27
2	3.977250000 MHz	22.57	Average	-23.43
1	4.483500000 MHz	32.70	Quasi Peak	-23.30
1	6.942750000 MHz	33.28	Quasi Peak	-26.72
2	9.690000000 MHz	26.01	Average	-23.99

Transducer Table

Name: tdf_20
 Interpolation: LIN
 Comment: ANS 25/2 Primary LISN IL Line 1 + Coax Cable IL

Frequency	Factor (dB)
150.00 kHz	0.19
170.00 kHz	0.17
200.00 kHz	0.16
250.00 kHz	0.13
300.00 kHz	0.12
350.00 kHz	0.12
400.00 kHz	0.11
500.00 kHz	0.12
600.00 kHz	0.12
700.00 kHz	0.11
800.00 kHz	0.13
900.00 kHz	0.12
1.00 MHz	0.21
1.20 MHz	0.22
1.50 MHz	0.28
2.00 MHz	0.37
2.50 MHz	0.41
3.00 MHz	0.59
4.00 MHz	0.40
5.00 MHz	0.47
7.00 MHz	0.63
10.00 MHz	0.88
15.00 MHz	1.08
20.00 MHz	1.01
30.00 MHz	1.80



8.2.18 174MHz, Line 2 Plot

01.Mar 21 18:50

Time Domain Scan (1 Range)

Scan Start: 150 kHz
Scan Stop: 30 MHz
Detector: Trace 1: MAX PEAK Trace 2: Average
Transducer: tdf_20

Start Frequency	Stop Frequency	Step Size	Res BW	Meas Time	RF Atten	Preamp	Input
150.000000 kHz	30.000000 MHz	2.25 kHz	9.00 kHz	500 ms	Auto	0 dB	INPUT2

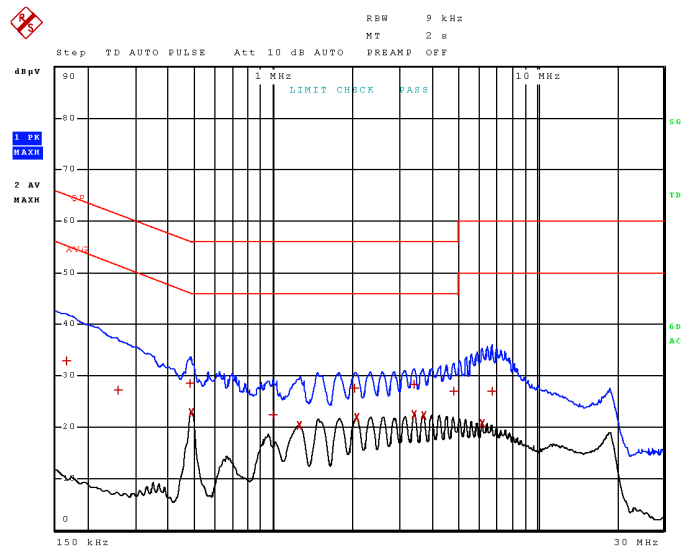



8.2.19 174MHz, Line 2 Table

01.Mar 21 18:50

Final Measurement

Meas Time: 2 s
 Margin: 30 dB
 Subranges: 14

Trace	Frequency	Level (dBµV)	Detector	Delta Limit/dB
1	163.50000000 kHz	32.83	Quasi Peak	-32.46
1	255.75000000 kHz	27.16	Quasi Peak	-34.41
1	483.00000000 kHz	28.51	Quasi Peak	-27.78
2	487.50000000 kHz	22.80	Average	-23.41
1	993.75000000 kHz	22.40	Quasi Peak	-33.60
2	1.24800000 MHz	20.29	Average	-25.71
1	2.03775000 MHz	27.46	Quasi Peak	-28.54
2	2.06250000 MHz	21.78	Average	-24.22
1	3.40125000 MHz	28.25	Quasi Peak	-27.75
2	3.42150000 MHz	22.41	Average	-23.59
2	3.70275000 MHz	22.29	Average	-23.71
1	4.81650000 MHz	26.89	Quasi Peak	-29.11
2	6.17550000 MHz	20.72	Average	-29.28
1	6.70425000 MHz	26.86	Quasi Peak	-33.14

Transducer Table

Name: tdf_20
 Interpolation: LIN
 Comment: ANS 25/2 Primary LISN IL Line 1 + Coax Cable IL

Frequency	Factor (dB)
150.00 kHz	0.19
170.00 kHz	0.17
200.00 kHz	0.16
250.00 kHz	0.13
300.00 kHz	0.12
350.00 kHz	0.12
400.00 kHz	0.11
500.00 kHz	0.12
600.00 kHz	0.12
700.00 kHz	0.11
800.00 kHz	0.13
900.00 kHz	0.12
1.00 MHz	0.21
1.20 MHz	0.22
1.50 MHz	0.28
2.00 MHz	0.37
2.50 MHz	0.41
3.00 MHz	0.59
4.00 MHz	0.40
5.00 MHz	0.47
7.00 MHz	0.63
10.00 MHz	0.88
15.00 MHz	1.08
20.00 MHz	1.01
30.00 MHz	1.80



8.2.20 406MHz, Line 1 Plot

01.Mar 21 18:55

Time Domain Scan (1 Range)

Scan Start: 150 kHz
Scan Stop: 30 MHz
Detector: Trace 1: MAX PEAK Trace 2: Average
Transducer: tdf_20

Start Frequency	Stop Frequency	Step Size	Res BW	Meas Time	RF Atten	Preamp	Input
150.000000 kHz	30.000000 MHz	2.25 kHz	9.00 kHz	500 ms	Auto	0 dB	INPUT2

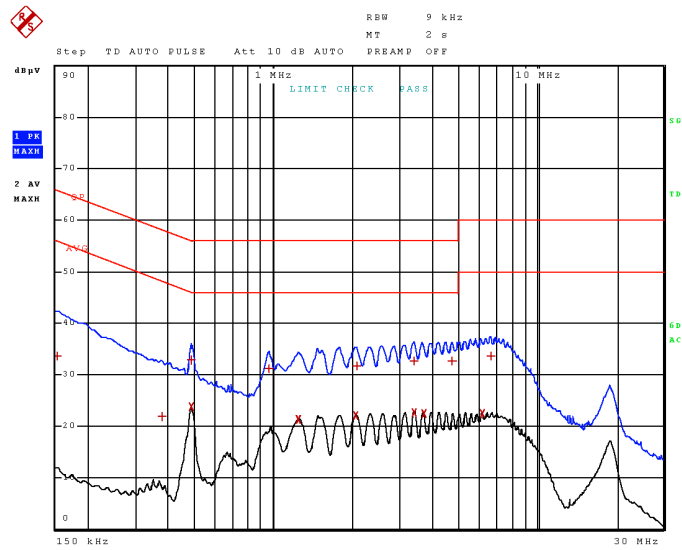



8.2.21 406MHz, Line 1 Table

01.Mar 21 18:55

Final Measurement

Meas Time: 2 s
 Margin: 30 dB
 Subranges: 14

Trace	Frequency	Level (dBµV)	Detector	Delta Limit/dB
1	152.250000000 kHz	33.55	Quasi Peak	-32.33
1	375.000000000 kHz	21.91	Quasi Peak	-36.48
1	487.500000000 kHz	32.89	Quasi Peak	-23.32
2	487.500000000 kHz	23.73	Average	-22.48
1	964.500000000 kHz	31.05	Quasi Peak	-24.95
2	1.243500000 MHz	21.22	Average	-24.78
2	2.051250000 MHz	21.96	Average	-24.04
1	2.067000000 MHz	31.68	Quasi Peak	-24.32
2	3.412500000 MHz	22.63	Average	-23.37
1	3.414750000 MHz	32.57	Quasi Peak	-23.43
2	3.698250000 MHz	22.49	Average	-23.51
1	4.742250000 MHz	32.62	Quasi Peak	-23.38
2	6.182250000 MHz	22.49	Average	-27.51
1	6.652500000 MHz	33.57	Quasi Peak	-26.43

Transducer Table

Name: tdf_20
 Interpolation: LIN
 Comment: ANS 25/2 Primary LISN IL Line 1 + Coax Cable IL

Frequency	Factor (dB)
150.00 kHz	0.19
170.00 kHz	0.17
200.00 kHz	0.16
250.00 kHz	0.13
300.00 kHz	0.12
350.00 kHz	0.12
400.00 kHz	0.11
500.00 kHz	0.12
600.00 kHz	0.12
700.00 kHz	0.11
800.00 kHz	0.13
900.00 kHz	0.12
1.00 MHz	0.21
1.20 MHz	0.22
1.50 MHz	0.28
2.00 MHz	0.37
2.50 MHz	0.41
3.00 MHz	0.59
4.00 MHz	0.40
5.00 MHz	0.47
7.00 MHz	0.63
10.00 MHz	0.88
15.00 MHz	1.08
20.00 MHz	1.01
30.00 MHz	1.80



8.2.22 406MHz, Line 2 Plot

01.Mar 21 18:52

Time Domain Scan (1 Range)

Scan Start: 150 kHz
Scan Stop: 30 MHz
Detector: Trace 1: MAX PEAK Trace 2: Average
Transducer: tdf_20

Start Frequency	Stop Frequency	Step Size	Res BW	Meas Time	RF Atten	Preamp	Input
150.000000 kHz	30.000000 MHz	2.25 kHz	9.00 kHz	500 ms	Auto	0 dB	INPUT2

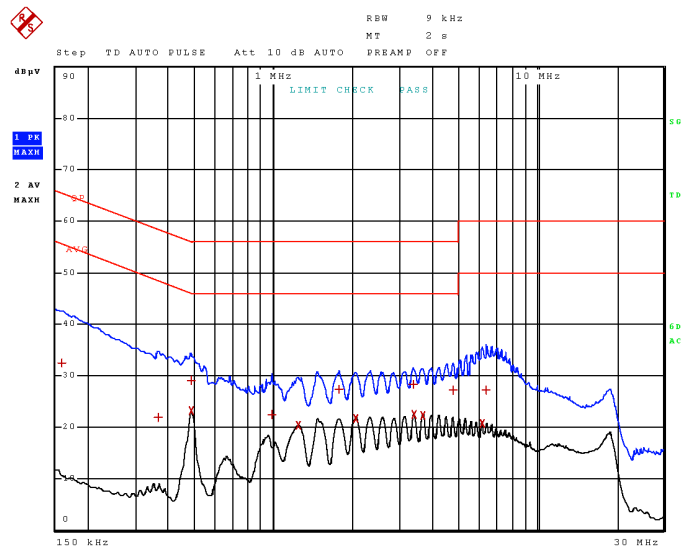



8.2.1 406MHz, Line 2 Table

01.Mar 21 18:52

Final Measurement

Meas Time: 2 s
 Margin: 30 dB
 Subranges: 14

Trace	Frequency	Level (dBµV)	Detector	Delta Limit/dB
1	159.00000000 kHz	32.39	Quasi Peak	-33.13
1	363.75000000 kHz	21.76	Quasi Peak	-36.89
1	485.25000000 kHz	28.97	Quasi Peak	-27.28
2	487.50000000 kHz	23.13	Average	-23.08
1	987.00000000 kHz	22.37	Quasi Peak	-33.63
2	1.243500000 MHz	20.40	Average	-25.60
1	1.765500000 MHz	27.28	Quasi Peak	-28.72
2	2.044500000 MHz	21.73	Average	-24.27
1	3.390000000 MHz	28.19	Quasi Peak	-27.81
2	3.410250000 MHz	22.43	Average	-23.57
2	3.680250000 MHz	22.18	Average	-23.82
1	4.798500000 MHz	27.13	Quasi Peak	-28.87
2	6.164250000 MHz	20.74	Average	-29.26
1	6.420750000 MHz	27.06	Quasi Peak	-32.94

Transducer Table

Name: tdf_20
 Interpolation: LIN
 Comment: ANS 25/2 Primary LISN IL Line 1 + Coax Cable IL

Frequency	Factor (dB)
150.00 kHz	0.19
170.00 kHz	0.17
200.00 kHz	0.16
250.00 kHz	0.13
300.00 kHz	0.12
350.00 kHz	0.12
400.00 kHz	0.11
500.00 kHz	0.12
600.00 kHz	0.12
700.00 kHz	0.11
800.00 kHz	0.13
900.00 kHz	0.12
1.00 MHz	0.21
1.20 MHz	0.22
1.50 MHz	0.28
2.00 MHz	0.37
2.50 MHz	0.41
3.00 MHz	0.59
4.00 MHz	0.40
5.00 MHz	0.47
7.00 MHz	0.63
10.00 MHz	0.88
15.00 MHz	1.08
20.00 MHz	1.01
30.00 MHz	1.80



8.2.2 512MHz, Line 1 Plot

01.Mar.21 18:58

Time Domain Scan (1 Range)

Scan Start: 150 kHz
 Scan Stop: 30 MHz
 Detector: Trace 1: MAX PEAK Trace 2: Average
 Transducer: tdf_20

Start Frequency	Stop Frequency	Step Size	Res BW	Meas Time	RF Atten	Preamp	Input
150.000000 kHz	30.000000 MHz	2.25 kHz	9.00 kHz	500 ms	Auto	0 dB	INPUT2

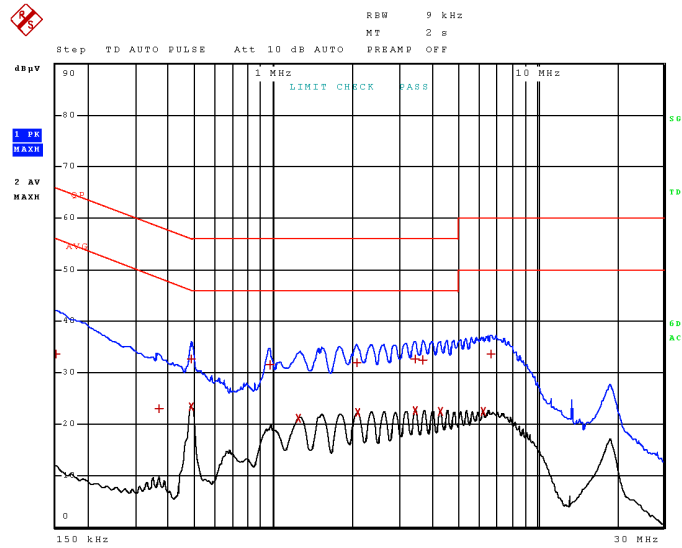



8.2.3 512MHz, Line 1 Table

01.Mar 21 18:58

Final Measurement

Meas Time: 2 s
 Margin: 30 dB
 Subranges: 14

Trace	Frequency	Level (dBµV)	Detector	Delta Limit/dB
1	150.00000000 kHz	33.50	Quasi Peak	-32.50
1	368.25000000 kHz	22.89	Quasi Peak	-35.65
2	485.25000000 kHz	23.29	Average	-22.96
1	487.50000000 kHz	32.66	Quasi Peak	-23.55
1	969.00000000 kHz	31.52	Quasi Peak	-24.48
2	1.24125000 MHz	21.00	Average	-25.00
1	2.07375000 MHz	31.78	Quasi Peak	-24.22
2	2.07600000 MHz	22.12	Average	-23.88
1	3.43950000 MHz	32.70	Quasi Peak	-23.30
2	3.45075000 MHz	22.62	Average	-23.38
1	3.68925000 MHz	32.47	Quasi Peak	-23.53
2	4.29450000 MHz	22.45	Average	-23.55
2	6.23625000 MHz	22.42	Average	-27.58
1	6.68400000 MHz	33.62	Quasi Peak	-26.38

Transducer Table

Name: tdf_20
 Interpolation: LIN
 Comment: ANS 25/2 Primary LISN IL Line 1 + Coax Cable IL

Frequency	Factor (dB)
150.00 kHz	0.19
170.00 kHz	0.17
200.00 kHz	0.16
250.00 kHz	0.13
300.00 kHz	0.12
350.00 kHz	0.12
400.00 kHz	0.11
500.00 kHz	0.12
600.00 kHz	0.12
700.00 kHz	0.11
800.00 kHz	0.13
900.00 kHz	0.12
1.00 MHz	0.21
1.20 MHz	0.22
1.50 MHz	0.28
2.00 MHz	0.37
2.50 MHz	0.41
3.00 MHz	0.59
4.00 MHz	0.40
5.00 MHz	0.47
7.00 MHz	0.63
10.00 MHz	0.88
15.00 MHz	1.08
20.00 MHz	1.01
30.00 MHz	1.80



8.2.4 512MHz, Line 2 Plot

01.Mar 21 19:00

Time Domain Scan (1 Range)

Scan Start: 150 kHz
Scan Stop: 30 MHz
Detector: Trace 1: MAX PEAK Trace 2: Average
Transducer: tdf_20

Start Frequency	Stop Frequency	Step Size	Res BW	Meas Time	RF Atten	Preamp	Input
150.000000 kHz	30.000000 MHz	2.25 kHz	9.00 kHz	500 ms	Auto	0 dB	INPUT2

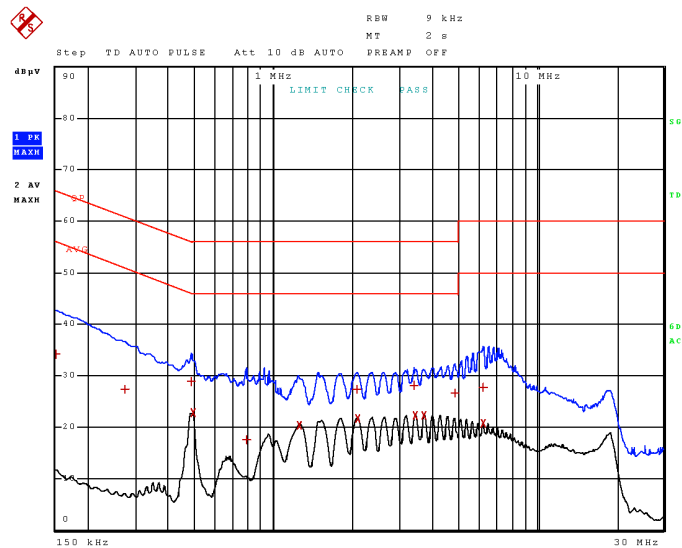



8.2.5 512MHz, Line 2 Table

01.Mar 21 19:00

Final Measurement

Meas Time: 2 s
 Margin: 30 dB
 Subranges: 14

Trace	Frequency	Level (dBµV)	Detector	Delta Limit/dB
1	150.00000000 kHz	34.15	Quasi Peak	-31.85
1	271.50000000 kHz	27.30	Quasi Peak	-33.77
1	487.50000000 kHz	28.85	Quasi Peak	-27.36
2	494.25000000 kHz	22.70	Average	-23.39
1	786.75000000 kHz	17.58	Quasi Peak	-38.42
2	1.245750000 MHz	20.32	Average	-25.68
1	2.071500000 MHz	27.41	Quasi Peak	-28.59
2	2.078250000 MHz	21.73	Average	-24.27
1	3.423750000 MHz	28.04	Quasi Peak	-27.96
2	3.446250000 MHz	22.26	Average	-23.74
2	3.727500000 MHz	22.22	Average	-23.78
1	4.872750000 MHz	26.64	Quasi Peak	-29.36
2	6.231750000 MHz	20.66	Average	-29.34
1	6.254250000 MHz	27.71	Quasi Peak	-32.29

Transducer Table

Name: tdf_20
 Interpolation: LIN
 Comment: ANS 25/2 Primary LISN IL Line 1 + Coax Cable IL

Frequency	Factor (dB)
150.00 kHz	0.19
170.00 kHz	0.17
200.00 kHz	0.16
250.00 kHz	0.13
300.00 kHz	0.12
350.00 kHz	0.12
400.00 kHz	0.11
500.00 kHz	0.12
600.00 kHz	0.12
700.00 kHz	0.11
800.00 kHz	0.13
900.00 kHz	0.12
1.00 MHz	0.21
1.20 MHz	0.22
1.50 MHz	0.28
2.00 MHz	0.37
2.50 MHz	0.41
3.00 MHz	0.59
4.00 MHz	0.40
5.00 MHz	0.47
7.00 MHz	0.63
10.00 MHz	0.88
15.00 MHz	1.08
20.00 MHz	1.01
30.00 MHz	1.80



9. ANNEX-A - Photographs of the EUT

Photographs of the EUT and any manufacturer supplied accessories to be used with the EUT are in a separate document.

10. ANNEX-B – Test Setup Photographs

Test setup photographs are located in a separate document.

11. History of Test Report Changes

Test Report #	Revision #	Description	Date of Issue
TR_0945-21_FCC_15B_Scanning Receiver_1	1	Initial release	3/2/2021
	1	Revised test Dates and page 5	3/24/2021



Timco Engineering, Inc., an IIA Company
849 NW State Road 45, Newberry, Florida 32669
(352) 472-5500 / testing@timcoengr.com

END OF TEST REPORT
