



MET Laboratories, Inc. *Safety Certification - EMI - Telecom Environmental Simulation*
33439 WESTERN AVENUE • UNION CITY, CALIFORNIA 94587-3201 • PHONE (510) 489-6300 • FAX (510) 489-6372

Dosimetric Assessment Test Report

for the

**Kenwood Communications Corporation
TK-5300**

**Tested and Evaluated In Accordance With
FCC OET 65 Supplement C: 01-01**

Prepared for:

Kenwood Communications Corporation
3975 Johns Creek Court, Suite 300
Suwanee, GA 30024

Engineering Statement: The measurements shown in this report were made in accordance with the procedures specified in Supplement C to OET Bulletin 65 of the Federal Communications Commission (FCC) Guidelines [FCC 2001] for Controlled Exposure/Occupational. I assume full responsibility for the accuracy and completeness of these measurements, and for the qualifications of all persons taking them. It is further stated that upon the basis of the measurements made, the equipment evaluated is capable of compliance for localized specific absorption rate (SAR) for Controlled Exposure/Occupational limits specified in ANSI/IEEE Std. C95.1-1999.



SAR Evaluation Certificate of Compliance

FCC ID: ALH37164110
 APPLICANT: Kenwood Communications Corporation

Applicant Name and Address: Kenwood Communications Corporation
 3975 Johns Creek Court, Suite 300
 Suwanee, GA 30024

Test Location: MET Laboratories, Inc.
 4855 Patrick Henry Drive, Building 6
 Santa Clara, CA 95054
 U.S.A.

EUT:	Kenwood TK-5300		
Date of Receipt:	December 21, 2005		
Device Category:	Licensed Non-Broadcast Transmitter Held to Face (TNF)		
RF exposure environment:	Controlled Exposure/Occupational		
RF exposure category:	Portable FM UHF PTT Radio Transceiver		
Power supply:	KNB-32N 2500mAh Ni-MH, 7.2VDC KNB-31A 1700mAh Ni-CAD 7.2VDC KNB-31A 1700mAh Li-ion 7.4VDC KBP-6 Alkaline Case 6x1.5VDC AA (only for 1W applications-Not tested)		
Antenna(s):	KRA-27M 150mm Whip KRA-23M 80mm Stubby		
Body Worn Accessories:	KBH-10 Belt Clip KBH-11 Belt Clip KMC-25 Speaker Microphone		
Production/prototype:	Production		
Modulation:	FM		
Duty Cycle:	100%		
TX Range:	450.0 – 485.1 MHz		
Maximum Tested RF Output Power in CW Mode:	450.05 MHz	Peak Conducted	36.9dBm/4.89W
	467.05 MHz	Peak Conducted	36.9dBm/4.89W
	485.05 MHz	Peak Conducted	36.9dBm/4.89W
Maximum SAR Measurement @ 50% Duty Cycle:	Body: 7.2m W/g		Head: 2.6mW/g



Kenwood Communications Corporation
TK-5300

Electromagnetic Compatibility
FCC OET 65 Supplement C: 01-01

A handwritten signature in black ink, appearing to read "Shawn McMillen", is positioned above a horizontal line.

Shawn McMillen, EMCProject Engineer





TABLE OF CONTENTS

INTRODUCTION	5
SAR DEFINITION.....	5
DESCRIPTION OF DEVICE UNDER TEST (EUT)	6
SAR MEASUREMENT SYSTEM	7
MEASUREMENT SUMMARY.....	8
DETAILS OF SAR EVALUATION.....	10
EVALUATION PROCEDURES	11
DATA EVALUATION PROCEDURES	12
SYSTEM PERFORMANCE CHECK.....	14
SIMULATED EQUIVALENT TISSUES	14
SAR SAFETY LIMITS	15
ROBOT SYSTEM SPECIFICATIONS.....	16
1.1. Specifications	16
1.2. Data Acquisition Electronic (Dae) System:.....	16
1.3. Phantom(s):	16
PROBE SPECIFICATIONS (ET3DV6).....	17
SAR Measurement System.....	18
1.4. RX90BL Robot.....	18
1.5. Robot Controller.....	18
1.6. Light Beam Switch.....	18
1.7. Data Acquisition Electronics	18
1.8. Electro-Optical Converter (EOC)	19
1.9. Measurement Server.....	19
1.10. Dosimetric Probe	19
1.11. SAM Phantom	19
1.12. Planar Phantom.....	19
1.13. Validation Planar Phantom.....	20
1.14. Split Planar Phantom	20
1.15. Device Holder.....	20
1.16. System Validation Kits.....	20
TEST EQUIPMENT LIST	21
MEASUREMENT UNCERTANTIES	22
REFERENCES.....	24
Appendix A – EUT SETUP PHOTOS.....	25
Appendix B – EUT PHOTOS.....	26
Appendix C – SAR MEASUREMENT DATA.....	27
Appendix D – SYSTEM VALIDAION	28
Appendix E – PROBE CALIBRATION CERTIFICATE.....	29
Appendix F – DIPOLE CALIBRATION CERTIFICATE.....	30
Appendix G – MEASURED FLUID DIELECTRIC PARAMETERS.....	31



INTRODUCTION

This measurement report demonstrates that the Kenwood TK-5300 FCC ID: ALH37164110 described within this report complies with the Specific Absorption Rate (SAR) RF exposure requirements specified in ANSI/IEEE Std. C95.1-1999 and FCC 47 CFR §2.1093 for the Controlled Exposure/Occupational environment. The test procedures described in FCC OET Bulletin 65, Supplement C, Edition 01-01 were employed.

A description of the device under test, device operating configuration and test conditions, measurement and site description, methodology and procedures used in the evaluation, equipment used, detailed summary of the test results and the various provisions of the rules are included in this dosimetric assessment test report.

SAR DEFINITION

Specific Absorption Rate (SAR) is defined as the time derivative (rate) of the incremental energy (dU) absorbed by (dissipated in) an incremental mass (dm) contained in a volume element (dV) of a given density (ρ). It is also defined as the rate of RF energy absorption per unit mass at a point in an absorbing body (see Fig. 1.1).

$$SAR = \frac{d}{dt} \left(\frac{dU}{dm} \right) = \frac{d}{dt} \left(\frac{dU}{\rho dv} \right)$$

Figure 1.1
SAR Mathematical Equation

SAR is expressed in units of Watts per Kilogram (W/kg).

$$SAR = \sigma E^2 / \rho$$

where:

- σ - conductivity of the tissue - simulant material (S/m)
- ρ - mass density of the tissue - simulant material (kg/m³)
- E - Total RMS electric field strength (V/m)

NOTE: The primary factors that control rate of energy absorption were found to be the wavelength of the incident field in relations to the dimensions and geometry of the irradiated organism, the orientation of the organism in relation to the polarity of field vectors, the presence of reflecting surfaces, and whether conductive contact is made by the organism with a ground plane.



DESCRIPTION OF DEVICE UNDER TEST (EUT)

Applicant:	Kenwood		
Description of Test Item:	Portable FM UHF PTT Digital Radio Transceiver		
FCC ID:	ALH37164110		
Model Number:	TK-5300		
Serial Number:	N/A		
Battery Type(s) Tested:	KNB-32N 2500mAh Ni-MH, 7.2VDC KNB-31A 1700mAh Ni-CAD 7.2VDC KNB-31A 1700mAh Li-ion 7.4VDC KBP-6 Alkaline Case 6x1.5VDC AA (only for 1W applications-Not tested)		
Antenna Type(s) Tested:	KRA-27M 150mm Whip KRA-23M 80mm Stubby		
Body Worn Accessories:	KBH-10 Belt Clip KBH-11 Belt Clip KMC-25 Speaker Microphone		
Maximum Duty Cycle Tested:	100%		
Transmitter Frequency Range (MHz):	450.0 – 485.1 MHz		
Maximum Tested RF Power Output CW Mode:	450.05 MHz	Peak Conducted	36.9 dBm/4.89W
	467.05 MHz	Peak Conducted	36.9 dBm/4.89W
	485.05 MHz	Peak Conducted	36.9 dBm/4.89W
Maximum SAR Measurement @ 50% Duty Cycle:	Body: 7.2 mW/g		Head: 2.6 mW/g
Application Type:	Certification		
FCC Classification:	Licensed Non-Broadcast Transmitter Held to Face (TNF)		
Exposure Category:	Controlled Exposure/Occupational		
FCC Rule Part(s):	FCC 47 CFR §2.1093,		
Standards:	IEEE Std. 1528-2003, FCC OET Bulletin 65, Supplement C, Edition 01-01		

Notes: This portable handheld transceiver model TK-5300 FCC ID: ALH37164110, operates using frequency Modulation (FM) utilizing simplex two-way radio transmission. This device will be marketed for Occupation use. This device is intended to be operated in front of the users face and by means of body-worn accessory(s). The operational band of this device is 450.0 – 485.1 MHz with 1 and 5 watts selectable power.



SAR MEASUREMENT SYSTEM

MET Laboratories, Inc SAR measurement facility utilizes the DASY4 Professional Dosimetric Assessment System (DASY™) manufactured by Schmid & Partner Engineering AG (SPEAG™) of Zurich, Switzerland for performing SAR compliance tests. The DASY4 measurement system is comprised of the measurement server, robot controller, computer, near-field probe, probe alignment sensor, specific anthropomorphic mannequin (SAM) phantom, and various planar phantoms for brain and/or body SAR evaluations. The robot is a six-axis industrial robot performing precise movements to position the probe to the location (points) of maximum electromagnetic field (EMF). The Cell controller system contain the power supply, robot controller, teach pendant (Joystick), and remote control, is used to drive the robot motors. The Staubli robot is connected to the cell controller to allow software manipulation of the robot. A data acquisition electronic (DAE) circuit performs the signal amplification, signal multiplexing, AD-conversion, offset measurements, mechanical surface detection, collision detection, etc. is connected to the Electro-optical coupler (EOC). The EOC performs the conversion from the optical into digital electric signal of the DAE and transfers data to the DASY4 measurement server. The DAE4 utilizes a highly sensitive electrometer-grade preamplifier with auto-zeroing, a channel and gain-switching multiplexer, a fast 16-bit AD-converter and a command decoder and control logic unit.



Transmission to the DASY4 measurement server is accomplished through an optical downlink for data and status information and an optical uplink for commands and clock lines. The mechanical probe-mounting device includes two different sensor systems for frontal and sidewise probe contacts. The sensor systems are also used for mechanical surface detection and probe collision detection. The robot uses its own controller with a built in VME-bus computer.



MEASUREMENT SUMMARY

FACE-HELD SAR MEASUREMENT RESULTS 450MHz Band ANSI/IEEE C95.1 1999 – SAFETY LIMIT HEAD: 8.0 W/kg (averaged over 1 gram) Spatial Peak – Controlled Exposure/Occupational												
Freq (MHz)	Chan	Cond. Power Before (dBm)	Cond. Power After (dBm)	Battery	Antenna	Sep Dist (cm)	Test Pos	Accessory	SAR over 1g	Drift (dB)	Adjusted SAR Over 1g	
											Duty Cycle	
											100%	50%
467.05	Mid	36.9	36.6	KNB-32N	KRA-27M	2.5	Face Held	None	4.80	-0.397	5.3	2.6
467.05	Mid	36.9	36.5	KNB-33L	KRA-27M	2.5	Face Held	None	4.76	-0.432	5.3	2.6
467.05	Mid	36.9	36.6	KNB-31A	KRA-27M	2.5	Face Held	None	4.65	-0.362	5.1	2.5
450.05	Low	36.9	36.7	KNB-32N	KRA-27M	2.5	Face Held	None	4.15	-0.290	4.4	2.2
485.05	High	36.9	36.5	KNB-32N	KRA-27M	2.5	Face Held	None	3.98	-0.420	4.4	2.2
467.05	Mid	36.9	36.5	KNB-32N	KRA-23M	2.5	Face Held	None	4.34	-0.359	4.7	2.4
467.05	Mid	36.9	36.6	KNB-33L	KRA-23M	2.5	Face Held	None	3.41	-0.247	3.6	1.8
467.05	Mid	36.9	36.7	KNB-31A	KRA-23M	2.5	Face Held	None	3.33	-0.221	3.5	1.8
450.05	Low	36.9	36.6	KNB-32N	KRA-23M	2.5	Face Held	None	4.65	-0.437	5.1	2.6
485.05	High	36.9	36.8	KNB-32N	KRA-23M	2.5	Face Held	None	3.16	-0.198	3.3	1.7
Measured Mixture Type		450 MHz Head						Date Tested			December 21, 2005	
Dielectric Constant ϵ_r		IEEE Target		Measured		Relative Humidity			62%			
		43.5		46.1		Ambient Temperature (C)			23.0			
Conductivity σ (mho/m)		IEEE Target		Measured		Fluid Temperature (C)			22.6			
		0.87		0.86		Fluid Depth			≥ 15 cm			
Measured Mixture Type		450 MHz Head						Date Tested			December 27, 2005	
Dielectric Constant ϵ_r		IEEE Target		Measured		Relative Humidity			71%			
		43.5		46.0		Ambient Temperature (C)			23.1			
Conductivity σ (mho/m)		IEEE Target		Measured		Fluid Temperature (C)			22.7			
		0.87		0.86		Fluid Depth			≥ 15 cm			



BODY-WORN SAR MEASUREMENT RESULTS 450MHz Band ANSI/IEEE C95.1 1999 – SAFETY LIMIT BODY: 8.0 W/kg (averaged over 1 gram) Spatial Peak – Controlled Exposure/Occupational												
Freq (MHz)	Chan	Cond. Power Before (dBm)	Cond. Power After (dBm)	Battery	Antenna	Sep Dist (cm)	Test Pos	Accessory	SAR over 1g 100% Duty cycle	Drift (dB)	Adjusted SAR due to drift Over 1g	
											Duty Cycle	
											100%	50%
467.05	Mid	36.9	36.5	KNB-33L	KRA-27M	0.0	Body	KBH-10 Belt clip	11.70	-0.474	13.0	6.5
467.05	Mid	36.9	36.4	KNB-33L	KRA-27M	0.0	Body	KBH-11 Belt clip	7.14	-0.695	8.4	4.2
467.05	Mid	36.9	36.5	KNB-32N	KRA-27M	0.0	Body	KBH-10 Belt clip	12.30	-0.476	13.7	6.9
467.05	Mid	36.9	36.8	KNB-31A	KRA-27M	0.0	Body	KBH-10 Belt clip	11.50	-0.173	12.0	6.0
450.05	Low	36.9	36.5	KNB-32N	KRA-27M	0.0	Body	KBH-10 Belt clip	8.81	-0.563	10.0	5.0
485.05	High	36.9	36.4	KNB-32N	KRA-27M	0.0	Body	KBH-10 Belt clip	6.94	-0.631	8.0	4.0
467.05	Mid	36.9	36.5	KNB-33L	KRA-23M	0.0	Body	KBH-10 Belt clip	11.40	-0.543	12.9	6.5
467.05	Mid	36.9	36.7	KNB-33L	KRA-23M	0.0	Body	KBH-11 Belt clip	8.54	-0.255	9.1	4.5
467.05	Mid	36.9	36.5	KNB-32N	KRA-23M	0.0	Body	KBH-10 Belt clip	10.40	-0.512	11.7	5.9
467.05	Mid	36.9	36.6	KNB-31A	KRA-23M	0.0	Body	KBH-10 Belt clip	10.10	-0.311	10.8	5.4
450.05	Low	36.9	36.5	KNB-32N	KRA-23M	0.0	Body	KBH-10 Belt clip	13.10	-0.407	14.4	7.2
485.05	High	36.9	36.8	KNB-32N	KRA-23M	0.0	Body	KBH-10 Belt clip	7.75	-0.149	8.0	4.0
Measured Mixture Type		450 MHz Body					Date Tested				December 21, 2005	
Dielectric Constant ϵ_r		IEEE Target		Measured		Relative Humidity				62%		
		56.7		58.3		Ambient Temperature (C)				23.1		
Conductivity σ (mho/m)		IEEE Target		Measured		Fluid Temperature (C)				22.7		
		0.94		0.92		Fluid Depth				≥ 15 cm		
Measured Mixture Type		450 MHz Body					Date Tested				December 27, 2005	
Dielectric Constant ϵ_r		IEEE Target		Measured		Relative Humidity				71%		
		56.7		58.5		Ambient Temperature (C)				23.0		
Conductivity σ (mho/m)		IEEE Target		Measured		Fluid Temperature (C)				22.6		
		0.94		0.96		Fluid Depth				≥ 15 cm		

Note: All body worn evaluations were carried out with the KMC-25 Speaker Microphone attached.



DETAILS OF SAR EVALUATION

The Kenwood TK-5300 FCC ID: ALH37164110 was determined to be compliant for localized Specific Absorption Rate based on the test provisions and conditions described below. Detailed test setup photographs are shown in the Appendix.

1. The EUT was tested for body-worn SAR with the KBH-11 and KBH-10 belt-clip accessories. The KBH-11 belt-clip provided 19mm separation between the back of the EUT and the outer surface of the planar phantom. The KBH-10 belt-clip provided 11mm separation between the back of the EUT and the outer surface of the planar phantom. All body worn SAR evaluations were performed with the KMC-25 Speaker Microphone attached.
2. The EUT was tested for face-held configurations with the front of the EUT facing the planar phantom. The EUT was placed at a separation distance of 2.5cm from the outer surface of the phantom.
3. Each Antenna configuration was evaluated with all available battery configurations with the exception of the Alkaline Battery Pack, which is applicable only used for 1W applications.
4. The device was positioned next to the phantom surface using either the DASY device positioner or low-loss polystyrene.
5. The EUT was tested at a 100% duty cycle in CW mode. The SAR values were scaled to account for any negative drift which occurred over the course of the test. A 50% duty cycle was applied to the final SAR values based on an equal transmit and receive time.
6. A SAR versus time sweep was carried out on the configuration that produced the highest measured SAR. The probe was positioned at the power measurement reference position.
7. The conducted power levels were measured before and after each test using a HP E4418B Power Meter according to the procedures described in FCC 47 CFR 2.1046. The EUT was set to the maximum power level for each SAR evaluation.
8. The SAR evaluations were performed with a fully charged battery.
9. The fluid temperature was measured prior to and after each SAR evaluation to ensure the temperature remained within ± 2 deg C of the temperature of the fluid when the dielectric properties were measured.
10. The dielectric parameters of the simulated body fluid were measured prior to the evaluation using an 85070D Dielectric Probe Kit and an 8722D Network Analyzer.
11. During the SAR evaluations if a distribution produced several hotspots over the course of the area scan, each hotspot was evaluated separately.



EVALUATION PROCEDURES

The evaluation was performed in the applicable area of the phantom depending on the type of device being tested.

- (i) For devices held to the ear during normal operation, both the left and right ear positions were evaluated using the SAM phantom.
- (ii) For body-worn and face-held devices a planar phantom was used.

The SAR was determined by a pre-defined procedure within the DASY4 software. Upon completion of a reference check, the exposed region of the phantom was scanned near the inner surface with a grid spacing of 15mm x 15mm.

An area scan was determined as follows:

Based on the defined area scan grid, a more detailed grid is created to increase the points by a factor of 10. The interpolation function then evaluates all field values between corresponding measurement points.

A linear search is applied to find all the candidate maxima. Subsequently, all maxima are removed that are >2 dB from the global maximum. The remaining maxima are then used to position the cube scans.

A 1g and 10g spatial peak SAR was determined as follows:

Based on the area scan, a 32mm x 32mm x 34mm (7x7x7 data points) zoom scan was assessed at the position where the greatest V/m was detected. The data at the surface was extrapolated since the distance from the probes sensors to the surface is 3.9cm. A least squares fourth-order polynomial was used to generate points between the probe detector and the inner surface of the phantom.

Interpolated data is used to calculate the average SAR over 1g and 10g cubes by spatially discretizing the entire measured cube. The volume used to determine the averaged SAR is a 1mm grid (42875 interpolated points).

Z-Scan was determined as follows:

The Z-scan measures points along a vertical straight line. The line runs along a line normal to the inner surface of the phantom surface.



DATA EVALUATION PROCEDURES

The DASY4 post processing software (SEMCAD) automatically executes the following procedures to calculate the field units from the microvolt readings at the probe connector. The parameters used in the evaluation are stored in the configuration modules of the software:

Probe Parameters:	- Sensitivity	$Norm_i, a_{i0}, a_{i1}, a_{i2}$
	- Conversion Factor	$ConvF_i$
	- Dipole Compression Point	dcp_i
Device parameters:	- Frequency	f
	- Crest factor	cf
Media parameters:	- Conductivity	σ
	- Density	ρ

These parameters must be set correctly in the software. They can be found in the component documents or be imported into the software from the configuration files issued for the DASY components. In the direct measuring mode of the multimeter option, the parameters of the actual system setup are used. In the scan visualization and export modes, the parameters stored in the corresponding document files are used. The first step of the evaluation is a linearization of the filtered input signal to account for the compression characteristics of the detector diode. The compensation depends on the input signal, the diode type and the DC - transmission factor from the diode to the evaluation electronics. If the exciting field is pulsed, the crest factor of the signal must be known to correctly compensate for peak power. The formula for each channel can be given as:

$$V_i = U_i + U_i^2 \cdot \frac{cf}{dcp_i}$$

With V_i = Compensated signal of channel i (i = x, y, z)
 U_i = Input signal of channel i (i = x, y, z)
 cf = Crest factor of exciting field (DASY parameter)
 dcp_i = Diode compression point (DASY parameter)

From the compensated input signals the primary field data for each channel can be evaluated:

$$\text{E - fieldprobes : } E_i = \sqrt{\frac{V_i}{Norm_i \cdot ConvF}}$$

$$\text{H - fieldprobes : } H_i = \sqrt{V_i} \cdot \frac{a_{i0} + a_{i1}f + a_{i2}f^2}{f}$$

with V_i = Compensated signal of channel i (i = x, y, z)
 $Norm_i$ = Sensor sensitivity of channel i (i = x, y, z)
 $\mu V/(V/m)^2$ for E-field probes
 $ConvF$ = Sensitivity enhancement in solution
 a_{ij} = Sensor sensitivity factors for H-field probes
 f = Carrier frequency (GHz)
 E_i = Electric field strength of channel i in V/m
 H_i = Magnetic field strength of channel i in A/m



The RSS value of the field components gives the total field strength (Hermitian magnitude):

$$E_{tot} = \sqrt{E_x^2 + E_y^2 + E_z^2}$$

The primary field data are used to calculate the derived field units.

$$SAR = E_{tot}^2 \cdot \frac{\sigma}{\rho \cdot 1'000}$$

with SAR = local specific absorption rate in mW/g

E_{tot} = total field strength in V/m

σ = conductivity in [mho/m] or [Siemens/m]

ρ = equivalent tissue density in g/cm³

Note that the density is normally set to 1 (or 1.06), to account for actual brain density rather than the density of the simulation liquid.

The power flow density is calculated assuming the excitation field as a free space field.

$$P_{pwe} = \frac{E_{tot}^2}{3770} \quad \text{or} \quad P_{pwe} = H_{tot}^2 \cdot 37.7$$

with P_{pwe} = Equivalent power density of a plane wave in mW/cm²

E_{tot} = total electric field strength in V/m

H_{tot} = total magnetic field strength in A/m



SYSTEM PERFORMANCE CHECK

Prior to the SAR evaluation a system check was performed with a 450 MHz dipole using the validation phantom. The dielectric parameters of the simulated brain fluid were measured prior to the system performance check using an 85070C Dielectric Probe Kit and an 8722D Network Analyzer. A forward power of 250mW was applied to the dipole and the system was verified to a tolerance of $\pm 10\%$.

Test Date	450MHz Equivalent Tissue	SAR 1g (W/kg)		Permittivity Constant ϵ_r		Conductivity σ (mho/m)		Ambient Temp. (C)	Fluid Temp. (C)	Fluid Depth (cm)
		Calibrated Target	Measured	IEEE Target	Measured	IEEE Target	Measured			
12/21/05	Head	1.32 \pm 5%	1.30	43.5 \pm 5%	46.1	0.87 \pm 10%	0.86	23.1	22.1	\geq 15
12/27/05	Head	1.32 \pm 5%	1.28	43.5 \pm 5%	46.0	0.87 \pm 10%	0.86	22.9	22.1	\geq 15

Note: The ambient and fluid temperatures were measured prior to the fluid parameter check and the system performance check. The temperatures listed in the table above were consistent for all measurement periods.

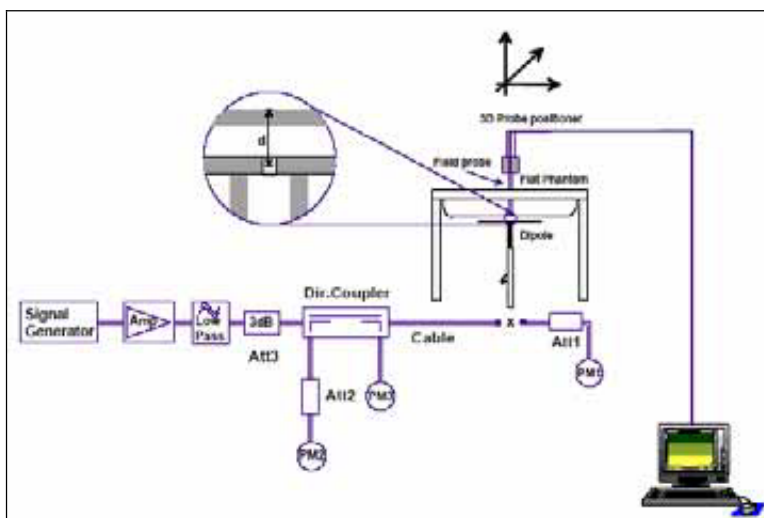

SIMULATED EQUIVALENT TISSUES

Simulated Tissue Mixture		
Ingredient	450MHz Head	450MHz Body
Water	38.56%	52.00%
Sugar	56.32%	45.65%
Salt	3.95%	1.75%
HEC	0.98%	0.50%
Bactericide	0.19%	0.10%



SAR SAFETY LIMITS

EXPOSURE LIMITS	SAR (W/kg)	
	(General Population / Uncontrolled Exposure Environment)	(Occupational / Controlled Exposure Environment)
Spatial Average (averaged over the whole body)	0.08	0.4
Spatial Peak (averaged over any 1g of tissue)	1.60	8.0
Spatial Peak (hands/wrists/feet/ankles averaged over 10g)	4.0	20.0

Notes:

1. Uncontrolled exposure environments are locations where there is potential exposure of individuals who have no knowledge or control of their potential exposure.
2. Controlled exposure environments are locations where there is potential exposure of individuals who have knowledge of their potential exposure and can exercise control over their exposure.



ROBOT SYSTEM SPECIFICATIONS

1.1. SPECIFICATIONS

Positioner:

Robot:	Staubli Unimation Corp. Robot Model: RX90
Repeatability:	0.02 mm
No. of axis:	6

1.2. DATA ACQUISITION ELECTRONIC (DAE) SYSTEM:

Cell Controller

Processor:	Compaq Evo Clock Speed:2.4 GHz Operating System: Windows XP Professional
------------	--

Data Converter

Features:	Signal Amplifier, multiplexer, A/D converter, and control logic
Software:	DASY4 software
Connecting Lines:	Optical downlink for data and status info. Optical uplink for commands and clock

Dasy4 Measurement Server

Function:	Real-time data evaluation for field measurements and surface detection
Hardware:	PC/104 166MHz Pentium CPU; 32 MB chipdisk; 64 MB RAM
Connections:	COM1, COM2, DAE, Robot, Ethernet, Service Interface

E-Field Probe

Model:	ET3DV6
Serial No.:	1793
Construction:	Triangular core fiber optic detection system
Frequency:	10 MHz to 6 GHz
Linearity:	± 0.2 dB (30 MHz to 3 GHz)

EX-Probe

Model:	EX3DV3
Serial No.	3511
Construction:	Triangular core
Frequency:	10 MHz to > 6 GHz
Linearity:	± 0.2 dB (30 MHz to 3 GHz)

1.3. PHANTOM(S):

Validation & Evaluation Phantom

Type:	SAM V4.0C
Shell Material:	Fiberglass
Thickness:	2.0 \pm 0.1 mm
Volume:	Approx. 20 liters



PROBE SPECIFICATIONS (ET3DV6)

Construction:	Symmetrical design with triangular core Built-in optical fiber for surface detection system Built-in shielding against static charges PEEK enclosure material (resistant to organic solvents, e.g. glycolether)
Calibration:	Basic Broadband calibration in air from 10 MHz to 3 GHz
Frequency:	10 MHz to 3 GHz; Linearity: ± 0.2 dB (30 MHz to 3 GHz)
Directivity:	± 0.2 dB in HSL (rotation around probe axis) ± 0.4 dB in HSL (rotation normal to probe axis)
Dynamic Range:	5μ W/g to > 100 mW/g; Linearity: ± 0.2 dB
Surface Detection:	± 0.2 mm repeatability in air and clear liquid over diffuse reflecting surfaces
Dimensions:	Overall length: 330 mm (Tip: 16 mm) Tip diameter (including protective cover): 6.8 mm (Body: 12 mm) Distance from probe tip to dipole centers: 2.7 mm
Application:	General dosimetric measurements up to 3 GHz Compliance tests of mobile phones Fast automatic scanning in arbitrary phantoms





SAR Measurement System

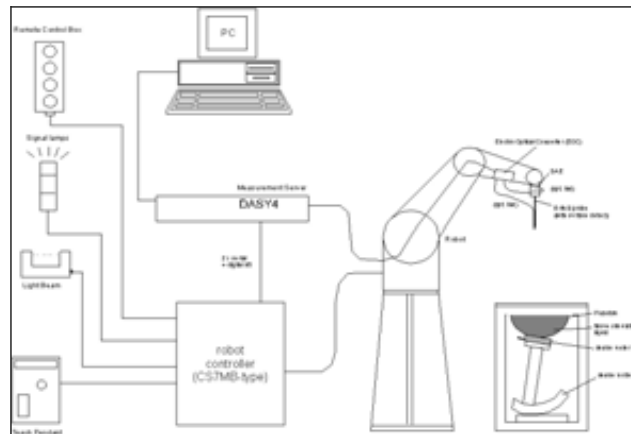

Measurement System Diagram

1.4. RX90BL ROBOT

The Stäubli RX90BL Robot is a standard high precision 6-axis robot with an arm extension for accommodating the data acquisition electronics (DAE).

1.5. ROBOT CONTROLLER

The CS7MB Robot Controller system drives the robot motors. The system consists of a power supply, robot controller, and remote control with teach pendant and additional circuitry for robot safety such as warning lamps, etc.

1.6. LIGHT BEAM SWITCH

The Light Beam Switch (Probe alignment tool) allows automatic "tooling" of the probe. During the process, the actual position of the probe tip with respect to the robot arm is measured as well as the probe length and the horizontal probe offset. The software then corrects all movements, so that the robot coordinates are valid for the probe tip. The repeatability of this process is better than 0.1 mm. If a position has been taught with an aligned probe, the same position will be reached with another aligned probe within 0.1 mm, even if the other probe has different dimensions. During probe rotations, the probe tip will keep its actual position.



1.7. DATA ACQUISITION ELECTRONICS

The Data Acquisition Electronics consists of a highly sensitive electrometer grade preamplifier with auto-zeroing, a channel and gain switching multiplexer, a fast 16-bit A/D converter and a command decoder and control logic unit. Some of the task the DAE performs is signal amplification, signal multiplexing, A/D conversion, and offset measurements. The DAE also contains the mechanical probe-mounting device, which contains two different sensor systems for frontal and sideways probe contacts used for probe collision detection and mechanical surface detection for controlling the distance between the probe and the inner surface of the phantom shell. Transmission from the DAE to the measurement server, via the EOC, is through an optical downlink for data and status information as well as an optical uplink for commands and the clock.





1.8. ELECTO-OPTICAL CONVERTER (EOC)

The Electro-Optical Converter performs the conversion between the optical and electrical of the signals for the digital communication to the DAE and for the analog signal from the optical surface detection. The EOC connects to, and transfers data to, the DASY4 measurement server. The EOC also contains the fiber optical surface detection system for controlling the distance between the probe and the inner surface of the phantom shell.



1.9. MEASUREMENT SERVER

The Measurement Server performs time critical tasks such as signal filtering, all real-time data evaluation for field measurements and surface detection, controls robot movements, and handles safety operation. The PC-operating system cannot interfere with these time critical processes. A watchdog supervises all connections, and disconnection of any of the cables to the measurement server will automatically disarm the robot and disable all program-controlled robot movements.



1.10. DOSIMETRIC PROBE

Dosimetric Probe is a symmetrical design with triangular core that incorporates three 3 mm long dipoles arranged so that the overall response is close to isotropic. The probe sensors are covered by an outer protective shell, which is resistant to organic solvents i.e. glycol. The probe is equipped with an optical multi-fiber line, ending at the front of the probe tip, for optical surface detection. This line connects to the EOC box on the robot arm and provides automatic detection of the phantom surface. The optical surface detection works in transparent liquids and on diffuse reflecting surfaces with a repeatability of better than ± 0.1 mm.



1.11. SAM PHANTOM

The SAM (Specific Anthropomorphic Mannequin) twin phantom is a fiberglass shell phantom with 2mm shell thickness (except the ear region where shell thickness increases to 6mm) integrated into a wooden table. The shape of the shell corresponds to the phantom defined by SCC34-SC2. It enables the dosimetric evaluation of left hand, right hand phone usage as well as body mounted usage at the flat phantom region. The flat section is also used for system validation and the length and width of the flat section are at least $0.75 \lambda_0$ and $0.6 \lambda_0$ respectively at frequencies of 824 MHz and above (λ_0 = wavelength in air).



Reference markings on the phantom top allow the complete setup of all predefined phantom positions and measurement grids by manually teaching three points in the robot. A white cover is provided to cover the phantom during off-periods preventing water evaporation and changes in the liquid parameters. Free space scans of devices on the cover are possible. The phantom is filled with a tissue simulating liquid to a depth of at least 15 cm at each ear reference point. The bottom plate of the wooden table contains three pair of bolts for locking the device holder.

1.12. PLANAR PHANTOM

The planar phantom is constructed of Plexiglas material with a 2.0 mm shell thickness for face-held and body-worn SAR evaluations of handheld radio transceivers. The outer dimensions of the planar phantom are 50cm x 50cm x 23cm. The planar phantom is mounted on the wooden table of the DASY4 system.





1.13. VALIDATION PLANAR PHANTOM

The validation planar phantom is constructed of Plexiglas material with a 6.0 mm shell thickness for system validations at 450MHz and below. The validation planar phantom is mounted on the wooden table of the DASY4 system.



1.14. SPLIT PLANAR PHANTOM

The Split Planar Phantom is constructed of Plexiglas material with a 2.0 mm shell thickness for face-held and body-worn SAR evaluations of handheld radio transceivers. The outer dimensions of each cell are 70cm x 20cm x 23cm and each side is separated by a 2.0mm Plexiglas wall. The Split Planar Phantom is mounted on the wooden table of the DASY4 system.



1.15. DEVICE HOLDER

The device holder is designed to cope with the different measurement positions in the three sections of the SAM phantom given in the standard. It has two scales, one for device rotation (with respect to the body axis) and one for device inclination (with respect to the line between the ear openings). The rotation center for both scales is the ear opening, thus the device needs no repositioning when changing the angles. The plane between the ear openings and the mouth tip has a rotation angle of 65°.



The DASY device holder has been made out of low-loss POM material having the following dielectric parameters: relative permittivity $\epsilon = 3$ and loss tangent $\delta = 0.02$. The amount of dielectric material has been reduced in the closest vicinity of the device, since measurements have suggested that the influence of the clamp on the test results could thus be lowered.

The dielectric properties of the liquid conform to all the tabulated values [2-5]. Liquids are prepared according to Annex A and dielectric properties are measured according to Annex B.

1.16. SYSTEM VALIDATION KITS

Power Capability: > 100 W ($f < 1\text{GHz}$); > 40 W ($f > 1\text{GHz}$)

Construction: Symmetrical dipole with 1/4 balun Enables measurement of feed point impedance with NWA Matched for use near flat phantoms filled with brain simulating solutions Includes distance holder and tripod adaptor.

Frequency: 300, 450, 835, 1900, 2450 MHz

Return loss: >20 dB at specified validation position

Dimensions: 300 MHz Dipole: Length: 396mm; Overall Height:430 mm; Diameter: 6 mm
450 MHz Dipole: Length: 270 mm; Overall Height: 347 mm; Diameter: 6 mm
835 MHz Dipole: Length: 161 mm; Overall Height: 270 mm; Diameter: 3.6 mm
1900 MHz Dipole: Length: 68 mm; Overall Height: 219 mm; Diameter: 3.6 mm
2450 MHz Dipole: Length: 51.5 mm; Overall Height: 300 mm; Diameter: 3.6 mm





TEST EQUIPMENT LIST

Test Equipment	Serial Number	Calibration Date
DASY4 System Robot ETVDV6 EX3DV3 DAE3 300MHz Dipole 450MHz Dipole 835MHz Dipole 1900MHz Dipole 2450MHz Dipole SAM Phantom V4.0C EUT Planar Phantom Validation Phantom	FO3/SX19A1/A/01 1793 3511 584 003 004 493 001 002 N/A N/A N/A	N/A Sept 2005 Jan 2004 Sept 2005 Dec 2004 Dec 2004 Sept 2005 June 2004 June 2004 N/A N/A N/A
85070D Dielectric Probe Kt	N/A	N/A
83650B Signal Generator	3844A00910	June 2005
HP E4418B Power Meter	GB40205140	June 2005
HP 8482A Power Sensor	2607A11286	June 2005
HP 8722D Vector Network Analyzer	3S36140188	March 2005
Anritsu Power Meter	6K00001832	June 2005
Anritsu Power Sensor	030864	Jan 2005
Mini-Circuits Power Amplifier	D111903#8	N/A



MEASUREMENT UNCERTAINTIES

UNCERTAINTY ASSESSMENT FOR EUT

Error Description	Uncertainty Value ±%	Probability Distribution	Divisor	c_i 1g	Standard Uncertainty ±% (1g)	v_i or v_{eff}
Measurement System						
Probe calibration	± 4.8	Normal	1	1	± 4.8	∞
Axial isotropy of the probe	± 4.6	Rectangular	$\sqrt{3}$	(1-cp)1/2	± 1.9	∞
Spherical isotropy of the probe	± 9.7	Rectangular	$\sqrt{3}$	(cp)1/2	± 3.9	∞
Boundary effects	± 8.5	Rectangular	$\sqrt{3}$	1	± 4.8	∞
Probe linearity	± 4.5	Rectangular	$\sqrt{3}$	1	± 2.7	∞
Detection limit	± 0.9	Rectangular	$\sqrt{3}$	1	± 0.6	∞
Readout electronics	± 1.0	Normal	1	1	± 1.0	∞
Response time	± 0.9	Rectangular	$\sqrt{3}$	1	± 0.5	∞
Integration time	± 1.2	Rectangular	$\sqrt{3}$	1	± 0.8	∞
RF ambient conditions	± 0.54	Rectangular	$\sqrt{3}$	1	± 0.43	∞
Mech. constraints of robot	± 0.5	Rectangular	$\sqrt{3}$	1	± 0.2	∞
Probe positioning	± 2.7	Rectangular	$\sqrt{3}$	1	± 1.7	∞
Extrapolation & integration	± 4.0	Rectangular	$\sqrt{3}$	1	± 2.3	∞
Test Sample Related						
Device positioning	± 2.2	Normal	1	1	± 2.23	11
Device holder uncertainty	± 5.0	Normal	1	1	± 5.0	7
Power drift	± 5.0	Rectangular	$\sqrt{3}$		± 2.9	∞
Phantom and Setup						
Phantom uncertainty	± 4.0	Rectangular	$\sqrt{3}$	1	± 2.3	∞
Liquid conductivity (target)	± 5.0	Rectangular	$\sqrt{3}$	0.6	± 1.7	∞
Liquid conductivity (measured)	± 5.0	Rectangular	$\sqrt{3}$	0.6	± 3.5./1.7	∞
Liquid permittivity (target)	± 5.0	Rectangular	$\sqrt{3}$	0.6	± 1.7	∞
Liquid permittivity (measured)	± 5.0	Rectangular	$\sqrt{3}$	0.6	± 1.7	∞
Combined Standard Uncertainty					± 12.14/11.7 6	
Coverage Factor for 95%		Kp=2				
Expanded Uncertainty (k=2)					± 24.29/23.5 1	

Table: Worst-case uncertainty for DASY4 assessed according to IEEE P1528.
The budget is valid for the frequency range 300MHz to 6GHz and represents a worst-case analysis.



UNCERTAINTY ASSESSMENT FOR SYSTEM VALIDATION

Error Description	Uncertainty Value ±%	Probability Distribution	Divisor	c_i 1g	Standard Uncertainty ±% (1g)	v_i or v_{eff}
Measurement System						
Probe calibration	± 4.8	Normal	1	1	± 4.8	∞
Axial isotropy of the probe	± 4.7	Rectangular	√3	(1-cp)1/2	± 2.7	∞
Spherical isotropy of the probe	± 9.6	Rectangular	√3	(cp)1/2	± 3.8	∞
Boundary effects	± 1.0	Rectangular	√3	1	± 0.0	∞
Probe linearity	± 4.7	Rectangular	√3	1	± 3.2	∞
Detection limit	± 1.0	Rectangular	√3	1	± 0.6	∞
Readout electronics	± 1.0	Normal	1	1	± 1.0	∞
Response time	± 0.8	Rectangular	√3	1	± 0.5	∞
Integration time	± 1.3	Rectangular	√3	1	± 0.8	∞
RF ambient conditions	± 3.0	Rectangular	√3	1	± 1.7	∞
Mech. constraints of robot	± 0.4	Rectangular	√3	1	± 0.2	∞
Probe positioning	± 1.4	Rectangular	√3	1	± 1.7	∞
Extrapolation & integration	± 4.0	Rectangular	√3	1	± 2.3	∞
Dipole						
Dipole Axis to liquid distance	± 2.0	Normal	1	1	± 1.2	11
Input Power	± 5.0	Normal	1	1	± 2.7	7
Phantom and Setup						
Phantom uncertainty	± 4.0	Rectangular	√3	1	± 2.3	∞
Liquid conductivity (target)	± 5.0	Rectangular	√3	0.6	± 1.7	∞
Liquid conductivity (measured)	± 5.0	Rectangular	√3	0.6	± 1.7	∞
Liquid permittivity (target)	± 5.0	Rectangular	√3	0.6	± 1.7	∞
Liquid permittivity (measured)	± 5.0	Rectangular	√3	0.6	± 1.7	∞
Combined Standard Uncertainty					± 9.8	
Coverage Factor for 95%		Kp=2				
Expanded Uncertainty (k=2)					± 19.7	



REFERENCES

- [1] Federal Communications Commission, ET Docket 93-62, Guidelines for Evaluating the Environmental Effects of Radiofrequency Radiation, Aug. 1996.
- [2] ANSI/IEEE C95.1 - 1999, American National Standard safety levels with respect to human exposure to radio frequency electromagnetic fields, 300kHz to 100GHz, New York: IEEE, Aug. 1992.
- [3] ANSI/IEEE C95.3 - 1991, IEEE Recommended Practice for the Measurement of Potentially Hazardous Electromagnetic Fields - RF and Microwave, New York: IEEE, 1992.
- [4] Federal Communications Commission, OET Bulletin 65 (Edition 97-01), Supplement C (Edition 01-01), Evaluating Compliance with FCC Guidelines for Human Exposure to Radiofrequency Electromagnetic Fields, July 2001.
- [5] IEEE Standards Coordinating Committee 34, IEEE 1528 (August 2003), Recommended Practice for Determining the Peak Spatial-Average Specific Absorption Rate (SAR) in the Human Body Due to Wireless Communications Devices.
- [6] NCRP, National Council on Radiation Protection and Measurements, Biological Effects and Exposure Criteria for RadioFrequency Electromagnetic Fields, NCRP Report No. 86, 1986. Reprinted Feb.1995.
- [7] T. Schmid, O. Egger, N. Kuster, Automated E-field scanning system for dosimetric assessments, IEEE Transaction on Microwave Theory and Techniques, vol. 44, Jan. 1996, pp. 105-113.
- [8] K. Pokovic, T. Schmid, N. Kuster, Robust setup for precise calibration of E-field probes in tissue simulating liquids at mobile communications frequencies, ICECOM97, Oct. 1997, pp. 120-124.
- [9] K. Pokovic, T. Schmid, and N. Kuster, E-field Probe with improved isotropy in brain simulating liquids, Proceedings of the ELMAR, Zadar, Croatia, June 23-25, 1996, pp. 172-175.
- [10] Schmid & Partner Engineering AG, Application Note: Data Storage and Evaluation, June 1998, p2.
- [11] V. Hombach, K. Meier, M. Burkhardt, E. Kuhn, N. Kuster, The Dependence of EM Energy Absorption upon Human Head Modeling at 900 MHz , IEEE Transaction on Microwave Theory and Techniques, vol. 44 no. 10, Oct. 1996, pp. 1865-1873.
- [12] N. Kuster and Q. Balzano, Energy absorption mechanism by biological bodies in the near field of dipole antennas above 300MHz , IEEE Transaction on Vehicular Technology, vol. 41, no. 1, Feb. 1992, pp. 17-23.
- [13] G. Hartsgrove, A. Kraszewski, A. Surowiec, Simulated Biological Materials for Electromagnetic Radiation Absorption Studies, University of Ottawa, Bioelectromagnetics, Canada: 1987, pp. 29-36.
- [14] Q. Balzano, O. Garay, T. Manning Jr., Electromagnetic Energy Exposure of Simulated Users of Portable Cellular Telephones, IEEE Transactions on Vehicular Technology, vol. 44, no.3, Aug. 1995.
- [15] W. Gander, Computermathematick, Birkhaeuser, Basel, 1992.
- [16] W.H. Press, S.A. Teukolsky, W.T. Vetterling, and B.P. Flannery, Numerical Receptions in C, The Art of Scientific Computing, Second edition, Cambridge University Press, 1992.
- [17] N. Kuster, R. Kastle, T. Schmid, Dosimetric Evaluation Of Mobile Communications Equipment With Known Precision, IEEE Transaction on Communications, vol. E80-B, no. 5, May 1997, pp. 645-652.
- [18] CENELEC CLC/SC111B, European Prestandard (prENV 50166-2), Human Exposure to Electromagnetic Fields High-frequency: 10kHz - 300GHz, Jan. 1995.
- [19] Prof. Dr. Niels Kuster, ETH, Eidgen ssische Technische Hochschule Zurich, Dosimetric Evaluation of the Cellular Phone.
- [20] Federal Communications Commission, Radiofrequency radiation exposure evaluation: portable devices, Rule Part 47 CFR 2.1093: 1999.
- [21] Health Canada, Limits of Human Exposure to Radiofrequency Electromagnetic Fields in the Frequency Range from 3 kHz to 300 GHz , Safety Code 6.
- [22] Industry Canada, Evaluation Procedure for Mobile and Portable Radio Transmitters with respect to Health Canada's Safety Code 6 for Exposure of Humans to Radio Frequency Fields, Radio Standards Specification RSS-102 Issue 1 (Provisional): September 1999.



Kenwood Communications Corporation
TK-5300

Electromagnetic Compatibility
FCC OET 65 Supplement C: 01-01

Appendix A – EUT SETUP PHOTOS



Face SAR with KRA-23M antenna and Thick Battery



Face SAR with KRA-23M antenna and Thick Battery



Face SAR with KRA-23M antenna and Slim Battery



Face SAR with KRA-23M antenna and Slim Battery



Body SAR with KRA-23M antenna, KBH-10 Belt Clip and Thick Battery



Body SAR with KRA-23M antenna, KBH-10 Belt Clip and Thick Battery



Body SAR with KRA-23M antenna, KBH-10 Belt Clip and Slim Battery



Body SAR with KRA-23M antenna, KBH-10 Belt Clip and Slim Battery



Body SAR with KRA-23M antenna, KBH-10 Belt Clip and Thick Battery



Body SAR with KRA-23M antenna, KBH-11 Belt Clip and Thick Battery



Body SAR with KRA-23M antenna, KBH-11 Belt Clip and Slim Battery



Body SAR with KRA-23M antenna, KBH-11 Belt Clip and Slim Battery



Body SAR with KRA-27M antenna, KBH-10 Belt Clip and Slim Battery

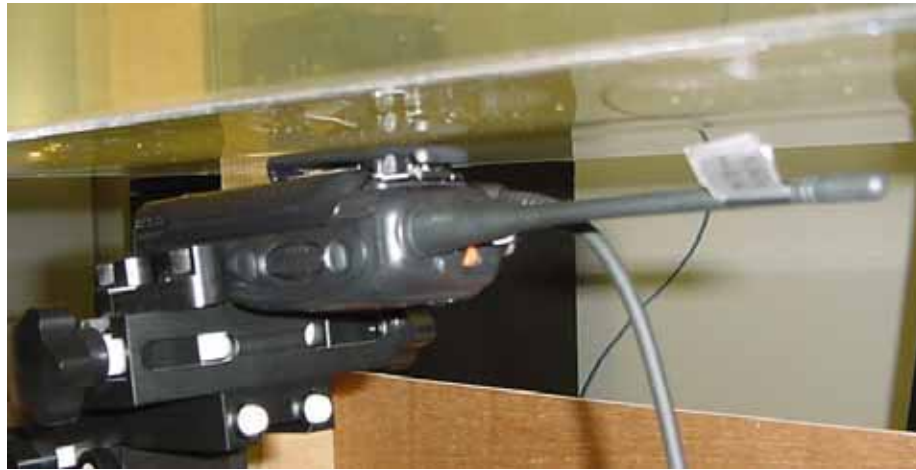

Body SAR with KRA-27M antenna, KBH-10 Belt Clip and Thick Battery



Body SAR with KRA-27M antenna, KBH-10 Belt Clip and Slim Battery



Body SAR with KRA-27M antenna, KBH-10 Belt Clip and Thick Battery



Body SAR with KRA-27M antenna, KBH-11 Belt Clip and Slim Battery



Body SAR with KRA-27M antenna, KBH-11 Belt Clip and Slim Battery



Body SAR with KRA-27M antenna, KBH-11 Belt Clip and Thick Battery



Body SAR with KRA-27M antenna, KBH-11 Belt Clip and Thick Battery



Face SAR with KRA-27M antenna and Thick Battery



Face SAR with KRA-27M antenna and Thin Battery

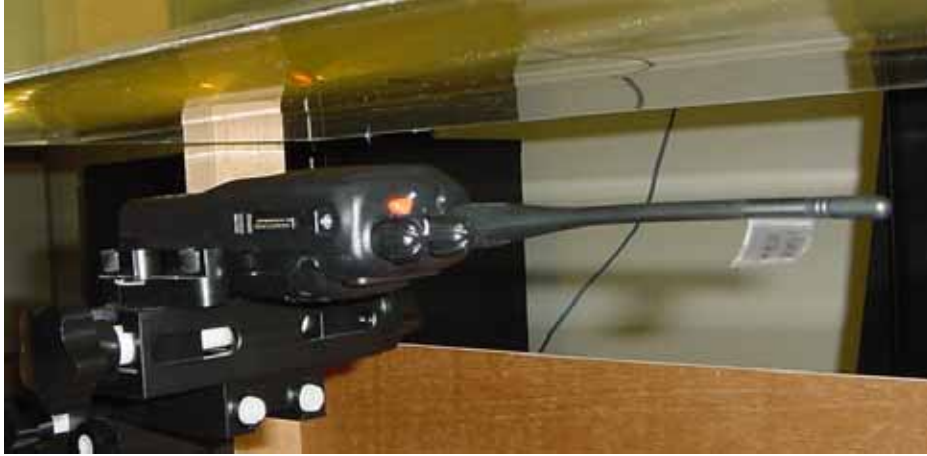

Face SAR with KRA-27M antenna and Thick Battery



Face SAR with KRA-27M antenna and Thick Battery Style



Kenwood Communications Corporation
TK-5300

Electromagnetic Compatibility
FCC OET 65 Supplement C: 01-01

Appendix B – EUT PHOTOS



TK-5300 with KRA-27M Antenna and KNB-33L Battery



TK-5300 with KRA-23M Antenna and KNB-33L Battery



Back of EUT



TK-5300 with KMC-25 Speaker Microphone



KNB-31A, KNB-33L, KNB-32N, KBP-6 Battery Packs



KNB-31A, KNB-33L, KNB-32N, KBP-6 Battery Packs



KRA-23 and KRA-27 Antennas



KBH-10 and KBH-11 Belt Clips



KBH-10 Belt Clip with Thick and Slim Battery types



KBH-11 Belt Clip with Thick and Slim Battery types



Kenwood Communications Corporation
TK-5300

Electromagnetic Compatibility
FCC OET 65 Supplement C: 01-01

Appendix C – SAR MEASUREMENT DATA

Mid Ch Face SAR Battery: KNB-32N; Antenna: KRA-27M

Date/Time: 12/21/2005 9:07:11 AM

DUT: Kenwood; Type: TK-5300; Serial: N/A

Medium Notes: Ambient Temp: 23.0 deg C; Fluid Temp: 22.6 deg C

Communication System: CW; ; Frequency: 450 MHz;Duty Cycle: 1:1

Medium: 450MHz head Medium parameters used: $f = 450 \text{ MHz}$; $\sigma = 0.86 \text{ mho/m}$; $\epsilon_r = 46.1$; $\rho = 1000$

kg/m^3

Phantom section: Flat Section

Probe: ET3DV6 - SN1793; ConvF(7.6, 7.6, 7.6); Calibrated: 9/20/2005

Sensor-Surface: 4mm (Mechanical Surface Detection)

Electronics: DAE3 Sn584; Calibrated: 9/22/2005

Phantom: Twin Box HSL; Type: HSL; Serial: 001

Measurement SW: DASY4, V4.5 Build 19; Postprocessing SW: SEMCAD, V1.8 Build 146

Area Scan (61x201x1): Measurement grid: $dx=15\text{mm}$, $dy=15\text{mm}$

Maximum value of SAR (interpolated) = 5.11 mW/g

Zoom Scan (7x7x7)/Cube 0: Measurement grid: $dx=5\text{mm}$, $dy=5\text{mm}$, $dz=5\text{mm}$

Reference Value = 76.1 V/m; Power Drift = -0.397 dB

Peak SAR (extrapolated) = 7.40 W/kg

SAR(1 g) = 4.8 mW/g; SAR(10 g) = 3.5 mW/g

Maximum value of SAR (measured) = 4.99 mW/g

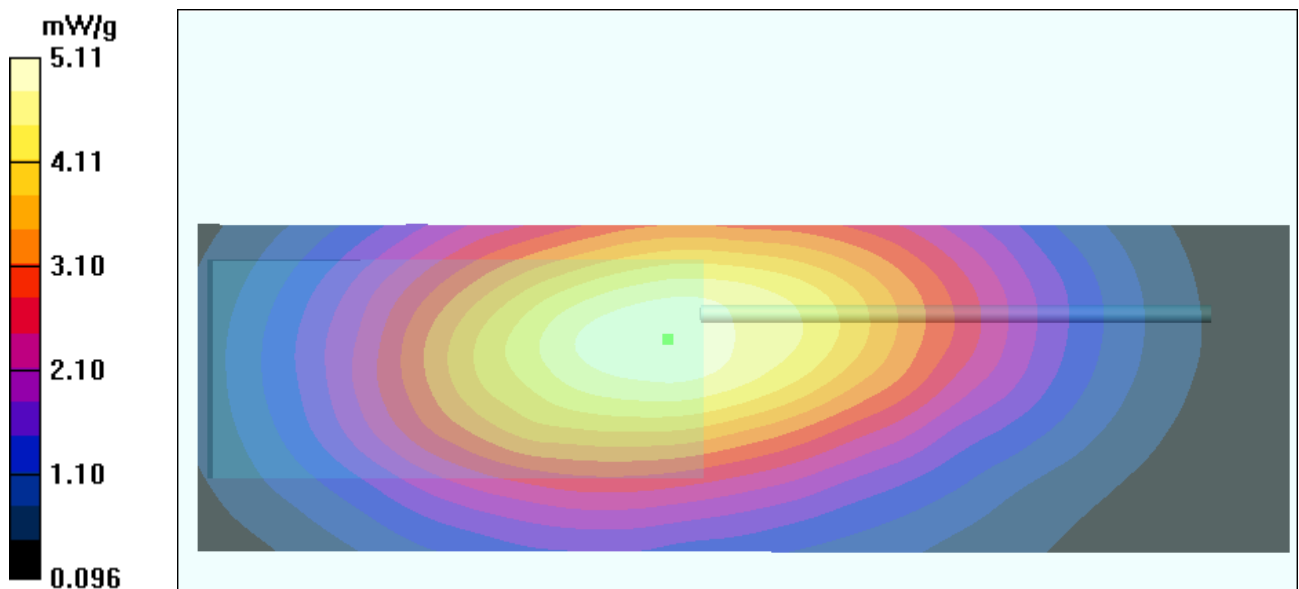

Mid Ch Face

KNB-32N and KRA-27M

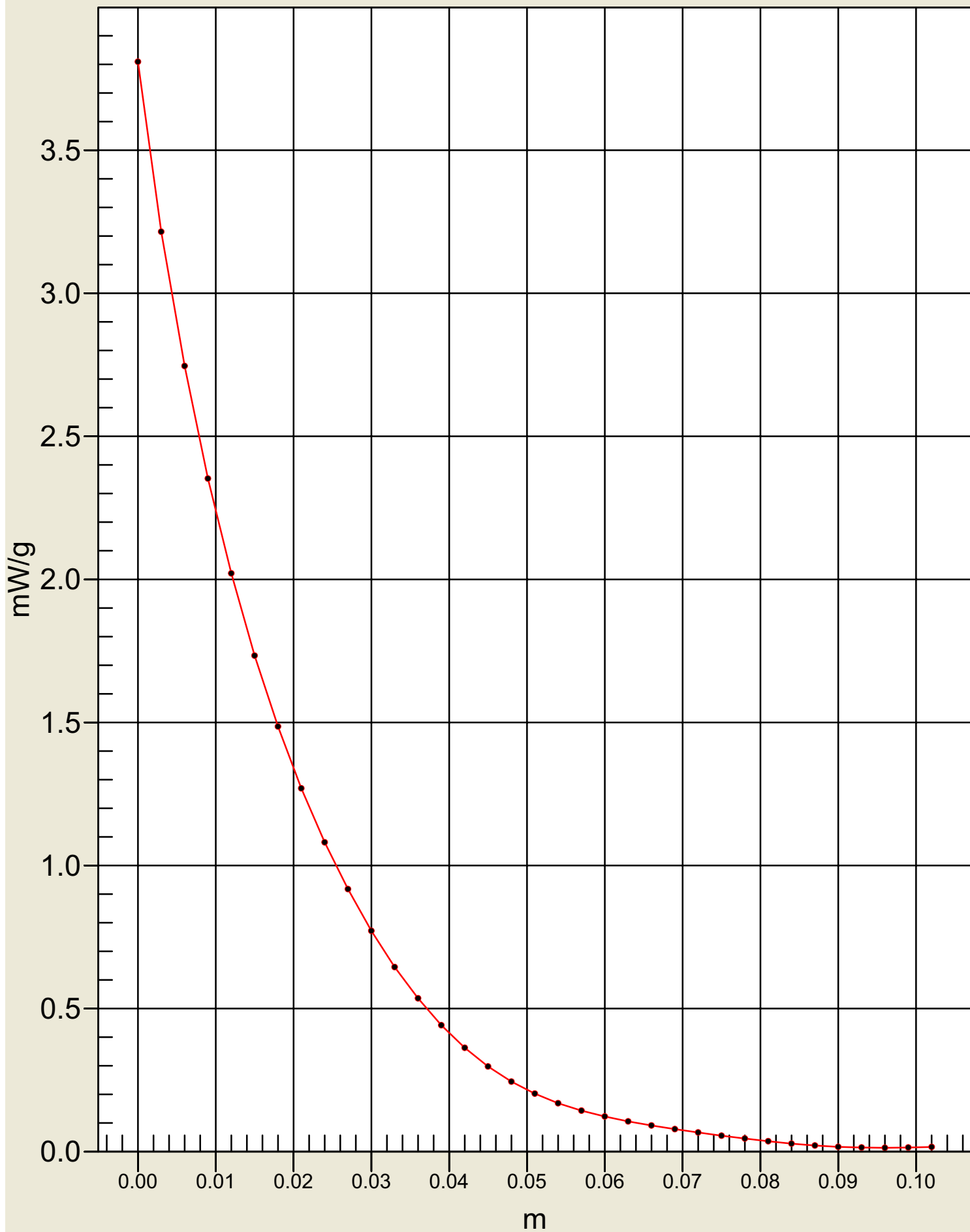

Mid Ch Face SAR Battery: KNB-32N; Antenna: KRA-27M

Date/Time: 12/21/2005 9:37:55 AM

DUT: Kenwood; Type: TK-5300; Serial: N/A

Medium Notes: Ambient Temp: 23.0 deg C; Fluid Temp: 22.6 deg C

Communication System: CW; ; Frequency: 450 MHz; Duty Cycle: 1:1

Medium: 450MHz head Medium parameters used: $f = 450 \text{ MHz}$; $\sigma = 0.86 \text{ mho/m}$; $\epsilon_r = 46.1$; $\rho = 1000$

kg/m^3

Phantom section: Flat Section

Probe: ET3DV6 - SN1793; ConvF(7.6, 7.6, 7.6); Calibrated: 9/20/2005

Sensor-Surface: 4mm (Mechanical Surface Detection)

Electronics: DAE3 Sn584; Calibrated: 9/22/2005

Phantom: Twin Box HSL; Type: HSL; Serial: 001

Measurement SW: DASY4, V4.5 Build 19; Postprocessing SW: SEMCAD, V1.8 Build 146

Area Scan (61x201x1): Measurement grid: $dx=15\text{mm}$, $dy=15\text{mm}$

Maximum value of SAR (interpolated) = 4.96 mW/g

Zoom Scan (7x7x7)/Cube 0: Measurement grid: $dx=5\text{mm}$, $dy=5\text{mm}$, $dz=5\text{mm}$

Reference Value = 73.4 V/m; Power Drift = -0.432 dB

Peak SAR (extrapolated) = 7.35 W/kg

SAR(1 g) = 4.76 mW/g; SAR(10 g) = 3.44 mW/g

Maximum value of SAR (measured) = 4.97 mW/g

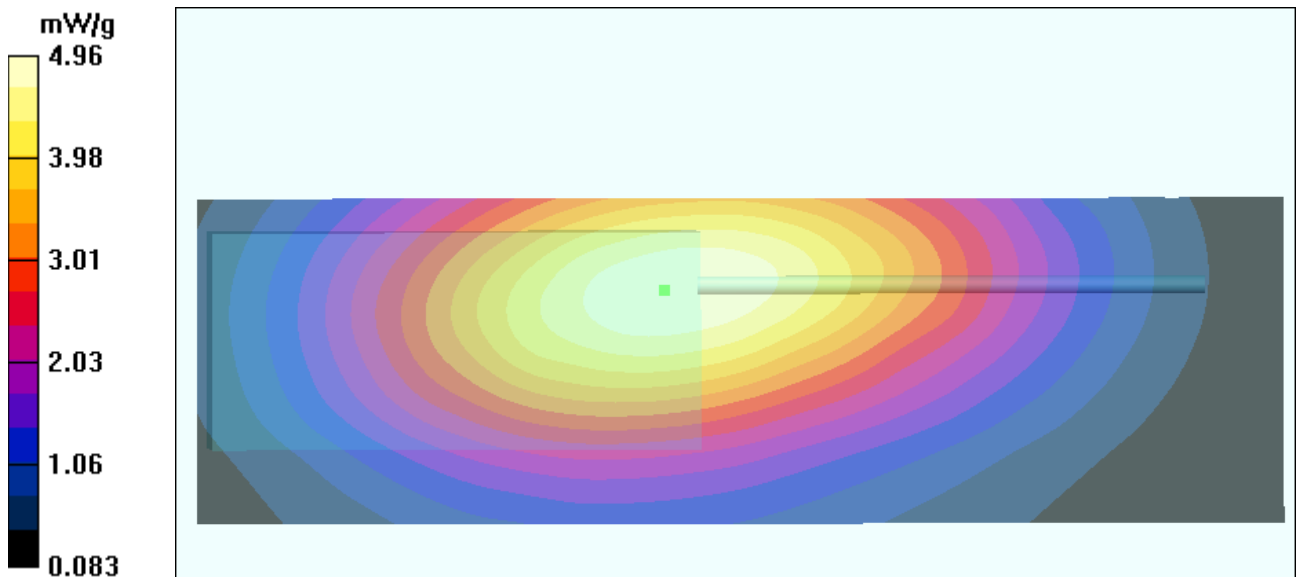

Mid Ch Face SAR Battery: KNB-31A; Antenna: KRA-27M

Date/Time: 12/27/2005 9:37:55 AM

DUT: Kenwood; Type: TK-5300; Serial: N/A

Medium Notes: Ambient Temp: 23.1 deg C; Fluid Temp: 22.7 deg C

Communication System: CW; ; Frequency: 450 MHz; Duty Cycle: 1:1

Medium: 450MHz head Medium parameters used: $f = 450 \text{ MHz}$; $\sigma = 0.86 \text{ mho/m}$; $\epsilon_r = 46.0$; $\rho = 1000$

kg/m^3

Phantom section: Flat Section

Probe: ET3DV6 - SN1793; ConvF(7.6, 7.6, 7.6); Calibrated: 9/20/2005

Sensor-Surface: 4mm (Mechanical Surface Detection)

Electronics: DAE3 Sn584; Calibrated: 9/22/2005

Phantom: Twin Box HSL; Type: HSL; Serial: 001

Measurement SW: DASY4, V4.5 Build 19; Postprocessing SW: SEMCAD, V1.8 Build 146

Area Scan (61x201x1): Measurement grid: $dx=15\text{mm}$, $dy=15\text{mm}$

Maximum value of SAR (interpolated) = 4.85 mW/g

Zoom Scan (7x7x7)/Cube 0: Measurement grid: $dx=5\text{mm}$, $dy=5\text{mm}$, $dz=5\text{mm}$

Reference Value = 73.4 V/m; Power Drift = -0.362 dB

Peak SAR (extrapolated) = 7.19 W/kg

SAR(1 g) = 4.65 mW/g; SAR(10 g) = 3.36 mW/g

Maximum value of SAR (measured) = 4.86 mW/g

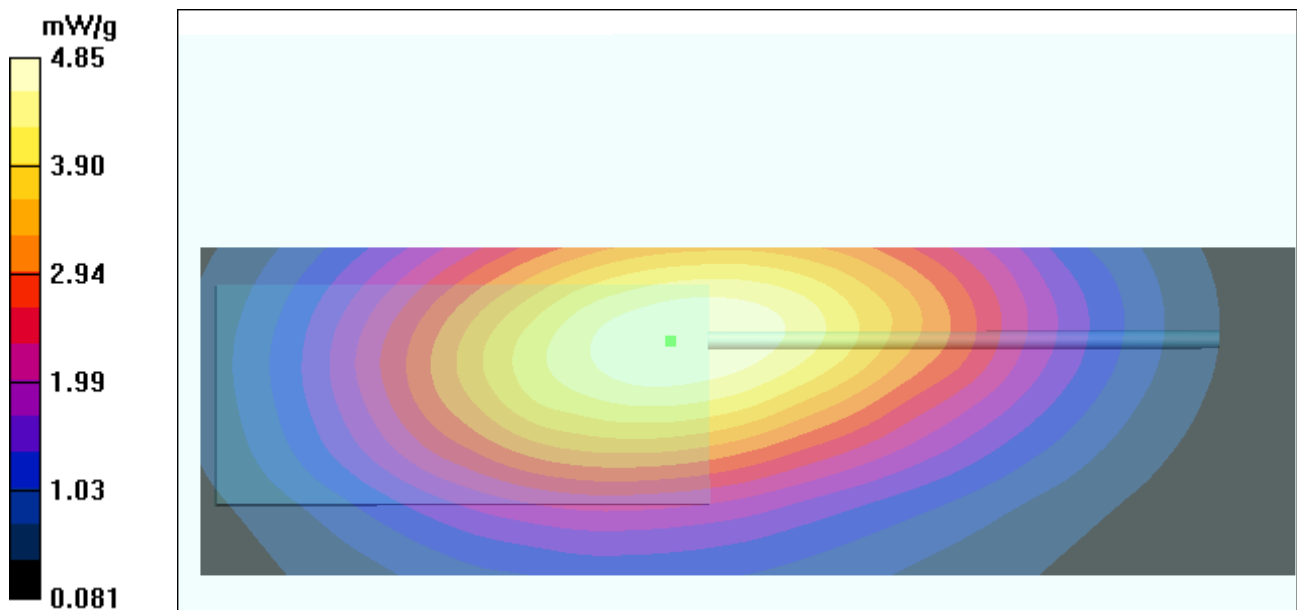

Low Ch Face SAR Battery: KNB-32N; Antenna: KRA-27M

Date/Time: 12/27/2005 11:10:00 AM

DUT: Kenwood; Type: TK-5300; Serial: N/A

Medium Notes: Ambient Temp: 23.1 deg C; Fluid Temp: 22.7 deg C

Communication System: CW; ; Frequency: 450 MHz; Duty Cycle: 1:1

Medium: 450MHz head Medium parameters used: $f = 450 \text{ MHz}$; $\sigma = 0.86 \text{ mho/m}$; $\epsilon_r = 46.0$; $\rho = 1000$

kg/m^3

Phantom section: Flat Section

Probe: ET3DV6 - SN1793; ConvF(7.6, 7.6, 7.6); Calibrated: 9/20/2005

Sensor-Surface: 4mm (Mechanical Surface Detection)

Electronics: DAE3 Sn584; Calibrated: 9/22/2005

Phantom: Twin Box HSL; Type: HSL; Serial: 001

Measurement SW: DASY4, V4.5 Build 19; Postprocessing SW: SEMCAD, V1.8 Build 146

Area Scan (61x201x1): Measurement grid: $dx=15\text{mm}$, $dy=15\text{mm}$

Maximum value of SAR (interpolated) = 4.35 mW/g

Zoom Scan (7x7x7)/Cube 0: Measurement grid: $dx=5\text{mm}$, $dy=5\text{mm}$, $dz=5\text{mm}$

Reference Value = 69.0 V/m; Power Drift = -0.290 dB

Peak SAR (extrapolated) = 6.36 W/kg

SAR(1 g) = 4.15 mW/g; SAR(10 g) = 3.04 mW/g

Maximum value of SAR (measured) = 4.36 mW/g

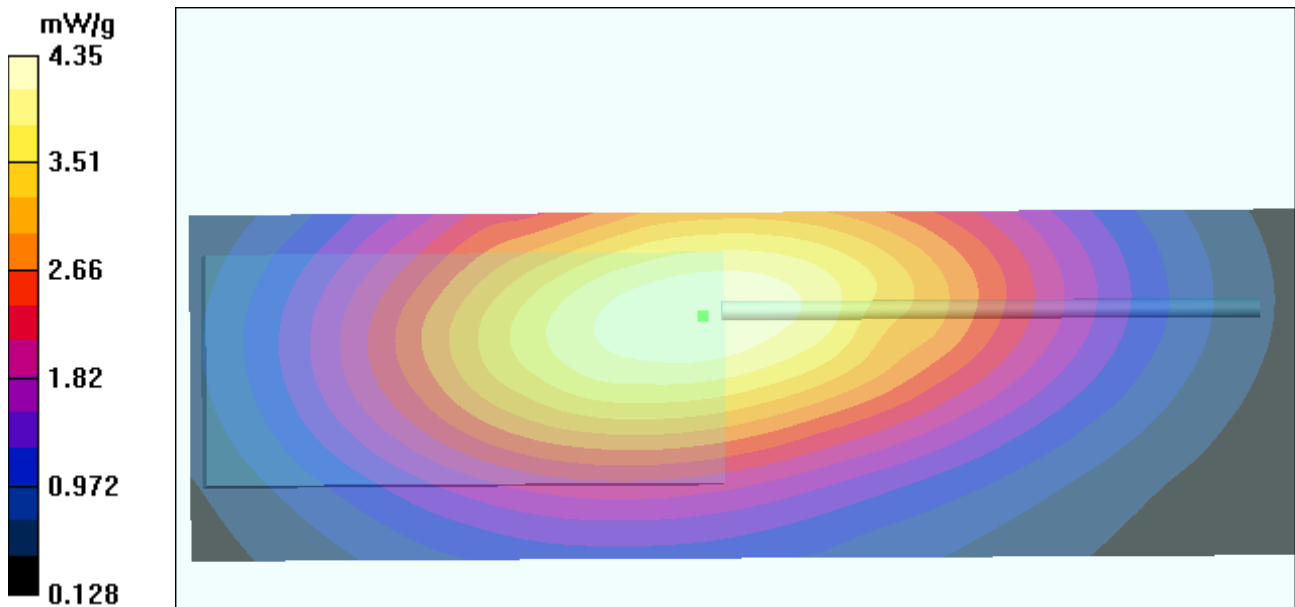

High Ch Face SAR Battery: KNB-32N; Antenna: KRA-27M

Date/Time: 12/27/2005 11:31:56 AM

DUT: Kenwood; Type: TK-5300; Serial: N/A

Medium Notes: Ambient Temp: 23.1 deg C; Fluid Temp: 22.7 deg C

Communication System: CW; ; Frequency: 450 MHz; Duty Cycle: 1:1

Medium: 450MHz head Medium parameters used: $f = 450 \text{ MHz}$; $\sigma = 0.86 \text{ mho/m}$; $\epsilon_r = 46.0$; $\rho = 1000$

kg/m^3

Phantom section: Flat Section

Probe: ET3DV6 - SN1793; ConvF(7.6, 7.6, 7.6); Calibrated: 9/20/2005

Sensor-Surface: 4mm (Mechanical Surface Detection)

Electronics: DAE3 Sn584; Calibrated: 9/22/2005

Phantom: Twin Box HSL; Type: HSL; Serial: 001

Measurement SW: DASY4, V4.5 Build 19; Postprocessing SW: SEMCAD, V1.8 Build 146

Area Scan (61x201x1): Measurement grid: $dx=15\text{mm}$, $dy=15\text{mm}$

Maximum value of SAR (interpolated) = 4.22 mW/g

Zoom Scan (7x7x7)/Cube 0: Measurement grid: $dx=5\text{mm}$, $dy=5\text{mm}$, $dz=5\text{mm}$

Reference Value = 70.2 V/m; Power Drift = -0.420 dB

Peak SAR (extrapolated) = 6.17 W/kg

SAR(1 g) = 3.98 mW/g; SAR(10 g) = 2.89 mW/g

Maximum value of SAR (measured) = 4.15 mW/g

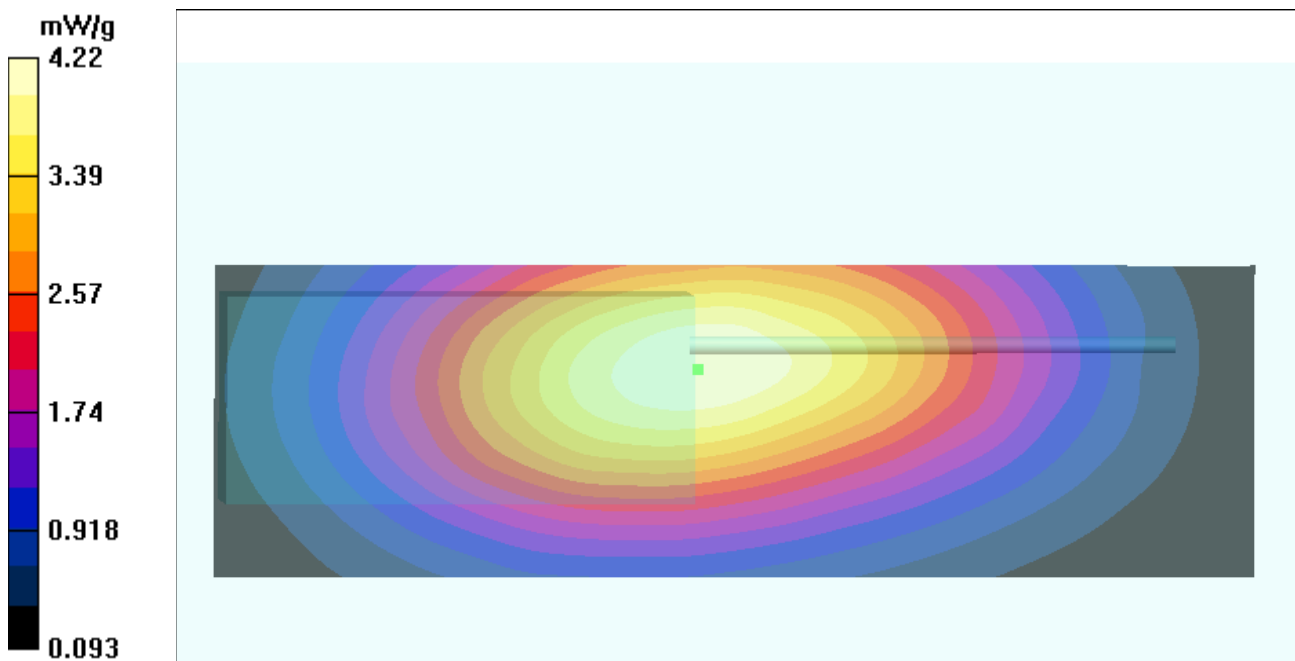

Mid Ch Face SAR Battery: KNB-32N; Antenna: KRA-23M

Date/Time: 12/27/2005 11:53:51 AM

DUT: Kenwood; Type: TK-5300; Serial: N/A

Medium Notes: Ambient Temp: 23.1 deg C; Fluid Temp: 22.7 deg C

Communication System: CW; ; Frequency: 450 MHz; Duty Cycle: 1:1

Medium: 450MHz head Medium parameters used: $f = 450 \text{ MHz}$; $\sigma = 0.86 \text{ mho/m}$; $\epsilon_r = 46.0$; $\rho = 1000$

kg/m^3

Phantom section: Flat Section

Probe: ET3DV6 - SN1793; ConvF(7.6, 7.6, 7.6); Calibrated: 9/20/2005

Sensor-Surface: 4mm (Mechanical Surface Detection)

Electronics: DAE3 Sn584; Calibrated: 9/22/2005

Phantom: Twin Box HSL; Type: HSL; Serial: 001

Measurement SW: DASY4, V4.5 Build 19; Postprocessing SW: SEMCAD, V1.8 Build 146

Area Scan (61x201x1): Measurement grid: $dx=15\text{mm}$, $dy=15\text{mm}$

Maximum value of SAR (interpolated) = 4.61 mW/g

Zoom Scan (7x7x7)/Cube 0: Measurement grid: $dx=5\text{mm}$, $dy=5\text{mm}$, $dz=5\text{mm}$

Reference Value = 71.7 V/m; Power Drift = -0.359 dB

Peak SAR (extrapolated) = 6.66 W/kg

SAR(1 g) = 4.34 mW/g; SAR(10 g) = 3.16 mW/g

Maximum value of SAR (measured) = 4.51 mW/g

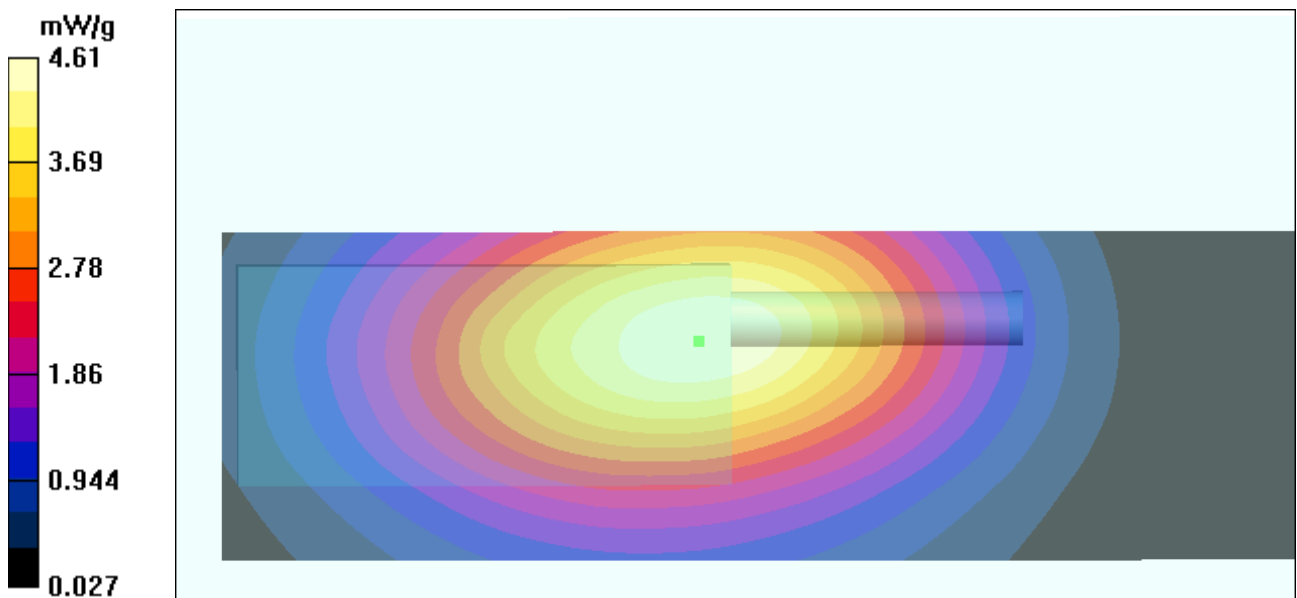

Mid Ch Face SAR Battery: KNB-33L; Antenna: KRA-23M

Date/Time: 12/27/2005 12:15:41 PM

DUT: Kenwood; Type: TK-5300; Serial: N/A

Medium Notes: Ambient Temp: 23.1 deg C; Fluid Temp: 22.7 deg C

Communication System: CW; ; Frequency: 450 MHz; Duty Cycle: 1:1

Medium: 450MHz head Medium parameters used: $f = 450 \text{ MHz}$; $\sigma = 0.86 \text{ mho/m}$; $\epsilon_r = 46.0$; $\rho = 1000$

kg/m^3

Phantom section: Flat Section

Probe: ET3DV6 - SN1793; ConvF(7.6, 7.6, 7.6); Calibrated: 9/20/2005

Sensor-Surface: 4mm (Mechanical Surface Detection)

Electronics: DAE3 Sn584; Calibrated: 9/22/2005

Phantom: Twin Box HSL; Type: HSL; Serial: 001

Measurement SW: DASY4, V4.5 Build 19; Postprocessing SW: SEMCAD, V1.8 Build 146

Area Scan (61x201x1): Measurement grid: $dx=15\text{mm}$, $dy=15\text{mm}$

Maximum value of SAR (interpolated) = 3.57 mW/g

Zoom Scan (7x7x7)/Cube 0: Measurement grid: $dx=5\text{mm}$, $dy=5\text{mm}$, $dz=5\text{mm}$

Reference Value = 62.2 V/m; Power Drift = -0.247 dB

Peak SAR (extrapolated) = 5.19 W/kg

SAR(1 g) = 3.41 mW/g; SAR(10 g) = 2.49 mW/g

Maximum value of SAR (measured) = 3.56 mW/g

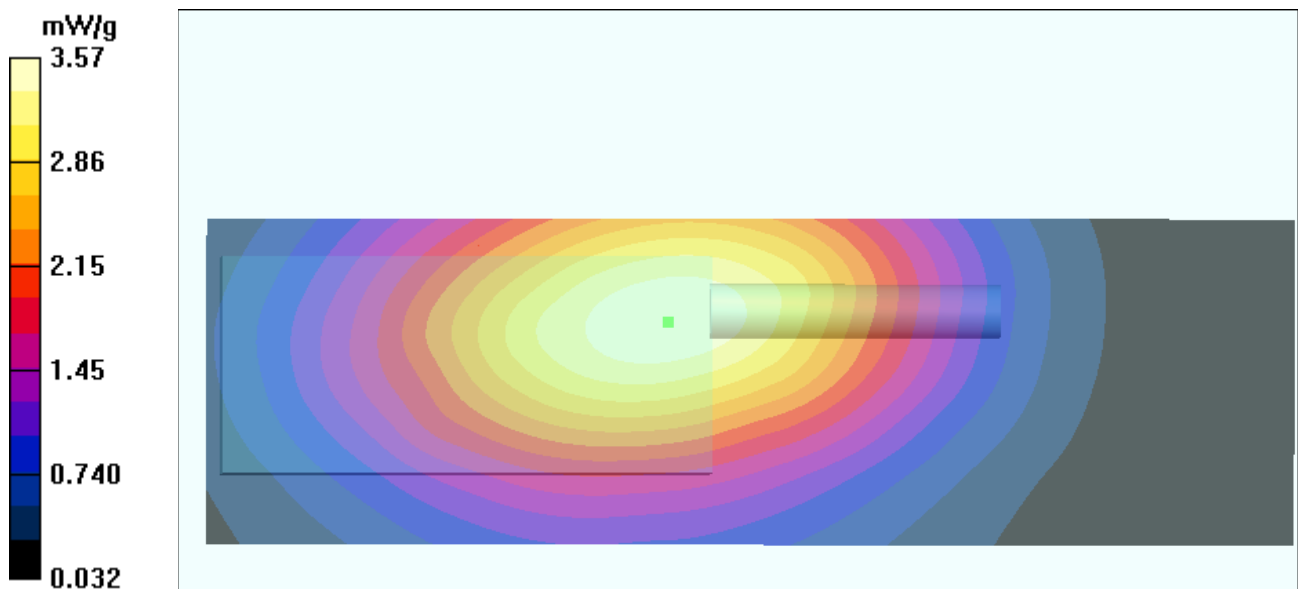

Mid Ch Face SAR Battery: KNB-31A; Antenna: KRA-23M

Date/Time: 12/27/2005 12:35:11 PM

DUT: Kenwood; Type: TK-5300; Serial: N/A

Medium Notes: Ambient Temp: 23.1 deg C; Fluid Temp: 22.7 deg C

Communication System: CW; ; Frequency: 450 MHz;Duty Cycle: 1:1

Medium: 450MHz head Medium parameters used: $f = 450 \text{ MHz}$; $\sigma = 0.86 \text{ mho/m}$; $\epsilon_r = 46.0$; $\rho = 1000$

kg/m^3

Phantom section: Flat Section

Probe: ET3DV6 - SN1793; ConvF(7.6, 7.6, 7.6); Calibrated: 9/20/2005

Sensor-Surface: 4mm (Mechanical Surface Detection)

Electronics: DAE3 Sn584; Calibrated: 9/22/2005

Phantom: Twin Box HSL; Type: HSL; Serial: 001

Measurement SW: DASY4, V4.5 Build 19; Postprocessing SW: SEMCAD, V1.8 Build 146

Area Scan (61x201x1): Measurement grid: $dx=15\text{mm}$, $dy=15\text{mm}$

Maximum value of SAR (interpolated) = 3.48 mW/g

Zoom Scan (7x7x7)/Cube 0: Measurement grid: $dx=5\text{mm}$, $dy=5\text{mm}$, $dz=5\text{mm}$

Reference Value = 62.2 V/m; Power Drift = -0.221 dB

Peak SAR (extrapolated) = 5.07 W/kg

SAR(1 g) = 3.33 mW/g; SAR(10 g) = 2.43 mW/g

Maximum value of SAR (measured) = 3.48 mW/g

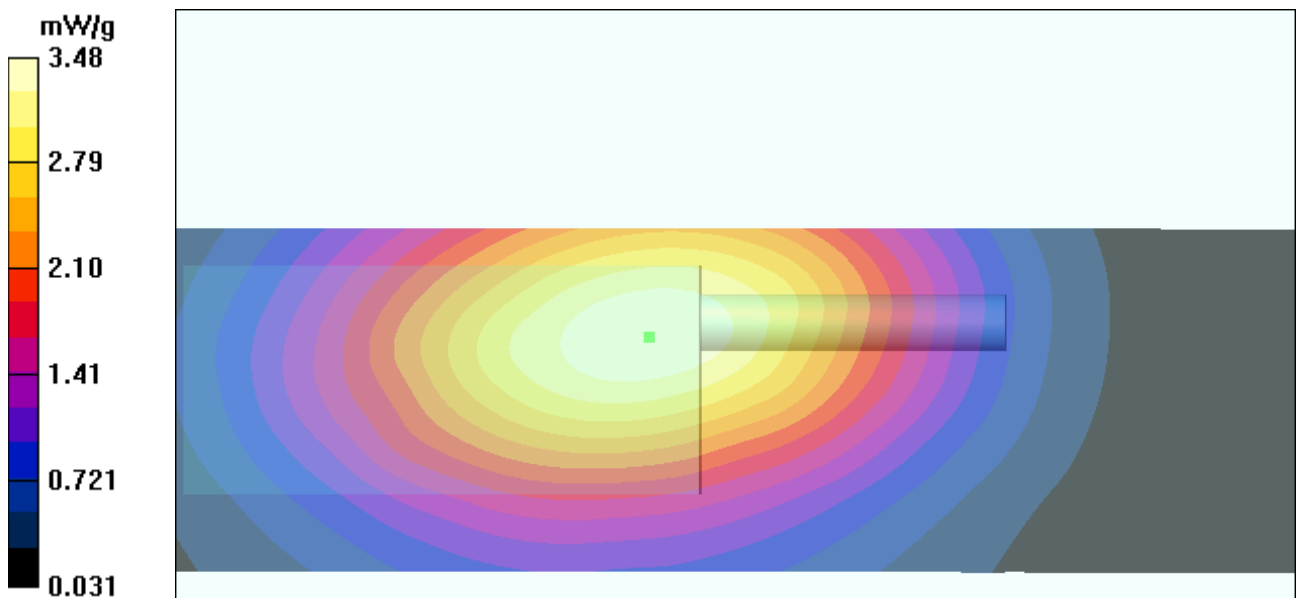

Low Ch Face SAR Battery: KNB-32N; Antenna: KRA-23M

Date/Time: 12/27/2005 12:59:38 PM

DUT: Kenwood; Type: TK-5300; Serial: N/A

Medium Notes: Ambient Temp: 23.1 deg C; Fluid Temp: 22.7 deg C

Communication System: CW; ; Frequency: 450 MHz; Duty Cycle: 1:1

Medium: 450MHz head Medium parameters used: $f = 450$ MHz; $\sigma = 0.86$ mho/m; $\epsilon_r = 46.0$; $\rho = 1000$

kg/m³

Phantom section: Flat Section

Probe: ET3DV6 - SN1793; ConvF(7.6, 7.6, 7.6); Calibrated: 9/20/2005

Sensor-Surface: 4mm (Mechanical Surface Detection)

Electronics: DAE3 Sn584; Calibrated: 9/22/2005

Phantom: Twin Box HSL; Type: HSL; Serial: 001

Measurement SW: DASY4, V4.5 Build 19; Postprocessing SW: SEMCAD, V1.8 Build 146

Area Scan (61x201x1): Measurement grid: dx=15mm, dy=15mm

Maximum value of SAR (interpolated) = 4.94 mW/g

Zoom Scan (7x7x7)/Cube 0: Measurement grid: dx=5mm, dy=5mm, dz=5mm

Reference Value = 73.4 V/m; Power Drift = -0.437 dB

Peak SAR (extrapolated) = 7.06 W/kg

SAR(1 g) = 4.65 mW/g; SAR(10 g) = 3.4 mW/g

Maximum value of SAR (measured) = 4.82 mW/g

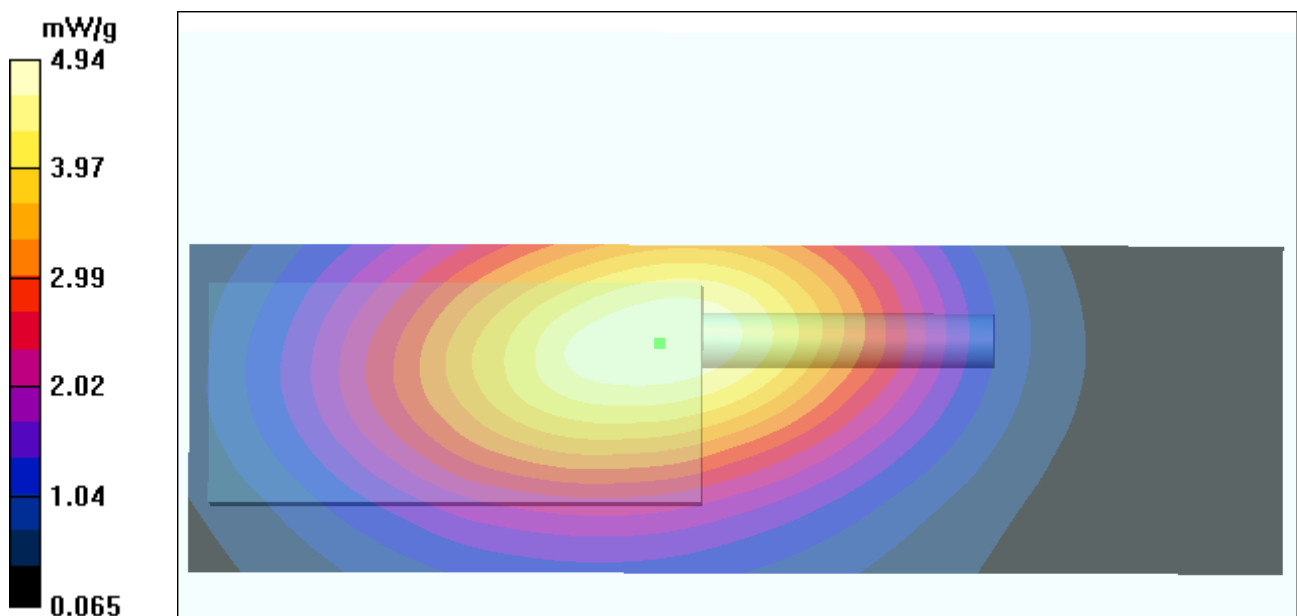

Low Ch Face

KNB-32N and KRA-23M

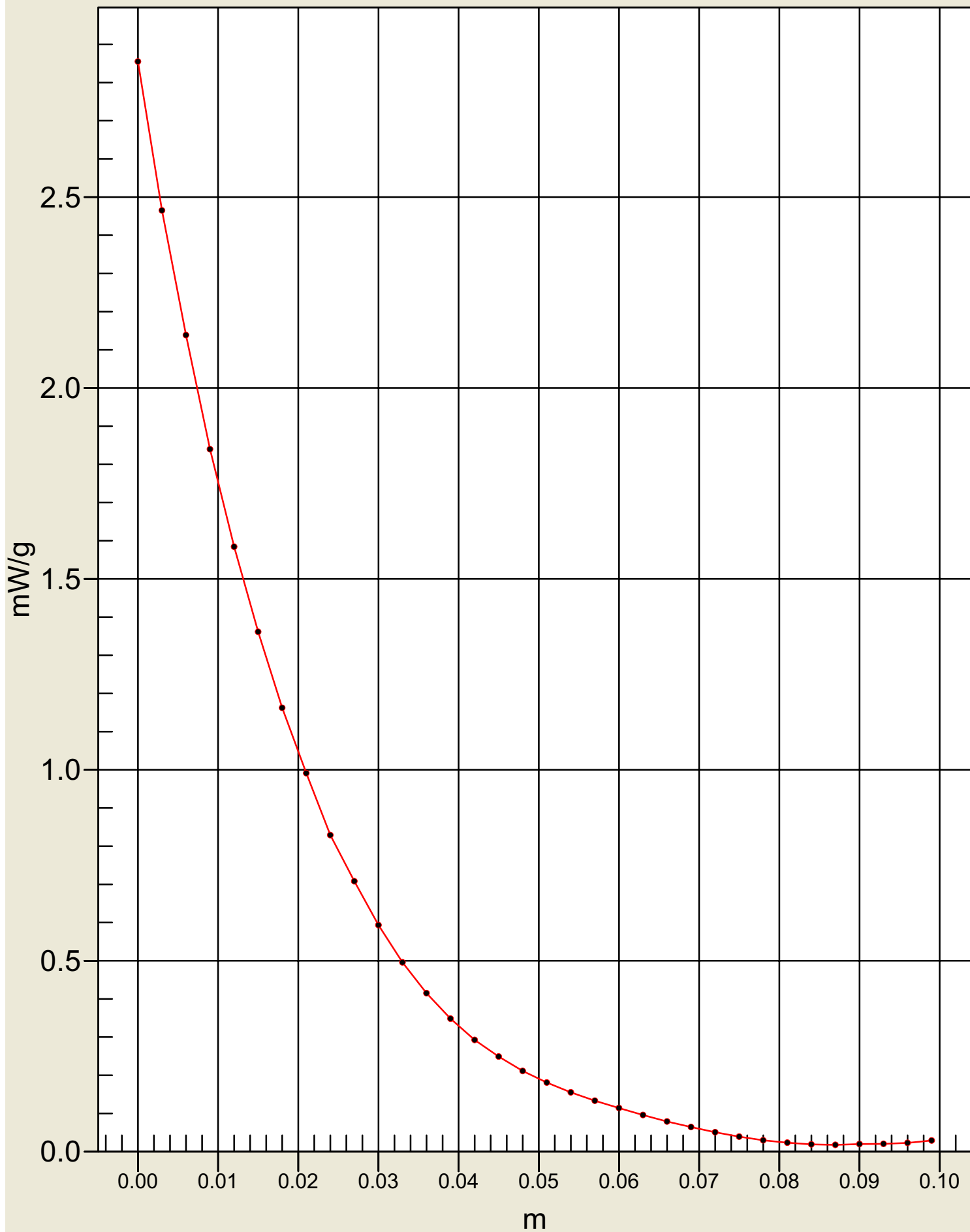

High Ch Face SAR Battery: KNB-32N; Antenna: KRA-23M

Date/Time: 12/27/2005 1:01:54 PM

DUT: Kenwood; Type: TK-5300; Serial: N/A

Medium Notes: Ambient Temp: 23.1 deg C; Fluid Temp: 22.7 deg C

Communication System: CW; ; Frequency: 450 MHz; Duty Cycle: 1:1

Medium: 450MHz head Medium parameters used: $f = 450 \text{ MHz}$; $\sigma = 0.86 \text{ mho/m}$; $\epsilon_r = 46.0$; $\rho = 1000$

kg/m^3

Phantom section: Flat Section

Probe: ET3DV6 - SN1793; ConvF(7.6, 7.6, 7.6); Calibrated: 9/20/2005

Sensor-Surface: 4mm (Mechanical Surface Detection)

Electronics: DAE3 Sn584; Calibrated: 9/22/2005

Phantom: Twin Box HSL; Type: HSL; Serial: 001

Measurement SW: DASY4, V4.5 Build 19; Postprocessing SW: SEMCAD, V1.8 Build 146

Area Scan (61x201x1): Measurement grid: $dx=15\text{mm}$, $dy=15\text{mm}$

Maximum value of SAR (interpolated) = 3.30 mW/g

Zoom Scan (7x7x7)/Cube 0: Measurement grid: $dx=5\text{mm}$, $dy=5\text{mm}$, $dz=5\text{mm}$

Reference Value = 58.6 V/m; Power Drift = -0.198 dB

Peak SAR (extrapolated) = 4.87 W/kg

SAR(1 g) = 3.16 mW/g; SAR(10 g) = 2.28 mW/g

Maximum value of SAR (measured) = 3.28 mW/g

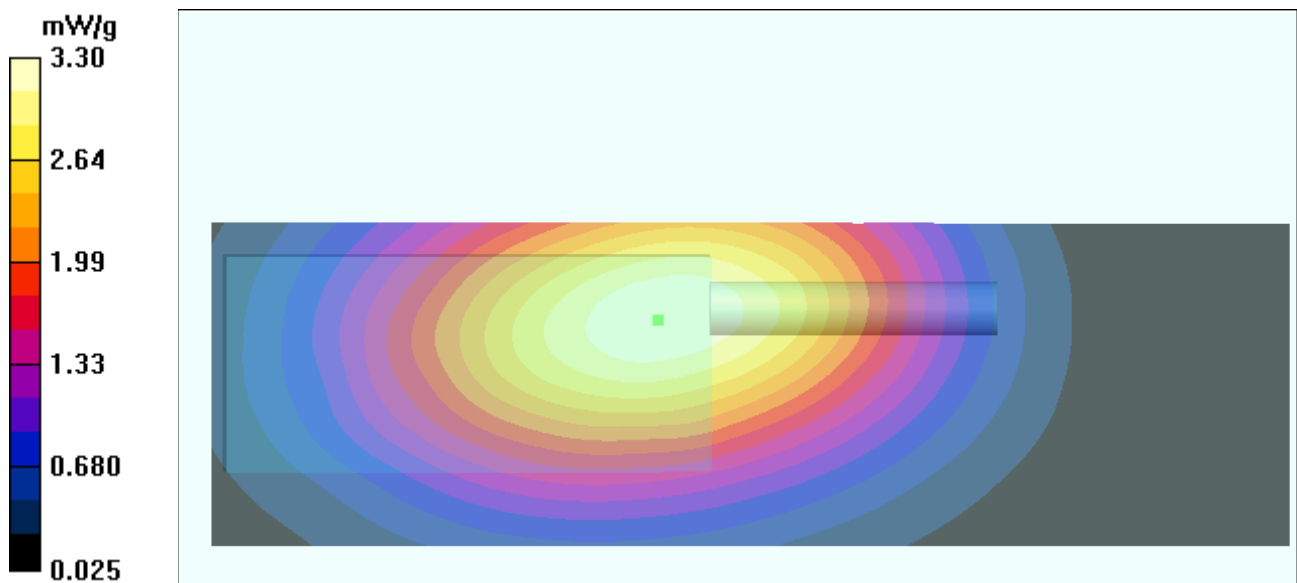

Mid Ch Body SAR Battery: KNB-33L; Antenna: KRA-27M; Belt Clip: KBH-10

Date/Time: 12/21/2005 10:27:23 AM

DUT: Kenwood; Type: TK-5300; Serial: N/A

Medium Notes: Ambient Temp: 23.1 deg C; Fluid Temp 22.7 deg C

Communication System: CW; ; Frequency: 450 MHz; Duty Cycle: 1:1

Medium: 450MHz Body Medium parameters used: $f = 450 \text{ MHz}$; $\sigma = 0.92 \text{ mho/m}$; $\epsilon_r = 58.3$; $\rho = 1000$

kg/m^3

Phantom section: Flat Section

Probe: ET3DV6 - SN1793; ConvF(7.5, 7.5, 7.5); Calibrated: 9/20/2005

Sensor-Surface: 4mm (Mechanical Surface Detection)

Electronics: DAE3 Sn584; Calibrated: 9/22/2005

Phantom: Twin Box HSL; Type: HSL; Serial: 001

Measurement SW: DASY4, V4.5 Build 19; Postprocessing SW: SEMCAD, V1.8 Build 146

Area Scan (61x201x1): Measurement grid: $dx=15\text{mm}$, $dy=15\text{mm}$

Maximum value of SAR (interpolated) = 12.4 mW/g

Zoom Scan (7x7x7)/Cube 0: Measurement grid: $dx=5\text{mm}$, $dy=5\text{mm}$, $dz=5\text{mm}$

Reference Value = 119.7 V/m; Power Drift = -0.474 dB

Peak SAR (extrapolated) = 19.9 W/kg

SAR(1 g) = 11.7 mW/g; SAR(10 g) = 7.87 mW/g

Maximum value of SAR (measured) = 12.2 mW/g

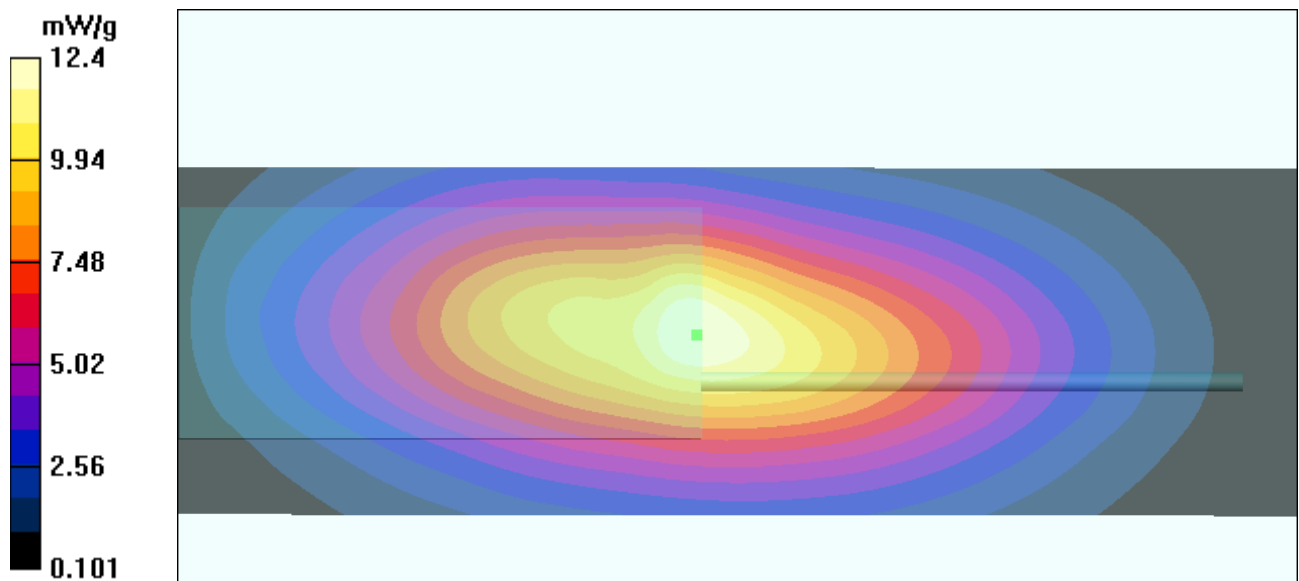

Mid Ch Body SAR Battery: KNB-33L; Antenna: KRA-27M; Belt Clip: KBH-11

Date/Time: 12/21/2005 11:47:29 AM

DUT: Kenwood; Type: TK-5300; Serial: N/A

Medium Notes: Ambient Temp: 23.1 deg C; Fluid Temp 22.7 deg C

Communication System: CW; ; Frequency: 450 MHz; Duty Cycle: 1:1

Medium: 450MHz Body Medium parameters used: $f = 450 \text{ MHz}$; $\sigma = 0.92 \text{ mho/m}$; $\epsilon_r = 58.3$; $\rho = 1000$

kg/m^3

Phantom section: Flat Section

Probe: ET3DV6 - SN1793; ConvF(7.5, 7.5, 7.5); Calibrated: 9/20/2005

Sensor-Surface: 4mm (Mechanical Surface Detection)

Electronics: DAE3 Sn584; Calibrated: 9/22/2005

Phantom: Twin Box HSL; Type: HSL; Serial: 001

Measurement SW: DASY4, V4.5 Build 19; Postprocessing SW: SEMCAD, V1.8 Build 146

Area Scan (61x201x1): Measurement grid: $dx=15\text{mm}$, $dy=15\text{mm}$

Maximum value of SAR (interpolated) = 7.88 mW/g

Zoom Scan (7x7x7)/Cube 0: Measurement grid: $dx=5\text{mm}$, $dy=5\text{mm}$, $dz=5\text{mm}$

Reference Value = 89.3 V/m; Power Drift = -0.695 dB

Peak SAR (extrapolated) = 12.7 W/kg

SAR(1 g) = 7.14 mW/g; SAR(10 g) = 4.95 mW/g

Maximum value of SAR (measured) = 7.44 mW/g

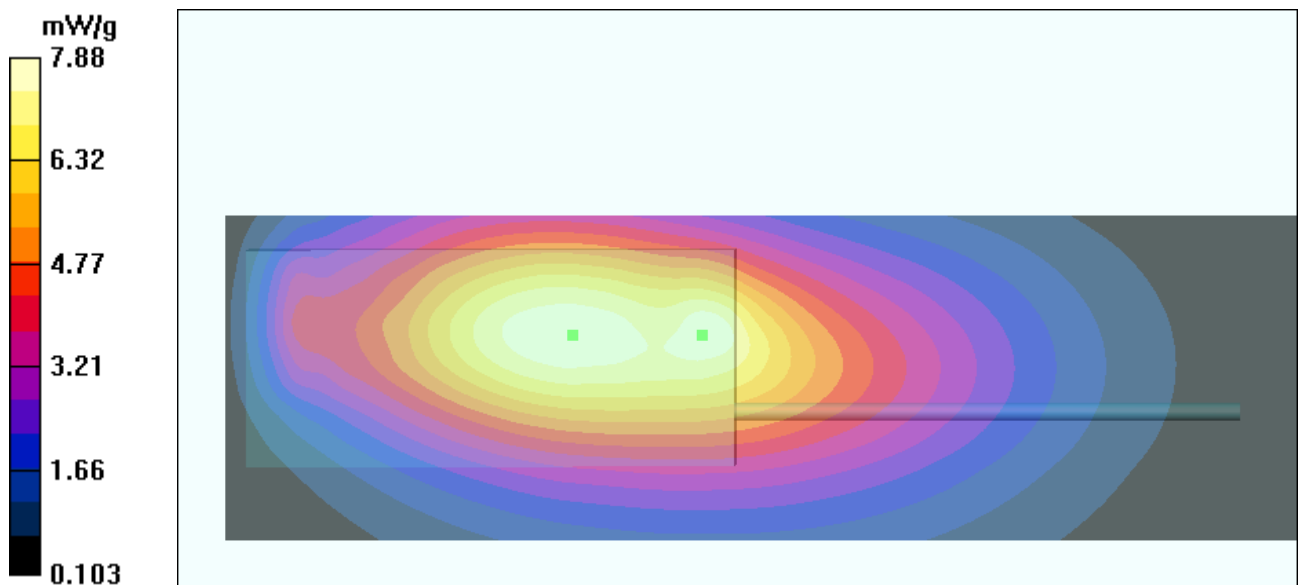

Mid Ch Body SAR Battery: KNB-32N; Antenna: KRA-27M; Belt Clip: KBH-10

Date/Time: 12/21/2005 2:03:10 PM

DUT: Kenwood; Type: TK-5300; Serial: N/A

Medium Notes: Ambient Temp: 23.1 deg C; Fluid Temp 22.7 deg C

Communication System: CW; ; Frequency: 450 MHz; Duty Cycle: 1:1

Medium: 450MHz Body Medium parameters used: $f = 450 \text{ MHz}$; $\sigma = 0.92 \text{ mho/m}$; $\epsilon_r = 58.3$; $\rho = 1000$

kg/m^3

Phantom section: Flat Section

Probe: ET3DV6 - SN1793; ConvF(7.5, 7.5, 7.5); Calibrated: 9/20/2005

Sensor-Surface: 4mm (Mechanical Surface Detection)

Electronics: DAE3 Sn584; Calibrated: 9/22/2005

Phantom: Twin Box HSL; Type: HSL; Serial: 001

Measurement SW: DASY4, V4.5 Build 19; Postprocessing SW: SEMCAD, V1.8 Build 146

Area Scan (61x201x1): Measurement grid: $dx=15\text{mm}$, $dy=15\text{mm}$

Maximum value of SAR (interpolated) = 13.1 mW/g

Zoom Scan (7x7x7)/Cube 0: Measurement grid: $dx=5\text{mm}$, $dy=5\text{mm}$, $dz=5\text{mm}$

Reference Value = 121.8 V/m; Power Drift = -0.476 dB

Peak SAR (extrapolated) = 20.5 W/kg

SAR(1 g) = 12.3 mW/g; SAR(10 g) = 8.42 mW/g

Maximum value of SAR (measured) = 12.9 mW/g

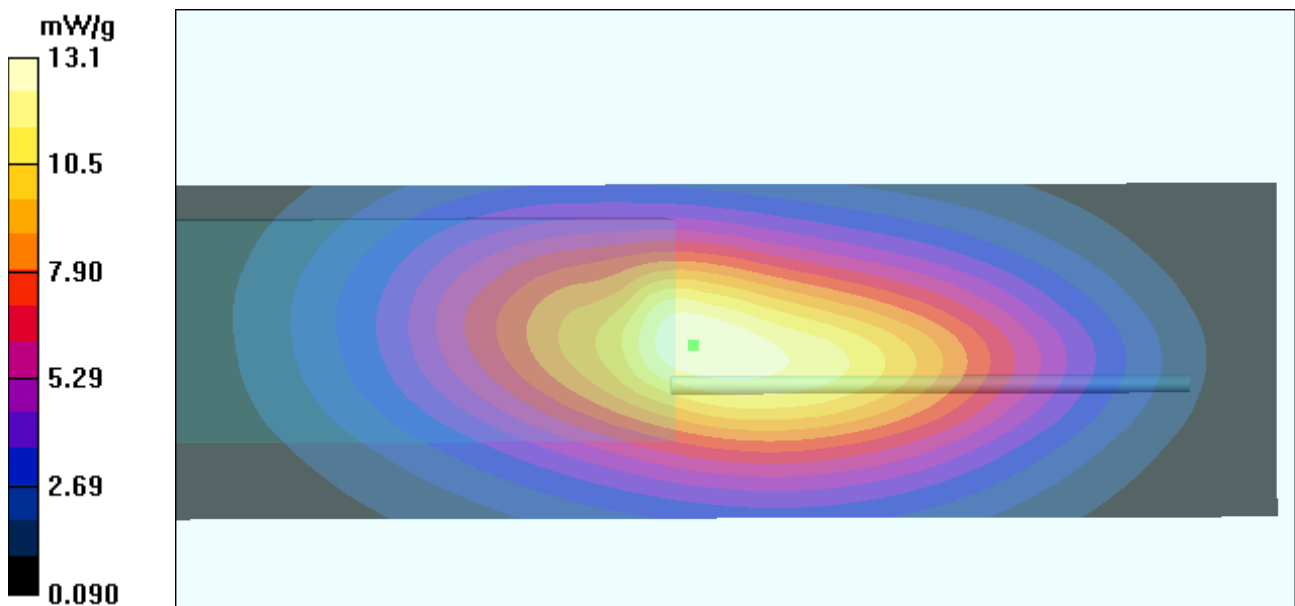

Mid Ch Body

KNB-32N; KRA-27M; KBH-10

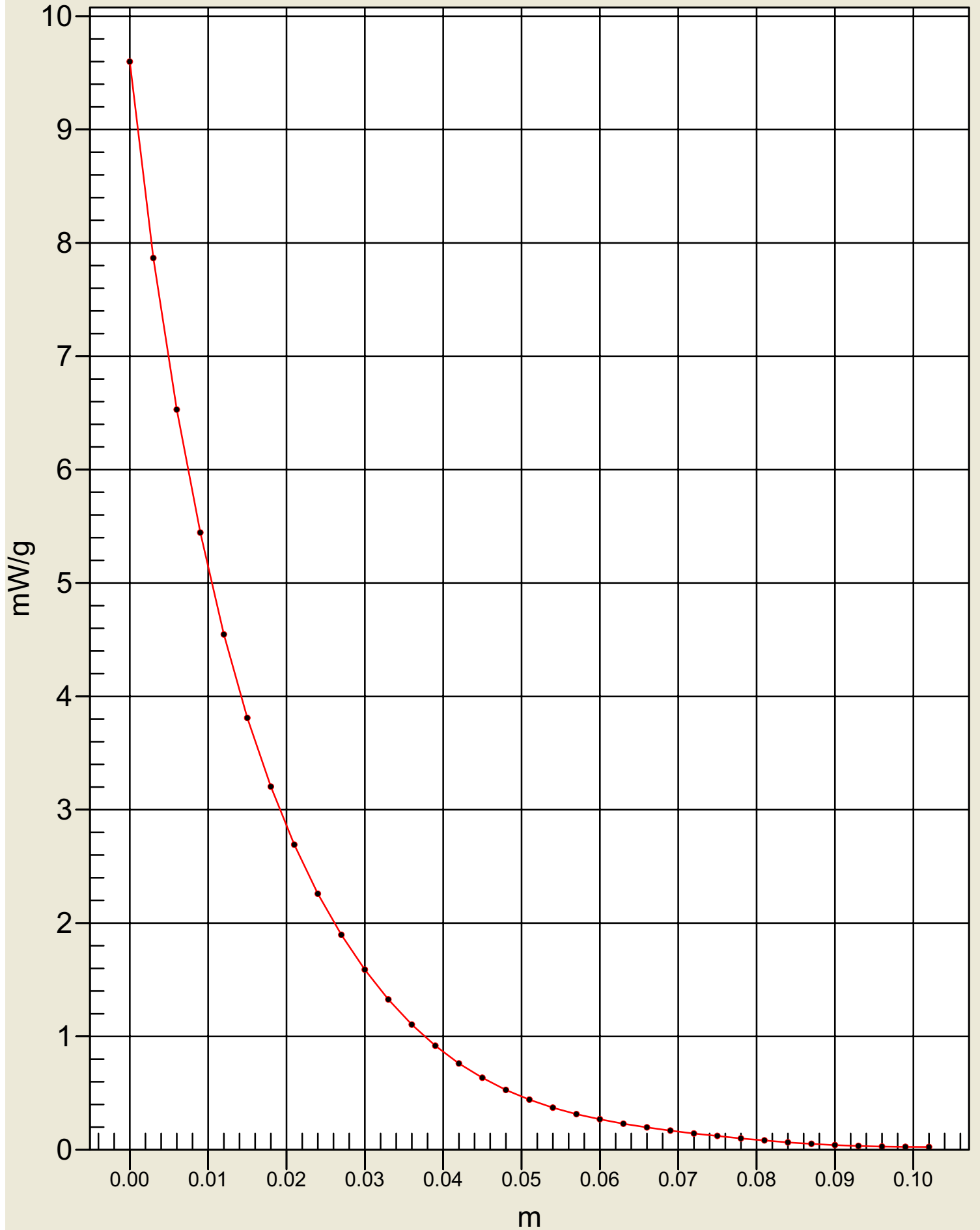

Mid Ch Body SAR Battery: KNB-31A; Antenna: KRA-27M; Belt Clip: KBH-10

Date/Time: 12/21/2005 2:27:23 PM

DUT: Kenwood; Type: TK-5300; Serial: N/A

Medium Notes: Ambient Temp: 23.1 deg C; Fluid Temp 22.7 deg C

Communication System: CW; ; Frequency: 450 MHz; Duty Cycle: 1:1

Medium: 450MHz Body Medium parameters used: $f = 450 \text{ MHz}$; $\sigma = 0.92 \text{ mho/m}$; $\epsilon_r = 58.3$; $\rho = 1000$

kg/m^3

Phantom section: Flat Section

Probe: ET3DV6 - SN1793; ConvF(7.5, 7.5, 7.5); Calibrated: 9/20/2005

Sensor-Surface: 4mm (Mechanical Surface Detection)

Electronics: DAE3 Sn584; Calibrated: 9/22/2005

Phantom: Twin Box HSL; Type: HSL; Serial: 001

Measurement SW: DASY4, V4.5 Build 19; Postprocessing SW: SEMCAD, V1.8 Build 146

Area Scan (61x201x1): Measurement grid: $dx=15\text{mm}$, $dy=15\text{mm}$

Maximum value of SAR (interpolated) = 12.3 mW/g

Zoom Scan (7x7x7)/Cube 0: Measurement grid: $dx=5\text{mm}$, $dy=5\text{mm}$, $dz=5\text{mm}$

Reference Value = 119.7 V/m; Power Drift = -0.173 dB

Peak SAR (extrapolated) = 19.7 W/kg

SAR(1 g) = 11.5 mW/g; SAR(10 g) = 7.79 mW/g

Maximum value of SAR (measured) = 12.1 mW/g

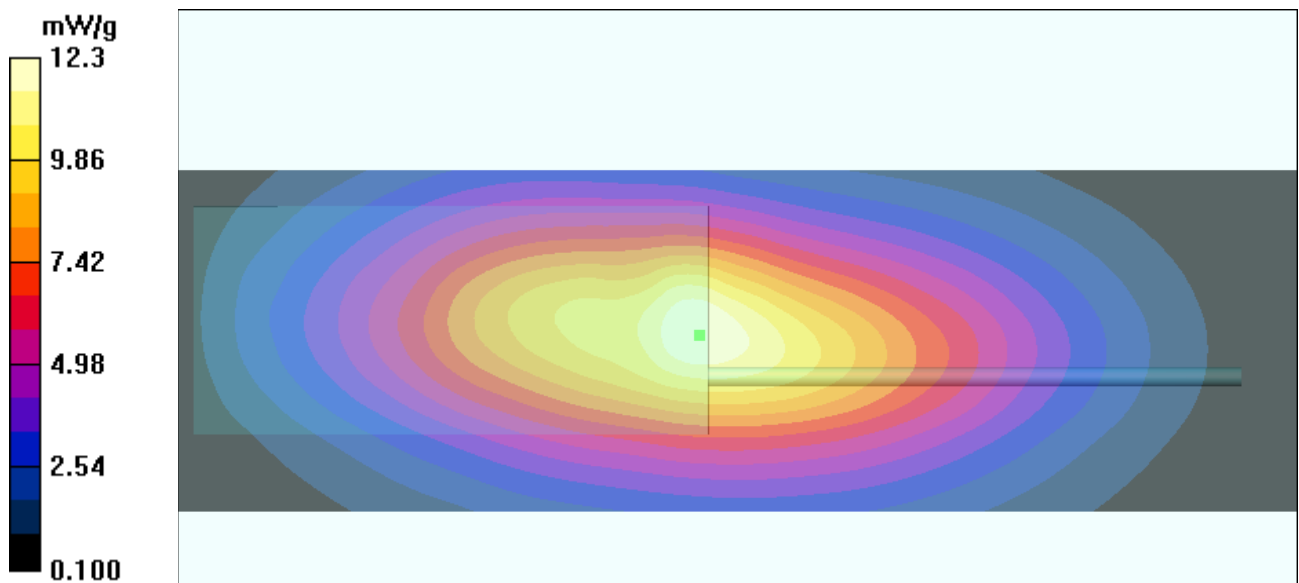

Low Ch Body SAR Battery: KNB-32N; Antenna: KRA-27M; Belt Clip: KBH-10

Date/Time: 12/21/2005 3:17:02 PM

DUT: Kenwood; Type: TK-5300; Serial: N/A

Medium Notes: Ambient Temp: 23.1 deg C; Fluid Temp 22.7 deg C

Communication System: CW; ; Frequency: 450 MHz; Duty Cycle: 1:1

Medium: 450MHz Body Medium parameters used: $f = 450 \text{ MHz}$; $\sigma = 0.92 \text{ mho/m}$; $\epsilon_r = 58.3$; $\rho = 1000$

kg/m^3

Phantom section: Flat Section

Probe: ET3DV6 - SN1793; ConvF(7.5, 7.5, 7.5); Calibrated: 9/20/2005

Sensor-Surface: 4mm (Mechanical Surface Detection)

Electronics: DAE3 Sn584; Calibrated: 9/22/2005

Phantom: Twin Box HSL; Type: HSL; Serial: 001

Measurement SW: DASY4, V4.5 Build 19; Postprocessing SW: SEMCAD, V1.8 Build 146

Area Scan (61x201x1): Measurement grid: $dx=15\text{mm}$, $dy=15\text{mm}$

Maximum value of SAR (interpolated) = 9.66 mW/g

Zoom Scan (7x7x7)/Cube 0: Measurement grid: $dx=5\text{mm}$, $dy=5\text{mm}$, $dz=5\text{mm}$

Reference Value = 103.6 V/m; Power Drift = -0.563 dB

Peak SAR (extrapolated) = 14.8 W/kg

SAR(1 g) = 8.81 mW/g; SAR(10 g) = 6.02 mW/g

Maximum value of SAR (measured) = 9.29 mW/g

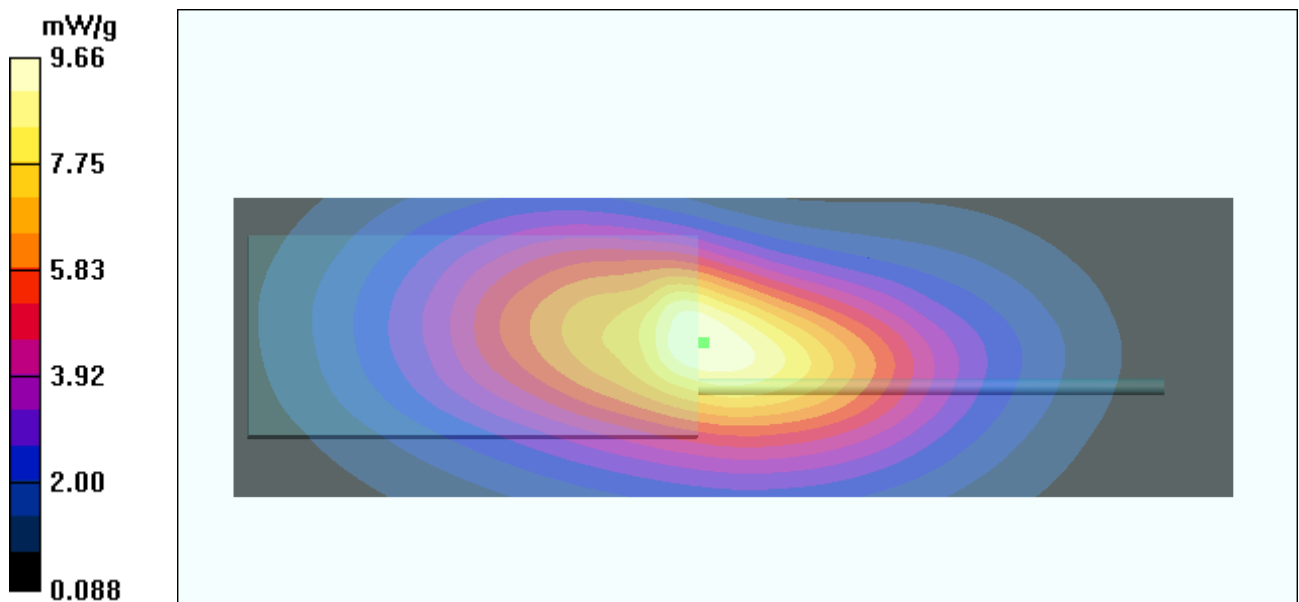

High Ch Body SAR Battery: KNB-33L; Antenna: KRA-27M; Belt Clip: KBH-10

Date/Time: 12/21/2005 3:44:37 PM

DUT: Kenwood; Type: TK-5300; Serial: N/A

Medium Notes: Ambient Temp: 23.1 deg C; Fluid Temp 22.7 deg C

Communication System: CW; ; Frequency: 450 MHz; Duty Cycle: 1:1

Medium: 450MHz Body Medium parameters used: $f = 450 \text{ MHz}$; $\sigma = 0.92 \text{ mho/m}$; $\epsilon_r = 58.3$; $\rho = 1000$

kg/m^3

Phantom section: Flat Section

Probe: ET3DV6 - SN1793; ConvF(7.5, 7.5, 7.5); Calibrated: 9/20/2005

Sensor-Surface: 4mm (Mechanical Surface Detection)

Electronics: DAE3 Sn584; Calibrated: 9/22/2005

Phantom: Twin Box HSL; Type: HSL; Serial: 001

Measurement SW: DASY4, V4.5 Build 19; Postprocessing SW: SEMCAD, V1.8 Build 146

Area Scan (61x201x1): Measurement grid: $dx=15\text{mm}$, $dy=15\text{mm}$

Maximum value of SAR (interpolated) = 7.20 mW/g

Zoom Scan (7x7x7)/Cube 0: Measurement grid: $dx=5\text{mm}$, $dy=5\text{mm}$, $dz=5\text{mm}$

Reference Value = 93.8 V/m; Power Drift = -0.631 dB

Peak SAR (extrapolated) = 11.6 W/kg

SAR(1 g) = 6.94 mW/g; SAR(10 g) = 4.76 mW/g

Maximum value of SAR (measured) = 7.25 mW/g

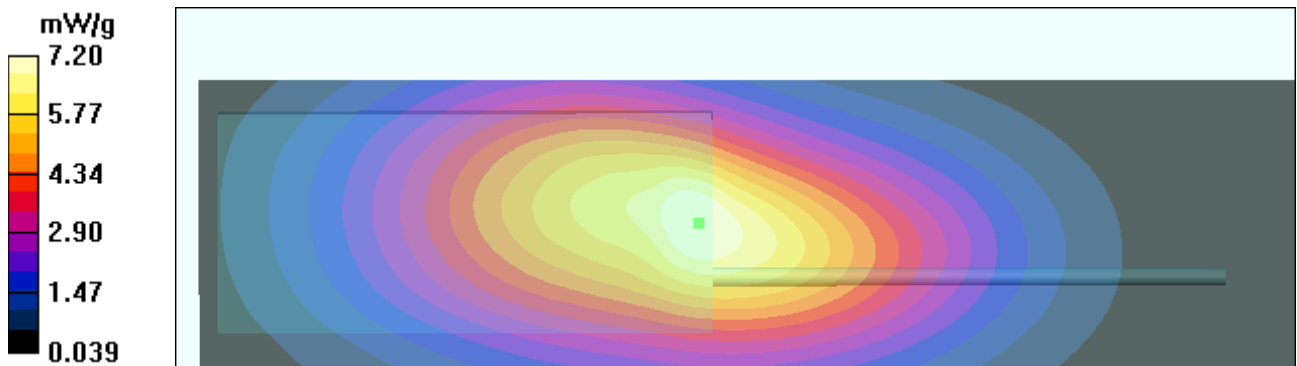

Mid Ch Body SAR Battery: KNB-32N; Antenna: KRA-23M; Belt Clip: KBH-10

Date/Time: 12/27/2005 8:55:25 AM

DUT: Kenwood; Type: TK-5300 ; Serial: N/A

Medium Notes: Ambient Temp: 23.0 deg C; Fluid Temp 22.6 deg C

Communication System: CW; ; Frequency: 450 MHz; Duty Cycle: 1:1

Medium: 450MHz Body Medium parameters used: $f = 450 \text{ MHz}$; $\sigma = 0.96 \text{ mho/m}$; $\epsilon_r = 58.5$; $\rho = 1000$

kg/m^3

Phantom section: Flat Section

Probe: ET3DV6 - SN1793; ConvF(7.5, 7.5, 7.5); Calibrated: 9/20/2005

Sensor-Surface: 4mm (Mechanical Surface Detection)

Electronics: DAE3 Sn584; Calibrated: 9/22/2005

Phantom: Twin Box HSL; Type: HSL; Serial: 001

Measurement SW: DASY4, V4.5 Build 19; Postprocessing SW: SEMCAD, V1.8 Build 146

Area Scan (61x201x1): Measurement grid: $dx=15\text{mm}$, $dy=15\text{mm}$

Maximum value of SAR (interpolated) = 12.1 mW/g

Zoom Scan (7x7x7)/Cube 0: Measurement grid: $dx=5\text{mm}$, $dy=5\text{mm}$, $dz=5\text{mm}$

Reference Value = 116.6 V/m; Power Drift = -0.543 dB

Peak SAR (extrapolated) = 19.3 W/kg

SAR(1 g) = 11.4 mW/g; SAR(10 g) = 7.76 mW/g

Maximum value of SAR (measured) = 12.0 mW/g

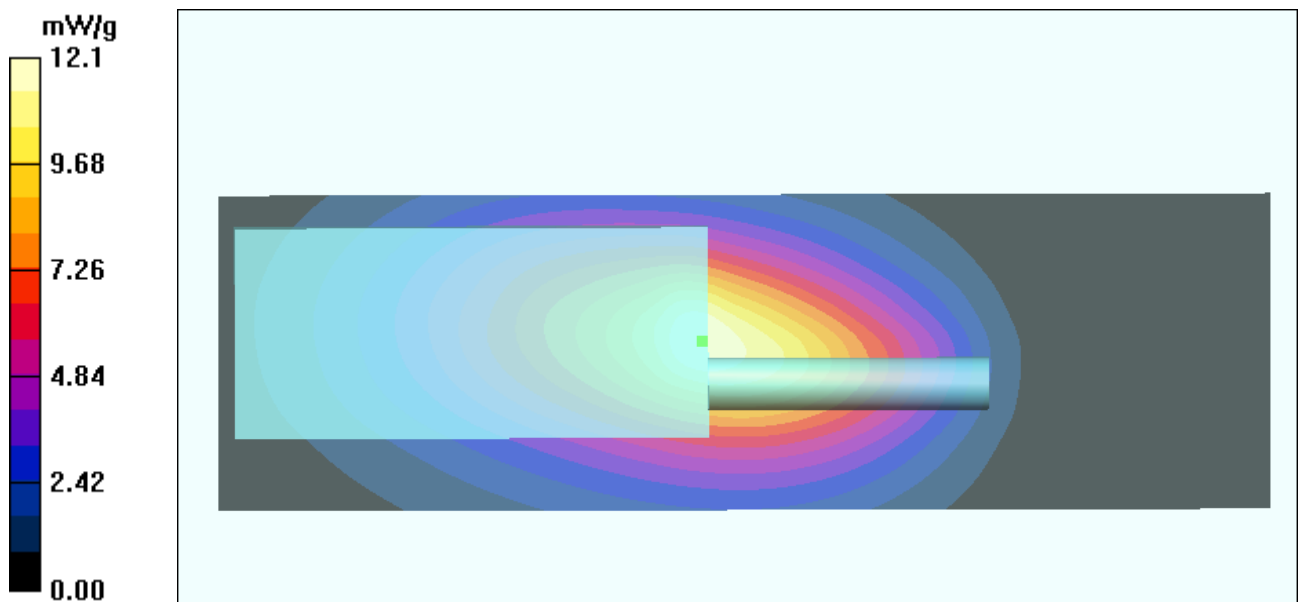

Mid Ch Body SAR Battery: KNB-32N; Antenna: KRA-23M; Belt Clip: KBH-11

Date/Time: 12/27/2005 9:27:45 AM

DUT: Kenwood; Type: TK-5300 ; Serial: N/A

Medium Notes: Ambient Temp: 23.0 deg C; Fluid Temp 22.6 deg C

Communication System: CW; ; Frequency: 450 MHz;Duty Cycle: 1:1

Medium: 450MHz Body Medium parameters used: $f = 450 \text{ MHz}$; $\sigma = 0.96 \text{ mho/m}$; $\epsilon_r = 58.5$; $\rho = 1000$

kg/m^3

Phantom section: Flat Section

Probe: ET3DV6 - SN1793; ConvF(7.5, 7.5, 7.5); Calibrated: 9/20/2005

Sensor-Surface: 4mm (Mechanical Surface Detection)

Electronics: DAE3 Sn584; Calibrated: 9/22/2005

Phantom: Twin Box HSL; Type: HSL; Serial: 001

Measurement SW: DASY4, V4.5 Build 19; Postprocessing SW: SEMCAD, V1.8 Build 146

Area Scan (61x201x1): Measurement grid: $dx=15\text{mm}$, $dy=15\text{mm}$

Maximum value of SAR (interpolated) = 8.96 mW/g

Zoom Scan (7x7x7)/Cube 0: Measurement grid: $dx=5\text{mm}$, $dy=5\text{mm}$, $dz=5\text{mm}$

Reference Value = 97.7 V/m; Power Drift = -0.255 dB

Peak SAR (extrapolated) = 14.9 W/kg

SAR(1 g) = 8.54 mW/g; SAR(10 g) = 5.79 mW/g

Maximum value of SAR (measured) = 9.04 mW/g

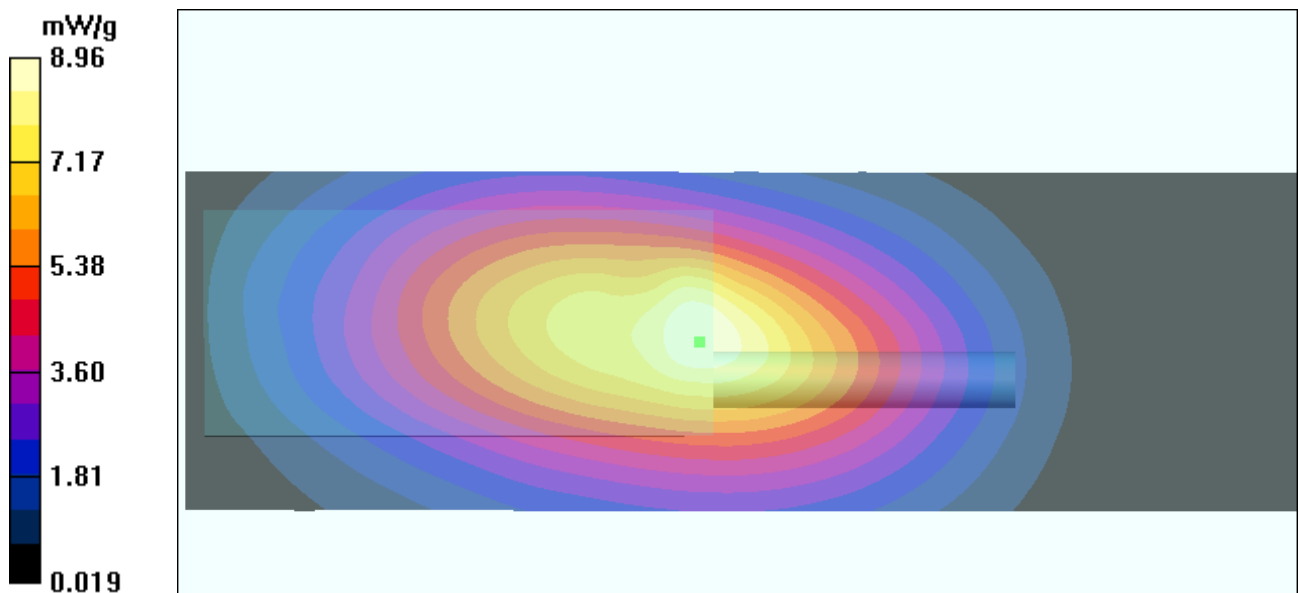

Mid Ch Body SAR Battery: KNB-32N; Antenna: KRA-23M; Belt Clip: KBH-10

Date/Time: 12/27/2005 9:56:51 AM

DUT: Kenwood; Type: TK-5300 ; Serial: N/A

Medium Notes: Ambient Temp: 23.0 deg C; Fluid Temp 22.6 deg C

Communication System: CW; ; Frequency: 450 MHz;Duty Cycle: 1:1

Medium: 450MHz Body Medium parameters used: $f = 450 \text{ MHz}$; $\sigma = 0.96 \text{ mho/m}$; $\epsilon_r = 58.5$; $\rho = 1000$

kg/m^3

Phantom section: Flat Section

Probe: ET3DV6 - SN1793; ConvF(7.5, 7.5, 7.5); Calibrated: 9/20/2005

Sensor-Surface: 4mm (Mechanical Surface Detection)

Electronics: DAE3 Sn584; Calibrated: 9/22/2005

Phantom: Twin Box HSL; Type: HSL; Serial: 001

Measurement SW: DASY4, V4.5 Build 19; Postprocessing SW: SEMCAD, V1.8 Build 146

Area Scan (61x201x1): Measurement grid: $dx=15\text{mm}$, $dy=15\text{mm}$

Maximum value of SAR (interpolated) = 11.2 mW/g

Zoom Scan (7x7x7)/Cube 0: Measurement grid: $dx=5\text{mm}$, $dy=5\text{mm}$, $dz=5\text{mm}$

Reference Value = 108.2 V/m; Power Drift = -0.512 dB

Peak SAR (extrapolated) = 17.8 W/kg

SAR(1 g) = 10.4 mW/g; SAR(10 g) = 7 mW/g

Maximum value of SAR (measured) = 10.8 mW/g

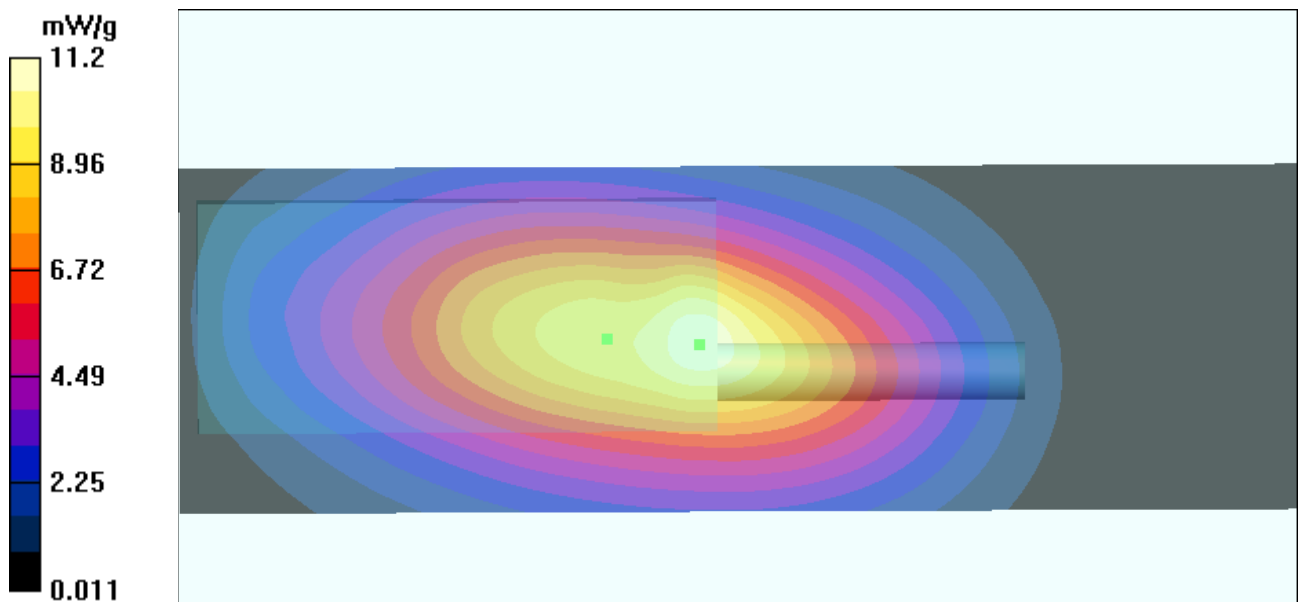

Mid Ch Body SAR Battery: KNB-31A; Antenna: KRA-23M; Belt Clip: KBH-10

Date/Time: 12/27/2005 10:04:51 AM

DUT: Kenwood; Type: TK-5300 ; Serial: N/A

Medium Notes: Ambient Temp: 23.0 deg C; Fluid Temp 22.6 deg C

Communication System: CW; ; Frequency: 450 MHz;Duty Cycle: 1:1

Medium: 450MHz Body Medium parameters used: $f = 450 \text{ MHz}$; $\sigma = 0.94 \text{ mho/m}$; $\epsilon_r = 58.5$; $\rho = 1000$

kg/m^3

Phantom section: Flat Section

Probe: ET3DV6 - SN1793; ConvF(7.5, 7.5, 7.5); Calibrated: 9/20/2005

Sensor-Surface: 4mm (Mechanical Surface Detection)

Electronics: DAE3 Sn584; Calibrated: 9/22/2005

Phantom: Twin Box HSL; Type: HSL; Serial: 001

Measurement SW: DASY4, V4.5 Build 19; Postprocessing SW: SEMCAD, V1.8 Build 146

Area Scan (61x201x1): Measurement grid: $dx=15\text{mm}$, $dy=15\text{mm}$

Maximum value of SAR (interpolated) = 10.9 mW/g

Zoom Scan (7x7x7)/Cube 0: Measurement grid: $dx=5\text{mm}$, $dy=5\text{mm}$, $dz=5\text{mm}$

Reference Value = 108.2 V/m; Power Drift = -0.311 dB

Peak SAR (extrapolated) = 17.4 W/kg

SAR(1 g) = 10.1 mW/g; SAR(10 g) = 6.85 mW/g

Maximum value of SAR (measured) = 10.6 mW/g

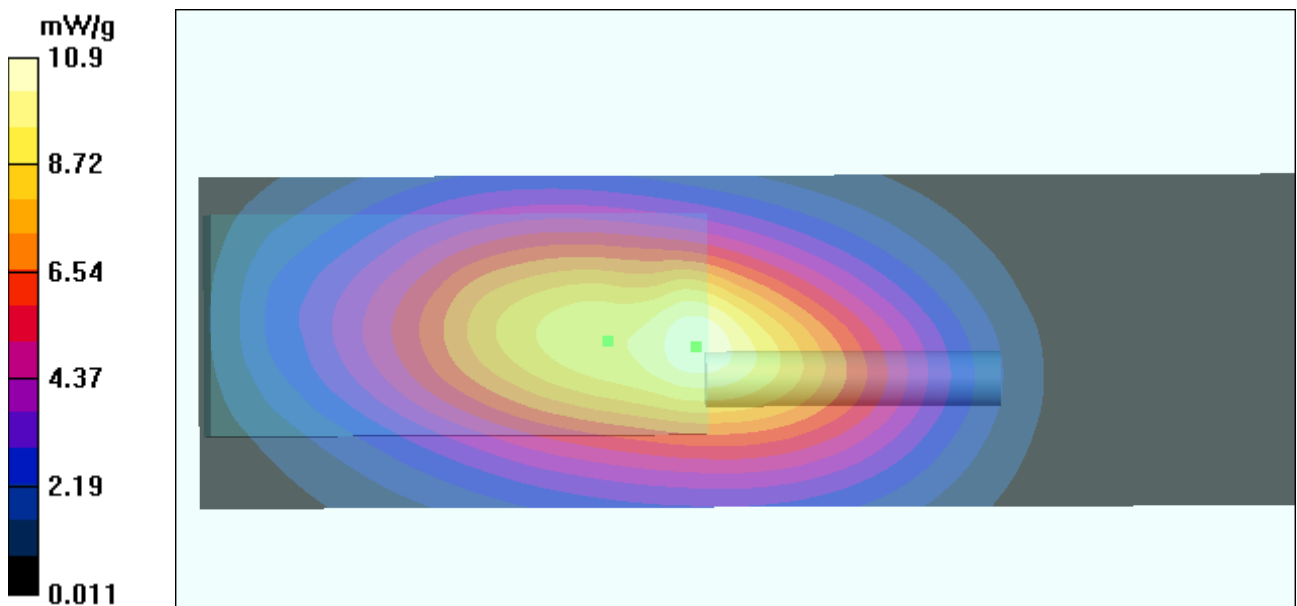

Low Ch Body SAR Battery: KNB-32N; Antenna: KRA-23M; Belt Clip: KBH-10

Date/Time: 12/27/2005 10:18:46 AM

DUT: Kenwood; Type: TK-5300 ; Serial: N/A

Medium Notes: Ambient Temp: 23.0 deg C; Fluid Temp 22.6 deg C

Communication System: CW; ; Frequency: 450 MHz; Duty Cycle: 1:1

Medium: 450MHz Body Medium parameters used: $f = 450 \text{ MHz}$; $\sigma = 0.96 \text{ mho/m}$; $\epsilon_r = 58.5$; $\rho = 1000$

kg/m^3

Phantom section: Flat Section

Probe: ET3DV6 - SN1793; ConvF(7.5, 7.5, 7.5); Calibrated: 9/20/2005

Sensor-Surface: 4mm (Mechanical Surface Detection)

Electronics: DAE3 Sn584; Calibrated: 9/22/2005

Phantom: Twin Box HSL; Type: HSL; Serial: 001

Measurement SW: DASY4, V4.5 Build 19; Postprocessing SW: SEMCAD, V1.8 Build 146

Area Scan (61x201x1): Measurement grid: $dx=15\text{mm}$, $dy=15\text{mm}$

Maximum value of SAR (interpolated) = 14.4 mW/g

Zoom Scan (7x7x7)/Cube 0: Measurement grid: $dx=5\text{mm}$, $dy=5\text{mm}$, $dz=5\text{mm}$

Reference Value = 118.8 V/m; Power Drift = -0.407 dB

Peak SAR (extrapolated) = 22.2 W/kg

SAR(1 g) = 13.1 mW/g; SAR(10 g) = 8.89 mW/g

Maximum value of SAR (measured) = 13.7 mW/g

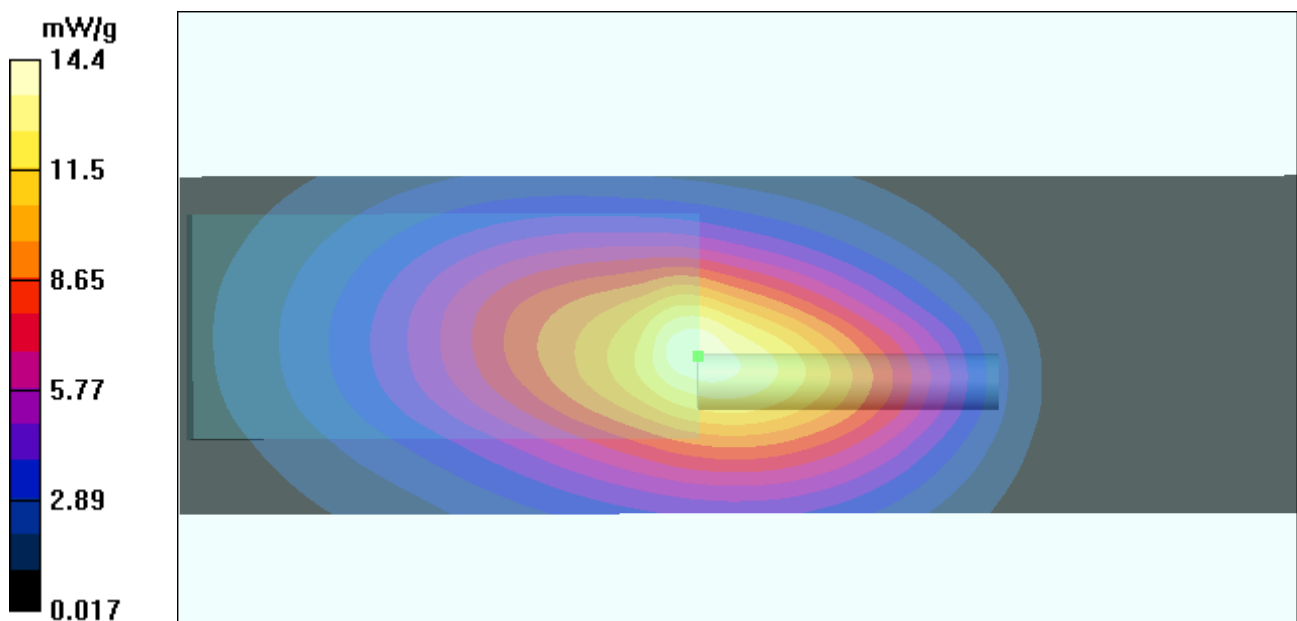

Low Ch Body

KNB-32N; KRA-23M; KBH-10

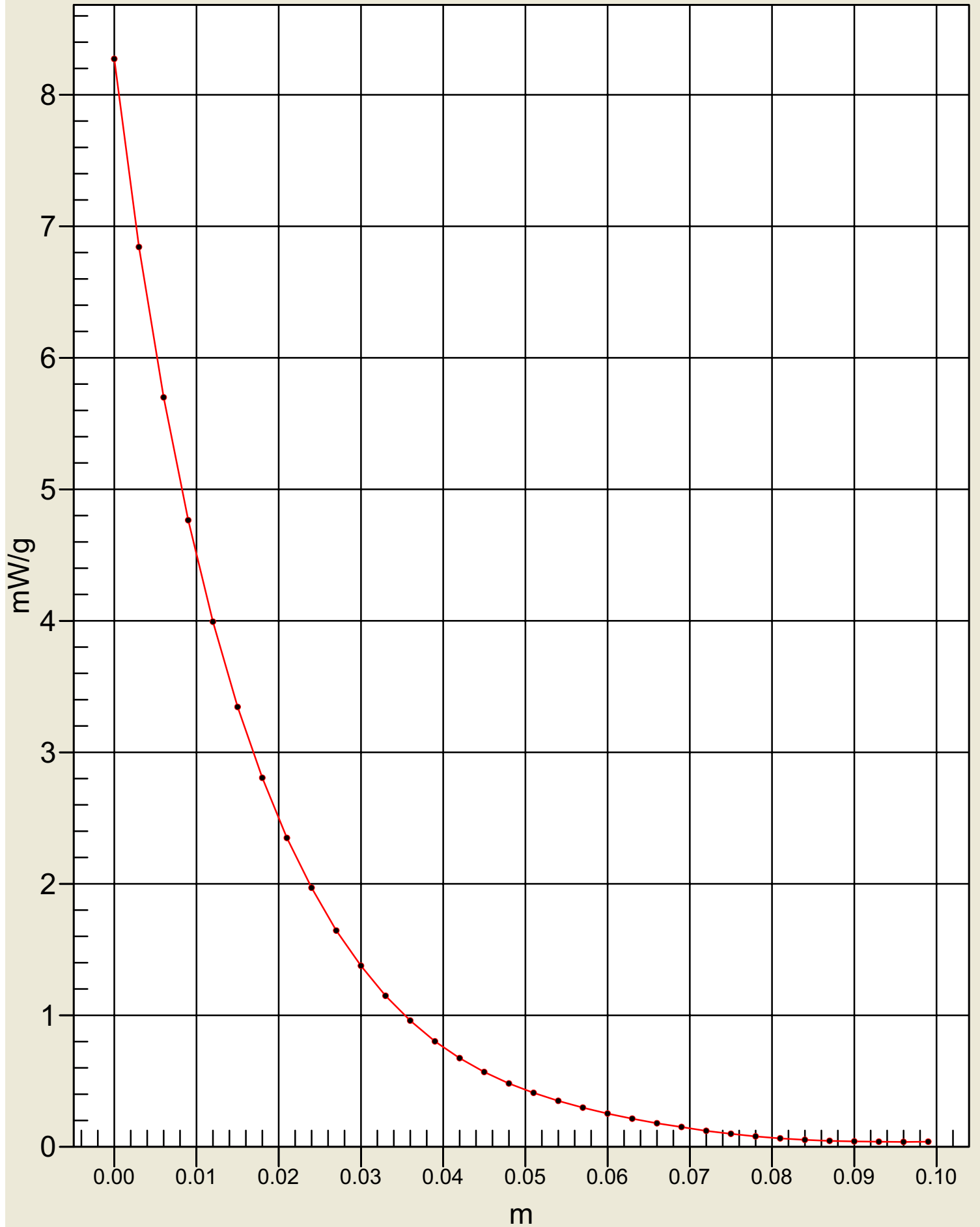

High Ch Body SAR Battery: KNB-32N; Antenna: KRA-23M; Belt Clip: KBH-10

Date/Time: 12/27/2005 10:42:18 AM

DUT: Kenwood; Type: TK-5300 ; Serial: N/A

Medium Notes: Ambient Temp: 23.0 deg C; Fluid Temp 22.6 deg C

Communication System: CW; ; Frequency: 450 MHz;Duty Cycle: 1:1

Medium: 450MHz Body Medium parameters used: $f = 450 \text{ MHz}$; $\sigma = 0.96 \text{ mho/m}$; $\epsilon_r = 58.5$; $\rho = 1000$

kg/m^3

Phantom section: Flat Section

Probe: ET3DV6 - SN1793; ConvF(7.5, 7.5, 7.5); Calibrated: 9/20/2005

Sensor-Surface: 4mm (Mechanical Surface Detection)

Electronics: DAE3 Sn584; Calibrated: 9/22/2005

Phantom: Twin Box HSL; Type: HSL; Serial: 001

Measurement SW: DASY4, V4.5 Build 19; Postprocessing SW: SEMCAD, V1.8 Build 146

Area Scan (61x201x1): Measurement grid: $dx=15\text{mm}$, $dy=15\text{mm}$

Maximum value of SAR (interpolated) = 8.19 mW/g

Zoom Scan (7x7x7)/Cube 0: Measurement grid: $dx=5\text{mm}$, $dy=5\text{mm}$, $dz=5\text{mm}$

Reference Value = 92.3 V/m; Power Drift = -0.149 dB

Peak SAR (extrapolated) = 13.0 W/kg

SAR(1 g) = 7.75 mW/g; SAR(10 g) = 5.27 mW/g

Maximum value of SAR (measured) = 8.13 mW/g

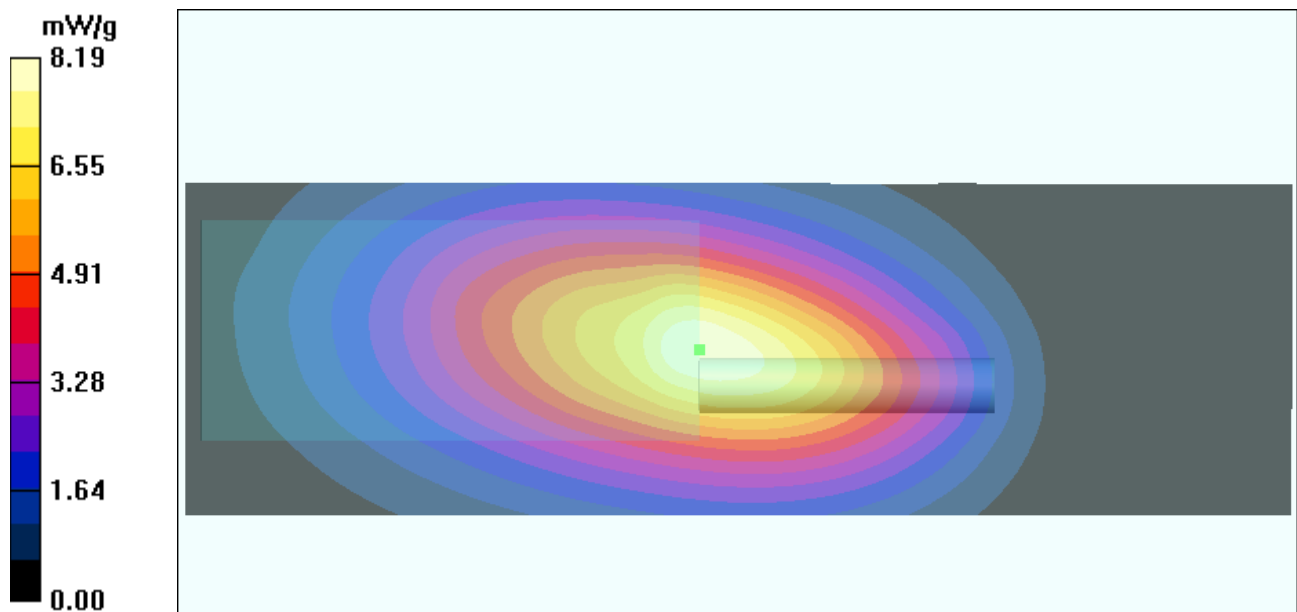



Kenwood Communications Corporation
TK-5300

Electromagnetic Compatibility
FCC OET 65 Supplement C: 01-01

Appendix D – SYSTEM VALIDATION

450MHz Validation Dec 21-2005

Date/Time: 12/21/2005 09:05:18 AM

DUT: Dipole 450 MHz; Type: D450V2; Serial: D450V2 - SN:004

Medium Notes: Ambient Temp: 23.1 deg C; Fluid Temp: 22.1 deg C

Communication System: CW; ; Frequency: 450 MHz; Duty Cycle: 1:1

Medium: 450MHz head Medium parameters used: $f = 450$ MHz; $\sigma = 0.86$ mho/m; $\epsilon_r = 46.1$; $\rho = 1000$ kg/m³

Phantom section: Flat Section

Probe: ET3DV6 - SN1793; ConvF(7.6, 7.6, 7.6); Calibrated: 9/20/2005

Sensor-Surface: 4mm (Mechanical Surface Detection)

Electronics: DAE3 Sn584; Calibrated: 9/22/2005

Phantom: Validation Phantom in front of RX90; Type: Plexiglas; Serial: 001

Measurement SW: DASY4, V4.5 Build 19; Postprocessing SW: SEMCAD, V1.8 Build 146

Area Scan (101x61x1): Measurement grid: dx=15mm, dy=15mm

Maximum value of SAR (interpolated) = 1.37 mW/g

Zoom Scan (7x7x7)/Cube 0: Measurement grid: dx=5mm, dy=5mm, dz=5mm

Reference Value = 39.9 V/m; Power Drift = -0.02 dB

Peak SAR (extrapolated) = 2.32 W/kg

SAR(1 g) = 1.3 mW/g; SAR(10 g) = 0.836 mW/g

Maximum value of SAR (measured) = 1.38 mW/g

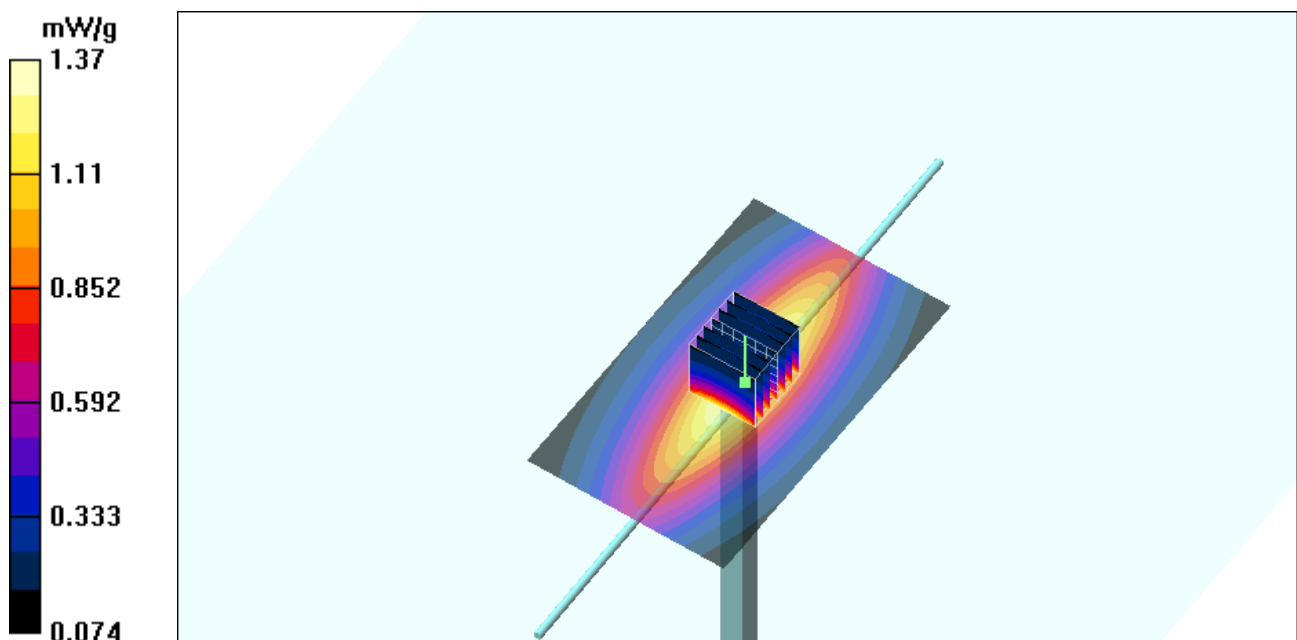

DEC 21, 2005

SAR; Z Scan: Value Along Z, X=0, Y=0

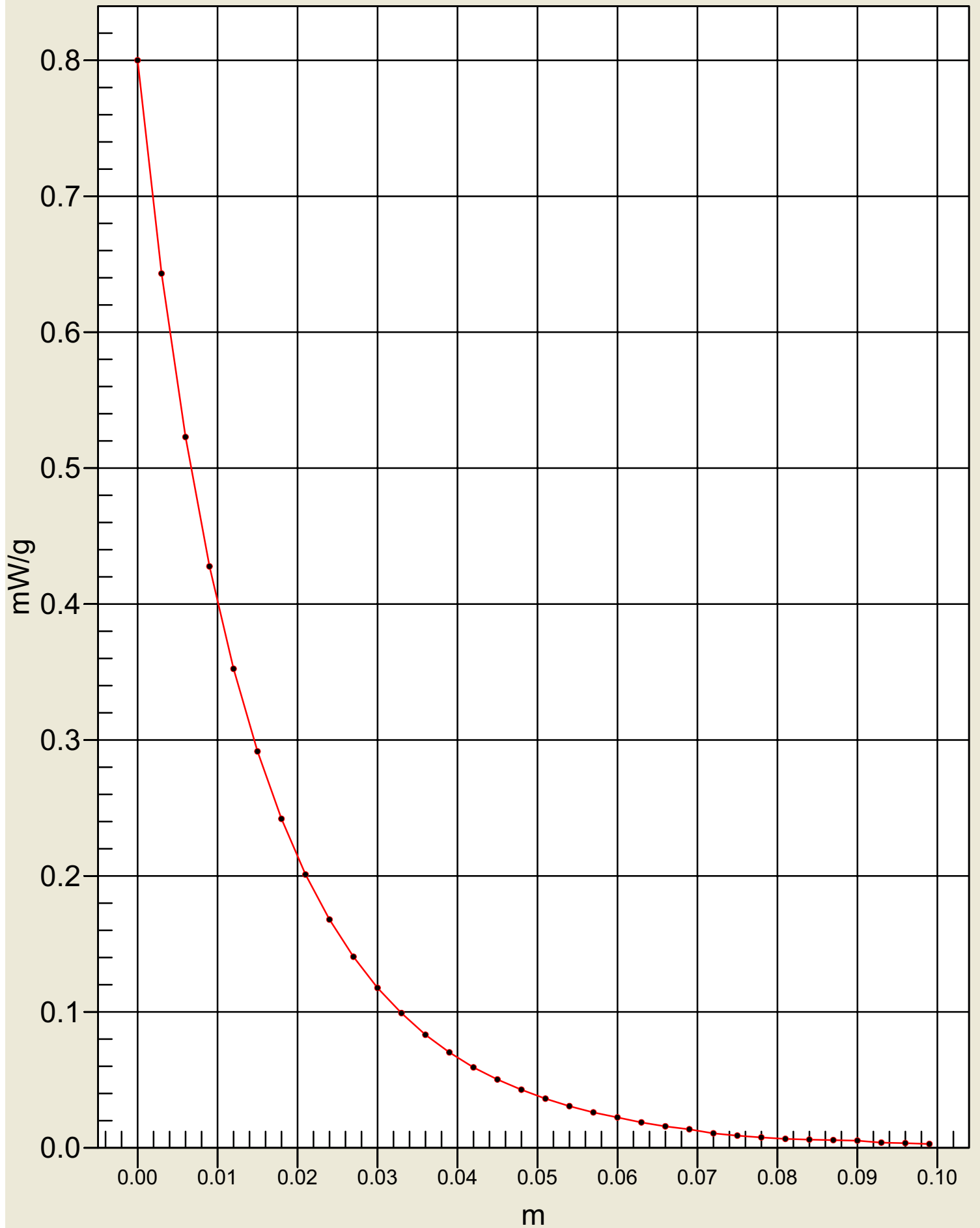

450MHz Validation Dec 27-2005

Date/Time: 12/27/2005 08:55:18 AM

DUT: Dipole 450 MHz; Type: D450V2; Serial: D450V2 - SN:004

Medium Notes: Ambient Temp: 22.9 deg C; Fluid Temp: 22.1 deg C

Communication System: CW; ; Frequency: 450 MHz; Duty Cycle: 1:1

Medium: 450MHz head Medium parameters used: $f = 450$ MHz; $\sigma = 0.85$ mho/m; $\epsilon_r = 46.0$; $\rho = 1000$ kg/m³

Phantom section: Flat Section

Probe: ET3DV6 - SN1793; ConvF(7.6, 7.6, 7.6); Calibrated: 9/20/2005

Sensor-Surface: 4mm (Mechanical Surface Detection)

Electronics: DAE3 Sn584; Calibrated: 9/22/2005

Phantom: Validation Phantom in front of RX90; Type: Plexiglas; Serial: 001

Measurement SW: DASY4, V4.5 Build 19; Postprocessing SW: SEMCAD, V1.8 Build 146

Area Scan (101x61x1): Measurement grid: dx=15mm, dy=15mm

Maximum value of SAR (interpolated) = 1.36 mW/g

Zoom Scan (7x7x7)/Cube 0: Measurement grid: dx=5mm, dy=5mm, dz=5mm

Reference Value = 39.9 V/m; Power Drift = 0.00 dB

Peak SAR (extrapolated) = 2.29 W/kg

SAR(1 g) = 1.28 mW/g; SAR(10 g) = 0.826 mW/g

Maximum value of SAR (measured) = 1.37 mW/g

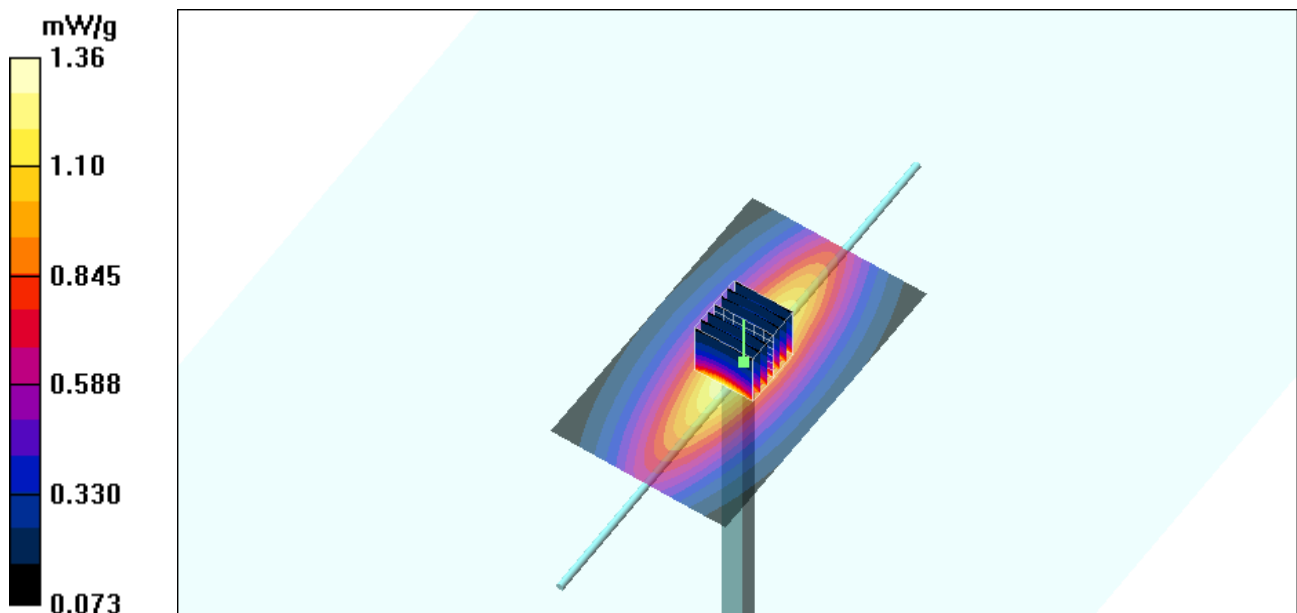

DEC 27, 2005

SAR; Z Scan: Value Along Z, X=0, Y=0

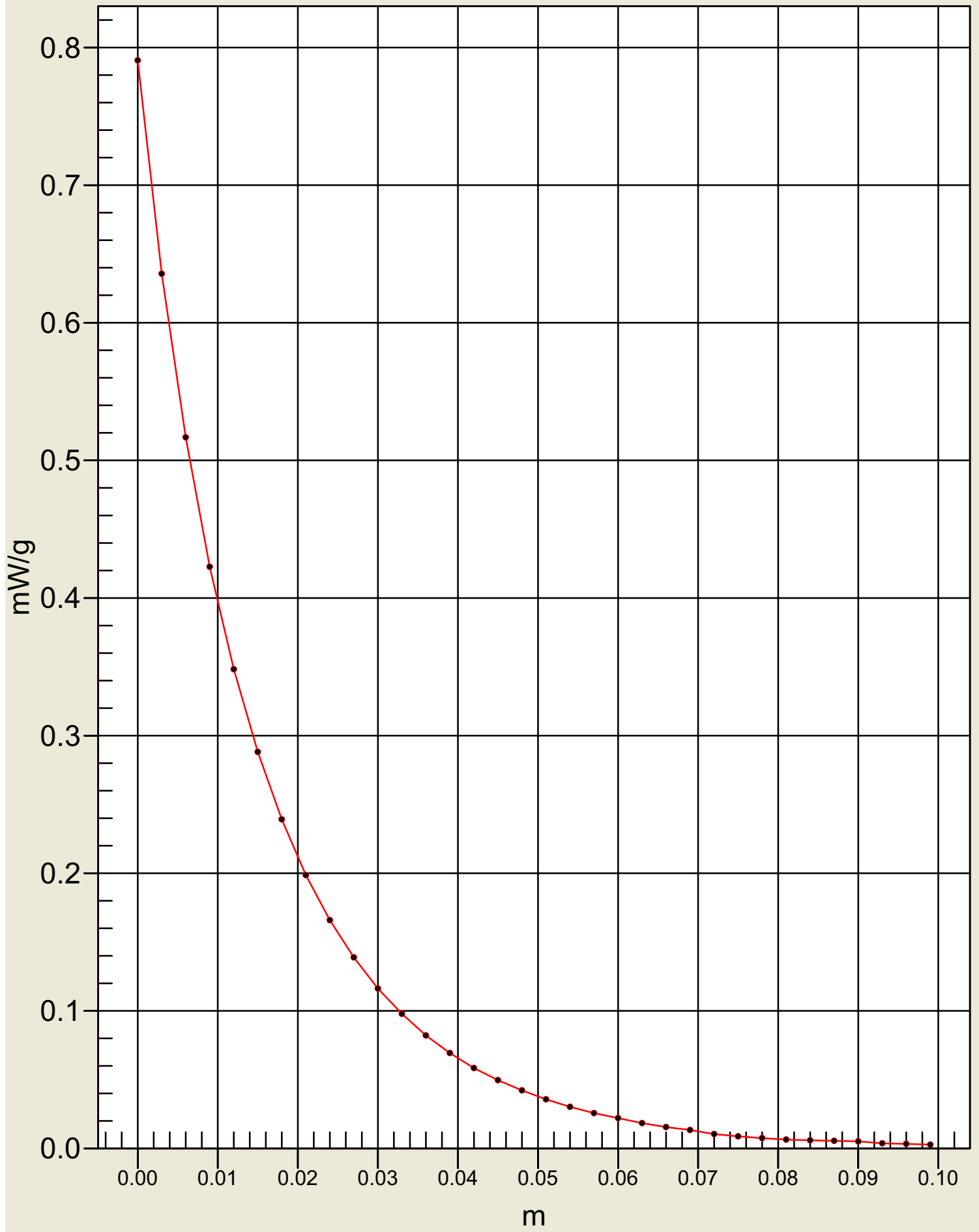



Kenwood Communications Corporation
TK-5300

Electromagnetic Compatibility
FCC OET 65 Supplement C: 01-01

Appendix E – PROBE CALIBRATION CERTIFICATE

152441

Calibration Laboratory of
Schmid & Partner
Engineering AG
Zeughausstrasse 43, 8004 Zurich, Switzerland



S Schweizerischer Kalibrierdienst
C Service suisse d'étalonnage
S Servizio svizzero di taratura
S Swiss Calibration Service

Accredited by the Swiss Federal Office of Metrology and Accreditation
The Swiss Accreditation Service is one of the signatories to the EA
Multilateral Agreement for the recognition of calibration certificates

Accreditation No.: SCS 108

Client MET Laboratories

Certificate No: ET3-1793_Sep05

CALIBRATION CERTIFICATE

Object ET3DV6 - SN:1793

Calibration procedure(s) QA CAL-01.v5
Calibration procedure for dosimetric E-field probes

Calibration date: September 20, 2005

Condition of the calibrated item In Tolerance

This calibration certificate documents the traceability to national standards, which realize the physical units of measurements (SI).
The measurements and the uncertainties with confidence probability are given on the following pages and are part of the certificate.

All calibrations have been conducted in the closed laboratory facility: environment temperature (22 ± 3)°C and humidity < 70%.

Calibration Equipment used (M&TE critical for calibration)

Primary Standards	ID #	Cal Date (Calibrated by, Certificate No.)	Scheduled Calibration
Power meter E4419B	GB41293874	3-May-05 (METAS, No. 251-00466)	May-06
Power sensor E4412A	MY41495277	3-May-05 (METAS, No. 251-00466)	May-06
Power sensor E4412A	MY41498087	3-May-05 (METAS, No. 251-00466)	May-06
Reference 3 dB Attenuator	SN: S5054 (3c)	11-Aug-05 (METAS, No. 251-00499)	Aug-06
Reference 20 dB Attenuator	SN: S5086 (20b)	3-May-05 (METAS, No. 251-00467)	May-06
Reference 30 dB Attenuator	SN: S5129 (30b)	11-Aug-05 (METAS, No. 251-00500)	Aug-06
Reference Probe ES3DV2	SN: 3013	7-Jan-05 (SPEAG, No. ES3-3013_Jan05)	Jan-06
DAE4	SN: 654	29-Nov-04 (SPEAG, No. DAE4-654_Nov04)	Nov-05

Secondary Standards	ID #	Check Date (in house)	Scheduled Check
RF generator HP 8648C	US3642U01700	4-Aug-99 (SPEAG, in house check Dec-03)	In house check: Dec-05
Network Analyzer HP 8753E	US37390585	18-Oct-01 (SPEAG, in house check Nov-04)	In house check: Nov 05

Calibrated by:	Name Nico Vetterli	Function Laboratory Technician	Signature
Approved by:	Name Katja Pokovic	Function Technical Manager	Signature

Issued: September 21, 2005

This calibration certificate shall not be reproduced except in full without written approval of the laboratory.



Accredited by the Swiss Federal Office of Metrology and Accreditation
The Swiss Accreditation Service is one of the signatories to the EA
Multilateral Agreement for the recognition of calibration certificates

Accreditation No.: **SCS 108**

Glossary:

TSL	tissue simulating liquid
NORM _{x,y,z}	sensitivity in free space
ConF	sensitivity in TSL / NORM _{x,y,z}
DCP	diode compression point
Polarization φ	φ rotation around probe axis
Polarization ϑ	ϑ rotation around an axis that is in the plane normal to probe axis (at measurement center), i.e., $\vartheta = 0$ is normal to probe axis

Calibration is Performed According to the Following Standards:

- IEEE Std 1528-2003, "IEEE Recommended Practice for Determining the Peak Spatial-Averaged Specific Absorption Rate (SAR) in the Human Head from Wireless Communications Devices: Measurement Techniques", December 2003
- CENELEC EN 50361, "Basic standard for the measurement of Specific Absorption Rate related to human exposure to electromagnetic fields from mobile phones (300 MHz - 3 GHz), July 2001

Methods Applied and Interpretation of Parameters:

- NORM_{x,y,z}**: Assessed for E-field polarization $\vartheta = 0$ ($f \leq 900$ MHz in TEM-cell; $f > 1800$ MHz: R22 waveguide). NORM_{x,y,z} are only intermediate values, i.e., the uncertainties of NORM_{x,y,z} does not effect the E²-field uncertainty inside TSL (see below *ConvF*).
- NORM(f)_{x,y,z} = NORM_{x,y,z} * frequency_response** (see Frequency Response Chart). This linearization is implemented in DASY4 software versions later than 4.2. The uncertainty of the frequency response is included in the stated uncertainty of *ConvF*.
- DCP_{x,y,z}**: DCP are numerical linearization parameters assessed based on the data of power sweep (no uncertainty required). DCP does not depend on frequency nor media.
- ConvF and Boundary Effect Parameters**: Assessed in flat phantom using E-field (or Temperature Transfer Standard for $f \leq 800$ MHz) and inside waveguide using analytical field distributions based on power measurements for $f > 800$ MHz. The same setups are used for assessment of the parameters applied for boundary compensation (alpha, depth) of which typical uncertainty values are given. These parameters are used in DASY4 software to improve probe accuracy close to the boundary. The sensitivity in TSL corresponds to NORM_{x,y,z} * ConvF whereby the uncertainty corresponds to that given for ConvF. A frequency dependent ConvF is used in DASY version 4.4 and higher which allows extending the validity from ± 50 MHz to ± 100 MHz.
- Spherical isotropy (3D deviation from isotropy)**: in a field of low gradients realized using a flat phantom exposed by a patch antenna.
- Sensor Offset**: The sensor offset corresponds to the offset of virtual measurement center from the probe tip (on probe axis). No tolerance required.

Probe ET3DV6

SN:1793

Manufactured:	May 28, 2005
Last calibrated:	September 15, 2003
Recalibrated:	September 20, 2005

Calibrated for DASY Systems

(Note: non-compatible with DASY2 system!)

DASY - Parameters of Probe: ET3DV6 SN:1793**Sensitivity in Free Space^A**

NormX	1.72 ± 10.1%	$\mu\text{V}/(\text{V}/\text{m})^2$
NormY	1.71 ± 10.1%	$\mu\text{V}/(\text{V}/\text{m})^2$
NormZ	1.76 ± 10.1%	$\mu\text{V}/(\text{V}/\text{m})^2$

Diode Compression^B

DCP X	93 mV
DCP Y	93 mV
DCP Z	93 mV

Sensitivity in Tissue Simulating Liquid (Conversion Factors)

Please see Page 8.

Boundary Effect

TSL **900 MHz** **Typical SAR gradient: 5 % per mm**

Sensor Center to Phantom Surface Distance		3.7 mm	4.7 mm
SAR _{be} [%]	Without Correction Algorithm	8.3	4.4
SAR _{be} [%]	With Correction Algorithm	0.1	0.2

TSL **1810 MHz** **Typical SAR gradient: 10 % per mm**

Sensor Center to Phantom Surface Distance		3.7 mm	4.7 mm
SAR _{be} [%]	Without Correction Algorithm	12.7	8.6
SAR _{be} [%]	With Correction Algorithm	0.9	0.1

Sensor Offset

Probe Tip to Sensor Center **2.7 mm**

The reported uncertainty of measurement is stated as the standard uncertainty of measurement multiplied by the coverage factor k=2, which for a normal distribution corresponds to a coverage probability of approximately 95%.

^A The uncertainties of NormX,Y,Z do not affect the E²-field uncertainty inside TSL (see Page 8).

^B Numerical linearization parameter: uncertainty not required.

Frequency Response of E-Field

(TEM-Cell:ifi110 EXX, Waveguide: R22)

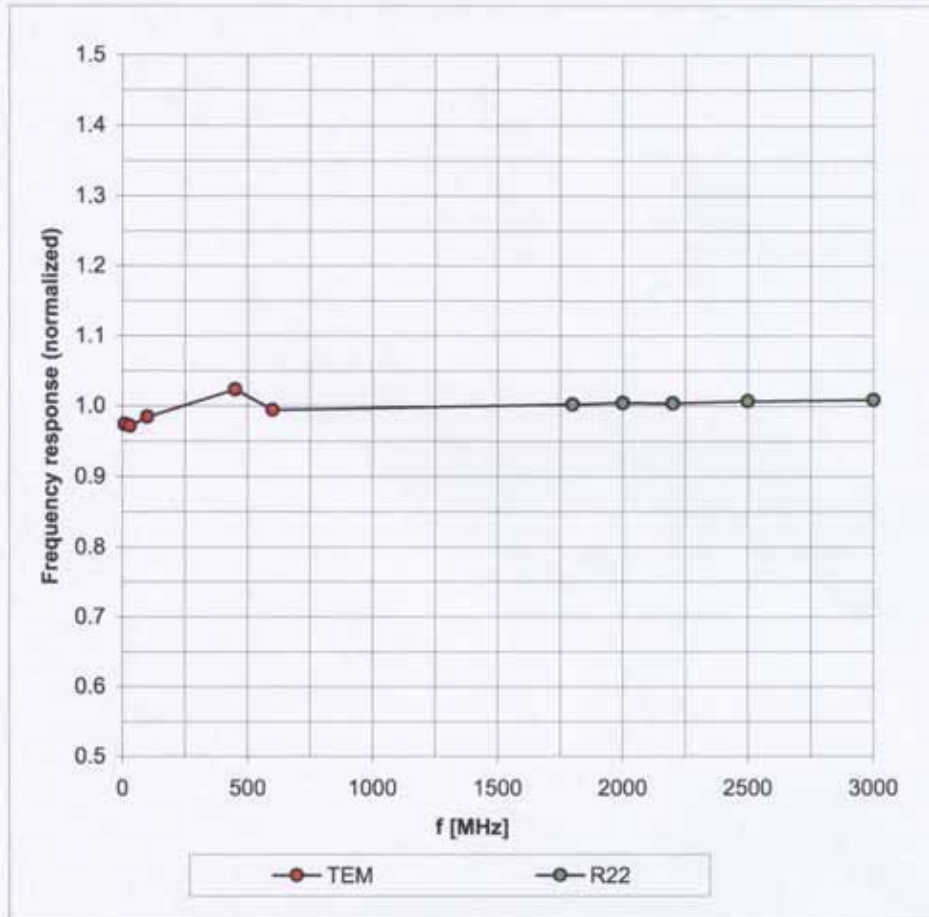

Uncertainty of Frequency Response of E-field: $\pm 6.3\%$ ($k=2$)

Receiving Pattern (ϕ), $\vartheta = 0^\circ$

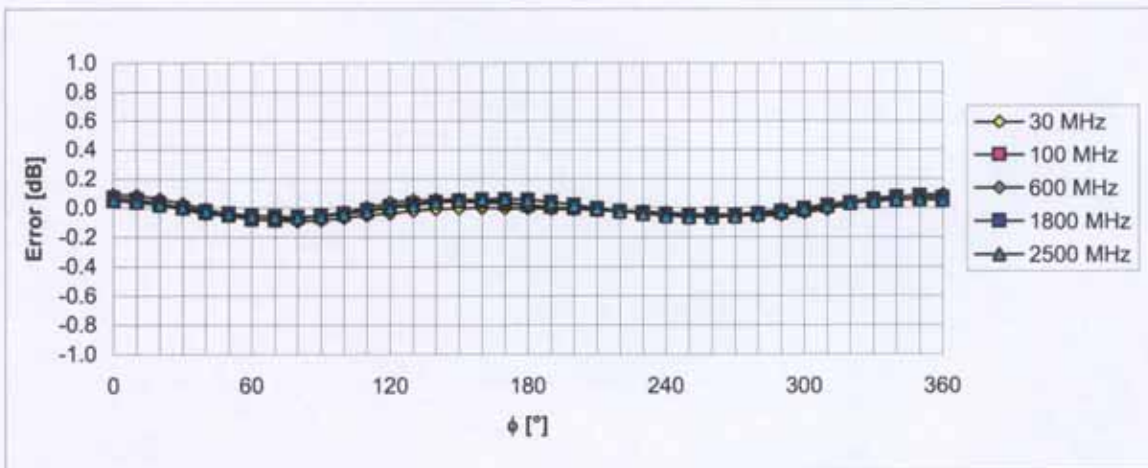
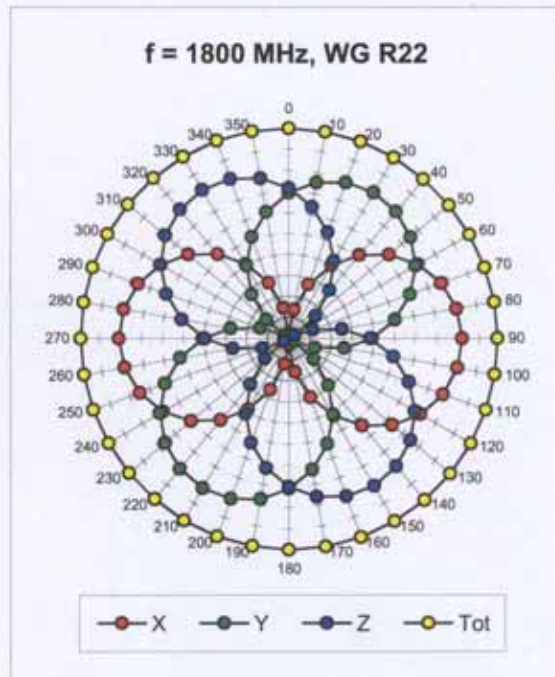
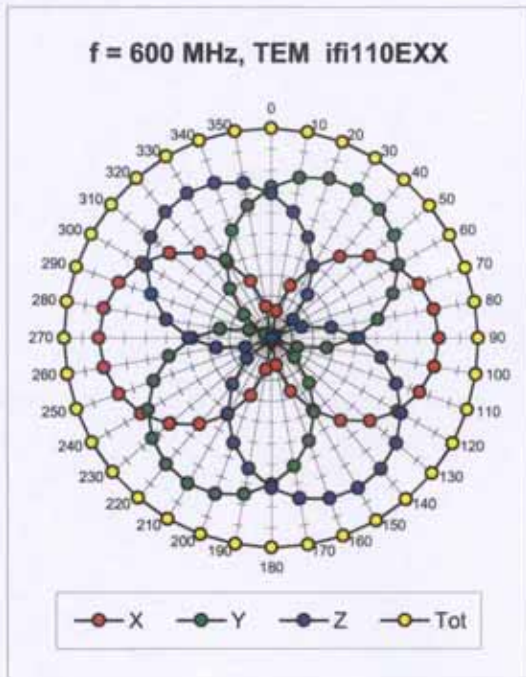

Uncertainty of Axial Isotropy Assessment: $\pm 0.5\%$ ($k=2$)

Dynamic Range $f(\text{SAR}_{\text{head}})$ (Waveguide R22, $f = 1800 \text{ MHz}$)

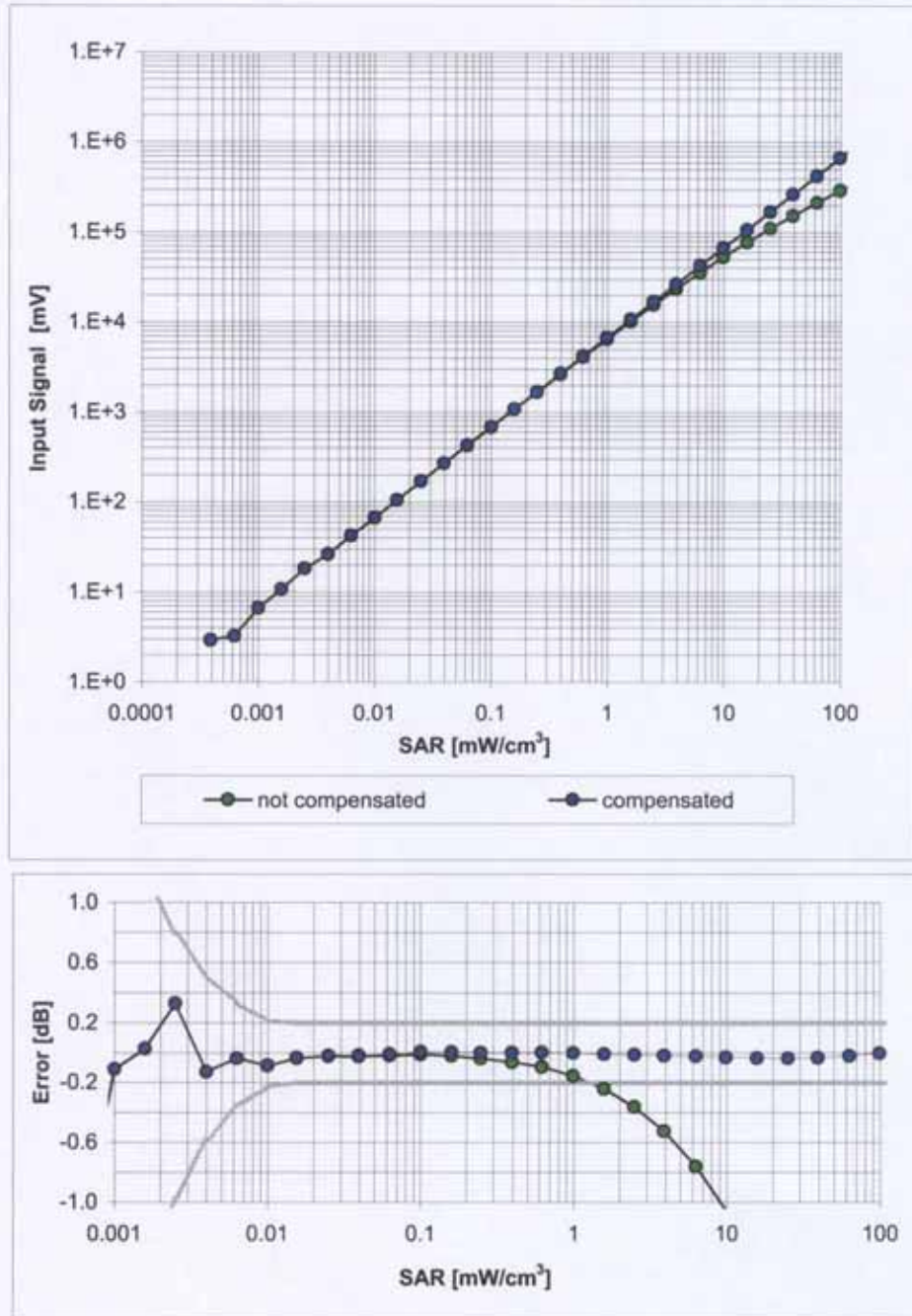

Uncertainty of Linearity Assessment: $\pm 0.6\%$ ($k=2$)

Conversion Factor Assessment

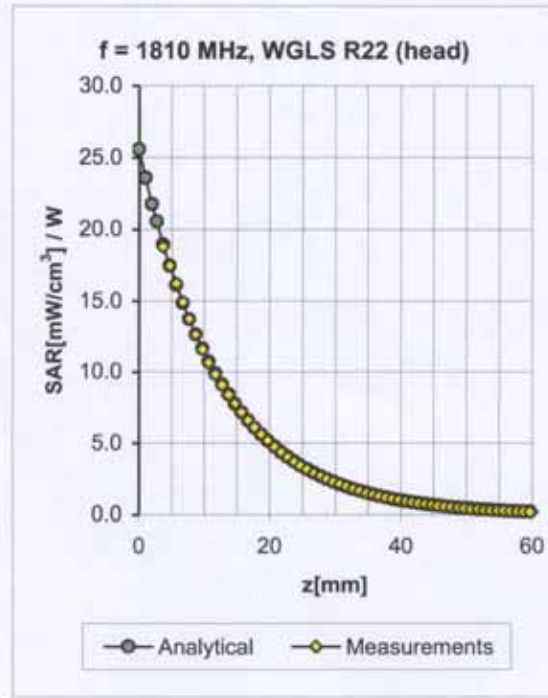
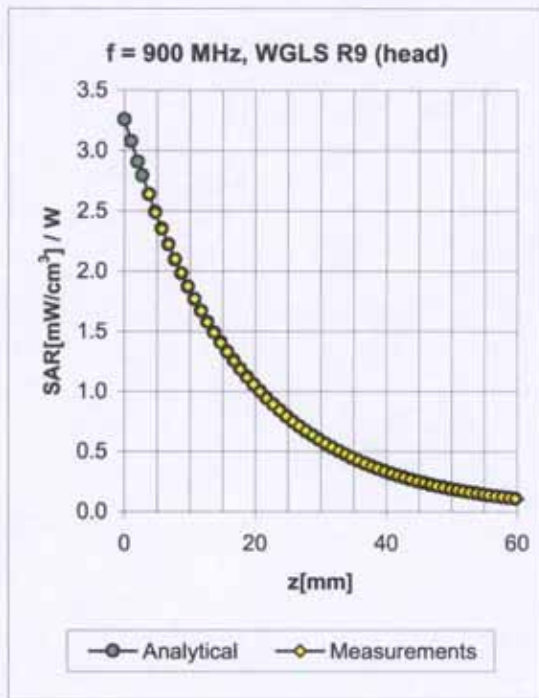

f [MHz]	Validity [MHz] ^c	TSL	Permittivity	Conductivity	Alpha	Depth	ConvF Uncertainty
900	± 50 / ± 100	Head	41.5 ± 5%	0.97 ± 5%	0.55	1.86	6.27 ± 11.0% (k=2)
1810	± 50 / ± 100	Head	40.0 ± 5%	1.40 ± 5%	0.60	2.29	5.22 ± 11.0% (k=2)

^c The validity of ± 100 MHz only applies for DASY v4.4 and higher (see Page 2). The uncertainty is the RSS of the ConvF uncertainty at calibration frequency and the uncertainty for the indicated frequency band.

Deviation from Isotropy in HSL

Error (ϕ, θ), $f = 900$ MHz

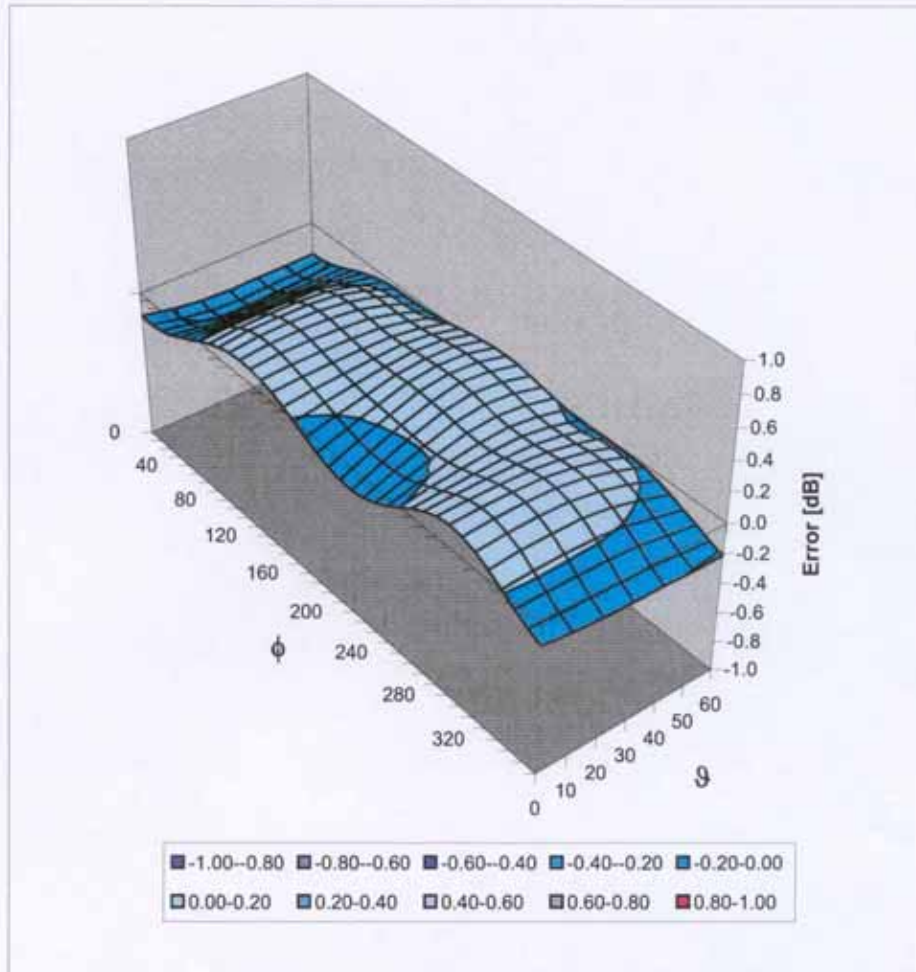

Uncertainty of Spherical Isotropy Assessment: $\pm 2.6\%$ ($k=2$)

Dosimetric E-Field Probe ET3DV6 SN:1793Conversion factor (\pm standard deviation)

450 MHz	ConvF	$7.6 \pm 8\%$	$\epsilon_r = 43.5 \pm 5\%$ $\sigma = 0.87 \pm 5\%$ mho/m (head tissue)
450 MHz	ConvF	$7.5 \pm 8\%$	$\epsilon_r = 56.7 \pm 5\%$ $\sigma = 0.94 \pm 5\%$ mho/m (body tissue)
900 MHz	ConvF	$6.3 \pm 8\%$	$\epsilon_r = 55.0 \pm 5\%$ $\sigma = 1.05 \pm 5\%$ mho/m (body tissue)
1800 MHz	ConvF	$4.8 \pm 8\%$	$\epsilon_r = 53.3 \pm 5\%$ $\sigma = 1.52 \pm 5\%$ mho/m (body tissue)



Kenwood Communications Corporation
TK-5300

Electromagnetic Compatibility
FCC OET 65 Supplement C: 01-01

Appendix F – DIPOLE CALIBRATION CERTIFICATE

CALIBRATION CERTIFICATE

Object: 450MHz Validation Dipole; serial # 004

Calibration Procedure: Calibration procedure for a validation dipole

Calibration Date: December 9, 2004

Condition of the Calibrated Item: In Tolerance

This calibration certificate documents the traceability to national standards, which realize the physical units of measurements (SI). The measurements and the uncertainties with confidence probability are given on the following pages and are part of the certificate.

All calibrations have been conducted in a closed laboratory facility: environment temperature $(21 \pm 3) ^\circ \text{C}$ and humidity $< 70\%$

Calibration equipment used

Model Type	Serial Number	MET Asset #	Cal due Date
Anritsu Power Meter ML2488A	6K00001832	1S2430	June 2005
Anritsu Power Sensor	030864	1S2432	June 2005
HP E4418B Power Meter	GB40205140	1S2276	June 2005
HP 8482A Power Sensor	2607A11286	1S2140	June 2005
83650B Signal Generator	3844A00910	1S2278	June 2005
HP 8722D Vector Network Analyzer	3S36140188	1S2272	March 2005

Calibrated by: Shawn McMillen
Name

Senior Engineer
Function



Signature

This calibration certificate shall not be reproduced except in full

Date of Issue: December 9, 2004

Calibration procedure for validation dipole

Calibration is performed according to the following standards:

- a) IEEE Std 1528-2003, “IEEE Recommended Practice for Determining the Peak Spatial Averaged Specific Absorption Rate (SAR) in the Human Head from Wireless Communication Devices: Measurement Techniques”, December 2003
- b) CENELEC EN 50361, “Basic standard for the measurement of Specific Absorption Rate related to human exposure to electromagnetic fields from mobile phones (300MHz – 3GHz), July 2001
- c) Federal Communications Commission Office of Engineering & Technology (FCC OET), “Evaluating Compliance with FCC Guidelines for Human Exposure to Radiofrequency Electromagnetic Fields; Additional information for Evaluating Compliance of Mobile and Portable Devices with FCC Limits for Human Exposure to Radiofrequency Emissions”, Bulletin 65 Supplement C (Edition 01-01).

Additional Documents

- d) DASY4 System Handbook

Methods Applied and Interpretation of Parameters:

- Measurement Conditions: Further details are available from the Validation Report at the end of the certificate. All Figures stated in the certificate are valid at the frequency indicated.
- Antenna flatness: The antenna is checked for straightness using a straight edge placed parallel to the dipole arms.
- Antenna Parameters with Tissue Simulating Liquid (TSL): The dipole is mounted with the spacer to position its feed point exactly below the center marking of the flat phantom section, with the arms oriented parallel to the body axis.
- Vector Network Analyzer: The network analyzer is calibrated as per the user’s manual.
- Feed Point Impedance and Return Loss: These parameters are measured with the dipole positioned under the liquid filled phantom. The impedance stated is transformed from the measurement at the SMA connector to the feed point. A Return Loss >20dB ensures low reflected power. No uncertainty required.
- Electrical Delay: One-way delay between the SMA connector and the antenna feed point. No Uncertainty required.
- SAR measured: SAR measured at the stated antenna input power.
- SAR normalized: SAR as measured, normalized to an input power of 1W at the antenna connector. No Uncertainty required
- SAR for nominal TSL parameters: The measured TSL parameters are used to calculate the SAR results.

Measurement Conditions

DASY system configuration

DASY Version	DASY4	V4.4
Extrapolation	Advanced Extrapolation	
Phantom	Planar Validation Phantom	1S2450
Dipole Spacer		
Distance Dipole Center-TSL	15.14mm ± 0.2mm	With spacer
Area Scan resolution	dx, dy = 10mm	
Zoom Scan resolution	dx, dy, dz = 5mm	
Frequency	450MHz ± 1MHz	

Head TSL Parameters

The following parameters and calculations were applied

	Temperature	Permittivity	Conductivity
Nominal Head TSL Parameters	22.0 °C	43.5	0.87
Measured Head TSL Parameters		43.5 ±5%	0.87 ±5%
Head TSL Temperature during Test	20.8 °C	--	--

Measurement Uncertainty of Dipole Calibration

Error Description	Uncertainty Value ±%	Probability Distribution	Divisor	C_i 1g	Standard Uncertainty ±% (1g)
Anritsu Power Meter ML2488A	± 1.4	normal	2	1	± 0.7
Anritsu Power Sensor	± 1.4	normal	2	1	± 0.7
HP E4418B Power Meter	± 0.2	normal	2	1	± 0.1
HP 8482A Power Sensor	± 0.8	normal	2	1	± 0.4
83650B Signal Generator	± 2.0	normal	2	1	± 1.0
HP 8722D Vector Network Analyzer	± 2.0	normal	2	1	± 1.0
Combined Standard Uncertainty					± 3.9

SAR results with Head TSL and system uncertainty

SAR averaged over 1 cm ³ (1g) of Head TSL	Condition	
SAR Normalized	Normalized to 1 W	5.24 mW/g
SAR for nominal Head TSL Parameters	Normalized to 1W	5.24 ± 24.29% mW/g (k=2)

SAR averaged over 1 cm ³ (10g) of Head TSL	Condition	
SAR Normalized	Normalized to 1 W	3.51 mW/g
SAR for nominal Head TSL Parameters	Normalized to 1W	3.51 ± 23.51% mW/g (k=2)



450 MHz System Validation Dipole

Type:	450Mhz
-------	--------

Serial Number:	004
----------------	-----

Place of Calibration:	MET Laboratories, Inc. 4855 Patrick Henry Dr. Bldg #6 Santa Clara, CA 95054USA
-----------------------	---

Date of Calibration:	December 9, 2004
----------------------	------------------

MET Laboratories, Inc certifies that this device has been calibrated on the date indicated above.

:

Approved By:



Shawn McMillen
SAR Compliance Manager



1. Measurement Conditions

The DASY4 System with a dosimetric E-Field probe ET3DV6 (SN1793, Conversion factor 7.6 at 450 MHz) was used for the measurements.

The target dielectric parameters for the head simulating solution used for the calibration at 450MHz is:

Relative Dielectricity	43.5 ±5%
Conductivity	0.87 ±5%

The measurements were performed in an 82x40x22cm flat Plexiglas Phantom filled with head stimulant tissue.

The dipole was mounted so that the dipole feed point was positioned below the center marking of the flat phantom section and the dipole was oriented parallel to the body axis (the long side of the phantom). The standard measuring distance was 15mm from dipole center to solution surface. A loss-less dielectric spacer was used during measurements for accurate distance positioning.

The course grid with a grid spacing of 15mm was aligned with the dipole. The 7x7x7 fine cube was chosen for cube integration. The dipole input power (forward power) was 250mW ±3%. The results are normalized to 1W input power.

2. SAR Measurement with DASY4 System

Standard SAR measurement were performed according to the measurement conditions described in section 1. The resulting average SAR values measured with the dosimetric probe ET3DV6 (SN1793) and applying advanced extrapolation are:

Averaged over 1cm³ (1g) of tissue: 5.24 mW/g

Averaged over 10cm³ (10g) of tissue: 3.51 mW/g

3. Dipole Impedance and Return Loss

The dipole was positioned at the flat phantom sections according to section 1 with the 15mm spacer. The impedance and return loss measurements are

Complex impedance at 450 MHz $\text{Re}\{Z\} = 58.014 \Omega$

$\text{Im}\{Z\} = 6.4277 \Omega$

Return Loss at 450 MHz -20.467 dB



4. SAR Measurement

The SAR measurement was performed with the E-field probe in mechanical detection mode only. The setup and determination of the forward power into the dipole was performed using the following procedures.

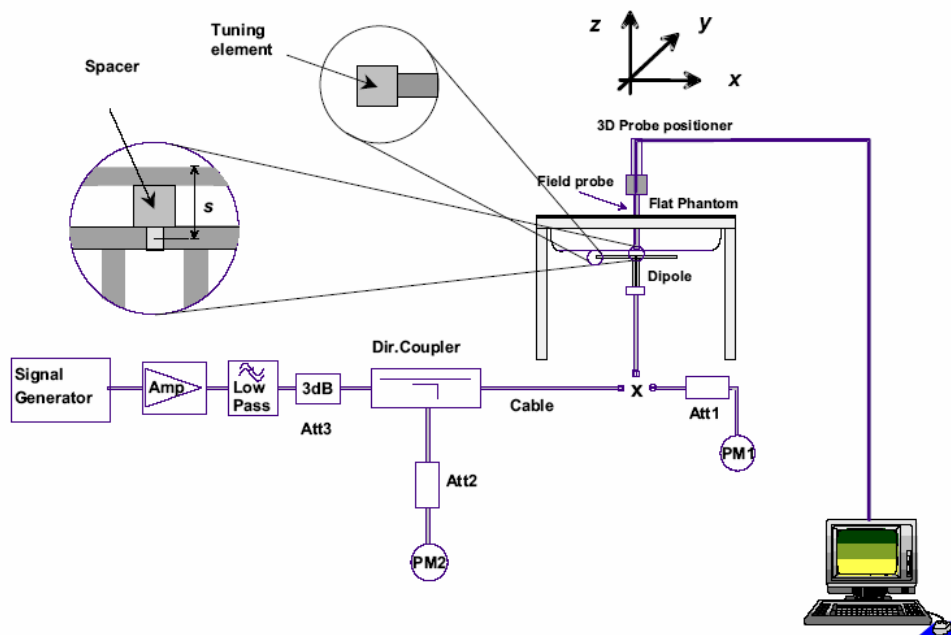

First the power meter PM1 (including attenuator Att1) is connected to the RF cable to measure the forward power at the location of the dipole connector (X). The signal generator is adjusted for the desired forward power at the dipole connector (taking into account the attenuation of Att1) as read by power meter PM2. After connecting the cable to the dipole, the signal generator is readjusted for the same reading at power meter PM2. If the signal generator does not allow adjustment in 0.01dB steps, the remaining difference at PM2 must be taken into consideration. The matching of the dipole should be checked using a network analyzer to ensure that the reflected power is at least 20 dB below the forward power.



4. Handling

Do not apply excessive force to the dipole arms, because they might bend. Bending of the dipole arms stresses the soldered connections near the feed point leading to a damage of the dipole.

5. Design

The validation dipole is made of standard semi ridged coaxial cable and is constructed in accordance with the IEEE Std “Recommended Practice for Determining the Spatial-Peak Specific Absorption Rate (SAR) in the Human Body Due to Wireless Communications Devices: Experimental Techniques”. The center conductor of the feeding line is directly connected to the second arm of the dipole. The antenna is therefore short-circuited for DC-signals.

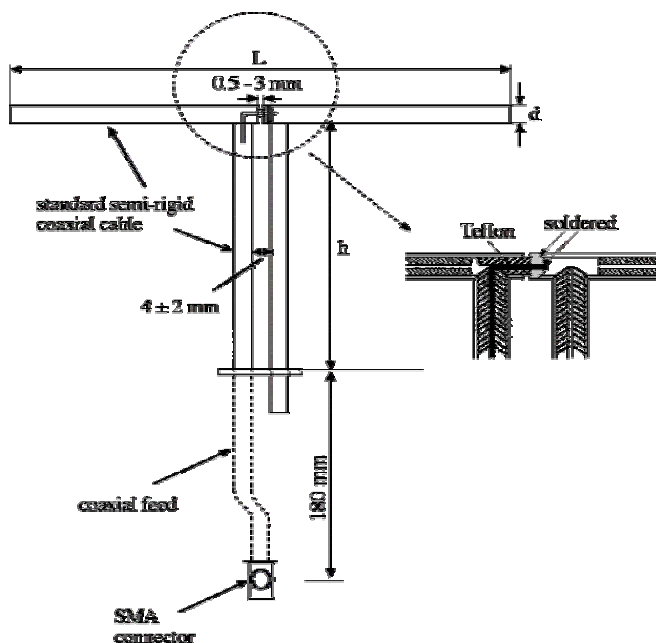

Frequency (MHz)	L (mm)	h (mm)	d (mm)
300	396.0	250.0	6.35
450	270.0	166.7	6.35
835	161.0	89.8	3.6
900	149.0	83.3	3.6
1450	89.1	51.7	3.6
1800	72.0	41.7	3.6
1900	68.0	39.5	3.6
2000	64.5	37.5	3.6
2450	51.8	30.4	3.6
3000	41.5	25.0	3.6

Validation Dipole Dimensions



6. Determination of Target SAR number

A total of 10 test runs were carried out. The fluid dielectric parameters were measured prior to each run. After each run the dipole was removed from the phantom surface, the forward dipole power reset and the dipole repositioned next to the phantom surface.

Test Run	Relative Dielectricity	Conductivity mho/m	SAR@250mW Over 1g	SAR@250mW Over 10g
Run #1	44.5	0.88	1.31	0.876
Run #2	43.7	0.89	1.33	0.877
Run #3	44.6	0.88	1.32	0.878
Run #4	44.6	0.86	1.29	0.876
Run #5	43.9	0.88	1.30	0.874
Run #6	44.5	0.87	1.32	0.877
Run #7	43.8	0.89	1.33	0.875
Run #8	44.9	0.88	1.32	0.880
Run #9	43.7	0.88	1.29	0.875
Run # 10	44.4	0.87	1.31	0.877
		Target Average	1.31	0.877

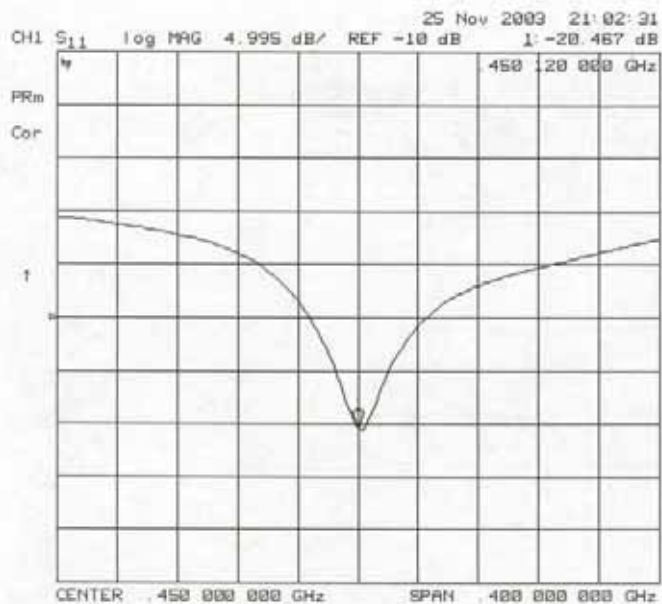
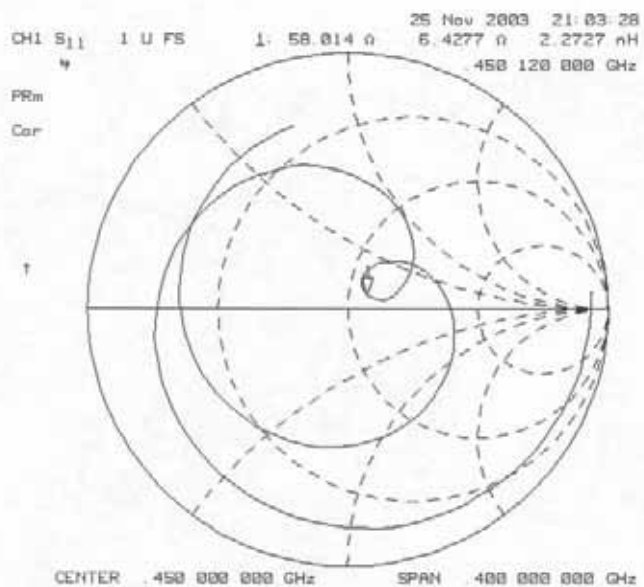

DUT: Dipole 450 MHz; Type: D450V2; Serial: D450V2 - SN:004

Communication System: CW; ; Frequency: 450 MHz; Duty Cycle: 1:1

Medium: 450MHz HSL Medium parameters used: $f = 450$ MHz; $\sigma = 0.87$ mho/m; $\epsilon_r = 44.5$; $\rho = 1000$ kg/m³

Phantom section: Flat Section

- Probe: ET3DV6 - SN1793; ConvF(7.1, 7.1, 7.1); Calibrated: 9/15/2003

- Sensor-Surface: 4mm (Mechanical Surface Detection)

- Electronics: DAE3 Sn584; Calibrated: 9/16/2003

- Phantom: Validation Phantom in front of RX90; Type: Plexiglas; Serial: 001

- Measurement SW: DASY4, V4.4 Build 3; Postprocessing SW: SEMCAD, V1.8 Build 130

Area Scan (151x71x1): Measurement grid: $dx=10$ mm, $dy=10$ mm

Maximum value of SAR (interpolated) = 1.4 mW/g

/Zoom Scan (7x7x7)/Cube 0: Measurement grid: $dx=5$ mm, $dy=5$ mm, $dz=5$ mm

Reference Value = 40.1 V/m; Power Drift = -0.004 dB

Peak SAR (extrapolated) = 2.01 W/kg

SAR(1 g) = 1.32 mW/g; SAR(10 g) = 0.877 mW/g

Maximum value of SAR (measured) = 1.41 mW/g

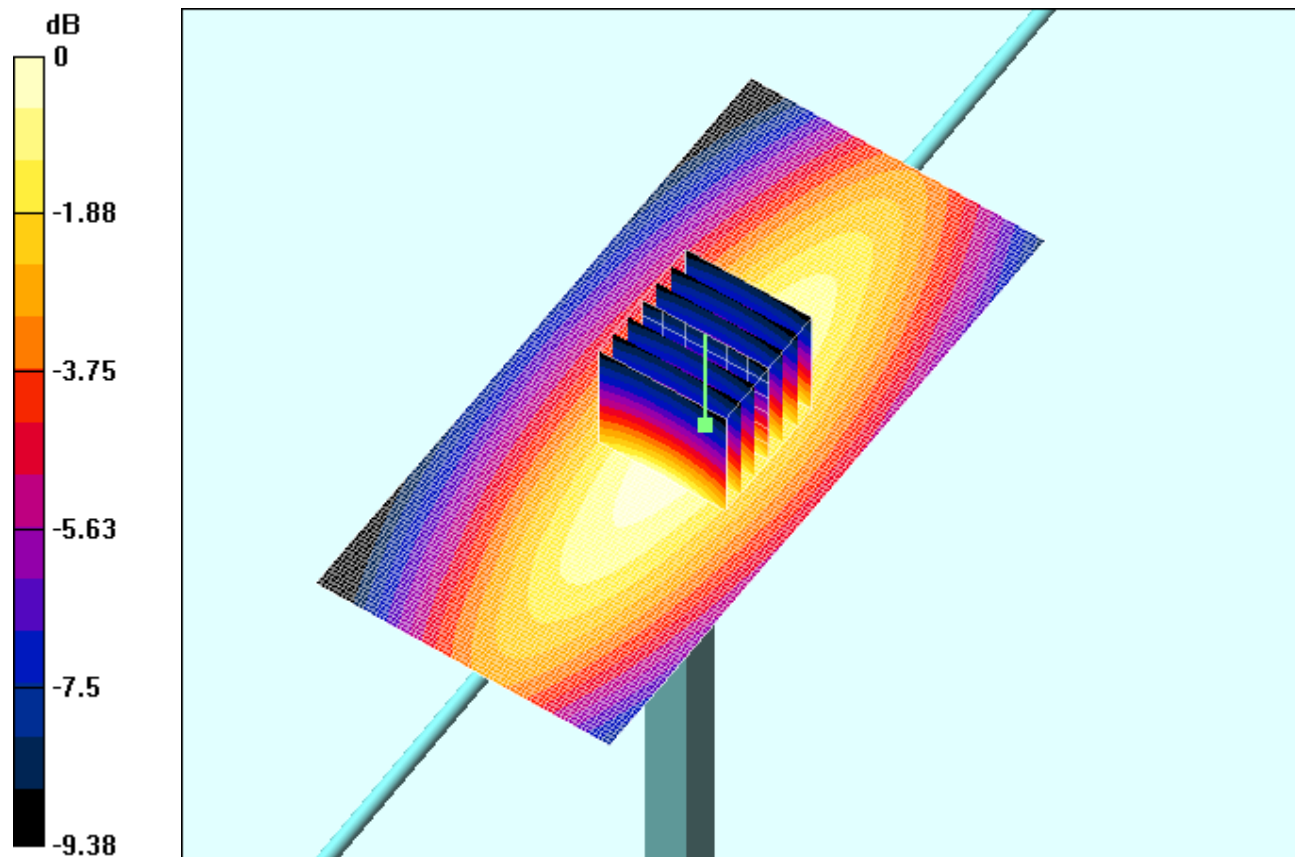

0 dB = 1.41mW/g



Kenwood Communications Corporation
TK-5300

Electromagnetic Compatibility
FCC OET 65 Supplement C: 01-01

Appendix G – MEASURED FLUID DIELECTRIC PARAMETERS

450MHz Head

December 21, 2005 07:58 AM

Frequency	e'	e''
400.000000 MHz	47.5197	36.5845
402.000000 MHz	47.7266	36.9187
404.000000 MHz	47.3764	36.6700
406.000000 MHz	47.3175	36.7519
408.000000 MHz	47.0395	36.1364
410.000000 MHz	47.2791	36.6146
412.000000 MHz	47.2347	36.1837
414.000000 MHz	47.0970	36.4616
416.000000 MHz	47.0705	36.0124
418.000000 MHz	47.1697	35.7288
420.000000 MHz	46.9324	35.8607
422.000000 MHz	46.6912	35.9526
424.000000 MHz	46.7942	35.6922
426.000000 MHz	46.6992	35.3762
428.000000 MHz	46.5629	35.5420
430.000000 MHz	46.7086	34.9466
432.000000 MHz	46.6538	35.7930
434.000000 MHz	46.5190	35.4010
436.000000 MHz	46.6885	35.3315
438.000000 MHz	46.4757	35.0542
440.000000 MHz	46.2305	35.1592
442.000000 MHz	46.4184	34.9735
444.000000 MHz	46.4048	34.4414
446.000000 MHz	46.2788	34.6141
448.000000 MHz	46.1468	34.5696
450.000000 MHz	46.1793	34.4893
452.000000 MHz	45.6312	34.6364
454.000000 MHz	45.8054	34.2726
456.000000 MHz	46.0318	34.2366
458.000000 MHz	45.8007	33.9071
460.000000 MHz	45.7539	34.1205
462.000000 MHz	45.4101	34.5292
464.000000 MHz	45.6554	33.8492
466.000000 MHz	45.7289	34.1132
468.000000 MHz	45.7120	33.7374
470.000000 MHz	45.6064	33.9036
472.000000 MHz	45.3520	33.8241
474.000000 MHz	45.3985	33.6046
476.000000 MHz	45.3186	33.6942
478.000000 MHz	45.0949	33.3543
480.000000 MHz	45.3842	33.6201
482.000000 MHz	45.1714	33.2375
484.000000 MHz	44.9884	33.2223
486.000000 MHz	45.2445	33.3064
488.000000 MHz	44.9535	32.6648

450MHz Body

December 21, 2005 10:30 AM

Frequency	e'	e''
400.000000 MHz	59.7421	39.6137
402.000000 MHz	59.7320	39.3086
404.000000 MHz	59.3163	39.0943
406.000000 MHz	59.1388	38.7324
408.000000 MHz	59.4783	38.9338
410.000000 MHz	59.0235	39.0254
412.000000 MHz	59.4729	38.6724
414.000000 MHz	59.3680	38.5736
416.000000 MHz	59.1888	38.5110
418.000000 MHz	59.3705	38.2964
420.000000 MHz	59.0796	38.1765
422.000000 MHz	59.3379	38.3555
424.000000 MHz	58.8982	38.2870
426.000000 MHz	58.8211	38.0471
428.000000 MHz	59.0607	37.8863
430.000000 MHz	58.7131	37.8441
432.000000 MHz	58.7693	37.4237
434.000000 MHz	59.0654	37.4129
436.000000 MHz	58.5824	37.2644
438.000000 MHz	58.7868	37.2919
440.000000 MHz	58.8451	37.2801
442.000000 MHz	59.1451	37.0719
444.000000 MHz	58.7658	37.0153
446.000000 MHz	58.2361	37.0102
448.000000 MHz	58.6968	36.7044
450.000000 MHz	58.3909	36.8761
452.000000 MHz	58.3940	36.8679
454.000000 MHz	58.5438	36.5623
456.000000 MHz	58.6099	36.6742
458.000000 MHz	58.5912	36.3878
460.000000 MHz	58.0629	36.2686
462.000000 MHz	58.5028	36.2817
464.000000 MHz	58.1880	35.8776
466.000000 MHz	58.1740	35.9137
468.000000 MHz	57.9536	36.2349
470.000000 MHz	58.3377	35.7593
472.000000 MHz	58.1917	35.5670
474.000000 MHz	58.2285	35.5376
476.000000 MHz	58.1261	35.5388
478.000000 MHz	58.0118	35.2344
480.000000 MHz	58.1209	35.5702
482.000000 MHz	57.8459	35.7184
484.000000 MHz	58.0195	35.2451
486.000000 MHz	57.8149	35.2531
488.000000 MHz	58.0840	35.2980

450MHz Head

December 27, 2005 08:01 AM

Frequency	e'	e''
400.000000 MHz	47.3868	36.8140
402.000000 MHz	47.3035	37.0874
404.000000 MHz	47.1489	37.2241
406.000000 MHz	47.3408	36.6346
408.000000 MHz	47.3530	36.1705
410.000000 MHz	47.5287	36.6376
412.000000 MHz	46.8410	36.4076
414.000000 MHz	47.0737	36.1808
416.000000 MHz	47.2129	35.8891
418.000000 MHz	47.0489	35.7276
420.000000 MHz	47.0279	36.0861
422.000000 MHz	46.7671	35.8011
424.000000 MHz	47.0472	35.9104
426.000000 MHz	46.5729	35.3271
428.000000 MHz	46.5245	35.5480
430.000000 MHz	47.2855	35.2455
432.000000 MHz	46.4717	35.5096
434.000000 MHz	46.4584	35.5079
436.000000 MHz	46.7037	35.4259
438.000000 MHz	46.4249	35.2166
440.000000 MHz	46.5405	35.1761
442.000000 MHz	46.3036	34.9731
444.000000 MHz	46.4438	34.8535
446.000000 MHz	45.8891	34.8389
448.000000 MHz	46.3025	34.8272
450.000000 MHz	46.0481	34.4922
452.000000 MHz	46.0899	34.6919
454.000000 MHz	46.1863	34.5450
456.000000 MHz	46.4685	34.2934
458.000000 MHz	45.9989	34.4288
460.000000 MHz	45.9511	34.1980
462.000000 MHz	45.7316	34.2550
464.000000 MHz	45.8006	33.8430
466.000000 MHz	45.8235	34.1337
468.000000 MHz	45.7897	34.0870
470.000000 MHz	45.7808	34.2899
472.000000 MHz	45.4808	33.9462
474.000000 MHz	45.3679	33.9506
476.000000 MHz	45.3022	33.9115
478.000000 MHz	45.5136	33.7715
480.000000 MHz	45.3289	33.5056
482.000000 MHz	45.3159	33.4596
484.000000 MHz	45.2035	33.4488
486.000000 MHz	45.0906	33.2281
488.000000 MHz	44.9690	32.8538

450MHz Body

December 27, 2005 08:22 AM

Frequency	e'	e''
400.000000 MHz	59.6932	40.9911
402.000000 MHz	59.4960	40.8639
404.000000 MHz	59.5754	40.8978
406.000000 MHz	59.4909	41.0155
408.000000 MHz	59.3054	40.7096
410.000000 MHz	59.3802	40.3358
412.000000 MHz	59.4959	40.3950
414.000000 MHz	59.2951	40.4319
416.000000 MHz	59.3520	40.2945
418.000000 MHz	58.9512	39.6099
420.000000 MHz	59.3144	40.1959
422.000000 MHz	59.3246	39.5187
424.000000 MHz	58.8387	39.8299
426.000000 MHz	59.1268	39.5809
428.000000 MHz	59.0694	39.6341
430.000000 MHz	59.0494	39.5187
432.000000 MHz	58.9641	39.2774
434.000000 MHz	58.7498	39.1839
436.000000 MHz	58.9111	39.1741
438.000000 MHz	58.5928	39.0444
440.000000 MHz	59.0158	38.5387
442.000000 MHz	58.8550	38.5475
444.000000 MHz	58.6283	38.5605
446.000000 MHz	58.6486	37.8825
448.000000 MHz	59.0334	38.3122
450.000000 MHz	58.5927	38.4873
452.000000 MHz	58.5664	38.4214
454.000000 MHz	58.6868	37.9618
456.000000 MHz	58.6196	38.1545
458.000000 MHz	58.6931	37.5762
460.000000 MHz	58.5255	37.4693
462.000000 MHz	58.7512	37.7871
464.000000 MHz	58.6224	37.5502
466.000000 MHz	58.5382	37.3431
468.000000 MHz	58.4415	37.2057
470.000000 MHz	58.6135	37.3630
472.000000 MHz	58.3826	37.2006
474.000000 MHz	58.5446	37.3953
476.000000 MHz	58.6151	37.2598
478.000000 MHz	58.6058	37.1792
480.000000 MHz	58.1071	36.8619
482.000000 MHz	58.5070	36.9013
484.000000 MHz	57.8540	36.6866
486.000000 MHz	58.2504	36.8794
488.000000 MHz	57.7760	36.6373