

TABLE OF CONTENTS

<u>RULE</u>	<u>DESCRIPTION</u>	<u>PAGE</u>
	Test Report	1
2.1033(c)	General Information Required	2
2.1033(c)(14)	Rule Summary	5
	Standard Test Conditions and Engineering Practices	6
2.1046(a)	Carrier Output Power (Conducted)	7
2.1051	Unwanted Emissions (Transmitter Conducted)	9
2.1053(a)	Field Strength of Spurious Radiation	13
2.1049(c)(1)	Emission Masks (Occupied Bandwidth)	16
90.214	Transient Frequency Behavior	23
2.1047(a)	Audio Low Pass Filter (Voice Input)	29
2.1047(a)	Audio Frequency Response	32
2.1047(b)	Modulation Limiting	34
2.1055(a)(1)	Frequency Stability (Temperature Variation)	37
2.1055(b)(1)	Frequency Stability (Voltage Variation)	40
2.202(g)	Necessary Bandwidth and Emission Bandwidth	41

PAGE NO.

1 of 41.

Required information per ISO/IEC Guide 25-1990, paragraph 13.2:

- a) TEST REPORT
- b) Laboratory: M. Flom Associates, Inc.  
 (FCC: 31040/SIT) 3356 N. San Marcos Place, Suite 107  
 (Canada: IC 2044) Chandler, AZ 85224
- c) Report Number: d9980027
- d) Client: Kenwood Communications Corporation  
 P.O. Box 22745  
 Long Beach, CA 90801-5745
- e) Identification: TKR-840-2  
 Description: FCC ID: ALH30643120  
 UHF FM Repeater
- f) EUT Condition: Not required unless specified in individual tests.
- g) Report Date: August 20, 1999  
 EUT Received: August 12, 1999
- h, j, k): As indicated in individual tests.
- i) Sampling method: No sampling procedure used.
- l) Uncertainty: In accordance with MFA internal quality manual.
- m) Supervised by:
-   
 William H. Graff, Director  
 of Engineering
- n) Results: The results presented in this report relate only to the item tested.
- o) Reproduction: This report must not be reproduced, except in full, without written permission from this laboratory.

PAGE NO.

2 of 41.

LIST OF GENERAL INFORMATION REQUIRED FOR CERTIFICATIONIN ACCORDANCE WITH FCC RULES AND REGULATIONS,  
VOLUME II, PART 2 AND TO

90

Sub-part 2.1033(c) (1): NAME AND ADDRESS OF APPLICANT:Kenwood Communications Corporation  
2201 E. Dominguez St  
P.O. Box 22745  
Long Beach, CA 90801-5745MANUFACTURER:Kenwood Corporation  
14-6, Dogenzaka 1-Chome  
Shibuya-ku, Tokyo(c) (2): FCC ID: ALH30643120MODEL NO: TKR-840-2(c) (3): INSTRUCTION MANUAL(S):

PLEASE SEE ATTACHED EXHIBITS

(c) (4): TYPE OF EMISSION: 16K0F3E, 11K0F3E(c) (5): FREQUENCY RANGE, MHz: 480 to 512(c) (6): POWER RATING, Watts: 0.1 to 5  
x Switchable \_\_\_ Variable \_\_\_ N/A(c) (7): MAXIMUM POWER RATING, Watts: 300W

M. Flom Associates, Inc. is accredited by the American Association for Laboratory Accreditation (A2LA) as shown in the scope below.



**THE AMERICAN ASSOCIATION FOR LABORATORY ACCREDITATION**

**ACCREDITED LABORATORY**

A2LA has accredited

**M. FLOM ASSOCIATES, INC.**  
Chandler, AZ

for technical competence in the field of

**Electrical (EMC) Testing**

The accreditation covers the specific tests and types of tests listed on the agreed scope of accreditation. This laboratory meets the requirements of ISOMET Guide 25-1990 "General Requirements for the Competence of Calibration and Testing Laboratories" (equivalent to relevant requirements of the ISO 9000 series of standards) and any additional program requirements in the identified field of testing.

Presented this 24<sup>th</sup> day of November, 1998.



*Peter Almy*  
President  
For the Accreditation Council  
Certificate Number 1008-01  
Valid to December 31, 2000

For tests or types of tests to which this accreditation applies, please refer to the laboratory's Electrical (EMC) Scope of Accreditation



**American Association for Laboratory Accreditation**

**SCOPE OF ACCREDITATION TO ISOMET GUIDE 25-1990 AND EN 45001**

**M. FLOM ASSOCIATES, INC.**  
Electronics Testing Laboratory  
3356 North Rio Salado Place, Suite 107  
Chandler, AZ 85224-1371  
Mesa, AZ Phone: 480 936 3100

**ELECTRICAL (EMC)**

Valid to: December 31, 2000 Certificate Number: 1008-01

In recognition of the successful completion of the A2LA evaluation process, accreditation is granted to this laboratory to perform the following (instrumental) measurement tests:

Tests	Standards
RF Immunity	ISOMET 3546, ARNEX 4251.1
RF Intensity	EN 50062-1, EN 50062-2, ARNEX 4251.1
Reflected Susceptibility	EN 61000-4-5, EN 50148, EN 50149, EN 50304, IEC 1000-4-5, IEC 801-2
ESD	EN 61000-4-2, IEC 1000-4-2, IEC 801-2
EMF	EN 61000-4-6, IEC 1000-4-6, IEC 801-4
Surge	EN 61000-4-5, EN 50142, IEC 1000-4-5, IEC 801-5
CFR (FCC)	2, 21, 22, 23, 24, 24, 26, 27, 28, 29, 30

*Peter Almy*

ESR Electronics Plus, Suite 200 • Frederick, MD 21704-6297 • Phone 301 664 2200 • Fax 301 662 2204

"This laboratory is accredited by the American Association for Laboratory Accreditation (A2LA) and the results shown in this report have been determined in accordance with the laboratory's terms of accreditation unless stated otherwise in the report."

Should this report contain any data for tests for which we are not accredited, or which have been undertaken by a subcontractor that is not A2LA accredited, such data would not covered by this laboratory's A2LA accreditation.

PAGE NO.

4 of 41.

Subpart 2.1033 (continued)

(c) (8): VOLTAGES & CURRENTS IN ALL ELEMENTS IN FINAL R. F. STAGE, INCLUDING FINAL TRANSISTOR OR SOLID STATE DEVICE:

COLLECTOR CURRENT, A = per manual  
 COLLECTOR VOLTAGE, Vdc = per manual  
 SUPPLY VOLTAGE, Vdc = 13.8

(c) (9): TUNE-UP PROCEDURE:

PLEASE SEE ATTACHED EXHIBITS

(c) (10): CIRCUIT DIAGRAM/CIRCUIT DESCRIPTION:  
 Including description of circuitry & devices provided for determining and stabilizing frequency, for suppression of spurious radiation, for limiting modulation and limiting power.

PLEASE SEE ATTACHED EXHIBITS

(c) (11): LABEL INFORMATION:

PLEASE SEE ATTACHED EXHIBITS

(c) (12): PHOTOGRAPHS:

PLEASE SEE ATTACHED EXHIBITS

(c) (13): DIGITAL MODULATION DESCRIPTION:

     ATTACHED EXHIBITS  
  X   N/A

(c) (14): TEST AND MEASUREMENT DATA:

FOLLOWS

PAGE NO.

5 of 41.

Sub-part  
2.1033(c) (14):TEST AND MEASUREMENT DATA

All tests and measurement data shown were performed in accordance with FCC Rules and Regulations, Volume II; Part 2, Sub-part J, Sections 2.947, 2.1033(c), 2.1041, 2.1046, 2.1047, 2.1079, 2.1051, 2.1053, 2.1055, 2.1057 and the following individual Parts:

- \_\_\_ 21 - Domestic Public Fixed Radio Services
- \_\_\_ 22 - Public Mobile Services
- \_\_\_ 22 Subpart H - Cellular Radiotelephone Service
- \_\_\_ 22.901(d) - Alternative technologies and auxiliary services
- \_\_\_ 23 - International Fixed Public Radiocommunication services
- \_\_\_ 24 - Personal Communications Services
- \_\_\_ 74 Subpart H - Low Power Auxiliary Stations
- \_\_\_ 80 - Stations in the Maritime Services
- \_\_\_ 80 Subpart E - General Technical Standards
- \_\_\_ 80 Subpart F - Equipment Authorization for Compulsory Ships
- \_\_\_ 80 Subpart K - Private Coast Stations and Marine Utility Stations
- \_\_\_ 80 Subpart S - Compulsory Radiotelephone Installations for Small Passenger Boats
- \_\_\_ 80 Subpart T - Radiotelephone Installation Required for Vessels on the Great Lakes
- \_\_\_ 80 Subpart U - Radiotelephone Installations Required by the Bridge-to-Bridge Act
- \_\_\_ 80 Subpart V - Emergency Position Indicating Radiobeacons (EPIRB'S)
- \_\_\_ 80 Subpart W - Global Maritime Distress and Safety System (GMDSS)
- \_\_\_ 80 Subpart X - Voluntary Radio Installations
- \_\_\_ 87 - Aviation Services
- x 90 - Private Land Mobile Radio Services
- \_\_\_ 94 - Private Operational-Fixed Microwave Service
- \_\_\_ 95 Subpart A - General Mobile Radio Service (GMRS)
- \_\_\_ 95 Subpart C - Radio Control (R/C) Radio Service
- \_\_\_ 95 Subpart D - Citizens Band (CB) Radio Service
- \_\_\_ 95 Subpart E - Family Radio Service
- \_\_\_ 95 Subpart F - Interactive Video and Data Service (IVDS)
- \_\_\_ 101 - Fixed Microwave Services

PAGE NO.

6 of 41.

STANDARD TEST CONDITIONS  
and  
ENGINEERING PRACTICES

Except as noted herein, the following conditions and procedures were observed during the testing:

In accordance with ANSI C63.4-1992, section 6.1.9, and unless otherwise indicated in the specific measurement results, the ambient temperature of the actual EUT was maintained within the range of 10° to 40°C (50° to 104 °F) unless the particular equipment requirements specify testing over a different temperature range. Also, unless otherwise indicated, the humidity levels were in the range of 10% to 90% relative humidity.

Prior to testing, the EUT was tuned up in accordance with the manufacturer's alignment procedures. All external gain controls were maintained at the position of maximum and/or optimum gain throughout the testing.

Measurement results, unless otherwise noted, are worst case measurements.

PAGE NO. 7 of 41.  
NAME OF TEST: Carrier Output Power (Conducted)  
SPECIFICATION: 47 CFR 2.1046(a)  
GUIDE: ANSI/TIA/EIA-603-1992, Paragraph 2.2.1  
TEST EQUIPMENT: As per attached page

MEASUREMENT PROCEDURE

1. The EUT was connected to a resistive coaxial attenuator of normal load impedance, and the unmodulated output power was measured by means of an R. F. Power Meter.
2. Measurement accuracy is  $\pm 3\%$ .

MEASUREMENT RESULTS  
(Worst case)

FREQUENCY OF CARRIER, MHz = 496, 480, 512

<u>POWER SETTING</u>	<u>R. F. POWER, WATTS</u>
Low	0.1
High	5

SUPERVISED BY:

  
William H. Graff, Director  
of Engineering



TRANSMITTER POWER CONDUCTED MEASUREMENTS

TEST 1: R. F. POWER OUTPUT  
 TEST 2: FREQUENCY STABILITY

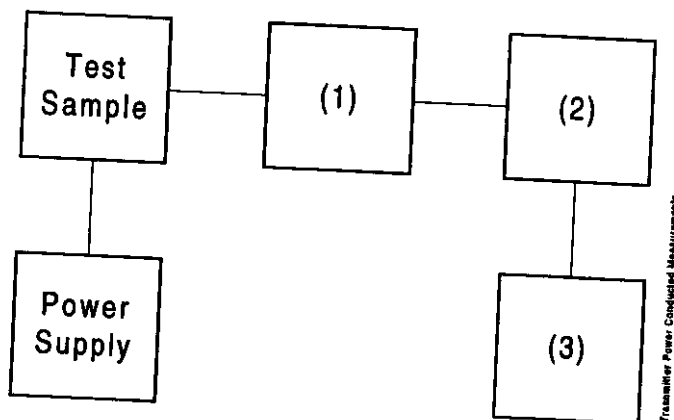

Asset	Description	s/n
<u>(1) COAXIAL ATTENUATOR</u>		
___	i00122 Narda 766-10	7802
___	i00123 Narda 766-10	7802A
___	i00069 Bird 8329 (30 dB)	1006
<u>x</u>	i00113 Sierra 661A-3D	1059
<u>(2) POWER METERS</u>		
___	i00014 HP 435A	1733A05836
<u>x</u>	i00039 HP 436A	2709A26776
<u>x</u>	i00020 HP 8901A POWER MODE	2105A01087
<u>(3) FREQUENCY COUNTER</u>		
___	i00042 HP 5383A	1628A00959
<u>x</u>	i00019 HP 5334B	2704A00347
<u>x</u>	i00020 HP 8901A FREQUENCY MODE	2105A01087

PAGE NO. 9 of 41.

NAME OF TEST: Unwanted Emissions (Transmitter Conducted)

SPECIFICATION: 47 CFR 2.1051

GUIDE: ANSI/TIA/EIA-603-1992, Paragraph 2.2.13

TEST EQUIPMENT: As per attached page

MEASUREMENT PROCEDURE

1. The emissions were measured for the worst case as follows:
  - (a): within a band of frequencies defined by the carrier frequency plus and minus one channel.
  - (b): from the lowest frequency generated in the EUT and to at least the 10th harmonic of the carrier frequency, or 40 GHz, whichever is lower.
2. The magnitude of spurious emissions that are attenuated more than 20 dB below the permissible value need not be specified.

3. MEASUREMENT RESULTS: ATTACHED FOR WORST CASE

FREQUENCY OF CARRIER, MHz	=	496, 480, 512
SPECTRUM SEARCHED, GHz	=	0 to 10 x F <sub>c</sub>
MAXIMUM RESPONSE, Hz	=	2510
ALL OTHER EMISSIONS	=	≥ 20 dB BELOW LIMIT
LIMIT(S), dBc		
	- (50+10xLOG P)	= -57 (5 Watts)
	- (50+10xLOG P)	= -50 (1 Watt)

SUPERVISED BY:

  
 William H. Graff, Director  
 of Engineering

TRANSMITTER SPURIOUS EMISSION

TEST A. OCCUPIED BANDWIDTH (IN-BAND SPURIOUS)  
 TEST B. OUT-OF-BAND SPURIOUS

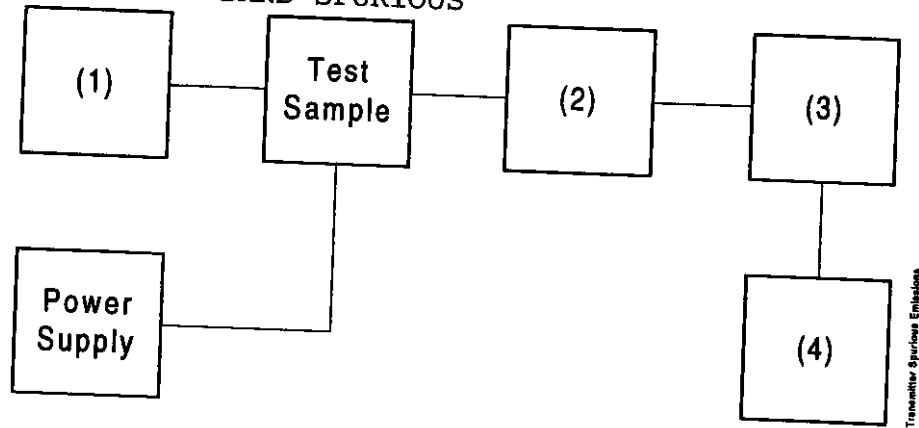

Asset	Description	s/n
<u>(1) AUDIO OSCILLATOR/GENERATOR</u>		
___	i00010 HP 204D	1105A04683
___	i00017 HP 8903A	2216A01753
<u>x</u>	i00012 HP 3312A	1432A11250
<u>(2) COAXIAL ATTENUATOR</u>		
___	i00122 Narda 766-10	7802
___	i00123 Narda 766-10	7802A
<u>x</u>	i00069 Bird 8329 (30 dB)	1006
<u>x</u>	i00113 Sierra 661A-3D	1059
<u>(3) FILTERS; NOTCH, HP, LP, BP</u>		
<u>x</u>	i00126 Eagle TNF-1	100-250
<u>x</u>	i00125 Eagle TNF-1	50-60
<u>x</u>	i00124 Eagle TNF-1	250-850
<u>(4) SPECTRUM ANALYZER</u>		
<u>x</u>	i00048 HP 8566B	2511A01467
___	i00029 HP 8563E	3213A00104

PAGE NO.

11 of 41.

NAME OF TEST: Unwanted Emissions (Transmitter Conducted)  
 g9980083: 1999-Aug-19 Thu 14:01:00  
 STATE: 2:Low Power

FREQUENCY TUNED, MHz	FREQUENCY EMISSION, MHz	LEVEL, dBm	LEVEL, dBc	MARGIN, dB
480.000000	960.005000	-51.2	-81.2	-31.2
496.000000	991.597000	-54.6	-84.6	-34.6
512.000000	1023.997000	-52.8	-82.8	-32.8
480.000000	1440.014000	-51	-81	-31
496.000000	1488.002000	-52.5	-82.5	-32.5
512.000000	1536.009000	-52.6	-82.6	-32.6
480.000000	1920.016000	-52.3	-82.3	-32.3
496.000000	1983.854000	-52.2	-82.2	-32.2
512.000000	2048.456000	-52.5	-82.5	-32.5
480.000000	2399.979000	-52.1	-82.1	-32.1
496.000000	2479.645000	-52.7	-82.7	-32.7
512.000000	2560.400000	-54.2	-84.2	-34.2
480.000000	2879.913000	-55.2	-85.2	-35.2
496.000000	2976.101000	-54.4	-84.4	-34.4
512.000000	3072.325000	-54.9	-84.9	-34.9
480.000000	3359.654000	-54.4	-84.4	-34.4
496.000000	3472.463000	-54.6	-84.6	-34.6
512.000000	3583.599000	-55.1	-85.1	-35.1
480.000000	3839.983000	-55.2	-85.2	-35.2
496.000000	3968.321000	-54.4	-84.4	-34.4
512.000000	4095.783000	-52.9	-82.9	-32.9
480.000000	4320.277000	-55	-85	-35
496.000000	4463.895000	-55.3	-85.3	-35.3
512.000000	4607.707000	-54.2	-84.2	-34.2
480.000000	4799.972000	-54.3	-84.3	-34.3
496.000000	4959.881000	-54.5	-84.5	-34.5
512.000000	5119.983000	-55.3	-85.3	-35.3
480.000000	5280.338000	-54.4	-84.4	-34.4
496.000000	5456.161000	-54.6	-84.6	-34.6
512.000000	5632.151000	-53.8	-83.8	-33.8
480.000000	5759.769000	-54.1	-84.1	-34.1
496.000000	5951.867000	-49.7	-79.7	-29.7
512.000000	6143.886000	-49.8	-79.8	-29.8
480.000000	6240.366000	-48.8	-78.8	-28.8
496.000000	6448.007000	-49.3	-79.3	-29.3
512.000000	6656.340000	-49.5	-79.5	-29.5
480.000000	6719.890000	-49.3	-79.3	-29.3
496.000000	6944.025000	-48.1	-78.1	-28.1
512.000000	7167.969000	-49.7	-79.7	-29.7
480.000000	7199.966000	-49.4	-79.4	-29.4
496.000000	7439.804000	-49.1	-79.1	-29.1
512.000000	7680.156000	-48.8	-78.8	-28.8

PAGE NO.

12 of 41.

NAME OF TEST: Unwanted Emissions (Transmitter Conducted)  
 g9980082: 1999-Aug-19 Thu 13:49:00  
 STATE: 2:High Power

FREQUENCY TUNED, MHz	FREQUENCY EMISSION, MHz	LEVEL, dBm	LEVEL, dBc	MARGIN, dB
480.000000	960.105000	-43.3	-80.2	-23.3
496.000000	992.321000	-43.2	-80.1	-23.2
512.000000	1023.501000	-43.8	-80.7	-23.8
480.000000	1440.073000	-43.7	-80.6	-23.7
496.000000	1487.806000	-43.8	-80.7	-23.8
512.000000	1535.998000	-41.3	-78.2	-21.3
480.000000	1919.720000	-42.8	-79.7	-22.8
496.000000	1983.997000	-42.4	-79.3	-22.4
512.000000	2047.772000	-42.9	-79.8	-22.9
480.000000	2400.055000	-43	-79.9	-23
496.000000	2480.384000	-41.6	-78.5	-21.6
512.000000	2560.394000	-44.7	-81.6	-24.7
480.000000	2880.224000	-44.3	-81.2	-24.3
496.000000	2976.041000	-45.7	-82.6	-25.7
512.000000	3072.086000	-45.2	-82.1	-25.2
480.000000	3359.661000	-44.1	-81	-24.1
496.000000	3472.496000	-42.5	-79.4	-22.5
512.000000	3584.203000	-45.3	-82.2	-25.3
480.000000	3840.156000	-44.4	-81.3	-24.4
496.000000	3968.103000	-45.2	-82.1	-25.2
512.000000	4096.295000	-45.6	-82.5	-25.6
480.000000	4319.940000	-45.1	-82	-25.1
496.000000	4464.062000	-44.4	-81.3	-24.4
512.000000	4607.704000	-45.2	-82.1	-25.2
480.000000	4799.630000	-44.7	-81.6	-24.7
496.000000	4959.820000	-43.9	-80.8	-23.9
512.000000	5120.198000	-45.4	-82.3	-25.4
480.000000	5280.453000	-44.9	-81.8	-24.9
496.000000	5456.278000	-44.8	-81.7	-24.8
512.000000	5632.451000	-45.5	-82.4	-25.5
480.000000	5759.736000	-44.3	-81.2	-24.3
496.000000	5952.270000	-39.4	-76.3	-19.4
512.000000	6143.794000	-39.6	-76.5	-19.6
480.000000	6239.693000	-37.9	-74.8	-17.9
496.000000	6447.616000	-39.3	-76.2	-19.3
512.000000	6656.498000	-39.1	-76	-19.1
480.000000	6720.238000	-39.3	-76.2	-19.3
496.000000	6944.271000	-38.5	-75.4	-18.5
512.000000	7167.538000	-40	-76.9	-20
480.000000	7199.677000	-38.8	-75.7	-18.8
496.000000	7440.454000	-39.3	-76.2	-19.3
512.000000	7680.462000	-39.1	-76	-19.1

PAGE NO. 13 of 41.  
NAME OF TEST: Field Strength of Spurious Radiation  
SPECIFICATION: 47 CFR 2.1053(a)  
GUIDE: ANSI/TIA/EIA-603-1992, Paragraph 2.2.12  
TEST EQUIPMENT: As per attached page

MEASUREMENT PROCEDURE

1. A description of the measurement facilities was filed with the FCC and was found to be in compliance with the requirements of Section 2.948, by letter from the FCC dated March 3, 1997, FILE 31040/SIT. All pertinent changes will be reported to the Commission by up-date prior to March 2000.
2. At first, in order to locate all spurious frequencies and approximate amplitudes, and to determine proper equipment functioning, the test sample was set up at a distance of three meters from the test instrument. Valid spurious signals were determined by switching the power on and off.
3. In the field, the test sample was placed on a wooden turntable above ground at three (or thirty) meters away from the search antenna. Excess power leads were coiled near the power supply.  
 The cables were oriented in order to obtain the maximum response. At each emission frequency, the turntable was rotated and the search antennas were raised and lowered vertically.
4. The emission was observed with both a vertically polarized and a horizontally polarized search antenna and the worst case was used.
6. The field strength of each emission within 20 dB of the limit was recorded and corrected with the appropriate cable and transducer factors.
7. The worst case for all channels is shown.
8. Measurement results: ATTACHED FOR WORST CASE

RADIATED TEST SETUP

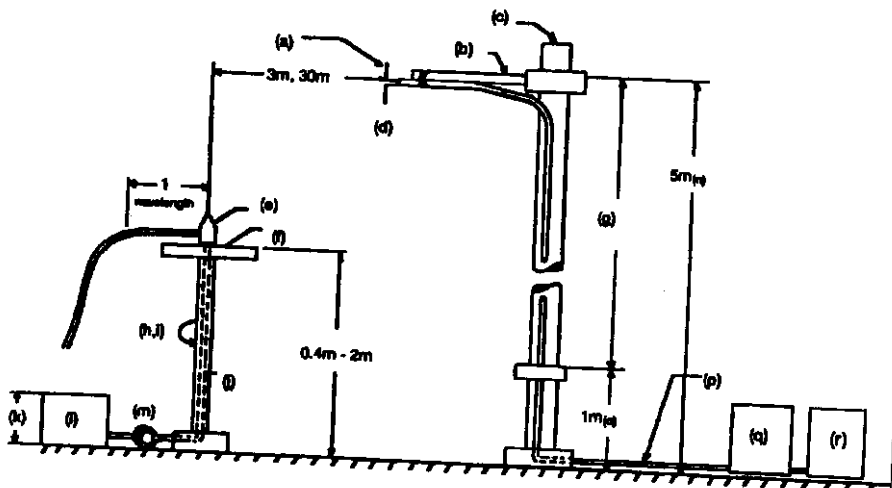

NOTES:

- (a) Search Antenna - Rotatable on boom
- (b) Non-metallic boom
- (c) Non-metallic mast
- (d) Adjustable horizontally
- (e) Equipment Under Test
- (f) Turntable
- (g) Boom adjustable in height.
- (h) External control cables routed horizontally at least one wavelength.
- (i) Rotatable
- (j) Cables routed through hollow turntable center
- (k) 30 cm or less
- (l) External power source
- (m) 10 cm diameter coil of excess cable
- (n) 25 cm (V), 1 m-7 m (V, H)
- (o) 25 cm from bottom end of 'V', 1m normally
- (p) Calibrated Cable at least 10m in length
- (q) Amplifier (optional)
- (r) Spectrum Analyzer

Asset	Description	s/n	Cycle	Last Cal
<u>TRANSDUCER</u>				
___	i00065 EMCO 3109B 100Hz-50MHz	2336		
___	i00033 Singer 94593-1 10kHz-32MHz	0219	12 mo.	
x	i00088 EMCO 3109-B 25MHz-300MHz	2336	12 mo.	
x	i00089 Aprel 2001 200MHz-1GHz	001500	12 mo.	Oct-98
x	i00103 EMCO 3115 1GHz-18GHz	9208-3925	12 mo.	Oct-98
___	i00085 EMCO 3116 10GHZ-40GHZ	2076	12 mo.	
<u>AMPLIFIER</u>				
___	i00028 HP 8449A	2749A00121	12 mo.	Mar-99
<u>SPECTRUM ANALYZER</u>				
___	i00029 HP 8563E			
x	i00033 HP 85462A	3213A00104	12 mo.	Aug-98
___	i00048 HP 8566B	3625A00357	12 mo.	Dec-98
		2511AD1467	6 mo.	Dec-98

PAGE NO. 15 of 41.

NAME OF TEST: Field Strength of Spurious Radiation

ALL OTHER EMISSIONS =  $\geq 20$  dB BELOW LIMIT

EMISSION, MHz/HARMONIC	SPURIOUS LEVEL, dBc	
	Low	High
2nd to 10th	<-75	<-70

SUPERVISED BY:

  
William H. Graff, Director  
of Engineering



PAGE NO. 16 of 41.  
NAME OF TEST: Emission Masks (Occupied Bandwidth)  
SPECIFICATION: 47 CFR 2.1049(c)(1)  
GUIDE: ANSI/TIA/EIA-603-1992, Paragraph 2.2.11  
TEST EQUIPMENT: As per previous page

MEASUREMENT PROCEDURE

1. The EUT and test equipment were set up as shown on the following page, with the Spectrum Analyzer connected.
2. For EUTs supporting audio modulation, the audio signal generator was adjusted to the frequency of maximum response and with output level set for  $\pm 2.5$  kHz deviation (or 50% modulation). With level constant, the signal level was increased 16 dB.
3. For EUTs supporting digital modulation, the digital modulation mode was operated to its maximum extent.
4. The Occupied Bandwidth was measured with the Spectrum Analyzer controls set as shown on the test results.
5. MEASUREMENT RESULTS: ATTACHED

PAGE NO.

17 of 41.

NAME OF TEST: Emission Masks (Occupied Bandwidth)  
g9980077: 1999-Aug-19 Thu 12:47:00  
STATE: 1:Low Power

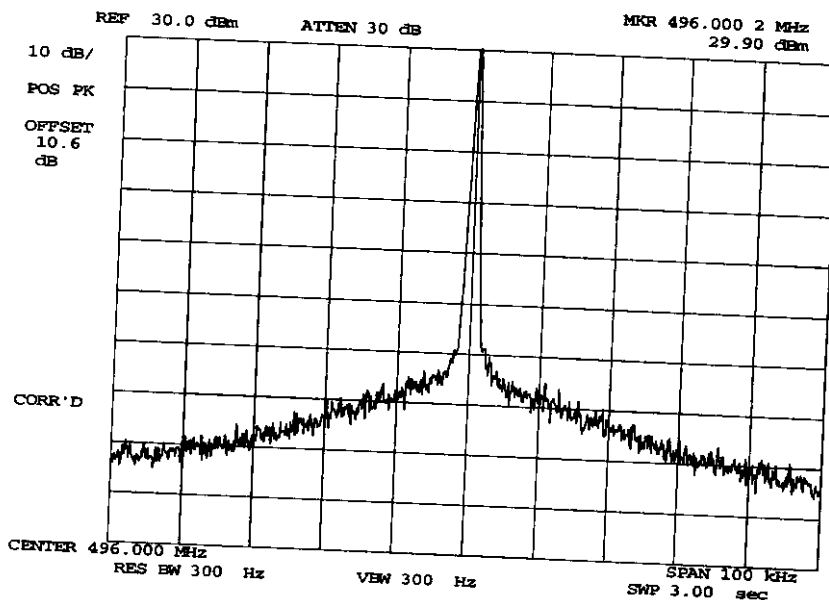

POWER:  
MODULATION:

LOW  
NONE

SUPERVISED BY:

William H. Graff, Director  
of Engineering

PAGE NO.

18 of 41.

NAME OF TEST: Emission Masks (Occupied Bandwidth)  
g9980079: 1999-Aug-19 Thu 12:51:00  
STATE: 1:Low Power

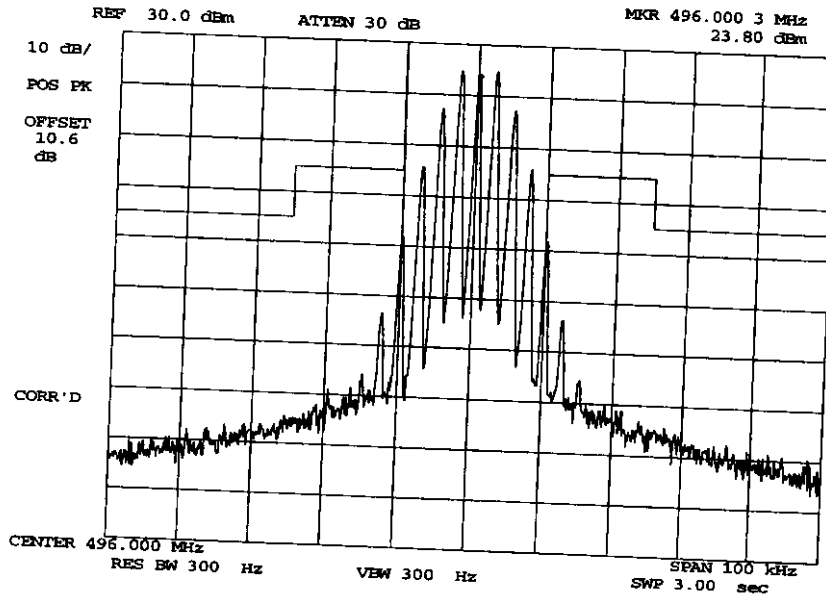

POWER:  
MODULATION:

LOW  
VOICE: 2500 Hz SINE WAVE  
MASK: B, VHF/UHF 25kHz,  
w/LPF

SUPERVISED BY:

*William H. Graff*  
William H. Graff, Director  
of Engineering

PAGE NO.

19 of 41.

NAME OF TEST: Emission Masks (Occupied Bandwidth)  
g9980081: 1999-Aug-19 Thu 12:57:00  
STATE: 1:Low Power

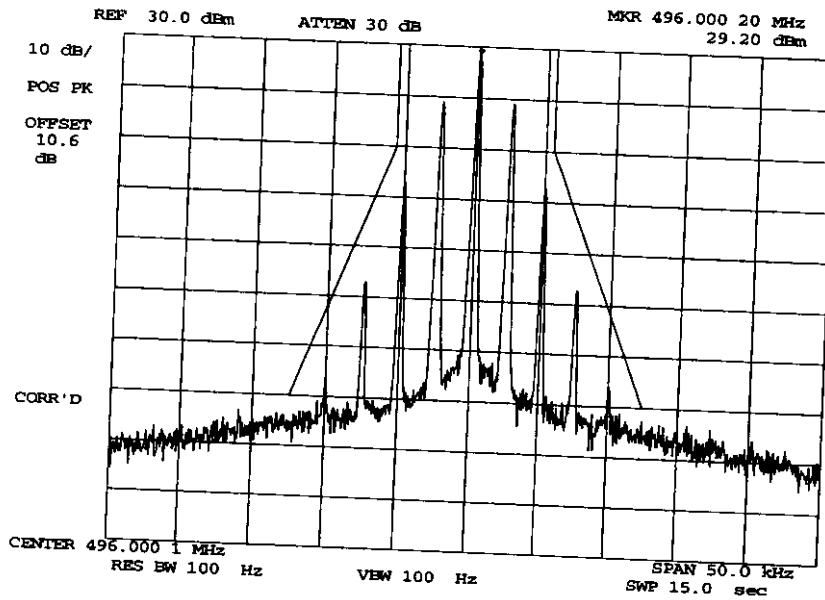

POWER:  
MODULATION:

LOW  
VOICE: 2500 Hz SINE WAVE  
MASK: D, VHF/UHF 12.5kHz BW

SUPERVISED BY:

*William H. Graff*  
William H. Graff, Director  
of Engineering

PAGE NO.

20 of 41.

NAME OF TEST: Emission Masks (Occupied Bandwidth)  
g9980076: 1999-Aug-19 Thu 12:46:00  
STATE: 2:High Power

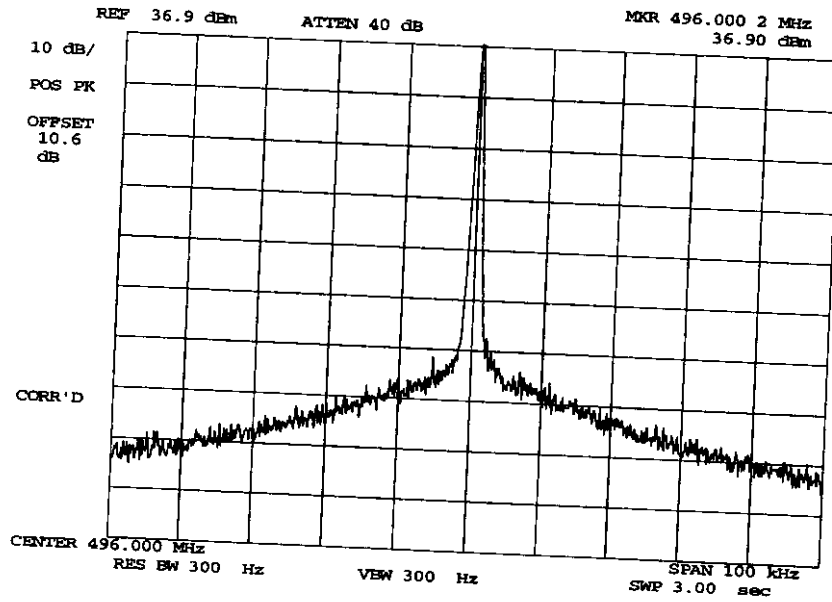

POWER:  
MODULATION:

HIGH  
NONE

SUPERVISED BY:

*William H. Graff*  
William H. Graff, Director  
of Engineering

PAGE NO.

21 of 41.

NAME OF TEST: Emission Masks (Occupied Bandwidth)  
g9980078: 1999-Aug-19 Thu 12:50:00  
STATE: 2:High Power

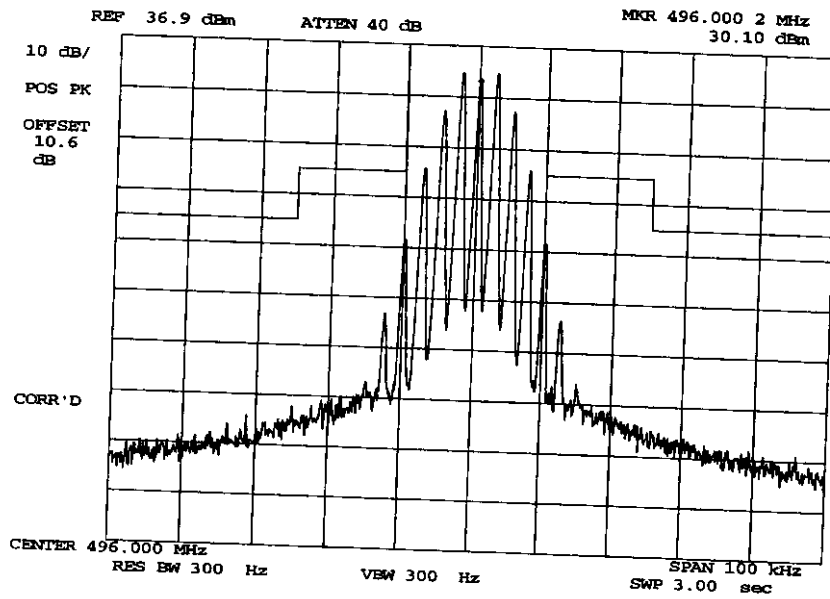

POWER:  
MODULATION:

HIGH  
VOICE: 2500 Hz SINE WAVE  
MASK: B, VHF/UHF 25kHz,  
w/LPF

SUPERVISED BY:

*William H. Graff*  
William H. Graff, Director  
of Engineering

PAGE NO.

22 of 41.

NAME OF TEST: Emission Masks (Occupied Bandwidth)  
g9980080: 1999-Aug-19 Thu 12:55:00  
STATE: 2:High Power

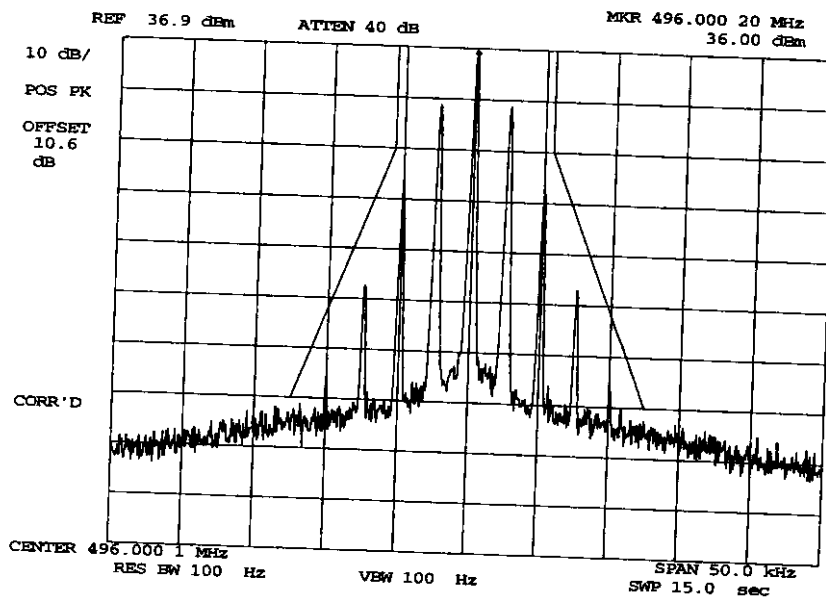

POWER:  
MODULATION:

HIGH  
VOICE: 2500 Hz SINE WAVE  
MASK: D, VHF/UHF 12.5kHz BW

SUPERVISED BY:

*William H. Graff*  
William H. Graff, Director  
of Engineering

PAGE NO. 23 of 41.  
NAME OF TEST: Transient Frequency Behavior  
SPECIFICATION: 47 CFR 90.214  
GUIDE: ANSI/TIA/EIA-603-1992, Paragraph 2.2.19  
TEST EQUIPMENT: As per attached page

MEASUREMENT PROCEDURE

1. The EUT was setup as shown on the attached page, following TIA/EIA-603 steps a, b, and c as a guide.
2. The transmitter was turned on.
3. Sufficient attenuation was provided so that the transmitter carrier level measured at the output of the combiner was 40 dB below the maximum input level of the test receiver. This level was recorded as step f.
4. The transmitter was turned off.
5. An RF signal generator (1) modulated with a 1 kHz tone at either 25, 12.5, or 6.25 kHz deviation, and set to the same frequency as the assigned transmitter frequency, (2) was adjusted to a level -20 dB below the level recorded for step f, as measured at the output of the combiner. This level was then fixed for the remainder of the test and is recorded at step h.
6. The oscilloscope was setup using TIA/EIA-603 steps j and k as a guide, and to either 10 ms/div (UHF) or 5 ms/div (VHF).
7. The 30 dB attenuator was removed, the transmitter was turned on, and the level of the carrier at the output of the combiner was recorded as step l.
8. The carrier on-time as referenced in TIA/EIA-603 steps m, n, and o was captured and plotted. The carrier off-time as referenced in TIA/EIA-603 steps p, q, r, and s was captured and plotted.

LEVELS MEASURED:

step f, dBm	= -14.5
step h, dBm	= -32.9
step l, dBm	= 16.5

SUPERVISED BY:

  
 William H. Graff, Director  
 of Engineering



TRANSIENT FREQUENCY BEHAVIOR

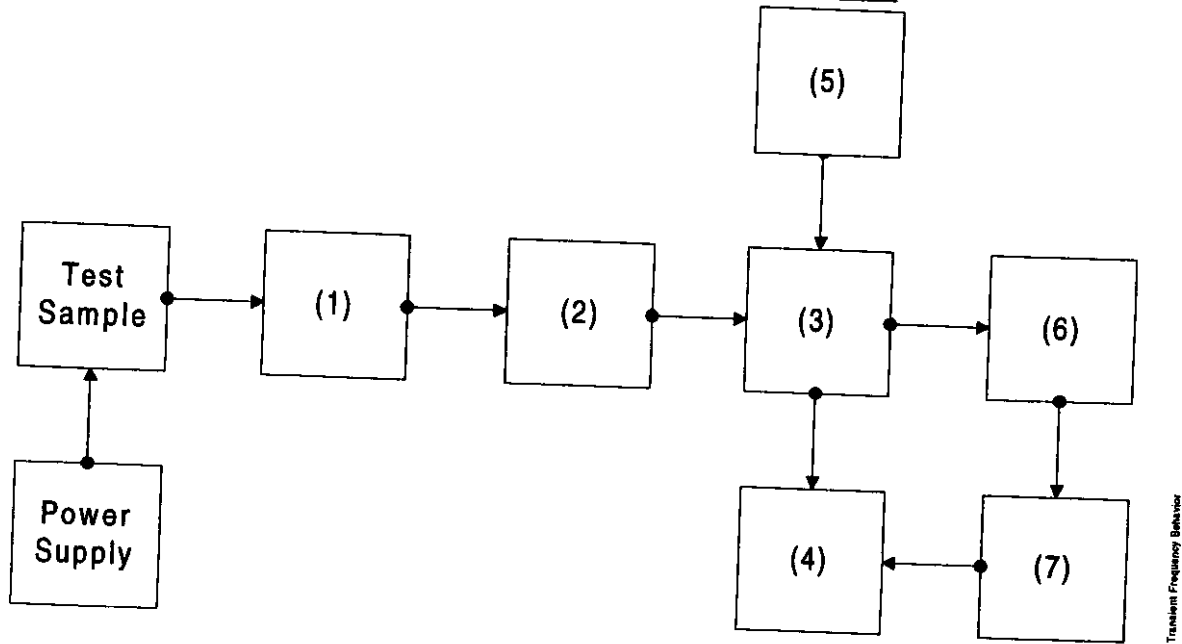

Asset	Description	s/n
(1)	<u>ATTENUATOR</u> (Removed after 1st step)	
x	i00112 Philco 30 dB	989
(2)	<u>ATTENUATOR</u>	
—	i00112 Philco 30 dB	989
—	i00172 Bird 30 dB	989
x	i00122 Narda 10 dB	7802
—	i00123 Narda 10 dB	7802A
—	i00110 Kay Variable	145-387
(3)	<u>COMBINER</u>	
x	i00154 4 x 25 Ω COMBINER	154
(4)	<u>CRYSTAL DETECTOR</u>	
x	i00159 HP 8470B	1822A10054
(5)	<u>RF SIGNAL GENERATOR</u>	
—	i00018 HP 8656A	2228A03472
—	i00031 HP 8656A	2402A06180
x	i00067 HP 8920A	3345U01242
(6)	<u>MODULATION ANALYZER</u>	
x	i00020 HP 8901A	2105A01087
(7)	<u>SCOPE</u>	
x	i00030 HP 54502A	2927A00209

PAGE NO.

25 of 41.

NAME OF TEST: Transient Frequency Behavior  
g9980072: 1999-Aug-19 Thu 12:30:00  
STATE: 2:High Power

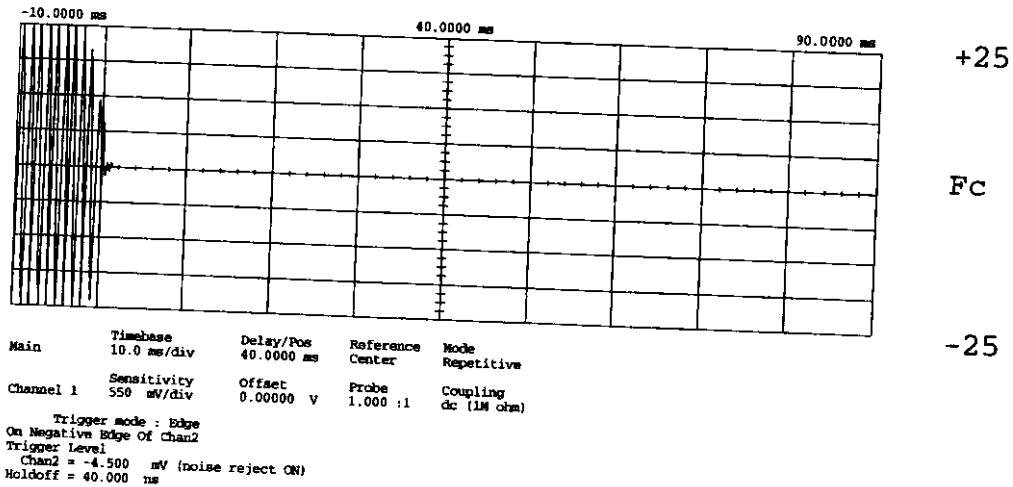

POWER:  
MODULATION:  
DESCRIPTION:

HIGH  
Ref Gen=25 kHz Deviation  
CARRIER ON TIME

SUPERVISED BY:

*William H. Graff*  
William H. Graff, Director  
of Engineering

PAGE NO.

26 of 41.

NAME OF TEST: Transient Frequency Behavior  
g9980073: 1999-Aug-19 Thu 12:31:00  
STATE: 2:High Power

0

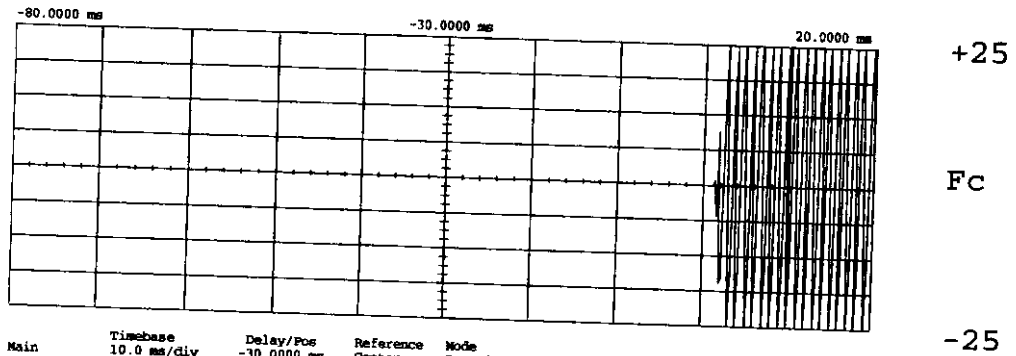

Main	Timebase 10.0 ms/div	Delay/Pos -30.0000 ms	Reference Center	Mode Repetitive
Channel 1	Sensitivity 550 mV/div	Offset 0.00000 v	Probe 1.000 :1	Coupling dc (1M ohm)

Trigger mode : Edge  
On Positive Edge Of Chan2  
Trigger Level  
Chan2 = -1.78750 V (noise reject ON)  
Holdoff = 40.000 ns

POWER:  
MODULATION:  
DESCRIPTION:

HIGH  
Ref Gen=25 kHz Deviation  
CARRIER OFF TIME

SUPERVISED BY:

*William H. Graff*  
William H. Graff, Director  
of Engineering

PAGE NO.

27 of 41.

NAME OF TEST: Transient Frequency Behavior  
 g9980074: 1999-Aug-19 Thu 12:36:00  
 STATE: 2:High Power

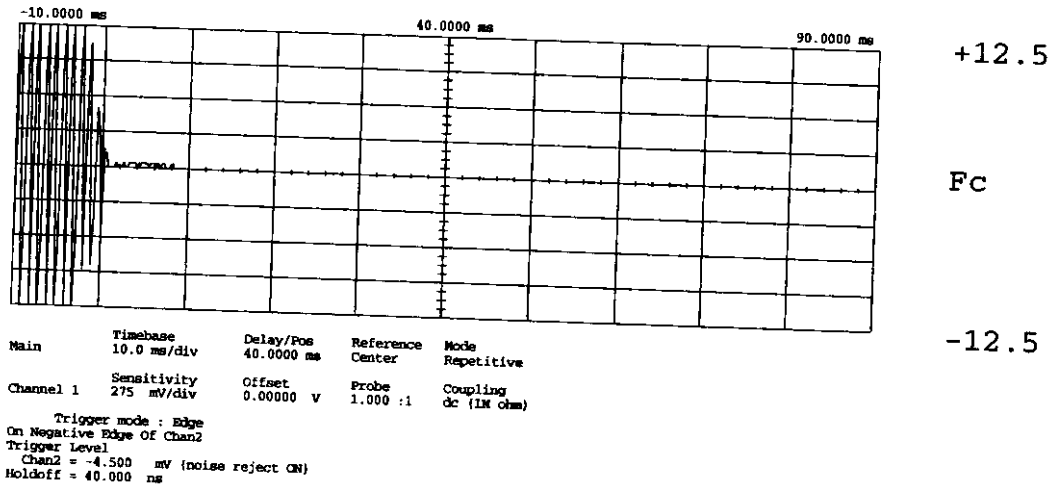

POWER:  
 MODULATION:  
 DESCRIPTION:

HIGH  
 Ref Gen=12.5 kHz Deviation  
 CARRIER ON TIME

SUPERVISED BY:

*William H. Graff*  
 William H. Graff, Director  
 of Engineering

PAGE NO.

28 of 41.

NAME OF TEST: Transient Frequency Behavior  
g9980075: 1999-Aug-19 Thu 12:37:00  
STATE: 2:High Power

0

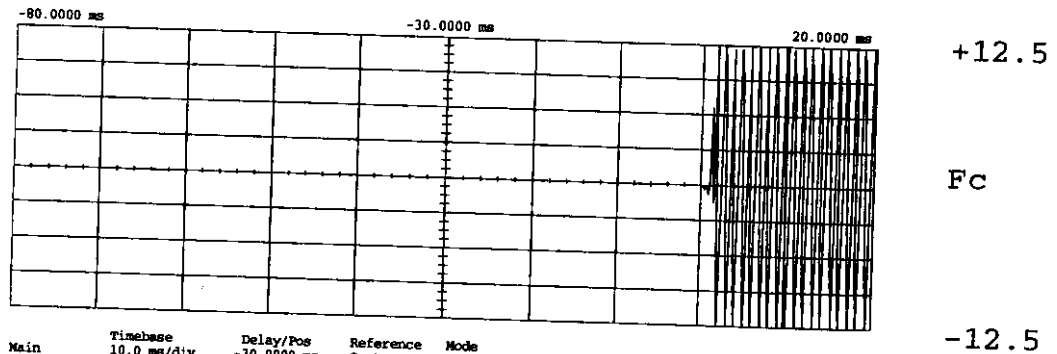

Main	Timebase	Delay/Pos	Reference	Mode
	10.0 ms/div	-30.0000 ms	Center	Repetitive
Channel 1	Sensitivity	Offset	Probe	Coupling
	275 mV/div	0.00000 v	1.000 :1	dc (1M ohm)

Trigger mode : Edge  
On Positive Edge Of Chan2  
Trigger Level  
Chan2 = -1.03125 V (noise reject ON)  
Holdoff = 40.000 ns

POWER:  
MODULATION:  
DESCRIPTION:

HIGH  
Ref Gen=12.5 kHz Deviation  
CARRIER OFF TIME

SUPERVISED BY:

*William H. Graff*  
William H. Graff, Director  
of Engineering

PAGE NO. 29 of 41.  
NAME OF TEST: Audio Low Pass Filter (Voice Input)  
SPECIFICATION: 47 CFR 2.1047(a)  
GUIDE: ANSI/TIA/EIA-603-1992, Paragraph 2.2.15  
TEST EQUIPMENT: As per attached page

MEASUREMENT PROCEDURE

1. The EUT and test equipment were set up such that the audio input was connected at the input to the modulation limiter, and the modulated stage.
2. The audio output was connected at the output to the modulated stage.
3. MEASUREMENT RESULTS: ATTACHED

TRANSMITTER TEST SET-UP

- TEST A. MODULATION CAPABILITY/DISTORTION
- TEST B. AUDIO FREQUENCY RESPONSE
- TEST C. HUM AND NOISE LEVEL
- TEST D. RESPONSE OF LOW PASS FILTER
- TEST E. MODULATION LIMITING

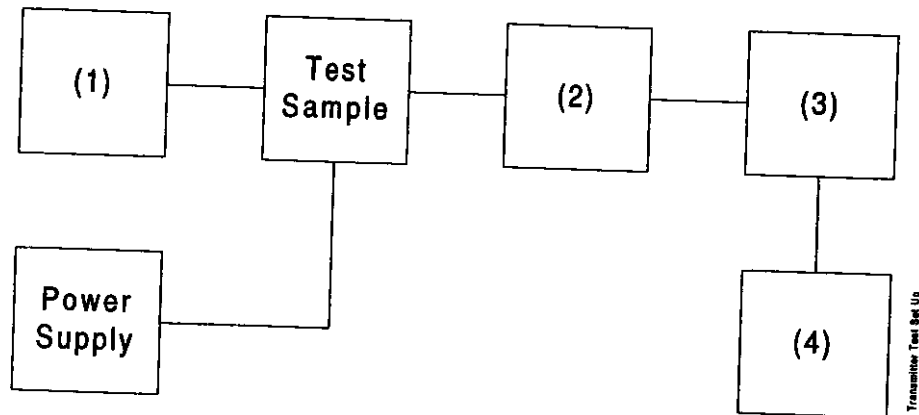

Asset	Description	s/n
(1)	<u>Audio Oscillator</u>	
<u>   </u>	i00010 HP 204D	1105A04683
<u>x</u>	i00017 HP 8903A	2216A01753
<u>x</u>	i00118 HP 33120A	US36002064
(2)	<u>COAXIAL ATTENUATOR</u>	
<u>   </u>	i00122 NARDA 766-10	7802
<u>   </u>	i00123 NARDA 766-10	7802A
<u>x</u>	i00113 SIERRA 661A-3D	1059
<u>   </u>	i00069 BIRD 8329 (30 dB)	10066
(3)	<u>MODULATION ANALYZER</u>	
<u>x</u>	i00020 HP 8901A	2105A01087
(4)	<u>AUDIO ANALYZER</u>	
<u>x</u>	i00017 HP 8903A	2216A01753

PAGE NO.

31 of 41.

NAME OF TEST: Audio Low Pass Filter (Voice Input)  
g9980054: 1999-Aug-19 Thu 10:30:00  
STATE: 0:General

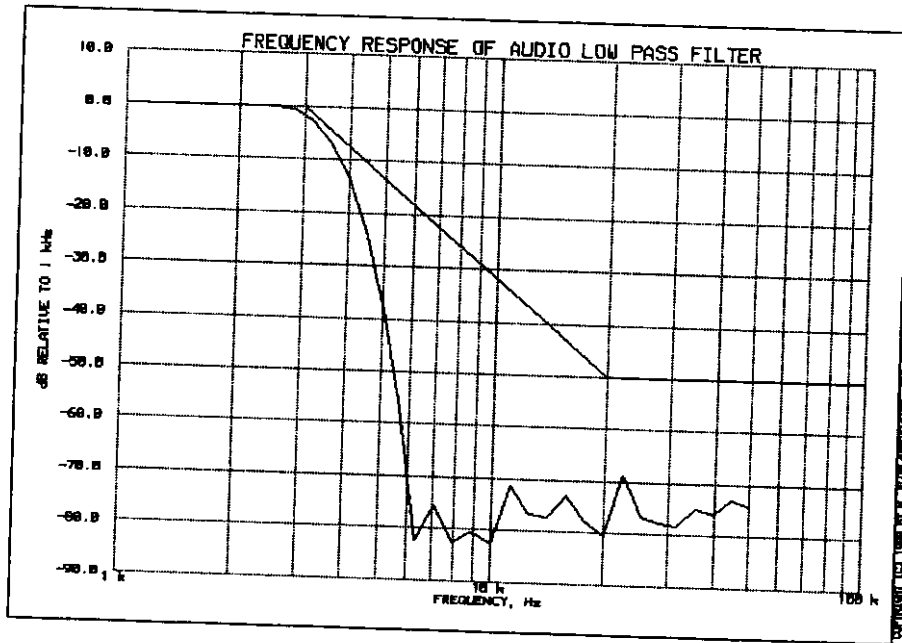

SUPERVISED BY:

  
William H. Graff, Director  
of Engineering



PAGE NO. 32 of 41.  
NAME OF TEST: Audio Frequency Response  
SPECIFICATION: 47 CFR 2.1047(a)  
GUIDE: ANSI/TIA/EIA-603-1992, Paragraph 2.2.6  
TEST EQUIPMENT: As per previous page

MEASUREMENT PROCEDURE

1. The EUT and test equipment were set up as shown on the following page.
2. The audio signal generator was connected to the audio input circuit/microphone of the EUT.
3. The audio signal input was adjusted to obtain 20% modulation at 1 kHz, and this point was taken as the 0 dB reference level.
4. With input levels held constant and below limiting at all frequencies, the audio signal generator was varied from 100 Hz to 50 kHz.
5. The response in dB relative to 1 kHz was then measured, using the HP 8901A Modulation Analyzer.
6. MEASUREMENT RESULTS: ATTACHED

PAGE NO.

33 of 41.

NAME OF TEST: Audio Frequency Response  
 g9980056: 1999-Aug-19 Thu 10:35:00  
 STATE: 0:General

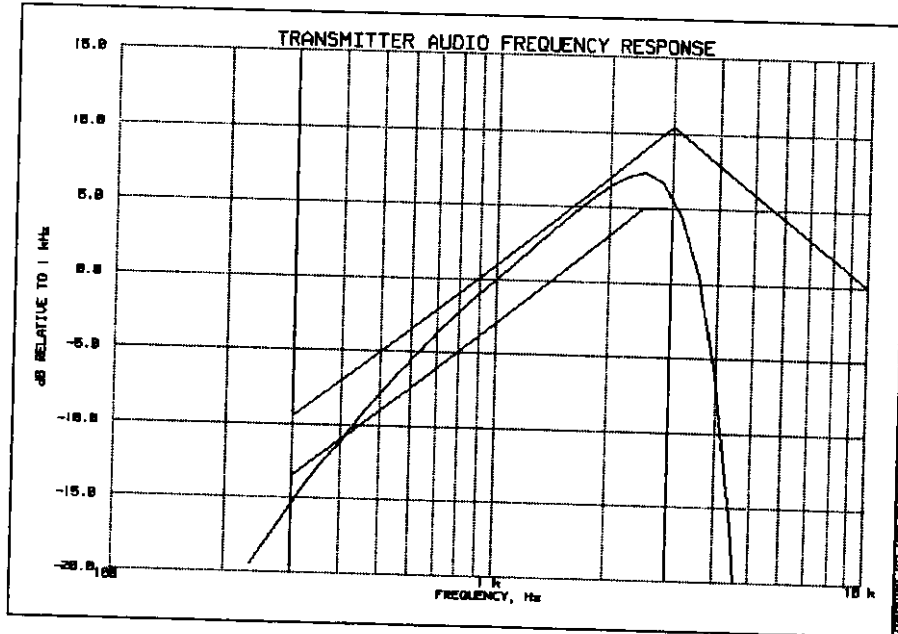

Additional points:

FREQUENCY, Hz	LEVEL, dB
300	-15.65
20000	-28.49
30000	-28.57
50000	-28.52

SUPERVISED BY:

William H. Graff, Director  
 of Engineering

PAGE NO. 34 of 41.  
NAME OF TEST: Modulation Limiting  
SPECIFICATION: 47 CFR 2.1047(b)  
GUIDE: ANSI/TIA/EIA-603-1992, Paragraph 2.2.3  
TEST EQUIPMENT: As per previous page

MEASUREMENT PROCEDURE

1. The signal generator was connected to the input of the EUT as for "Frequency Response of the Modulating Circuit."
2. The modulation response was measured for each of three frequencies (one of which was the frequency of maximum response), and the input voltage was varied and was observed on an HP 8901A Modulation Analyzer.
3. The input level was varied from 30% modulation ( $\pm 1.5$  kHz deviation) to at least 20 dB higher than the saturation point.
4. Measurements were performed for both negative and positive modulation and the respective results were recorded.
5. MEASUREMENT RESULTS: ATTACHED

PAGE NO.

35 of 41.

NAME OF TEST: Modulation Limiting  
g9980057: 1999-Aug-19 Thu 10:40:00  
STATE: 0:General

Positive  
Peaks:

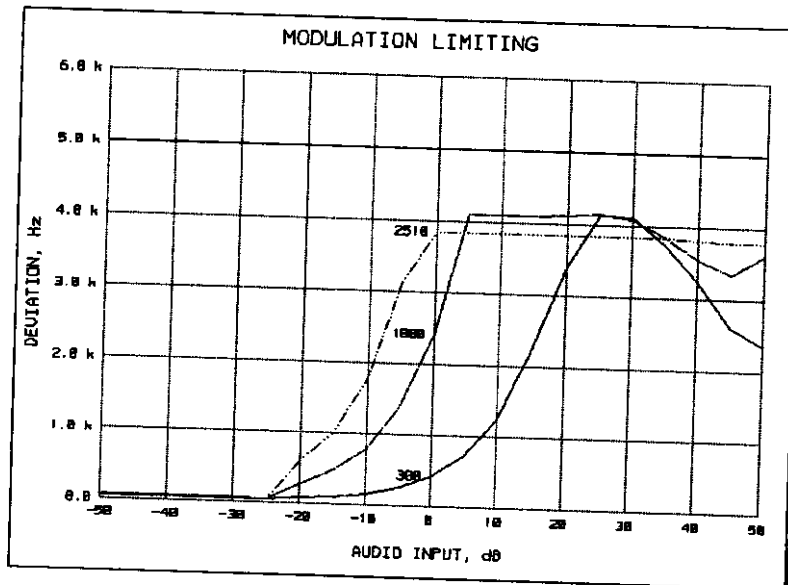

Negative  
Peaks:

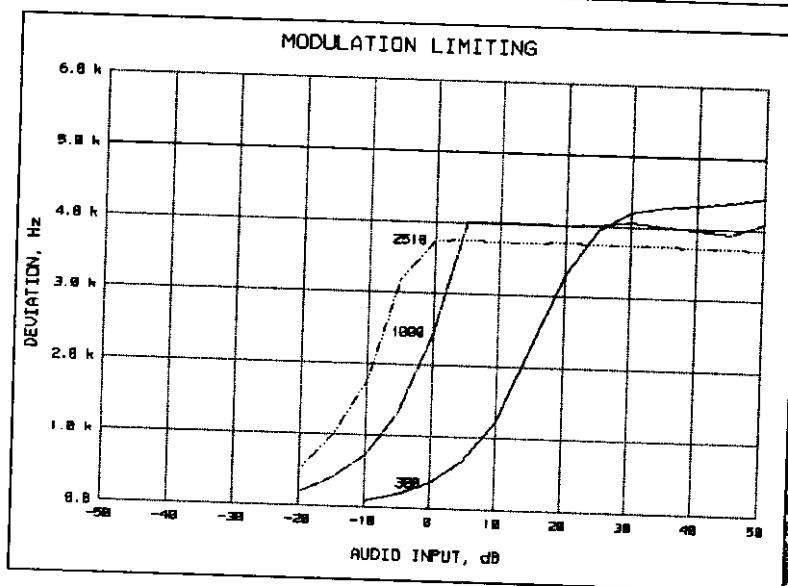

SUPERVISED BY:

*William H. Graff*  
William H. Graff, Director  
of Engineering

PAGE NO.

36 of 41.

NAME OF TEST: Modulation Limiting  
g9980058: 1999-Aug-19 Thu 10:44:00  
STATE: 0:General

Positive  
Peaks:

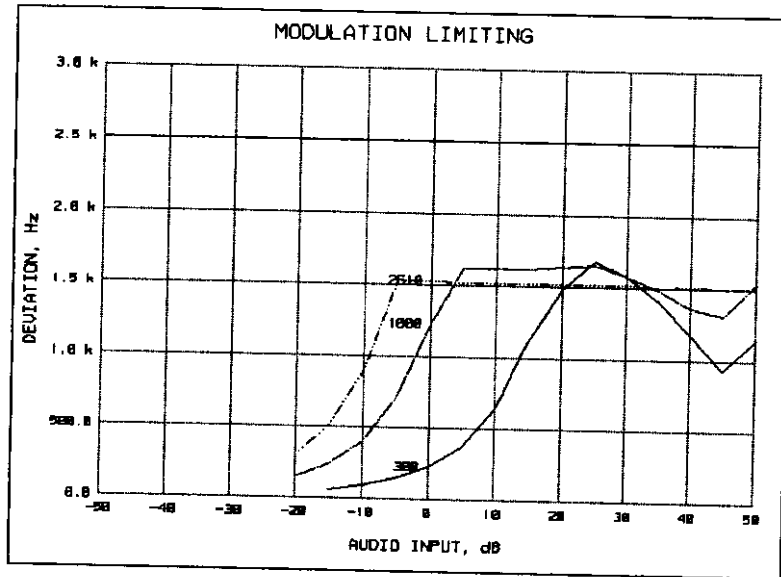

Negative  
Peaks:

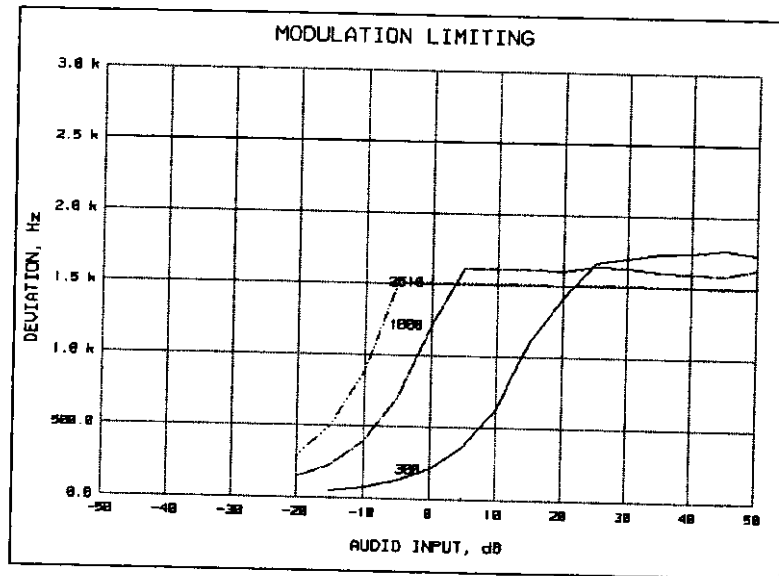

SUPERVISED BY:

  
William H. Graff, Director  
of Engineering

PAGE NO. 37 of 41.  
NAME OF TEST: Frequency Stability (Temperature Variation)  
SPECIFICATION: 47 CFR 2.1055(a)(1)  
GUIDE: ANSI/TIA/EIA-603-1992, Paragraph 2.2.2  
TEST CONDITIONS: As Indicated  
TEST EQUIPMENT: As per previous page

MEASUREMENT PROCEDURE

1. The EUT and test equipment were set up as shown on the following page.
2. With all power removed, the temperature was decreased to  $-30^{\circ}\text{C}$  and permitted to stabilize for three hours. Power was applied and the maximum change in frequency was noted within one minute.
3. With power OFF, the temperature was raised in  $10^{\circ}\text{C}$  steps. The sample was permitted to stabilize at each step for at least one-half hour. Power was applied and the maximum frequency change was noted within one minute.
4. The temperature tests were performed for the worst case.
5. MEASUREMENT RESULTS: ATTACHED

TRANSMITTER TEST SET-UP

- TEST A. OPERATIONAL STABILITY
- TEST B. CARRIER FREQUENCY STABILITY
- TEST C. OPERATIONAL PERFORMANCE STABILITY
- TEST D. HUMIDITY
- TEST E. VIBRATION
- TEST F. ENVIRONMENTAL TEMPERATURE
- TEST G. FREQUENCY STABILITY: TEMPERATURE VARIATION
- TEST H. FREQUENCY STABILITY: VOLTAGE VARIATION

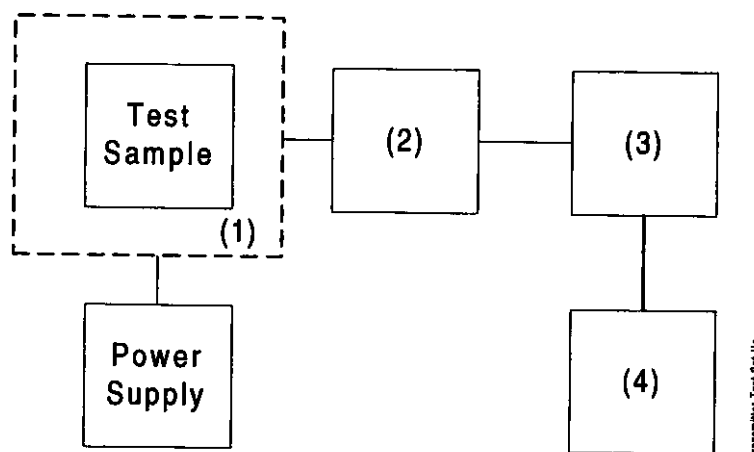

Asset	Description	s/n
<u>(1) TEMPERATURE, HUMIDITY, VIBRATION</u>		
<u>x</u>	i00027 Tenny Temp. Chamber	9083-765-234
___	i00 Weber Humidity Chamber	
___	i00 L.A.B. RVH 18-100	
<u>(2) COAXIAL ATTENUATOR</u>		
___	i00122 NARDA 766-10	7802
___	i00123 NARDA 766-10	7802A
<u>x</u>	i00113 SIERRA 661A-3D	1059
___	i00069 BIRD 8329 (30 dB)	10066
<u>(3) R.F. POWER</u>		
___	i00014 HP 435A POWER METER	1733A05839
<u>x</u>	i00039 HP 436A POWER METER	2709A26776
<u>x</u>	i00020 HP 8901A POWER MODE	2105A01087
<u>(4) FREQUENCY COUNTER</u>		
___	i00042 HP 5383A	1628A00959
<u>x</u>	i00019 HP 5334B	2704A00347
<u>x</u>	i00020 HP 8901A	2105A01087

PAGE NO.

39 of 41.

NAME OF TEST: Frequency Stability (Temperature Variation)  
g9980042: 1999-Aug-16 Mon 10:30:00  
STATE: 0:General

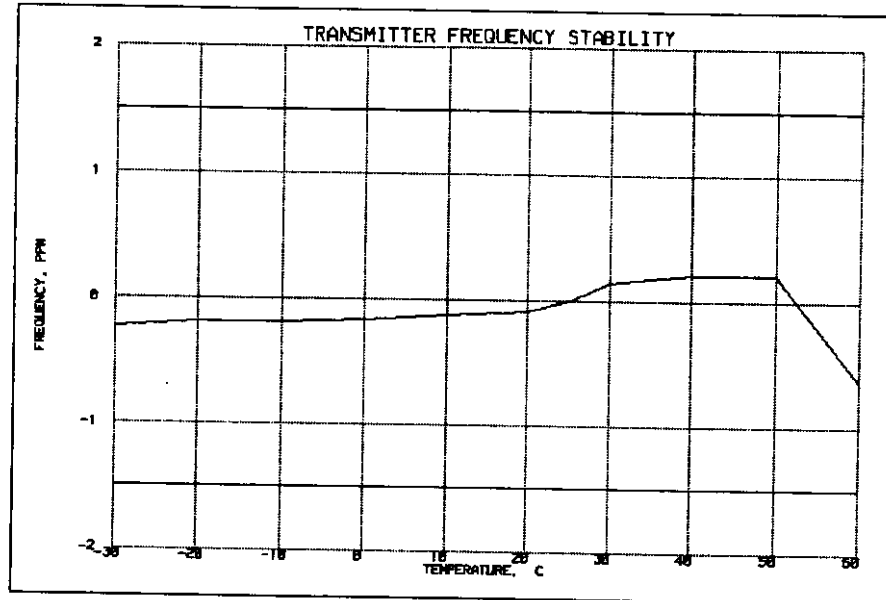

SUPERVISED BY:

William H. Graff, Director  
of Engineering



PAGE NO. 40 of 41.  
NAME OF TEST: Frequency Stability (Voltage Variation)  
SPECIFICATION: 47 CFR 2.1055(b) (1)  
GUIDE: ANSI/TIA/EIA-603-1992, Paragraph 2.2.2  
TEST EQUIPMENT: As per previous page

MEASUREMENT PROCEDURE

1. The EUT was placed in a temperature chamber at 25±5°C and connected as for "Frequency Stability - Temperature Variation" test.
2. The power supply voltage to the EUT was varied from 85% to 115% of the nominal value measured at the input to the EUT.
3. The variation in frequency was measured for the worst case.

RESULTS: Frequency Stability (Voltage Variation)  
g9980067: 1999-Aug-16 Mon 10:27:12  
STATE: 0:General

		LIMIT, ppm = 1.5			
		LIMIT, Hz = 720			
		BATTERY END POINT (Voltage) = 9			
% of STV	Voltage	Frequency, MHz	Change, Hz	Change, ppm	
85	11.73	479.999990	-10	-0.02	
100	13.8	480.000000	0	0.00	
115	15.87	480.000010	10	0.02	
65	9	479.999980	-20	-0.04	

RESULTS: Frequency Stability (Voltage Variation)  
g9980070: 1999-Aug-19 Thu 11:06:39  
STATE: 0:General

		LIMIT, ppm = 2.5			
		LIMIT, Hz = 1240			
		BATTERY END POINT (Voltage) = 8.7			
% of STV	Voltage	Frequency, MHz	Change, Hz	Change, ppm	
85	11.73	496.000000	0	0.00	
100	13.8	496.000000	0	0.00	
115	15.87	496.000000	0	0.00	
63	8.7	495.999980	-20	-0.04	

SUPERVISED BY:

  
William H. Graff, Director  
of Engineering

PAGE NO. 41 of 41.  
NAME OF TEST: Necessary Bandwidth and Emission Bandwidth  
SPECIFICATION: 47 CFR 2.202(g)

MODULATION = 16K0F3E

NECESSARY BANDWIDTH CALCULATION:

MAXIMUM MODULATION (M), kHz = 3  
 MAXIMUM DEVIATION (D), kHz = 5  
 CONSTANT FACTOR (K) = 1  
 NECESSARY BANDWIDTH (B<sub>N</sub>), kHz = (2 x M) + (2 x D x K)  
 = 16.0

MODULATION = 11K0F3E

NECESSARY BANDWIDTH CALCULATION:

MAXIMUM MODULATION (M), kHz = 3  
 MAXIMUM DEVIATION (D), kHz = 2.5  
 CONSTANT FACTOR (K) = 1  
 NECESSARY BANDWIDTH (B<sub>N</sub>), kHz = (2 x M) + (2 x D x K)  
 = 11.0

SUPERVISED BY:



William H. Graff, Director  
 of Engineering

TESTIMONIAL  
AND  
STATEMENT OF CERTIFICATION

THIS IS TO CERTIFY THAT:

1. THAT the application was prepared either by, or under the direct supervision of, the undersigned.
2. THAT the technical data supplied with the application was taken under my direction and supervision.
3. THAT the data was obtained on representative units, randomly selected.
4. THAT, to the best of my knowledge and belief, the facts set forth in the application and accompanying technical data are true and correct.

CERTIFYING ENGINEER:

  
William H. Graff, Director  
of Engineering