

## TEST REPORT

**Report Number: 19110037HKG-002**

Application for Class II Permissive Change of 47 CFR Part 15 Certification

**FCC ID: AL8-E60XXX**

**Prepared and Checked by:**

**Approved by:**

Signed On File  
Chan Hin Man, Oscar  
Assistant Engineer

---

Lee Shui Tim, Tim  
Assistant Supervisor  
Date: January 21, 2020

---

Intertek's standard Terms and Conditions can be obtained at our website <http://www.intertek.com/terms/>.

This test report only allows to be revised within the retention period unless further standard or the requirement was noticed.

This report is for the exclusive use of Intertek's Client and is provided pursuant to the agreement between Intertek and its Client. Intertek's responsibility and liability are limited to the terms and conditions of the agreement. Intertek assumes no liability to any party, other than to the Client in accordance with the agreement, for any loss, expense or damage occasioned by the use of this report. Only the Client is authorized to permit copying or distribution of this report and then only in its entirety. Any use of the Intertek name or one of its marks for the sale or advertisement of the tested material, product or service must first be approved in writing by Intertek. The observations and test results in this report are relevant only to the sample tested. This report by itself does not imply that the material, product, or service is or has ever been under an Intertek certification program.

© 2017 Intertek

## TEST REPORT

### GENERAL INFORMATION

<b>Applicant Name:</b>	Plantronics, Inc.
<b>Applicant Address:</b>	345 Encinal Street, Santa Cruz, CA 95060, United States of America.
<b>FCC Specification Standard:</b>	FCC Part 15, October 1, 2018 Edition
<b>FCC ID:</b>	AL8-E60XXX
<b>FCC Model(s):</b>	Elara 60 WS
<b>Firmware Version:</b>	0.8.10
<b>Type of EUT:</b>	Unlicensed National Information Infrastructure Transmitter
<b>Description of EUT:</b>	Mobile Phone Station with Bluetooth
<b>Serial Number:</b>	N/A
<b>Sample Receipt Date:</b>	December 14, 2019
<b>Date of Test:</b>	December 14, 2019 to January 20, 2020
<b>Report Date:</b>	January 21, 2020
<b>Environmental Conditions:</b>	Temperature: +10 to 40°C Humidity: 10 to 90%
<b>Conclusion:</b>	Test was conducted by client submitted sample. The submitted sample as received complied with the 47 CFR Part 15 Certification.

## TEST REPORT

### TABLE OF CONTENTS

<b>1.0</b>	<b>TEST RESULTS SUMMARY &amp; STATEMENT OF COMPLIANCE .....</b>	<b>4</b>
1.1	Summary of Test Results .....	4
1.2	Statement of Compliance .....	4
<b>2.0</b>	<b>GENERAL DESCRIPTION .....</b>	<b>5</b>
2.1	Product Description.....	5
2.2	Purpose of Change .....	5
2.3	Test Facility .....	5
2.4	Related Submittal(s) Grants.....	5
<b>3.0</b>	<b>SYSTEM TEST CONFIGURATION .....</b>	<b>6</b>
3.1	Justification .....	6
3.2	EUT Exercising Software .....	7
3.3	Details of EUT and Description of Accessories.....	8
3.4	Measurement Uncertainty .....	8
<b>4.0</b>	<b>TEST RESULTS .....</b>	<b>9</b>
4.1	Maximum Conducted Output Power at Antenna Terminals.....	9
4.2	Minimum 6dB RF Bandwidth .....	10
4.3	Maximum Power Spectral Density .....	14
4.4	Out of Band Conducted Emissions .....	18
4.5	Field Strength Calculation .....	25
4.6	Transmitter Radiated Emissions in Restricted Bands and Spurious Emissions.....	26
4.6.1	Radiated Emission Configuration Photograph .....	26
4.6.2	Radiated Emission Data .....	26
4.6.3	Radiated Emission Test Setup .....	37
4.6.4	Transmitter Duty Cycle Calculation .....	38
4.7	AC Power Line Conducted Emission .....	39
4.7.1	AC Power Line Conducted Emission Configuration Photograph .....	39
4.7.2	AC Power Line Conducted Emission Data.....	39
4.7.3	Conducted Emission Test Setup .....	42
<b>5.0</b>	<b>EQUIPMENT LIST.....</b>	<b>43</b>

## TEST REPORT

### 1.0 TEST RESULTS SUMMARY & STATEMENT OF COMPLIANCE

#### 1.1 Summary of Test Results

Test Items	FCC Part 15 Section	Results	Details See Section
Antenna Requirement	15.203	Pass	2.1
Max. Conducted Output Power (Peak)	15.247(b)(3)&(4)	Pass	4.1
Min. 6dB RF Bandwidth	15.247(a)(2)	Pass	4.2
Max. Power Density (average)	15.247(e)	Pass	4.3
Out of Band Antenna Conducted Emission	15.247(d)	Pass	4.4
Radiated Emission in Restricted Bands and Spurious Emissions	15.247(d), 15.209 & 15.109	Pass	4.6
AC Power Line Conducted Emission	15.207 & 15.107	N/A	4.7

Note: Pursuant to FCC Part 15 Section 15.215(c), the 20dB bandwidth of the emission was contained within the frequency band designated (mentioned as above) which the EUT operated. The effects, if any, from frequency sweeping, frequency hopping, other modulation techniques and frequency stability over expected variations in temperature and supply voltage were considered.

#### 1.2 Statement of Compliance

The equipment under test is found to be complying with the following standard:

FCC Part 15, October 1, 2018 Edition

## TEST REPORT

### 2.0 GENERAL DESCRIPTION

#### 2.1 Product Description

The Elara 60 WS is a Mobile Phone Station with Bluetooth. A wireless mobile phone dock is consisting of a base unit and either wireless headset/wireless USB dongle or corded headset.

The Equipment Under Test (EUT) operates at frequency range of 2402MHz to 2480 MHz. There are totally 40 with 1MHz channel separation .

The EUT is powered by a 100-240VAC 50/60Hz AC adaptor.

The antenna used in the EUT is integral, and the test sample is a prototype.

The circuit description is saved with filename: descri.pdf.

#### 2.2 Purpose of Change

The purpose of change is saved with filename: product change.pdf

#### 2.3 Test Facility

The radiated emission test site and antenna port conducted measurement facility used to collect the radiated data and conductive data are at Workshop No. 3, G/F., World-Wide Industrial Centre, 43-47 Shan Mei Street, Fo Tan, Sha Tin, N.T., Hong Kong SAR, China. This test facility and site measurement data have been fully placed on file with the FCC.

#### 2.4 Related Submittal(s) Grants

This is a single application for certification of a transceiver (WiFi portion)

## TEST REPORT

### 3.0 SYSTEM TEST CONFIGURATION

#### 3.1 Justification

For radiated emissions testing, the equipment under test (EUT) was setup to transmit / receive continuously to simplify the measurement methodology. Care was taken to ensure proper power supply voltages during testing. During testing, all cables (if any) were manipulated to produce worst case emissions.

The EUT was powered by a 100-240VAC 50/60Hz adaptor.

For the measurements, the EUT was attached to a plastic stand if necessary and placed on the wooden turntable. If the base unit attached to peripherals, they were connected and operational (as typical as possible).

The signal was maximized through rotation and placement in the three orthogonal axes. The antenna height and polarization were varied during the search for maximum signal level. The antenna height was varied from 1 to 4 meters. Radiated emissions were taken at three meters unless the signal level was too low for measurement at that distance. If necessary, a pre-amplifier was used and/or the test was conducted at a closer distance.

For any intentional radiator powered by AC power line, measurements of the radiated signal level of the fundamental frequency component of the emission was performed with the supply voltage varied between 85% and 115% of the nominal rated supply voltage.

Radiated emission measurement for transmitter were performed from the lowest radio frequency signal generated in the device which is greater than 9 kHz to the tenth harmonic of the highest fundamental frequency or to 40 GHz, whichever is lower.

Emission that are directly caused by digital circuits in the transmit path and transmitter portion were measured, and the limit are according to FCC Part 15 Section 15.209. Digital circuitries used to control additional functions other than the operation of the transmitter are subject to FCC Part 15 Section 15.109 Limits.

## TEST REPORT

### 3.1 Justification – Cont'd

Detector function for radiated emissions was in peak mode. Average readings, when required, were taken by measuring the duty cycle of the equipment under test and subtracting the corresponding amount in dB from the measured peak readings. A detailed description for the calculation of the average factor can be found in section 4.8.3.

Determination of pulse desensitization was made according to *Hewlett Packard Application Note 150-2, Spectrum Analysis... Pulsed RF*. The effective period (Teff) was referred to Exhibit 4.8.3. With the resolution bandwidth 1MHz and spectrum analyzer IF bandwidth 3dB, the pulse desensitization factor was 0dB.

For AC line conducted emission test, the EUT along with its peripherals were placed on a 1.0m(W)x1.5m(L) and 0.8m in height wooden table and the EUT was adjusted to maintain a 0.4 meter space from a vertical reference plane. The EUT was connected to power mains through a line impedance stabilization network (LISN), which provided 50ohm coupling impedance for measuring instrument. The LISN housing, measuring instrument case, reference ground plane, and vertical ground plane were bounded together. The excess power cable between the EUT and the LISN was bundled.

All connecting cables of EUT and peripherals were manipulated to find the maximum emission.

Different data rates have been tested. Worst case is reported only.

All relevant operation modes have been tested, and the worst case data is included in this report.

All data rates were tested under normal mode of WiFi. Only the worst-case data is shown in the report for DSSS and OFDM

### 3.2 EUT Exercising Software

The EUT exercise program (if any) used during radiated and conducted testing was designed to exercise the various system components in a manner similar to a typical use.

## TEST REPORT

### 3.3 Details of EUT and Description of Accessories

#### Details of EUT:

An AC adaptor (provided with the unit) was used to power the device. Their description are listed below.

- (1) An AC adaptor (100-240VAC 50/60Hz 0.6A to 12VDC 1.5A, Model: SSC-120150) (Provided by Client)

#### Description of Accessories:

- (1) Pika Cradle model: 5200 #003 and docking. (Provided by Client)
- (2) Pika Cradle model: Focus #01 and docking. (Provided by Client)
- (3) Pika Cradle model: USB-A #01 (Provided by Client)
- (4) Bluetooth USB Dongle Model:BT600 (Provided by Client)
- (5) Bluetooth hands-free model: Voyager 5200 (Provided by Client)
- (6) Bluetooth headset model: B825 (Provided by Client)
- (7) Wired headset model: C3220 (Provided by Client)
- (8) Wired headset model: Blackwire 5220 (C5220T stereo headset + C5200 control panel kit)
- (9) Bluetooth USB Dongle Model:BT900 with audio loop back mode test software (Provided by Client)
- (10) USB loading 5V 1A (Provided by Intertek)
- (11) Samsung S8 (provided by Intertek)

### 3.4 Measurement Uncertainty

When determining of the test conclusion, the Measurement Uncertainty of test at a level of confidence of 95% has been considered. The values of the Measurement uncertainty for radiated emission test and RF conducted measurement test are  $\pm 5.3\text{dB}$  and  $\pm 0.99\text{dB}$  respectively. The value of the Measurement uncertainty for conducted emission test is  $\pm 4.2\text{dB}$ .

Uncertainty and Compliance - Unless the standard specifically states that measured values are to be extended by the measurement uncertainty in determining compliance, all compliance determinations are based on the actual measured value.



## TEST REPORT

### 4.0 TEST RESULTS

#### 4.1 Maximum Conducted (peak) Output Power at Antenna Terminals

##### RF Conduct Measurement Test Setup

The figure below shows the test setup, which is utilized to make these measurements.

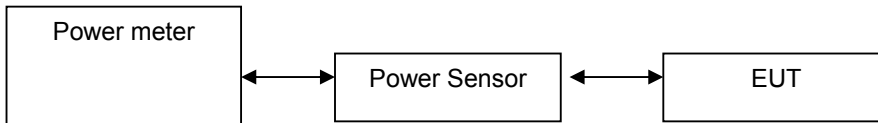

The antenna port of the EUT was connected to the input of a spectrum analyzer.

- The antenna power of the EUT was connected to the input of a power meter. Power was read directly and cable loss correction was added to the reading to obtain power at the EUT antenna terminals. The measurement procedure 9.1.2 was used.
- The EUT should be configured to transmit continuously (at a minimum duty cycle of 98%) at full power over the measurement duration. The measurement procedure AVG1 was used.

BLE Antenna Gain = -2.0 dBi

Frequency (MHz)	Output in dBm	Output in mWatt
Low Channel: 2402	0.21	1.05
Middle Channel: 2440	0.19	1.04
High Channel: 2480	-0.40	0.91

Cable loss : 0.5 dB External Attenuation : 0 dB

Cable loss, external attenuation:  included in OFFSET function  
 added to SA raw reading

BLE

max. conducted (peak) output level = 0.0 dBm

Limits:

- 1W (30dBm) for antennas with gains of 6dBi or less
- \_\_\_ W (\_\_\_ dBm) for antennas with gains more than 6dBi

The plots of conducted output power are saved as below.

## TEST REPORT

### 4.2 Minimum 6dB RF Bandwidth

The antenna port of the EUT was connected to the input of a spectrum analyzer. The EBW measurement procedure was used. A PEAK output reading was taken, a DISPLAY line was drawn 6dB lower than PEAK level. The 6dB bandwidth was determined from where the channel output spectrum intersected the display line.

#### BLE

Frequency (MHz)	6dB Bandwidth (MHz)
Low Channel: 2402	0.792
Middle Channel: 2440	0.792
High Channel: 2480	0.792

#### Limits

6 dB bandwidth shall be at least 500kHz

The plots of 6dB RF bandwidth are saved as below.

**TEST REPORT**

**PLOTS OF 6dB RF BANDWIDTH**

BLE, Lowest Channel

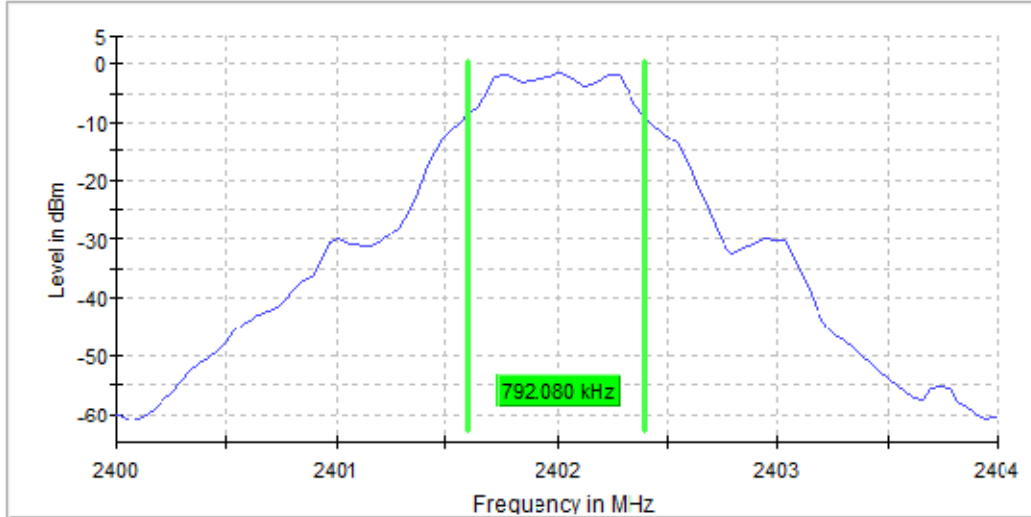

DUT Frequency (MHz)	Bandwidth (MHz)	Limit Min (MHz)	Limit Max (MHz)	Band Edge Left (MHz)	Band Edge Right (MHz)
2402.000000	0.792080	0.500000	---	2401.603960	2402.396040

Setting	Instrument Value	Target Value
Start Frequency	2.40000 GHz	2.40000 GHz
Stop Frequency	2.40400 GHz	2.40400 GHz
Span	4.000 MHz	4.000 MHz
RBW	100.000 kHz	~ 100.000 kHz
VBW	300.000 kHz	~ 300.000 kHz
SweepPoints	101	~ 40
Sweeptime	18.938 $\mu$ s	AUTO
Reference Level	-10.000 dBm	-10.000 dBm
Attenuation	10.000 dB	AUTO
Detector	MaxPeak	MaxPeak
SweepCount	100	100
Filter	3 dB	3 dB
Trace Mode	Max Hold	Max Hold
SweepType	FFT	AUTO
Preamp	off	off
Stablemode	Trace	Trace
Stablevalue	0.50 dB	0.50 dB
Run	5 / max. 10	max. 10
Stable	2 / 2	2
Max Stable Difference	0.27 dB	0.50 dB

**TEST REPORT**

BLE, Middle Channel

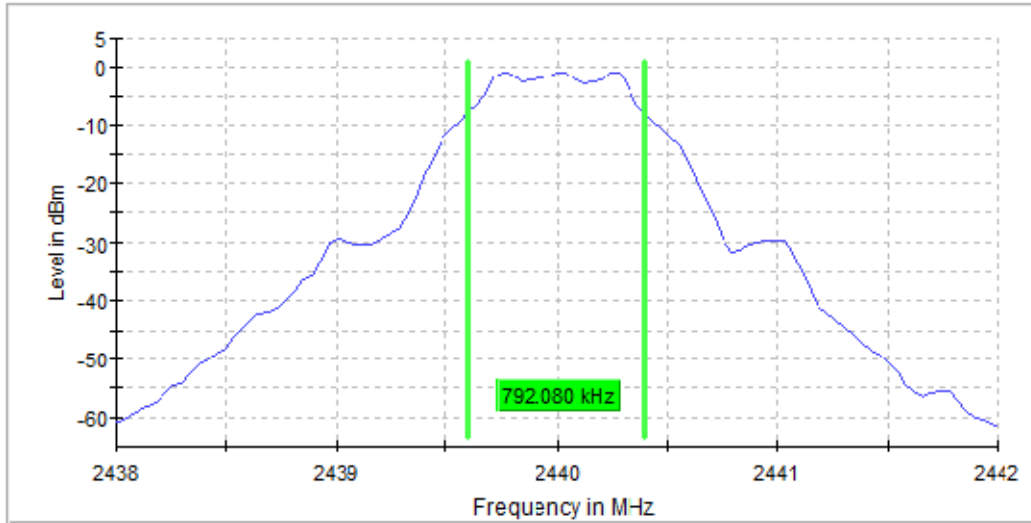

DUT Frequency (MHz)	Bandwidth (MHz)	Limit Min (MHz)	Limit Max (MHz)	Band Edge Left (MHz)	Band Edge Right (MHz)
2440.000000	0.792080	0.500000	---	2439.603960	2440.396040

Setting	Instrument Value	Target Value
Start Frequency	2.43800 GHz	2.43800 GHz
Stop Frequency	2.44200 GHz	2.44200 GHz
Span	4.000 MHz	4.000 MHz
RBW	100.000 kHz	~ 100.000 kHz
VBW	300.000 kHz	~ 300.000 kHz
SweepPoints	101	~ 40
SweepTime	18.938 $\mu$ s	AUTO
Reference Level	-10.000 dBm	-10.000 dBm
Attenuation	10.000 dB	AUTO
Detector	MaxPeak	MaxPeak
SweepCount	100	100
Filter	3 dB	3 dB
Trace Mode	Max Hold	Max Hold
SweepType	FFT	AUTO
Preamp	off	off
Stablemode	Trace	Trace
Stablevalue	0.50 dB	0.50 dB
Run	8 / max. 10	max. 10
Stable	2 / 2	2
Max Stable Difference	0.00 dB	0.50 dB

**TEST REPORT**

**PLOTS OF 6dB RF BANDWIDTH**

BLE, Highest Channel

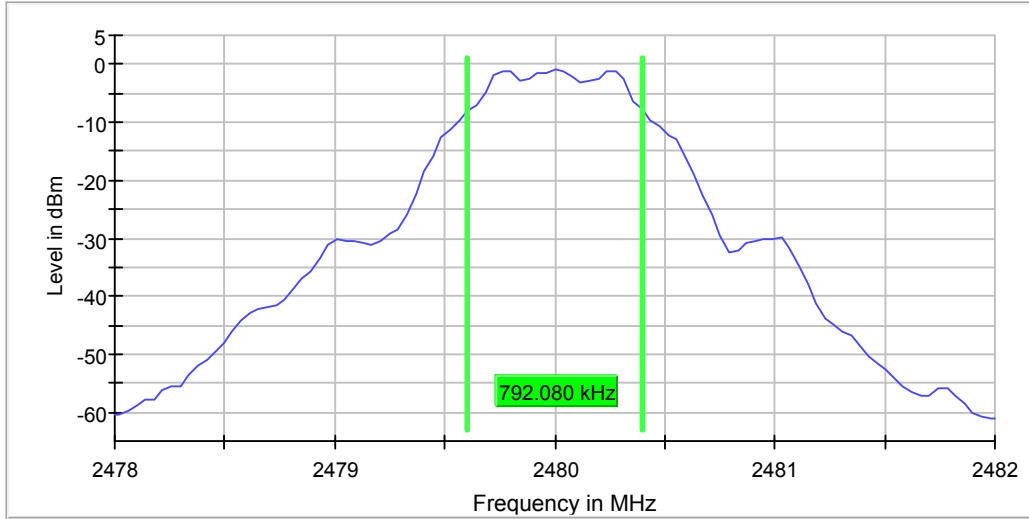

DUT Frequency (MHz)	Bandwidth (MHz)	Limit Min (MHz)	Limit Max (MHz)	Band Edge Left (MHz)	Band Edge Right (MHz)
2480.000000	0.792080	0.500000	---	2479.603960	2480.396040

Setting	Instrument Value	Target Value
Start Frequency	2.47800 GHz	2.47800 GHz
Stop Frequency	2.48200 GHz	2.48200 GHz
Span	4.000 MHz	4.000 MHz
RBW	100.000 kHz	~ 100.000 kHz
VBW	300.000 kHz	~ 300.000 kHz
SweepPoints	101	~ 40
SweepTime	18.938 $\mu$ s	AUTO
Reference Level	-10.000 dBm	-10.000 dBm
Attenuation	10.000 dB	AUTO
Detector	MaxPeak	MaxPeak
SweepCount	100	100
Filter	3 dB	3 dB
Trace Mode	Max Hold	Max Hold
SweepType	FFT	AUTO
Preamp	off	off
Stablemode	Trace	Trace
Stablevalue	0.50 dB	0.50 dB
Run	5 / max. 10	max. 10
Stable	2 / 2	2
Max Stable Difference	0.10 dB	0.50 dB

## TEST REPORT

### 4.3 Maximum Power Spectral Density

Antenna output of the EUT was coupled directly to spectrum analyzer. The measurement procedure 10.2 PKPSD was used. If an external attenuator and/or cable was used, these losses are compensated for using the OFFSET function of the analyser.

#### BLE

Frequency (MHz)	PSD in 100kHz (dBm)
Low Channel:	-1.478
Middle Channel:	-0.744
High Channel:	-0.941

Cable Loss: 0.5 dB

Limit:  
8dBm

The plots of power spectral density are as below.

**TEST REPORT**

**PLOTS OF POWER SPECTRAL DENSITY**

BLE, Lowest channel

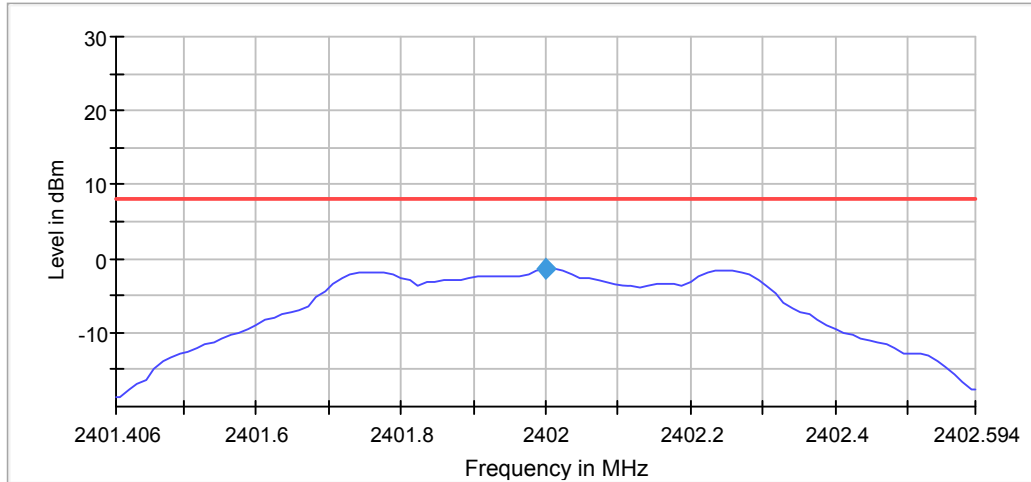

— Limit    — Sum Level    ◆ PSD

DUT Frequency (MHz)	Frequency (MHz)	PSD (dBm)	Limit Max (dBm)	Result
2402.000000	2402.000000	-1.478	8.0	PASS

Setting	Instrument Value	Target Value
Start Frequency	2.40141 GHz	2.40141 GHz
Stop Frequency	2.40259 GHz	2.40259 GHz
Span	1.188 MHz	1.188 MHz
RBW	100.000 kHz	<= 100.000 kHz
VBW	300.000 kHz	>= 300.000 kHz
SweepPoints	101	~ 24
Sweeptime	505.000 ms	505.000 ms
Reference Level	-10.000 dBm	-10.000 dBm
Attenuation	10.000 dB	AUTO
Detector	MaxPeak	MaxPeak
SweepCount	1	1
Filter	3 dB	3 dB
Trace Mode	Max Hold	Max Hold
Sweeptype	Sweep	Sweep
Preamp	off	off
Stablemode	Trace	Trace
Stablevalue	0.50 dB	0.50 dB
Run	3 / max. 10	max. 10
Stable	2 / 2	2
Max Stable Difference	0.06 dB	0.50 dB

## TEST REPORT

BLE, Middle channel

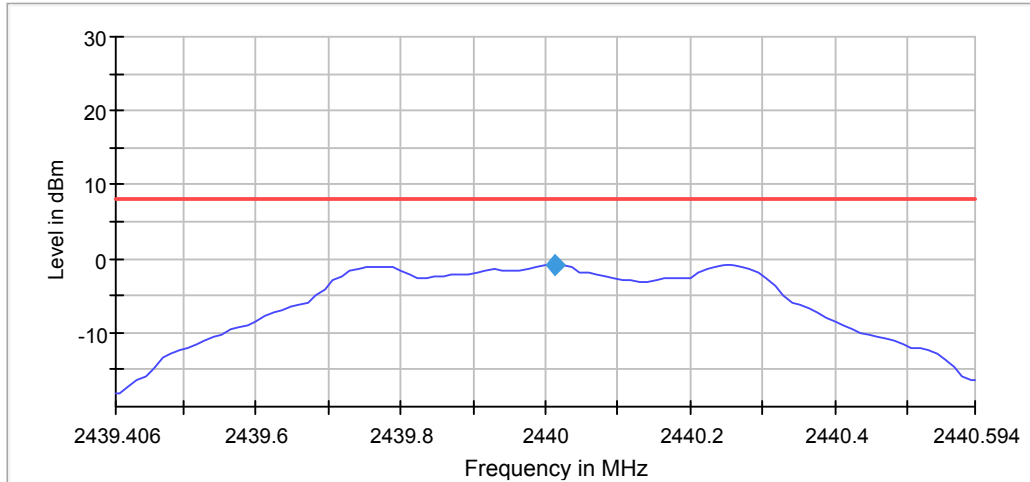

— Limit    — Sum Level    ◆ PSD

DUT Frequency (MHz)	Frequency (MHz)	PSD (dBm)	Limit Max (dBm)	Result
2440.000000	2440.011764	-0.744	8.0	PASS

Setting	Instrument Value	Target Value
Start Frequency	2.43941 GHz	2.43941 GHz
Stop Frequency	2.44059 GHz	2.44059 GHz
Span	1.188 MHz	1.188 MHz
RBW	100.000 kHz	<= 100.000 kHz
VBW	300.000 kHz	>= 300.000 kHz
SweepPoints	101	~ 24
Sweeptime	505.000 ms	505.000 ms
Reference Level	-10.000 dBm	-10.000 dBm
Attenuation	10.000 dB	AUTO
Detector	Peak	Peak
SweepCount	1	1
Filter	3 dB	3 dB
Trace Mode	Max Hold	Max Hold
SweepType	Sweep	Sweep
Preamp	off	off
Stablemode	Trace	Trace
Stablevalue	0.50 dB	0.50 dB
Run	3 / max. 10	max. 10
Stable	2 / 2	2
Max Stable Difference	0.21 dB	0.50 dB



**TEST REPORT**

**PLOTS OF POWER SPECTRAL DENSITY**

BLE, Highest channel

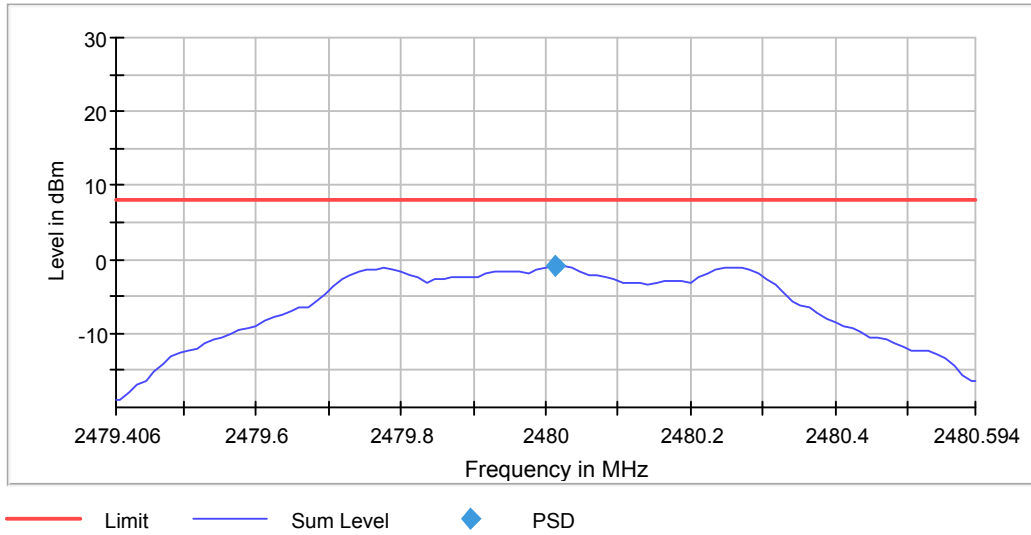

DUT Frequency (MHz)	Frequency (MHz)	PSD (dBm)	Limit Max (dBm)	Result
2480.000000	2480.011764	-0.941	8.0	PASS

Setting	Instrument Value	Target Value
Start Frequency	2.47941 GHz	2.47941 GHz
Stop Frequency	2.48059 GHz	2.48059 GHz
Span	1.188 MHz	1.188 MHz
RBW	100.000 kHz	<= 100.000 kHz
VBW	300.000 kHz	>= 300.000 kHz
SweepPoints	101	~ 24
SweepTime	505.000 ms	505.000 ms
Reference Level	-10.000 dBm	-10.000 dBm
Attenuation	10.000 dB	AUTO
Detector	Peak	Peak
SweepCount	1	1
Filter	3 dB	3 dB
Trace Mode	Max Hold	Max Hold
SweepType	Sweep	Sweep
Preamp	off	off
Stablemode	Trace	Trace
Stablevalue	0.50 dB	0.50 dB
Run	3 / max. 10	max. 10
Stable	2 / 2	2
Max Stable Difference	0.17 dB	0.50 dB

## TEST REPORT

### 4.4 Out of Band Conducted Emissions

For BLE, the maximum conducted (peak) output power was used to demonstrate compliance as described in 9.1. Then the display line (in red) shown in the following plots denotes the limit at 20dB below maximum measured in-band peak PSD level in 100 KHz bandwidth for BLE/g/n20/n40MHz.

The measurement procedures under sections 11 of No.558074 D01 v05r02 (02-April-2019) were used.

Furthermore, delta measurement technique for measuring bandedge emissions was incorporated in the test of the edge at 2483.5MHz.

#### Limits:

All spurious emission and up to the tenth harmonic was measured and they were found to be at least for BLE below the maximum measured in-band peak PSD level.

**TEST REPORT**

**PLOTS OF OUT OF BAND CONDUCTED EMISSIONS**

BLE, Lowest Channel, Plot A

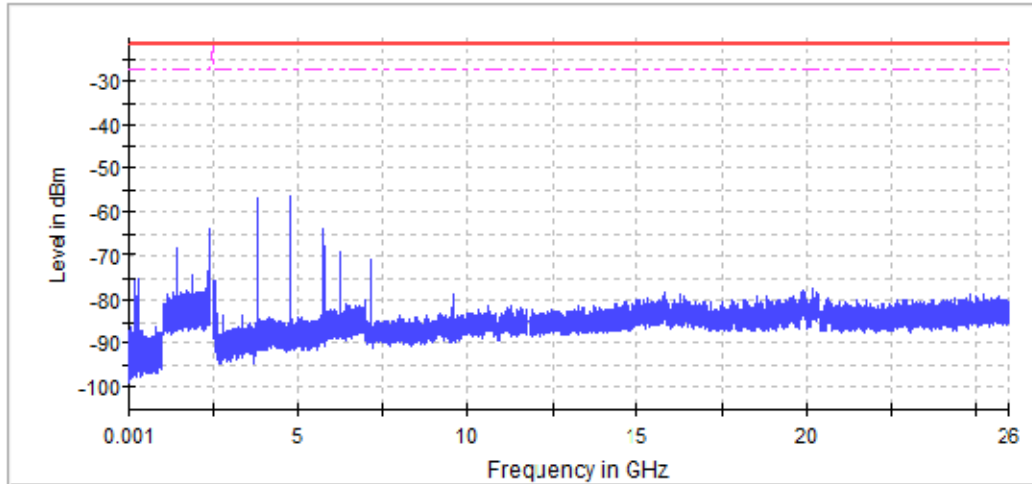

— Limit    — Sum Level    - - - Threshold    × Critical    × Final Critical

DUT Frequency (MHz)	Result
2402.000000	PASS

Frequency (MHz)	Level (dBm)	Margin (dB)	Limit (dBm)
4803.567662	-56.6	35.1	-21.5
3843.276859	-56.7	35.2	-21.5
4804.555615	-58.0	36.6	-21.5
4803.849934	-58.3	36.8	-21.5
3843.700267	-58.4	36.9	-21.5
3843.135722	-58.9	37.4	-21.5
3843.559131	-59.6	38.1	-21.5
4804.414479	-61.3	39.8	-21.5
4803.426526	-62.1	40.6	-21.5
4803.991071	-62.9	41.4	-21.5
4804.132207	-63.0	41.5	-21.5
4804.273343	-63.1	41.6	-21.5
4803.708798	-63.4	42.0	-21.5
5743.534850	-63.8	42.3	-21.5
2399.925000	-63.8	42.3	-21.5

Start Frequency (MHz)	Stop Frequency (MHz)	Pre Measurement	Final Measurement
1.000000	1000.000000	1	1
1000.000000	2400.000000	2	2
2483.500000	7000.000000	2	2
7000.000000	18000.000000	2	2
18000.000000	26000.000000	2	2

## TEST REPORT

### Pre Measurement 1

Setting	Instrument Value	Target Value
RBW	100.000 kHz	<= 100.000 kHz
VBW	300.000 kHz	>= 300.000 kHz
SweepPoints	19980	~ 19980
SweepTime	20.000 ms	AUTO
Reference Level	-30.000 dBm	-30.000 dBm
Attenuation	0.000 dB	AUTO
Detector	Peak	Peak
SweepCount	30	30
Filter	3 dB	3 dB
Trace Mode	Max Hold	Max Hold
SweepType	Sweep	AUTO
Preamp	off	off
Stablemode	Trace	Trace
Stablevalue	0.50 dB	0.50 dB
Run	1 / max. 1	max. 1
Stable	0 / 1	1
Max Stable Difference	0.00 dB	0.50 dB

### Pre Measurement 2

Setting	Instrument Value	Target Value
RBW	100.000 kHz	<= 100.000 kHz
VBW	300.000 kHz	>= 300.000 kHz
SweepPoints	28000	~ 28000
SweepTime	28.000 ms	AUTO
Reference Level	-20.000 dBm	-30.000 dBm
Attenuation	10.000 dB	AUTO
Detector	Peak	Peak
SweepCount	30	30
Filter	3 dB	3 dB
Trace Mode	Max Hold	Max Hold
SweepType	Sweep	AUTO
Preamp	off	off
Stablemode	Trace	Trace
Stablevalue	0.50 dB	0.50 dB
Run	1 / max. 1	max. 1
Stable	0 / 3	3
Max Stable Difference	0.00 dB	0.50 dB

**TEST REPORT**

**PLOTS OF OUT OF BAND CONDUCTED EMISSIONS**

BLE, Middle Channel, Plot A

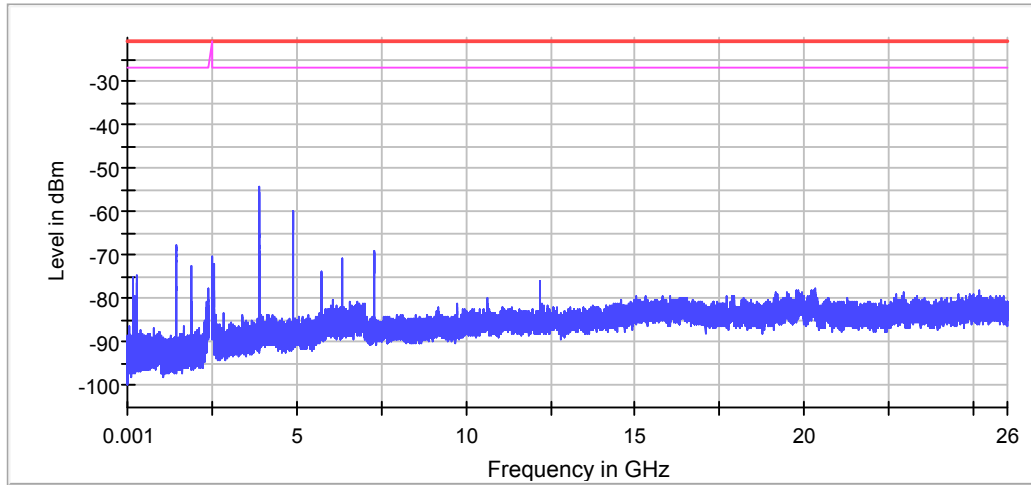

— Limit    — Sum Level    — Threshold    × Critical    × Final Critical

DUT Frequency (MHz)	Result
2440.000000	PASS

Frequency (MHz)	Level (dBm)	Margin (dB)	Limit (dBm)
3904.106567	-54.2	33.5	-20.7
3904.529976	-55.5	34.8	-20.7
3903.965431	-55.5	34.8	-20.7
3904.671112	-56.1	35.4	-20.7
3904.247703	-59.0	38.2	-20.7
4879.922354	-59.9	39.1	-20.7
4880.486899	-60.1	39.3	-20.7
4879.781218	-60.2	39.4	-20.7
4880.628035	-61.2	40.5	-20.7
4880.063490	-61.2	40.5	-20.7
4879.640082	-61.6	40.9	-20.7
4879.498945	-62.0	41.2	-20.7
3903.824295	-62.3	41.5	-20.7
3903.683158	-63.6	42.8	-20.7
4880.204626	-63.8	43.1	-20.7

Start Frequency (MHz)	Stop Frequency (MHz)	Pre Measurement	Final Measurement
1.000000	1000.000000	1	1
1000.000000	2400.000000	2	2
2483.500000	7000.000000	2	2
7000.000000	18000.000000	2	2
18000.000000	26000.000000	2	2

## TEST REPORT

### Pre Measurement 1

Setting	Instrument Value	Target Value
RBW	100.000 kHz	<= 100.000 kHz
VBW	300.000 kHz	>= 300.000 kHz
SweepPoints	19980	~ 19980
SweepTime	20.000 ms	AUTO
Reference Level	-30.000 dBm	-30.000 dBm
Attenuation	0.000 dB	AUTO
Detector	Peak	Peak
SweepCount	30	30
Filter	3 dB	3 dB
Trace Mode	Max Hold	Max Hold
SweepType	Sweep	AUTO
Preamp	off	off
Stablemode	Trace	Trace
Stablevalue	0.50 dB	0.50 dB
Run	1 / max. 1	max. 1
Stable	0 / 1	1
Max Stable Difference	0.00 dB	0.50 dB

### Pre Measurement 2

Setting	Instrument Value	Target Value
RBW	100.000 kHz	<= 100.000 kHz
VBW	300.000 kHz	>= 300.000 kHz
SweepPoints	28000	~ 28000
SweepTime	28.000 ms	AUTO
Reference Level	-30.000 dBm	-30.000 dBm
Attenuation	0.000 dB	AUTO
Detector	Peak	Peak
SweepCount	30	30
Filter	3 dB	3 dB
Trace Mode	Max Hold	Max Hold
SweepType	Sweep	AUTO
Preamp	off	off
Stablemode	Trace	Trace
Stablevalue	0.50 dB	0.50 dB
Run	1 / max. 1	max. 1
Stable	0 / 3	3
Max Stable Difference	0.00 dB	0.50 dB

**TEST REPORT**

**PLOTS OF OUT OF BAND CONDUCTED EMISSIONS**

BLE, Highest Channel, Plot A

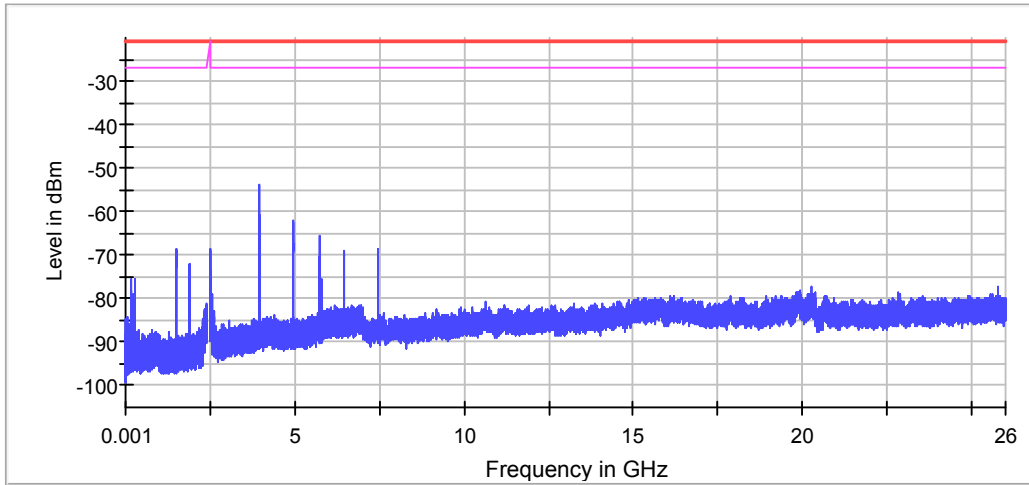

— Limit    — Sum Level    — Threshold    × Critical    × Final Critical

DUT Frequency (MHz)	Result
2480.000000	PASS

Frequency (MHz)	Level (dBm)	Margin (dB)	Limit (dBm)
3968.041272	-53.8	32.8	-20.9
3968.182408	-58.7	37.7	-20.9
3956.891511	-60.7	39.7	-20.9
3955.056740	-60.9	40.0	-20.9
3955.197877	-61.0	40.1	-20.9
3956.750375	-61.3	40.4	-20.9
4959.523179	-62.0	41.1	-20.9
4960.511132	-62.3	41.4	-20.9
3957.032647	-63.7	42.7	-20.9
3967.900136	-64.0	43.1	-20.9
3955.339013	-64.7	43.7	-20.9
3967.335591	-65.1	44.1	-20.9
4960.652269	-65.1	44.2	-20.9
3967.476727	-65.5	44.6	-20.9
5747.486664	-65.6	44.7	-20.9

**Measurement Settings**

Start Frequency (MHz)	Stop Frequency (MHz)	Pre Measurement	Final Measurement
1.000000	1000.000000	1	1
1000.000000	2400.000000	2	2
2483.500000	7000.000000	2	2
7000.000000	18000.000000	2	2
18000.000000	26000.000000	2	2

## TEST REPORT

### Pre Measurement 1

Setting	Instrument Value	Target Value
RBW	100.000 kHz	<= 100.000 kHz
VBW	300.000 kHz	>= 300.000 kHz
SweepPoints	19980	~ 19980
SweepTime	20.000 ms	AUTO
Reference Level	-30.000 dBm	-30.000 dBm
Attenuation	0.000 dB	AUTO
Detector	Peak	Peak
SweepCount	30	30
Filter	3 dB	3 dB
Trace Mode	Max Hold	Max Hold
SweepType	Sweep	AUTO
Preamp	off	off
Stablemode	Trace	Trace
Stablevalue	0.50 dB	0.50 dB
Run	1 / max. 1	max. 1
Stable	0 / 1	1
Max Stable Difference	0.00 dB	0.50 dB

### Pre Measurement 2

Setting	Instrument Value	Target Value
RBW	100.000 kHz	<= 100.000 kHz
VBW	300.000 kHz	>= 300.000 kHz
SweepPoints	28000	~ 28000
SweepTime	28.000 ms	AUTO
Reference Level	-30.000 dBm	-30.000 dBm
Attenuation	0.000 dB	AUTO
Detector	Peak	Peak
SweepCount	30	30
Filter	3 dB	3 dB
Trace Mode	Max Hold	Max Hold
SweepType	Sweep	AUTO
Preamp	off	off
Stablemode	Trace	Trace
Stablevalue	0.50 dB	0.50 dB
Run	1 / max. 1	max. 1
Stable	0 / 3	3
Max Stable Difference	0.00 dB	0.50 dB



## TEST REPORT

### 4.5 Field Strength Calculation

The field strength is calculated by adding the reading on the Spectrum Analyzer to the factors associated with preamplifiers (if any), antennas, cables, pulse desensitization and average factors (when specified limit is in average and measurements are made with peak detectors). A sample calculation is included below.

$$FS = RA + AF + CF - AG + PD + AV$$

Where FS = Field Strength in dB $\mu$ V/m

RA = Receiver Amplitude (including preamplifier) in dB $\mu$ V

CF = Cable Attenuation Factor in dB

AF = Antenna Factor in dB

AG = Amplifier Gain in dB

PD = Pulse Desensitization in dB

AV = Average Factor in -dB

In the radiated emission table which follows, the reading shown on the data table may reflect the preamplifier gain. An example of the calculations, where the reading does not reflect the preamplifier gain, follows:

$$FS = RA + AF + CF - AG + PD + AV$$

#### Example

Assume a receiver reading of 62.0 dB $\mu$ V is obtained. The antenna factor of 7.4 dB and cable factor of 1.6 dB is added. The amplifier gain of 29.0 dB is subtracted. The pulse desensitization factor of the spectrum analyzer is 0.0 dB, and the resultant average factor is -10.0 dB. The net field strength for comparison to the appropriate emission limit is 32.0 dB $\mu$ V/m. This value in dB $\mu$ V/m is converted to its corresponding level in  $\mu$ V/m.

$$RA = 62.0 \text{ dB}\mu\text{V}$$

$$AF = 7.4 \text{ dB}$$

$$CF = 1.6 \text{ dB}$$

$$AG = 29.0 \text{ dB}$$

$$PD = 0.0 \text{ dB}$$

$$AV = -10 \text{ dB}$$

$$FS = 62.0 + 7.4 + 1.6 - 29.0 + 0.0 + (-10.0) = 32.0 \text{ dB}\mu\text{V/m}$$

$$\text{Level in } \mu\text{V/m} = \text{Common Antilogarithm } [(32.0 \text{ dB}\mu\text{V/m})/20] = 39.8 \mu\text{V/m}$$

## TEST REPORT

### 4.6 Transmitter Radiated Emissions in Restricted Bands and Spurious Emissions

Data is included of the worst case configuration (the configuration which resulted in the highest emission levels). A sample calculation, configuration photographs and data tables of the emissions are included.

The data on the following pages list the significant emission frequencies, the limit and the margin of compliance.

#### 4.6.1 Radiated Emission Configuration Photograph

Worst Case Restricted Band Radiated Emission  
at

361.726 MHz

The worst case radiated emission configuration photographs are saved with filename: config photos.pdf

#### 4.6.2 Radiated Emission Data

The data in tables 1-4 list the significant emission frequencies, the limit and the margin of compliance.

Judgement -

Passed by 3.2 dB margin

**TEST REPORT**

**RADIATED EMISSION DATA**

Mode: Pika only  
TX-2402MHz

Table 1

Polarization	Frequency (MHz)	Reading (dBµV)	Pre-Amp Gain (dB)	Antenna Factor (dB)	Net at 3m (dBµV/m)	Average Factor (dB)	Calculated at 3m (dBµV/m)	Average Limit at 3m (dBµV/m)	Margin (dB)
H	2390.000	45.3	33	29.4	41.7	0	41.7	54.0	-12.3
V	4804.000	40.7	33	34.9	42.6	0	42.6	54.0	-11.4
H	7206.000	29.3	33	37.9	34.2	0	34.2	54.0	-19.8
V	9608.000	30.7	33	40.4	38.1	0	38.1	54.0	-15.9
H	12010.000	33.1	33	40.5	40.6	0	40.6	54.0	-13.4
V	14412.000	36.5	33	40.0	43.5	0	43.5	54.0	-10.5

Polarization	Frequency (MHz)	Reading (dBµV)	Pre-Amp Gain (dB)	Antenna Factor (dB)	Net at 3m - Peak (dBµV/m)	Peak Limit at 3m (dBµV/m)	Margin (dB)
H	2390.000	53.0	33	29.4	49.4	74.0	-24.6
V	4804.000	41.1	33	34.9	43.0	74.0	-31.0
H	7206.000	40.6	33	37.9	45.5	74.0	-28.5
V	9608.000	38.2	33	40.4	45.6	74.0	-28.4
H	12010.000	45.9	33	40.5	53.4	74.0	-20.6
V	14412.000	46.4	33	40.0	53.4	74.0	-20.6

- NOTES:
1. Peak detector is used for the emission measurement.
  2. Average detector is used for the average data of emission measurement.
  3. All measurements were made at 3 meters. Radiated emissions not detected at the 3-meter distance were measured at 0.3-meter and an inverse proportional extrapolation was performed to compare the signal level to the 3-meter limit. No other radiated emissions than those reported were detected at a test distance of 0.3-meter.
  4. Negative value in the margin column shows emission below limit.
  5. Horn antenna is used for the emission over 1000MHz.
  6. Emission (the row indicated by ***bold italic***) within the restricted band meets the requirement of FCC Part 15 Section 15.205.

**TEST REPORT**

Mode: Pika only  
TX-2440MHz

Table 2

Polarization	Frequency (MHz)	Reading (dBµV)	Pre-Amp Gain (dB)	Antenna Factor (dB)	Net at 3m (dBµV/m)	Average Factor (dB)	Calculated at 3m (dBµV/m)	Average Limit at 3m (dBµV/m)	Margin (dB)
V	4880.000	28.9	33	34.9	30.8	0	30.8	54.0	-23.2
V	7320.000	28.7	33	37.9	33.6	0	33.6	54.0	-20.4
V	9760.000	29.0	33	40.4	36.4	0	36.4	54.0	-17.6
H	12200.000	32.7	33	40.5	40.2	0	40.2	54.0	-13.8
V	14640.000	37.6	33	38.4	43.0	0	43.0	54.0	-11.0

Polarization	Frequency (MHz)	Reading (dBµV)	Pre-Amp Gain (dB)	Antenna Factor (dB)	Net at 3m - Peak (dBµV/m)	Peak Limit at 3m (dBµV/m)	Margin (dB)
V	4880.000	40.1	33	34.9	42.0	74.0	-32.0
V	7320.000	39.9	33	37.9	44.8	74.0	-29.2
V	9760.000	41.5	33	40.4	48.9	74.0	-25.1
H	12200.000	45.1	33	40.5	52.6	74.0	-21.4
V	14640.000	47.4	33	38.4	52.8	74.0	-21.2

- NOTES:
1. Peak detector is used for the emission measurement.
  2. Average detector is used for the average data of emission measurement
  3. All measurements were made at 3 meters. Radiated emissions not detected at the 3-meter distance were measured at 0.3-meter and an inverse proportional extrapolation was performed to compare the signal level to the 3-meter limit. No other radiated emissions than those reported were detected at a test distance of 0.3-meter.
  4. Negative value in the margin column shows emission below limit.
  5. Horn antenna is used for the emission over 1000MHz.
  6. Emission (the row indicated by ***bold italic***) within the restricted band meets the requirement of FCC Part 15 Section 15.205.

**TEST REPORT**

Mode: Pika only  
TX-2480MHz

Table 3

Polarization	Frequency (MHz)	Reading (dBµV)	Pre-Amp Gain (dB)	Antenna Factor (dB)	Net at 3m (dBµV/m)	Average Factor (dB)	Calculated at 3m (dBµV/m)	Average Limit at 3m (dBµV/m)	Margin (dB)
V	2483.500	51.8	33	29.4	48.2	0	48.2	54.0	-5.8
V	4960.000	29.3	33	34.9	31.2	0	31.2	54.0	-22.8
V	7440.000	28.9	33	37.9	33.8	0	33.8	54.0	-20.2
H	9920.000	29.7	33	40.4	37.1	0	37.1	54.0	-16.9
V	12400.000	33.3	33	40.5	40.8	0	40.8	54.0	-13.2
V	14880.000	37.2	33	38.4	42.6	0	42.6	54.0	-11.4

Polarization	Frequency (MHz)	Reading (dBµV)	Pre-Amp Gain (dB)	Antenna Factor (dB)	Net at 3m - Peak (dBµV/m)	Peak Limit at 3m (dBµV/m)	Margin (dB)
V	2483.500	64.9	33	29.4	61.3	74.0	-12.7
V	4960.000	41.4	33	34.9	43.3	74.0	-30.7
V	7440.000	41.9	33	37.9	46.8	74.0	-27.2
H	9920.000	43.2	33	40.4	50.6	74.0	-23.4
V	12400.000	45.6	33	40.5	53.1	74.0	-20.9
V	14880.000	48.4	33	38.4	53.8	74.0	-20.2

- NOTES:
1. Peak detector is used for the emission measurement.
  2. Average detector is used for the average data of emission measurement
  3. All measurements were made at 3 meters. Radiated emissions not detected at the 3-meter distance were measured at 0.3-meter and an inverse proportional extrapolation was performed to compare the signal level to the 3-meter limit. No other radiated emissions than those reported were detected at a test distance of 0.3-meter.
  4. Negative value in the margin column shows emission below limit.
  5. Horn antenna is used for the emission over 1000MHz.
  6. Emission (the row indicated by ***bold italic***) within the restricted band meets the requirement of FCC Part 15 Section 15.205.

**TEST REPORT**

Mode: Pika BLE + USB Dongle Bluetooth 3.0  
TX-2402MHz

Table 4

Polarization	Frequency (MHz)	Reading (dBµV)	Pre-Amp Gain (dB)	Antenna Factor (dB)	Net at 3m (dBµV/m)	Average Factor (dB)	Calculated at 3m (dBµV/m)	Average Limit at 3m (dBµV/m)	Margin (dB)
H	2390.000	34.8	33	29.4	31.2	0	31.2	54.0	-22.8
V	4804.000	29.4	33	34.9	31.3	0	31.3	54.0	-22.7
H	7206.000	29.3	33	37.9	34.2	0	34.2	54.0	-19.8
V	9608.000	30.7	33	40.4	38.1	0	38.1	54.0	-15.9
H	12010.000	33.1	33	40.5	40.6	0	40.6	54.0	-13.4
V	14412.000	36.5	33	40.0	43.5	0	43.5	54.0	-10.5

Polarization	Frequency (MHz)	Reading (dBµV)	Pre-Amp Gain (dB)	Antenna Factor (dB)	Net at 3m - Peak (dBµV/m)	Peak Limit at 3m (dBµV/m)	Margin (dB)
H	2390.000	46.2	33	29.4	42.6	74.0	-31.4
V	4804.000	39.7	33	34.9	41.6	74.0	-32.4
H	7206.000	40.6	33	37.9	45.5	74.0	-28.5
V	9608.000	38.2	33	40.4	45.6	74.0	-28.4
H	12010.000	45.9	33	40.5	53.4	74.0	-20.6
V	14412.000	46.4	33	40.0	53.4	74.0	-20.6

- NOTES:
1. Peak detector is used for the emission measurement.
  2. Average detector is used for the average data of emission measurement.
  3. All measurements were made at 3 meters. Radiated emissions not detected at the 3-meter distance were measured at 0.3-meter and an inverse proportional extrapolation was performed to compare the signal level to the 3-meter limit. No other radiated emissions than those reported were detected at a test distance of 0.3-meter.
  4. Negative value in the margin column shows emission below limit.
  5. Horn antenna is used for the emission over 1000MHz.
  6. Emission (the row indicated by **bold italic**) within the restricted band meets the requirement of FCC Part 15 Section 15.205.

## TEST REPORT

Mode: Pika BLE + USB Dongle Bluetooth 3.0  
TX-2442MHz

Table 5

Polarization	Frequency (MHz)	Reading (dBμV)	Pre-Amp Gain (dB)	Antenna Factor (dB)	Net at 3m (dBμV/m)	Average Factor (dB)	Calculated at 3m (dBμV/m)	Average Limit at 3m (dBμV/m)	Margin (dB)
V	4880.000	28.9	33	34.9	30.8	0	30.9	54.0	-23.2
V	7320.000	28.7	33	37.9	33.6	0	34.4	54.0	-19.6
V	9760.000	29.0	33	40.4	36.4	0	36.4	54.0	-17.6
H	12200.000	32.7	33	40.5	40.2	0	40.2	54.0	-13.8
V	14640.000	37.6	33	38.4	43.0	0	43.0	54.0	-11.0

Polarization	Frequency (MHz)	Reading (dBμV)	Pre-Amp Gain (dB)	Antenna Factor (dB)	Net at 3m - Peak (dBμV/m)	Peak Limit at 3m (dBμV/m)	Margin (dB)
V	4880.000	42.9	33	34.9	44.8	74.0	-29.2
V	7320.000	43.1	33	37.9	48.0	74.0	-26.0
V	9760.000	41.5	33	40.4	48.9	74.0	-25.1
H	12200.000	45.1	33	40.5	52.6	74.0	-21.4
V	14640.000	47.4	33	38.4	52.8	74.0	-21.2

- NOTES:
1. Peak detector is used for the emission measurement.
  2. Average detector is used for the average data of emission measurement.
  3. All measurements were made at 3 meters. Radiated emissions not detected at the 3-meter distance were measured at 0.3-meter and an inverse proportional extrapolation was performed to compare the signal level to the 3-meter limit. No other radiated emissions than those reported were detected at a test distance of 0.3-meter.
  4. Negative value in the margin column shows emission below limit.
  5. Horn antenna is used for the emission over 1000MHz.
  6. Emission (the row indicated by ***bold italic***) within the restricted band meets the requirement of FCC Part 15 Section 15.205.

## TEST REPORT

Mode: Pika BLE + USB Dongle Bluetooth 3.0  
TX-2480MHz

Table 6

Polarization	Frequency (MHz)	Reading (dB $\mu$ V)	Pre-Amp Gain (dB)	Antenna Factor (dB)	Net at 3m (dB $\mu$ V/m)	Average Factor (dB)	Calculated at 3m (dB $\mu$ V/m)	Average Limit at 3m (dB $\mu$ V/m)	Margin (dB)
V	2483.500	51.8	33	29.4	48.2	0	40.3	54.0	-13.7
V	4960.000	29.3	33	34.9	31.2	0	37.0	54.0	-17.0
V	7440.000	28.9	33	37.9	33.8	0	33.8	54.0	-20.2
H	9920.000	29.7	33	40.4	37.1	0	37.1	54.0	-16.9
V	12400.000	33.3	33	40.5	40.8	0	40.8	54.0	-13.2
V	14880.000	37.2	33	38.4	42.6	0	42.6	54.0	-11.4

Polarization	Frequency (MHz)	Reading (dB $\mu$ V)	Pre-Amp Gain (dB)	Antenna Factor (dB)	Net at 3m - Peak (dB $\mu$ V/m)	Peak Limit at 3m (dB $\mu$ V/m)	Margin (dB)
V	2483.500	61.1	33	29.4	57.5	74.0	-16.5
V	4960.000	47.8	33	34.9	49.7	74.0	-24.3
V	7440.000	41.9	33	37.9	46.8	74.0	-27.2
H	9920.000	43.2	33	40.4	50.6	74.0	-23.4
V	12400.000	45.6	33	40.5	53.1	74.0	-20.9
V	14880.000	48.4	33	38.4	53.8	74.0	-20.2

- NOTES:
1. Peak detector is used for the emission measurement.
  2. Average detector is used for the average data of emission measurement.
  3. All measurements were made at 3 meters. Radiated emissions not detected at the 3-meter distance were measured at 0.3-meter and an inverse proportional extrapolation was performed to compare the signal level to the 3-meter limit. No other radiated emissions than those reported were detected at a test distance of 0.3-meter.
  4. Negative value in the margin column shows emission below limit.
  5. Horn antenna is used for the emission over 1000MHz.
  6. Emission (the row indicated by ***bold italic***) within the restricted band meets the requirement of FCC Part 15 Section 15.205.



## TEST REPORT

Mode: Pika BLE + USB Dongle Bluetooth BLE  
TX-2402MHz

Table 7

Polarization	Frequency (MHz)	Reading (dB $\mu$ V)	Pre-Amp Gain (dB)	Antenna Factor (dB)	Net at 3m (dB $\mu$ V/m)	Average Factor (dB)	Calculated at 3m (dB $\mu$ V/m)	Average Limit at 3m (dB $\mu$ V/m)	Margin (dB)
H	2390.000	41.4	33	29.4	37.8	0	37.8	54.0	-16.2
V	4804.000	30.3	33	34.9	32.2	0	32.2	54.0	-21.8
H	7206.000	29.3	33	37.9	34.2	0	34.2	54.0	-19.8
V	9608.000	30.7	33	40.4	38.1	0	38.1	54.0	-15.9
H	12010.000	33.1	33	40.5	40.6	0	40.6	54.0	-13.4
V	14412.000	36.5	33	40.0	43.5	0	43.5	54.0	-10.5

Polarization	Frequency (MHz)	Reading (dB $\mu$ V)	Pre-Amp Gain (dB)	Antenna Factor (dB)	Net at 3m - Peak (dB $\mu$ V/m)	Peak Limit at 3m (dB $\mu$ V/m)	Margin (dB)
H	2390.000	54.0	33	29.4	50.4	74.0	-23.6
V	4804.000	40.7	33	34.9	42.6	74.0	-31.4
H	7206.000	40.6	33	37.9	45.5	74.0	-28.5
V	9608.000	38.2	33	40.4	45.6	74.0	-28.4
H	12010.000	45.9	33	40.5	53.4	74.0	-20.6
V	14412.000	46.4	33	40.0	53.4	74.0	-20.6

- NOTES:
1. Peak detector is used for the emission measurement.
  2. Average detector is used for the average data of emission measurement.
  3. All measurements were made at 3 meters. Radiated emissions not detected at the 3-meter distance were measured at 0.3-meter and an inverse proportional extrapolation was performed to compare the signal level to the 3-meter limit. No other radiated emissions than those reported were detected at a test distance of 0.3-meter.
  4. Negative value in the margin column shows emission below limit.
  5. Horn antenna is used for the emission over 1000MHz.
  6. Emission (the row indicated by ***bold italic***) within the restricted band meets the requirement of FCC Part 15 Section 15.205.

**TEST REPORT**

Mode: Pika BLE + USB Dongle Bluetooth BLE  
TX-2442MHz

Table 8

Polarization	Frequency (MHz)	Reading (dBμV)	Pre-Amp Gain (dB)	Antenna Factor (dB)	Net at 3m (dBμV/m)	Average Factor (dB)	Calculated at 3m (dBμV/m)	Average Limit at 3m (dBμV/m)	Margin (dB)
V	4880.000	28.9	33	34.9	30.8	0	35.1	54.0	-18.9
V	7320.000	28.7	33	37.9	33.6	0	33.6	54.0	-20.4
V	9760.000	29.0	33	40.4	36.4	0	36.4	54.0	-17.6
H	12200.000	32.7	33	40.5	40.2	0	40.2	54.0	-13.8
V	14640.000	37.6	33	38.4	43.0	0	43.0	54.0	-11.0

Polarization	Frequency (MHz)	Reading (dBμV)	Pre-Amp Gain (dB)	Antenna Factor (dB)	Net at 3m - Peak (dBμV/m)	Peak Limit at 3m (dBμV/m)	Margin (dB)
V	4880.000	43.5	33	34.9	45.4	74.0	-28.6
V	7320.000	39.9	33	37.9	44.8	74.0	-29.2
V	9760.000	41.5	33	40.4	48.9	74.0	-25.1
H	12200.000	45.1	33	40.5	52.6	74.0	-21.4
V	14640.000	47.4	33	38.4	52.8	74.0	-21.2

- NOTES:
1. Peak detector is used for the emission measurement.
  2. Average detector is used for the average data of emission measurement.
  3. All measurements were made at 3 meters. Radiated emissions not detected at the 3-meter distance were measured at 0.3-meter and an inverse proportional extrapolation was performed to compare the signal level to the 3-meter limit. No other radiated emissions than those reported were detected at a test distance of 0.3-meter.
  4. Negative value in the margin column shows emission below limit.
  5. Horn antenna is used for the emission over 1000MHz.
  6. Emission (the row indicated by **bold italic**) within the restricted band meets the requirement of FCC Part 15 Section 15.205.

**TEST REPORT**

Mode: Pika BLE + USB Dongle Bluetooth BLE  
TX-2480MHz

Table 9

Polarization	Frequency (MHz)	Reading (dBμV)	Pre-Amp Gain (dB)	Antenna Factor (dB)	Net at 3m (dBμV/m)	Average Factor (dB)	Calculated at 3m (dBμV/m)	Average Limit at 3m (dBμV/m)	Margin (dB)
V	2483.500	51.8	33	29.4	48.2	0	41.0	54.0	-13.0
V	4960.000	29.3	33	34.9	31.2	0	38.3	54.0	-15.7
V	7440.000	28.9	33	37.9	33.8	0	33.8	54.0	-20.2
H	9920.000	29.7	33	40.4	37.1	0	37.1	54.0	-16.9
V	12400.000	33.3	33	40.5	40.8	0	40.8	54.0	-13.2
V	14880.000	37.2	33	38.4	42.6	0	42.6	54.0	-11.4

Polarization	Frequency (MHz)	Reading (dBμV)	Pre-Amp Gain (dB)	Antenna Factor (dB)	Net at 3m - Peak (dBμV/m)	Peak Limit at 3m (dBμV/m)	Margin (dB)
V	2483.500	62.2	33	29.4	58.6	74.0	-15.4
V	4960.000	45.1	33	34.9	47.0	74.0	-27.0
V	7440.000	41.9	33	37.9	46.8	74.0	-27.2
H	9920.000	43.2	33	40.4	50.6	74.0	-23.4
V	12400.000	45.6	33	40.5	53.1	74.0	-20.9
V	14880.000	48.4	33	38.4	53.8	74.0	-20.2

- NOTES:
1. Peak detector is used for the emission measurement.
  2. Average detector is used for the average data of emission measurement
  3. All measurements were made at 3 meters. Radiated emissions not detected at the 3-meter distance were measured at 0.3-meter and an inverse proportional extrapolation was performed to compare the signal level to the 3-meter limit. No other radiated emissions than those reported were detected at a test distance of 0.3-meter.
  4. Negative value in the margin column shows emission below limit.
  5. Horn antenna is used for the emission over 1000MHz.
  6. Emission (the row indicated by ***bold italic***) within the restricted band meets the requirement of FCC Part 15 Section 15.205.

**TEST REPORT**

Mode: On

Table 10

Polarization	Frequency (MHz)	Reading (dBμV)	Pre-amp (dB)	Antenna Factor (dB)	Net at 3m (dBμV/m)	Limit at 3m (dBμV/m)	Margin (dB)
V	47.328	26.1	16	11.0	21.1	40.0	-18.9
V	112.759	26.6	16	14.0	24.6	43.5	-18.9
V	120.254	38.3	16	14.0	36.3	43.5	-7.2
H	180.306	30.5	16	20.0	34.5	43.5	-9.0
H	240.534	35.5	16	19.0	38.5	46.0	-7.6
H	360.726	34.8	16	24.0	42.8	46.0	-3.2
H	371.220	31.3	16	24.0	39.3	46.0	-6.7
H	438.723	27.5	16	26.0	37.5	46.0	-8.5
V	941.447	22.3	16	33.0	39.3	46.0	-6.7

- NOTES:
1. Peak Detector Data unless otherwise stated.
  2. All measurements were made at 3 meters. Harmonic emissions not detected at the 3-meter distances were measured at 0.3-meter and an inverse proportional extrapolation was performed to compare the signal level to the 3-meter limit. No other harmonic emissions than those reported were detected at a test distance of 0.3-meter.
  3. Negative sign in the column shows value below limit.
  4. Horn antenna is used for the emission over 1000MHz.
  5. Emission (the row indicated by ***bold italic***) within the restricted band meets the requirement of FCC Part 15 Section 15.205.
  6. Measurement Uncertainty is ±5.3dB at a level of confidence of 95%.

## TEST REPORT

### 4.6.3 Radiated Emission Test Setup

The figure below shows the test setup, which is utilized to make these measurements.

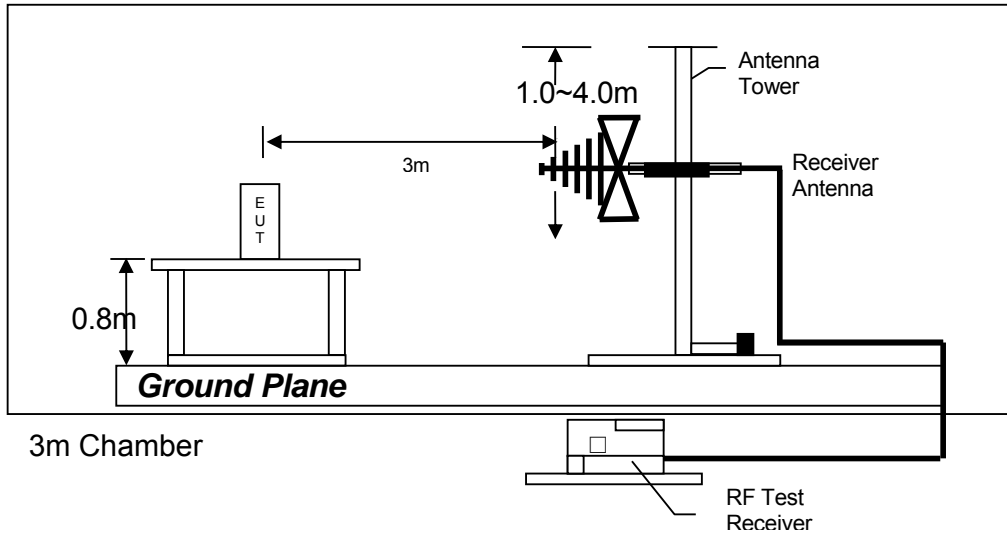

Test setup of radiated emissions up to 1GHz

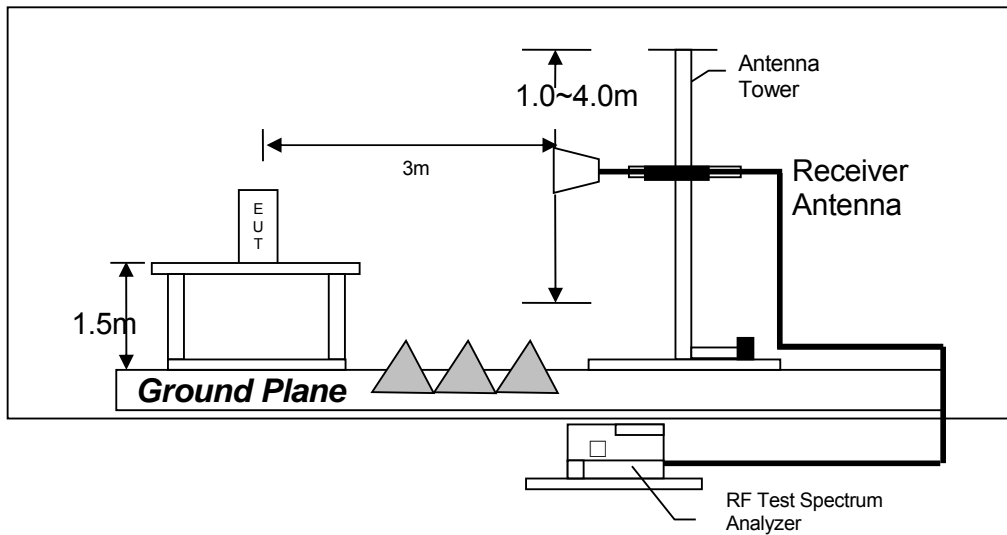

Test setup of radiated emissions above 1GHz

## TEST REPORT

### 4.6.4 Transmitter Duty Cycle Calculation

Not applicable – No average factor is required.

## TEST REPORT

### 4.7 AC Power Line Conducted Emission

- Not applicable – EUT is only powered by battery for operation.
- EUT connects to AC power line. Emission Data is listed in following pages.
  
- Base Unit connects to AC power line and has transmission. Handset connects to AC power line but has no transmission. Emission Data of Base Unit is listed in following pages.

#### 4.7.1 AC Power Line Conducted Emission Configuration Photograph

Worst Case Line-Conducted Configuration  
at

199.5 kHz

The worst case line conducted configuration photographs are attached in the Appendix and saved with filename: config photos.pdf

#### 4.7.2 AC Power Line Conducted Emission Data

The plot(s) and data in the following pages list the significant emission frequencies, the limit and the margin of compliance.

Passed by 8.31 dB margin compare with Quasi-peak limit

**TEST REPORT**

**AC POWER LINE CONDUCTED EMISSION**

Worst Case: Bluetooth on mode with full load



RBW 9 kHz  
MT 1 s

Att 10 dB AUTO PREAMP OFF

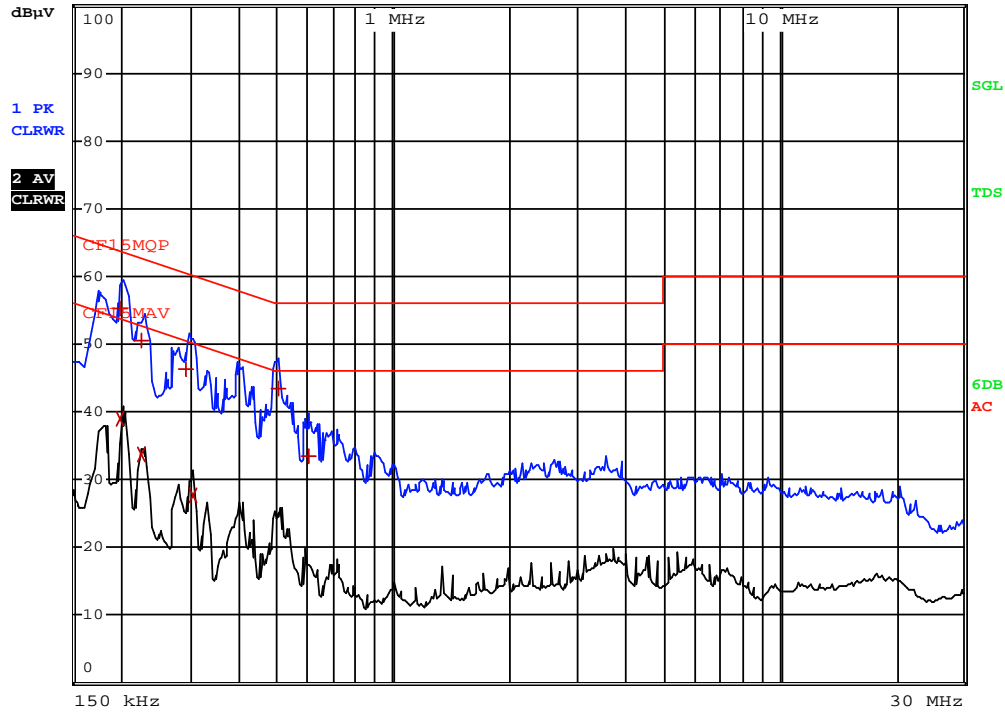



**TEST REPORT**

Worst Case: Bluetooth on mode with full load

EDIT PEAK LIST (Final Measurement Results)				
Trace1:	CF15MQP			
Trace2:	CF15MAV			
Trace3:	---			
TRACE	FREQUENCY	LEVEL dBμV		DELTA LIMIT dB
1 Quasi Peak	199.5 kHz	55.31 N		-8.31
2 CISPR Average	199.5 kHz	38.93 N		-14.69
1 Quasi Peak	226.5 kHz	50.42 N		-12.15
2 CISPR Average	226.5 kHz	33.73 N		-18.84
1 Quasi Peak	294 kHz	46.43 N		-13.97
2 CISPR Average	303 kHz	27.77 N		-22.38
1 Quasi Peak	505.5 kHz	43.42 N		-12.57
1 Quasi Peak	600 kHz	33.37 N		-22.62

## TEST REPORT

### 4.7.3 Conducted Emission Test Setup

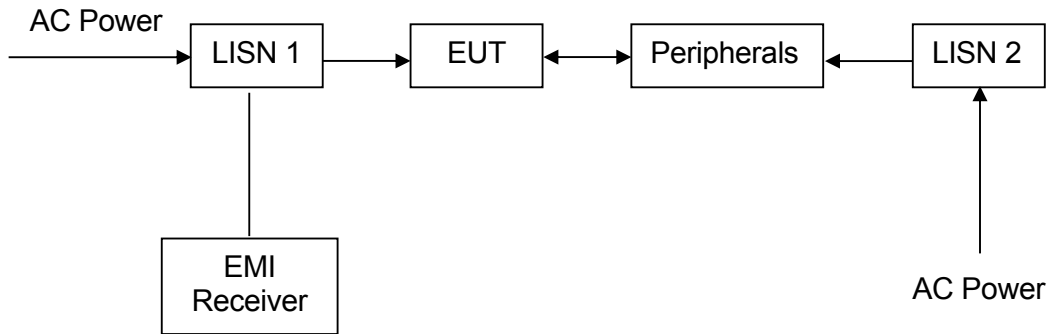

## TEST REPORT

### 5.0 EQUIPMENT LIST

#### 1) Radiated Emissions Test

Equipment	EMI Test Receiver	Spectrum Analyzer	Biconical Antenna
Registration No.	EW-3095	EW-2253	EW-0571
Manufacturer	R&S	R&S	EMCO
Model No.	ESCI	FSP40	3104C
Calibration Date	March 26, 2019	November 18, 2019	July 23, 2019
Calibration Due Date	March 26, 2020	November 18, 2020	July 23, 2021

Equipment	Log Periodic Antenna	Double Ridged Guide Antenna
Registration No.	EW-0447	EW-1133
Manufacturer	EMCO	EMCO
Model No.	3146	3115
Calibration Date	September 01, 2019	November 29, 2018
Calibration Due Date	September 01, 2021	May 29, 2020

#### 2) Conducted Emissions Test

Equipment	EMI Test Receiver	Artificial Mains Network
Registration No.	EW-3095	EW-2874
Manufacturer	R&S	R&S
Model No.	ESCI	ENV-216
Calibration Date	March 26, 2019	July 05, 2019
Calibration Due Date	March 26, 2020	July 05, 2020

#### 3) Conductive Measurement Test

Equipment	Spectrum Analyzer
Registration No.	EW-2253
Manufacturer	R&S
Model No.	FSP40
Calibration Date	November 18, 2019
Calibration Due Date	November 18, 2020

**END OF TEST REPORT**