

TEST REPORT

Test Report No.: 1-2242-02-03/10-B



Testing Laboratory

CETECOM ICT Services GmbH

Untertuerkheimer Straße 6 – 10
66117 Saarbruecken/Germany
Phone: + 49 681 5 98 - 0
Fax: + 49 681 5 98 - 9075
Internet: <http://www.cetecom-ict.de>
e-mail: ict@cetecom.com

Accredited Test Laboratory:

The test laboratory (area of testing) is accredited according to DIN EN ISO/IEC 17025
DAR registration number: DGA-PL-176/94-D1

Area of Testing: Radio Satellite Communications

Applicant

Plantronics Ltd

Interface Business Park, Bincknoll Lane
Wootton Bassett, Wiltshire SN4 8QQ / United Kingdom
Phone: +44 1793 84 89 99
Fax: +44 1793 84 2-399
Contact: Tim Davison
e-mail: tim.davison@plantronics.com
Phone: +44 1793 84 2-294

Manufacturer

Plantronics Inc

345 Encinal Street
Santa Cruz, CA95060 7 USA

Test Standard/s

47 CFR Part 15	Title 47 of the Code of Federal Regulations; Chapter I-Federal Communications Commission subchapter A - general, Part 15-Radio frequency devices
RSS - 210 Issue 7	Spectrum Management and Telecommunications - Radio Standards Specification Low-power Licence-exempt Radiocommunication Devices (All Frequency Bands): Category I Equipment

For further applied test standards please refer to section 3 of this test report.

Test Item

Kind of test item:	Bluetooth® USB dongle with indicator light
Model name:	BT300
FCC ID:	AL8-BT300
IC:	457A-BT300
Frequency [MHz]:	ISM-band 2400 – 2483.5 MHz (2402 – 2480 MHz)
Power supply:	5.0V DC via USB
Temperature range:	0 °C to 50 °C

Test performed:

Stefan Bös

Test Report authorised:

Jörg Warken

1 Table of contents

1 Table of contents2

2 General information3

 2.1 Notes.....3

 2.2 Application details.....3

3 Test standard/s3

4 Test environment.....3

5 Test item4

6 Test laboratories sub-contracted4

7 Host equipment4

8 Summary of measurement results5

9 RF measurement testing.....6

 9.1 Description of test setup6

 9.1.1 Radiated measurements.....6

 9.1.2 Conducted measurements.....7

 9.2 Additional comments7

 9.3 RSP100 test report cover sheet / performance test data8

10 Measurement results9

 10.1 Antenna gain9

 10.2 Power spectral density10

 10.3 Carrier frequency separation.....11

 10.4 Number of hopping channels13

 10.5 Time of occupancy (Dwell Time)15

 10.6 Spectrum bandwidth of a FHSS System – 20 dB bandwidth17

 10.7 Maximum output power.....23

 10.8 Band edge compliance conducted30

 10.9 Band edge compliance radiated.....38

 10.10 TX spurious emissions conducted46

 10.11 TX spurious emissions radiated.....52

 10.12 TX spurious emissions radiated < 30 MHz61

11 Test equipment and ancillaries used for tests63

12 Photographs of the test setup65

13 External photographs of the EUT65

14 Internal photographs of the EUT65

15 Document history65

16 Further information65

2 General information

2.1 Notes

The test results of this test report relate exclusively to the test item specified in this test report. CETECOM ICT Services GmbH does not assume responsibility for any conclusions and generalisations drawn from the test results with regard to other specimens or samples of the type of the equipment represented by the test item. The test report may only be reproduced or published in full. Reproduction or publication of extracts from the report requires the prior written approval of CETECOM ICT Services GmbH.

This test report is electronically signed and valid without handwriting signature. For verification of the electronic signatures, the public keys can be requested at the testing laboratory.

2.2 Application details

Date of receipt of order:	2010-05-28
Date of receipt of test item:	2010-06-01
Start of test:	2010-06-01
End of test:	2010-09-23
Person(s) present during the test:	Mr. Tim Davison

3 Test standard/s

Test Standard	Version	Test Standard Description
47 CFR Part 15	2009-10	Title 47 of the Code of Federal Regulations; Chapter I-Federal Communications Commission subchapter A - general, Part 15-Radio frequency devices
RSS - 210 Issue 7	2007-06	Spectrum Management and Telecommunications - Radio Standards Specification Low-power Licence-exempt Radiocommunication Devices (All Frequency Bands): Category I Equipment

4 Test environment

Temperature:	T_{nom}	23 °C during room temperature tests
	T_{max}	50 °C during high temperature test
	T_{min}	0 °C during low temperature test
Relative humidity content:		53 %
Air pressure:		not relevant for this kind of testing
Power supply:	V_{nom}	5.0 V DC via USB
	V_{max}	5.25 V
	V_{min}	4.35 V

5 Test item

Kind of test item	:	Bluetooth® USB dongle with indicator light
Type identification	:	BT300
S/N serial number	:	Cond.: 0003892BB523 Rad.: 0003892BB4E5
HW hardware status	:	Rev. 25
FW software status	:	Rev. 26
Frequency Band [MHz]	:	ISM-band 2400 – 2483.5 MHz (2402 – 2480 MHz)
Type of Modulation	:	GFSK, Pi/4-DQPSK, 8DPSK
Number of channels	:	79
Antenna	:	Integrated PCB-Antenna
Power Supply	:	5.0 V DC via USB
Temperature Range	:	0°C to 50 °C

Max. power radiated: 4.60 dBm

Max. power conducted: 2.85 dBm

6 Test laboratories sub-contracted

None

7 Host equipment

Laptop: DELL Inspiron mini 10 / Model 1010-5102

USB-Cable 0.8m

USB-mouse: Fujitsu SAJBL-0406

8 Summary of measurement results

- No deviations from the technical specifications were ascertained
- There were deviations from the technical specifications ascertained

TC Identifier	Description	Verdict	Date	Remark
RF-Testing	CFR Part 15 RSS 210, Issue 7, Annex 8 – ICES-003	Passed	2010-10-01	-/-

Test Specification Clause	Test Case	Temperature Conditions	Power Source Voltages	Mode	Pass	Fail	NA	NP	Result
§15.247(b)(4) RSS 210 / A8.4(2)	Antenna Gain	Nominal	Nominal	GFSK	<input checked="" type="checkbox"/>	<input type="checkbox"/>	<input type="checkbox"/>	<input type="checkbox"/>	complies
§15.247(e) RSS 210 / A8.2(b)	Power spectral density	Nominal	Nominal	GFSK Pi/4 DQPSK 8 DPSK	<input type="checkbox"/>	<input type="checkbox"/>	<input checked="" type="checkbox"/>	<input type="checkbox"/>	
§15.247(a)(1) RSS 210 / A8.1(b)	Carrier frequency separation	Nominal	Nominal	GFSK	<input checked="" type="checkbox"/>	<input type="checkbox"/>	<input type="checkbox"/>	<input type="checkbox"/>	complies
§15.247(a)(1) RSS 210 / A8.1(d)	Number of hopping channels	Nominal	Nominal	GFSK	<input checked="" type="checkbox"/>	<input type="checkbox"/>	<input type="checkbox"/>	<input type="checkbox"/>	complies
§15.247(a)(1)(iii) RSS 210 / A8.3(1)	Time of occupancy (dwell time)	Nominal	Nominal	GFSK Pi/4 DQPSK 8 DPSK	<input checked="" type="checkbox"/>	<input type="checkbox"/>	<input type="checkbox"/>	<input type="checkbox"/>	complies
§15.247(a)(1) RSS 210 / A8.2(a)	Spectrum bandwidth of a FHSS system 20dB bandwidth	Nominal	Nominal	GFSK Pi/4 DQPSK 8 DPSK	<input checked="" type="checkbox"/> <input checked="" type="checkbox"/> <input checked="" type="checkbox"/>	<input type="checkbox"/> <input type="checkbox"/> <input type="checkbox"/>	<input type="checkbox"/> <input type="checkbox"/> <input type="checkbox"/>	<input type="checkbox"/> <input type="checkbox"/> <input type="checkbox"/>	complies
§15.247(b)(1) RSS-210 / A8.4(2)	Maximum output power	Nominal	Nominal	GFSK Pi/4 DQPSK 8 DPSK	<input checked="" type="checkbox"/> <input checked="" type="checkbox"/> <input checked="" type="checkbox"/>	<input type="checkbox"/> <input type="checkbox"/> <input type="checkbox"/>	<input type="checkbox"/> <input type="checkbox"/> <input type="checkbox"/>	<input type="checkbox"/> <input type="checkbox"/> <input type="checkbox"/>	complies
§15.247(d) RSS-210 / A8.5	Band edge compliance conducted	Nominal	Nominal	GFSK Pi/4 DQPSK 8 DPSK	<input checked="" type="checkbox"/> <input checked="" type="checkbox"/> <input checked="" type="checkbox"/>	<input type="checkbox"/> <input type="checkbox"/> <input type="checkbox"/>	<input type="checkbox"/> <input type="checkbox"/> <input type="checkbox"/>	<input type="checkbox"/> <input type="checkbox"/> <input type="checkbox"/>	complies
§15.205 RSS-210 / A8.5	Band edge compliance radiated	Nominal	Nominal	GFSK Pi/4 DQPSK 8 DPSK	<input checked="" type="checkbox"/> <input checked="" type="checkbox"/> <input checked="" type="checkbox"/>	<input type="checkbox"/> <input type="checkbox"/> <input type="checkbox"/>	<input type="checkbox"/> <input type="checkbox"/> <input type="checkbox"/>	<input type="checkbox"/> <input type="checkbox"/> <input type="checkbox"/>	complies
§15.247(d) RSS-210 / A8.5	TX spurious emissions conducted	Nominal	Nominal	GFSK Pi/4 DQPSK 8 DPSK	<input checked="" type="checkbox"/> <input checked="" type="checkbox"/> <input checked="" type="checkbox"/>	<input type="checkbox"/> <input type="checkbox"/> <input type="checkbox"/>	<input type="checkbox"/> <input type="checkbox"/> <input type="checkbox"/>	<input type="checkbox"/> <input type="checkbox"/> <input type="checkbox"/>	complies
§15.247(d) RSS-210 / A8.5	TX spurious emissions radiated	Nominal	Nominal	GFSK	<input checked="" type="checkbox"/>	<input type="checkbox"/>	<input type="checkbox"/>	<input type="checkbox"/>	complies
§15.209(a) RSS-Gen	TX spurious emissions radiated < 30 MHz	Nominal	Nominal	GFSK	<input checked="" type="checkbox"/>	<input type="checkbox"/>	<input type="checkbox"/>	<input type="checkbox"/>	complies

Note: NA = Not Applicable; NP = Not Performed

9 RF measurement testing

9.1 Description of test setup

9.1.1 Radiated measurements

The radiated measurements are performed in vertical and horizontal plane in the frequency range from 9 kHz to 25 GHz in semi-anechoic chambers. The EUT is positioned on a non-conductive support with a height of 0.80 m above a conductive ground plane that covers the whole chamber. The receiving antennas are confirmed with specifications ANSI C63.2-1996 clause 15 and ANSI C63.4-2009 clause 4.1.5. These antennas can be moved over the height range between 1.0 m and 4.0 m in order to search for maximum field strength emitted from EUT. The measurement distances between EUT and receiving antennas are indicated in the test setups for the various frequency ranges. For each measurement, the EUT is rotated in all three axes until the maximum field strength is received. The wanted and unwanted emissions are received by spectrum analysers where the detector modes and resolution bandwidths over various frequency ranges are set according to requirement ANSI C63-4-2009 clause 4.2.

Antennas are confirmed with ANSI C63.2-1996 item 15.

Semi anechoic chamber

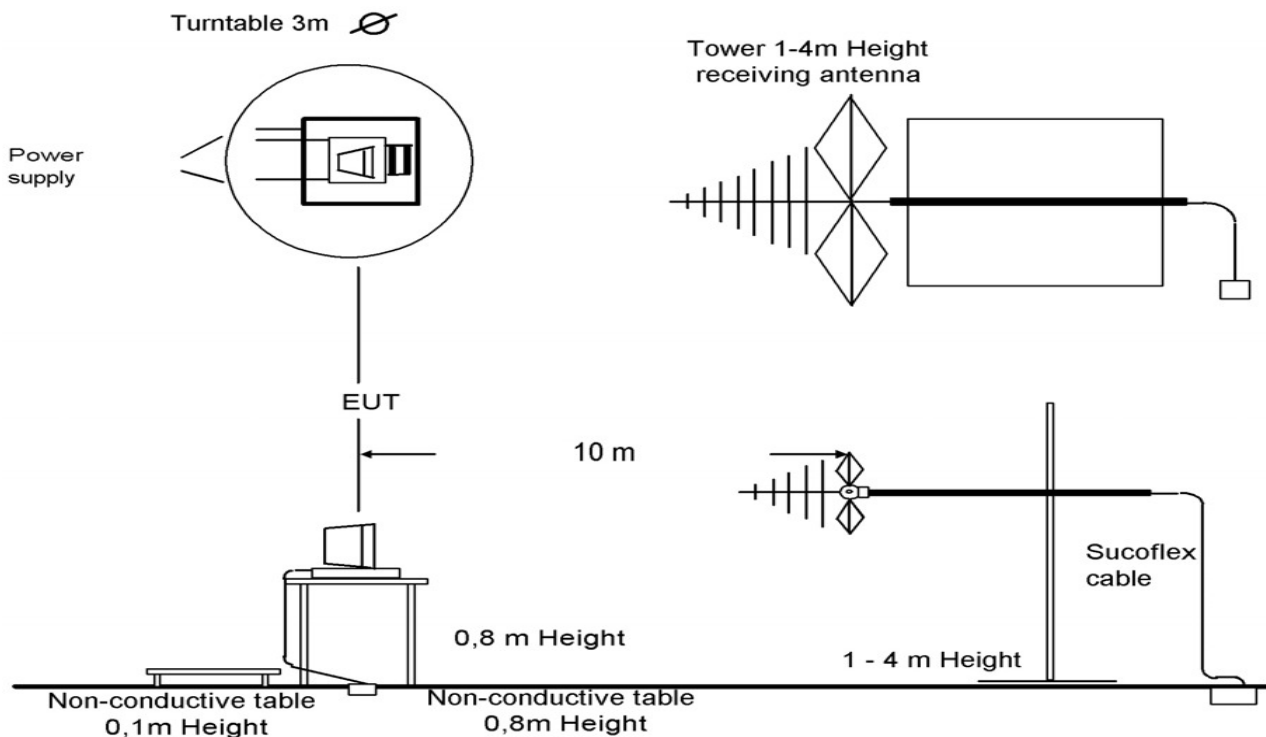

Picture 1: Diagram radiated measurements

9 kHz - 30 MHz:	active loop antenna
30 MHz – 1 GHz:	tri-log antenna
> 1 GHz:	horn antenna

All measurements are done in accordance with the Filing and Measurement Guidelines for Frequency Hopping Spread Spectrum Systems DA 00-705 and Appendix A "BLUETOOTH® APPROVALS". The EUT is powered by an external power supply with nominal voltage. The signalling is performed from outside the chamber with a signalling unit (CMU200 or other) by air link using signalling antenna.

9.1.2 Conducted measurements

The EUT's RF signal is coupled out by the antenna connector which is supplied by the manufacturer. The signal is first 10dB attenuated before it is power divided (~6dB loss per branch). One of the signal paths is connected to the communication base Station (CMU200 or other), the other one is connected to the spectrum analyzer. The specific losses for both signal paths are first checked within a calibration. The measurement readings on the signalling unit/spectrum analyzer are corrected by the specific test set-up loss. The attenuator, power divider, signalling unit and the spectrum analyzer are impedance matched on 50 Ohm.

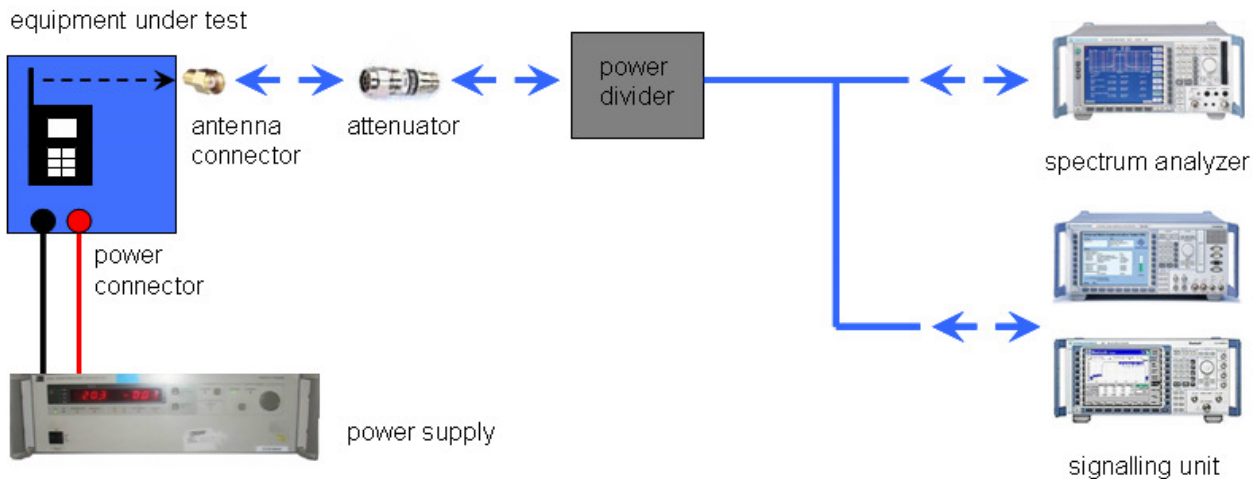

Picture 2: Diagram conducted measurements

9.2 Additional comments

Reference documents: This test report replaces the former version 1-2242-02-03_10 (2010-08-27).

Special test descriptions: None

Configuration descriptions: None

9.3 RSP100 test report cover sheet / performance test data

IC Registration Number	:	457A-BT300
Kind of test item	:	Bluetooth® USB dongle with indicator light
Type identification	:	BT300
Applicant (complete Address)	:	Plantronics Ltd Interface Business Park, Bincknoll Lane Wootton Bassett, Wiltshire SN4 8QQ / United Kingdom Phone: +44 1793 84 89 99 Fax: +44 1793 84 2-399
Frequency	:	2400 – 2483.5 MHz-band (2402 – 2480 MHz)
RF-power [W] (max.)	:	cond.: 1.93 m EIRP: 2.88 m
Antenna Type	:	Integrated PCB-Antenna
Occupied bandwidth (99%-BW) [kHz]	:	GFSK: 908 Pi/4-DQPSK: 1238 8DPSK: 1263
Type of modulation	:	GFSK; Pi/4-DQPSK; 8DPSK
Emission Designator (TRC-43)	:	1M13FXD / 79M0GXD (FHSS) for EDR
Number of channels	:	79
Power supply (normal)	:	5.0 V DC via USB
Transmitter Spurious (worst case) [$\mu\text{V}/\text{m}$ @ 3m]	:	248 $\mu\text{V}/\text{m}$ @ 4804 MHz (AVG)
Receiver Spurious (worst case) [$\mu\text{V}/\text{m}$ @ 3m]	:	1084 $\mu\text{V}/\text{m}$ @ 11824 MHz (Peak)
Open Area Test Site IC No.	:	IC 3462C-1
IC Standards	:	RSS 210, Issue 7, Annex 8

ATTESTATION: DECLARATION OF COMPLIANCE:

I attest that the testing was performed or supervised by me; that the test measurements were made in accordance with the above-mentioned Industry Canada standard(s); and that the equipment identified in this application has been subjected to all the applicable test conditions specified in the Industry Canada standards and all of the requirements of the standard have been met.

Laboratory Manager:

2010-10-01	Stefan Bös	
Date	Name	Signature

10 Measurement results

10.1 Antenna gain

Measurement:

The antenna gain of the complete system is calculated by the difference of radiated power in EIRP and the conducted power of the module. For normal Bluetooth® devices, the GFSK modulation is used.

Measurement parameters:

Measurement parameter	
Detector:	Peak
Sweep time:	Auto
Video bandwidth:	3 MHz
Resolution bandwidth:	3 MHz
Span:	5 MHz
Trace-Mode:	Max hold

Limits:

FCC	IC
CFR Part 15.247 (b)(4)	RSS 210, Issue 7, A 8.4(2)
Antenna Gain	
6 dBi	

Results:

T_{nom}	V_{nom}	lowest channel 2402 MHz	middle channel 2441 MHz	highest channel 2480 MHz
Conducted power [dBm] Measured with GFSK modulation		2.35	2.02	1.57
Radiated power [dBm] Measured with GFSK modulation		4.6	4.6	3.7
Gain [dBi] Calculated		2.25	2.58	2.13

Result: The result of the measurement is passed.

10.2 Power spectral density

Description:

Measurement of the power spectral density of a digital modulated system. This requirement is only valid for digitally modulated systems without hopping functionality.

Measurement:

Measurement parameter	
Detector:	Peak
Sweep time:	500 s
Video bandwidth:	10 kHz
Resolution bandwidth:	3 kHz
Span:	1.5 MHz
Trace-Mode:	Max Hold

Limits:

FCC	IC
CFR Part 15.247 (e)	RSS 210, Issue 7, A 8.2(b)
Power Spectral Density	
For digitally modulated systems the transmitter power spectral density conducted from the transmitter to the antenna shall not be greater than 8 dBm in any 3 kHz band during any time interval of continuous transmission or over 1.0 second if the transmission exceeds 1.0-second duration.	

Result:

Modulation	Power Spectral density [dBm/3kHz]		
	2402 MHz	2441 MHz	2480 MHz
Frequency			
GFSK	Not required for hopping systems !		
Pi/4 DQPSK			
8DPSK			
Measurement uncertainty	± 0.5 dB		

10.3 Carrier frequency separation

Description:

Measurement of the carrier frequency separation of a hopping system. The carrier frequency separation is constant for all modulation-modes. We use GFSK-modulation to show compliance. EUT in hopping mode.

Measurement:

Measurement parameter	
Detector:	Peak
Sweep time:	Auto
Video bandwidth:	100 kHz
Resolution bandwidth:	100 kHz
Span:	4 MHz
Trace-Mode:	Max Hold

Limits:

FCC	IC
CFR Part 15.247 (a)(1)	RSS 210, Issue 7, A 8.1(b)
Carrier Frequency Separation	
Minimum 25 kHz or two-thirds of the 20 dB bandwidth of the hopping system whichever is greater.	

Result:

Carrier Frequency Separation	~ 1 MHz
------------------------------	---------

Result: The result of the measurement is passed.

Plot 1: Carrier Frequency Separation (GFSK)

C.BER by Cetecom Saarbruecken Germany

Ref. Level Offset [dB]	Detector	SweepTime [s]
12.5	POS	2.5m

Video BW [Hz]	RBW [Hz]
100k	100000

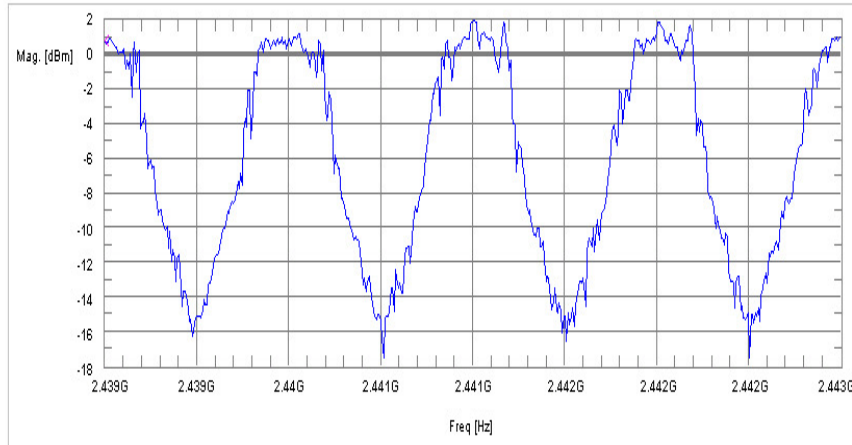

Start Freq [Hz]	Stop Freq [Hz]	TraceM.	Found Peak [dBm]	Found Peak [Hz]
2.439G	2.443G	MAXH	0.9612	2.439G

10.4 Number of hopping channels

Description:

Measurement of the total number of used hopping channels. The number of hopping channels is constant for all modulation-modes. We use GFSK-modulation to show compliance. EUT in hopping mode.

Measurement:

Measurement parameter	
Detector:	Peak
Sweep time:	Auto
Video bandwidth:	500 kHz
Resolution bandwidth:	500 kHz
Span:	Plot 1: 2400 – 2445 MHz Plot 2: 2445 – 2485 MHz
Trace-Mode:	Max Hold

Limits:

FCC	IC
CFR Part 15.247 (a)(1)	RSS 210, Issue 7, A 8.1(d)
Number of Hopping Channels	
At least 15 non overlapping hopping channels	

Result:

Number of Hopping Channels	79
----------------------------	----

Result: The result of the measurement is passed.

Plot 1: Number of Hopping Channels (GFSK)

C.BER by Cetecom Saarbruecken Germany

Ref. Level Offset [dB]	Detector	Sweeptime [s]	Video BW [Hz]	RBW [Hz]
12.5	POS	2.5m	300k	300000

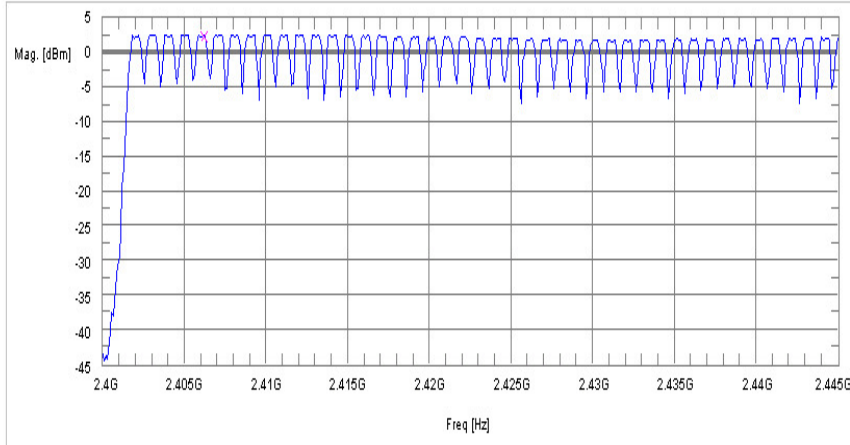

Start Freq [Hz]	Stop Freq [Hz]	Trace	Found Peak [dBm]	Found Peak [Hz]
2.4G	2.445G	MAXH	2.427	2.406G

Plot 2: Number of Hopping Channels (GFSK)

C.BER by Cetecom Saarbruecken Germany

Ref. Level Offset [dB]	Detector	Sweeptime [s]	Video BW [Hz]	RBW [Hz]
12.5	POS	2.5m	300k	300000

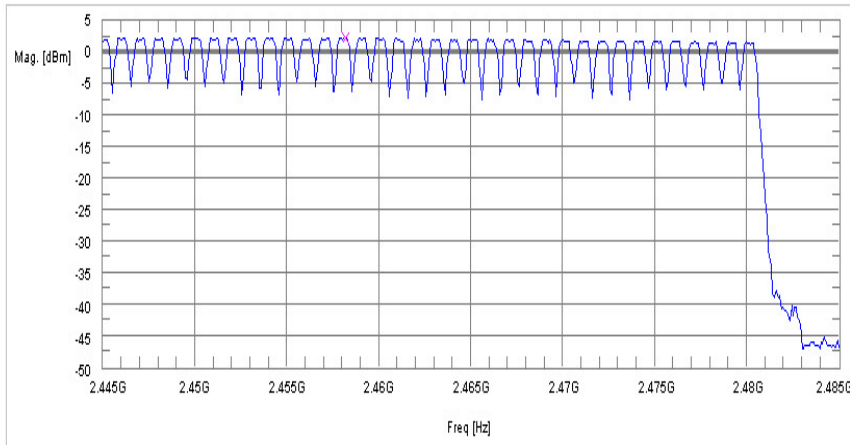

Start Freq [Hz]	Stop Freq [Hz]	Trace	Found Peak [dBm]	Found Peak [Hz]
2.445G	2.485G	MAXH	2.37	2.468G

10.5 Time of occupancy (Dwell Time)

For Bluetooth® devices:

The channel staying time of 0.4 s within a 31.6 second period in data mode is constant for Bluetooth® devices and independent from the packet type (packet length). The calculation for a 31.6 second period is as follows:

$$\text{Channel staying time} = \text{time slot length} * \text{hop rate} / \text{number of hopping channels} * 31.6 \text{ s}$$

Example for a DH1 packet (with a maximum length of one time slot)

$$\text{Channel staying time} = 625 \mu\text{s} * 1600 * 1/\text{s} / 79 * 31.6 \text{ s} = 0.4 \text{ s (in a 31.6 s period)}$$

For multi-slot packets the hopping is reduced according to the length of the packet.

Example for a DH3 packet (with a maximum length of three time slots)

$$\text{Channel staying time} = 3 * 625 \mu\text{s} * 1600/3 * 1/\text{s} / 79 * 31.6 \text{ s} = 0.4 \text{ s (in a 31.6 s period)}$$

Example for a DH5 packet (with a maximum length of five time slots)

$$\text{Channel staying time} = 5 * 625 \mu\text{s} * 1600/5 * 1/\text{s} / 79 * 31.6 \text{ s} = 0.4 \text{ s (in a 31.6 s period)}$$

This is according to the Bluetooth® Core Specification V2.0 & V2.1 & V3.0 & V4.0 (+ critical errata) for all Bluetooth® devices.

The following table shows the relations:

Packet Size	Pulse Width [ms] *	Max. number of transmissions per channel in 31.6 sec
DH1	0.366	640
DH3	1.622	214
DH5	2.870	128

* according Bluetooth® specification

Measurement results:

Packet Size	Measured Pulse Width [ms]	Max. number of transmissions in 31.6 sec	Dwell time [Pulse width * Number of transmissions]
DH1	0.385	640	246.4 ms
DH3	1.587	214	339.6 ms
DH5	2.857	128	365.7 ms

Plot 1 DH1

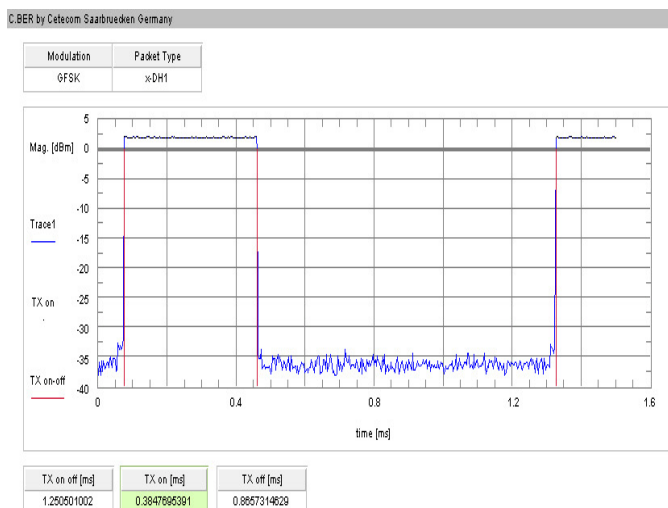

Plot 2 DH3

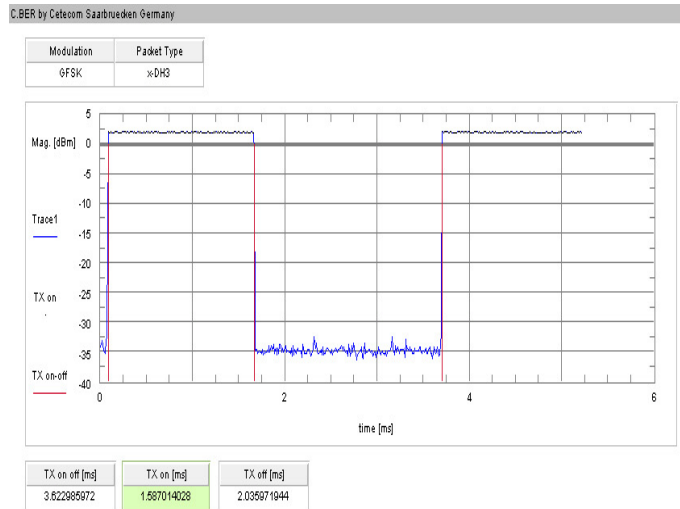

Plot 3 DH5

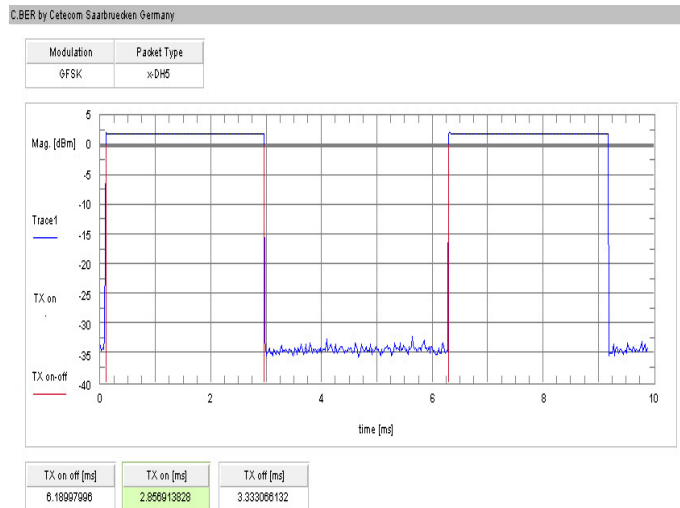

Limits:

FCC	IC
CFR Part 15.247 (a)(1)(iii)	RSS 210, Issue 7, A 8.3(1)
Time of Occupancy (Dwell Time)	
The frequency hopping operation shall have an average time of occupancy on any frequency not exceeding 0.4 seconds within a duration in seconds equal to the number of hopping frequencies multiplied by 0.4.	

Result: The result of the measurement is passed.

10.6 Spectrum bandwidth of a FHSS System – 20 dB bandwidth

Description:

Measurement of the 20dB bandwidth of the modulated signal. The measurement is performed according to the "Measurement Guidelines" (DA 00-705, March 30, 2000). EUT in single channel mode.

Measurement:

Measurement parameter	
Detector:	Peak
Sweep time:	2 s
Video bandwidth:	30 kHz
Resolution bandwidth:	10 kHz (GFSK) 30 kHz (Pi/4 DQPSK, 8DPSK)
Span:	3 MHz
Trace-Mode:	Max Hold

Limits:

FCC	IC
CFR Part 15.247 (a)(1)	RSS 210, Issue 7, A 8.2(a)
Spectrum Bandwidth of a FHSS System – 20 dB Bandwidth	
GFSK < 1000 kHz Pi/4 DQPSK < 1500 kHz 8DPSK < 1500 kHz	

Result:

Modulation	20 dB BANDWIDTH [kHz]		
	2402 MHz	2441 MHz	2480 MHz
Frequency			
GFSK	908	908	878
Pi/4 DQPSK	1238	1238	1238
8DPSK	1263	1257	1257
Measurement uncertainty	± 30 kHz		

Result: The result of the measurement is passed.

Plot 1: Channel 00 / GFSK

C.BER by Cetecom Saarbruecken Germany

Ref. Level Offset [dB]	Detector	Sweeptime [s]
12.5	POS	2

Video BW [Hz]	RBW [Hz]
30k	10000

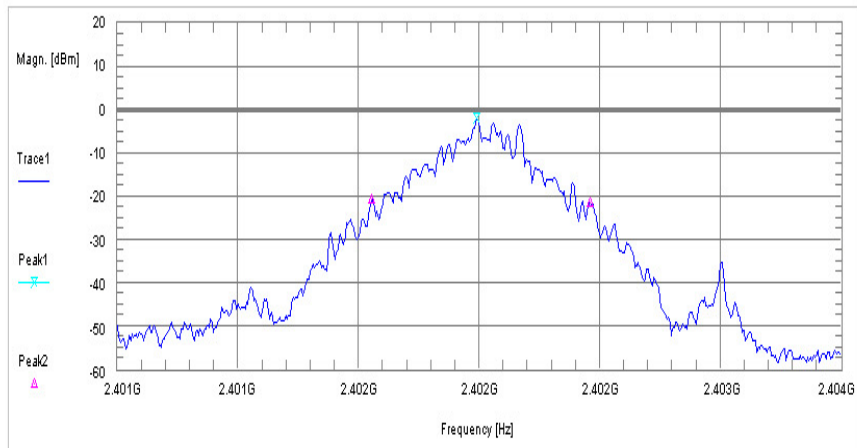

Found Peak [dBm]	Found Peak [Hz]	Tracemode
-1.77	2.402 G	MAXH

20 dB Bandwidth [Hz]
908

Plot 2: Channel 39 / GFSK

C.BER by Cetecom Saarbruecken Germany

Ref. Level Offset [dB]	Detector	Sweeptime [s]
12.5	POS	2

Video BW [Hz]	RBW [Hz]
30k	10000

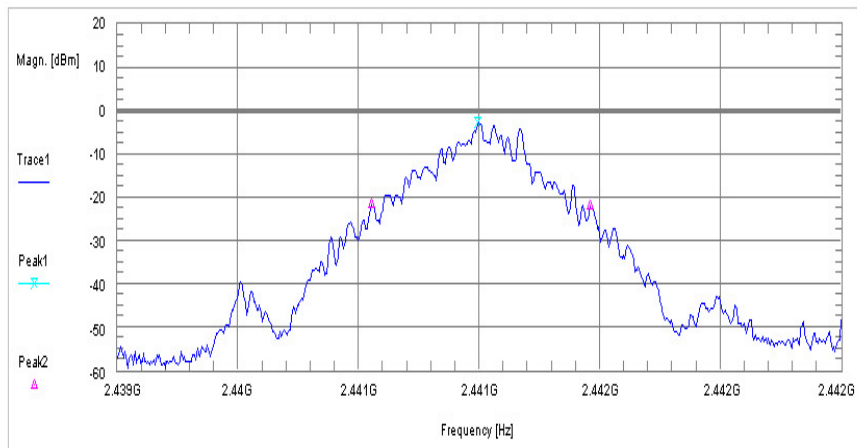

Found Peak [dBm]	Found Peak [Hz]	Tracemode
-2.521	2.441 G	MAXH

20 dB Bandwidth [Hz]
908

Plot 3: Channel 78 / GFSK

C.BER by Cetecom Saarbruecken Germany

Ref. Level Offset [dB]	Detector	Sweeptime [s]	Video BW [Hz]	RBW [Hz]
12.5	PDS	2	30k	10000

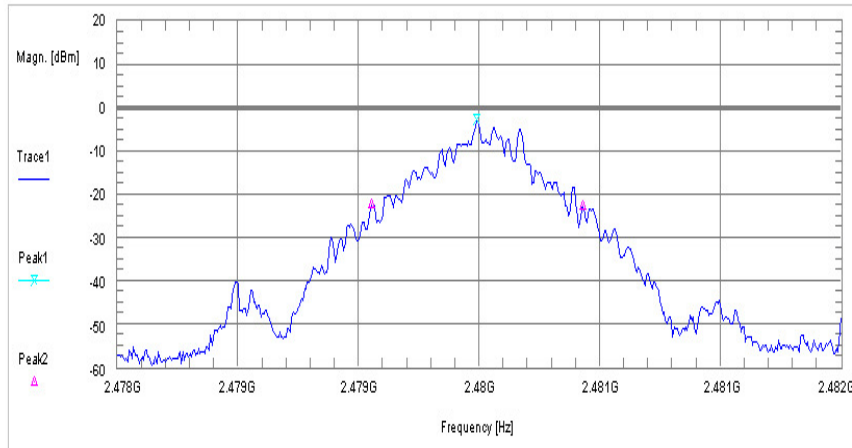

Found Peak [dBm]	Found Peak [Hz]	Trace mode	20 dB Bandwidth [Hz]
-2.855	2.480	MAXH	878

Plot 4: Channel 00 / Pi/4 DQPSK

C.BER by Cetecom Saarbruecken Germany

Ref. Level Offset [dB]	Detector	Sweeptime [s]	Video BW [Hz]	RBW [Hz]
12.5	PDS	2	30k	30000

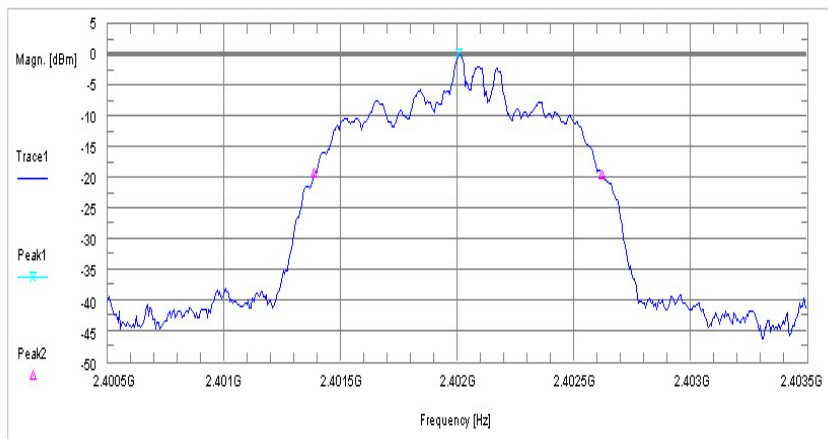

Found Peak [dBm]	Found Peak [Hz]	Trace mode	20 dB Bandwidth [Hz]
0.2148520615	2.4020066	MAXH	1238

Plot 5: Channel 39 / Pi/4 DQPSK

C.BER by Cetecom Saarbruecken Germany

Ref. Level Offset [dB]	Detector	Sweeptime [s]
12.5	PDS	2

Video BW [Hz]	RBW [Hz]
30k	30000

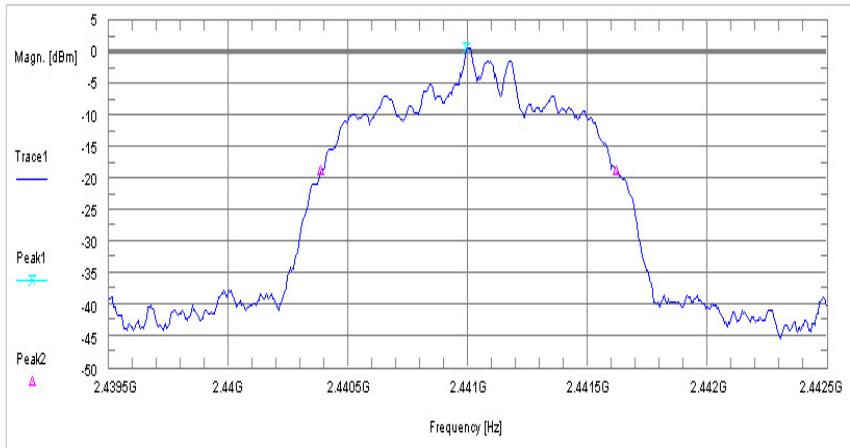

Found Peak [dBm]	Found Peak [Hz]	Tracemode
0.793880849	2.4409946	MAXH

20 dB Bandwidth [kHz]
1238

Plot 6: Channel 78 / Pi/4 DQPSK

C.BER by Cetecom Saarbruecken Germany

Ref. Level Offset [dB]	Detector	Sweeptime [s]
12.5	PDS	2

Video BW [Hz]	RBW [Hz]
30k	30000

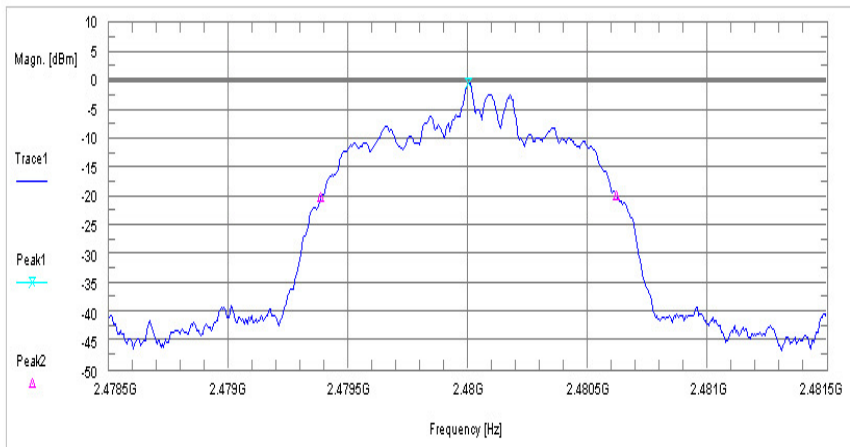

Found Peak [dBm]	Found Peak [Hz]	Tracemode
-0.2748613358	2.48G	MAXH

20 dB Bandwidth [kHz]
1238

Plot 7: Channel 00 / 8DPSK

C.BER by Cetecom Saarbruecken Germany

Ref. Level Offset [dB]	Detector	Sweeptime [s]
12.5	PDS	2

Video BW [Hz]	RBW [Hz]
30k	30000

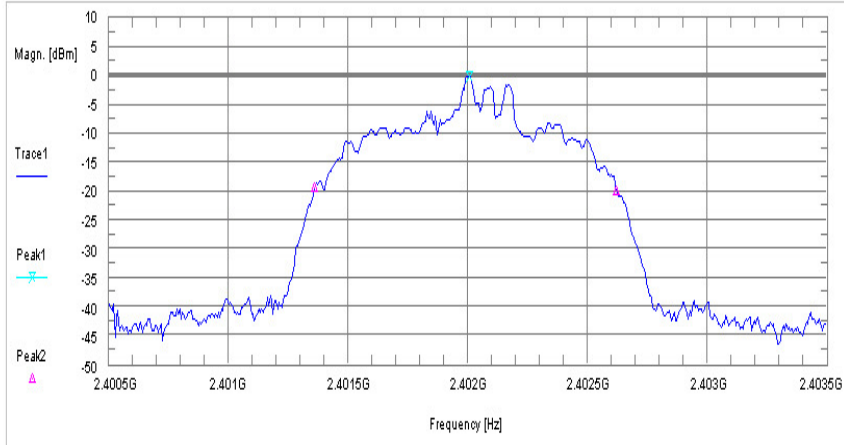

Found Peak [dBm]	Found Peak [Hz]	Tracemode
-95.82233429m	2.4020086	MAXH

20 dB Bandwidth [kHz]
1263

Plot 8: Channel 39 / 8DPSK

C.BER by Cetecom Saarbruecken Germany

Ref. Level Offset [dB]	Detector	Sweeptime [s]
12.5	PDS	2

Video BW [Hz]	RBW [Hz]
30k	30000

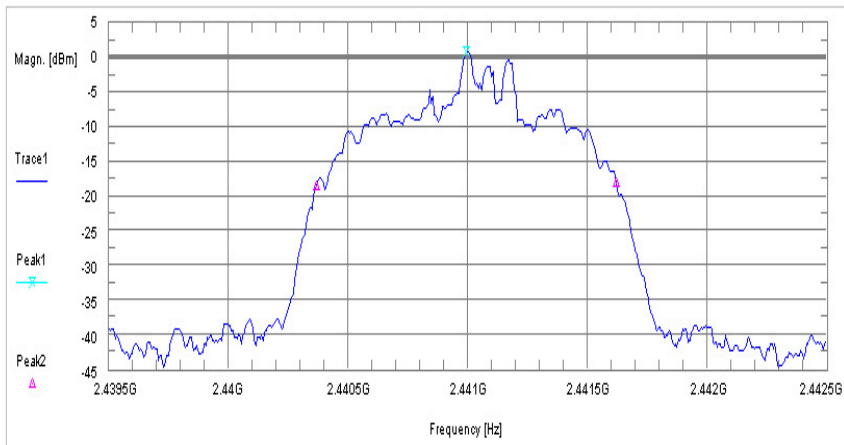

Found Peak [dBm]	Found Peak [Hz]	Tracemode
0.8382730484	2.4409946	MAXH

20 dB Bandwidth [kHz]
1257

Plot 9: Channel 78 / 8DPSK

C.BER by Cetecom Saarbruecken Germany

Ref. Level Offset [dB]	Detector	Sweeptime [s]
12.5	PDG	2

Video BW [Hz]	RBW [Hz]
30k	30000

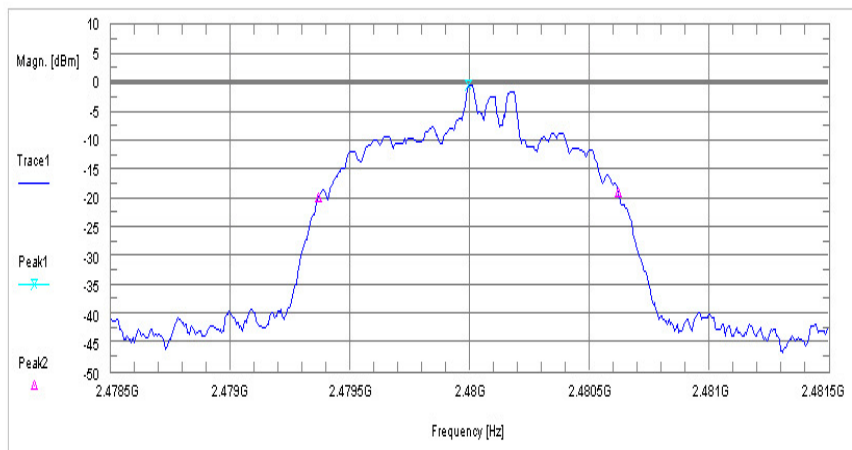

Found Peak [dBm]	Found Peak [Hz]	Tracemode
-0.3334703445	2.4799946	MAXH

20 dB Bandwidth [Hz]
1257

10.7 Maximum output power

Description:

Measurement of the maximum output power conducted and radiated. EUT in single channel mode.

Measurement:

Measurement parameter	
Detector:	Peak
Sweep time:	Auto
Video bandwidth:	3 MHz
Resolution bandwidth:	3 MHz
Span:	3 MHz
Trace-Mode:	Max Hold

Limits:

FCC	IC
CFR Part 15.247 (b)(1)	RSS 210, Issue 7, A 8.4(2)
Maximum Output Power	
[Conducted: 0.125 W – Antenna Gain max. 6 dBi] Systems using more than 75 hopping channels: Conducted: 1.0 W – Antenna Gain max. 6 dBi	

Result:

Modulation Frequency	Maximum Output Power Conducted [dBm]		
	2402 MHz	2441 MHz	2480 MHz
GFSK	2.35	2.02	1.57
Pi/4 DQPSK	2.55	2.16	1.63
8DPSK	2.85	2.45	1.98
Measurement uncertainty	± 0.5 dB		

Modulation Frequency	Maximum Output Power Radiated - EIRP [dBm]		
	2402 MHz	2441 MHz	2480 MHz
GFSK	4.6	4.6	3.7
Pi/4 DQPSK	4.4	4.3	3.9
8DPSK	4.4	4.2	3.8
Measurement uncertainty	± 2.0 dB		

Result: The result of the measurement is passed.

Plot 1: Channel 00 / GFSK (conducted)

C.BER by Cetecom Saarbruecken Germany

Ref. Level Offset [dB]	Detector	Sweeptime [s]
12.5	PDS	2.5m

Video BW [Hz]	RBW [Hz]
3M	3000000

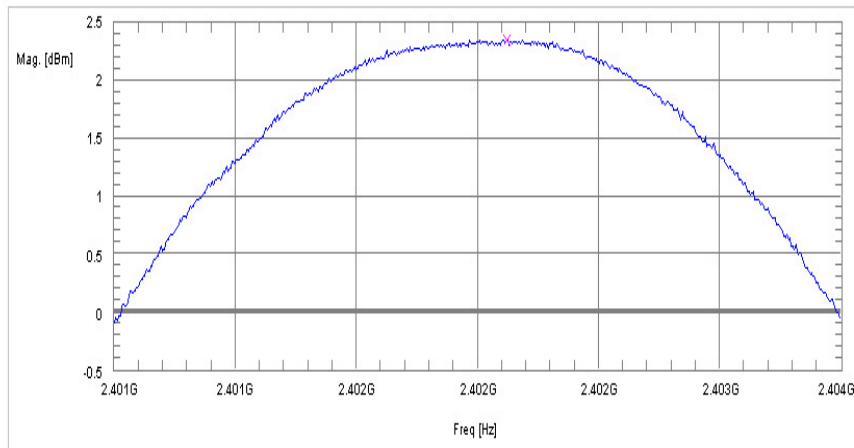

Start Freq [Hz]	Stop Freq [Hz]	TraceM.	Found Peak [dBm]	Found Peak [Hz]
2.401G	2.404G	MAXH	2.354	2.402G

Plot 2: Channel 39 / GFSK (conducted)

C.BER by Cetecom Saarbruecken Germany

Ref. Level Offset [dB]	Detector	Sweeptime [s]
12.5	PDS	2.5m

Video BW [Hz]	RBW [Hz]
3M	3000000

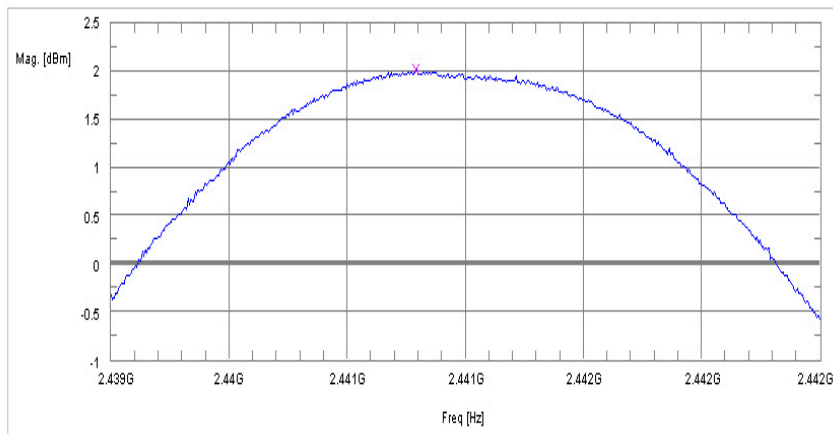

Start Freq [Hz]	Stop Freq [Hz]	TraceM.	Found Peak [dBm]	Found Peak [Hz]
2.439G	2.442G	MAXH	2.021	2.441G

Plot 3: Channel 78 / GFSK (conducted)

C.BER by Cetecom Saarbruecken Germany

Ref. Level Offset [dB]	Detector	SweepTime [s]
12.5	POS	2.5m

Video BW [Hz]	RBW [Hz]
3M	3000000

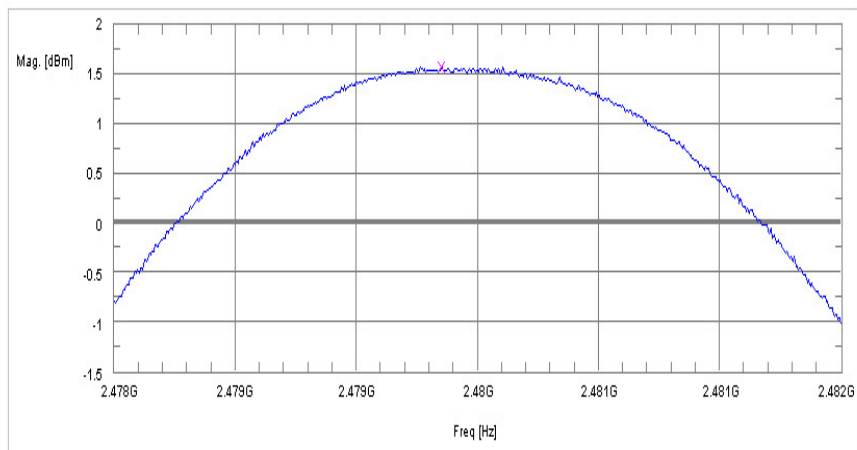

Start Freq [Hz]	Stop Freq [Hz]	TraceM.	Found Peak [dBm]	Found Peak [Hz]
2.478G	2.482G	MAXH	1.573	2.48G

Plot 4: Channel 00 / Pi/4 DQPSK (conducted)

C.BER by Cetecom Saarbruecken Germany

Ref. Level Offset [dB]	Detector	SweepTime [s]
12.5	POS	2.5m

Video BW [Hz]	RBW [Hz]
3M	3000000

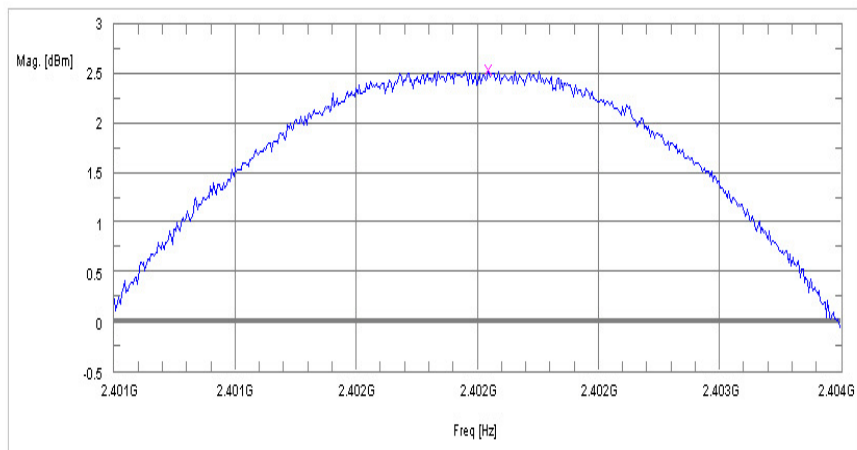

Start Freq [Hz]	Stop Freq [Hz]	TraceM.	Found Peak [dBm]	Found Peak [Hz]
2.401G	2.404G	MAXH	2.546	2.402G

Plot 5: Channel 39 / Pi/4 DQPSK (conducted)

C.BER by Cetecom Saarbruecken Germany

Ref. Level Offset [dB]	Detector	Sweeptime [s]	Video BW [Hz]	RBW [Hz]
12.5	POS	2.5m	3M	3000000

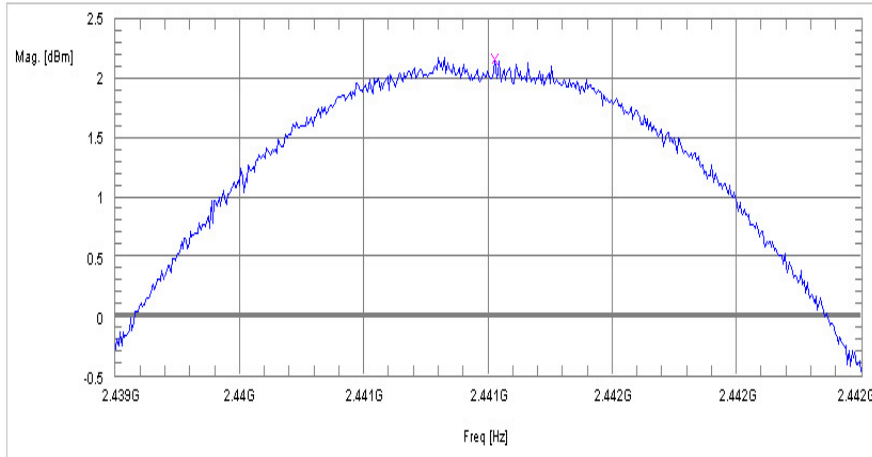

Start Freq [Hz]	Stop Freq [Hz]	Tracem.	Found Peak [dBm]	Found Peak [Hz]
2.439G	2.442G	MAXH	2.162	2.441G

Plot 6: Channel 78 / Pi/4 DQPSK (conducted)

C.BER by Cetecom Saarbruecken Germany

Ref. Level Offset [dB]	Detector	Sweeptime [s]	Video BW [Hz]	RBW [Hz]
12.5	POS	2.5m	3M	3000000

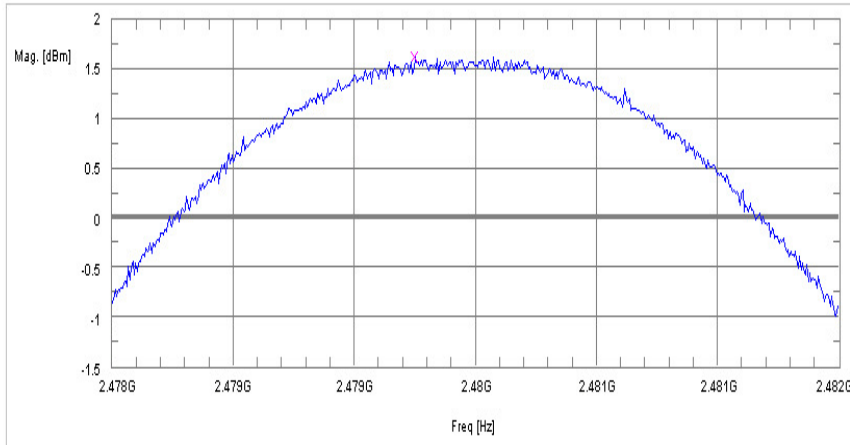

Start Freq [Hz]	Stop Freq [Hz]	Tracem.	Found Peak [dBm]	Found Peak [Hz]
2.478G	2.482G	MAXH	1.63	2.48G

Plot 7: Channel 00 / 8DPSK (conducted)

C.BER by Cetecom Saarbruecken Germany

Ref. Level Offset [dB]	Detector	Sweeptime [s]
12.5	POS	2.5m

Video BW [Hz]	RBW [Hz]
3M	3000000

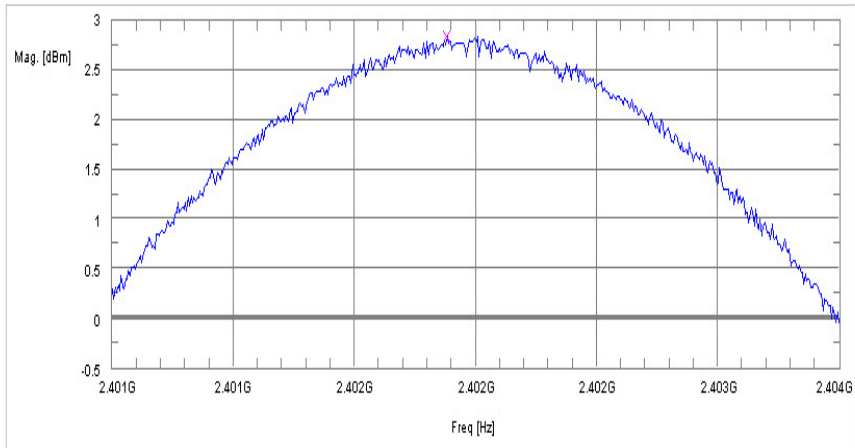

Start Freq [Hz]	Stop Freq [Hz]	TraceM.	Found Peak [dBm]	Found Peak [Hz]
2.4016	2.4046	MAXH	2.852	2.4026

Plot 8: Channel 39 / 8DPSK (conducted)

C.BER by Cetecom Saarbruecken Germany

Ref. Level Offset [dB]	Detector	Sweeptime [s]
12.5	POS	2.5m

Video BW [Hz]	RBW [Hz]
3M	3000000

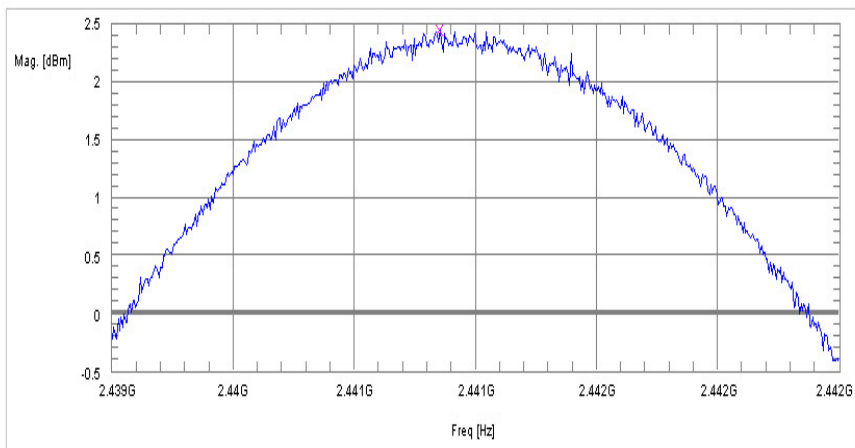

Start Freq [Hz]	Stop Freq [Hz]	TraceM.	Found Peak [dBm]	Found Peak [Hz]
2.4396	2.4426	MAXH	2.455	2.4416

Plot 9: Channel 78 / 8DPSK (conducted)

C.BER by Cetecom Saarbruecken Germany

Ref. Level Offset [dB]	Detector	SweepTime [s]
12.5	POS	2.5m

Video BW [Hz]	RBW [Hz]
3M	3000000

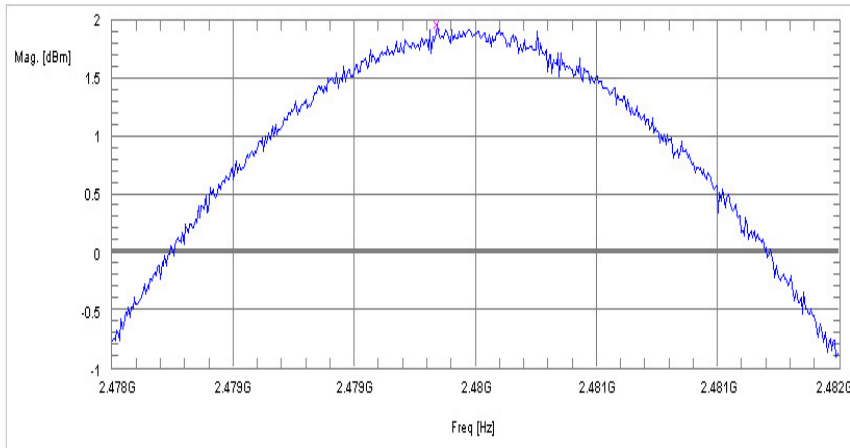

Start Freq [Hz]	Stop Freq [Hz]	TraceM.	Found Peak [dBm]	Found Peak [Hz]
2.478G	2.482G	MAXH	1.977	2.48G

10.8 Band edge compliance conducted

Description:

Measurement of the conducted band edge compliance. EUT is measured at the lower and upper band edge in single channel and hopping mode. The measurement is repeated for all modulations.

Measurement:

Measurement parameter	
Detector:	Peak
Sweep time:	Auto
Video bandwidth:	100 kHz
Resolution bandwidth:	100 kHz
Span:	Lower Band Edge: 2395 – 2405 MHz Upper Band Edge: 2478 – 2489 MHz
Trace-Mode:	Max Hold

Limits:

FCC	IC
CFR Part 15.247 (d)	RSS 210, Issue 7, A 8.5
Band Edge Compliance Conducted	
<p>In any 100 kHz bandwidth outside the frequency band in which the spread spectrum or digitally modulated intentional radiator is operating, the radio frequency power that is produced by the intentional radiator shall be at least 20 dB below that in the 100 kHz bandwidth within the band that contains the highest level of the desired power, based on either an RF conducted or a radiated measurement. Attenuation below the general limits specified in Section 15.209(a) is not required.</p>	

Result: Also see plots

Scenario Modulation	Band Edge Compliance Conducted [dB]		
	GFSK	Pi/4 DQPSK	8DPSK
Lower Band Edge – Hopping Off	> 20 dB	> 20 dB	> 20 dB
Lower Band Edge – Hopping On	> 20 dB	> 20 dB	> 20 dB
Upper Band Edge – Hopping Off	> 20 dB	> 20 dB	> 20 dB
Upper Band Edge – Hopping On	> 20 dB	> 20 dB	> 20 dB
Measurement uncertainty	± 1.5 dB		

Result: The result of the measurement is passed.

Plot 1: Lower Band Edge – Hopping Off / GFSK (conducted)

C.BER by Cetecom Saarbruecken Germany

Ref. Level Offset [dB]	Detector	Sweeptime [s]
12.5	POS	2.5m

Video BW [Hz]	RBW [Hz]
100k	100000

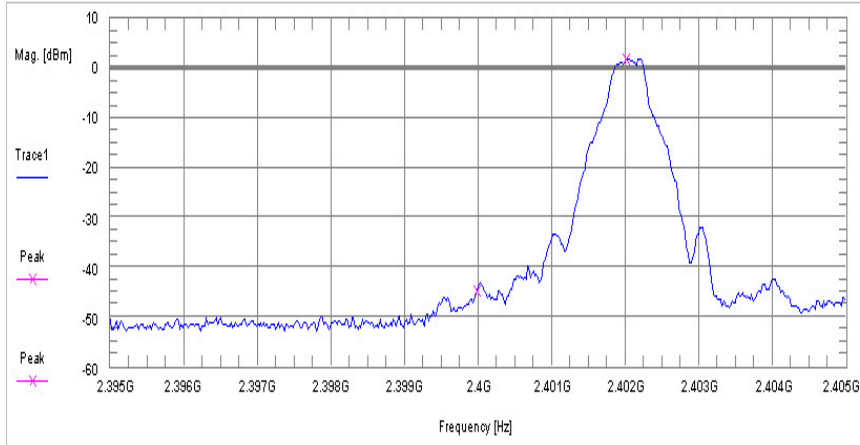

Found Peak [dBm]	Found Peak [Hz]	Tracemode
2.02	2.402G	MAXH

Delta [dB]
46.77

Plot 2: Lower Band Edge – Hopping On / GFSK (conducted)

C.BER by Cetecom Saarbruecken Germany

Ref. Level Offset [dB]	Detector	Sweeptime [s]
12.5	POS	2.5m

Video BW [Hz]	RBW [Hz]
100k	100000

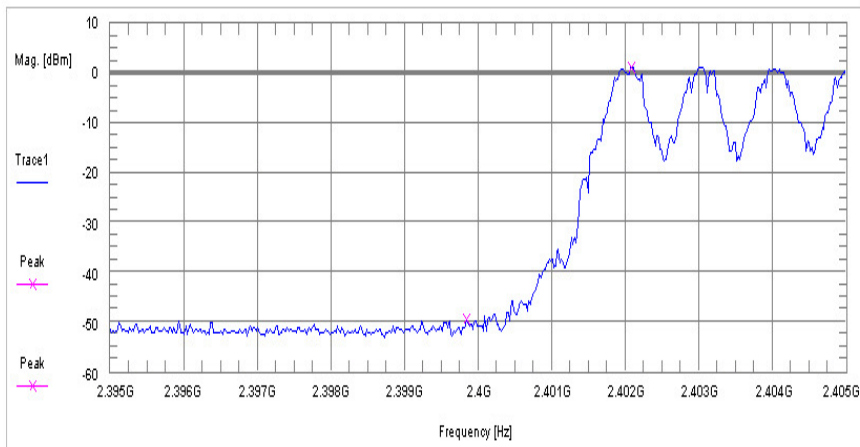

Found Peak [dBm]	Found Peak [Hz]	Tracemode
1.36	2.402G	MAXH

Delta [dB]
50.78

Plot 3: Upper Band Edge – Hopping Off / GFSK (conducted)

C.BER by Cetecom Saarbruecken Germany

Ref. Level Offset [dB]	Detector	Sweeptime [s]
12.5	POS	2.5m

Video BW [Hz]	RBW [Hz]
100k	100000

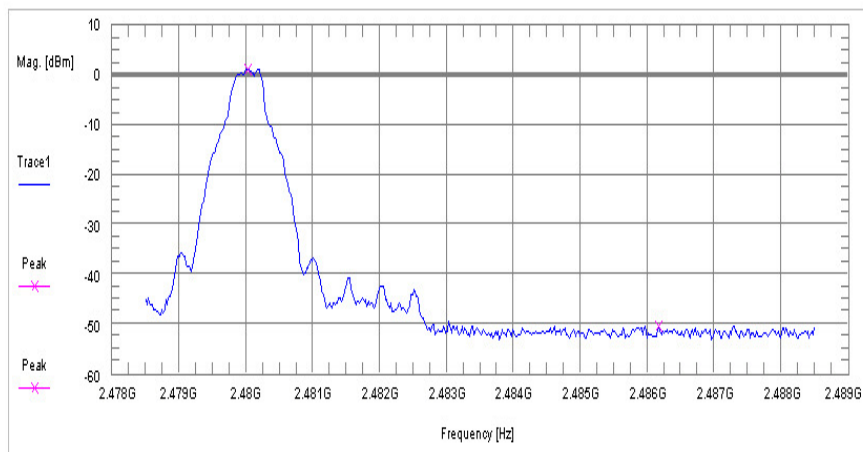

Found Peak [dBm]	Found Peak [Hz]	Tracemode
1.308	2.48G	MAXH

Delta [dB]
51.91

Plot 4: Upper Band Edge – Hopping On / GFSK (conducted)

C.BER by Cetecom Saarbruecken Germany

Ref. Level Offset [dB]	Detector	Sweeptime [s]
12.5	POS	2.5m

Video BW [Hz]	RBW [Hz]
100k	100000

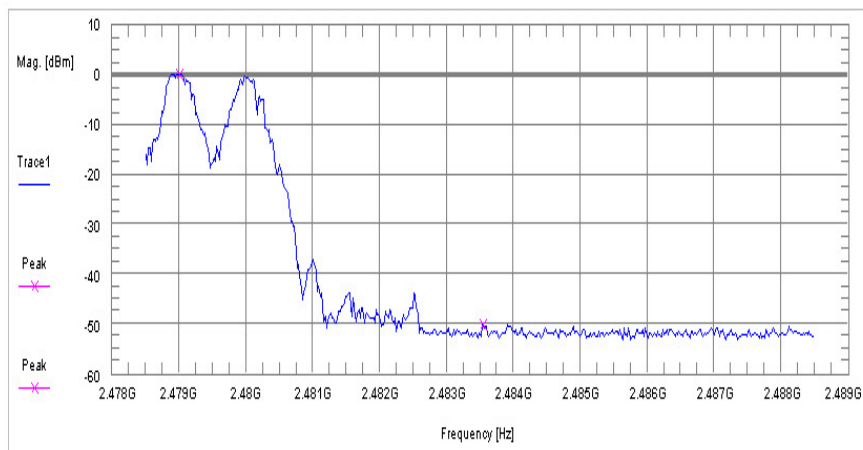

Found Peak [dBm]	Found Peak [Hz]	Tracemode
0.3789	2.479G	MAXH

Delta [dB]
50.65

Plot 5: Lower Band Edge – Hopping Off / Pi/4 DQPSK (conducted)

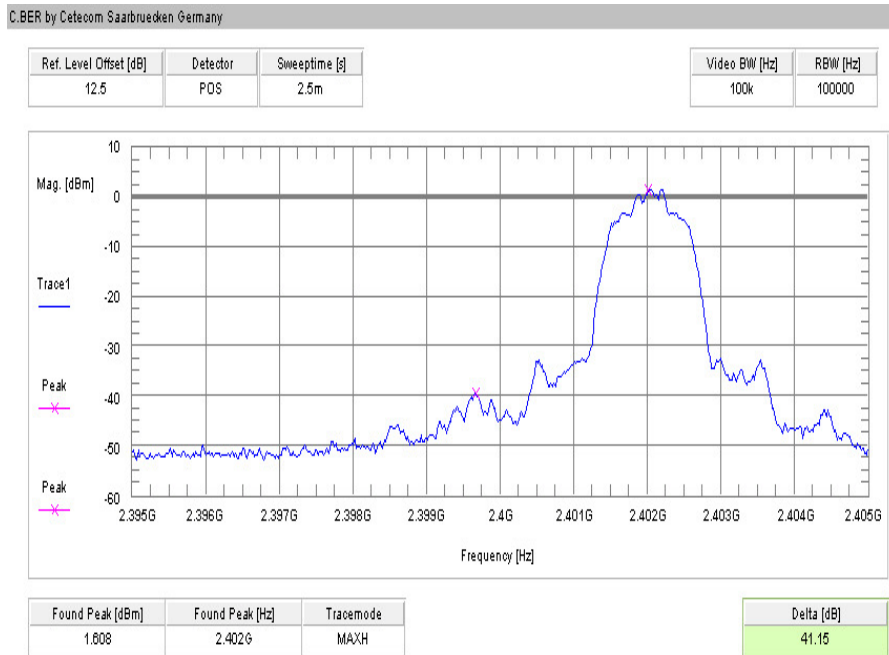

Plot 6: Lower Band Edge – Hopping On / Pi/4 DQPSK (conducted)

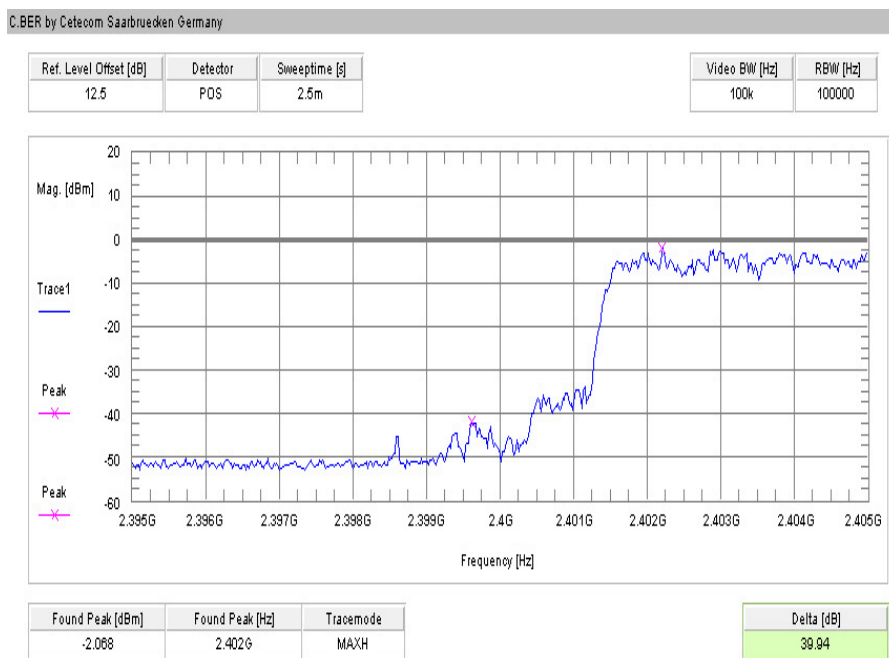

Plot 7: Upper Band Edge – Hopping Off / Pi/4 DQPSK (conducted)

C.BER by Cetecom Saarbruecken Germany

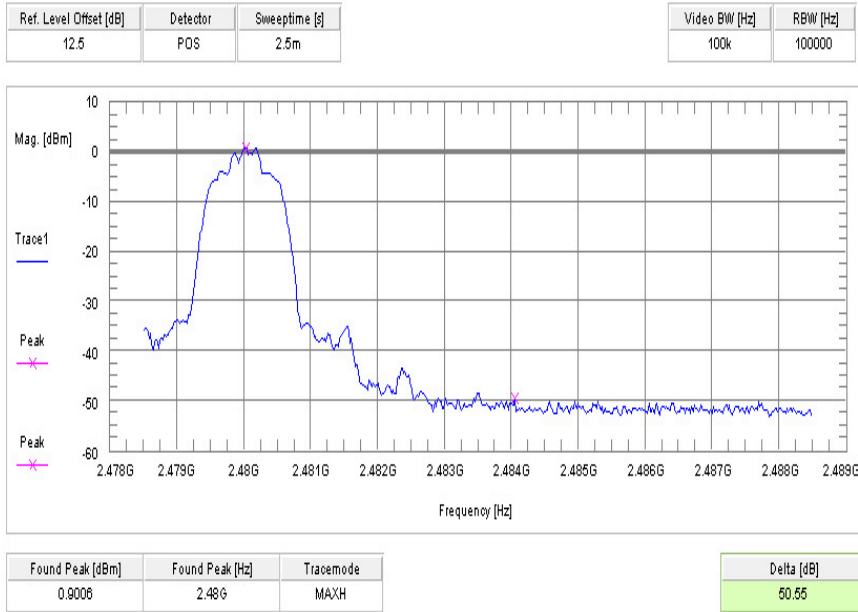

Plot 8: Upper Band Edge – Hopping On / Pi/4 DQPSK (conducted)

C.BER by Cetecom Saarbruecken Germany

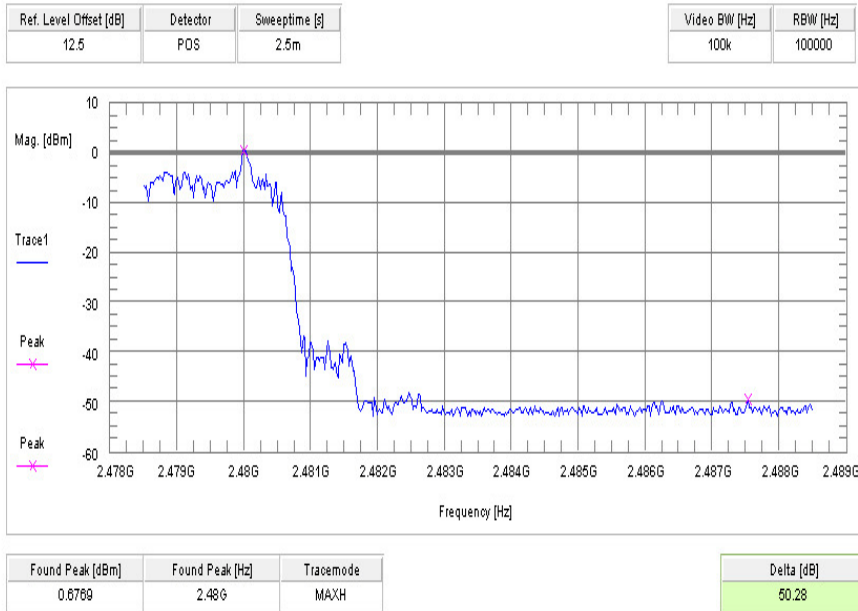

Plot 9: Lower Band Edge – Hopping Off / 8DPSK (conducted)

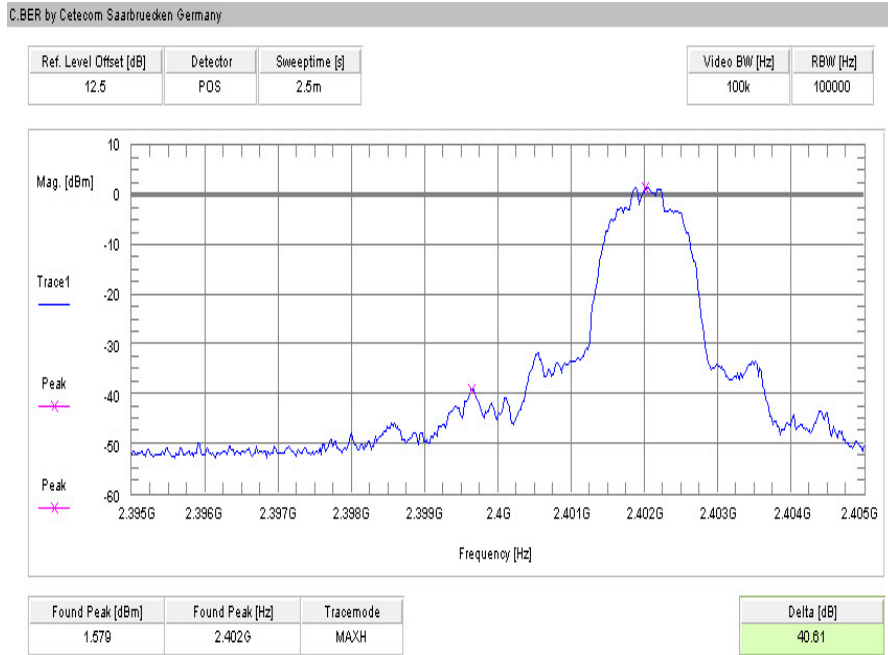

Plot 10: Lower Band Edge – Hopping On / 8DPSK (conducted)

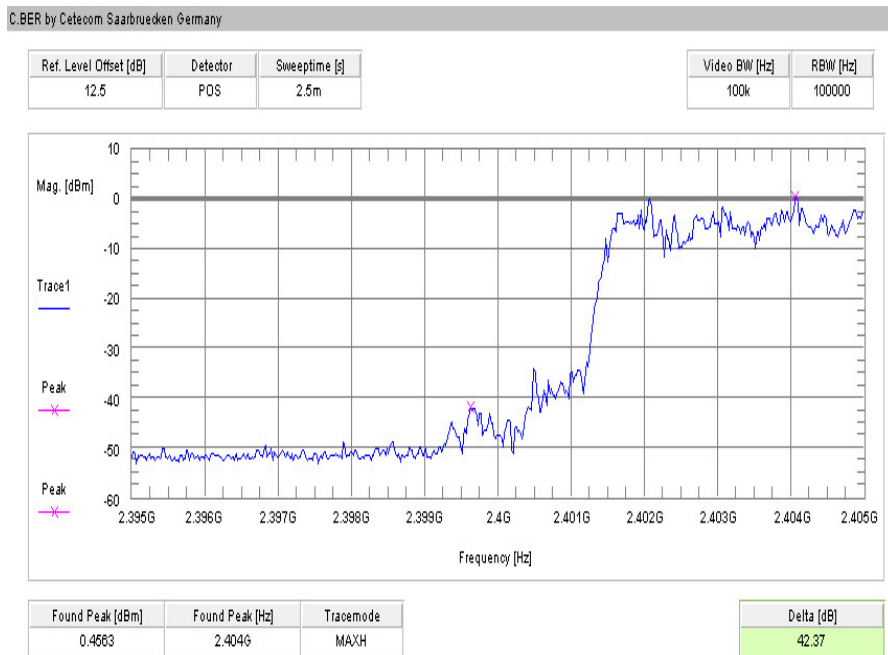

Plot 11: Upper Band Edge – Hopping Off / 8DPSK (conducted)

C.BER by Cetecom Saarbruecken Germany

Ref. Level Offset [dB]	Detector	Sweeptime [s]	Video BW [Hz]	RBW [Hz]
12.5	PDS	2.5m	100k	100000

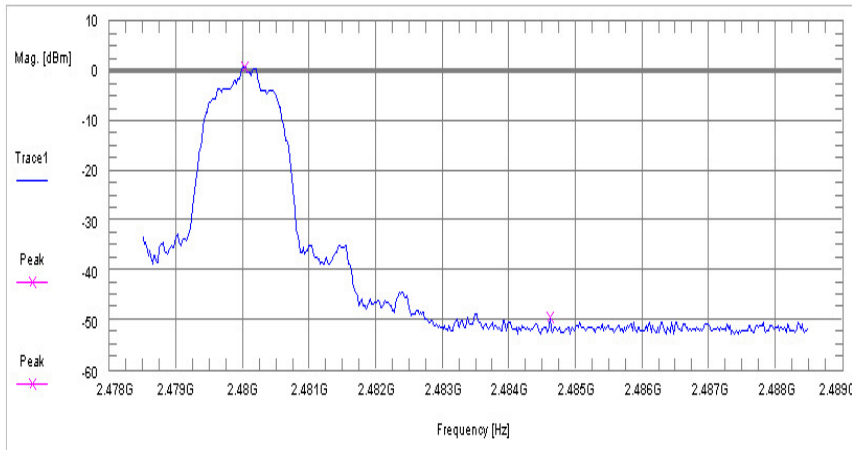

Found Peak [dBm]	Found Peak [Hz]	Tracemode	Delta [dB]
0.8833	2.486	MAXH	50.3

Plot 12: Upper Band Edge – Hopping On / 8DPSK (conducted)

C.BER by Cetecom Saarbruecken Germany

Ref. Level Offset [dB]	Detector	Sweeptime [s]	Video BW [Hz]	RBW [Hz]
12.5	PDS	2.5m	100k	100000

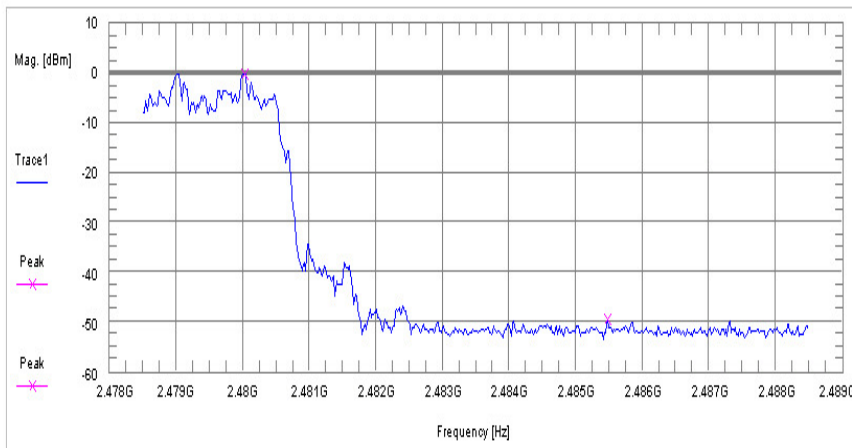

Found Peak [dBm]	Found Peak [Hz]	Tracemode	Delta [dB]
46.95m	2.486	MAXH	49.77

10.9 Band edge compliance radiated

Description:

Measurement of the radiated band edge compliance. The EUT is turned in the position that results in the maximum level at the band edge. Then a sweep over the corresponding restricted band is performed. The EUT is set to single channel mode and the transmit channel is channel 00 for the lower restricted band and channel 78 for the upper restricted band. The measurement is repeated for all modulations. Measurement distance is 3m. The EUT is checked for both the peak and average limit. The plots only show the results of the average measurements if no critical peak is measured.

Measurement:

Measurement parameter	
Detector:	Peak
Sweep time:	Auto
Video bandwidth:	10 Hz (AVG) / 1 MHz (PK)
Resolution bandwidth:	1 MHz
Span:	Lower Band: 2300 – 2400 MHz Higher Band: 2480 – 2500 MHz
Trace-Mode:	Max Hold

Limits:

FCC	IC
CFR Part 15.205	RSS 210, Issue 7, A 8.5
Band Edge Compliance Radiated	
<p>In any 100 kHz bandwidth outside the frequency band in which the spread spectrum or digitally modulated intentional radiator is operating, the radio frequency power that is produced by the intentional radiator shall be at least 20 dB below that in the 100 kHz bandwidth within the band that contains the highest level of the desired power, based on either an RF conducted or a radiated measurement. Attenuation below the general limits specified in Section 15.209(a) is not required. In addition, radiated emissions which fall in the restricted bands, as defined in Section 15.205(a), must also comply with the radiated emission limits specified in Section 15.209(a) (see Section 5.205(c)).</p>	
54 dBµV/m AVG 74 dBµV/m PK	

Result: Also see plots

Szenario Modulation	Band Edge Compliance Radiated [dB μ V/m]		
	GFSK	Pi/4 DQPSK	8DPSK
Lower Restricted Band	< 54 (see plots 1/2)	< 54 (see plots 5/6)	< 54 (see plots 9/10)
Upper Restricted Band	< 54 (see plots 3/4)	< 54 (see plots 7/8)	< 54 (see plots 11/12)
Measurement uncertainty	± 3 dB		

Result: The result of the measurement is passed.

Plot 1: Lower Restricted Band / GFSK (radiated) - vertical

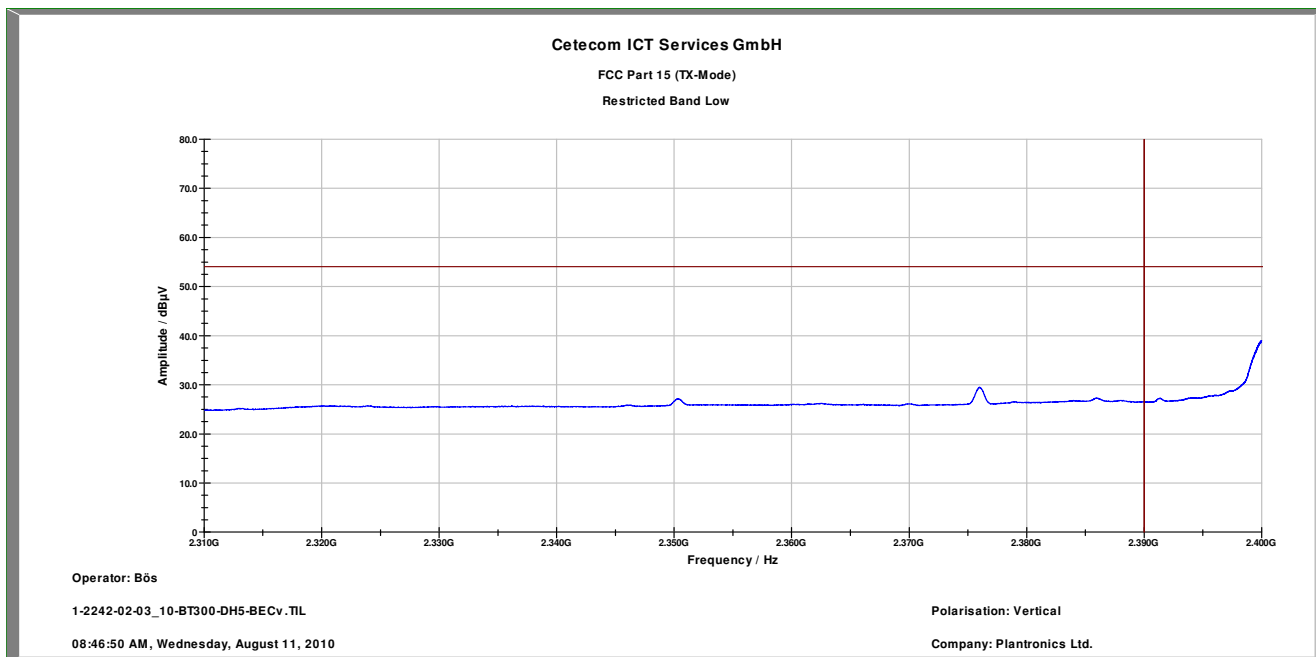

Plot 2: Lower Restricted Band / GFSK (radiated) - horizontal

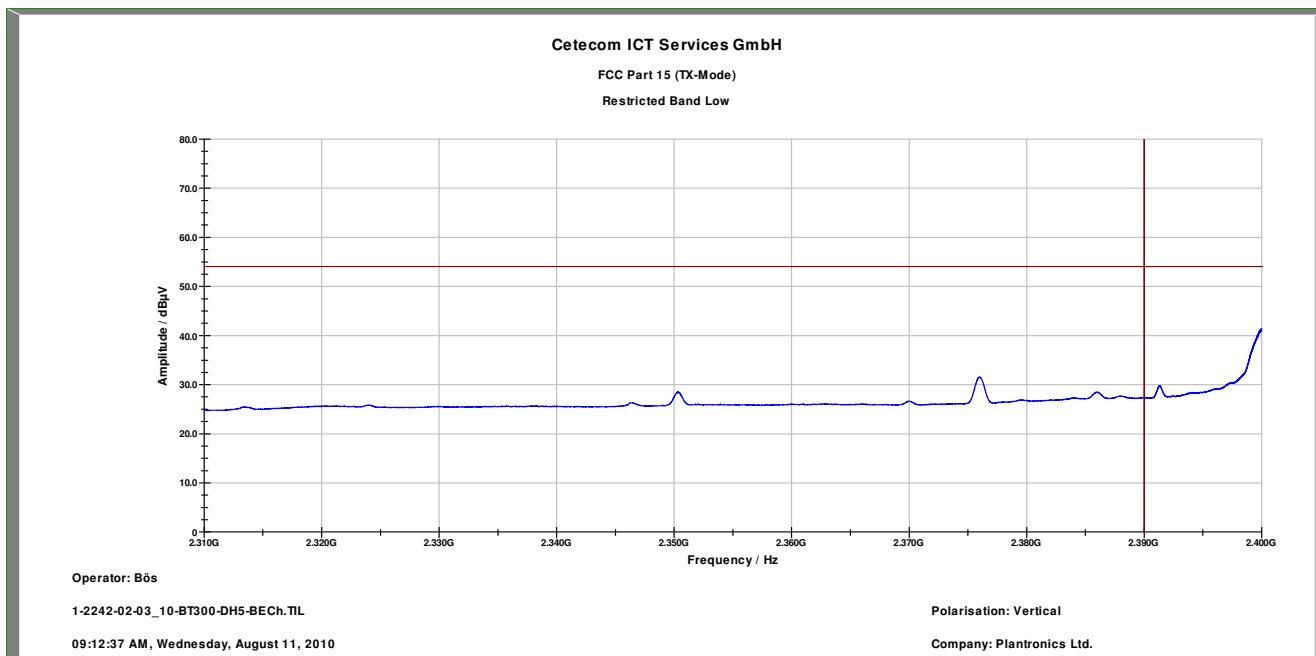

Plot 3: Upper Restricted Band / GFSK (radiated) - vertical

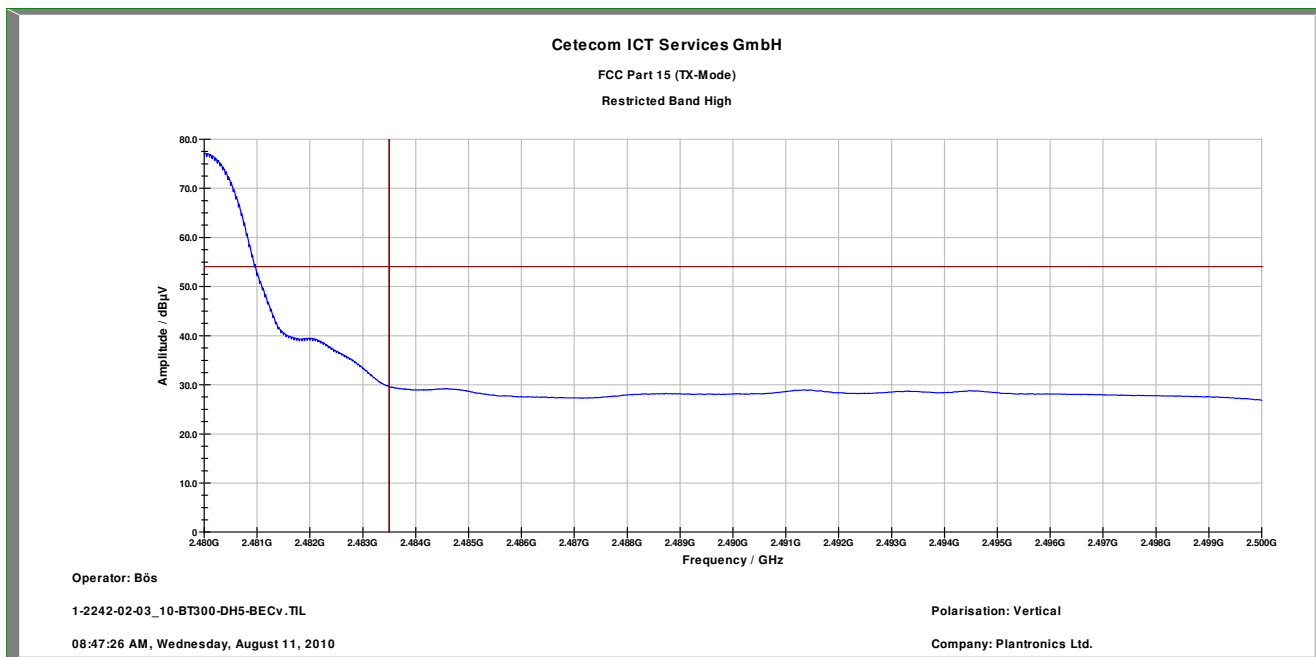

Plot 4: Upper Restricted Band / GFSK (radiated) - horizontal

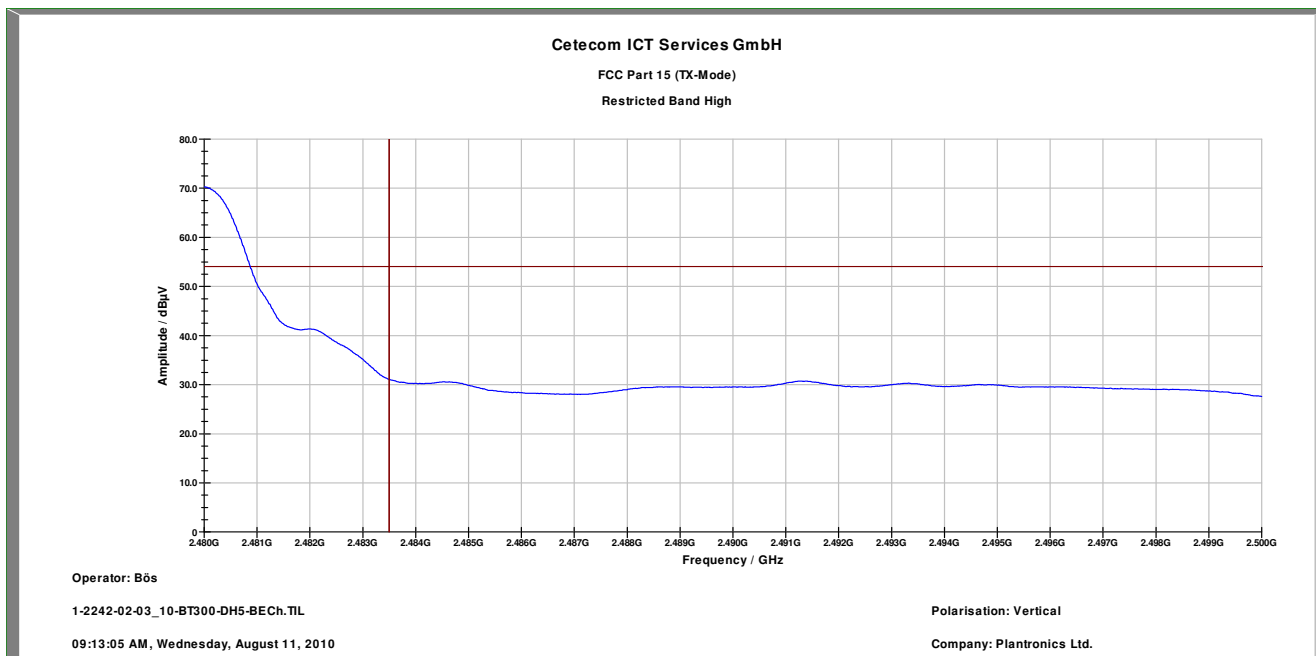

Plot 5: Lower Restricted Band / Pi/4 DQPSK (radiated) - vertical

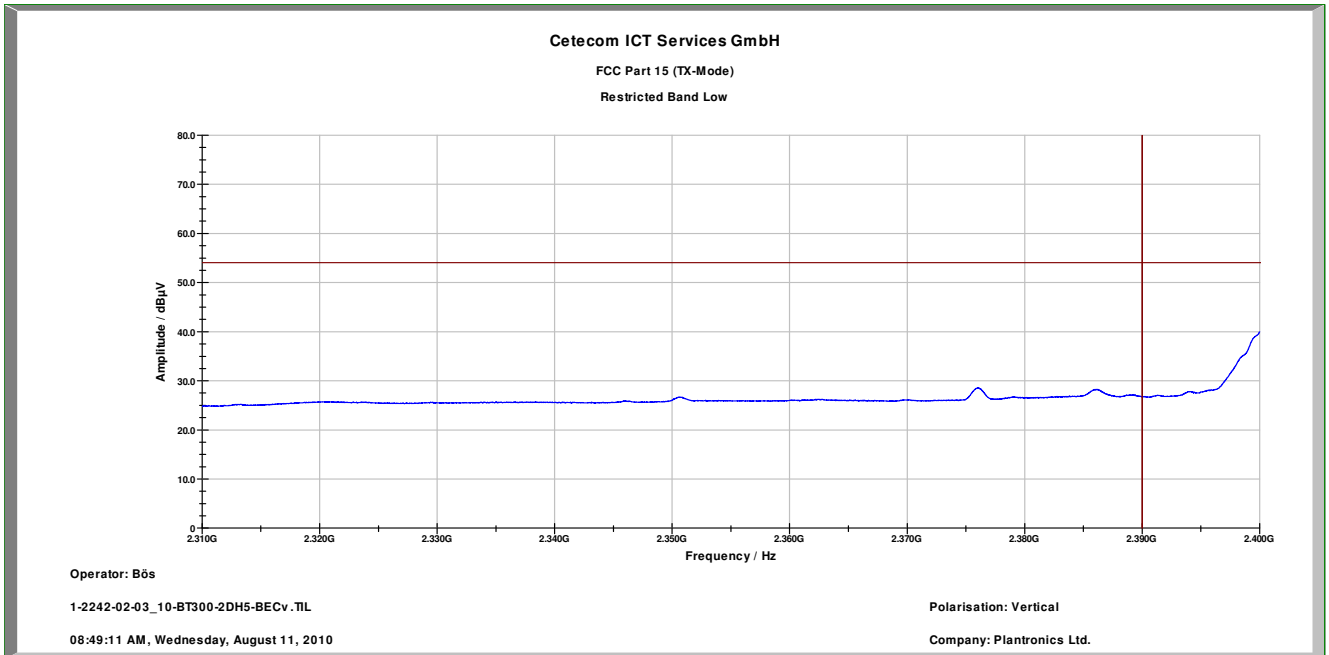

Plot 6: Lower Restricted Band / Pi/4 DQPSK (radiated) - horizontal

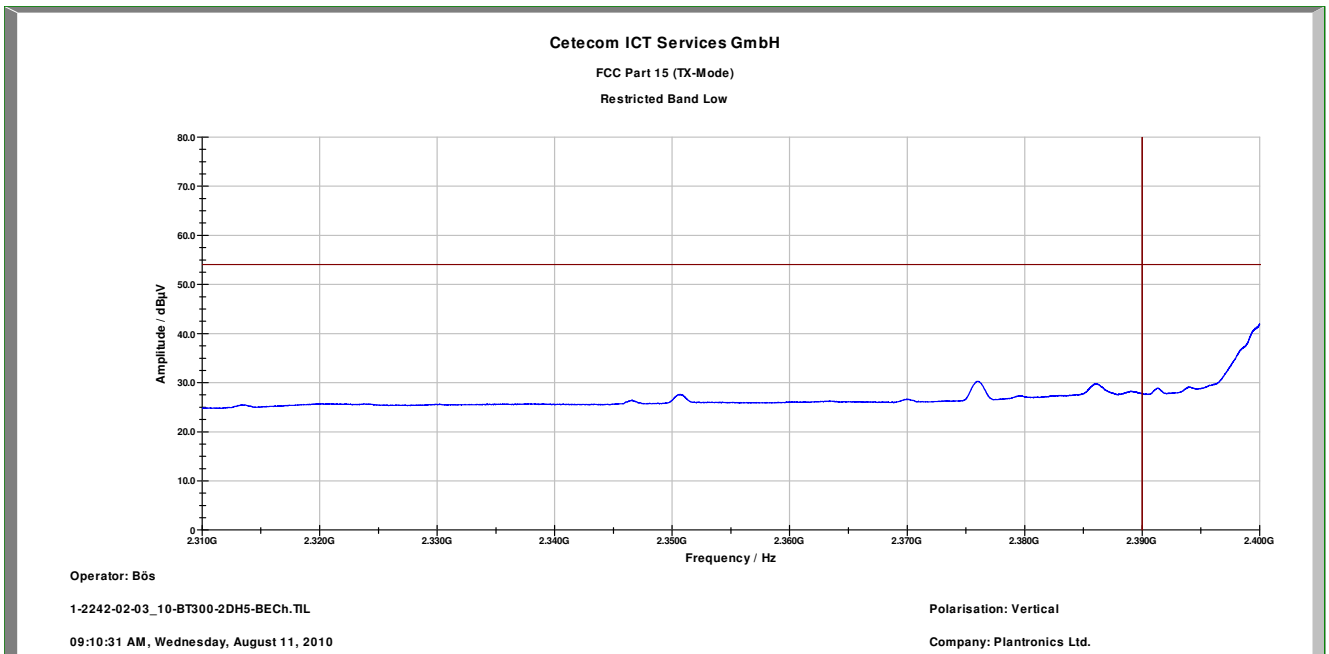

Plot 7: Upper Restricted Band / Pi/4 DQPSK (radiated) - vertical

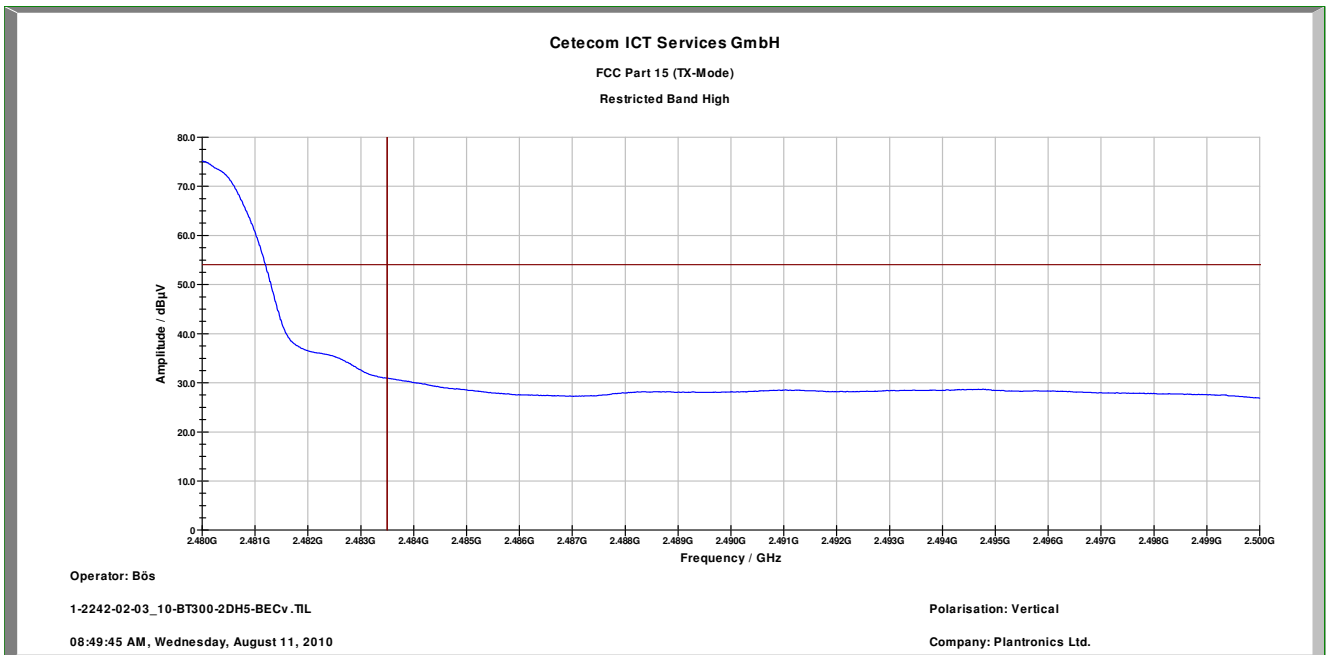

Plot 8: Upper Restricted Band / Pi/4 DQPSK (radiated) - horizontal

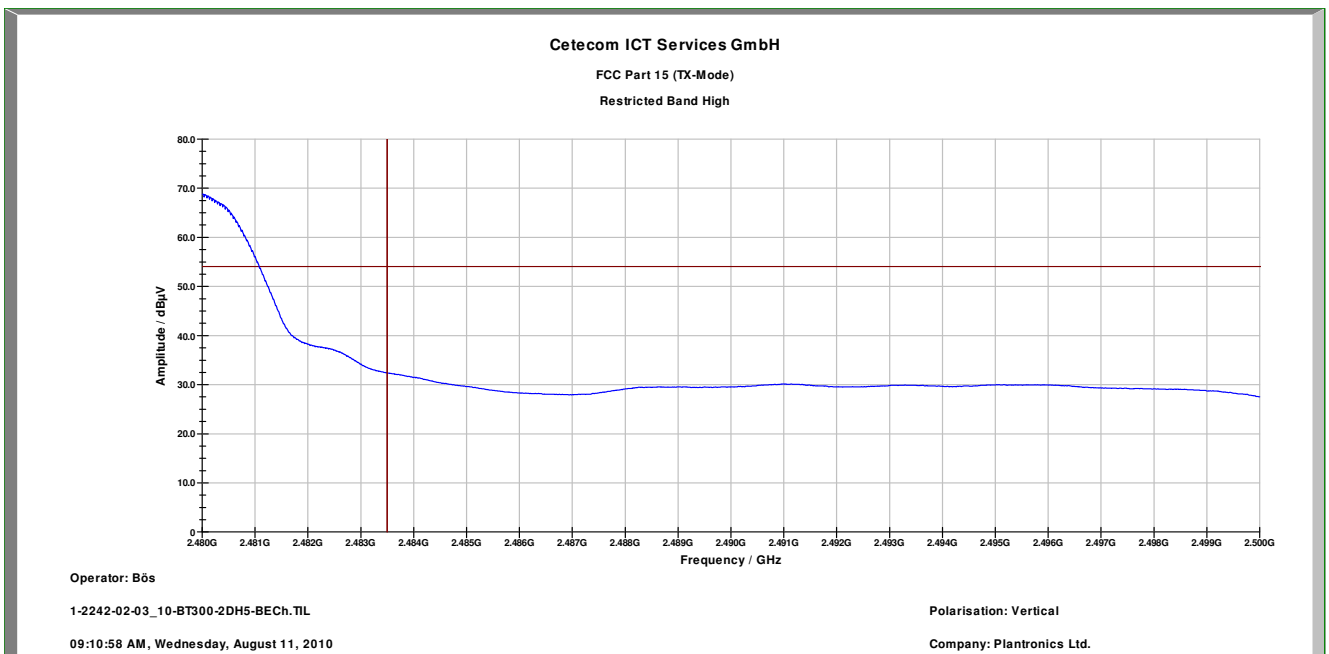

Plot 9: Lower Restricted Band / 8DPSK (radiated) - vertical

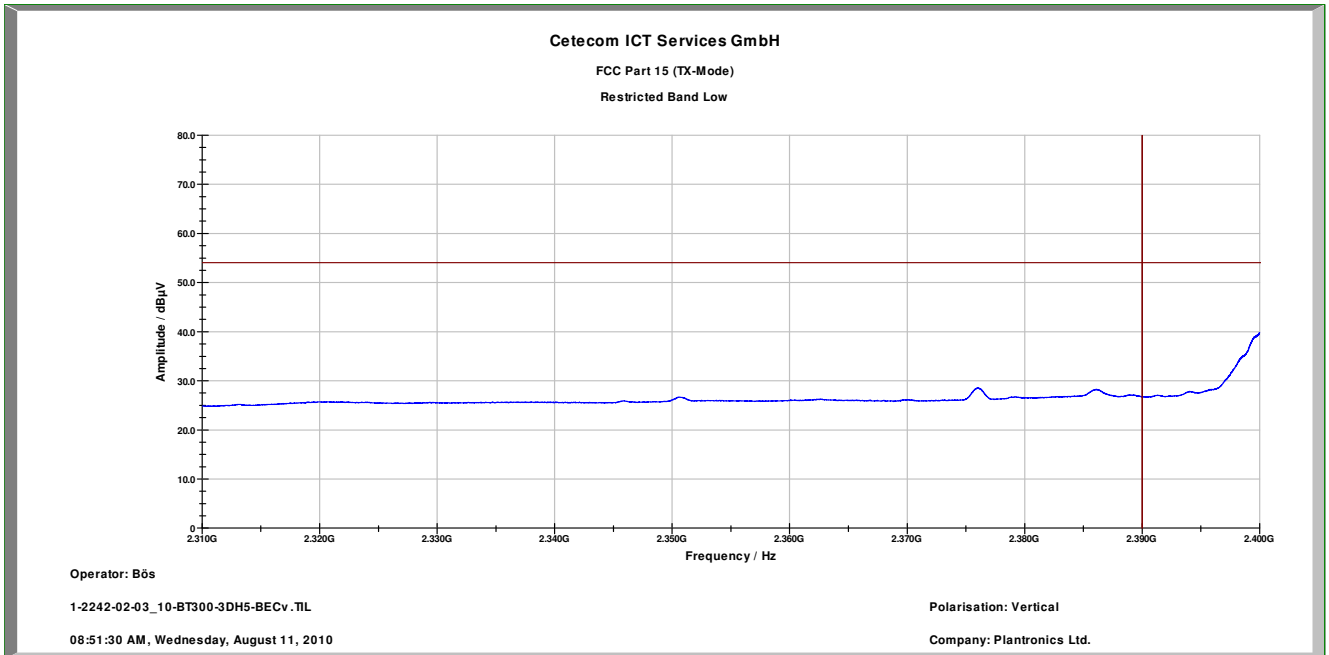

Plot 10: Lower Restricted Band / 8DPSK (radiated) - horizontal

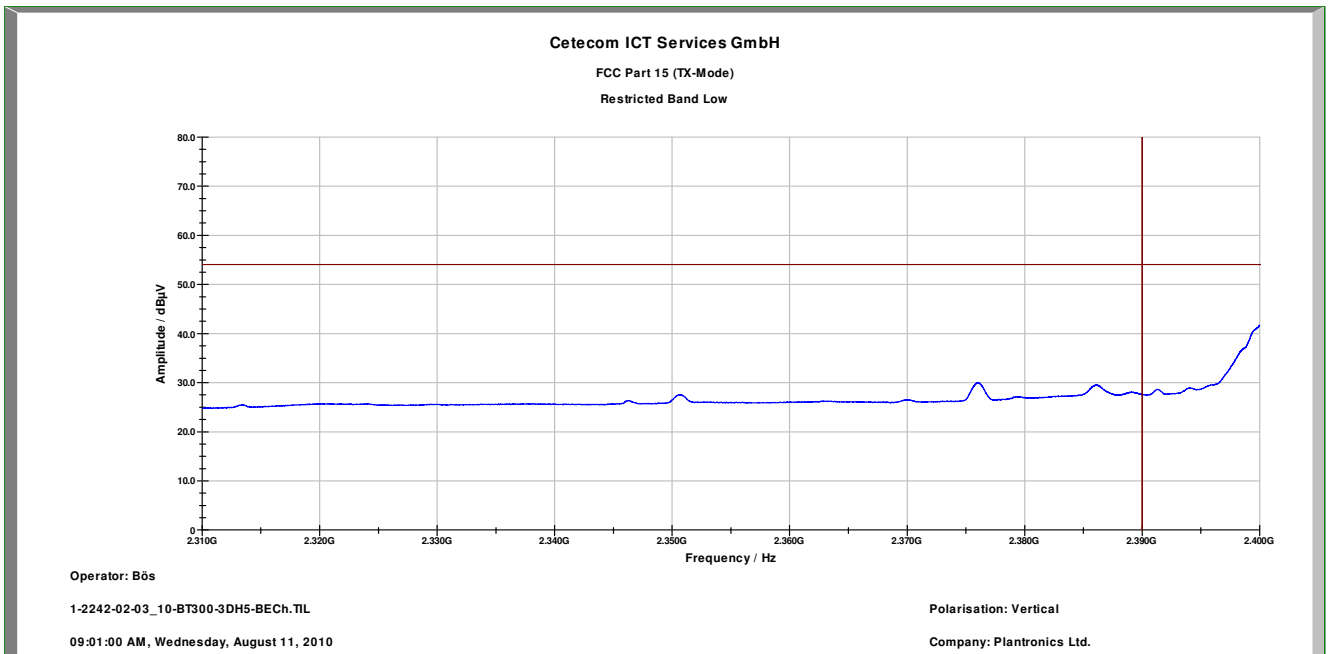

Plot 11: Upper Restricted Band / 8DPSK (radiated) - vertical

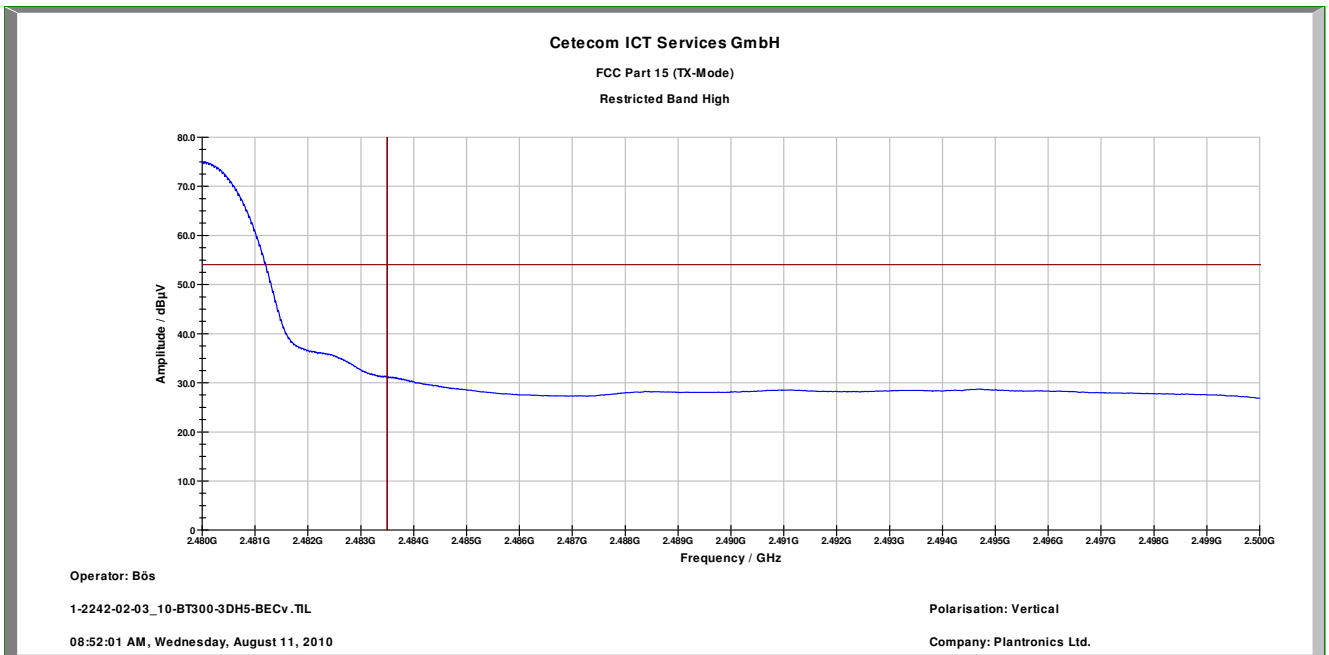

Plot 12: Upper Restricted Band / 8DPSK (radiated) - horizontal

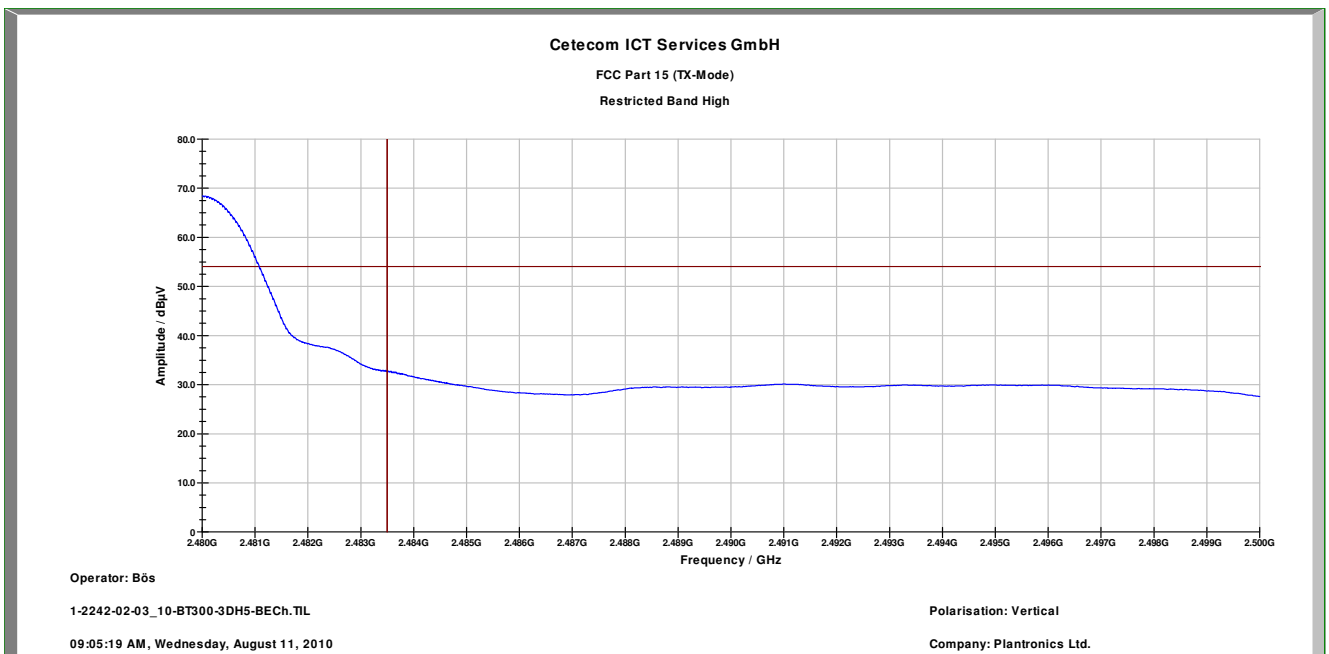

10.10 TX spurious emissions conducted

Description:

Measurement of the conducted spurious emissions in transmit mode. The EUT is set to single channel mode and the transmit channel is channel 00, channel 39 and channel 78. The measurement is repeated for all modulations.

Measurement:

Measurement parameter	
Detector:	Peak
Sweep time:	Auto
Video bandwidth:	F < 1 GHz: 100 kHz F > 1 GHz: 1 MHz
Resolution bandwidth:	F < 1 GHz: 100 kHz F > 1 GHz: 1 MHz
Span:	9 kHz to 25 GHz
Trace-Mode:	Max Hold

Limits:

FCC	IC
CFR Part 15.247(d)	RSS 210, Issue 7, A 8.5
TX Spurious Emissions Conducted	
<p>In any 100 kHz bandwidth outside the frequency band in which the spread spectrum or digitally modulated intentional radiator is operating, the radio frequency power that is produced by the intentional radiator shall be at least 20 dB below that in the 100 kHz bandwidth within the band that contains the highest level of the desired power, based on either an RF conducted or a radiated measurement. Attenuation below the general limits specified in Section 15.209(a) is not required</p>	

Result: Also see plots

TX Spurious Emissions Conducted					
GFSK - mode					
f [MHz]		amplitude of emission [dBm]	limit max. allowed emission power	actual attenuation below frequency of operation [dB]	results
2402		2.2	30 dBm		Operating frequency
		<i>No critical peaks found</i>			complies
			-20 dBc		
2441		1.8	30 dBm		Operating frequency
		<i>No critical peaks found</i>			complies
			-20 dBc		
2480		1.4	30 dBm		Operating frequency
		<i>No critical peaks found</i>			complies
			-20 dBc		
Measurement uncertainty			± 3 dB		

TX Spurious Emissions Conducted					
Pi/4-DQPSK - mode					
f [MHz]		amplitude of emission [dBm]	limit max. allowed emission power	actual attenuation below frequency of operation [dB]	results
2402		2.5	30 dBm		Operating frequency
		<i>No critical peaks found</i>			complies
			-20 dBc		
2441		1.8	30 dBm		Operating frequency
		<i>No critical peaks found</i>			complies
			-20 dBc		
2480		1.1	30 dBm		Operating frequency
		<i>No critical peaks found</i>			complies
			-20 dBc		
Measurement uncertainty			± 3dB		

TX Spurious Emissions Conducted					
8DPSK - mode					
f [MHz]		amplitude of emission [dBm]	limit max. allowed emission power	actual attenuation below frequency of operation [dB]	results
2402		2.6	30 dBm		Operating frequency
<i>No critical peaks found</i>			-20 dBc		complies
2441		1.8	30 dBm		Operating frequency
<i>No critical peaks found</i>			-20 dBc		complies
2480		1.2	30 dBm		Operating frequency
<i>No critical peaks found</i>			-20 dBc		complies
Measurement uncertainty		± 3dB			

Result: The result of the measurement is passed.

Plot 1: Channel 00 / GFSK

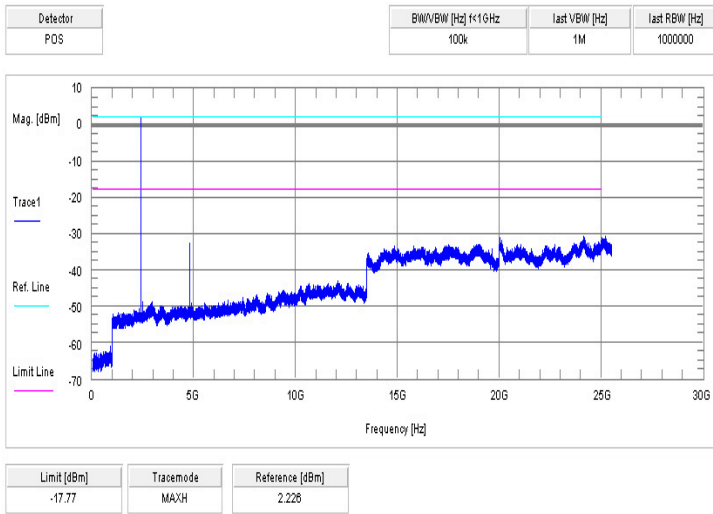

Plot 2: Channel 39 / GFSK

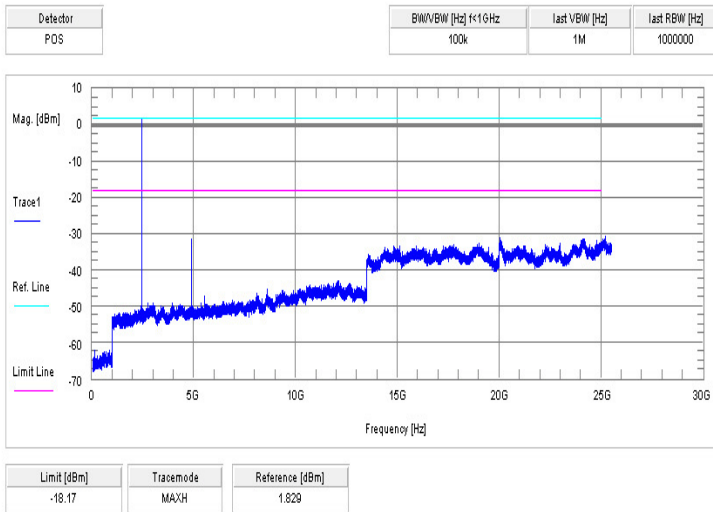

Plot 3: Channel 78 / GFSK

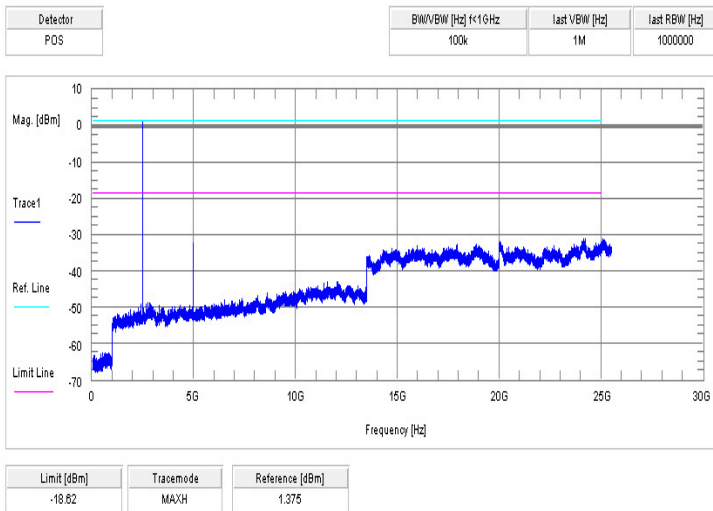

Plot 4: Channel 00 / Pi/4 DQPSK

Detector	BW/VBW [Hz] f<1GHz	Last V/BW [Hz]	Last RBW [Hz]
POS	100k	1M	1000000

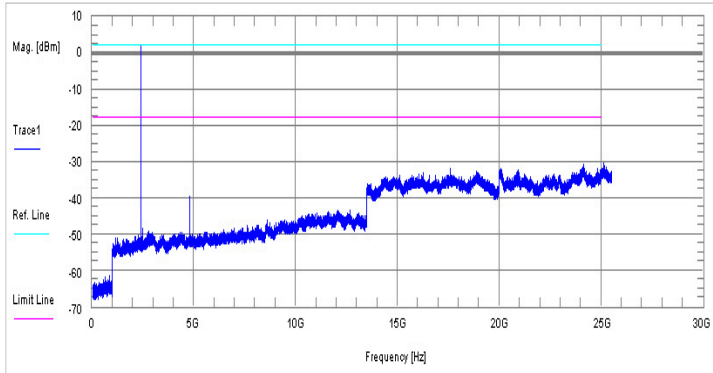

Limit [dBm]	Tracemode	Reference [dBm]
-17.76	MAXH	2.245

Plot 5: Channel 39 / Pi/4 DQPSK

Detector	BW/VBW [Hz] f<1GHz	Last V/BW [Hz]	Last RBW [Hz]
POS	100k	1M	1000000

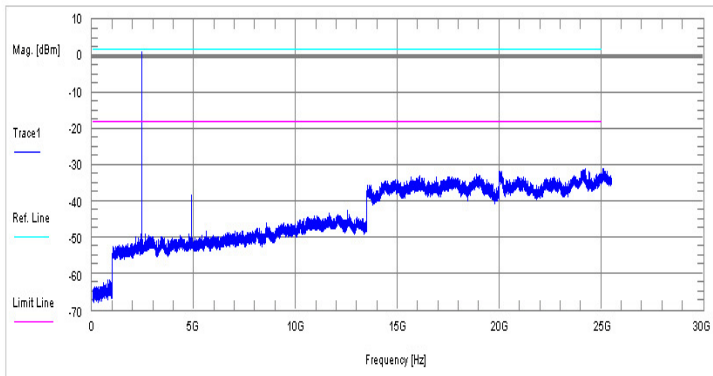

Limit [dBm]	Tracemode	Reference [dBm]
-18.19	MAXH	1.807

Plot 6: Channel 78 / Pi/4 DQPSK

Detector	BW/VBW [Hz] f<1GHz	Last V/BW [Hz]	Last RBW [Hz]
POS	100k	1M	1000000

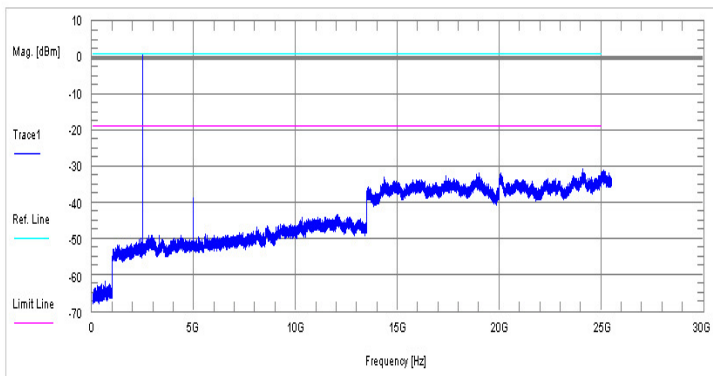

Limit [dBm]	Tracemode	Reference [dBm]
-18.91	MAXH	1.089

Plot 7: Channel 00 / 8DPSK

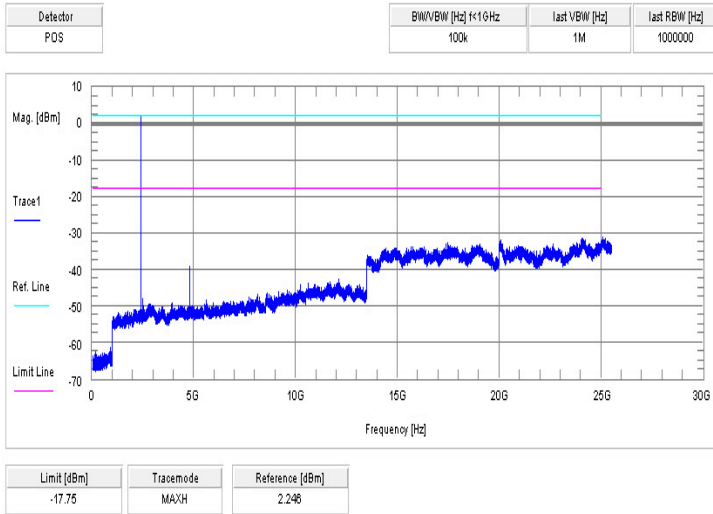

Plot 8: Channel 00 / 8DPSK

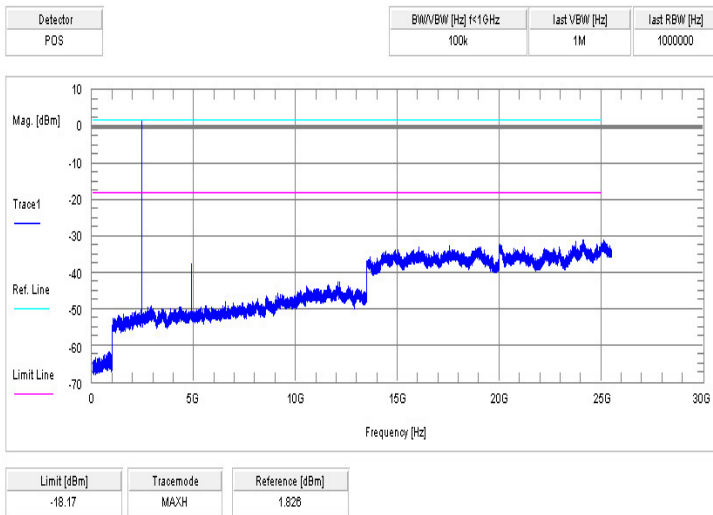

Plot 9: Channel 00 / 8DPSK

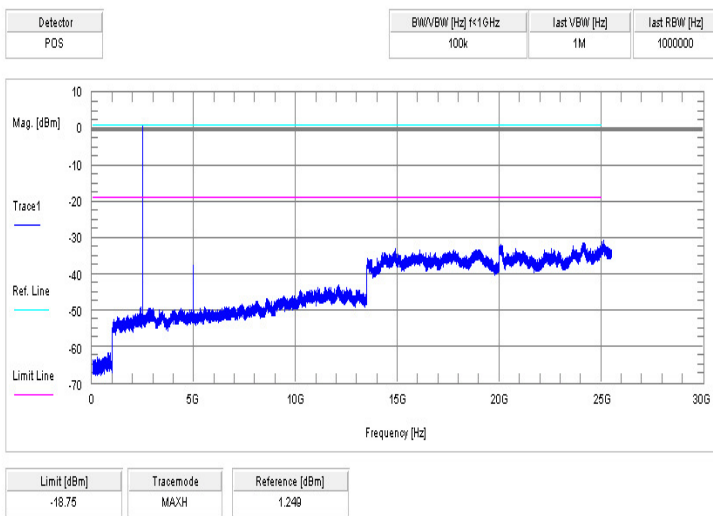

10.11 TX spurious emissions radiated

Description:

Measurement of the radiated spurious emissions in transmit mode. The EUT is set to single channel mode and the transmit channel is channel 00, channel 39 and channel 78. The prescans are performed in the mode with the highest output power. If spurious emissions are detected remeasurements in all modes are performed. The result table shows the worst case results of the remeasurements.

The plots only show the results of the prescans. The remeasured values are not marked in the plots and only documented in the result table.

Measurement:

Measurement parameter	
Detector:	Peak
Sweep time:	Auto
Video bandwidth:	Sweep: 100 kHz Remeasurement: 10 Hz
Resolution bandwidth:	F < 1 GHz: 100 kHz F > 1 GHz: 1 MHz
Span:	30 MHz to 25 GHz
Trace-Mode:	Max Hold

Limits:

FCC		IC	
CFR Part 15.247(d)		RSS 210, Issue 7, A 8.5	
TX Spurious Emissions Radiated			
<p>In any 100 kHz bandwidth outside the frequency band in which the spread spectrum or digitally modulated intentional radiator is operating, the radio frequency power that is produced by the intentional radiator shall be at least 20 dB below that in the 100 kHz bandwidth within the band that contains the highest level of the desired power, based on either an RF conducted or a radiated measurement. Attenuation below the general limits specified in Section 15.209(a) is not required. In addition, radiated emissions which fall in the restricted bands, as defined in §15.205(a), must also comply with the radiated emission limits specified in §15.209(a) (see §15.205(c)).</p>			
§15.209			
Frequency (MHz)	Field Strength (dBµV/m)	Measurement distance	
30 - 88	30.0	10	
88 - 216	33.5	10	
216 - 960	36.0	10	
Above 960	54.0	3	

Result: Also see plots

TX Spurious Emissions Radiated [dBμV/m]								
2402 MHz			2441 MHz			2480 MHz		
F [MHz]	VBW [Hz]	Level [dBμV/m]	F [MHz]	VBW [Hz]	Level [dBμV/m]	F [MHz]	VBW [Hz]	Level [dBμV/m]
3000	10	35.0	3253	10	30.8	1653	10	36.5
4804	10	47.9	4882	10	46.3	3305	10	27.8
						4960	10	44.8
Measurement uncertainty			± 3 dB					

Result: The result of the measurement is passed.

Plot 1: 30 MHz to 1 GHz / Channel 00 (horizontal/vertical)

Common Information

EUT: BT300 + WA-30A 19K
 Serial Number: Prototype
 Test Description: FCC part 15 C
 Operating Conditions: BT-Testmode; CH 00
 Operator Name: Lang
 Comment: Powered via USB from Notebook

Scan Setup: STAN_Fin [EMI radiated]

Hardware Setup: Electric Field (NOS)
 Level Unit: dBµV/m

Subrange **Detectors** **IF Bandwidth** **Meas. Time** **Receiver**
 0 MHz - 1,05 GHz QuasiPeak 120 kHz 15 s Receiver

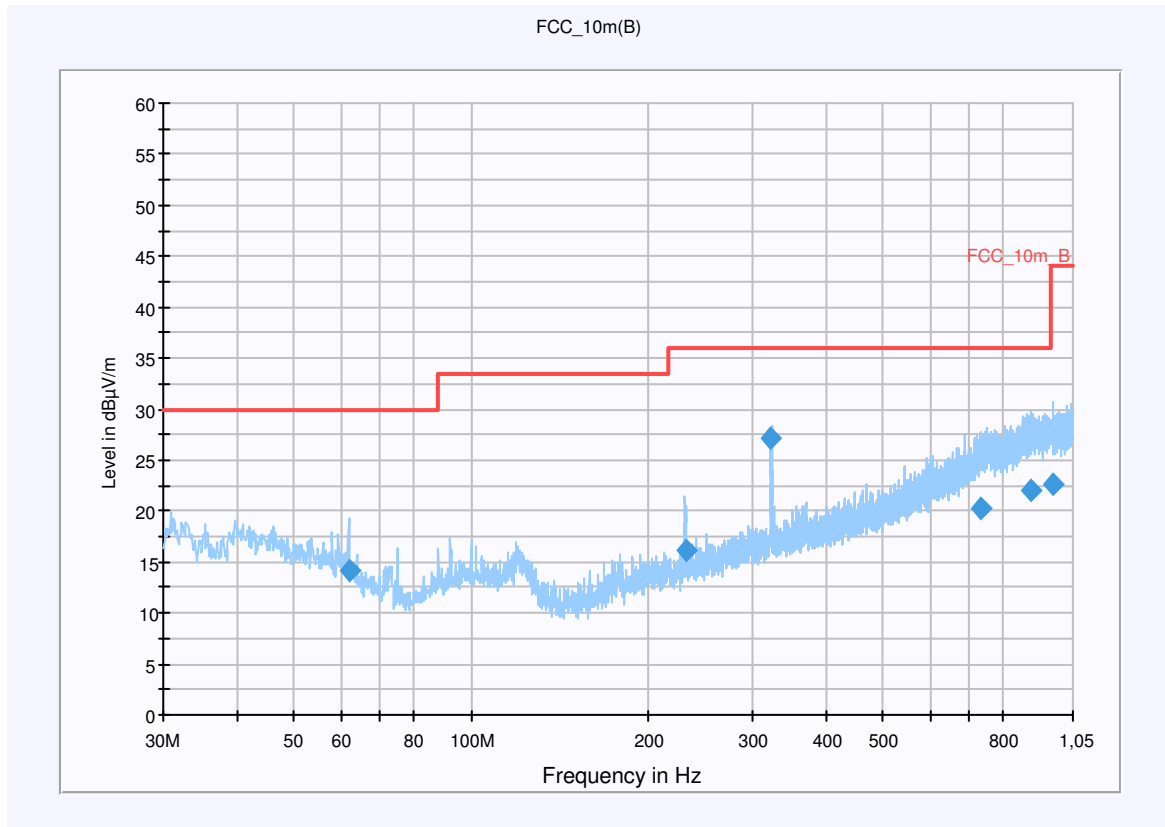

Final Result 1

Frequency (MHz)	QuasiPeak (dBµV/m)	Meas. Time (ms)	Bandwidth (kHz)	Antenna height (cm)	Polarity	Turntable position (deg)	Corr. (dB)	Margin (dB)	Limit (dBµV/m)	Comment
61.997400	14.3	15000.000	120.000	237.0	V	210.0	11.1	15.7	30.0	
230.747700	16.1	15000.000	120.000	117.0	V	31.0	12.7	19.9	36.0	
322.994400	27.1	15000.000	120.000	251.0	H	31.0	15.2	8.9	36.0	
733.509750	20.3	15000.000	120.000	400.0	H	171.0	23.3	15.7	36.0	
889.189500	22.1	15000.000	120.000	400.0	H	252.0	25.1	13.9	36.0	
970.765350	22.6	15000.000	120.000	200.0	H	107.0	25.5	21.4	44.0	

Hardware Setup: EMI radiated\Electric Field (NOS) - [EMI radiated]

Subrange 1

Frequency Range: 30 MHz - 2 GHz

Receiver: Receiver [ESCI 3]
@ GPIB0 (ADR 20), SN 100083/003, FW 4.32

Signal Path: without Notch
FW 1.0

Antenna: VULB 9163
SN 9163-295, FW ---
Correction Table (vertical): VULP6113
Correction Table (horizontal): VULP6113
Correction Table: Cable_EN_1GHz (1005)

Antenna Tower: Tower [EMCO 2090 Antenna Tower]
@ GPIB0 (ADR 8), FW REV 3.12

Turntable: Turntable [EMCO Turntable]
@ GPIB0 (ADR 9), FW REV 3.12

EMC 32 Version 8.10.00

Plot 2: 1 GHz to 12.75 GHz / Channel 00 (horizontal/vertical)

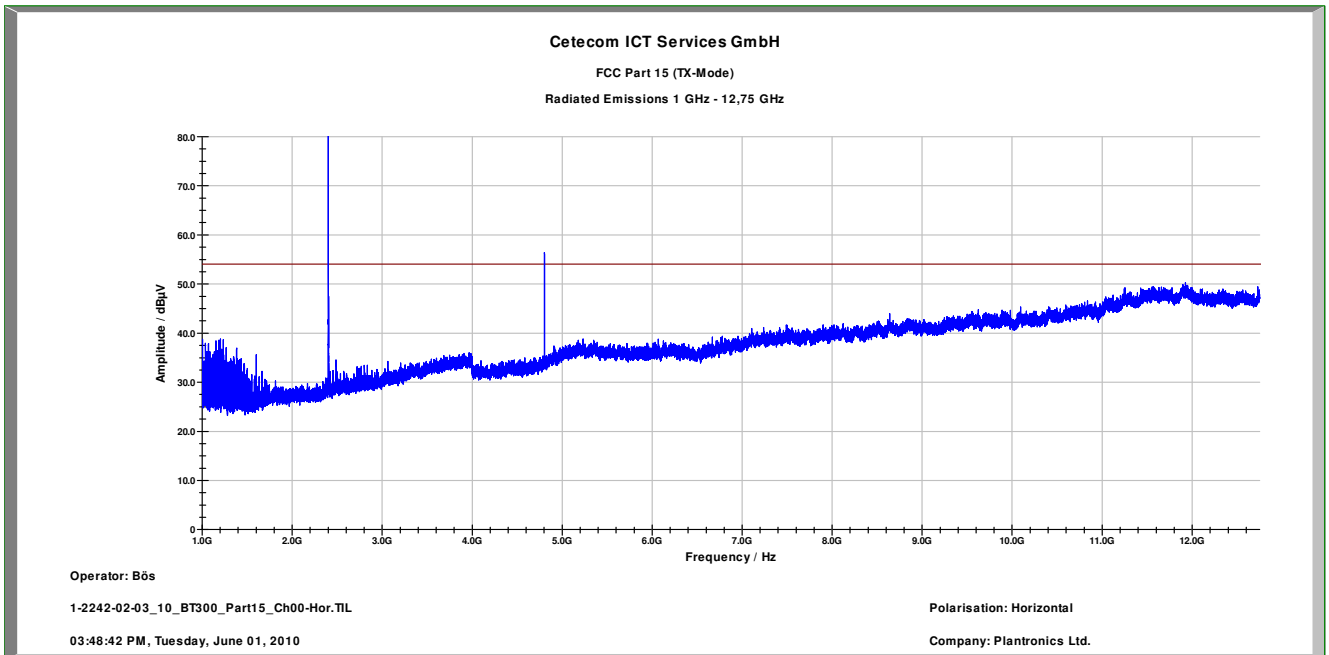

Plot 3: 12 GHz to 25 GHz / Channel 00 (horizontal/vertical) – valid for all channels

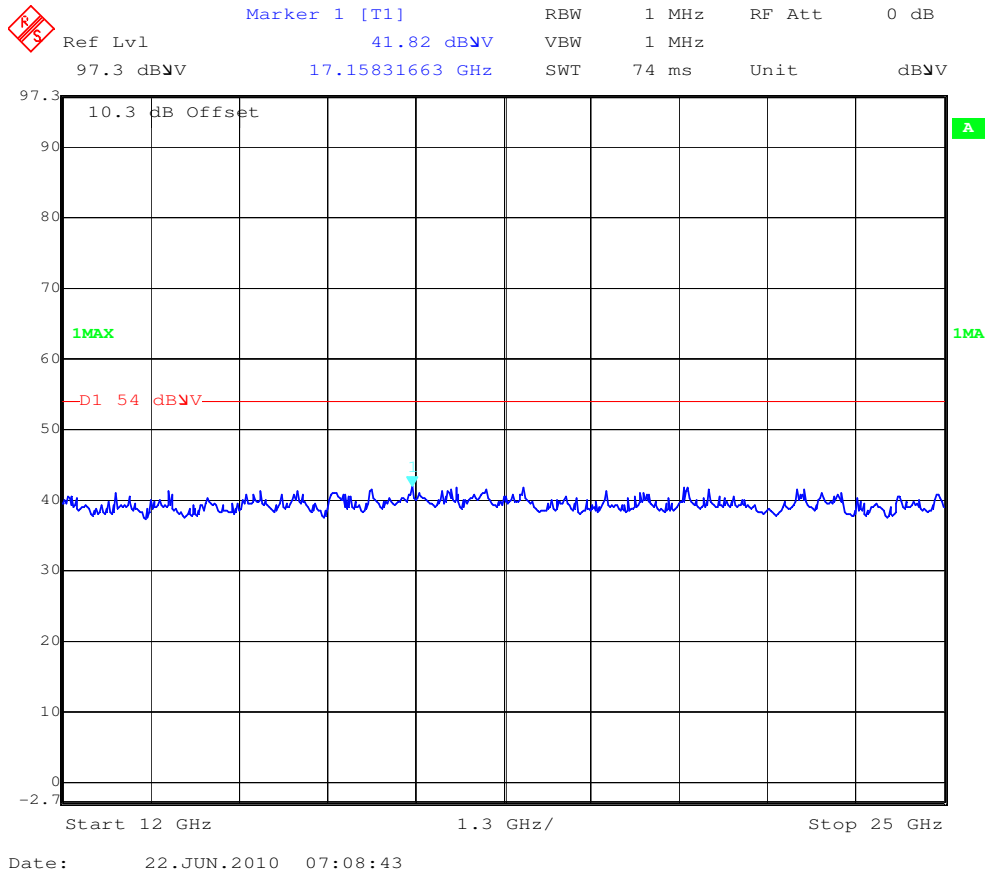

Plot 4: 30 MHz to 1 GHz / Channel 39 (horizontal/vertical)

Common Information

EUT: BT300 + WA-30A 19K
 Serial Number: Prototype
 Test Description: FCC part 15 C
 Operating Conditions: BT-Testmode; CH 39
 Operator Name: Lang
 Comment: Powered via USB from Notebook

Scan Setup: STAN_Fin [EMI radiated]

Hardware Setup: Electric Field (NOS)
 Level Unit: dBµV/m

Subrange	Detectors	IF Bandwidth	Meas. Time	Receiver
30 MHz - 1,05 GHz	QuasiPeak	120 kHz	15 s	Receiver

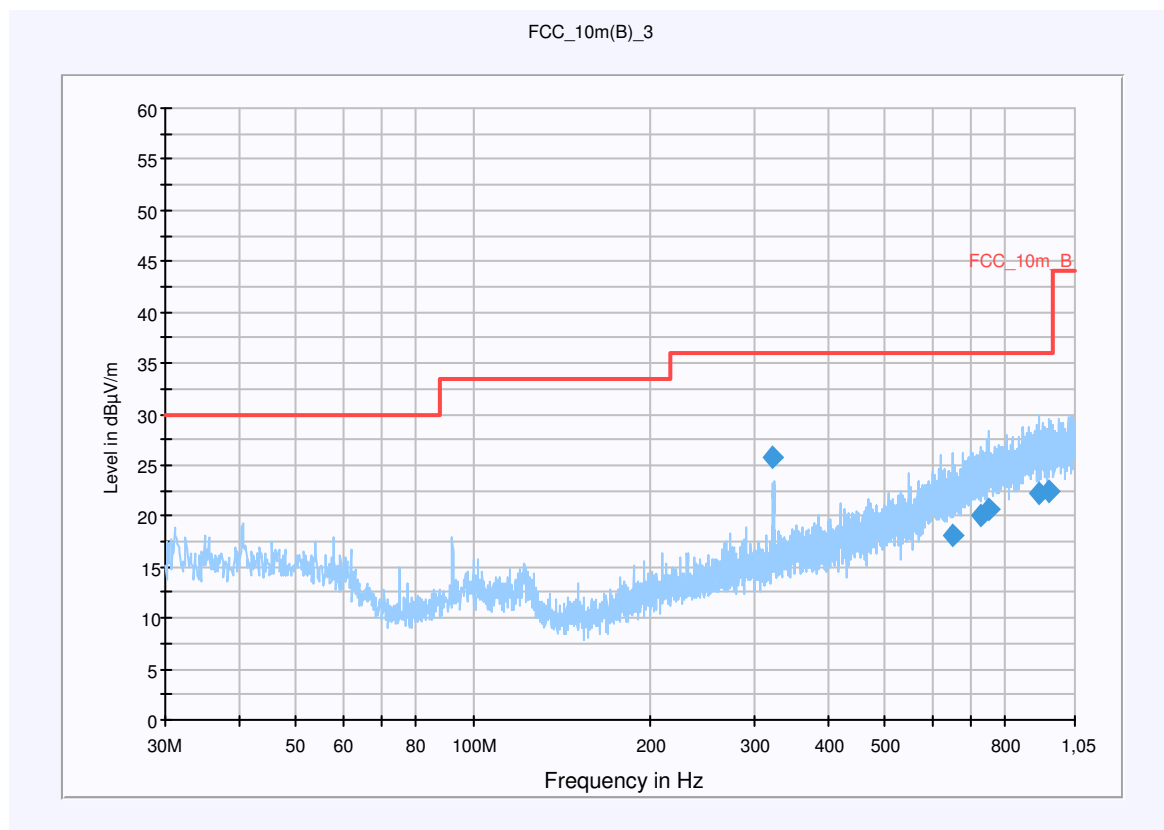

Final Result 1

Frequency (MHz)	QuasiPeak (dBµV/m)	Meas. Time (ms)	Bandwidth (kHz)	Antenna height (cm)	Polarity	Turntable position (deg)	Corr. (dB)	Margin (dB)	Limit (dBµV/m)	Comment
322.800750	25.8	15000.000	120.000	220.0	H	265.0	15.2	10.2	36.0	
652.655100	18.0	15000.000	120.000	220.0	V	192.0	21.2	18.0	36.0	
728.592750	20.1	15000.000	120.000	220.0	H	-3.0	23.2	15.9	36.0	
750.591450	20.6	15000.000	120.000	151.0	H	0.0	23.7	15.4	36.0	
911.277900	22.3	15000.000	120.000	220.0	H	86.0	25.2	13.7	36.0	
948.000450	22.4	15000.000	120.000	120.0	V	266.0	25.3	13.6	36.0	

Hardware Setup: EMI radiated\Electric Field (NOS) - [EMI radiated]

Subrange 1

Frequency Range: 30 MHz - 2 GHz

Receiver: Receiver [ESCI 3]
@ GPIB0 (ADR 20), SN 100083/003, FW 4.32

Signal Path: without Notch
FW 1.0

Antenna: VULB 9163
SN 9163-295, FW ---
Correction Table (vertical): VULP6113
Correction Table (horizontal): VULP6113
Correction Table: Cable_EN_1GHz (1005)

Antenna Tower: Tower [EMCO 2090 Antenna Tower]
@ GPIB0 (ADR 8), FW REV 3.12

Turntable: Turntable [EMCO Turntable]
@ GPIB0 (ADR 9), FW REV 3.12

EMC 32 Version 8.10.00

Plot 5: 1 GHz to 12.75 GHz / Channel 39 (horizontal/vertical)

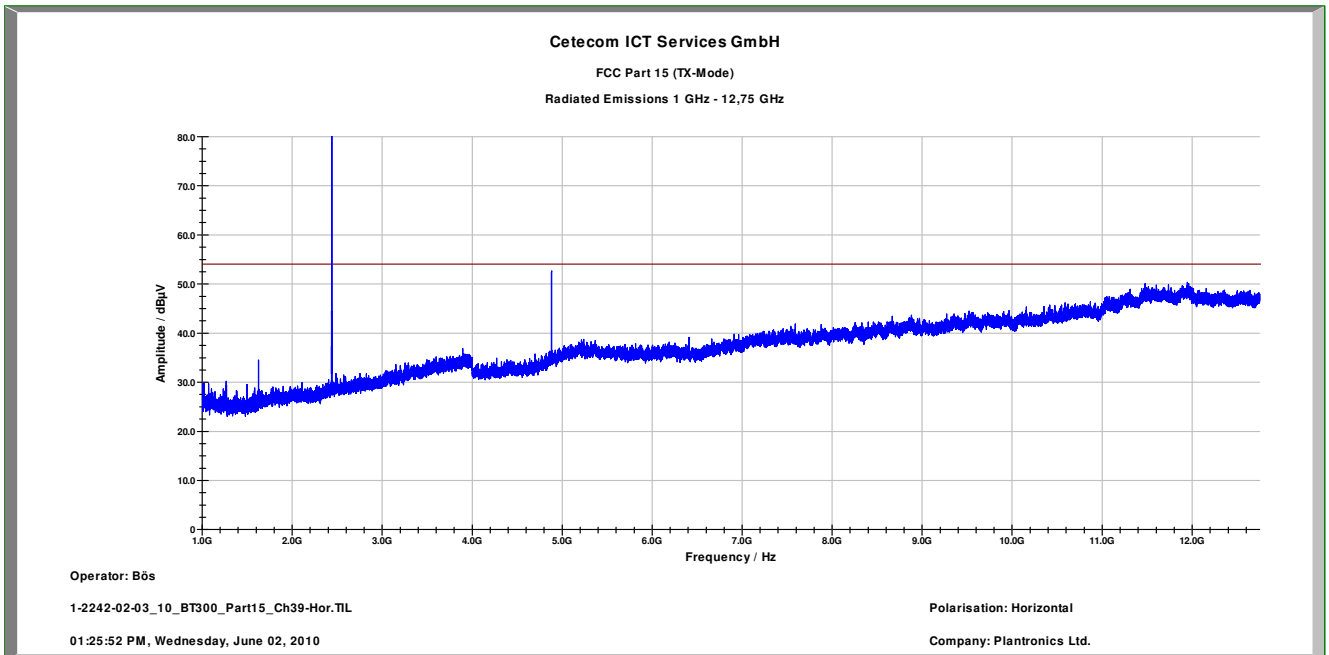

Plot 6: 30 MHz to 1 GHz / Channel 78 (horizontal/vertical)

Common Information

EUT: BT300 + WA-30A 19K
 Serial Number: Prototype
 Test Description: FCC part 15 C
 Operating Conditions: BT-Testmode; CH 78
 Operator Name: Lang
 Comment: Powered via USB from Notebook

Scan Setup: STAN_Fin [EMI radiated]

Hardware Setup: Electric Field (NOS)
 Level Unit: dBµV/m

Subrange	Detectors	IF Bandwidth	Meas. Time	Receiver
30 MHz - 1,05 GHz	QuasiPeak	120 kHz	15 s	Receiver

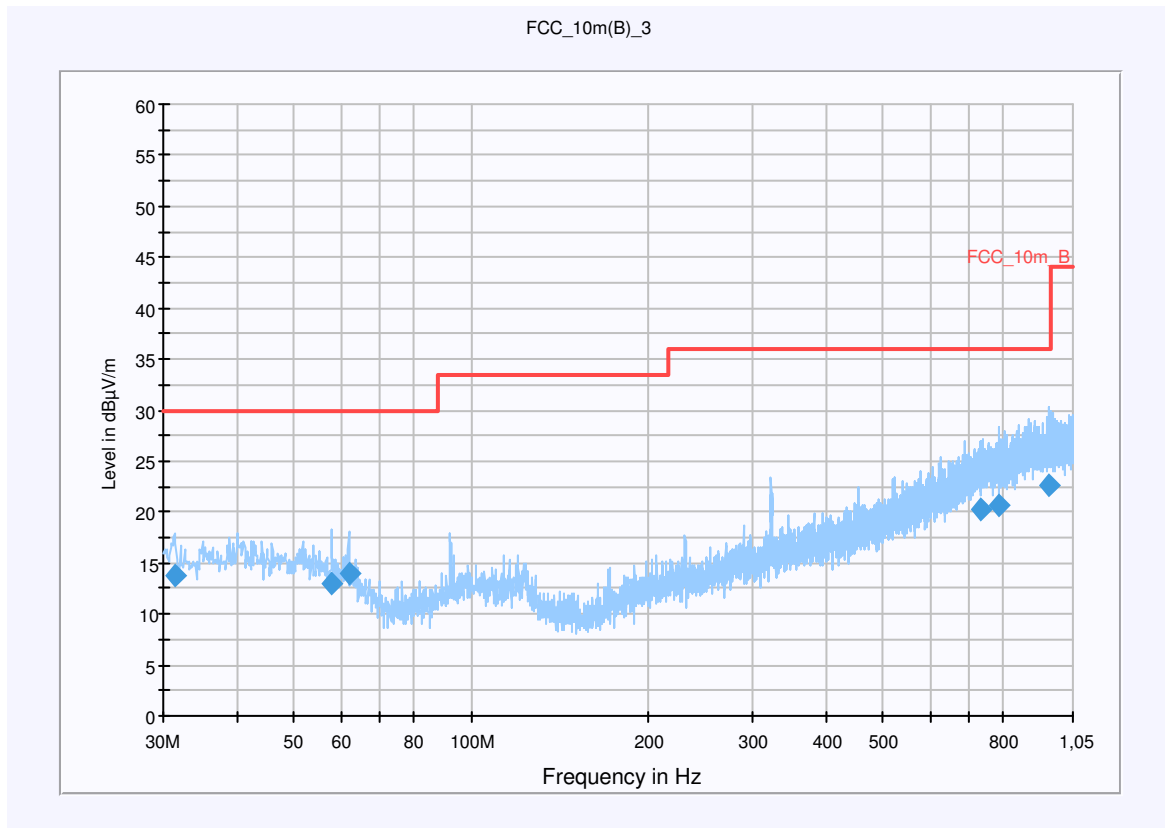

Final Result 1

Frequency (MHz)	QuasiPeak (dBµV/m)	Meas. Time (ms)	Bandwidth (kHz)	Antenna height (cm)	Polarity	Turntable position (deg)	Corr. (dB)	Margin (dB)	Limit (dBµV/m)	Comment
31.403400	13.8	15000.000	120.000	98.0	V	170.0	12.7	16.2	30.0	
58.028400	12.9	15000.000	120.000	126.0	V	183.0	12.1	17.1	30.0	
62.002200	14.0	15000.000	120.000	220.0	V	279.0	11.1	16.0	30.0	
734.224350	20.3	15000.000	120.000	220.0	H	176.0	23.3	15.7	36.0	
787.099650	20.6	15000.000	120.000	220.0	V	259.0	23.8	15.4	36.0	
957.115650	22.6	15000.000	120.000	125.0	V	107.0	25.4	13.4	36.0	

Hardware Setup: EMI radiated\Electric Field (NOS) - [EMI radiated]

Subrange 1

Frequency Range: 30 MHz - 2 GHz

Receiver: Receiver [ESCI 3]
@ GPIB0 (ADR 20), SN 100083/003, FW 4.32

Signal Path: without Notch
FW 1.0

Antenna: VULB 9163
SN 9163-295, FW ---
Correction Table (vertical): VULP6113
Correction Table (horizontal): VULP6113
Correction Table: Cable_EN_1GHz (1005)

Antenna Tower: Tower [EMCO 2090 Antenna Tower]
@ GPIB0 (ADR 8), FW REV 3.12

Turntable: Turntable [EMCO Turntable]
@ GPIB0 (ADR 9), FW REV 3.12

EMC 32 Version 8.10.00

Plot 7: 1 GHz to 12.75 GHz / Channel 78 (horizontal/vertical)

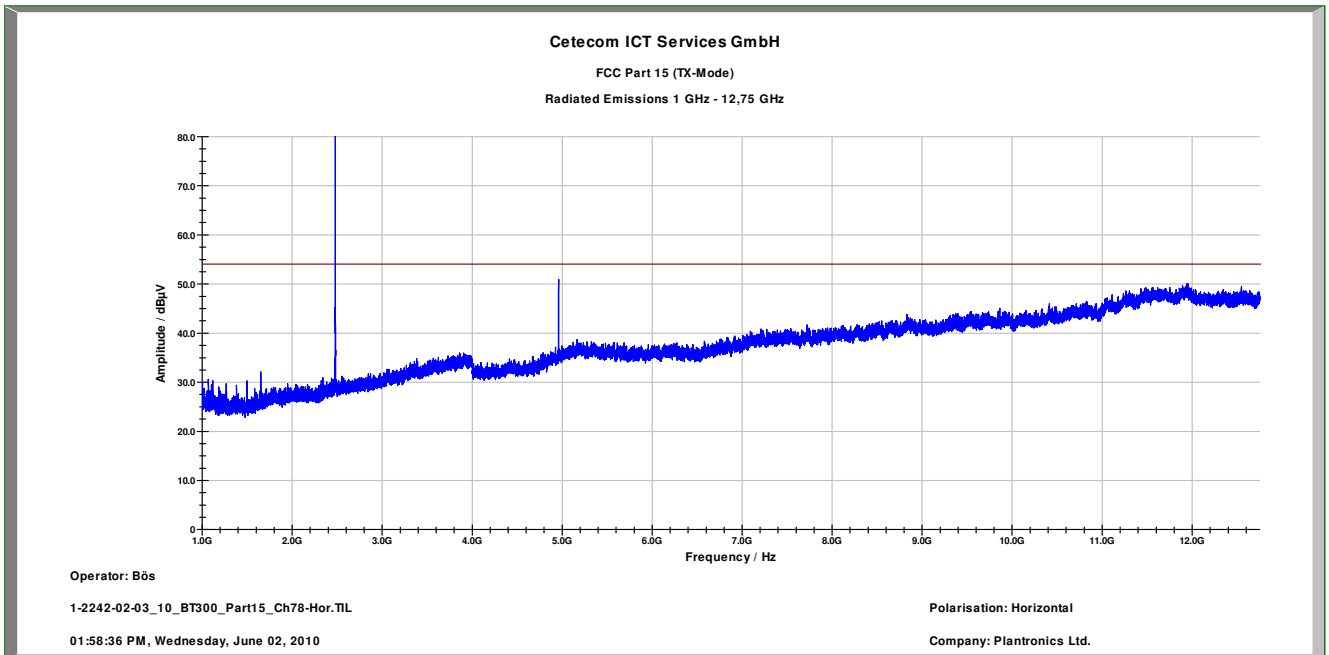

10.12 TX spurious emissions radiated < 30 MHz

Description:

Measurement of the radiated spurious emissions in transmit mode below 30 MHz. The EUT is set to single channel mode and the transmit channel is channel 39. This measurement is representative for all channels and modes. If critical peaks are found channel 00 and channel 78 will be measured too. The measurement is performed in the mode with the highest output power. The limits are recalculated to a measurement distance of 3 m with 40 dB/decade according CFR Part 2.

Measurement:

Measurement parameter	
Detector:	Quasi Peak
Sweep time:	Auto
Video bandwidth:	F < 150 kHz: 200 Hz F > 150 kHz: 9 kHz
Resolution bandwidth:	F < 150 kHz: 1 kHz F > 150 kHz: 100 kHz
Span:	9 kHz to 30 MHz
Trace-Mode:	Max Hold

Limits:

FCC		IC	
CFR Part 15.209(a)		RSS 210, Issue 7, 2.2	
TX Spurious Emissions Radiated < 30 MHz			
Frequency (MHz)	Field Strength (dBµV/m)	Measurement distance	
0.009 – 0.490	2400/F(kHz)	300	
0.490 – 1.705	24000/F(kHz)	30	
1.705 – 30.0	30	30	

Result: Also see plot

TX Spurious Emissions Radiated < 30 MHz [dBµV/m]		
F [MHz]	Detector	Level [dBµV/m]
No critical peaks found		
Measurement uncertainty	± 3 dB	

Result: The result of the measurement is passed.

Plot 1: 9 kHz to 30 MHz / Channel 39 (valid for all channels and modes)

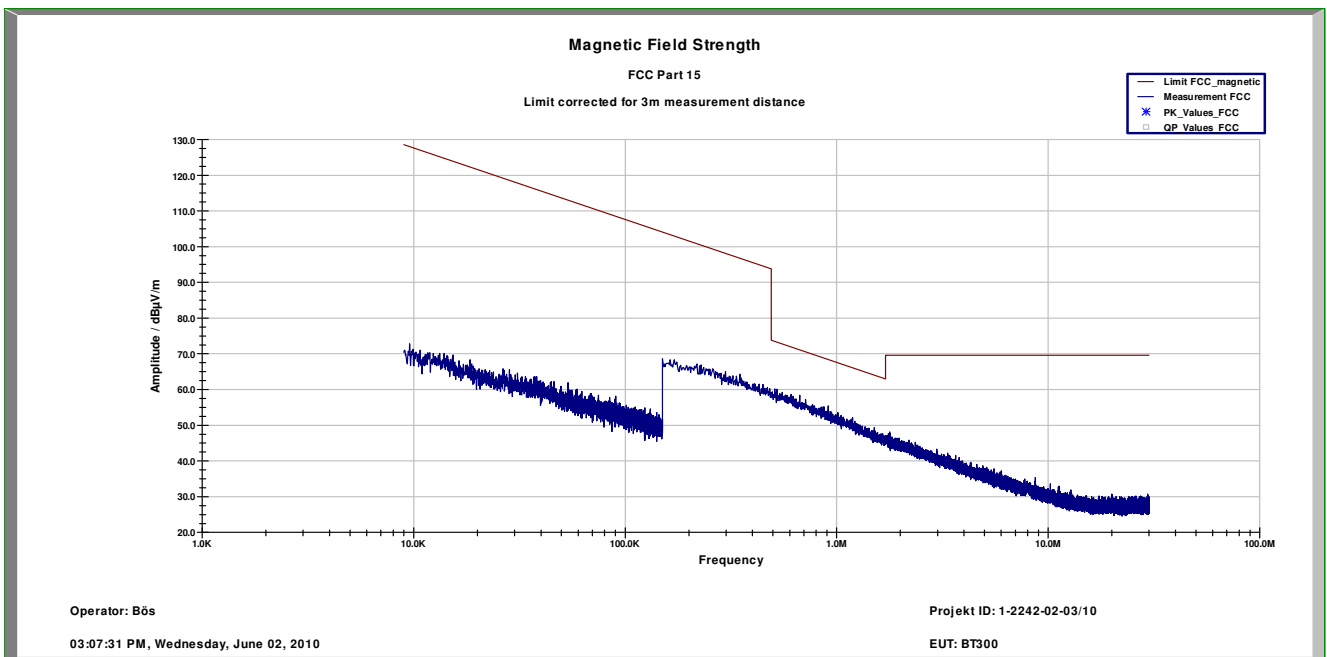

11 Test equipment and ancillaries used for tests

In order to simplify the identification of the equipment used at each specific test, each item of test equipment and ancillaries are provided with an identifier or number in the equipment list below.

Typically, the calibrations of the test apparatus are commissioned to and performed by an accredited calibration laboratory. The calibration intervals are determined in accordance with the DIN EN ISO/IEC 17025. In addition to the external calibrations, the laboratory executes comparison measurements with other calibrated test systems or effective verifications. Weekly chamber inspections and range calibrations are performed. Where possible, rf-generating and signalling equipment as well as measuring receivers and analyzers are connected to an external high-precision 10 MHz reference (GPS-based or rubidium frequency standard).

No.	Labor / Item	Equipment	Type	Manufact.	Serial No.	INV. No Cetecom	Kal. Art	Last Calibration	Next Calibration
1	n. a.	DC power supply, 60Vdc, 50A, 1200 W	6032A	HP Meßtechnik	2818A03450	300001040	Ve	01.2009	01.2012
2	n. a.	PowerAttenuator	8325	Byrd	1530	300001595			
3	n. a.	Double-Ridged Waveguide Horn Antenna 1- 18.0GHz	3115	EMCO	8812-3088	300001032	vIKI!	03.2009	03.2011
4	n. a.	Active Loop Antenna	6502	EMCO	2210	300001015	ne		
5	n. a.	Anechoic chamber		MWB	87400/02	300000996			
6	Spec.A. 2_2e	System rack for EMI measurement solution	85900	HP I.V.	*	300000222	ne		
7	9	Artificial Mains 9 kHz to 30 MHz, 4 x 25 Ampere	ESH3-Z5	R&S	828576/020	300001210	Ve		
8	n. a.	Relais Matrix	3488A	HP Meßtechnik	2719A15013	300001156	ne		
9	n. a.	Relais Matrix	PSU	R&S	890167/024	300001168	ne		
10	n. a.	Isolating Transformer	RT5A	Grundig	9242	300001263	ne		
11	n. a.	Three-Way Power Splitter, 50 Ohm	11850C	HP Meßtechnik		300000997	ne		
12	n. a.	Switch / Control Unit	3488A	HP	2605e08770	300001443	ne		
13	n. a.	Band Reject filter	WRCG1855/1910-1835/1925-40/8SS	Wainwright	7	300003350	ev		
14	n. a.	Band Reject filter	WRCG2400/2483-2375/2505-50/10SS	Wainwright	11	300003351	ev		
15	n. a.	TILE-Software Emission	Quantum Change, Modell TILE-ICS/FULL	EMCO	none	300003451	ne		
16	n. a.	Highpass Filter	WHKX2.9/18G-12SS	Wainwright	1	300003492	ev		
17	n. a.	Highpass Filter	WHK1.1/15G-10SS	Wainwright	3	300003255	ev		
18	n. a.	Highpass Filter	WHKX7.0/18G-8SS	Wainwright	18	300003789	ne		
19	n. a.	PSA Spectrum Analyzer 3 Hz - 26.5 GHz	E4440A	Agilent Technologies	MY48250080	300003812	k	08.2008	08.2010
20	n. a.	MXG Microwave Analog Signal Generator	N5183A	Agilent Technologies	MY47420220	300003813	k	08.2008	08.2010
21	n. a.	RF Filter Section 9kHz - 1GHz	N9039A	Agilent Technologies	MY48260003	300003825	vIKI!	08.2008	08.2010
22	n. a.	TRIOLOG Broadband Test-Antenna 30 MHz - 3 GHz	VULB9163	Schwarzbeck	371	300003854	vIKI!	12.2008	12.2010
23	n. a.	CBT-K57 Software-Option for CBT/CBT32	CBT-K57	R&S	101051	300003910	ne		
24	n. a.	Switch / Control	3488A	HP		300000929	ne		

		Unit		Meßtechnik					
25	n. a.	Signal Analyzer 20Hz-26,5GHz- 150 to + 30 DBM	FSIQ26	R&S	835540/018	300002681- 0005	k	01.2010	01.2012
26	n. a.	CBT (Bluetooth® EDR Signalisierung)	CBT 1153.9000K35, CBT-B55, CBT- K55	R&S	100313	300003516	k	09.2008	09.2010
27	n. a.	Power Supply 0- 20V; 0-5A	6632B	HP	US37478366	400000117	k	08.2008	08.2010
28	45	Switch-Unit	3488A	HP Meßtechnik	2719A14505	300000368	g		
29	50	DC power supply, 60Vdc, 50A, 1200 W	6032A	HP Meßtechnik	2920A04466	300000580	k	01.2009	01.2011
30	n. a.	software	SPS_PHE 1.4f	Spitzberger & Spieß	B5981; 5D1081;B5979	300000210	ne		
31	n. a.	EMI Test Receiver	ESCI 1166.5950.03	R&S	100083	300003312	k	01.2010	01.2012
32	n. a.	Analyzerr- Reference- System (Harmonics and Flicker)	ARS 16/1	SPS	A3509 07/0 0205	300003314	k		
33	n. a.	Amplifier	JS42-00502650- 28-5A	MITEQ	1084532	300003379	ev		
34	n. a.	Antenna Tower	Model 2175	ETS- LINDGREN	64762	300003745	izw		
35	n. a.	Positioning Controller	Model 2090	ETS- LINDGREN	64672	300003746	izw		
36	n. a.	Turntable Interface-Box	Model 105637	ETS- LINDGREN	44583	300003747	izw		
37	n. a.	TRILOG Broadband Test- Antenna 30 MHz - 3 GHz	VULB9163	Schwarzbeck	295	300003787	k		
38	n. a.	Spectrum- Analyzer	FSU26	R&S	200809	300003874	k	01.2010	01.2012

12 Photographs of the test setup

Please see photographs in Annex A to test report 1-2242-02-03/10-B

13 External photographs of the EUT

Please see photographs in Annex A to test report 1-2242-02-03/10-B

14 Internal photographs of the EUT

Please see photographs in Annex A to test report 1-2242-02-03/10-B

15 Document history

Version	Applied changes	Date of release
1.0	Initial release	2010-08-27
1.1	This test report (1-2242-02-03_10-A) replaces the former version 1-2242-02-03_10 (2010-08-27). Editorial complements and new measurements of occupied bandwidth for EDR and Dwell Time.	2010-09-23
1.2	This test report (1-2242-02-03_10-B) replaces the former version 1-2242-02-03_10-A (2010-09-23). Editorial complements and new measurements of occupied bandwidth for EDR and Dwell Time.	2010-10-01

16 Further information

Glossary

DUT	-	Device under Test
EMC	-	Electromagnetic Compatibility
EUT	-	Equipment under Test
FCC	-	Federal Communication Commission
FCC ID	-	Company Identifier at FCC
HW	-	Hardware
IC	-	Industry Canada
Inv. No.	-	Inventory number
N/A	-	not applicable
S/N	-	Serial Number
SW	-	Software