

**TYPE OF EXHIBIT:** TABLE OF CONTENTS  
**FCC PART:** 2.1033(c)(14)  
**MANUFACTURER:** RITRON, Inc.  
**MODEL:** DTX-460-0\_\_6  
**TYPE OF UNIT:** UHF Transceiver Module  
**FCC ID:** AIERIT33-4600  
**DATE:** October 19, 2011

<u>Description</u>	<u>Page</u>
List of Test Equipment Used	2
Measurement Methods	3
Description of Measurement Facility	4
Radio Frequency Output Power	5
Modulator Response	8
Clipper Filter Response	12
Modulation Limiting Curves	15
Occupied Bandwidth	19
Bandwidth Calculations/Modulation Types	25
Conducted Spurious Emissions	28
Field Strength of Spurious Emissions	32
Frequency Stability vs Temperature	39
Frequency Stability vs Supply Voltage	43
Transient Frequency Behavior	44

**TYPE OF EXHIBIT:** LIST OF TEST EQUIPMENT USED

**FCC PART:** 2.947(d)

**MANUFACTURER:** RITRON, Inc.

**MODEL:** DTX-460-0\_\_6

**TYPE OF UNIT:** UHF Transceiver Module

**FCC ID:** AIERIT33-4600

**DATE:** October 19, 2011

ITEM	MAKE/MODEL	SERIAL NO.	CAL.	NEXT CAL.
DC Power Supply	Astron VS 20M	9205017	N/A	N/A
Multimeter	BK Precision 2704A	234-008459	N/A	N/A
RF Test Set	HP 8920AB	US39225560	12/16/2010	12/16/2011
Spectrum Analyzer	Advantest R3265A	75060189	10/21/2010	10/21/2011
Spectrum Analyzer	HP 8560E	3720A02980	10/21/2010	10/21/2011
Storage Scope	Fluke PM3335	DM630034	N/A	N/A
Temp. Chamber	Delta Design 3900	0-52-R	N/A	N/A
Audio Test Set	A/P SYS-322A	SYS1-33641	N/A	N/A
Thermocouple	Triplett 320-G/P		N/A	N/A

**TYPE OF EXHIBIT:** MEASUREMENT METHODS  
**FCC PART:** 2.947  
**MANUFACTURER:** RITRON, Inc.  
**MODEL:** DTX-460-0\_\_6  
**TYPE OF UNIT:** UHF Transceiver Module  
**FCC ID:** AIERIT33-4600  
**DATE:** October 19, 2011

All of the measurements made on this device and included in this report were made per ANSI/TIA-603-C-2004.

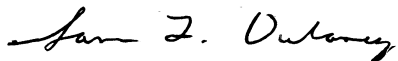

Sam L. Dulaney  
Chief Engineer  
RITRON, Inc.

**TYPE OF EXHIBIT:** DESCRIPTION OF MEASUREMENT FACILITY  
**FCC PART:** 2.948  
**MANUFACTURER:** RITRON, Inc.  
**MODEL:** DTX-460-0\_\_6  
**TYPE OF UNIT:** UHF Transceiver Module  
**FCC ID:** AIERIT33-4600  
**DATE:** October 19, 2011

The Field Strength measurements filed with this application were made on a site certified by RITRON, Inc. Data pertaining to this site are on file with the FCC and Industry Canada and are current.

This site is used on a continuing basis exclusively by RITRON, Inc. and is utilized only for RF Field Strength measurements of equipment designed and manufactured by RITRON, Inc. It is not used for measurements by, or for, any other party on a contract basis or otherwise.

All other measurements were taken at RITRON's Engineering Laboratory in Carmel, IN.

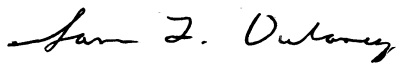

Sam L. Dulaney  
Chief Engineer  
RITRON, Inc.

**TYPE OF EXHIBIT:** RADIO FREQUENCY OUTPUT POWER

**FCC PART:** 2.1046(a)

**MANUFACTURER:** RITRON, Inc.

**MODEL:** DTX-460-0\_\_6

**TYPE OF UNIT:** UHF Transceiver Module

**FCC ID:** AIERIT33-4600

**DATE:** October 19, 2011

**PROCEDURE:**

1. The DTX-460 was aligned for transmitter operation at three power levels per the tune-up procedure outlined in the Maintenance manual for frequencies at the lower, middle and upper band edges.
2. Power was supplied to the DTX-460 by an Astron VS 20M Power Supply. The DTX-460 was connected to a HP8920B Test Set used to measure the RF carrier power. The input to the Test Set provides a resistive 50-ohm termination at the frequencies and power levels used for this test.
3. The voltage across an internal shunt in series with the power supply lead of the RF Power Module was used with a fluke 45 Digital Multimeter to measure current (Id). A Fluke 45 Digital Multimeter was used to measure the RF Power Module output stage power control voltage (Vcon) and drain voltage (Vd). In addition, the digital power control setting (Con. Value) used to set the output power was noted and recorded.
4. Measurements were taken at various power levels between 1 watt and 6 watts.

**TYPE OF EXHIBIT:** RADIO FREQUENCY OUTPUT POWER  
**FCC PART:** 2.1046(a)  
**MANUFACTURER:** RITRON, Inc.  
**MODEL:** DTX-460-0\_\_6  
**TYPE OF UNIT:** UHF Transceiver Module  
**FCC ID:** AIERIT33-4600  
**DATE:** October 19, 2011

**RESULTS:**

450.025 MHz Carrier Frequency

Po (watts)	Con. Value	Vcon (V)	Vd (V)	Id (A)
1.0	154	2.58	7.64	0.80
2.0	164	2.74	7.58	1.26
3.0	170	2.84	7.54	1.55
4.0	177	2.96	7.49	1.87
5.0	185	3.09	7.45	2.18
6.0	193	3.23	7.41	2.43

461.750 MHz Carrier Frequency

Po (watts)	Con. Value	Vcon (V)	Vd (V)	Id (A)
1.0	147	2.45	7.66	0.60
2.0	156	2.61	7.61	1.00
3.0	162	2.71	7.58	1.27
4.0	170	2.84	7.54	1.57
5.0	180	3.00	7.50	1.84
6.0	200	3.34	7.44	2.25

**TYPE OF EXHIBIT:** RADIO FREQUENCY OUTPUT POWER  
**FCC PART:** 2.1046(a)  
**MANUFACTURER:** RITRON, Inc.  
**MODEL:** DTX-460-0\_\_6  
**TYPE OF UNIT:** UHF Transceiver Module  
**FCC ID:** AIERIT33-4600  
**DATE:** October 19, 2011  
**RESULTS:** Cont.

469.925 MHz Carrier Frequency

Po (watts)	Con. Value	Vcon (V)	Vd (V)	Id (A)
1.0	142	2.38	7.67	0.63
2.0	151	2.53	7.62	1.00
3.0	158	2.64	7.58	1.25
4.0	168	2.81	7.54	1.53
5.0	182	3.04	7.50	1.86
6.0	215	3.59	7.40	2.46

**TYPE OF EXHIBIT:** MODULATOR RESPONSE-12.5 kHz CHANNELS

**FCC PART:** 2.1047(a)

**MANUFACTURER:** RITRON, Inc.

**MODEL:** DTX-460-0\_\_6

**TYPE OF UNIT:** UHF Transceiver Module

**FCC ID:** AIERIT33-4600

**DATE:** October 19, 2011

**PROCEDURE:**

1. The DTX-460 was aligned for transmitter operation at 461.750 MHz at full rated power per the tune-up procedure outlined in the Maintenance manual.
2. The response was measured from the audio input to the modulator input.
3. The audio test set was swept in frequency from 200 Hz to 10 kHz and the results noted. Plots are shown for both 6.25 kHz and 12.5 kHz channel spacing operation and for 12.5 kHz channel spacing, for both flat and pre-emphasized audio. The frequency response is independent of carrier frequency, therefore, only the center operating frequency is shown.



**TYPE OF EXHIBIT:** MODULATOR RESPONSE-12.5 kHz CHANNELS  
**FCC PART:** 2.1047(a)  
**MANUFACTURER:** RITRON, Inc.  
**MODEL:** DTX-460-0\_\_6  
**TYPE OF UNIT:** UHF Transceiver Module  
**FCC ID:** AIERIT33-4600  
**DATE:** October 19, 2011  
**RESULTS:** Flat audio input

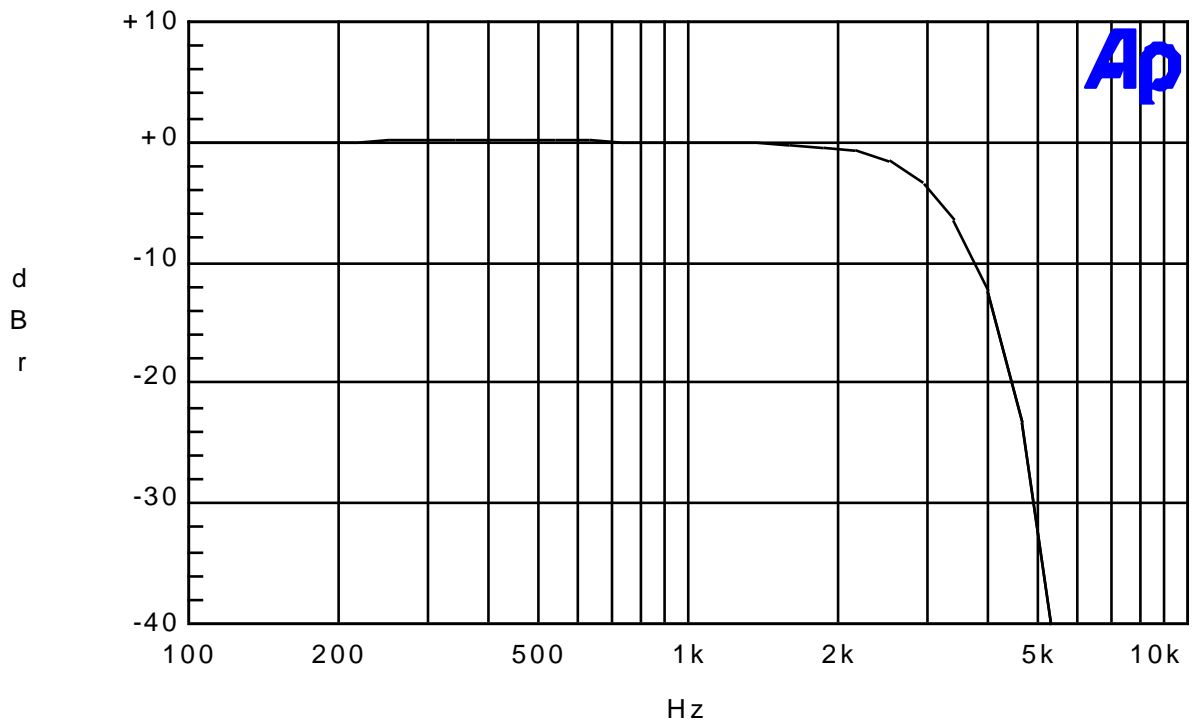

**TYPE OF EXHIBIT:** MODULATOR RESPONSE-12.5 kHz CHANNELS  
**FCC PART:** 2.1047(a)  
**MANUFACTURER:** RITRON, Inc.  
**MODEL:** DTX-460-0\_\_6  
**TYPE OF UNIT:** UHF Transceiver Module  
**FCC ID:** AIERIT33-4600  
**DATE:** October 19, 2011  
**RESULTS:** Pre-emphasized audio input

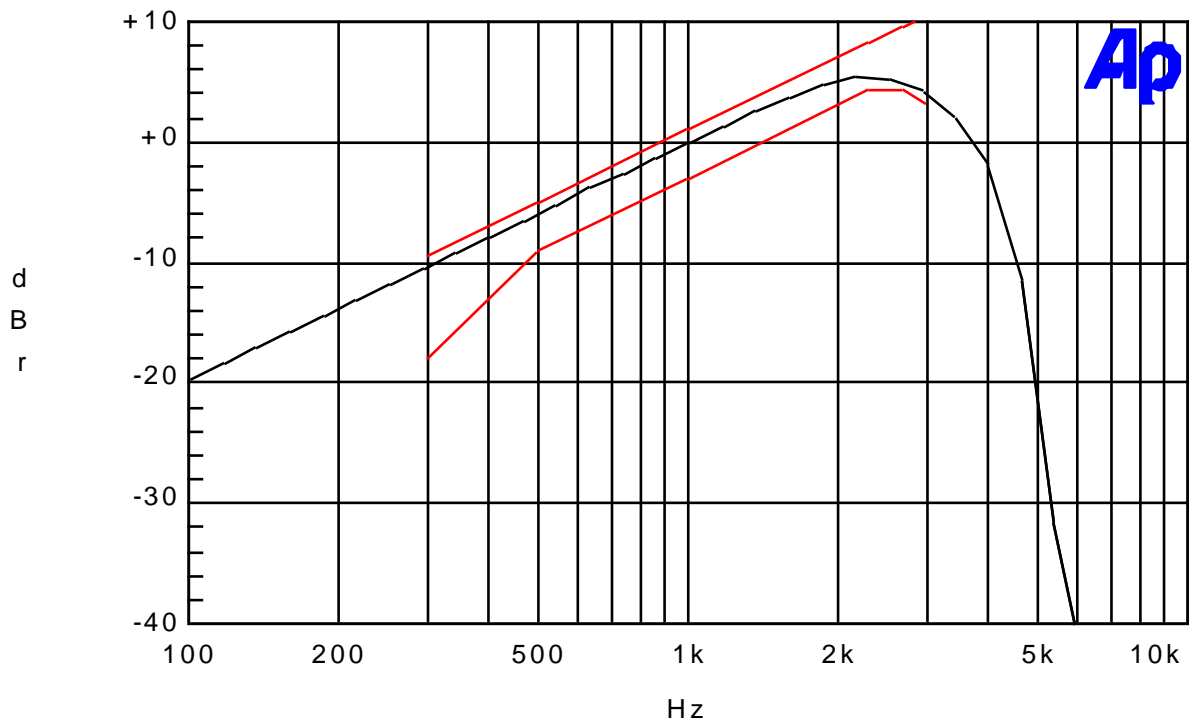

**TYPE OF EXHIBIT:** MODULATOR RESPONSE-6.25 kHz CHANNELS

**FCC PART:** 2.1047(a)

**MANUFACTURER:** RITRON, Inc.

**MODEL:** DTX-460-0\_\_6

**TYPE OF UNIT:** UHF Transceiver Module

**FCC ID:** AIERIT33-4600

**DATE:** October 19, 2011

**RESULTS:**

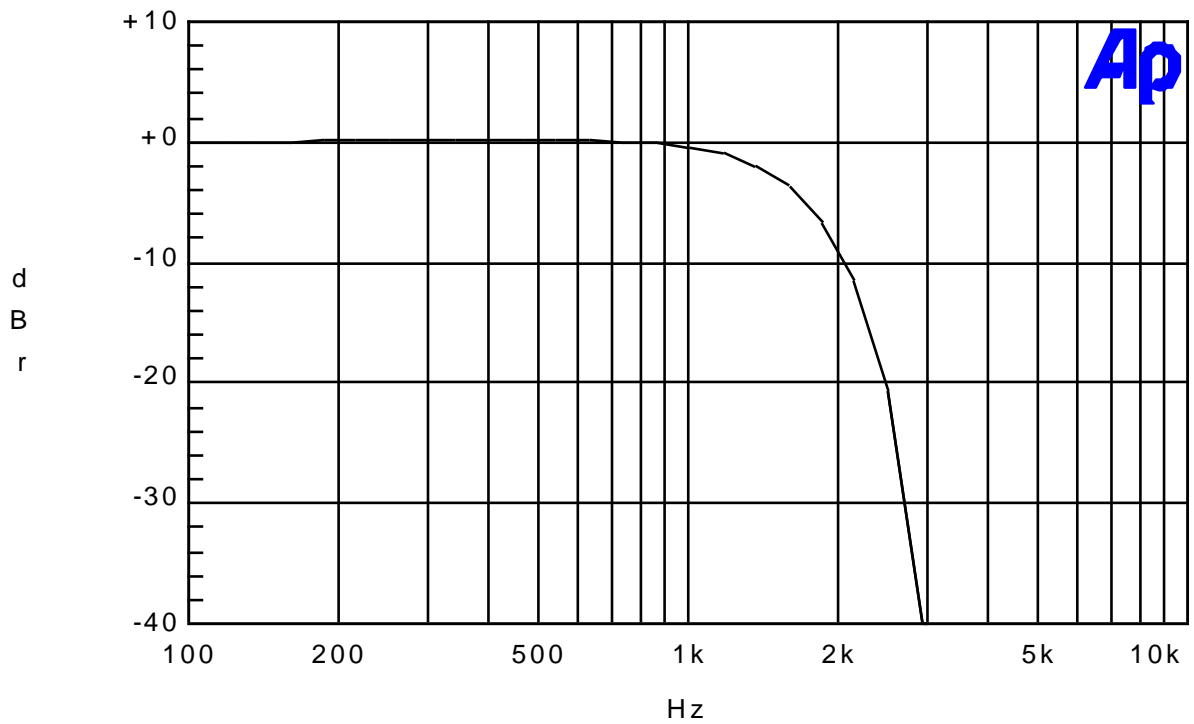

**TYPE OF EXHIBIT:** CLIPPER FILTER RESPONSE

**FCC PART:** 2.1047(a)

**MANUFACTURER:** RITRON, Inc.

**MODEL:** DTX-460-0\_\_6

**TYPE OF UNIT:** UHF Transceiver Module

**FCC ID:** AIERIT33-4600

**DATE:** October 19, 2011

**PROCEDURE:**

1. The audio output of the audio test set was coupled into the audio input of the DTX-460. The DTX-460 was setup so that all audio filters in the transmitter were bypassed except the post limiter filter. The audio input of the test set was connected to the input of the modulator.
2. The audio generator frequency was swept from 200 Hz to 20 kHz and the response for 6.25 kHz and 12.5 kHz channel spacing operation noted and plotted. The frequency response is independent of carrier frequency.

**TYPE OF EXHIBIT:** CLIPPER FILTER RESPONSE-12.5 kHz CHANNELS

**FCC PART:** 2.1047(a)

**MANUFACTURER:** RITRON, Inc.

**MODEL:** DTX-460-0\_\_6

**TYPE OF UNIT:** UHF Transceiver Module

**FCC ID:** AIERIT33-4600

**DATE:** October 19, 2011

**RESULTS:**

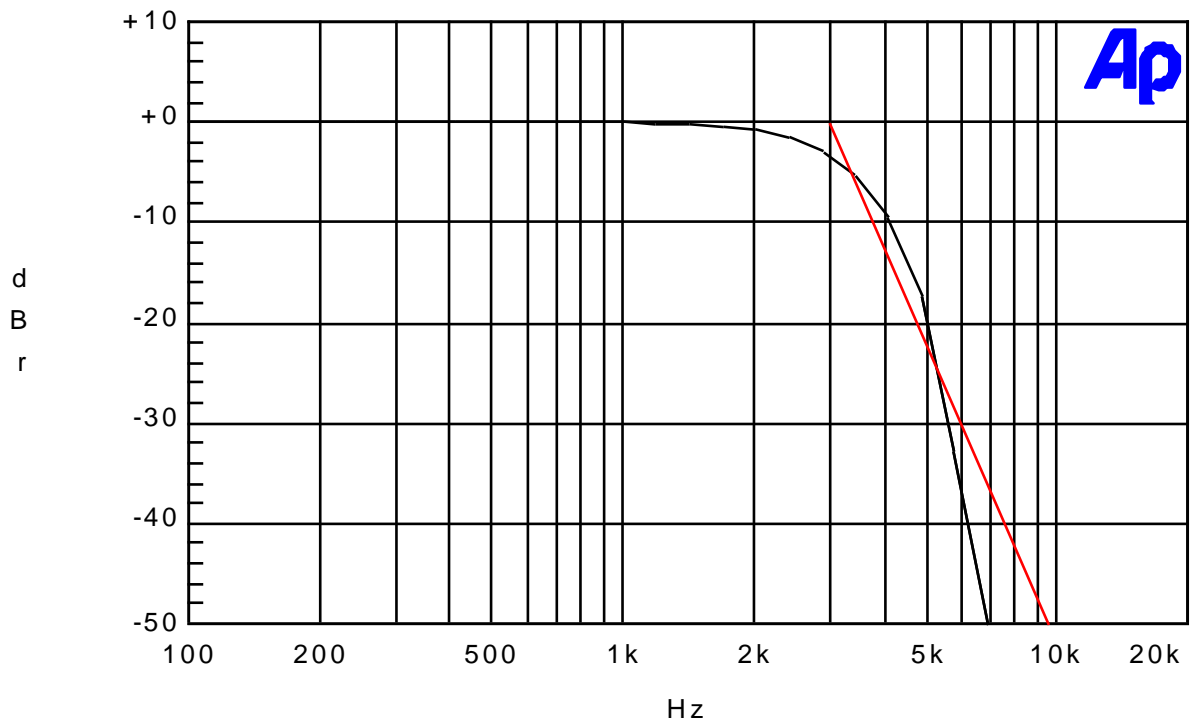

**TYPE OF EXHIBIT:** CLIPPER FILTER RESPONSE-6.25 kHz CHANNELS

**FCC PART:** 2.1047(a)

**MANUFACTURER:** RITRON, Inc.

**MODEL:** DTX-460-0\_\_6

**TYPE OF UNIT:** UHF Transceiver Module

**FCC ID:** AIERIT33-4600

**DATE:** October 19, 2011

**RESULTS:**

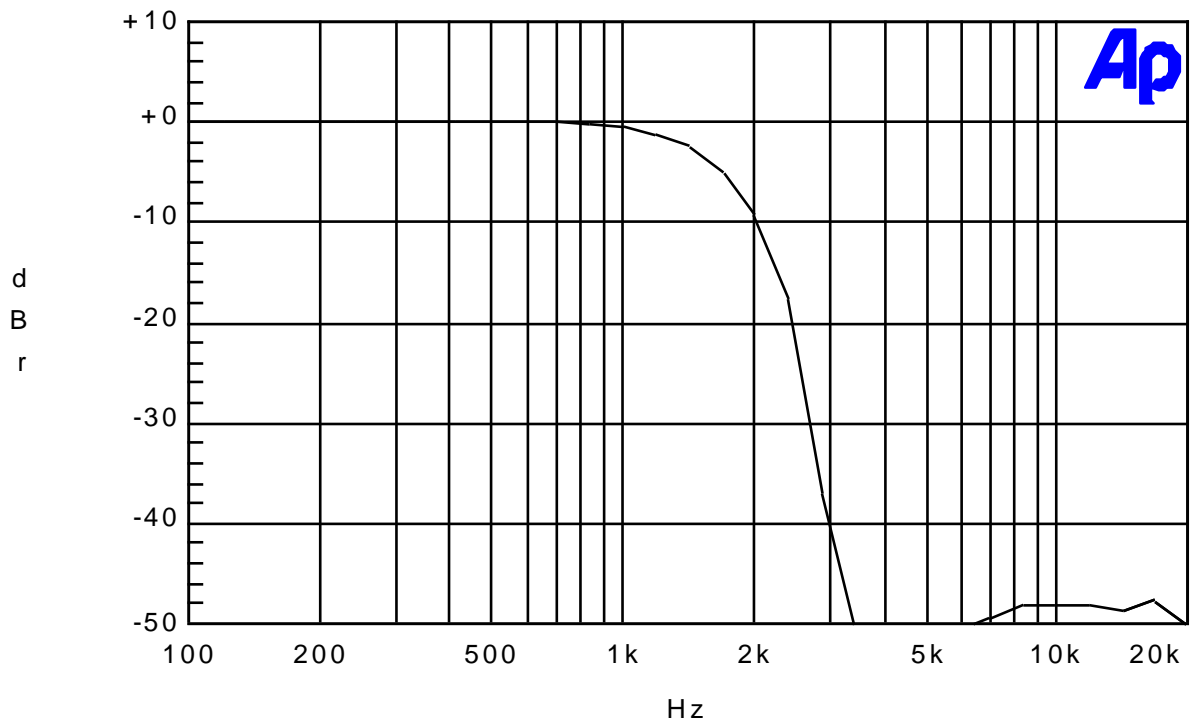

**TYPE OF EXHIBIT:** MODULATION LIMITING CURVES

**FCC PART:** 2.1047(b)

**MANUFACTURER:** RITRON, Inc.

**MODEL:** DTX-460-0\_\_6

**TYPE OF UNIT:** UHF Transceiver Module

**FCC ID:** AIERIT33-4600

**DATE:** October 19, 2011

**PROCEDURE:**

1. The DTX-460 was aligned for transmitter operation on 461.750 MHz per the tune-up procedure outlined in the Maintenance manual.
2. The RF output was connected to the RF input of a radio Test Set configured to measure FM deviation. The audio output of the audio test set was routed to the audio input of the DTX-460.
3. The frequency of the audio generator was adjusted to find the frequency of maximum response. As outlined in the Maintenance manual the DTX-460 transmit deviation was adjusted for 2.4 kHz maximum deviation for 12.5 kHz channel spacing and 1.1 kHz for 6.25 kHz channel spacing. The audio generator level was reduced to produce 50% of maximum deviation and the level noted.
4. The audio frequency was set to 300 Hz and the output level was varied from zero to a level at least 16 dB above that required to produce 50% maximum deviation noted in step 3 above.
5. Step 4 was repeated for audio frequencies of 1000 and 3000 Hz for 12.5 kHz channel spacing and for audio frequencies 600 Hz and 1200 Hz for 6.25 kHz channel spacing.

**TYPE OF EXHIBIT:** MODULATION LIMITING CURVES-12.5 kHz CHANNELS  
**FCC PART:** 2.1047(b)  
**MANUFACTURER:** RITRON, Inc.  
**MODEL:** DTX-460-0\_\_6  
**TYPE OF UNIT:** UHF Transceiver Module  
**FCC ID:** AIERIT33-4600  
**DATE:** October 19, 2011  
**RESULTS:** Flat audio input

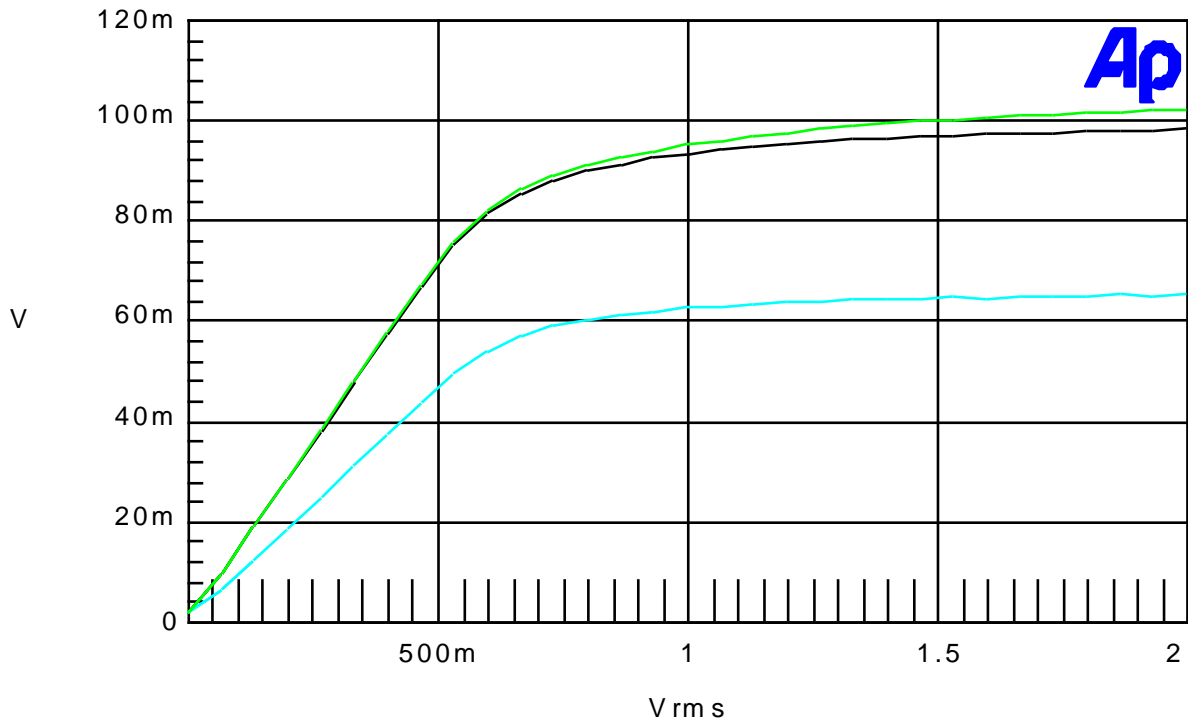

Top to bottom: 1 kHz, 3 kHz, 300 Hz.

Note: 100 mV output represents 2.4 kHz deviation.



**TYPE OF EXHIBIT:** MODULATION LIMITING CURVES-12.5 kHz CHANNELS

**FCC PART:** 2.1047(b)

**MANUFACTURER:** RITRON, Inc.

**MODEL:** DTX-460-0\_\_6

**TYPE OF UNIT:** UHF Transceiver Module

**FCC ID:** AIERIT33-4600

**DATE:** October 19, 2011

**RESULTS:** Pre-emphasized audio input

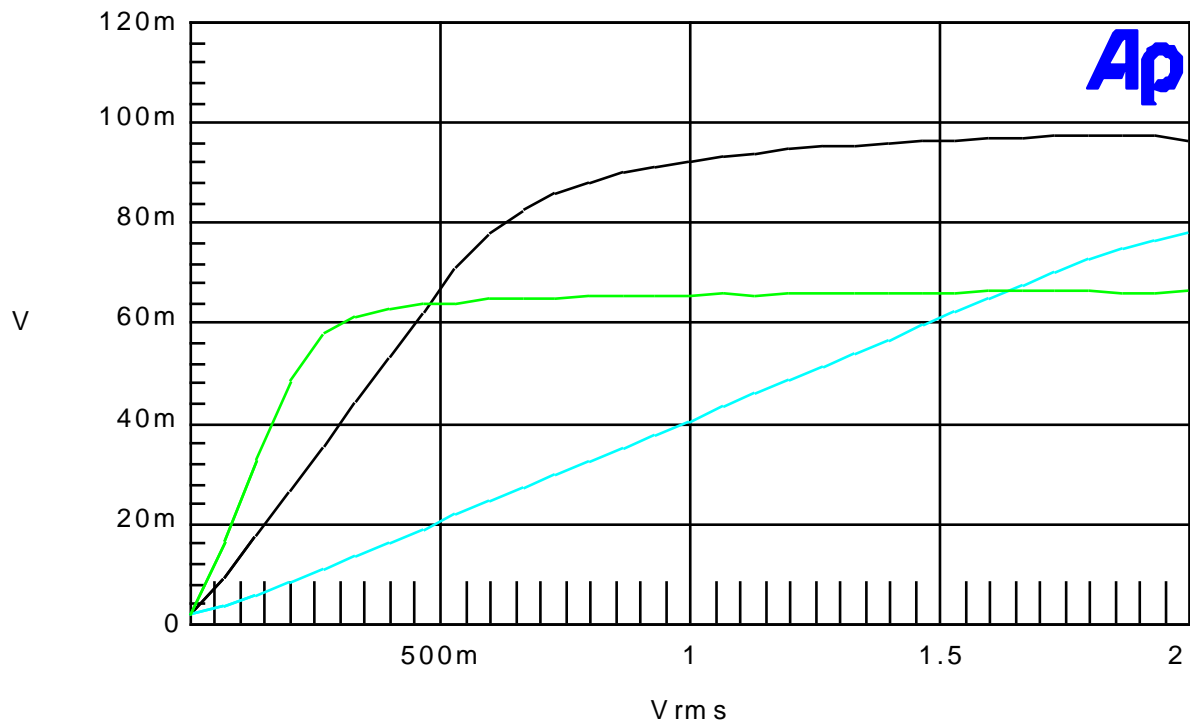

Top to bottom: 1 kHz, 3 kHz, 300 Hz.

Note: 100 mV output represents 2.4 kHz deviation.

**TYPE OF EXHIBIT:** MODULATION LIMITING CURVES-6.25 kHz CHANNELS

**FCC PART:** 2.1047(b)

**MANUFACTURER:** RITRON, Inc.

**MODEL:** DTX-460-0\_\_6

**TYPE OF UNIT:** UHF Transceiver Module

**FCC ID:** AIERIT33-4600

**DATE:** October 19, 2011

**RESULTS:**

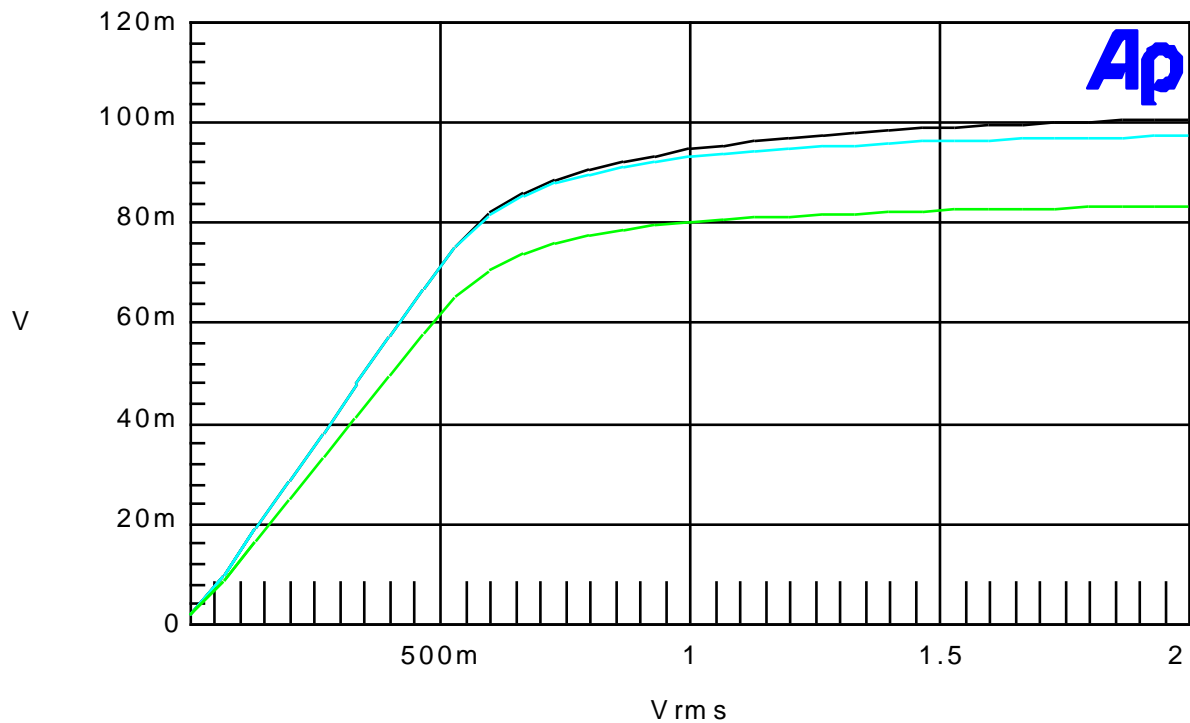

Top to bottom: 1 kHz, 1.1 kHz, 300 Hz.

Note: 100 mV output represents 1.2 kHz deviation.

**TYPE OF EXHIBIT:** OCCUPIED BANDWIDTH  
**FCC PART:** 2.1049(c)(1), 90.210(d), 90.210(e)  
**MANUFACTURER:** RITRON, Inc.  
**MODEL:** DTX-460-0\_\_6  
**TYPE OF UNIT:** UHF Transceiver Module  
**FCC ID:** AIERIT33-4600  
**DATE:** October 19, 2011

**PROCEDURE:**

1. For 12.5 kHz channel voice operation, a 2.5 kHz audio signal was applied to the microphone input of the unit. Its level was adjusted to be 16 dB above that required to produce 50% of peak deviation at the frequency of maximum deviation. The deviation adjustment was set for 2.4 kHz maximum deviation for 12.5 kHz channel operation and a spectrum analyzer was connected to the RF output through an RF power attenuator. The analyzer was set to sweep +/-25 kHz of carrier with a reference level set to that observed when the resolution bandwidth and video bandwidth were set to 1 MHz.
2. For 12.5 kHz digital voice operation, an external digital voice (NXDN) circuit board was connected and the maximum output deviation of the C4FM signal was set to +/-2.4 kHz when a special test modulation input was applied. The analyzer was set to sweep +/-25 kHz of carrier with a reference level set to that observed when the resolution bandwidth and video bandwidth were set to 1 MHz. The C4FM board also was set to create a pn data sequence for data operation. Digital voice and data are indistinguishable when viewed on a spectrum analyzer and therefore, will be shown as one plot.
3. For 6.25 kHz digital voice operation, the deviation was decreased to +/-1.1 kHz and the analyzer set to sweep +/-10 kHz either side of the carrier. Digital voice and data are indistinguishable when viewed on a spectrum analyzer and therefore, will be shown as one plot. Also, digital and voice and data can also be combined as a common signal with the plot appearing the same as data or digitized voice.
4. The spectrum for the transmission of a continuous wave identification tone for 6.25 kHz digital operation is also shown as well as that for 12.5 kHz audio frequency shift keyed data (2400 bps, pn sequence, 1200/2400 Hz tones).
5. The occupied bandwidth plots are independent of carrier frequency, therefore, only the plots for 461.750 MHz are shown.

**TYPE OF EXHIBIT:** OCCUPIED BANDWIDTH-12.5 kHz CHANNELS  
**FCC PART:** 2.1049(c)(1), 90.210(d)  
**MANUFACTURER:** RITRON, Inc.  
**MODEL:** DTX-460-0\_\_6  
**TYPE OF UNIT:** UHF Transceiver Module  
**FCC ID:** AIERIT33-4600  
**DATE:** October 19, 2011  
**RESULTS:** Analog voice modulation

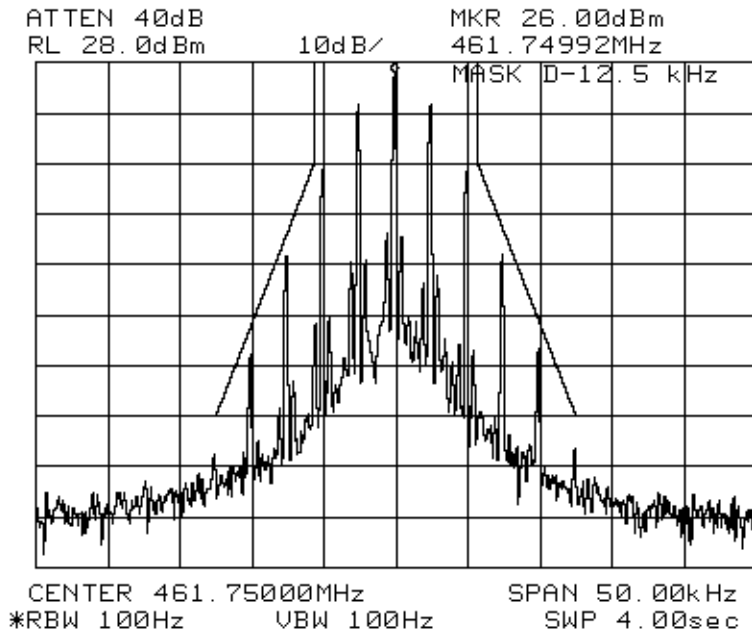

**TYPE OF EXHIBIT:** OCCUPIED BANDWIDTH-12.5 kHz CHANNELS  
**FCC PART:** 2.1049(c)(1), 90.210(d)  
**MANUFACTURER:** RITRON, Inc.  
**MODEL:** DTX-460-0\_\_6  
**TYPE OF UNIT:** UHF Transceiver Module  
**FCC ID:** AIERIT33-4600  
**DATE:** October 19, 2011  
**RESULTS:** Digital voice/data modulation

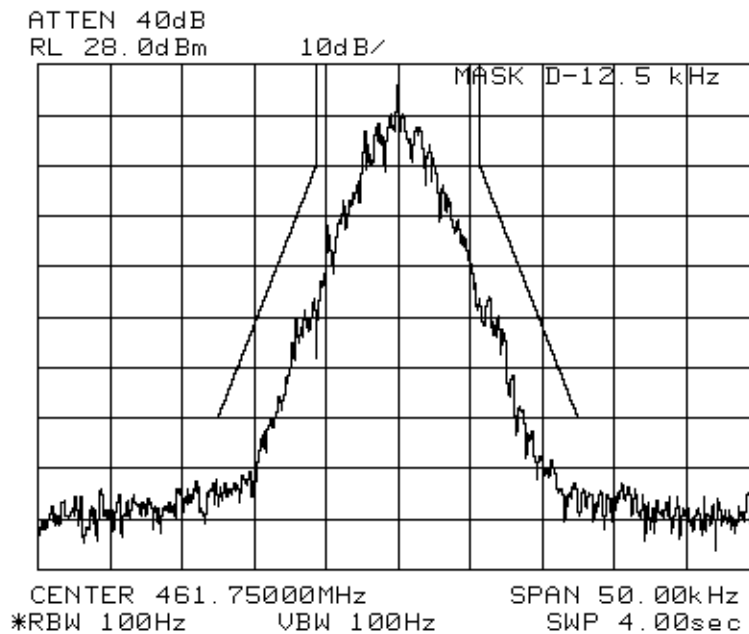

**TYPE OF EXHIBIT:** OCCUPIED BANDWIDTH-12.5 kHz CHANNELS  
**FCC PART:** 2.1049(c)(1), 90.210(d)  
**MANUFACTURER:** RITRON, Inc.  
**MODEL:** DTX-460-0\_\_6  
**TYPE OF UNIT:** UHF Transceiver Module  
**FCC ID:** AIERIT33-4600  
**DATE:** October 19, 2011  
**RESULTS:** AFSK data modulation

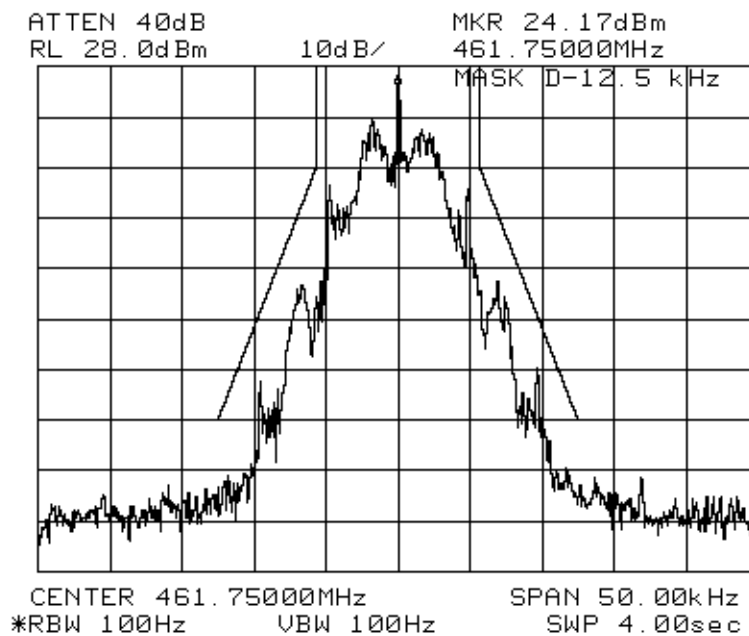

**TYPE OF EXHIBIT:** OCCUPIED BANDWIDTH-6.25 kHz CHANNELS  
**FCC PART:** 2.1049(c)(1), 90.210(e)  
**MANUFACTURER:** RITRON, Inc.  
**MODEL:** DTX-460-0\_\_6  
**TYPE OF UNIT:** UHF Transceiver Module  
**FCC ID:** AIERIT33-4600  
**DATE:** October 19, 2011  
**RESULTS:** Digital voice/data modulation

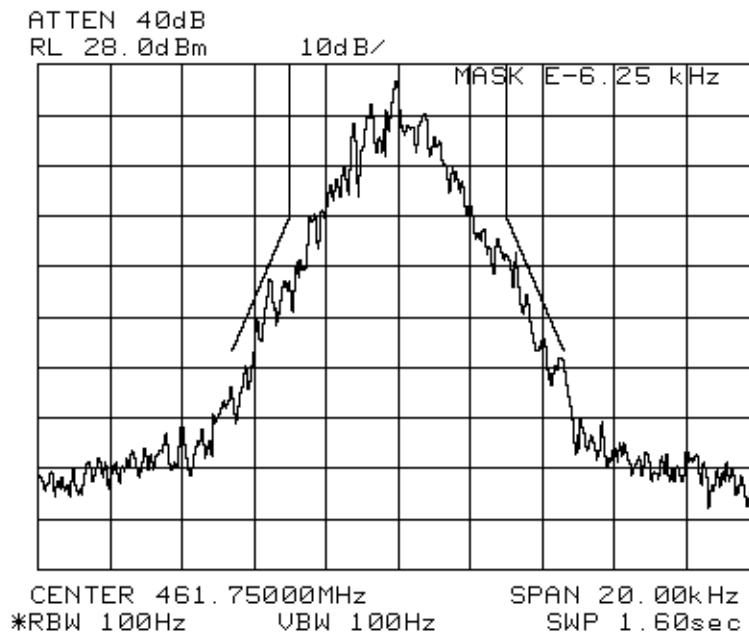

**TYPE OF EXHIBIT:** OCCUPIED BANDWIDTH-6.25 kHz CHANNELS

**FCC PART:** 2.1049(c)(1), 90.210(e)

**MANUFACTURER:** RITRON, Inc.

**MODEL:** DTX-460-0\_\_6

**TYPE OF UNIT:** UHF Transceiver Module

**FCC ID:** AIERIT33-4600

**DATE:** October 19, 2011

**RESULTS:** CW ID tone modulation

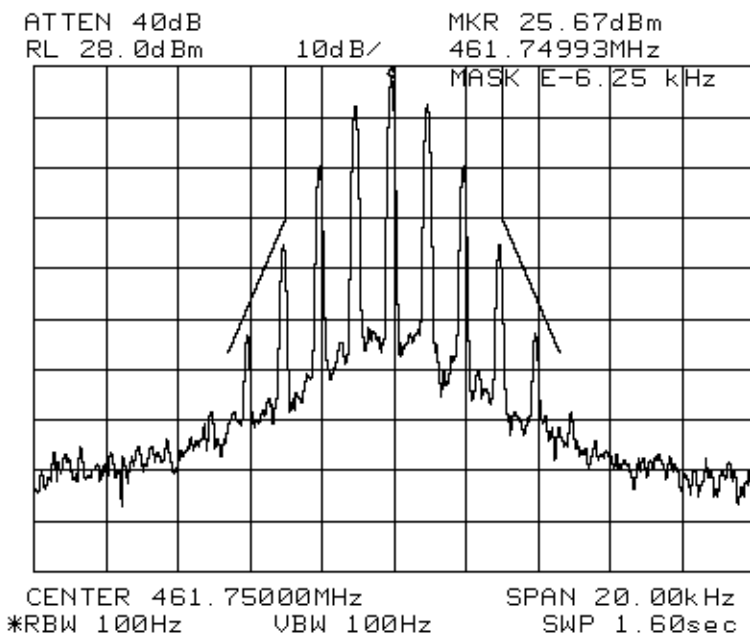



**TYPE OF EXHIBIT:** BANDWIDTH CALCULATION/MODULATION TYPE  
**FCC PART:** 2.1049(c)(1), 90.210(d), 90.210(e)  
**MANUFACTURER:** RITRON, Inc.  
**MODEL:** DTX-460-0\_\_6  
**TYPE OF UNIT:** UHF Transceiver Module  
**FCC ID:** AIERIT33-4600  
**DATE:** October 19, 2011

**RESULTS:**

Modulation:

Voice

Analog voice signals directly modulate the transmitter carrier with a maximum peak deviation which is dependant upon the channel spacing. Voice signals are pre-emphasized, limited, and filtered prior to being sent to the modulator. Digital voice signals represent the 4-level (4FSK) output of a digital voice encoder and directly modulate the transmitter carrier. The maximum deviation is dependant upon the channel spacing.

Data-4FSK

The 4FSK data stream is encoded into dibits at half the original data rate and used to create a 4-level audio signal which passes through a root-raised cosine filter and is then used to directly modulate the transmitter carrier. The maximum deviation is dependent upon the channel spacing.

CW ID Tone

The on-off (OOK) CW sequence modulates an audio subcarrier, which then frequency modulates the radio. The maximum deviation is dependent upon the channel spacing.

Data-AFSK

The AFSK data stream is used to frequency an audio subcarrier at 1800 Hz. The peak audio deviation is +/-600 Hz. This signal is in turn filtered and used to directly frequency modulate the transmitter carrier with a peak deviation dependent upon the channel spacing.

**TYPE OF EXHIBIT:** BANDWIDTH CALCULATION/MODULATION TYPE

**FCC PART:** 2.1049(c)(1), 90.210(d), 90.210(e)

**MANUFACTURER:** RITRON, Inc.

**MODEL:** DTX-460-0\_\_6

**TYPE OF UNIT:** UHF Transceiver Module

**FCC ID:** AIERIT33-4600

**DATE:** October 19, 2011

**RESULTS:**

By Carson's rule, the occupied bandwidth for an FM signal may be calculated by:

$BW = 2(f_{\Delta} + f_m)$  where  $f_{\Delta}$  is the frequency deviation and  $f_m$  is the modulating frequency.

Modulation	$f_{\Delta}$	$f_m$	BW	Emissions Designator
Analog Voice				
12.5 kHz	2.5	2.5	10.0	10K0F3E
Digital Voice				
6.25 kHz	1.05	0.95	4.0	4K00F1E
12.5 kHz	2.10	1.90	8.0	8K00F1E
4FSK Data				
6.25 kHz	1.05	0.95	4.0	4K00F1D
12.5 kHz	2.10	1.90	8.0	8K00F1D
Digital Voice/Data Combination				
6.25 kHz	1.05	0.95	4.0	4K00F7W
12.5 kHz	2.10	1.90	8.0	8K00F7W

**TYPE OF EXHIBIT:** BANDWIDTH CALCULATION/MODULATION TYPE  
**FCC PART:** 2.1049(c)(1), 90.210(d), 90.210(e)  
**MANUFACTURER:** RITRON, Inc.  
**MODEL:** DTX-460-0\_\_6  
**TYPE OF UNIT:** UHF Transceiver Module  
**FCC ID:** AIERIT33-4600  
**DATE:** October 19, 2011  
**RESULTS:** Cont.

CW ID Tone

6.25 kHz	1.0	1.0	4.0	4K00F2D
----------	-----	-----	-----	---------

AFSK Data

12.5 kHz	2.5	1.8	8.6	8K60F2D
----------	-----	-----	-----	---------

**TYPE OF EXHIBIT:** CONDUCTED SPURIOUS EMISSIONS

**FCC PART:** 2.1051, 90.210(d)

**MANUFACTURER:** RITRON, Inc.

**MODEL:** DTX-460-0\_\_6

**TYPE OF UNIT:** UHF Transceiver Module

**FCC ID:** AIERIT33-4600

**DATE:** October 19, 2011

**PROCEDURE:**

1. The DTX-460 was aligned for transmitter operation at the band edges and the band center at power levels ranging from 1 watt to 6 watts per the tune-up procedure outlined in the Maintenance manual. The transmitter was modulated in a manner consistent with the type of signal to be transmitted.
2. The RF output was connected to an HP 8560E spectrum analyzer through a 10 dB, 10 watt, 50-ohm RF attenuator. The center frequency of the spectrum analyzer was set to the transmitter frequency. The frequency span and resolution and video bandwidths were set to show spurious emissions at least 80 dB below the unmodulated carrier level. The transmitter was keyed and the reference level on the analyzer noted.
3. For the transmitter harmonics, an RF highpass filter was inserted into the path from the attenuator to the spectrum analyzer.
4. The transmitter was keyed and the output spectrum was examined from 9 kHz to 10 times the operating frequency, except within 100 kHz of the operating frequency. The attenuation of the highpass filter at the transmitter harmonic frequencies was measured and factored into the absolute dBm results.

**TYPE OF EXHIBIT:** CONDUCTED SPURIOUS EMISSIONS

**FCC PART:** 2.1051, 90.210(d)

**MANUFACTURER:** RITRON, Inc.

**MODEL:** DTX-460-0\_\_6

**TYPE OF UNIT:** UHF Transceiver Module

**FCC ID:**

**DATE:** October 19, 2011

**RESULTS:**

450.025 MHz Carrier Frequency

Spur Frequency (MHz)	Notes	Spur level (dBm)	Rel. Spur (dBc)	Limit (dBc)
435.630		-42.0	-80.0	-62.8
449.525	-500 kHz DC-DC converter	-44.0	-82.0	-62.8
449.960	-65 kHz Codec spur	-37.0	-75.0	-62.8
449.993	-32 kHz Codec spur	-42.0	-80.0	-62.8
450.057	+32 kHz Codec spur	-42.0	-80.0	-62.8
450.090	+65 kHz Codec spur	-37.0	-75.0	-62.8
450.525	+500 kHz DC-DC converter	-44.0	-82.0	-62.8
464.420		-40.0	-78.0	-62.8
900.050	2 <sup>nd</sup> harmonic	-51.0	-89.0	-62.8
2250.125	5 <sup>th</sup> harmonic	-47.0	-89.0	-62.8
2700.150	6 <sup>th</sup> harmonic	-47.0	-89.0	-62.8

Note: Spurious levels more than 20 dB below the limit may not be reported.

**TYPE OF EXHIBIT:** CONDUCTED SPURIOUS EMISSIONS

**FCC PART:** 2.1051, 90.210(d)

**MANUFACTURER:** RITRON, Inc.

**MODEL:** DTX-460-0\_\_6

**TYPE OF UNIT:** UHF Transceiver Module

**FCC ID:**

**DATE:** October 19, 2011

**RESULTS:** Cont.

461.750 MHz Carrier Frequency

Spur Frequency (MHz)	Notes	Spur level (dBm)	Rel. Spur (dBc)	Limit (dBc)
418.570		-43.0	-81.0	-62.8
461.685	-65 kHz Codec spur	-39.0	-77.0	-62.8
461.718	-32 kHz Codec spur	-47.0	-85.0	-62.8
461.782	+32 kHz Codec spur	-47.0	-85.0	-62.8
461.815	+65 kHz Codec spur	-39.0	-77.0	-62.8
466.770		-43.0	-81.0	-62.8
476.150		-45.0	-83.0	-62.8
923.500	2 <sup>nd</sup> harmonic	-46.0	-84.0	-62.8
1385.250	3 <sup>rd</sup> harmonic	-44.0	-81.0	-62.8
2308.750	5 <sup>th</sup> harmonic	-45.0	-83.0	-62.8

Note: Spurious levels more than 20 dB below the limit may not be reported.

**TYPE OF EXHIBIT:** CONDUCTED SPURIOUS EMISSIONS

**FCC PART:** 2.1051, 90.210(d)

**MANUFACTURER:** RITRON, Inc.

**MODEL:** DTX-460-0\_\_6

**TYPE OF UNIT:** UHF Transceiver Module

**FCC ID:**

**DATE:** October 19, 2011

**RESULTS:** Cont.

469.925 MHz Carrier Frequency

Spur Frequency (MHz)	Notes	Spur level (dBm)	Rel. Spur (dBc)	Limit (dBc)
455.530		-46.0	-84.0	-62.8
464.930		-47.0	-85.0	-62.8
469.960	-65 kHz Codec spur	-37.0	-75.0	-62.8
469.893	-32 kHz Codec spur	-42.0	-80.0	-62.8
469.957	+32 kHz Codec spur	-42.0	-80.0	-62.8
469.990	+65 kHz Codec spur	-37.0	-75.0	-62.8
484.300		-44.0	-82.0	-62.8
939.850	2 <sup>nd</sup> harmonic	-46.0	-84.0	-62.8
1409.775	3 <sup>rd</sup> harmonic	-37.0	-75.0	-62.8
2349.625	5 <sup>th</sup> harmonic	-45.0	-83.0	-62.8
2819.550	6 <sup>th</sup> harmonic	-47.0	-89.0	-62.8

Note: Spurious levels more than 20 dB below the limit may not be reported.

**TYPE OF EXHIBIT:** FIELD STRENGTH OF SPURIOUS EMISSIONS-  
TRANSMITTER

**FCC PART:** 2.1053(a), (b)

**MANUFACTURER:** RITRON, Inc.

**MODEL:** DTX-460-0\_\_6

**TYPE OF UNIT:** UHF Transceiver Module

**FCC ID:** AIERIT33-4600

**DATE:** October 19, 2011

**PROCEDURE:**

1. The measurements for field strength of spurious emissions were taken at the RITRON, Inc. 3-meter test site, details of which are on file with the FCC and Industry Canada.
2. The DTX-460 was aligned for transmitter operation at the band edges and the band center at power levels ranging from 1 watt to 6 watts per the tune-up procedure outlined in the Maintenance manual. The transmitter was modulated in a manner consistent with the type of signal to be transmitted.
3. The unit was then terminated at the antenna port with a non-radiating 50-ohm load.
4. All field strength measurements were made with the Hewlett-Packard Model 8560E and Advantest R3265A Spectrum Analyzers and either a log periodic antenna, dipoles, or a microwave horn antenna depending upon frequency.
5. The transmitter was keyed and the spectrum searched from 9 kHz to the 10<sup>th</sup> harmonic of the transmit carrier. When a spurious emission was found, the height and polarization of the field strength measurement antenna and orientation of the DTX-460 were varied to provide maximum field strength.
6. A substitution antenna, a calibrated dipole, was substituted for the DTX-460 at the DTX-460's location. An RF signal generator was set for the frequency of the DTX-460 with the level at the substitution antenna noted.



**TYPE OF EXHIBIT:** FIELD STRENGTH OF SPURIOUS EMISSIONS-  
TRANSMITTER

**FCC PART:** 2.1053(a), (b)

**MANUFACTURER:** RITRON, Inc.

**MODEL:** DTX-460-0\_\_6

**TYPE OF UNIT:** UHF Transceiver Module

**FCC ID:** AIERIT33-4600

**DATE:** October 19, 2011

**PROCEDURE (continued):**

7. The polarization of the substitution antenna was adjusted for maximum signal strength at the field strength measuring antenna. The level at the field strength antenna was noted.

**TYPE OF EXHIBIT:** FIELD STRENGTH OF SPURIOUS EMISSIONS-  
TRANSMITTER

**FCC PART:** 2.1053(a), (b)

**MANUFACTURER:** RITRON, Inc.

**MODEL:** DTX-460-0\_\_6

**TYPE OF UNIT:** UHF Transceiver Module

**FCC ID:** AIERIT33-4600

**DATE:** October 19, 2011

**EQUATIONS:**

The spurious level is referenced to the carrier level of the transmitter, which is 6 watts (37.8 dBm), maximum. The equation for spurious levels relative to carrier level is:

$$P_{\text{spur}} (\text{dBc}) = P_{\text{carr}} (\text{dBm}) - P_{\text{spur}} (\text{dBm})$$

For radiated emissions testing,  $P_{\text{spur}} (\text{dBm})$  is the spurious emissions level as measured at the range receiving antenna. The reference level at the range receiving antenna for a 6-watt transmitter is:

$$P_{\text{carr}} (\text{dBm}) = 37.8 \text{ dBm} - P_{\text{gen}} (\text{dBm}) + L_{\text{cab}} (\text{dB}) + P_{\text{ref}} (\text{dBm})$$

Where:

$P_{\text{carr}}$  is the calculated level of a 6-watt transmitter into the substitution antenna.

$P_{\text{gen}}$  is the RF signal generator level at the substitution antenna input.

$L_{\text{cab}}$  is the cable loss from the substitution signal generator to the substitution antenna.

$P_{\text{ref}}$  is the power level of the substitution antenna emission at the receiving antenna output.

The overall equation thus becomes:

$$P_{\text{spur}} (\text{dBc}) = -37.8 \text{ dBm} + P_{\text{gen}} (\text{dBm}) - L_{\text{cab}} (\text{dB}) - P_{\text{ref}} (\text{dBm}) + P_{\text{spur}} (\text{dBm})$$

For an absolute level of the spur, the equation is:

$$\text{Spur Level}(\text{dBm}) = P_{\text{spur}} (\text{dBm}) - P_{\text{ref}} (\text{dBm}) + P_{\text{gen}} (\text{dBm}) - L_{\text{cab}} (\text{dB})$$

**TYPE OF EXHIBIT:** FIELD STRENGTH OF SPURIOUS EMISSIONS-  
TRANSMITTER

**FCC PART:** 2.1053(a), (b)

**MANUFACTURER:** RITRON, Inc.

**MODEL:** DTX-460-0\_\_6

**TYPE OF UNIT:** UHF Transceiver Module

**FCC ID:** AIERIT33-4600

**DATE:** October 19, 2011

**RESULTS:** Horizontal Polarization

450.025 MHz Carrier Frequency

Spur Freq. (MHz)	Notes	Pspur (dBm)	Pgen (dBm)	Lcab (dB)	Pref (dBm)	Spur Level (dBm)	Spur Level (dBc)	Limit (dBc)
900.050	2 <sup>nd</sup> harmonic	-69.2	0	2.0	-34.0	-37.2	-75.0	-62.8
1350.075	3 <sup>rd</sup> harmonic	-80.0	0	3.6	-42.4	-41.2	-79.0	-62.8
1800.100	4 <sup>th</sup> harmonic	-78.0	0	4.3	-44.3	-38.0	-75.8	-62.8
2250.125	5 <sup>th</sup> harmonic	-85.0	0	4.9	-47.8	-42.1	-79.9	-62.8

461.750 MHz Carrier Frequency

Spur Freq. (MHz)	Notes	Pspur (dBm)	Pgen (dBm)	Lcab (dB)	Pref (dBm)	Spur Level (dBm)	Spur Level (dBc)	Limit (dBc)
923.500	2 <sup>nd</sup> harmonic	-69.0	0	2.0	-33.4	-37.6	-71.6	-62.8
1385.250	3 <sup>rd</sup> harmonic	-80.5	0	3.6	-43.6	-40.5	-78.3	-62.8
1847.000	4 <sup>th</sup> harmonic	-79.0	0	4.3	-44.7	-38.6	-76.4	-62.8
2308.750	5 <sup>th</sup> harmonic	-85.0	0	5.0	-48.5	-41.5	-79.3	-62.8

Note: Spurious levels more than 20 dB below limit may not be reported.

**TYPE OF EXHIBIT:** FIELD STRENGTH OF SPURIOUS EMISSIONS-  
TRANSMITTER

**FCC PART:** 2.1053(a), (b)

**MANUFACTURER:** RITRON, Inc.

**MODEL:** DTX-460-0\_\_6

**TYPE OF UNIT:** UHF Transceiver Module

**FCC ID:** AIERIT33-4600

**DATE:** October 19, 2011

**RESULTS:** Horizontal Polarization (Cont.)

469.925 MHz Carrier Frequency

Spur Freq. (MHz)	Notes	Pspur (dBm)	Pgen (dBm)	Lcab (dB)	Pref (dBm)	Spur Level (dBm)	Spur Level (dBc)	Limit (dBc)
939.850	2 <sup>nd</sup> harmonic	-67.5	0	2.1	-34.4	-35.2	-73.0	-62.8
1409.775	3 <sup>rd</sup> harmonic	-76.0	0	3.6	-44.4	-35.2	-73.0	-62.8
1879.700	4 <sup>th</sup> harmonic	-80.0	0	4.3	-44.4	-39.9	-77.7	-62.8
2349.625	5 <sup>th</sup> harmonic	-87.0	0	5.0	-48.1	-43.9	-81.7	-62.8

Note: Spurious levels more than 20 dB below limit may not be reported.

**TYPE OF EXHIBIT:** FIELD STRENGTH OF SPURIOUS EMISSIONS-  
TRANSMITTER

**FCC PART:** 2.1053(a), (b)

**MANUFACTURER:** RITRON, Inc.

**MODEL:** DTX-460-0\_\_6

**TYPE OF UNIT:** UHF Transceiver Module

**FCC ID:** AIERIT33-4600

**DATE:** October 19, 2011

**RESULTS:** Vertical Polarization

450.025 MHz Carrier Frequency

Spur Freq. (MHz)	Notes	Pspur (dBm)	Pgen (dBm)	Lcab (dB)	Pref (dBm)	Spur Level (dBm)	Spur Level (dBc)	Limit (dBc)
900.050	2 <sup>nd</sup> harmonic	-77.5	0	2.0	-37.1	-42.4	-80.2	-62.8
1350.075	3 <sup>rd</sup> harmonic	-83.0	0	3.6	-43.0	-43.6	-81.4	-62.8
1800.100	4 <sup>th</sup> harmonic	-77.0	0	4.3	-44.7	-36.6	-74.4	-62.8
2250.125	5 <sup>th</sup> harmonic	-85.0	0	4.9	-48.4	-38.7	-76.5	-62.8
2700.150	6 <sup>th</sup> harmonic	-87.0	0	5.1	-51.4	-40.7	-78.5	-62.8
3150.175	7 <sup>th</sup> harmonic	-83.5	0	5.3	-57.9	-30.9	-68.7	-62.8

461.750 MHz Carrier Frequency

Spur Freq. (MHz)	Notes	Pspur (dBm)	Pgen (dBm)	Lcab (dB)	Pref (dBm)	Spur Level (dBm)	Spur Level (dBc)	Limit (dBc)
923.500	2 <sup>nd</sup> harmonic	-69.0	0	2.0	-37.8	-33.2	-71.0	-62.8
1385.250	3 <sup>rd</sup> harmonic	-80.5	0	3.6	-42.9	-41.2	-79.0	-62.8
1847.000	4 <sup>th</sup> harmonic	-79.0	0	4.3	-46.1	-37.2	-75.0	-62.8
2308.750	5 <sup>th</sup> harmonic	-85.0	0	5.0	-48.9	-41.1	-78.9	-62.8
2770.500	6 <sup>th</sup> harmonic	-86.0	0	5.1	-50.7	-40.4	-78.2	-62.8

Note: Spurious levels more than 20 dB below limit may not be reported.

**TYPE OF EXHIBIT:** FIELD STRENGTH OF SPURIOUS EMISSIONS-  
TRANSMITTER

**FCC PART:** 2.1053(a), (b)

**MANUFACTURER:** RITRON, Inc.

**MODEL:** DTX-460-0\_\_6

**TYPE OF UNIT:** UHF Transceiver Module

**FCC ID:** AIERIT33-4600

**DATE:** October 19, 2011

**RESULTS:** Vertical Polarization (Cont.)

469.925 MHz Carrier Frequency

Spur Freq. (MHz)	Notes	Pspur (dBm)	Pgen (dBm)	Lcab (dB)	Pref (dBm)	Spur Level (dBm)	Spur Level (dBc)	Limit (dBc)
939.850	2 <sup>nd</sup> harmonic	-71.5	0	2.1	-38.8	-34.8	-72.6	-62.8
1409.775	3 <sup>rd</sup> harmonic	-79.5	0	3.6	-41.9	-41.2	-79.0	-62.8
1879.700	4 <sup>th</sup> harmonic	-83.5	0	4.3	-45.6	-42.2	-80.0	-62.8
2349.625	5 <sup>th</sup> harmonic	-81.0	0	5.0	-48.8	-37.2	-75.0	-62.8

Note: Spurious levels more than 20 dB below limit may not be reported.

**TYPE OF EXHIBIT:** FREQUENCY STABILITY VS TEMPERATURE

**FCC PART:** 2.1055(a)(1), 90.213

**MANUFACTURER:** RITRON, Inc.

**MODEL:** DTX-460-0\_\_6

**TYPE OF UNIT:** UHF Transceiver Module

**FCC ID:** AIERIT33-4600

**DATE:** October 19, 2011

**PROCEDURE:**

1. The DTX-460 was aligned for transmitter operation at 461.750 MHz at full rated power per the tune-up procedure outlined in the Maintenance manual.
2. The DTX-460 was placed in a Delta Design Model 3900 CL Temperature Chamber. The RF output of the DTX-460 was connected to an HP 8920 Test Set to monitor the transmitter frequency. An Astron VS 20M Power Supply was adjusted for a nominal voltage of 12.6 VDC and connected to the DC power supply input of the DTX-460. A Triplet Model 320-G/P Thermocouple was used to monitor the temperature inside the chamber.
3. The chamber and the DTX-460 were heated to +50 degrees C and allowed to stabilize for 30 minutes for the first measurement and 30 minutes for each 10 degree decrement in temperature until the unit reached a temperature of -30 degrees C.
4. The RF frequency at each temperature was recorded and compared with the frequency at 25 degrees C, the tune-up temperature in the Maintenance manual.

**TYPE OF EXHIBIT:** FREQUENCY STABILITY VS TEMPERATURE

**FCC PART:** 2.1055(a)(1), 90.213

**MANUFACTURER:** RITRON, Inc.

**MODEL:** DTX-460-0\_\_6

**TYPE OF UNIT:** UHF Transceiver Module

**FCC ID:** AIERIT33-4600

**DATE:** October 19, 2011

**RESULTS:**

T (°C)	$\Delta f$ (Hz)	$\Delta f$ (ppm)	Limit (ppm)
-30	151	0.53	+/-1.0
-20	167	0.56	+/-1.0
-10	91	0.40	+/-1.0
0	72	0.36	+/-1.0
10	60	0.33	+/-1.0
20	-33	0.13	+/-1.0
25	0	0	+/-1.0
30	-140	-0.10	+/-1.0
40	-190	-0.21	+/-1.0
50	-181	-0.19	+/-1.0



**TYPE OF EXHIBIT:** FREQUENCY STABILITY VS TEMPERATURE

**FCC PART:** 2.1055(a)(1), 90.213

**MANUFACTURER:** RITRON, Inc.

**MODEL:** DTX-460-0\_\_6

**TYPE OF UNIT:** UHF Transceiver Module

**FCC ID:** AIERIT33-4600

**DATE:** October 19, 2011

**RESULTS:**

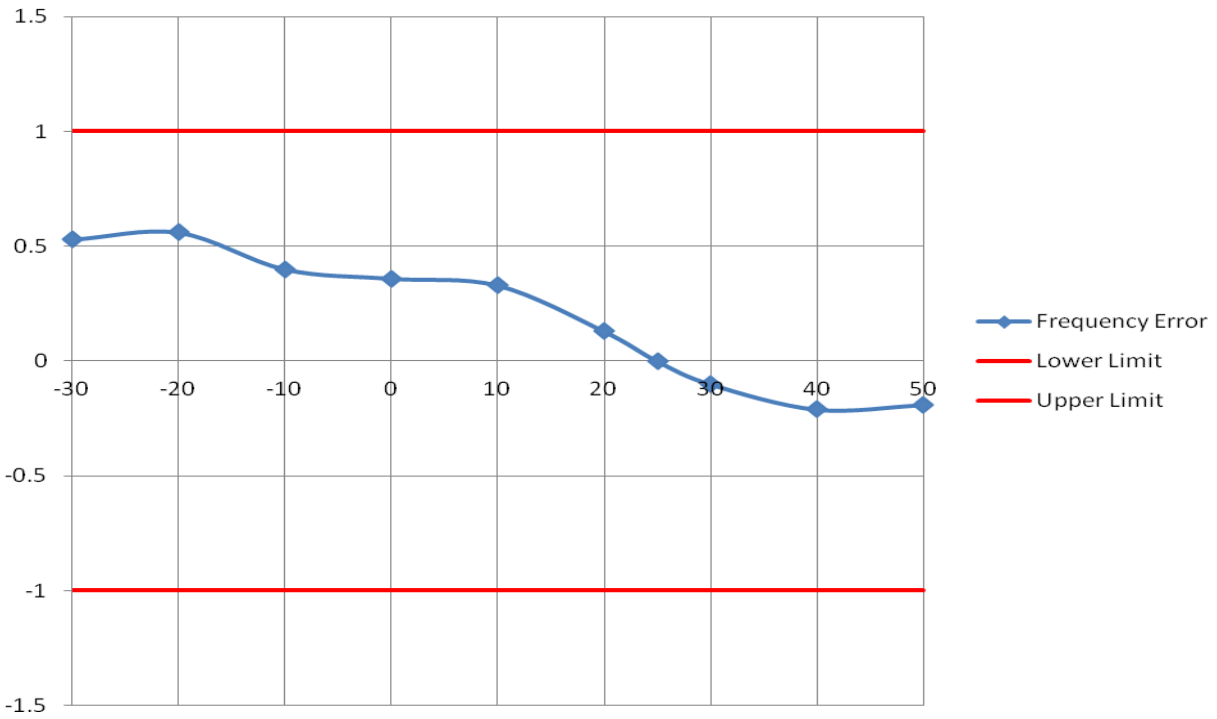

Frequency Stability vs Temperature

**TYPE OF EXHIBIT:** FREQUENCY STABILITY VS SUPPLY VOLTAGE

**FCC PART:** 2.1055(d)(1)

**MANUFACTURER:** RITRON, Inc.

**MODEL:** DTX-460-0\_\_6

**TYPE OF UNIT:** UHF Transceiver Module

**FCC ID:** AIERIT33-4600

**DATE:** October 19, 2011

**PROCEDURE:**

1. The DTX-460 was aligned for transmitter operation at 461.750 MHz at full rated power per the tune-up procedure outlined in the Maintenance manual. The unit was setup with the internal regulator option which regulates the nominal input voltage of 11 VDC to 16 VDC (12.6 VDC nominal) to 7.5 VDC for use by the DTX-460.
2. The RF output of the DTX-460 was connected to an HP 8920B Test Set to monitor the transmitter frequency. An Astron VS 20M Power Supply was adjusted for a nominal voltage of 12.6 VDC and connected to the DC power supply input of the DTX-460. The output frequency of the DTX-460 was noted and used as the reference for the results in paragraph 3 below.
3. The power supply voltage was set to 85% nominal and 115% nominal and the frequency noted.
4. The above was repeated for the unit setup in the unregulated configuration and the power supply set for a nominal voltage of 7.5 VDC.

**TYPE OF EXHIBIT:** FREQUENCY STABILITY VS SUPPLY VOLTAGE

**FCC PART:** 2.1055(d)(1)

**MANUFACTURER:** RITRON, Inc.

**MODEL:** DTX-460-0\_\_6

**TYPE OF UNIT:** UHF Transceiver Module

**FCC ID:** AIERIT33-4600

**DATE:** October 19, 2011

**RESULTS:**

Regulated Configuration

% Nominal	Voltage VDC	$\Delta F$ Hz	$\Delta F$ ppm
85	10.7	0	0
100	12.6	0	0
115	14.5	0	0

Unregulated Configuration

% Nominal	Voltage VDC	$\Delta F$ Hz	$\Delta F$ ppm
85	6.4	-11	0.02
100	7.5	0	0
115	8.6	0	0

**TYPE OF TEST:** TRANSIENT FREQUENCY BEHAVIOR

**FCC PART:** 90.214

**MANUFACTURER:** RITRON, INC.

**MODEL:** DTX-460-0\_\_6

**TYPE OF UNIT:** UHF Transceiver Module

**FCC ID:** AIERIT33-4600

**DATE:** October 19, 2011

**PROCEDURE:**

1. The DTX-460 was aligned for transmitter operation on 461.750 MHz at full rated power per the tune-up procedure outlined in the Maintenance Manual.
2. The test equipment was connected per the following diagram:

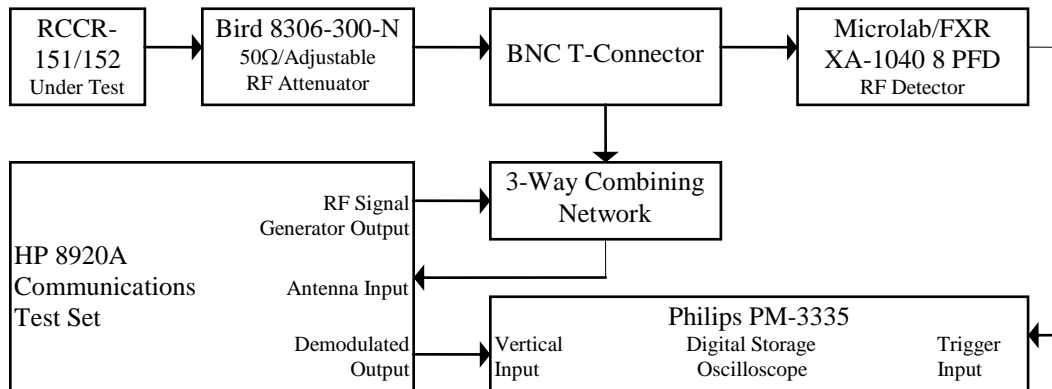

3. The HP 8920A Receiver was set to measure FM deviation with the audio bandwidth set at <50 Hz to greater than 15 kHz with the RF frequency set to 461.750 MHz. The attenuator was set for 10 dB.
4. The DTX-460 transmitter under test was activated and the HP 8920A Spectrum Analyzer was used to measure the RF power level through the test network.

**TYPE OF TEST:** TRANSIENT FREQUENCY BEHAVIOR  
**FCC PART:** 90.214  
**MANUFACTURER:** RITRON, INC.  
**MODEL:** DTX-460-0\_\_6  
**TYPE OF UNIT:** UHF Transceiver Module  
**FCC ID:** AIERIT33-4600  
**DATE:** October 19, 2011

**PROCEDURE** (continued):

5. The DTX-460 transmitter was turned off. The HP 8920A RF Signal Generator was set to 461.750 MHz at an RF level at the HP 8920A which was 30 dB below that measured in step 3 and modulated with a 1 kHz tone at +/-6.25 kHz deviation.
6. The Philips PM-3335 Digital Oscilloscope Horizontal Sweep Rate was set to 10 msec/div. The Vertical Amplitude Control was adjusted to display the 1000 Hz demodulated audio from the Signal Generator at +/-4 divisions, vertically centered on the screen.
7. The Philips PM-3335 Digital Oscilloscope was set to trigger at 1 division from the left side of the display when the RF Detector sensed RF power from the DTX-460 transmitter.
8. The DTX-460 transmitter was activated and the resulting waveform on the oscilloscope display was stored and plotted. The FCC limits per Part 90.214 were added to the plot. The resulting plot is labeled "Switch On Condition" and shows compliance with FCC Part 90.214/IC RSS-119, section 6.5.
9. The Philips PM-3335 Digital Oscilloscope was set to trigger at 1 division from the right side of the display when the RF Detector senses loss of RF power from the DTX-460 transmitter.
10. The DTX-460 transmitter was turned off and the resulting waveform on the oscilloscope display was stored and plotted. The limits per FCC Part 90.214/RSS-119, section 6.5 were added to the plot in the same manner illustrated in EIA-603 Part 3.2.19.2. The resulting plot is labeled "Switch Off Condition" and shows compliance.
11. Since this product supports 6.25 kHz and 12.5 kHz channel operation, the more stringent 6.25 kHz limits are shown.

**TYPE OF TEST:** TRANSIENT FREQUENCY BEHAVIOR

**FCC PART:** 90.214

**MANUFACTURER:** RITRON, INC.

**MODEL:** DTX-460-0\_\_6

**TYPE OF UNIT:** UHF Transceiver Module

**FCC ID:** AIERIT33-4600

**DATE:** October 19, 2011

**RESULTS:** Switch-On Condition

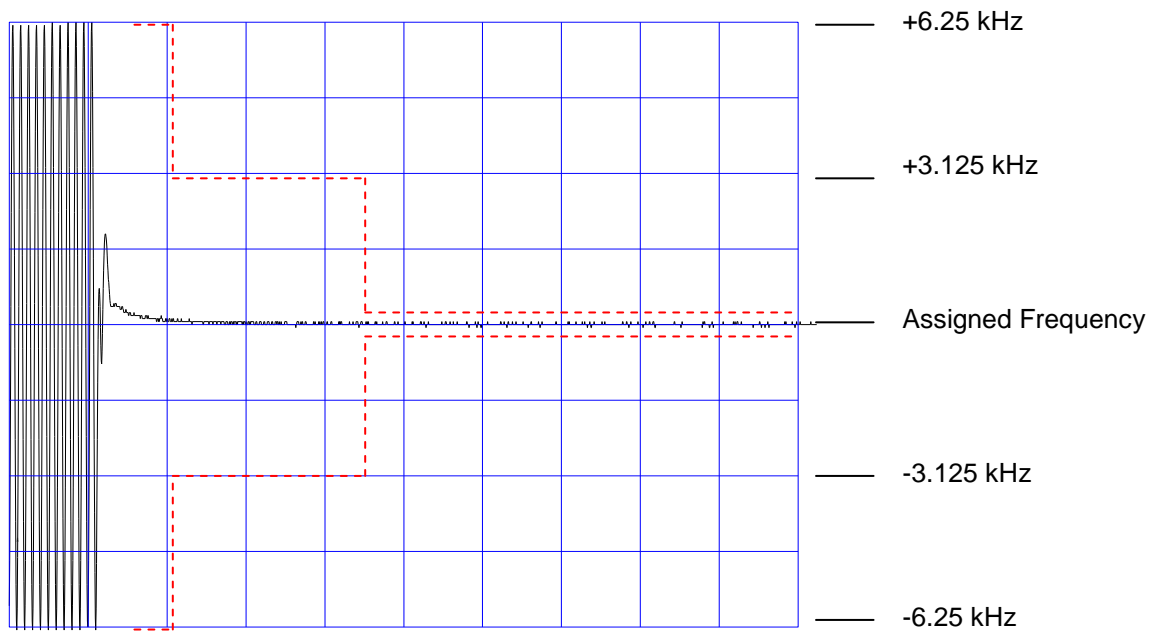

10 ms/div

**TYPE OF TEST:** TRANSIENT FREQUENCY BEHAVIOR

**FCC PART:** 90.214

**MANUFACTURER:** RITRON, INC.

**MODEL:** DTX-460-0\_\_6

**TYPE OF UNIT:** UHF Transceiver Module

**FCC ID:** AIERIT33-4600

**DATE:** October 19, 2011

**RESULTS:** Switch-Off Condition

