

**TYPE OF EXHIBIT:** LIST OF ATTACHED EXHIBITS  
**FCC PART:** 2.1033(c)(14)  
**IC PART:**  
**MANUFACTURER:** RITRON, Inc.  
**MODEL:** RPM-460  
**TYPE OF UNIT:** UHF Mobile Transceiver  
**FCC ID:** AIERIT24-460  
**IC ID:** 1084A-RIT24460  
**DATE:** March 15, 2006

The following exhibits are contained in this file:

<u>Description of Exhibit</u>	<u>Page</u>
List of Test Equipment Used	3
Description of Measurement Facility	4
Interface Impedances	5
Radio Frequency Output Power	6
Modulator Response	8
Clipper Filter Response	11
Modulation Limiting Curves	13
Occupied Bandwidth	16
Bandwidth Calculations/Modulation Types	19
Conducted Spurious Emissions-Transmitter	20
Conducted Spurious Emissions-Receiver	24
Field Strength of Spurious Emissions-Transmitter	26

**TYPE OF EXHIBIT:** LIST OF ATTACHED EXHIBITS  
**FCC PART:** 2.1033(c)(14)  
**IC PART:**  
**MANUFACTURER:** RITRON, Inc.  
**MODEL:** RPM-460  
**TYPE OF UNIT:** UHF Mobile Transceiver  
**FCC ID:** AIERIT24-460  
**IC ID:** 1084A-RIT24460  
**DATE:** March 15, 2006

<u>Description of Exhibit</u>	<u>Page</u>
Field Strength of Spurious Emissions-Receiver	30
Frequency Stability vs Temperature	33
Frequency Stability vs Supply Voltage	35
Transient Frequency Behavior	37

**TYPE OF EXHIBIT:** LIST OF TEST EQUIPMENT USED

**FCC PART:** 2.947(d)

**IC PART:**

**MANUFACTURER:** RITRON, Inc.

**MODEL:** RPM-460

**TYPE OF UNIT:** UHF Mobile Transceiver

**FCC ID:** AIERIT24-460

**IC ID:** 1084A-RIT24460

**DATE:** March 15, 2006

All measurements were conducted with one or more of the following pieces of equipment:

ITEM	MANUFACTURER	MODEL NO.	SERIAL NO.
DC Power Supply	Astron	VS 12M	90071655
Multimeter	Fluke	45	6967029
Multimeter	BK Precision	2704A	234-008455
Wattmeter	Telewave	612	15081
RF Test Set	Hewlett-Packard	8920A	01498
Spectrum Analyzer	Advantest	R3265A	75060189
Spectrum Analyzer	Hewlett-Packard	8560E	3720A02980
Storage Scope	Fluke/Philips	PM3335	DM630034
Temp. Chamber	Delta Design	3900 CL	0-52-R
Frequency Counter	Hewlett-Packard	5383A	1716A01417
Audio Test Set	Audio Precision	SYS-322A	SYS1-33641
Thermocouple	Triplett	320-G/P	

**TYPE OF EXHIBIT:** DESCRIPTION OF MEASUREMENT FACILITY  
**FCC PART:** 2.948  
**IC PART:**  
**MANUFACTURER:** RITRON, Inc.  
**MODEL:** RPM-460  
**TYPE OF UNIT:** UHF Mobile Transceiver  
**FCC ID:** AIERIT24-460  
**IC ID:** 1084A-RIT24460  
**DATE:** March 15, 2006

The Field Strength measurements filed with this application were made on a site certified by RITRON, Inc. Data pertaining to this site are on file with the FCC and Industry Canada and are current.

This site is used on a continuing basis exclusively by RITRON, Inc. and is utilized only for RF Field Strength measurements of equipment designed and manufactured by RITRON, Inc. It is not used for measurements by, or for, any other party on a contract basis or otherwise.

All other measurements were taken at RITRON's Engineering Laboratory in Carmel, IN.

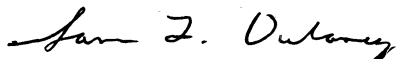

Sam L. Dulaney  
Chief Engineer  
RITRON, Inc.

**TYPE OF EXHIBIT:** INTERFACE IMPEDANCES  
**FCC PART:**  
**IC PART:** RSS-119, Section 5.6  
**MANUFACTURER:** RITRON, Inc.  
**MODEL:** RPM-460  
**TYPE OF UNIT:** UHF Mobile Transceiver  
**FCC ID:** AIERIT24-460  
**IC ID:** 1084A-RIT24460  
**DATE:** March 15, 2006

Audio Input:

The nominal input impedance of the audio inputs is 10k-ohms resistive.

Audio Output:

The nominal audio output impedance of the audio power amplifier is 0 ohms resistive with a nominal load impedance of 8 ohms resistive.

RF Output

The nominal load impedance for the RF output is 50 ohms resistive.

**TYPE OF EXHIBIT:** RADIO FREQUENCY OUTPUT POWER

**FCC PART:** 2.1046(a)

**IC PART:** RSS-199, Section 6.2

**MANUFACTURER:** RITRON, Inc.

**MODEL:** RPM-460

**TYPE OF UNIT:** UHF Mobile Transceiver

**FCC ID:** AIERIT24-460

**IC ID:** 1084A-RIT24460

**DATE:** March 15, 2006

**PROCEDURE:**

1. The RPM-460 was aligned for transmitter operation at full rated power per the tune-up procedure outlined in the Maintenance manual for frequencies at the lower, middle and upper band edges.
2. Power was supplied to the RPM-460 by an Astron VS 12M Power Supply. The RPM-460 was connected to a Bird 6154 Thermaline Wattmeter used to measure the RF carrier power. The wattmeter provides a resistive 50-ohm termination at the frequencies and power levels used for this test.
3. A B&K Digital Multimeter was connected in series with the drain lead of the final RF output transistor and set to measure current ( $I_d$ ). A Fluke 45 Digital Multimeter was used to measure the final RF output stage power control voltage ( $V_c$ ) and drain voltage ( $V_d$ ).
4. Measurements were taken at various power levels between 5.0 watts and 40.0 watts.

**TYPE OF EXHIBIT:** RADIO FREQUENCY OUTPUT POWER  
**FCC PART:** 2.1046(a)  
**IC PART:** RSS-119, Section 6.2  
**MANUFACTURER:** RITRON, Inc.  
**MODEL:** RPM-460  
**TYPE OF UNIT:** UHF Mobile Transceiver  
**FCC ID:** AIERIT24-460  
**IC ID:** 1084A-RIT24460  
**DATE:** March 15, 2006

**RESULTS:**

Frequency (MHz)	Po (watts)	Vc (V)	Vd (V)	Id (A)
450.100	5.0	3.2	13.7	1.7
450.100	15.0	3.4	13.7	3.4
450.100	30.0	3.7	13.7	6.1
450.100	40.0	4.6	13.7	7.7
460.100	5.0	3.4	13.7	1.9
460.100	15.0	3.6	13.7	3.7
460.100	30.0	3.9	13.7	6.3
460.100	40.0	4.8	13.7	7.8
469.100	5.0	3.4	13.7	1.8
469.100	15.0	3.6	13.7	3.7
469.100	30.0	4.0	13.7	6.0
469.100	40.0	4.3	13.7	7.6

**TYPE OF EXHIBIT:** MODULATOR RESPONSE  
**FCC PART:** 2.1047(a)  
**IC PART:** RSS-119, Section 6.6  
**MANUFACTURER:** RITRON, Inc.  
**MODEL:** RPM-460  
**TYPE OF UNIT:** UHF Mobile Transceiver  
**FCC ID:** AIERIT24-460  
**IC ID:** 1084A-RIT24460  
**DATE:** March 15, 2006

**PROCEDURE:**

1. The RPM-460 was aligned for transmitter operation at 460.100 MHz at full rated power per the tune-up procedure outlined in the Maintenance manual.
2. The response was measured from the microphone input to the output of the audio processing IC where it connects to the modulator.
3. The audio test set was swept in frequency from 200 Hz to 20 kHz and the results noted. The test was run for the audio processor IC set for both 12.5 kHz channel and 25 kHz channel operation.



**TYPE OF EXHIBIT:** MODULATOR RESPONSE  
**FCC PART:** 2.1047(a)  
**IC PART:** RSS-119, Section 6.6  
**MANUFACTURER:** RITRON, Inc.  
**MODEL:** RPM-460  
**TYPE OF UNIT:** UHF Mobile Transceiver  
**FCC ID:** AIERIT24-460  
**IC ID:** 1084A-RIT24460  
**DATE:** March 15, 2006  
**RESULTS:** 12.5 kHz channel spacing

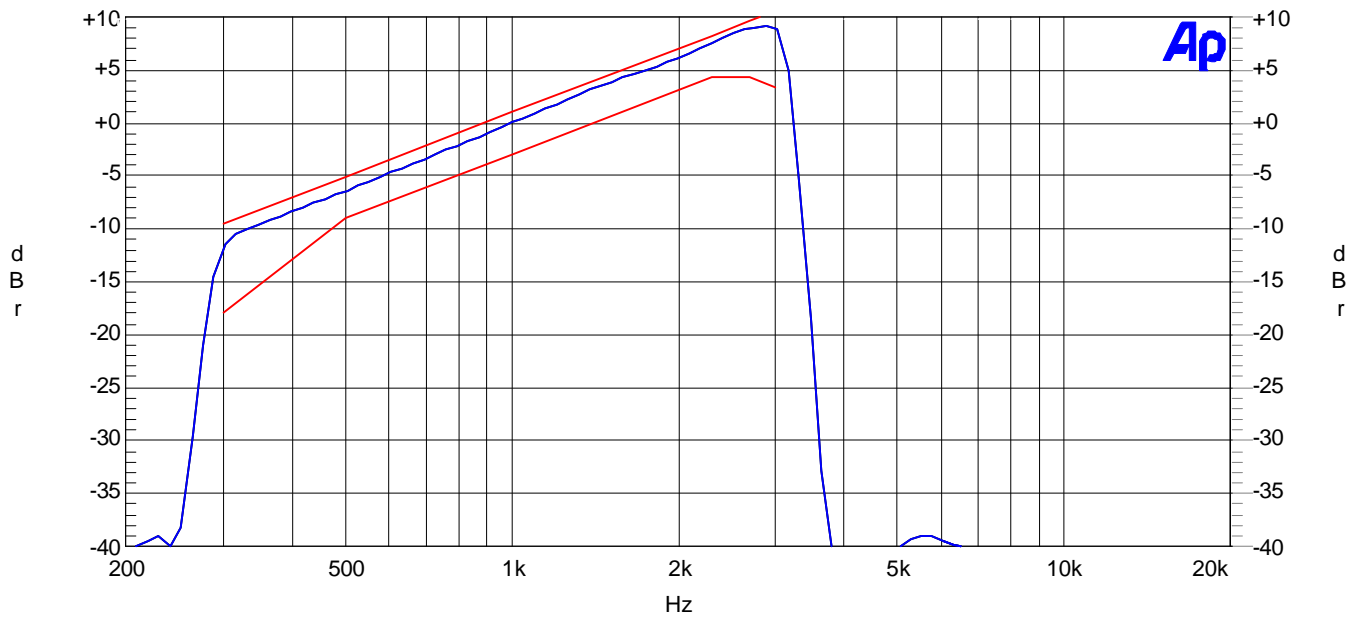

**TYPE OF EXHIBIT:** MODULATOR RESPONSE  
**FCC PART:** 2.1047(a)  
**IC PART:** RSS-119, Section 6.6  
**MANUFACTURER:** RITRON, Inc.  
**MODEL:** RPM-460  
**TYPE OF UNIT:** UHF Mobile Transceiver  
**FCC ID:** AIERIT24-460  
**IC ID:** 1084A-RIT24460  
**DATE:** March 15, 2006  
**RESULTS:** 25 kHz channel spacing

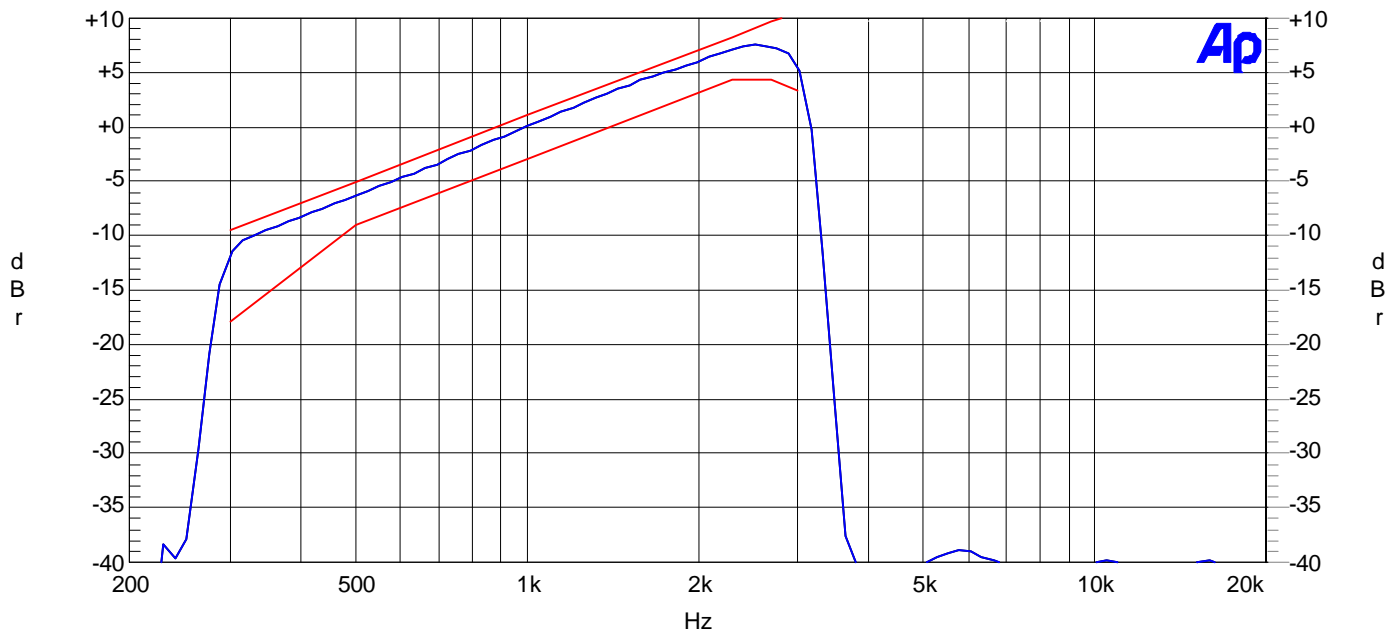

**TYPE OF EXHIBIT:** CLIPPER FILTER RESPONSE

**FCC PART:** 2.1047(a)

**IC PART:**

**MANUFACTURER:** RITRON, Inc.

**MODEL:** RPM-460

**TYPE OF UNIT:** UHF Mobile Transceiver

**FCC ID:** AIERIT24-460

**IC ID:** 1084A-RIT24460

**DATE:** March 15, 2006

**PROCEDURE:**

1. The audio processing was set up so that all filtering except the clipper filter was removed from the transmit audio path.
2. The audio generator frequency was swept from 200 Hz to 20 kHz and the response noted and plotted. The same clipper filter is used for both 12.5 kHz channel operation and 25 kHz operation. Therefore, only one response is shown.

**TYPE OF EXHIBIT:** CLIPPER FILTER RESPONSE

**FCC PART:** 2.1047(a)

**IC PART:**

**MANUFACTURER:** RITRON, Inc.

**MODEL:** RPM-460

**TYPE OF UNIT:** UHF Mobile Transceiver

**FCC ID:** AIERIT24-460

**IC ID:** 1084A-RIT24460

**DATE:** March 15, 2006

**RESULTS:**

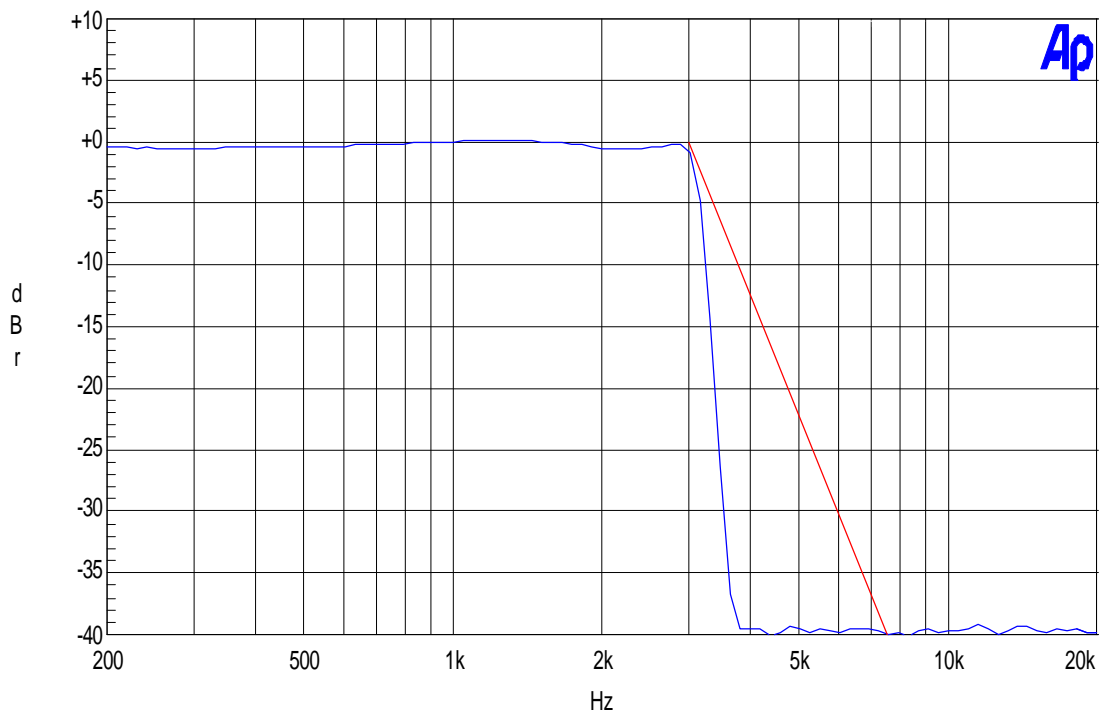

**TYPE OF EXHIBIT:** MODULATION LIMITING CURVES

**FCC PART:** 2.1047(b)

**IC PART:**

**MANUFACTURER:** RITRON, Inc.

**MODEL:** RPM-460

**TYPE OF UNIT:** UHF Mobile Transceiver

**FCC ID:** AIERIT24-460

**IC ID:** 1084A-RIT24460

**DATE:** March 15, 2006

**PROCEDURE:**

1. The RPM-460 was aligned for transmitter operation on 460.100 MHz per the tune-up procedure outlined in the Maintenance manual.
2. The RF output was connected to the RF input of a radio Test Set configured to measure FM deviation. The audio output of the audio test set was routed to the microphone input of the RPM-460.
3. The frequency of the audio generator was adjusted to find the frequency of maximum response. The RPM-460 transmit deviation was adjusted for 5 kHz maximum deviation as outlined in the Maintenance manual. The audio generator level was reduced to produce 50% of maximum deviation and the level noted.
4. The audio frequency was set to 300 Hz and the output level was varied from zero to a level at least 16 dB above that required to produce 50% maximum deviation noted in step 3 above.
5. Step 4 was repeated for audio frequencies of 1000 and 3000 Hz and for the audio processing IC set for 12.5 kHz operation.

**TYPE OF EXHIBIT:** MODULATION LIMITING CURVES  
**FCC PART:** 2.1047(b)  
**IC PART:**  
**MANUFACTURER:** RITRON, Inc.  
**MODEL:** RPM-460  
**TYPE OF UNIT:** UHF Mobile Transceiver  
**FCC ID:** AIERIT24-460  
**IC ID:** 1084A-RIT24460  
**DATE:** March 15, 2006  
**RESULTS:** 12.5 kHz channel spacing

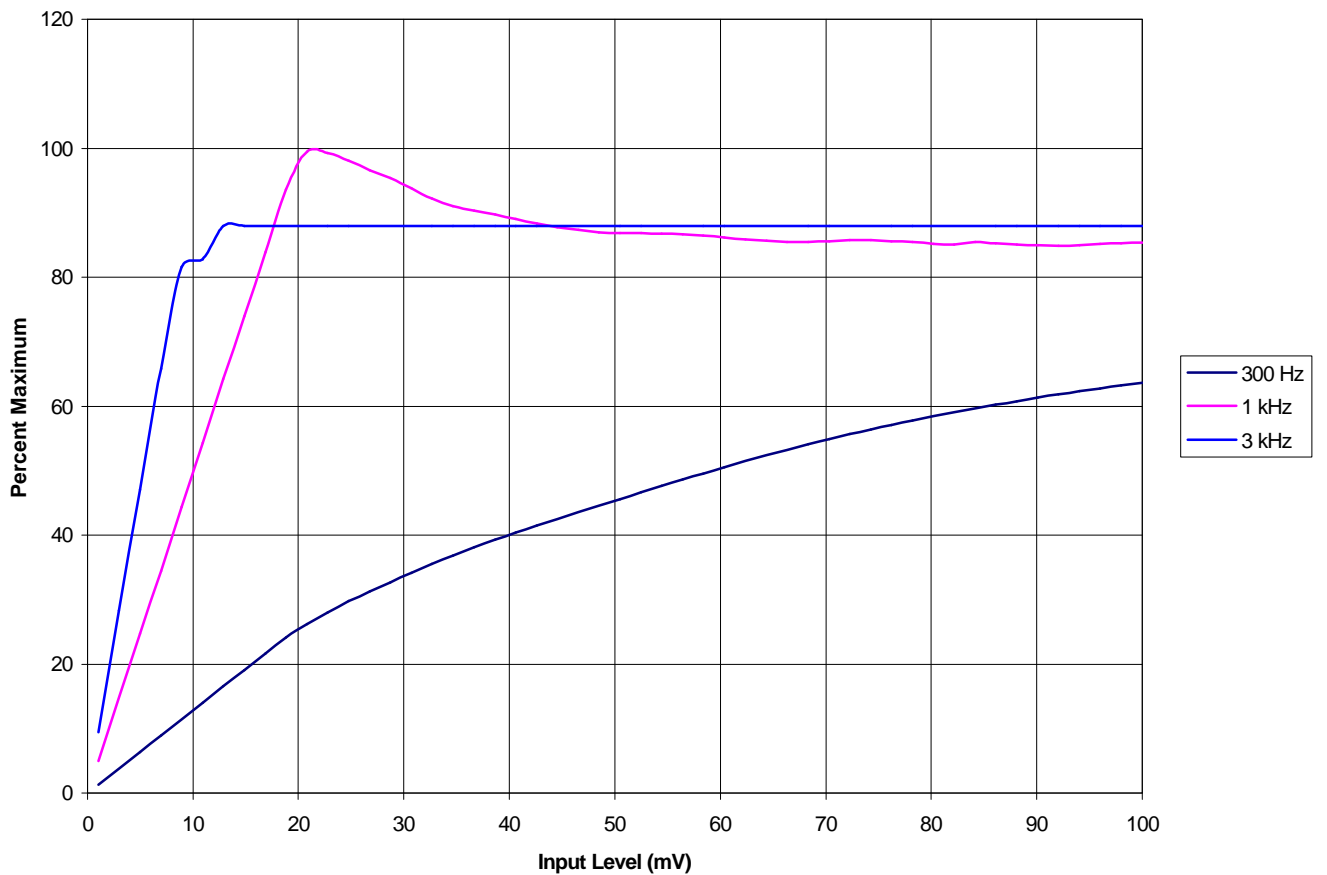

Note: 100% modulation represents 2.5 kHz deviation.

**TYPE OF EXHIBIT:** MODULATION LIMITING CURVES  
**FCC PART:** 2.1047(b)  
**IC PART:**  
**MANUFACTURER:** RITRON, Inc.  
**MODEL:** RPM-460  
**TYPE OF UNIT:** UHF Mobile Transceiver  
**FCC ID:** AIERIT24-460  
**IC ID:** 1084A-RIT24460  
**DATE:** March 15, 2006  
**RESULTS:** 25 kHz channel operation

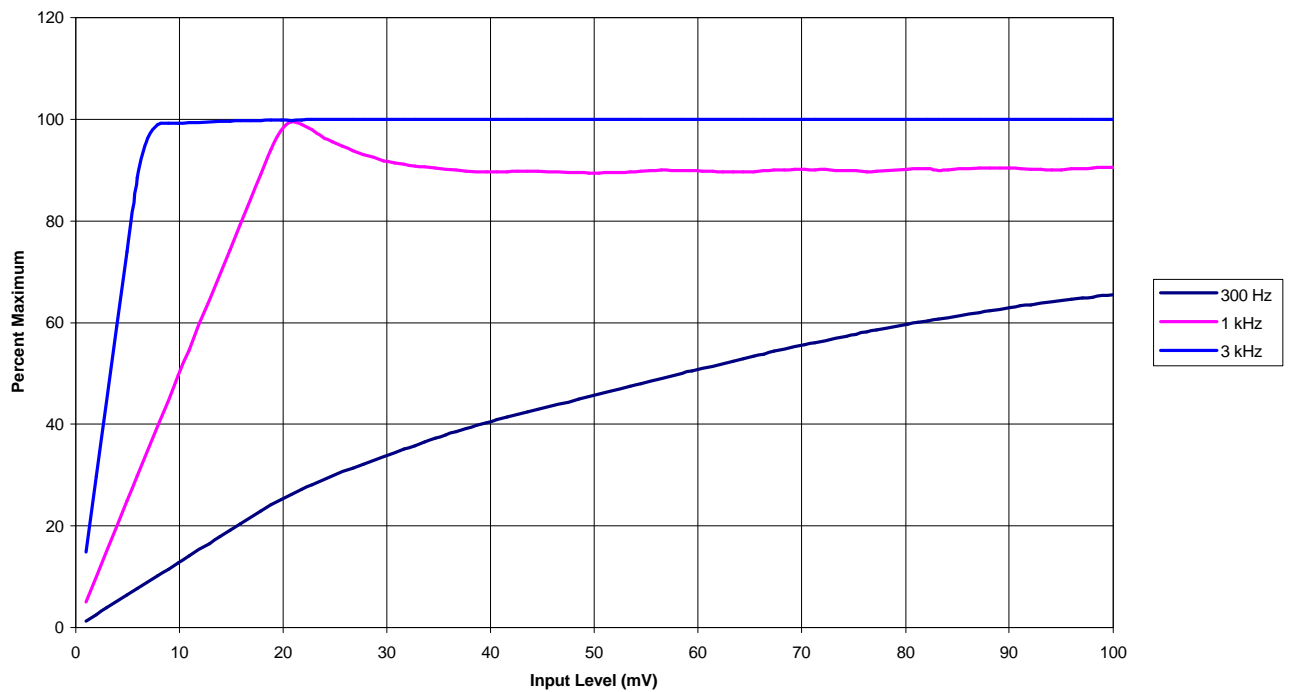

Note: 100% modulation represents 5 kHz deviation.

**TYPE OF EXHIBIT:** OCCUPIED BANDWIDTH

**FCC PART:** 2.1049(c)(1), 90.210(d)

**IC PART:** RSS-119, Section 6.4

**MANUFACTURER:** RITRON, Inc.

**MODEL:** RPM-460

**TYPE OF UNIT:** UHF Mobile Transceiver

**FCC ID:** AIERIT24-460

**IC ID:** 1084A-RIT24460

**DATE:** March 15, 2006

**PROCEDURE:**

1. The RPM-460 was aligned for transmitter operation on 460.100 MHz at 40 watts per the tune-up procedure outlined in the Maintenance manual. The transmitter was modulated with a 2500 Hz tone at a level 16 dB greater than that required to produce 50% maximum deviation of +/- 2.5 kHz.
2. The RF output was connected to an HP 8560E spectrum analyzer through a 30 dB, 100-watt, 50 ohm RF attenuator. The center frequency of the spectrum analyzer was set to the transmitter frequency. The sweep span was set for 100 kHz and the resolution and video bandwidth set for 100 kHz. The detector was set for peak hold mode.
3. The RPM-460 transmitter was keyed and the reference level for the spectrum analyzer set to the maximum level of the RF input signal. The resolution bandwidth and video bandwidth were set to 100 Hz and the results plotted along with emission mask D.
4. The deviation was increased to 5 kHz and the radio was set for 25 kHz channel spacing operation. The frequency span was increased to 100 kHz with resolution and video bandwidths set at 300 Hz and the results were plotted.



**TYPE OF EXHIBIT:** OCCUPIED BANDWIDTH  
**FCC PART:** 2.1049(c)(1), 90.210(d)  
**IC PART:** RSS-119, Section 6.4  
**MANUFACTURER:** RITRON, Inc.  
**MODEL:** RPM-460  
**TYPE OF UNIT:** UHF Mobile Transceiver  
**FCC ID:** AIERIT24-460  
**IC ID:** 1084A-RIT24460  
**DATE:** March 15, 2006  
**RESULTS:** 12.5 kHz channel operation

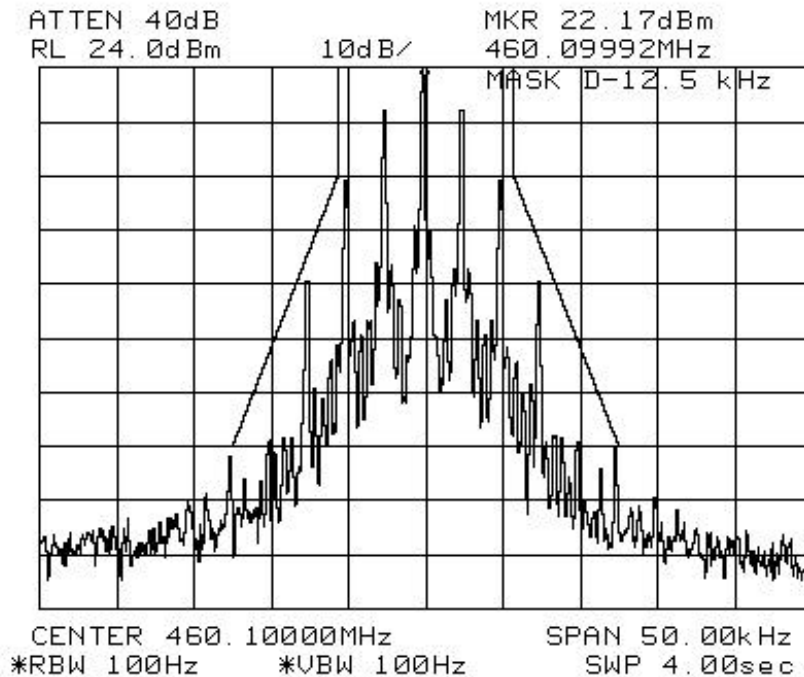

**TYPE OF EXHIBIT:** OCCUPIED BANDWIDTH  
**FCC PART:** 2.1049(c)(1), 90.210(d)  
**IC PART:** RSS-119, Section 6.4  
**MANUFACTURER:** RITRON, Inc.  
**MODEL:** RPM-460  
**TYPE OF UNIT:** UHF Mobile Transceiver  
**FCC ID:** AIERIT24-460  
**IC ID:** 1084A-RIT24460  
**DATE:** March 15, 2006  
**RESULTS:** 25 kHz channel operation

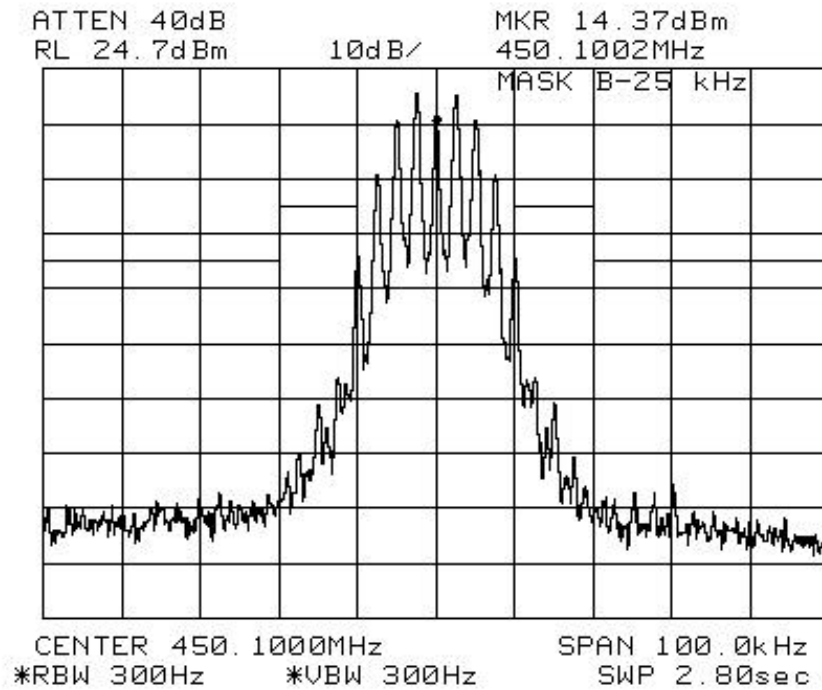

**TYPE OF EXHIBIT:** BANDWIDTH CALCULATION/MODULATION TYPE  
**FCC PART:** 2.1049(c)(1), 90.210(d)  
**IC PART:** RSS-119, Section 5.7  
**MANUFACTURER:** RITRON, Inc.  
**MODEL:** RPM-460  
**TYPE OF UNIT:** UHF Mobile Transceiver  
**FCC ID:** AIERIT24-460  
**IC ID:** 1084A-RIT24460  
**DATE:** March 15, 2006

**RESULTS:**

Modulation:

This device used direct frequency modulation with a nominal maximum deviation of 2.5 kHz for 12.5 kHz channel operation and 5 kHz for 25 kHz channel operation.

Occupied Bandwidth:

By Carson's rule, the occupied bandwidth for an FM signal may be calculated by:

$BW = 2(f_{\Delta} + f_m)$  where  $f_{\Delta}$  is the frequency deviation and  $f_m$  is the modulating frequency.

12.5 kHz channel operation:

For 12.5 kHz channel operation, the maximum frequency of modulation is 2.7 kHz and the deviation is 2.5 kHz. Therefore, the occupied bandwidth is 10.4 kHz. The emission designator is therefore 10K4F3E.

25 kHz channel operation:

For 25 kHz channel operation, the maximum frequency of modulation is 2.5 kHz and the deviation is 5 kHz. Therefore, the occupied bandwidth is 15 kHz. The emission designator is therefore 15K0F3E.

**TYPE OF EXHIBIT:** CONDUCTED SPURIOUS EMISSIONS-  
TRANSMITTER

**FCC PART:** 2.1051, 90.210(d)

**IC PART:** RSS-119, Section 6.3

**MANUFACTURER:** RITRON, Inc.

**MODEL:** RPM-460

**TYPE OF UNIT:** UHF Mobile Transceiver

**FCC ID:** AIERIT24-460

**IC ID:** 1084A-RIT24460

**DATE:** March 15, 2006

**PROCEDURE:**

1. The RPM-460 was aligned for transmitter operation at the band edges and the band center at power levels ranging from 5 watts to 40 watts per the tune-up procedure outlined in the Maintenance manual. The transmitter was modulated with a 2500 Hz tone at a level 16 dB greater than that required to produce 50% maximum deviation at the modulation frequency of maximum deviation. The maximum deviation was set for +/- 2.5 kHz.
2. The RF output was connected to an HP 8560E spectrum analyzer through a 30 dB, 100 watt, 50 ohm RF attenuator. The center frequency of the spectrum analyzer was set to the transmitter frequency. The frequency span and resolution and video bandwidths were set to 100 kHz. The transmitter was keyed and the reference level on the analyzer noted.
3. An RF highpass filter was inserted into the path from the attenuator to the spectrum analyzer. The transmitter was keyed and the output spectrum was examined from 9 kHz to 10 times the operating frequency, except within 100 kHz of the operating frequency. The attenuation of the highpass filter at the transmitter spurious frequencies was measured and factored into the attenuator calculations.

**TYPE OF EXHIBIT:** CONDUCTED SPURIOUS EMISSIONS-TRANSMITTER

**FCC PART:** 2.1051, 90.210(d)

**IC PART:** RSS-119, Section 6.3

**MANUFACTURER:** RITRON, Inc.

**MODEL:** RPM-460

**TYPE OF UNIT:** UHF Mobile Transceiver

**FCC ID:** AIERIT24-460

**IC ID:** 1084A-RIT24460

**DATE:** March 15, 2006

**RESULTS:**

Corrected Spur level(dBm) = Spur level @ analyzer(dBm) + Attenuator loss(dB)

Frequency (MHz)	Spur Frequency (MHz)	Spur level (dBm)	Atten. loss (dB)	Corr. Spur (dBm)	Limit (dBm)
-----------------	----------------------	------------------	------------------	------------------	-------------

Output Power = 5 watts

450.100	900.200	-66	30	-36	-20
460.100	920.200	-64	30	-34	-20
469.100	938.200	-63	30	-33	-20

Output Power = 15 watts

450.100	900.200	-62	30	-32	-20
450.100	2250.500	-70	30	-40	-20
460.100	920.200	-62	30	-32	-20
460.100	1380.300	-66	30	-36	-20
469.100	938.200	-60	30	-30	-20
469.100	1407.300	-68	30	-38	-20

Emissions more than 20 below limit are not reported.

**TYPE OF EXHIBIT:** CONDUCTED SPURIOUS EMISSIONS TRANSMITTER

**FCC PART:** 2.1051, 90.210(d)

**IC PART:** RSS-119, Section 6.3

**MANUFACTURER:** RITRON, Inc.

**MODEL:** RPM-460

**TYPE OF UNIT:** UHF Mobile Transceiver

**FCC ID:** AIERIT24-460

**IC ID:** 1084A-RIT24460

**DATE:** March 15, 2006

**RESULTS:**

Corrected Spur level(dBm) = Spur level @ analyzer(dBm) + Attenuator loss(dB)

Frequency (MHz)	Spur Frequency (MHz)	Spur level (dBm)	Atten. loss (dB)	Corr. Spur (dBm)	Limit (dBm)
Output Power = 30 watts					
450.100	900.200	-68	30	-38	-20
450.100	1350.300	-65	30	-35	-20
450.100	2250.500	-68	30	-38	-20
460.100	920.200	-68	30	-38	-20
460.100	1380.300	-62	30	-32	-20
460.100	2300.500	-68	30	-38	-20
460.100	4140.900	-65	30	-35	-20
469.100	938.200	-64	30	-34	-20
469.100	1407.300	-65	30	-35	-20
469.100	2345.500	-67	30	-37	-20
469.100	4221.900	-65	30	-35	-20
469.100	4691.000	-65	30	-35	-20

Emissions more than 20 below limit are not reported.

**TYPE OF EXHIBIT:** CONDUCTED SPURIOUS EMISSIONS TRANSMITTER

**FCC PART:** 2.1051, 90.210(d)

**IC PART:** RSS-119, Section 6.3

**MANUFACTURER:** RITRON, Inc.

**MODEL:** RPM-460

**TYPE OF UNIT:** UHF Mobile Transceiver

**FCC ID:** AIERIT24-460

**IC ID:** 1084A-RIT24460

**DATE:** March 15, 2006

**RESULTS:**

Corrected Spur level(dBm) = Spur level @ analyzer(dBm) + Attenuator loss(dB)

Frequency (MHz)	Spur Frequency (MHz)	Spur level (dBm)	Atten. loss (dB)	Corr. Spur (dBm)	Limit (dBm)
Output Power = 40 watts					
450.100	1350.300	-65	30	-35	-20
450.100	2250.500	-62	30	-32	-20
450.100	2700.600	-66	30	-36	-20
450.100	4050.800	-62	30	-32	-20
450.100	4501.000	-60	30	-30	-20
460.100	1380.300	-67	30	-37	-20
460.100	2300.500	-65	30	-35	-20
460.100	2760.600	-70	30	-40	-20
460.100	4140.900	-60	30	-30	-20
460.100	4601.000	-63	30	-33	-20
469.100	938.200	-66	30	-36	-20
469.100	1407.300	-62	30	-32	-20
469.100	2345.500	-62	30	-32	-20
469.100	4221.900	-62	30	-32	-20
469.100	4691.000	-65	30	-35	-20

Emissions more than 20 below limit are not reported.

**TYPE OF EXHIBIT:** CONDUCTED SPURIOUS EMISSIONS-RECEIVER

**FCC PART:** 15.111

**IC PART:** RSS-119, Section 8

**MANUFACTURER:** RITRON, Inc.

**MODEL:** RPM-460

**TYPE OF UNIT:** UHF Mobile Transceiver

**FCC ID:** AIERIT24-460

**IC ID:** 1084A-RIT24460

**DATE:** March 15, 2006

**PROCEDURE:**

1. The RPM-460 was set for receive operation at the band edges and the band center.
2. The RF output was connected directly to an HP 8560E spectrum analyzer. The center frequency of the spectrum analyzer was scanned from the lowest generated frequency to 2 GHz. The frequency span and resolution and video bandwidths were set to 100 kHz.



**TYPE OF EXHIBIT:** CONDUCTED SPURIOUS EMISSIONS-RECEIVER

**FCC PART:** 15.111

**IC PART:** RSS-119, Section 8

**MANUFACTURER:** RITRON, Inc.

**MODEL:** RPM-460

**TYPE OF UNIT:** UHF Mobile Transceiver

**FCC ID:** AIERIT24-460

**IC ID:** 1084A-RIT24460

**DATE:** March 15, 2006

**RESULTS:**

Operating Frequency	Spurious Frequency	Spurious Level	Limit
450.1 MHz	None noted	<-110 dBm	-57 dBm
460.1 MHz	None noted	<-110 dBm	-57 dBm
469.1 MHz	None noted	<-110 dBm	-57 dBm

**TYPE OF EXHIBIT:** FIELD STRENGTH OF SPURIOUS EMISSIONS-  
TRANSMITTER

**FCC PART:** 2.1053(a), (b)

**IC PART:** RSS-119, Section 6.3

**MANUFACTURER:** RITRON, Inc.

**MODEL:** RPM-460

**TYPE OF UNIT:** UHF Mobile Transceiver

**FCC ID:** AIERIT24-460

**IC ID:** 1084A-RIT24460

**DATE:** March 15, 2006

**PROCEDURE:**

1. The measurements for field strength of spurious emissions were taken at the RITRON, Inc. 3-meter test site, details of which are on file with the FCC and Industry Canada.
2. The RPM-460 was aligned for transmitter operation on lower, center, and upper band edges at the 40 watt maximum output power rating for the unit per the tune-up procedure outlined in the Maintenance Manual. The unit was then terminated at the antenna port with a non-radiating 50-ohm load.
3. All field strength measurements were made with the Hewlett-Packard Model 8560E and 8559A Spectrum Analyzers and either a log periodic antenna, dipoles, or a microwave horn antenna depending upon frequency.
4. The transmitter was keyed and the spectrum searched from 9 kHz to the 10<sup>th</sup> harmonic of the transmit carrier. When a spurious emission was found, the height and polarization of the field strength measurement antenna and orientation of the RPM-460 were varied to provide maximum field strength.
5. A substitution antenna, a calibrated dipole, was substituted for the RPM-460 at the RPM-460's location. An RF signal generator was set for the frequency of the RPM-460 with the level at the substitution antenna noted.
6. The polarization of the substitution antenna was adjusted for maximum signal strength at the field strength measuring antenna. The level at the field strength antenna was noted.

**TYPE OF EXHIBIT:** FIELD STRENGTH OF SPURIOUS EMISSIONS TRANSMITTER

**FCC PART:** 2.1053(a), (b)

**IC PART:** RSS-119, Section 6.3

**MANUFACTURER:** RITRON, Inc.

**MODEL:** RPM-460

**TYPE OF UNIT:** UHF Mobile Transceiver

**FCC ID:** AIERIT24-460

**IC ID:** 1084A-RIT24460

**DATE:** March 15, 2006

**EQUATIONS:**

The spurious emission level is:

$$\text{Spur(dBm)} = \text{Pspur(dBm)} + \text{Pgen(dBm)} - \text{Pref(dBm)}$$

Where:

Pspur is the power level of the radio's emission at the receiving antenna output.

Pgen is the RF signal generator level at the substitution antenna input.

Pref is the power level of the substitution antenna emission at the receiving antenna output.

**TYPE OF EXHIBIT:** FIELD STRENGTH OF SPURIOUS EMISSIONS TRANSMITTER

**FCC PART:** 2.1053(a), (b)

**IC PART:** RSS-119, Section 6.3

**MANUFACTURER:** RITRON, Inc.

**MODEL:** RPM-460

**TYPE OF UNIT:** UHF Mobile Transceiver

**FCC ID:** AIERIT24-460

**IC ID:** 1084A-RIT24460

**DATE:** March 15, 2006

**RESULTS:** Horizontal Polarization

Freq. (MHz)	Spur Freq. (MHz)	Pspur (dBm)	Pgen (dBm)	Pref (dBm)	Spur Level (dBm)	Limit (dBm)
		<-100 dBm	0 dBm	-27.5 dBm	<-40 dBm	-20 dBm

No emissions were found within 20 dB of the specification limit.

**TYPE OF EXHIBIT:** FIELD STRENGTH OF SPURIOUS EMISSIONS TRANSMITTER

**FCC PART:** 2.1053(a), (b)

**IC PART:** RSS-119, Section 6.3

**MANUFACTURER:** RITRON, Inc.

**MODEL:** RPM-460

**TYPE OF UNIT:** UHF Mobile Transceiver

**FCC ID:** AIERIT24-460

**IC ID:** 1084A-RIT24460

**DATE:** March 15, 2006

**RESULTS:** Vertical Polarization

Freq. (MHz)	Spur Freq. (MHz)	Pspur (dBm)	Pgen (dBm)	Pref (dBm)	Spur Level (dBm)	Limit (dBm)
		<-100 dBm	0 dBm	-27.5 dBm	<-40 dBm	-20 dBm

No emissions were found within 20 dB of the specification limit.

**TYPE OF EXHIBIT:** FIELD STRENGTH OF SPURIOUS EMISSIONS-RECEIVER

**FCC PART:** 15.109

**IC PART:** RSS-119, Section 8

**MANUFACTURER:** RITRON, Inc.

**MODEL:** RPM-460

**TYPE OF UNIT:** UHF Mobile Transceiver

**FCC ID:** AIERIT24-460

**IC ID:** 1084A-RIT24460

**DATE:** March 15, 2006

**PROCEDURE:**

1. The measurements for field strength of spurious emissions were taken at the RITRON, Inc. 3-meter test site, details of which are on file with the FCC and Industry Canada.
2. The RPM-460 was aligned for operation on lower, center, and upper band edges. The unit was then terminated at the antenna port with a non-radiating 50-ohm load.
3. All field strength measurements were made with the Hewlett-Packard Model 8560E and 8559A Spectrum Analyzers and either a log periodic antenna, dipoles, or a microwave horn antenna depending upon frequency.
4. The spectrum searched from 9 kHz to the 10<sup>th</sup> harmonic of the local oscillator frequency. When a spurious emission was found, the height and polarization of the field strength measurement antenna and orientation of the RPM-460 were varied to provide maximum field strength.
5. A substitution antenna, a calibrated dipole, was substituted for the RPM-460 at the RPM-460's location. An RF signal generator was set for the frequency of the RPM-460 with the level at the substitution antenna noted.
6. The polarization of the substitution antenna was adjusted for maximum signal strength at the field strength measuring antenna. The level at the field strength antenna was noted.

**TYPE OF EXHIBIT:** FIELD STRENGTH OF SPURIOUS EMISSIONS-RECEIVER

**FCC PART:** 15.109

**IC PART:** RSS-119, Section 8

**MANUFACTURER:** RITRON, Inc.

**MODEL:** RPM-460

**TYPE OF UNIT:** UHF Mobile Transceiver

**FCC ID:** AIERIT24-460

**IC ID:** 1084A-RIT24460

**DATE:** March 15, 2006

**EQUATIONS:**

The spurious emission level is:

$$\text{Spur(dBm)} = \text{Pspur(dBm)} + \text{Pgen(dBm)} - \text{Pref(dBm)}$$

Where:

Pspur is the power level of the radio's emission at the receiving antenna output.

Pgen is the RF signal generator level at the substitution antenna input.

Pref is the power level of the substitution antenna emission at the receiving antenna output.

**TYPE OF EXHIBIT:** FIELD STRENGTH OF SPURIOUS EMISSIONS-RECEIVER

**FCC PART:** 15.109

**IC PART:** RSS-119, Section 8

**MANUFACTURER:** RITRON, Inc.

**MODEL:** RPM-460

**TYPE OF UNIT:** UHF Mobile Transceiver

**FCC ID:** AIERIT24-460

**IC ID:** 1084A-RIT24460

**DATE:** March 15, 2006

**RESULTS:** Horizontal Polarization

Freq. (MHz)	Spur Freq. (MHz)	Pspur (dBm)	Pgen (dBm)	Pref (dBm)	Spur Level (dBm)	Limit (dBm)
		<-100 dBm	0 dBm	-27.5 dBm	<-40 dBm	-20 dBm

No emissions were found within 20 dB of the specification limit.

**RESULTS:** Vertical Polarization

Freq. (MHz)	Spur Freq. (MHz)	Pspur (dBm)	Pgen (dBm)	Pref (dBm)	Spur Level (dBm)	Limit (dBm)
		<-100 dBm	0 dBm	-27.5 dBm	<-40 dBm	-20 dBm

No emissions were found within 20 dB of the specification limit.



**TYPE OF EXHIBIT:** FREQUENCY STABILITY VS TEMPERATURE

**FCC PART:** 2.1055(a)(1), 90.213

**IC PART:** RSS-119, Section 7

**MANUFACTURER:** RITRON, Inc.

**MODEL:** RPM-460

**TYPE OF UNIT:** UHF Mobile Transceiver

**FCC ID:** AIERIT24-460

**IC ID:** 1084A-RIT24460

**DATE:** March 15, 2006

**PROCEDURE:**

1. The RPM-460 was aligned for transmitter operation at 460.100 MHz at full rated power per the tune-up procedure outlined in the Maintenance manual.
2. The RPM-460 was placed in a Delta Design Model 3900 CL Temperature Chamber. The RF output of the RPM-460 was connected through a 30 dB power attenuator to an HP 8353A Frequency Counter to monitor the transmitter frequency. An Astron VS 12M Power Supply was adjusted for a nominal voltage of 13.7 VDC and connected to the DC power supply input of the RPM-460. A Triplet Model 320-G/P Thermocouple was used to monitor the temperature inside the chamber.
3. The chamber and the RPM-460 were heated to +50 degrees C and allowed to stabilize for 30 minutes for the first measurement and 30 minutes for each 10 degree decrement in temperature until the unit reached a temperature of -30 degrees C.
4. The RF frequency at each temperature was recorded and compared with the frequency at 25 degrees C, the tune-up temperature in the Maintenance manual.

**TYPE OF EXHIBIT:** FREQUENCY STABILITY VS TEMPERATURE

**FCC PART:** 2.1055(a)(1), 90.213

**IC PART:** RSS-119, Section 7

**MANUFACTURER:** RITRON, Inc.

**MODEL:** RPM-460

**TYPE OF UNIT:** UHF Mobile Transceiver

**FCC ID:** AIERIT24-460

**IC ID:** 1084A-RIT24460

**DATE:** March 15, 2006

**RESULTS:**

**Frequency Error vs Temperature**

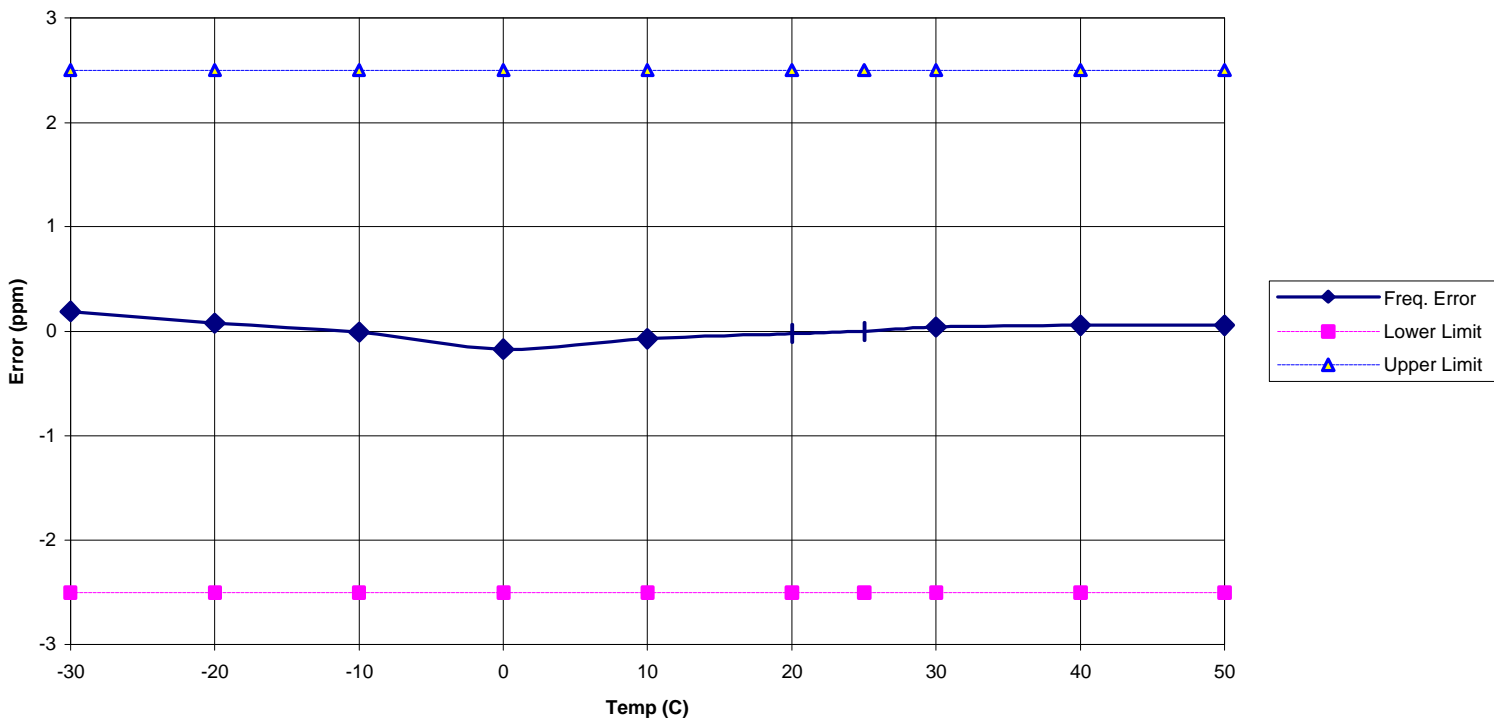

**TYPE OF EXHIBIT:** FREQUENCY STABILITY VS SUPPLY VOLTAGE  
**FCC PART:** 2.1055(d)(1)  
**IC PART:** RSS-119, Section 7  
**MANUFACTURER:** RITRON, Inc.  
**MODEL:** RPM-460  
**TYPE OF UNIT:** UHF Mobile Transceiver  
**FCC ID:** AIERIT24-460  
**IC ID:** 1084A-RIT24460  
**DATE:** March 15, 2006

**PROCEDURE:**

1. The RPM-460 was aligned for transmitter operation at 460.100 MHz at full rated power per the tune-up procedure outlined in the Maintenance manual.
2. The RF output of the RPM-460 was connected through a 30 dB power attenuator to an HP 8353A Frequency Counter to monitor the transmitter frequency. An Astron VS 12M Power Supply was adjusted for a nominal voltage of 13.7 VDC and connected to the DC power supply input of the RPM-460. The output frequency of the RPM-460 was noted and used as the reference for the results in paragraph 3 below.
3. The voltage out of the DC power supply was adjusted to between 85% and 115% of nominal (12.5 VDC) and the output frequency noted.

**TYPE OF EXHIBIT:** FREQUENCY STABILITY VS SUPPLY VOLTAGE  
**FCC PART:** 2.1055(d)(1)  
**IC PART:** RSS-119, Section 7  
**MANUFACTURER:** RITRON, Inc.  
**MODEL:** RPM-460  
**TYPE OF UNIT:** UHF Mobile Transceiver  
**FCC ID:** AIERIT24-460  
**IC ID:** 1084A-RIT24460  
**DATE:** March 15, 2006  
**RESULTS:**

**Frequency Error vs Supply Voltage**

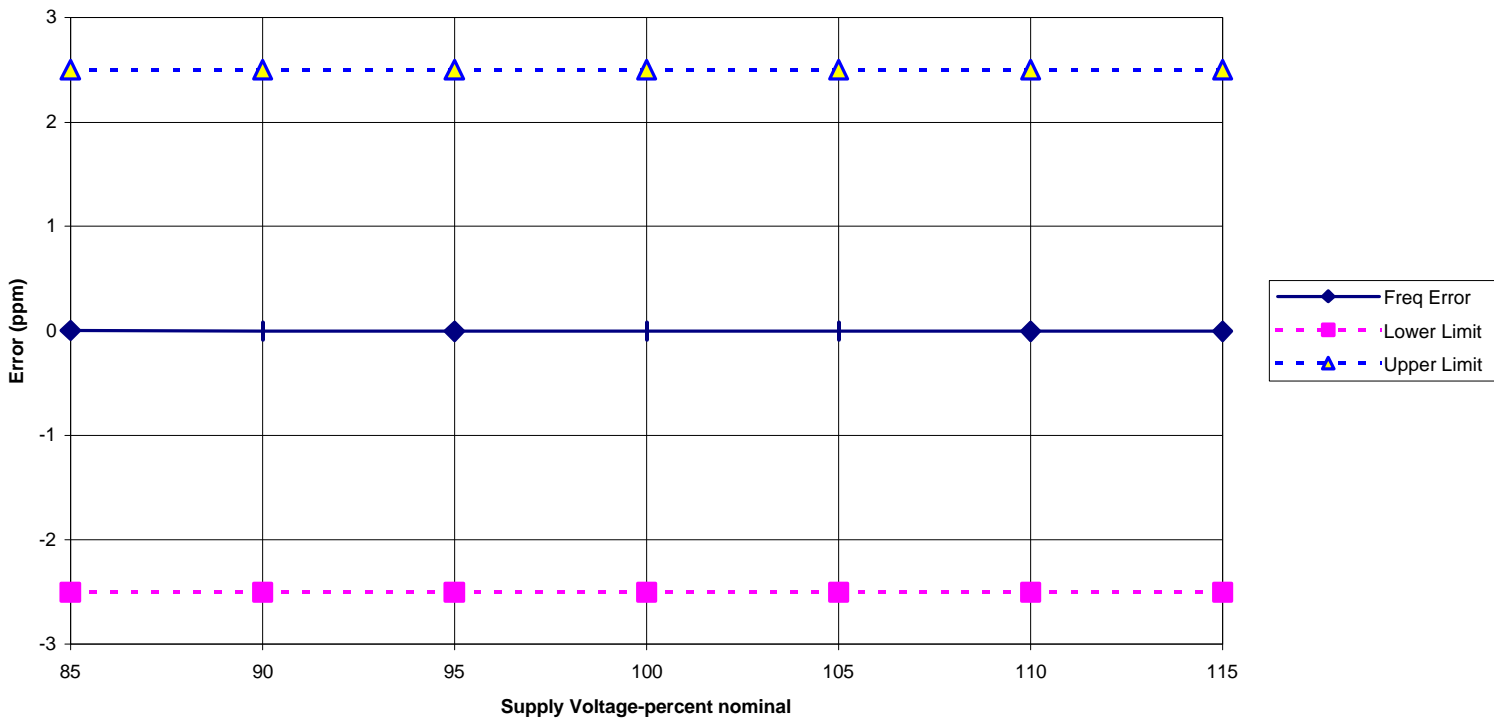

**TYPE OF TEST:** TRANSIENT FREQUENCY BEHAVIOR

**FCC PART:** 90.214

**IC PART:** RSS-119, Section 6.5

**MANUFACTURER:** RITRON, INC.

**MODEL:** RPM-460

**TYPE OF UNIT:** UHF Mobile Transceiver

**FCC ID:** AIERIT24-460

**IC ID:** 1084A-RIT24460

**DATE:** March 15, 2006

**PROCEDURE:**

1. The RPM-460 was aligned for transmitter operation on 460.100 MHz at full rated power per the tune-up procedure outlined in the Maintenance Manual. The following steps are per TIA./EIA-603.
2. The test equipment was connected per the following diagram:

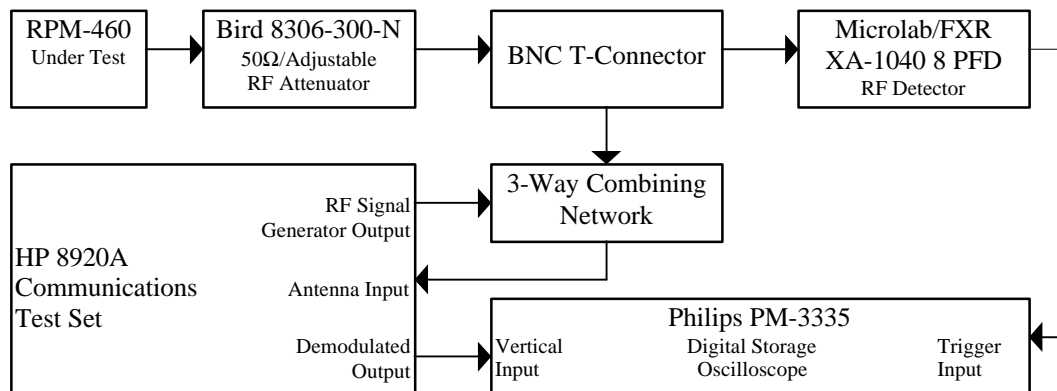

3. The HP 8920A Receiver was set to measure FM deviation with the audio bandwidth set at DC to greater than 15 kHz with the RF frequency set to 460.100 MHz. The attenuator was set for 40 dB.
4. The RPM-460 transmitter under test was activated and the HP 8920A Spectrum Analyzer was used to measure the RF power level through the test network.

**TYPE OF TEST:** TRANSIENT FREQUENCY BEHAVIOR  
**FCC PART:** 90.214  
**IC PART:** RSS-119, Section 6.5  
**MANUFACTURER:** RITRON, INC.  
**MODEL:** RPM-460  
**TYPE OF UNIT:** UHF Mobile Transceiver  
**FCC ID:** AIERIT24-460  
**IC ID:** 1084A-RIT24460  
**DATE:** March 15, 2006

**PROCEDURE** (continued):

5. The RPM-460 transmitter was turned off. The HP 8920A RF Signal Generator was set to 460.100 MHz at an RF level at the HP 8920A which was 30 dB below that measured in step 3 and modulated with a 1 kHz tone at +/-12.5 kHz deviation.
6. The Philips PM-3335 Digital Oscilloscope Horizontal Sweep Rate was set to 10 msec/div. The Vertical Amplitude Control was adjusted to display the 1000 Hz demodulated audio from the Signal Generator at +/-4 divisions, vertically centered on the screen.
7. The Philips PM-3335 Digital Oscilloscope was set to trigger at 1 division from the left side of the display when the RF Detector sensed RF power from the RPM-460 transmitter.
8. The RPM-460 transmitter was activated and the resulting waveform on the oscilloscope display was stored and plotted. The FCC limits per Part 90.214 were added to the plot. The resulting plot is labeled "Switch On Condition" and shows compliance with FCC Part 90.214/IC RSS-119, section 6.5.
9. The Philips PM-3335 Digital Oscilloscope was set to trigger at 1 division from the right side of the display when the RF Detector senses loss of RF power from the RPM-460 transmitter.

**TYPE OF TEST:** TRANSIENT FREQUENCY BEHAVIOR  
**FCC PART:** 90.214  
**IC PART:** RSS-119, Section 6.5  
**MANUFACTURER:** RITRON, INC.  
**MODEL:** RPM-460  
**TYPE OF UNIT:** UHF Mobile Transceiver  
**FCC ID:** AIERIT24-460  
**IC ID:** 1084A-RIT24460  
**DATE:** March 15, 2006

**PROCEDURE** (continued):

10. The RPM-460 transmitter was turned off and the resulting waveform on the oscilloscope display was stored and plotted. The limits per FCC Part 90.214/RSS-119, section 6.5 were added to the plot in the same manner illustrated in EIA-603 Part 3.2.19.2. The resulting plot is labeled "Switch Off Condition" and shows compliance.

11. Since this product supports both 12.5 kHz and 25 kHz channel operation, the more stringent 12.5 kHz limits are shown.

**TYPE OF TEST:** TRANSIENT FREQUENCY BEHAVIOR  
**FCC PART:** 90.214  
**IC PART:** RSS-119, Section 6.5  
**MANUFACTURER:** RITRON, INC.  
**MODEL:** RPM-460  
**TYPE OF UNIT:** UHF Mobile Transceiver  
**FCC ID:** AIERIT24-460  
**IC ID:** 1084A-RIT24460  
**DATE:** March 15, 2006  
**RESULTS:** Switch-On Condition

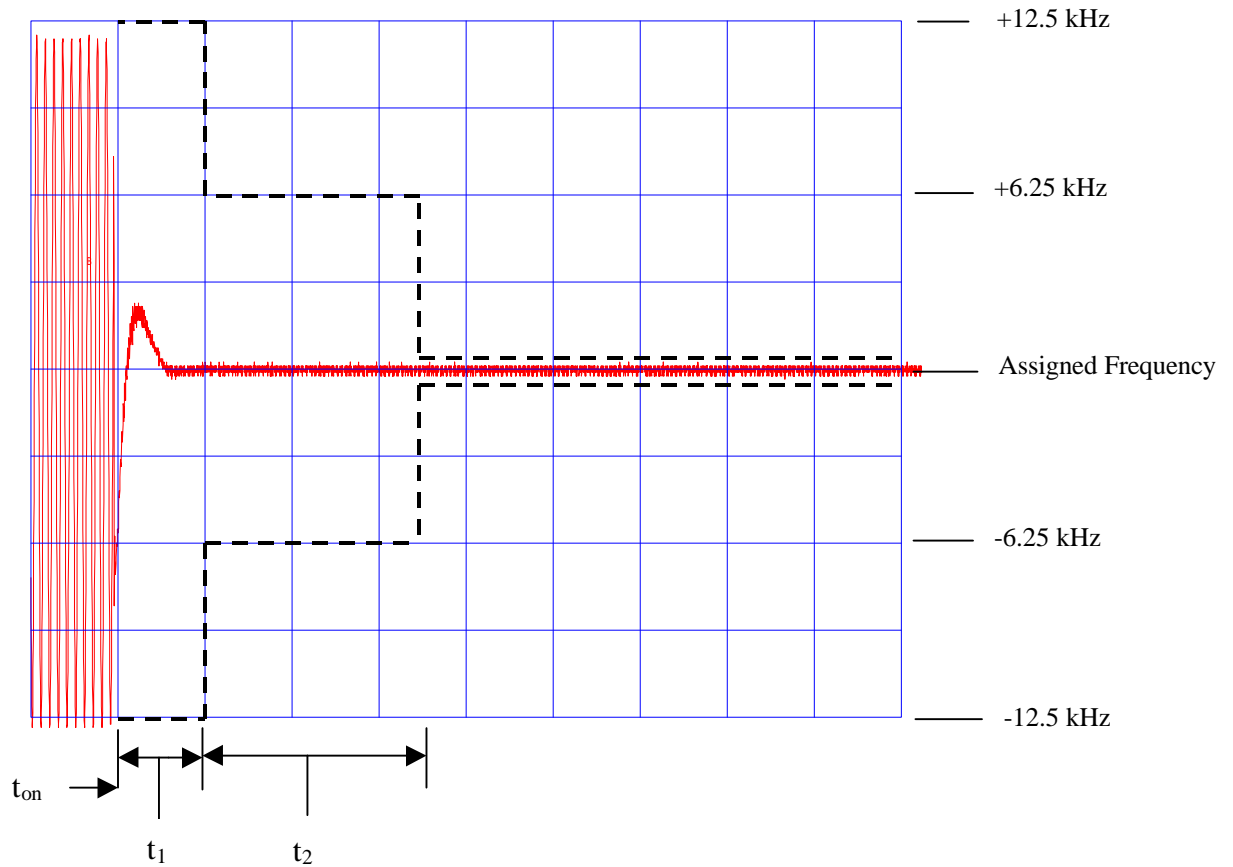



**TYPE OF TEST:** TRANSIENT FREQUENCY BEHAVIOR  
**FCC PART:** 90.214  
**IC PART:** RSS-119, Section 6.5  
**MANUFACTURER:** RITRON, INC.  
**MODEL:** RPM-460  
**TYPE OF UNIT:** UHF Mobile Transceiver  
**FCC ID:** AIERIT24-460  
**IC ID:** 1084A-RIT24460  
**DATE:** March 15, 2006  
**RESULTS:** Switch-Off Condition

