

NEC

Quick Start Guide

'11.12

NE-103S

NE-103T

Thank you for your purchasing of this product. Before using the this product, read this manual.

For more information about this product, please refer to the User's Manual which is shown on your PC.

<http://www.XXXXXXXXXXXXXXX>

Supplied Accessories

- This Product



- Quick Start Guide (this manual)

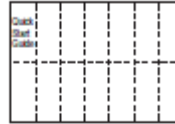

- AC Charger



- Battery Pack



- microSD* (sample)



* This has been attached when purchased.

- microUSB Cable (sample)



- microUSB to 3.5 mm Headset Cable (sample)





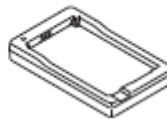

- Battery Cradle (sample)



Getting Started

Parts Names and Functions

- 1 Power switch
- 2 microUSB connector
- 3 Proximity/Illuminance sensor
- 4 Notification LED
- 5 Earpiece (receiver)
- 6 Display (Touch panel)
- 7 Mouthpiece/microphone
- 8  (menu) key
- 9  (home) key
- 10  (back) key
- 11  (search) key
- 12 Speaker
- 13 Camera
- 14 Light
- 15 +/- (volume) keys
- 16 Sub microphone
- 17 microSD card slot
- 18 Back cover
- 19 SIM slot
- 20 Strap slot

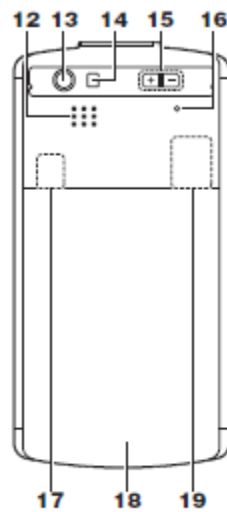
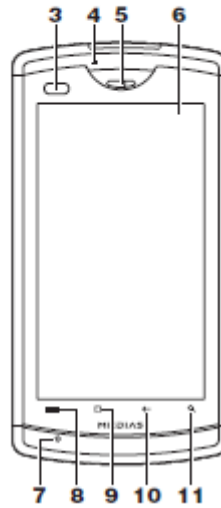
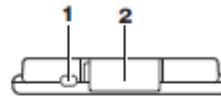

Removing/Attaching the Back Cover

To remove the back cover, hook your finger on the slot and remove in direction without too much force.

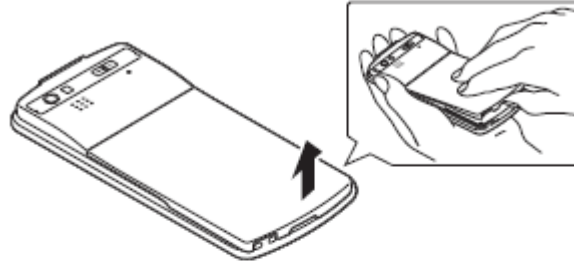

To attach the back cover, insert the tabs on top of the back cover into the slots, slide it in direction and push it down securely in direction.

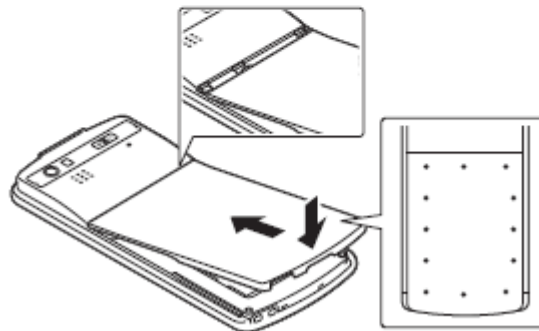

Securely push the areas illustrated by the dots and make sure that there is no space between the back cover and this product.

Inserting the SIM Card

SIM is an IC card that stores your phone number and other information. Some functions are not available if the SIM card is not inserted.

- 1 Hold the tab to slide the tray.**

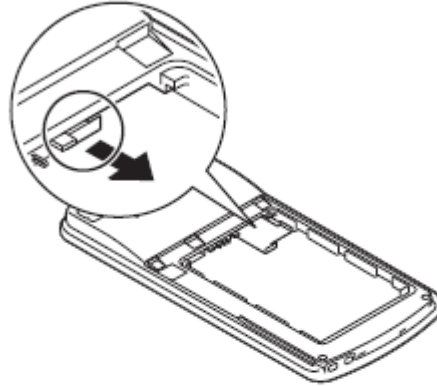

- 2 Place the SIM card on the tray, setting the IC surface on the upside.**

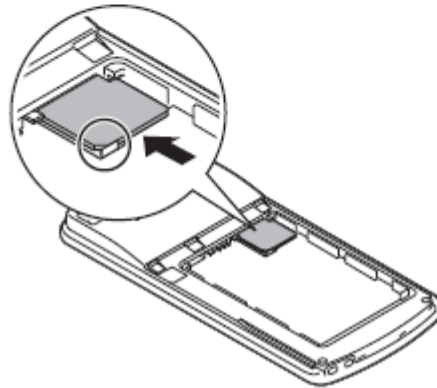

- 3 Slide the tray to the end.**

Inserting the microSD Card

Insert the microSD card into the microSD slot until it is locked.

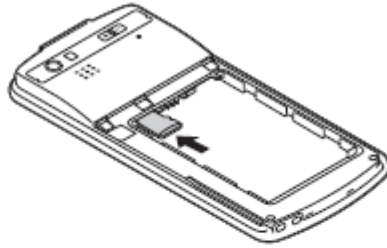

For removing the microSD card, push it.

Attaching the Battery

Insert in the direction by hooking the tabs on the battery pack in the slots.

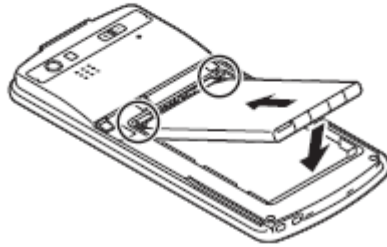

Charging with the AC Charger

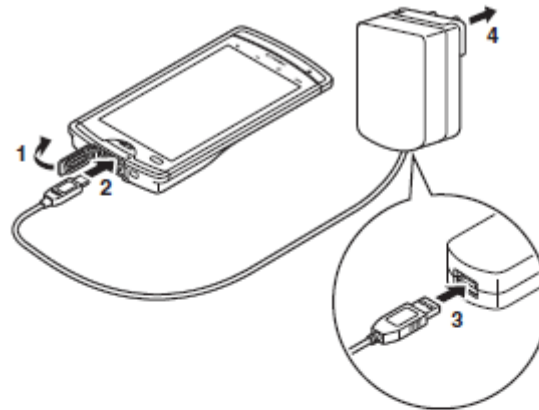

- 1 Open the microUSB connector cap.
- 2 Connect the microUSB plug of the supplied microUSB cable with engraved side facing down with the microUSB connector.
- 3 Connect the USB plug of the cable with the supplied AC charger.
- 4 Insert the AC charger plug into the power outlet.

Charging with the PC Connection

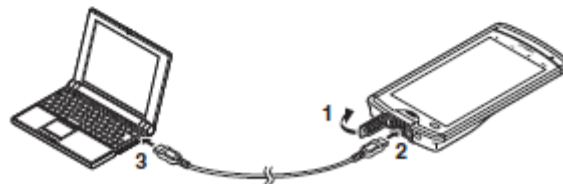

- 1 Open the microUSB connector cap.
- 2 Connect the microUSB plug of the supplied microUSB cable with engraved side facing down with the microUSB connector.
- 3 Connect the USB plug of the cable with your PC.

■ About the notification LED

Notification LED turns red while charging.

Notification LED turns green when the battery level is over 90%, and off when charging is complete.

When charging starts, such as when the battery is depleted, the notification LED may not immediately light. However, charging has started.

Using the battery cradle

You can also charge the battery pack using the battery cradle.

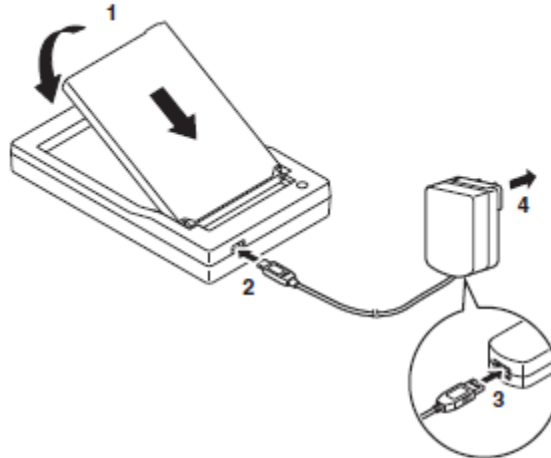

- 1** After removing the battery pack, set it into the battery cradle.
- 2** Connect the microUSB jack of the microUSB cable with the battery cradle.
- 3** Connect the USB jack of the microUSB cable with the AC charger.
- 4** Connect the AC charger plug with the power outlet.
Charging starts and the Charge LED lights on red.
When finishing the charging, the Charge LED lights on green.

Turning Power On and Off

Turning Power On

Press and hold the power switch for two seconds or longer.

Turning Power Off



- 1 Press and hold the power switch for one second or longer.
- 2 Touch "Power off".
- 3 Touch "OK".

■ Sleep mode

When the power switch is pressed, the display turns off and this product enters sleep mode.

Pressing the power switch quits sleep mode.

■ Screen lock

When you turn the power on or quit sleep mode, the touch panel is locked. Drag  to  to unlock the screen.





Initial Settings

When the power is first turned on, the initial setting screen appears.

- 1 Tap "Change language" if you need.**
- 2 Tap a language to set.**
- 3 Tap the Android icon.**
- 4 Tap "Skip" for undo the Wi-Fi setting.**
For setting Wi-Fi, tap "Connect to Wi-Fi", and select the Wi-Fi network. Then tap "Connect" to complete the Wi-Fi setting.
- 5 Check the displayed content, and tap "Next".**
- 6 Set each setting.**
- 7 Tap "Next".**
- 8 Tap "Home" or "Launcher" to complete initial settings.**

Basic Operation

Using the Keys

-  displays the menu available for the current screen.
-  displays the Home screen.
-  goes back to the previous screen.
-  opens "Google Search" when pressing on the Home screen.

Using the Touch Panel

■ Tap

With touching and releasing your finger, the item is selected or run.



■ Touch and hold

In some screens, continuing to touch the touch panel displays a menu.

■ Slide

With sliding your finger, the screen scrolls up/down/left/right in direction.

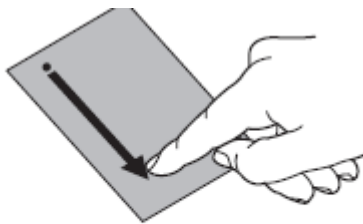

■ Drag

Quickly slide your finger while touching an item (icon, etc.) to move.

■ **Flick**

With quickly sliding and releasing your finger, the screen quickly scrolls in direction.

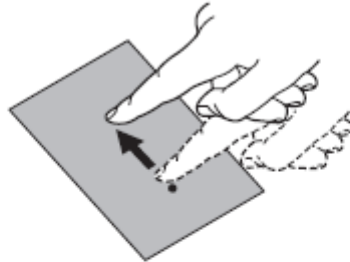

■ **Pinch with two fingers**

For zoom in or zoom out, touch the touch panel with two fingers, and then slide them apart or together.

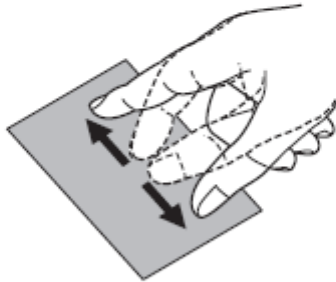

Text Entry

Tap a text box on the screen to display the on screen keyboard.

■ **QWERTY keyboard**

This keyboard uses a PC keyboard layout.



■ **10-key keyboard**

This is an ordinary keyboard of mobile phones.



Home Screen



- 1 Widgets
- 2 Application shortcuts
- 3 Dock
- 4 Launch "Phone", "Call log", and "Contacts".
- 5 Open the applications list screen
- 6 Launch browser

Reading the Status Bar

Notification icons for new information are displayed on the left, and status icons are displayed on the right side of the status bar.



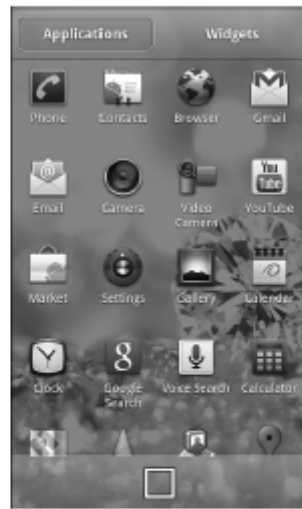

Applications List Screen

Tap  on the Home screen to display the applications list screen.



Calling

Making a Call

- 1 Tap  on the Home screen.
- 2 Enter the phone number.
- 3 Tap  to start the call.
- 4 To finish the call, tap .

■ Entering a push tone (pause)

Before step 3, tap  and then "Add 2-sec pause"/"Add wait".

■ Adjusting the call volume

Press the +/- (volume) keys.

■ Putting the other party on the speaker

Tap "Speaker".



■ Muting your voice to the other party

Tap "Mute".

■ Using the Bluetooth function

Tap "Bluetooth" when connected to a Bluetooth device compatible with your headset, etc.

Receiving a Call

- 1 When a call is received, drag  to  (to the right).
- 2 To finish the call, tap .

■ Declining a call

Drag  to  (to the left).

Call Log

You can check the outgoing/incoming calls history.

1 Tap  on the Home screen.

2 Tap "Call log".

: Outgoing call

: Incoming call

: Missed call

Contacts (Phonebook)

You can add data such as phone numbers, email addresses, and SNS (Twitter, Facebook, etc.) account information to "Contacts". You can easily make a call from "Contacts" or check SNS update information.

Communication charges may be incurred when you enter or obtain information from SNS.

1 Tap  on the Home screen.

2 Tap "Contacts".

■ Adding a new contact

Tap  and "New contact". After entering required items such as name, number, and email address, tap "Done" to complete adding.

■ Importing contacts from the SD card

Tap  and "Import/Export". Then tap "Import from SD card" and select the account.

Using the headset cable (hands-free phone)

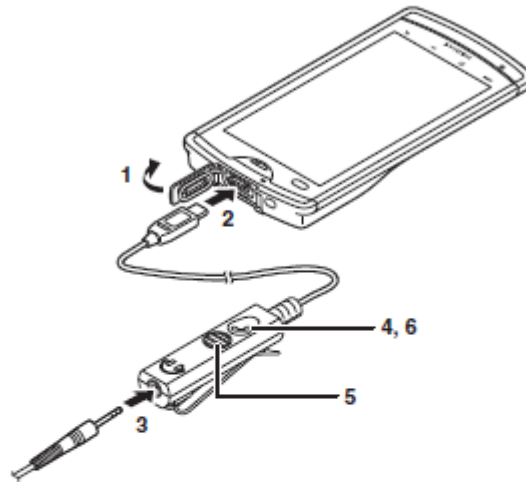

- 1** Open the microUSB connector cap.
- 2** Connect the microUSB plug of the supplied headset cable with engraved side facing down with the microUSB connector.
- 3** Connect your headphones' plug with the headset cable.
- 4** To answer an incoming call, press the button of the headset cable.
- 5** Talk using the microphone of the headset cable.
- 6** To finish the call, press the button of the headset cable.

E-Mail/Browser

E-Mail

By setting an email account, you can send and receive emails in the same way as your PC.

■ Displaying email

1 Tap "Email" on the application list screen.

The inbox screen appears. Any received email is displayed in the "Inbox".

For refreshing the "Inbox", tap  and then "Refresh".

2 Tap the email you want to read.

■ Replying to email

1 Tap "Reply"/"Reply all" and then enter a message.

2 Tap "Send".

■ Forwarding email

1 Tap  and then "Forward".

2 Enter the forwarding email address in "To".

3 Tap "Send".

■ Deleting email

Tap "Delete".

■ Creating and sending email

1 From the inbox screen, tap  and then "Compose".

2 Enter the partner email address in "To".

For adding a Cc or Bcc, tap  and then "Add Cc/Bcc".

3 Enter a title in "Subject".

4 Enter a message in "Compose Mail".

For adding an attachment, tap  and then "Add attachment".

5 Tap "Send".

SMS

You can send and receive text messages with a cell phone number as the address.

Tap "Messaging" on the application list screen.

The message screen appears.

■ Creating and sending SMS

Tap "New message". Enter the number in "To" and the message in "Type to Compose". Then tap "Send".

■ Displaying sent/received SMS

Tap a message thread.

■ Replying to SMS

Tap the address you want to reply to and enter the message. Then tap "Send".

■ Forwarding SMS



Tap a message thread and touch and hold the SMS you want to forward. Tap "Forward" and enter the forwarding phone number in "To". Then tap "Send".

■ Adding an SMS phone number to Contacts

Touch and hold a message thread and tap "Add to Contacts". Then tap "Create new contact" or tap a contact.

BROWSER

You can browse web pages using the browser. You can browse sites via packet communication and Wi-Fi also.

- 1 Tap  on the Home screen.
- 2 Tap the address bar.
- 3 Enter an URL or keywords.
Once you enter an URL or keywords in the address bar, a list of candidates appears.
- 4 Tap  or the web page you want to display from the list of candidates.

■ Using the voice search

Instead of step 3, tap  and clearly speak the search words into the microphone.

Turning WI-FI on to Connect to a Network

- 1 From the Home screen, press , and then "Settings".
- 2 Tap "Wireless & networks" and then "Wi-Fi settings".
- 3 Check the box of "Wi-Fi".
A scan for Wi-Fi networks starts automatically. A list of available networks appears.
- 4 Tap the name of the Wi-Fi network that you want to connect to.
To connect to a protected Wi-Fi network, enter the required information and tap "Connect".

Support

Troubleshooting

- First, check whether the software update is required. If required, update the software.
- If a symptom does not improve after its cause has been identified, contact "Repairs" at the last page of this manual or a repair counter specified.

■ Power supply

Power does not turn ON.	
• Is the battery back inserted correctly?	P.6
• Is the battery pack charged?	P.7

■ Charging

Cannot charge (Notification LED does not light or blinks).	
• Is the battery pack inserted correctly?	P.6
• Is the AC charger plug securely connected to the power outlet?	P.7
• If you are using the microUSB cable for PC connection, is the PC powered on?	–
• If you make a call, perform data communication, or use some other function for a long time while charging, this product may become hot and charging may be stopped. In this case, charge again after the product cools down.	–

■ Operation of the terminal

The this product becomes hot during operations or charging.	
• The product, battery pack, or AC charger may become hot during operations or charging, or if you use the camera function for a long time while charging. This is not a safety hazard, so you can continue to use them.	–
• If you use the camera function for a long time, the unit may become hot and the camera function may end. Wait a while before restarting to use the camera function.	–

Battery usage time is short.	
• Has the unit been out of the network service area for a long time? As this product searches for radio waves in order to enable communication when out of the network service area, more electricity is consumed than usual.	–
• The battery pack usage time varies depending on the usage conditions and the degradation level.	–
• The battery pack is a consumable. The available usage time shortens every time the battery pack is recharged. If the usage time significantly reduces compared to the time of purchase even if the battery pack is fully charged, purchase the specified battery pack.	–

Power turns off or automatic restart occurs.	
• If the battery pack terminal is dirty, the contact may become poor and the power may be turned off. If dirty, wipe the battery pack terminals with, for example, a dry cotton swab.	–

No operation occurs by tapping or pressing a key.	
• Is the power turned off?	P.9
• Is sleep mode set? Press the power switch to cancel sleep mode.	P.9
• Is the screen locked?	P.9
• Are you touching the touch panel correctly?	P.11

Tapping does not work properly.	
• Do you tap the screen with gloved hands?	–
• Do you tap with the tip of a fingernail, or is there any foreign matter between your hand and the screen?	–
• Is the display covered with a protective sheet? Some types of protective sheets prevent correct operation.	–

Screen response to tapping or key pressing is slow.	
• The screen response may slow down if large amounts of data are saved in this product or transferred between the product and the microSD card.	–

The SIM card is not recognized.	
• Is the SIM card inserted in the right direction?	P.5

The clock shows wrong time.	
• If power is kept on for a prolonged time, the clock may show the wrong time. Check that the "Date & time" are set to "Automatic", and turn the terminal off then back on in a location with good signal reception.	–

■ Telephone call

The ringtone does not sound.	
• Is the product in Silent mode?	–
• Is the ring time for the Voice mail service or Call forwarding service set to "0 sec."? Set "Set ring time" of "Voice mail service" on "Call settings" in "Settings".	–
• Is the ringtone volume set to its minimum? Set "Volume" of "Ring" on "Ringtones and sounds" from "Settings".	–
• If you cover the proximity sensor with your hand, the ringtone volume may be lower.	P.3

Cannot make a call with  shown	
• Are you out of the service area or in a place with poor signal strength? Check on the Status Bar.	P.14

Cannot make a call (does not disappear when you move, or calls cannot be made or received even when the radio wave is strong enough)	
• Turn the power off and then on, or remove and reinsert the battery pack or the SIM card.	P.4, 5, 9
• You may not be able to make or receive calls, depending on the type of radio signal, even when is shown. Move to another place and call again.	–
• Depending on how congested the radio waves are, it may be difficult to establish a connection in crowded places due to a congestion of calls and emails.	–

Error Message

SIM card is PUK-locked.	
• This message appears when you turn on the power while PIN1 code is locked. Tap "Emergency call" and enter " **05* [PUK code]* [new PIN1 code]* [new PIN1code]#".	–
• This message appears if you turn on the power or attempt to perform an operation related to the UIM card while the PIN unblocking key is locked. Contact a carrier Shop Service Counter.	–

Warranty and After-Sales Service

Warranty

- Be sure to receive a warranty at the time of purchase of the FOMA terminal. Read contents of the warranty, confirm information such as the "Shop name and date of purchase" and keep it in a safe place. If necessary items are not described, immediately contact the shop of purchase. The warranty for free repair is valid for one year from the date of purchase.
- This product and its accessories are subject to modified, in part or whole, for improvement without prior notice.
- Data saved in your contacts, etc. may be modified or lost due to the malfunction, repair or other handling of this product. You should therefore make a copy of your contacts data, etc. as a precautionary measure. If you have this product repaired, most of the previously downloaded data will not be transferred to the repaired terminal, as prohibited by the Copyright Act.
- * You can back up contacts data from this product to a microSD card.

After-sales service

■ For problems with your product

Before requesting repairs, read "Troubleshooting" in this instruction manual. If the problem still persists, contact "Repairs" (in Japanese only) at the last page of this manual.

■ For repairs after inquiry

Bring your product to a repair counter specified. Repairs are accepted during business hours of a repair counter. Also, you must bring the warranty.

Note that it may take some days to repair the terminal depending on the malfunction state.

During the warranty period

- This product is repaired at no charge under the conditions of the warranty.
- Make sure to bring the warranty for repair. You will be charged even during the warranty period if the warranty is not presented or the trouble or damage is caused by your inappropriate handling (such as damage to LCD or connector, etc.).
- You will be charged even during the warranty period if malfunction is caused by the use of devices and consumables other than those specified.

Repair may not be possible in the following cases:

- When a repair counter judges the cause of malfunction is exposure to water (Example: when wet-indication sticker reacts)
- When, as the result of inspection, corrosion is found due to exposure to water, condensation or sweat, or any of the internal boards are damaged or deformed (damage to the external connector terminal (earphone/microphone terminal) or LCD or cracked body could be the case as well)
- * Since these conditions are outside the scope of the warranty, any repairs, if at all possible, will be charged.

After expiration of the warranty

All repairs that are requested are charged.

Replacement parts

Replacement parts (parts required to maintain functions) will in principle be kept in stock for 6 years after termination of production. However, depending on the malfunctioning part, repair may not be possible due to a lack of replacement parts. Even after the stock period has expired, the repair of some malfunctioning parts may be possible. You should therefore contact "Repairs" (in Japanese only) at the last page of this manual.

Updating Software

Software Update is a function that connects to the network to check whether software on this product needs to be updated, downloads a portion of the software by packet communication as and when required, and updates the software. The NEC website provides information about required software updates.

■ **There are three ways to update software: auto update, immediate update, and booked update.**

- Auto update:
Automatically download software, and overwrite (update) it at a time set beforehand.
- Immediate update:
Update whenever you want to update.
- Booked update:
Book a time to install an update package, and the software is updated automatically at the booked time.

Making an emergency call

Emergency call	Phone number
Police emergency	110
Fire brigade/Ambulance emergency	119
Maritime distress call	118

- This product supports "Emergency Location Report". Calls made to emergency service organizations (e.g. by dialing 110, 119 or 118) disclose information on the caller's location to the organization receiving the call. The location information may not be correctly sent depending on the current location or signal quality. When the location information is disclosed, the organization name appears on the standby screen.
The location information and phone number are not disclosed when, before each individual call made, "184" or another blocking prefix is dialed first. If the information is deemed necessary for the protection of life, etc., this information may be acquired by the organization being called.
Locations/timing planned for adoption of this feature vary according to the status of the preparations by the relevant emergency service organizations.
- When calling 110, 119 or 118 from this product, first say you are calling from a mobile phone, give your number, and state your location clearly, because the police or fire department may call you back for confirmation. Also, do not move around when making the call. Do not turn off the power immediately after ending the call, but leave it turned on for ten minutes or so, so that you can receive a call.
- Depending on the area you are calling from, you may not be connected with the nearest police or fire department, etc.

<Note>

- If PIN lock is activated, you must first cancel it to make emergency calls in Airplane mode.
- While the Screen lock is set, you cannot use this product without releasing the Screen lock. However, you can only make an emergency call.
- In Japan, making an emergency call (110, 119 and 118) is not possible without a UIM.
- In Japan, making an emergency call (110, 119 and 118) is not possible from the PIN code input screen.

FCC Regulations

This mobile phone complies with part 15 of the FCC Rules. Operation is subject to the following two conditions: (1) This device may not cause harmful interference, and (2) this device must accept any interference received, including interference that may cause undesired operation.

This mobile phone has been tested and found to comply with the limits for a Class B digital device, pursuant to Part 15 of the FCC Rules. These limits are designed to provide reasonable protection against harmful interference in a residential installation.

This equipment generates, uses and can radiate radio frequency energy and, if not installed and used in accordance with the instructions, may cause harmful interference to radio communications.

However, there is no guarantee that interference will not occur in a particular installation; if this equipment does cause harmful interference to radio or television reception, which can be determined by turning the equipment off and on, the user is encouraged to try to correct the interference by one or more of the following measures:

- Reorient or relocate the receiving antenna.
- Increase the separation between the equipment and receiver.
- Connect the equipment into an outlet on a circuit different from that to which the receiver is connected.
- Consult the dealer or an experienced radio/TV technician for help.

Changes or modifications not expressly approved by the party responsible for compliance could void the user's authority to operate the equipment.

Radio Frequency (RF) Signals

THIS MODEL PHONE MEETS THE U.S. GOVERNMENT'S REQUIREMENTS FOR EXPOSURE TO RADIO WAVES.

Your wireless phone contains a radio transmitter and receiver. Your phone is designed and manufactured not to exceed the emission limits for exposure to radio frequency (RF) energy set by the Federal Communications Commission of the U.S. Government. These limits are part of comprehensive guidelines and establish permitted levels of RF energy for the general population. The guidelines are based on standards that were developed by independent scientific organizations through periodic and thorough evaluation of scientific studies.

The exposure standard for wireless mobile phones employs a unit of measurement known as the Specific Absorption Rate (SAR). The SAR limit set by the FCC is 1.6 W/kg.* Tests for SAR are conducted using standard operating positions accepted by the FCC with the phone transmitting at its highest certified power level in all tested frequency bands. Although the SAR is determined at the highest certified power level, the actual SAR level of the phone while operating can be well below the maximum value. This is because the phone is designed to operate at multiple power levels so as to use only the power required to reach the network. In general, the closer you are to a wireless base station antenna, the lower the output.

Before a phone model is available for sale to the public, it must be tested and certified to the FCC that it does not exceed the limit established by the U.S. government-adopted requirement for safe exposure. The tests are performed on position and locations (for example, at the ear and worn on the body) as required by FCC for each model. The highest SAR value for this model phone as reported to the FCC when tested for use at the ear is 0.679W/kg, and when worn on the body, is 1.39 W/kg. (Bodyworn measurements differ among phone models, depending upon available accessories and FCC requirements). While there may be differences between the SAR levels of various phones and at various positions, they all meet the U.S. government requirement.

Radio Frequency (RF) Signals

THIS MODEL PHONE MEETS THE U.S. GOVERNMENT'S REQUIREMENTS FOR EXPOSURE TO RADIO WAVES.

Your wireless phone contains a radio transmitter and receiver. Your phone is designed and manufactured not to exceed the emission limits for exposure to radio frequency (RF) energy set by the Federal Communications Commission of the U.S. Government. These limits are part of comprehensive guidelines and establish permitted levels of RF energy for the general population. The guidelines are based on standards that were developed by independent scientific organizations through periodic and thorough evaluation of scientific studies.

The exposure standard for wireless mobile phones employs a unit of measurement known as the Specific Absorption Rate (SAR). The SAR limit set by the FCC is 1.6 W/kg.* Tests for SAR are conducted using standard operating positions accepted by the FCC with the phone transmitting at its highest certified power level in all tested frequency bands. Although the SAR is determined at the highest certified power level, the actual SAR level of the phone while operating can be well below the maximum value. This is because the phone is designed to operate at multiple power levels so as to use only the power required to reach the network. In general, the closer you are to a wireless base station antenna, the lower the output. Before a phone model is available for sale to the public, it must be tested and certified to the FCC that it does not exceed the limit established by the U.S. government-adopted requirement for safe exposure. The tests are performed on position and locations (for example, at the ear and worn on the body) as required by FCC for each model. The highest SAR value for this model phone as reported to the FCC when tested for use at the ear is 0.679W/kg, and when worn on the body, is 1.39 W/kg. (Bodyworn measurements differ among phone models, depending upon available accessories and FCC requirements). While there may be differences between the SAR levels of various phones and at various positions, they all meet the U.S. government requirement.

For body worn operation, this phone has been tested and meets the FCC RF exposure guidelines when used with an accessory designated for this product or when used with an accessory that contains no metal and that positions the handset a minimum of 1.0 cm from the body. Non-compliance with the above restrictions may result in violation of FCC RF Exposure guidelines.

* In the United States, the SAR limit for wireless mobile phones used by the public is 1.6 watts/kg (W/kg) averaged over one gram of tissue. SAR values may vary depending upon national reporting requirements and the network band.

Declaration of Conformity

Hereby, NEC CASIO mobile communications, Ltd. declares that this product is compliance with the essential requirements and other relevant provisions of Directive 1999/5/EC. Declaration of Conformity can be found on <http://www.n-keitai.com/lineup/index.html> (Japanese only).

CE 2200

This product uses non-harmonised frequency and is intended for use in all European countries. The WLAN can be operated in the EU without restriction indoors, but cannot be operated outdoors in France.

This mobile phone complies with the EU requirements for exposure to radio waves. Your mobile phone is a radio transceiver, designed and manufactured not to exceed the SAR* limits** for exposure to radio-frequency (RF) energy, which SAR* value, when tested for compliance against the standard was 0.957W/kg. While there may be differences between the SAR* levels of various phones and at various positions, they all meet*** the EU requirements for RF exposure.

* The exposure standard for mobile phones employs a unit of measurement known as the Specific Absorption Rate, or SAR.

** The SAR limit for mobile phones used by the public is 2.0 watts/kilogram (W/kg) averaged over ten grams of tissue, recommended by The Council of the European Union. The limit incorporates a substantial margin of safety to give additional protection for the public and to account for any variations in measurements.

*** Tests for SAR have been conducted using standard operating positions with the phone transmitting at its highest certified power level in all tested frequency bands. Although the SAR is determined at the highest certified power level, the actual SAR level of the phone while operating can be well below the maximum value. This is because the phone is designed to operate at multiple power levels so as to use only the power required to reach the network. In general, the closer you are to a base station antenna, the lower the power output.

Prevention of Hearing Loss

Warning statement requirement under EN 60950-1:A12.



To prevent possible hearing damage, do not listen at high volume levels for long periods.

Note: For France, headphones/earphones for this device are compliant with

the sound pressure level requirement laid down in the applicable EN 50332-1: 2000 and/or EN50332-2: 2003 standard as required by French Article L.5232-1.



A pleine puissance, l'écoute prolongée du baladeur peut endommager l'audition de l'utilisateur.

Products with 2.4–GHz Wireless LAN Devices

France

L'utilisation de cet équipement (2.4GHz wireless LAN) est soumise à certaines restrictions: cet équipement peut être utilisé à l'intérieur d'un bâtiment en utilisant toutes les fréquences de 2400 à 2483.5MHz (Chaîne 1–13). Pour une utilisation en environnement extérieur, les fréquences comprises entre 2400-2454 MHz peuvent être utilisées. Pour les dernières restrictions, voir <http://www.art-telecom.fr>.

For 2.4–GHz wireless LAN operation of this product, certain restrictions apply. This equipment may use the entire–2400–MHz to 2483.5–MHz frequency band (channels 1 through 13) for indoor applications. For outdoor use, only 2400-2454 MHz frequency band may be used. For the latest requirements, see <http://www.art-telecom.fr>.

This equipment may be operated in:							
AT	BE	BG	CH	CY	CZ	DE	DK
EE	ES	FI	FR	GB	GR	HU	IE
IT	IS	LI	LT	LU	LV	MT	NL
NO	PL	PT	RO	SE	SI	SK	TR