



FCC TEST REPORT

(15.247)

REPORT NO.: RF140626C27

MODEL NO.: EPG5000

FCC ID: A8JEPG5000

RECEIVED: Jun. 26, 2014

TESTED: Jul. 04 ~ Jul. 30, 2014

ISSUED: Aug. 08, 2014

APPLICANT: EnGenius Technologies

ADDRESS: 1580 Scenic Avenue, Costa Mesa, CA92626

ISSUED BY: Bureau Veritas Consumer Products Services
(H.K.) Ltd., Taoyuan Branch

LAB ADDRESS: No. 47-2, 14th Ling, Chia Pau Vil., Lin Kou Dist.,
New Taipei City, Taiwan, R.O.C.

TEST LOCATION: No. 19, Hwa Ya 2nd Rd, Wen Hwa Tsuen, Kwei
Shan Hsiang, Taoyuan Hsien 333, Taiwan, R.O.C.

This report should not be used by the client to claim product certification, approval, or endorsement by TAF or any government agencies.



This report is for your exclusive use. Any copying or replication of this report to or for any other person or entity, or use of our name or trademark, is permitted only with our prior written permission. This report sets forth our findings solely with respect to the test samples identified herein. The results set forth in this report are not indicative or representative of the quality or characteristics of the lot from which a test sample was taken or any similar or identical product unless specifically and expressly noted. Our report includes all of the tests requested by you and the results thereof based upon the information that you provided to us. You have 60 days from date of issuance of this report to notify us of any material error or omission caused by our negligence, provided, however, that such notice shall be in writing and shall specifically address the issue you wish to raise. A failure to raise such issue within the prescribed time shall constitute your unqualified acceptance of the completeness of this report, the tests conducted and the correctness of the report contents. Unless specific mention, the uncertainty of measurement has been explicitly taken into account to declare the compliance or non-compliance to the specification.



TABLE OF CONTENTS

RELEASE CONTROL RECORD	4
1. CERTIFICATION.....	5
2. SUMMARY OF TEST RESULTS	6
2.1 MEASUREMENT UNCERTAINTY	6
3. GENERAL INFORMATION.....	7
3.1 GENERAL DESCRIPTION OF EUT.....	7
3.2 DESCRIPTION OF TEST MODES.....	9
3.2.1 TEST MODE APPLICABILITY AND TESTED CHANNEL DETAIL.....	10
3.3 DUTY CYCLE OF TEST SIGNAL.....	12
3.4 DESCRIPTION OF SUPPORT UNITS	13
3.4.1 CONFIGURATION OF SYSTEM UNDER TEST	13
3.5 GENERAL DESCRIPTION OF APPLIED STANDARDS.....	14
4. TEST TYPES AND RESULTS	15
4.1 RADIATED EMISSION AND BANDEDGE MEASUREMENT	15
4.1.1 LIMITS OF RADIATED EMISSION AND BANDEDGE MEASUREMENT.....	15
4.1.2 TEST INSTRUMENTS.....	16
4.1.3 TEST PROCEDURES	17
4.1.4 DEVIATION FROM TEST STANDARD	17
4.1.5 TEST SETUP.....	18
4.1.6 EUT OPERATING CONDITIONS	19
4.1.7 TEST RESULTS	20
4.2 CONDUCTED EMISSION MEASUREMENT	33
4.2.1 LIMITS OF CONDUCTED EMISSION MEASUREMENT	33
4.2.2 TEST INSTRUMENTS.....	33
4.2.3 TEST PROCEDURES	34
4.2.4 DEVIATION FROM TEST STANDARD	34
4.2.5 TEST SETUP.....	34
4.2.6 EUT OPERATING CONDITIONS	34
4.2.7 TEST RESULTS	35
4.3 6dB BANDWIDTH MEASUREMENT	37
4.3.1 LIMITS OF 6dB BANDWIDTH MEASUREMENT.....	37
4.3.2 TEST SETUP.....	37
4.3.3 TEST INSTRUMENTS.....	37
4.3.4 TEST PROCEDURE.....	37
4.3.5 DEVIATION FROM TEST STANDARD	37
4.3.6 EUT OPERATING CONDITIONS	37
4.3.7 TEST RESULTS	38
4.4 CONDUCTED OUTPUT POWER	40
4.4.1 LIMITS OF CONDUCTED OUTPUT POWER MEASUREMENT	40
4.4.2 TEST SETUP.....	40
4.4.3 TEST INSTRUMENTS.....	40
4.4.4 TEST PROCEDURES	40



A D T

4.4.5	DEVIATION FROM TEST STANDARD	41
4.4.6	EUT OPERATING CONDITIONS	41
4.4.7	TEST RESULTS	42
4.5	POWER SPECTRAL DENSITY MEASUREMENT.....	43
4.5.1	LIMITS OF POWER SPECTRAL DENSITY MEASUREMENT.....	43
4.5.2	TEST SETUP.....	43
4.5.3	TEST INSTRUMENTS.....	43
4.5.4	TEST PROCEDURE.....	43
4.5.5	DEVIATION FROM TEST STANDARD	43
4.5.6	EUT OPERATING CONDITION	43
4.5.7	TEST RESULTS	44
4.6	CONDUCTED OUT OF BAND EMISSION MEASUREMENT	47
4.6.1	LIMITS OF CONDUCTED OUT OF BAND EMISSION MEASUREMENT.....	47
4.6.2	TEST SETUP.....	47
4.6.3	TEST INSTRUMENTS.....	47
4.6.4	TEST PROCEDURE.....	48
4.6.5	DEVIATION FROM TEST STANDARD	48
4.6.6	EUT OPERATING CONDITION	48
4.6.7	TEST RESULTS	49
5.	PHOTOGRAPHS OF THE TEST CONFIGURATION	62
6.	INFORMATION ON THE TESTING LABORATORIES.....	63
7.	APPENDIX A - MODIFICATIONS RECORDERS FOR ENGINEERING CHANGES TO THE EUT BY THE LAB.....	64



RELEASE CONTROL RECORD

ISSUE NO.	REASON FOR CHANGE	DATE ISSUED
RF140626C27	Original release	Aug. 08, 2014

1. CERTIFICATION

PRODUCT: IoT Gateway
MODEL NO.: EPG5000
BRAND: EnGenius
APPLICANT: EnGenius Technologies
TESTED: Jul. 04 ~ Jul. 30, 2014
TEST SAMPLE: ENGINEERING SAMPLE
STANDARDS: **FCC Part 15, Subpart C (Section 15.247)**
ANSI C63.10-2009

The above equipment (model: EPG5000) has been tested by **Bureau Veritas Consumer Products Services (H.K.) Ltd., Taoyuan Branch**, and found compliance with the requirement of the above standards. The test record, data evaluation & Equipment Under Test (EUT) configurations represented herein are true and accurate accounts of the measurements of the sample's EMC characteristics under the conditions specified in this report.

PREPARED BY : Ivy Lin , **DATE** : Aug. 08, 2014

Ivy Lin / Specialist

APPROVED BY : Ken Liu , **DATE** : Aug. 08, 2014

Ken Liu / Senior Manager

2. SUMMARY OF TEST RESULTS

The EUT has been tested according to the following specifications:

APPLIED STANDARD: FCC PART 15, SUBPART C (SECTION 15.247)			
STANDARD SECTION	TEST TYPE	RESULT	REMARK
15.207	AC Power Conducted Emission	PASS	Meet the requirement of limit. Minimum passing margin is -10.38dB at 10.99219MHz.
15.205 & 209	Radiated Emissions	PASS	Meet the requirement of limit. Minimum passing margin is -1.0dB at 2390.00MHz & 2483.50MHz
15.247(d)	Band Edge Measurement	PASS	Meet the requirement of limit. Minimum passing margin is -1.0dB at 2483.50MHz
15.247(d)	Antenna Port Emission	PASS	Meet the requirement of limit.
15.247(a)(2)	6dB bandwidth	PASS	Meet the requirement of limit.
15.247(b)	Conducted power	PASS	Meet the requirement of limit.
15.247(e)	Power Spectral Density	PASS	Meet the requirement of limit.
15.203	Antenna Requirement	PASS	No antenna connector is used.

2.1 MEASUREMENT UNCERTAINTY

Where relevant, the following measurement uncertainty levels have been estimated for tests performed on the EUT as specified in CISPR 16-4-2:

MEASUREMENT	FREQUENCY	UNCERTAINTY
Conducted emissions	150kHz~30MHz	2.44 dB
Radiated emissions	30MHz ~ 200MHz	3.34 dB
	200MHz ~1000MHz	3.35 dB
	1GHz ~ 18GHz	2.26 dB
	18GHz ~ 40GHz	1.94 dB

This uncertainty represents an expanded uncertainty expressed at approximately the 95% confidence level using a coverage factor of $k = 2$.



3. GENERAL INFORMATION

3.1 GENERAL DESCRIPTION OF EUT

EUT	IoT Gateway
MODEL NO.	EPG5000
POWER SUPPLY	12Vdc (adapter)
MODULATION TYPE	CCK, DQPSK, DBPSK for DSSS 64QAM, 16QAM, QPSK, BPSK for OFDM
MODULATION TECHNOLOGY	DSSS, OFDM
TRANSFER RATE	802.11b:11.0/ 5.5/ 2.0/ 1.0Mbps 802.11g: 54.0/ 48.0/ 36.0/ 24.0/ 18.0/ 12.0/ 9.0/ 6.0Mbps 802.11n: up to 450.0Mbps
OPERATING FREQUENCY	2412 ~ 2462MHz
NUMBER OF CHANNEL	11 for 802.11b, 802.11g, 802.11n (20MHz) 7 for 802.11n (40MHz)
OUTPUT POWER	833.888 mW
ANTENNA TYPE	Refer to note
ANTENNA CONNECTOR	Refer to note
DATA CABLE	N/A
I/O PORTS	Refer to user's manual
ACCESSORY DEVICES	Adapter

NOTE:

1. The EUT incorporates a MIMO function. Physically, the EUT provides three completed transmitters and three receivers.

MODULATION MODE	TX FUNCTION
802.11b	3TX
802.11g	3TX
802.11n (20MHz)	3TX
802.11n (40MHz)	3TX

2. The EUT consumes power from the following adapter.

Brand	Powertron Electronics Corp.
Model	PA1024-2HUB PA1024-120HUB200
Input Power	100-240Vac, 50-60Hz, 0.6A
Output Power	12Vdc, 2.0A, 24W Max
Power Line	DC: 1.5m non-shielded cable with 1 core



A D T

3. The following antennas are provided to the EUT.

Type	Connector	Gain(dBi)		
		2400 ~ 2483.5MHz	5150 ~ 5250MHz	5725 ~ 5850MHz
PIFA	NA	4	5	5

4. The above EUT information is declared by manufacturer and for more detailed feature description, please refer to the manufacturer's specifications or user's manual.

3.2 DESCRIPTION OF TEST MODES

11 channels are provided for 802.11b, 802.11g and 802.11n (20MHz):

CHANNEL	FREQUENCY	CHANNEL	FREQUENCY
1	2412MHz	7	2442MHz
2	2417MHz	8	2447MHz
3	2422MHz	9	2452MHz
4	2427MHz	10	2457MHz
5	2432MHz	11	2462MHz
6	2437MHz		

7 channels are provided for 802.11n (40MHz):

CHANNEL	FREQUENCY	CHANNEL	FREQUENCY
3	2422MHz	7	2442MHz
4	2427MHz	8	2447MHz
5	2432MHz	9	2452MHz
6	2437MHz		

3.2.1 TEST MODE APPLICABILITY AND TESTED CHANNEL DETAIL

EUT CONFIGURE MODE	APPLICABLE TO				DESCRIPTION
	RE≥1G	RE<1G	PLC	APCM	
-	√	√	√	√	-

Where **RE≥1G**: Radiated Emission above 1GHz **RE<1G**: Radiated Emission below 1GHz
PLC: Power Line Conducted Emission **APCM**: Antenna Port Conducted Measurement

NOTE:
The EUT had been pre-tested on the positioned of each 3 axis. The worst case was found when positioned on **Y-plane**.

RADIATED EMISSION TEST (ABOVE 1GHz):

- Pre-Scan has been conducted to determine the worst-case mode from all possible combinations between available modulations, data rates and antenna ports (if EUT with antenna diversity architecture).
- Following channel(s) was (were) selected for the final test as listed below.

EUT CONFIGURE MODE	MODE	AVAILABLE CHANNEL	TESTED CHANNEL	MODULATION TECHNOLOGY	MODULATION TYPE	DATA RATE (Mbps)
-	802.11b	1 to 11	1, 6, 11	DSSS	DBPSK	1.0
-	802.11g	1 to 11	1, 6, 11	OFDM	BPSK	6.0
-	802.11n (20MHz)	1 to 11	1, 6, 11	OFDM	BPSK	7.2
-	802.11n (40MHz)	3 to 9	3, 6, 9	OFDM	BPSK	15.0

RADIATED EMISSION TEST (BELOW 1GHz):

- Pre-Scan has been conducted to determine the worst-case mode from all possible combinations between available modulations, data rates and antenna ports (if EUT with antenna diversity architecture).
- Following channel(s) was (were) selected for the final test as listed below.

EUT CONFIGURE MODE	MODE	AVAILABLE CHANNEL	TESTED CHANNEL	MODULATION TECHNOLOGY	MODULATION TYPE	DATA RATE (Mbps)
-	802.11g	1 to 11	6	OFDM	BPSK	6.0

POWER LINE CONDUCTED EMISSION TEST:

- Pre-Scan has been conducted to determine the worst-case mode from all possible combinations between available modulations, data rates and antenna ports (if EUT with antenna diversity architecture).
- Following channel(s) was (were) selected for the final test as listed below.

EUT CONFIGURE MODE	MODE	AVAILABLE CHANNEL	TESTED CHANNEL	MODULATION TECHNOLOGY	MODULATION TYPE	DATA RATE (Mbps)
-	802.11g	1 to 11	6	OFDM	BPSK	6.0



BANDEDGE MEASUREMENT:

- Pre-Scan has been conducted to determine the worst-case mode from all possible combinations between available modulations, data rates and antenna ports (if EUT with antenna diversity architecture).
- Following channel(s) was (were) selected for the final test as listed below.

EUT CONFIGURE MODE	MODE	AVAILABLE CHANNEL	TESTED CHANNEL	MODULATION TECHNOLOGY	MODULATION TYPE	DATA RATE (Mbps)
-	802.11b	1 to 11	1, 11	DSSS	DBPSK	1.0
-	802.11g	1 to 11	1, 11	OFDM	BPSK	6.0
-	802.11n (20MHz)	1 to 11	1, 11	OFDM	BPSK	7.2
-	802.11n (40MHz)	3 to 9	3, 9	OFDM	BPSK	15.0

ANTENNA PORT CONDUCTED MEASUREMENT:

- This item includes all test value of each mode, but only includes spectrum plot of worst value of each mode.
- Pre-Scan has been conducted to determine the worst-case mode from all possible combinations between available modulations, data rates and antenna ports (if EUT with antenna diversity architecture).
- Following channel(s) was (were) selected for the final test as listed below.

EUT CONFIGURE MODE	MODE	AVAILABLE CHANNEL	TESTED CHANNEL	MODULATION TECHNOLOGY	MODULATION TYPE	DATA RATE (Mbps)
-	802.11b	1 to 11	1, 6, 11	DSSS	DBPSK	1.0
-	802.11g	1 to 11	1, 6, 11	OFDM	BPSK	6.0
-	802.11n (20MHz)	1 to 11	1, 6, 11	OFDM	BPSK	7.2
-	802.11n (40MHz)	3 to 9	3, 6, 9	OFDM	BPSK	15.0

TEST CONDITION:

APPLICABLE TO	ENVIRONMENTAL CONDITIONS	INPUT POWER	TESTED BY
RE≥1G	23deg. C, 65%RH	120Vac, 60Hz	Jones Chang
RE<1G	19deg. C, 69%RH	120Vac, 60Hz	Chris Lin
PLC	25deg. C, 70%RH	120Vac, 60Hz	Jones Chang
APCM	25deg. C, 65%RH	120Vac, 60Hz	Nick Chen

3.3 DUTY CYCLE OF TEST SIGNAL

802.11b: Duty cycle of test signal is 100 %, duty factor is not required.

Duty cycle is < 98%, duty factor shall be considered.

802.11g: Duty cycle = $2.021/2.089 = 0.967$, Duty factor = $10 * \log(1/0.967) = 0.15$

802.11n (20MHz): Duty cycle = $1.888/1.939 = 0.974$, Duty factor = $10 * \log(1/0.974) = 0.11$

802.11n (40MHz): Duty cycle = $924.0/970.0 = 0.953$, Duty factor = $10 * \log(1/0.953) = 0.21$

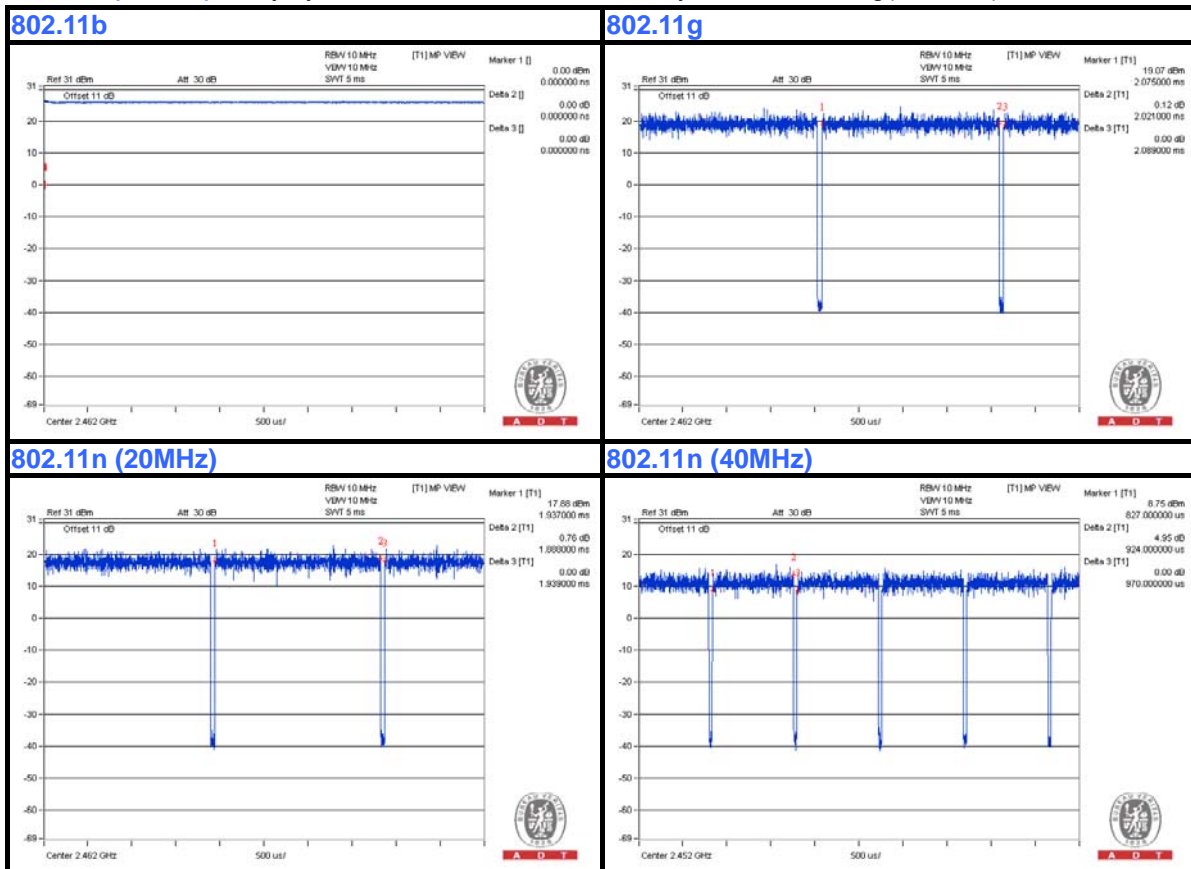

3.4 DESCRIPTION OF SUPPORT UNITS

The EUT has been tested as an independent unit together with other necessary accessories or support units. The following support units or accessories were used to form a representative test configuration during the tests.

NO.	PRODUCT	BRAND	MODEL NO.	SERIAL NO.	FCC ID
1	Notebook	DELL	E5410	1HC2XM1	FCC Doc Approved

NO.	SIGNAL CABLE DESCRIPTION OF THE ABOVE SUPPORT UNITS
1	3m LAN cable

NOTE:

1. All power cords of the above support units are non-shielded (1.8m).
2. Item 1 acted as a communication partner to transfer data.

3.4.1 CONFIGURATION OF SYSTEM UNDER TEST

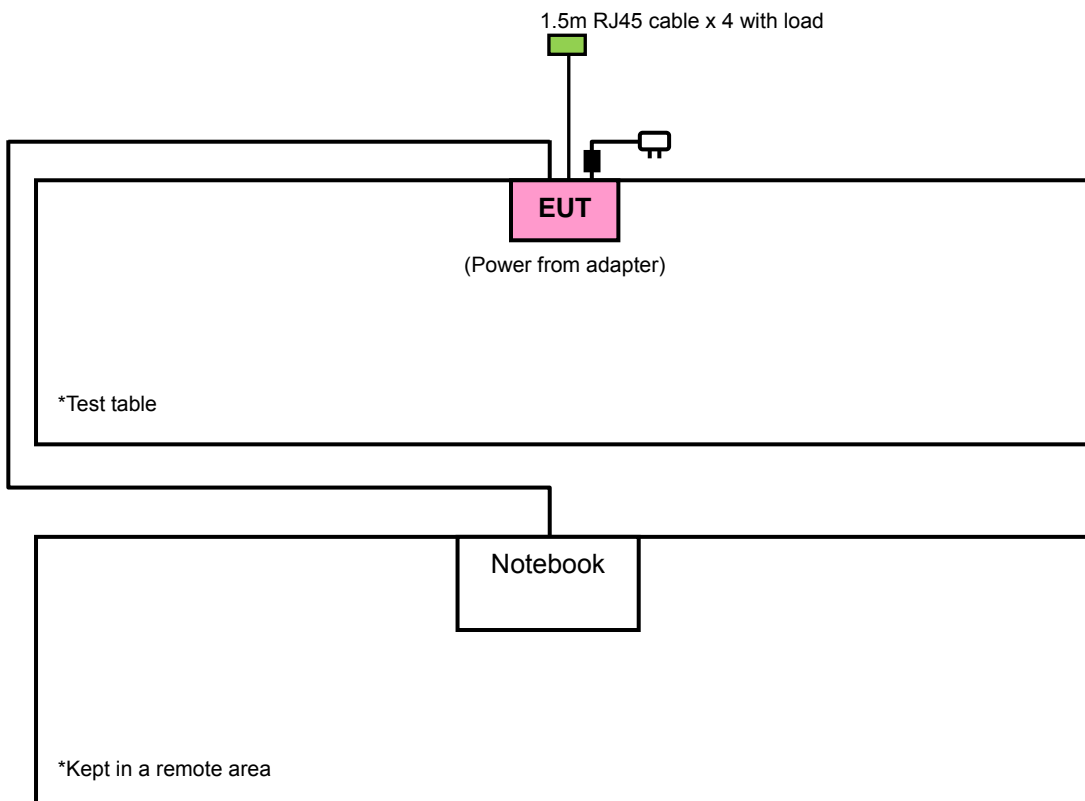

3.5 GENERAL DESCRIPTION OF APPLIED STANDARDS

The EUT is a RF Product. According to the specifications of the manufacturer, it must comply with the requirements of the following standards:

FCC Part 15, Subpart C (15.247)

558074 D01 DTS Meas Guidance v03r02

662911 D01 Multiple Transmitter Output v02r01

ANSI C63.10-2009

All test items have been performed and recorded as per the above standards.

NOTE: The EUT is also considered as a kind of computer peripheral, because the connection to computer is necessary for typical use. It has been verified to comply with the requirements of FCC Part 15, Subpart B, Class B (DoC). The test report has been issued separately.

4. TEST TYPES AND RESULTS

4.1 RADIATED EMISSION AND BANDEDGE MEASUREMENT

4.1.1 LIMITS OF RADIATED EMISSION AND BANDEDGE MEASUREMENT

Radiated emissions which fall in the restricted bands must comply with the radiated emission limits specified as below table. Other emissions shall be at least 30dB below the highest level of the desired power:

FREQUENCIES (MHz)	FIELD STRENGTH (microvolts/meter)	MEASUREMENT DISTANCE (meters)
0.009 ~ 0.490	2400/F(kHz)	300
0.490 ~ 1.705	24000/F(kHz)	30
1.705 ~ 30.0	30	30
30 ~ 88	100	3
88 ~ 216	150	3
216 ~ 960	200	3
Above 960	500	3

NOTE:

1. The lower limit shall apply at the transition frequencies.
2. Emission level (dBuV/m) = 20 log Emission level (uV/m).
3. For frequencies above 1000MHz, the field strength limits are based on average detector, however, the peak field strength of any emission shall not exceed the maximum permitted average limits, specified above by more than 30dB under any condition of modulation.

4.1.2 TEST INSTRUMENTS

DESCRIPTION & MANUFACTURER	MODEL NO.	SERIAL NO.	DATE OF CALIBRATION	DUE DATE OF CALIBRATION
Test Receiver ROHDE & SCHWARZ	ESIB7	100187	Jan. 02, 2014	Jan. 01, 2015
Spectrum Analyzer ROHDE & SCHWARZ	FSP40	100039	Mar. 03, 2014	Mar. 02, 2015
BILOG Antenna SCHWARZBECK	VULB9168	9168-160	Feb. 26, 2014	Feb. 25, 2015
HORN Antenna SCHWARZBECK	9120D	209	Sep. 12, 2013	Sep. 11, 2014
HORN Antenna SCHWARZBECK	BBHA 9170	BBHA9170241	Feb. 17, 2014	Feb. 16, 2015
Preamplifier Agilent	8447D	2944A10633	Oct. 07, 2013	Oct. 06, 2014
Preamplifier Agilent	8449B	3008A01964	Aug. 26, 2013	Aug. 25, 2014
RF signal cable HUBER+SUHNNER	SUCOFLEX 104	214378/4	Aug. 26, 2013	Aug. 25, 2014
RF signal cable HUBER+SUHNNER	SUCOFLEX 106	12738/6 +309224/4	Aug. 26, 2013	Aug. 25, 2014
Software BV ADT	ADT_Radiated_ V7.6.15.9.4	NA	NA	NA
Antenna Tower inn-co GmbH	MA 4000	013303	NA	NA
Antenna Tower Controller inn-co GmbH	CO2000	017303	NA	NA
Turn Table BV ADT	TT100	TT93021703	NA	NA
Turn Table Controller BV ADT	SC100	SC93021703	NA	NA
High Speed Peak Power Meter	ML2495A	0824011	Jul. 29, 2013	Jul. 28, 2014
			Jul. 26, 2014	Jul. 25, 2015
Power Sensor	MA2411B	0738171	Jul. 29, 2013	Jul. 28, 2014
			Jul. 26, 2014	Jul. 25, 2015

- NOTE:**
1. The calibration interval of the above test instruments is 12 months and the calibrations are traceable to NML/ROC and NIST/USA.
 2. The test was performed in HwaYa Chamber 3.
 3. The horn antenna and HP preamplifier (model: 8449B) are used only for the measurement of emission frequency above 1GHz if tested.
 4. The FCC Site Registration No. is 988962.
 5. The IC Site Registration No. is IC 7450F-3.

4.1.3 TEST PROCEDURES

- a. The EUT was placed on the top of a rotating table 0.8 meters above the ground at a 3 meters semi-anechoic chamber. The table was rotated 360 degrees to determine the position of the highest radiation.
- b. The EUT was set 3 meters away from the interference-receiving antenna, which was mounted on the top of a variable-height antenna tower.
- c. Height of receiving antenna is varied from one meter to four meters above the ground to determine the maximum value of the field strength. Both horizontal and vertical polarizations of the antenna are set to make the measurement.
- d. For each suspected emission, the EUT was arranged to its worst case and then the antenna was tuned to heights from 1 meter to 4 meters and the rotatable table was turned from 0 degrees to 360 degrees to find the maximum reading.
- e. The test-receiver system was set to Peak Detect Function and Specified Bandwidth with Maximum Hold Mode.
- f. If the emission level of the EUT in peak mode was lower than the limit specified, then testing could be stopped and the peak values of the EUT would be reported. Otherwise the emissions would be re-tested one by one using peak, quasi-peak or average method as specified and then reported in a data sheet.

NOTE:

1. The resolution bandwidth and video bandwidth of test receiver/spectrum analyzer is 120kHz for Quasi-peak detection at frequency below 1GHz.
2. The resolution bandwidth of test receiver/spectrum analyzer is 1MHz and video bandwidth is 3MHz for Peak detection at frequency above 1GHz.
3. The resolution bandwidth of test receiver/spectrum analyzer is 1MHz and the video bandwidth is $\geq 1/T$ (Duty cycle < 98%) or 10Hz(Duty cycle > 98%) for Average detection (AV) at frequency above 1GHz.
4. All modes of operation were investigated and the worst-case emissions are reported.

4.1.4 DEVIATION FROM TEST STANDARD

No deviation.

4.1.5 TEST SETUP

Frequency range 30MHz~1GHz

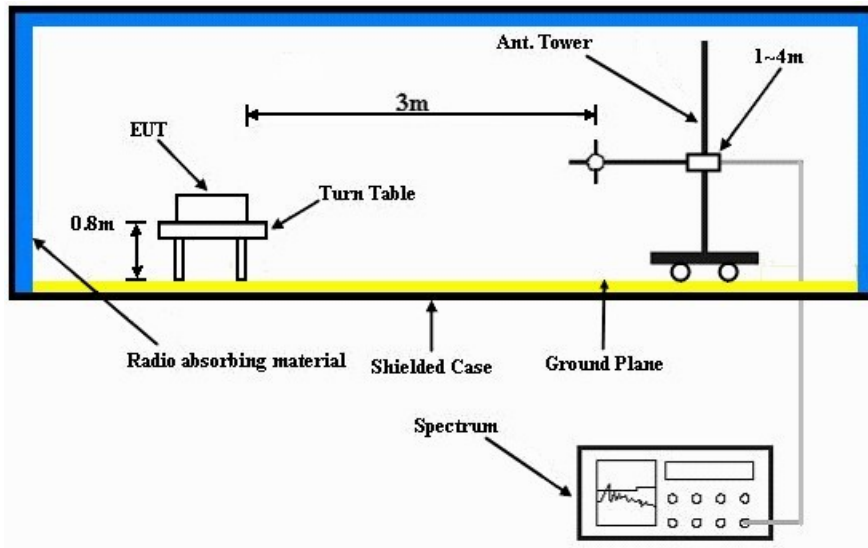

Frequency range above 1GHz

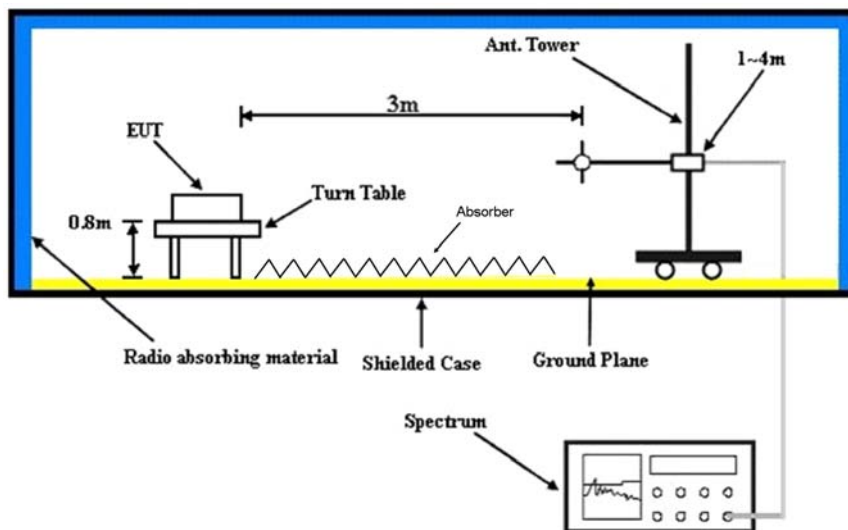

For the actual test configuration, please refer to the attached file (Test Setup Photo).

4.1.6 EUT OPERATING CONDITIONS

- a. Placed the EUT on the testing table.
- b. Prepared notebooks to act as communication partner and placed it outside of testing area.
- c. The communication partner connected with EUT via a RJ45 cable and run a test program (provided by manufacturer) to enable EUT under transmission condition continuously at specific channel frequency.
- d. The communication partner sent data to EUT by command "PING".



A D T

4.1.7 TEST RESULTS

ABOVE 1GHz DATA :

802.11b

CHANNEL	TX Channel 1	DETECTOR FUNCTION	Peak (PK)
FREQUENCY RANGE	1GHz ~ 25GHz		Average (AV)

ANTENNA POLARITY & TEST DISTANCE: HORIZONTAL AT 3 M

NO.	FREQ. (MHz)	EMISSION LEVEL (dBuV/m)	LIMIT (dBuV/m)	MARGIN (dB)	ANTENNA HEIGHT (m)	TABLE ANGLE (Degree)	RAW VALUE (dBuV)	CORRECTION FACTOR (dB/m)
1	2372.00	62.2 PK	74.0	-11.8	1.09 H	1	31.30	30.90
2	2372.00	52.1 AV	54.0	-1.9	1.09 H	1	21.20	30.90
3	*2412.00	115.4 PK			1.47 H	18	84.30	31.10
4	*2412.00	112.1 AV			1.47 H	18	81.00	31.10
5	4824.00	53.1 PK	74.0	-20.9	1.29 H	148	48.20	4.90
6	4824.00	48.4 AV	54.0	-5.6	1.29 H	148	43.50	4.90
7	#7236.00	58.4 PK	85.4	-27.0	1.48 H	12	47.50	10.90
8	#7236.00	52.2 AV	82.1	-29.9	1.48 H	12	41.30	10.90

ANTENNA POLARITY & TEST DISTANCE: VERTICAL AT 3 M

NO.	FREQ. (MHz)	EMISSION LEVEL (dBuV/m)	LIMIT (dBuV/m)	MARGIN (dB)	ANTENNA HEIGHT (m)	TABLE ANGLE (Degree)	RAW VALUE (dBuV)	CORRECTION FACTOR (dB/m)
1	2372.00	59.9 PK	74.0	-14.1	1.18 V	315	29.00	30.90
2	2372.00	50.2 AV	54.0	-3.8	1.18 V	315	19.30	30.90
3	*2412.00	117.6 PK			1.41 V	322	86.50	31.10
4	*2412.00	113.8 AV			1.41 V	322	82.70	31.10
5	4824.00	53.1 PK	74.0	-20.9	1.02 V	339	48.20	4.90
6	4824.00	47.9 AV	54.0	-6.1	1.02 V	339	43.00	4.90
7	#7236.00	57.8 PK	87.6	-29.8	1.49 V	270	46.90	10.90
8	#7236.00	50.6 AV	83.8	-33.2	1.49 V	270	39.70	10.90

REMARKS:

1. Emission Level(dBuV/m) = Raw Value(dBuV) + Correction Factor(dB/m)
2. Correction Factor(dB/m) = Antenna Factor(dB/m) + Cable Factor(dB)
3. The other emission levels were very low against the limit.
4. Margin value = Emission Level – Limit value
5. " * ": Fundamental frequency.
6. " # ": The radiated frequency is out of the restricted band.



A D T

CHANNEL	TX Channel 6	DETECTOR FUNCTION	Peak (PK)
FREQUENCY RANGE	1GHz ~ 25GHz		Average (AV)

ANTENNA POLARITY & TEST DISTANCE: HORIZONTAL AT 3 M

NO.	FREQ. (MHz)	EMISSION LEVEL (dBuV/m)	LIMIT (dBuV/m)	MARGIN (dB)	ANTENNA HEIGHT (m)	TABLE ANGLE (Degree)	RAW VALUE (dBuV)	CORRECTION FACTOR (dB/m)
1	2390.00	58.2 PK	74.0	-15.8	1.06 H	0	27.20	31.00
2	2390.00	47.9 AV	54.0	-6.1	1.06 H	0	16.90	31.00
3	*2437.00	115.1 PK			1.42 H	357	83.90	31.20
4	*2437.00	112.0 AV			1.42 H	357	80.80	31.20
5	2483.50	58.1 PK	74.0	-15.9	1.05 H	357	26.70	31.40
6	2483.50	47.0 AV	54.0	-7.0	1.05 H	357	15.60	31.40
7	4874.00	53.4 PK	74.0	-20.6	1.18 H	350	48.40	5.00
8	4874.00	48.0 AV	54.0	-6.0	1.18 H	350	43.00	5.00
9	7311.00	58.7 PK	74.0	-15.3	1.38 H	344	47.50	11.20
10	7311.00	52.1 AV	54.0	-1.9	1.38 H	344	40.90	11.20

ANTENNA POLARITY & TEST DISTANCE: VERTICAL AT 3 M

NO.	FREQ. (MHz)	EMISSION LEVEL (dBuV/m)	LIMIT (dBuV/m)	MARGIN (dB)	ANTENNA HEIGHT (m)	TABLE ANGLE (Degree)	RAW VALUE (dBuV)	CORRECTION FACTOR (dB/m)
1	2390.00	55.0 PK	74.0	-19.0	1.01 V	330	24.00	31.00
2	2390.00	45.1 AV	54.0	-8.9	1.01 V	330	14.10	31.00
3	*2437.00	114.8 PK			1.00 V	293	83.60	31.20
4	*2437.00	111.1 AV			1.00 V	293	79.90	31.20
5	2483.50	57.3 PK	74.0	-16.7	1.05 V	352	25.90	31.40
6	2483.50	46.6 AV	54.0	-7.4	1.05 V	352	15.20	31.40
7	4874.00	53.2 PK	74.0	-20.8	1.02 V	339	48.20	5.00
8	4874.00	49.7 AV	54.0	-4.3	1.02 V	339	44.70	5.00
9	7311.00	57.8 PK	74.0	-16.2	1.56 V	350	46.60	11.20
10	7311.00	49.7 AV	54.0	-4.3	1.56 V	350	38.50	11.20

REMARKS:

1. Emission Level(dBuV/m) = Raw Value(dBuV) + Correction Factor(dB/m)
2. Correction Factor(dB/m) = Antenna Factor(dB/m) + Cable Factor(dB)
3. The other emission levels were very low against the limit.
4. Margin value = Emission Level – Limit value
5. " * ": Fundamental frequency.



A D T

CHANNEL	TX Channel 11	DETECTOR FUNCTION	Peak (PK)
FREQUENCY RANGE	1GHz ~ 25GHz		Average (AV)

ANTENNA POLARITY & TEST DISTANCE: HORIZONTAL AT 3 M								
NO.	FREQ. (MHz)	EMISSION LEVEL (dBuV/m)	LIMIT (dBuV/m)	MARGIN (dB)	ANTENNA HEIGHT (m)	TABLE ANGLE (Degree)	RAW VALUE (dBuV)	CORRECTION FACTOR (dB/m)
1	*2462.00	121.3 PK			1.05 H	349	90.00	31.30
2	*2462.00	117.3 AV			1.05 H	349	86.00	31.30
3	2500.00	65.0 PK	74.0	-9.0	1.06 H	349	33.50	31.50
4	2500.00	52.0 AV	54.0	-2.0	1.06 H	349	20.50	31.50
5	4924.00	53.1 PK	74.0	-20.9	1.36 H	135	47.90	5.20
6	4924.00	47.3 AV	54.0	-6.7	1.36 H	135	42.10	5.20
7	7386.00	59.4 PK	74.0	-14.6	1.77 H	18	48.00	11.40
8	7386.00	52.1 AV	54.0	-1.9	1.77 H	18	40.70	11.40
ANTENNA POLARITY & TEST DISTANCE: VERTICAL AT 3 M								
NO.	FREQ. (MHz)	EMISSION LEVEL (dBuV/m)	LIMIT (dBuV/m)	MARGIN (dB)	ANTENNA HEIGHT (m)	TABLE ANGLE (Degree)	RAW VALUE (dBuV)	CORRECTION FACTOR (dB/m)
1	*2462.00	116.3 PK			1.12 V	18	85.00	31.30
2	*2462.00	113.3 AV			1.12 V	18	82.00	31.30
3	2500.00	62.5 PK	74.0	-11.5	1.12 V	19	31.00	31.50
4	2500.00	51.2 AV	54.0	-2.8	1.12 V	19	19.70	31.50
5	4924.00	53.5 PK	74.0	-20.5	1.68 V	325	48.30	5.20
6	4924.00	48.7 AV	54.0	-5.3	1.68 V	325	43.50	5.20
7	7386.00	61.3 PK	74.0	-12.7	1.85 V	318	49.90	11.40
8	7386.00	51.7 AV	54.0	-2.3	1.85 V	318	40.30	11.40

REMARKS:

1. Emission Level(dBuV/m) = Raw Value(dBuV) + Correction Factor(dB/m)
2. Correction Factor(dB/m) = Antenna Factor(dB/m) + Cable Factor(dB)
3. The other emission levels were very low against the limit.
4. Margin value = Emission Level – Limit value
5. " * ": Fundamental frequency.



A D T

802.11g

CHANNEL	TX Channel 1	DETECTOR FUNCTION	Peak (PK)
FREQUENCY RANGE	1GHz ~ 25GHz		Average (AV)

ANTENNA POLARITY & TEST DISTANCE: HORIZONTAL AT 3 M

NO.	FREQ. (MHz)	EMISSION LEVEL (dBuV/m)	LIMIT (dBuV/m)	MARGIN (dB)	ANTENNA HEIGHT (m)	TABLE ANGLE (Degree)	RAW VALUE (dBuV)	CORRECTION FACTOR (dB/m)
1	2390.00	72.4 PK	74.0	-1.6	1.05 H	1	41.40	31.00
2	2390.00	51.7 AV	54.0	-2.3	1.00 H	357	20.70	31.00
3	*2412.00	113.2 PK			1.04 H	3	82.10	31.10
4	*2412.00	103.4 AV			1.04 H	3	72.30	31.10
5	4824.00	49.9 PK	74.0	-24.1	1.12 H	198	45.00	4.90
6	4824.00	39.9 AV	54.0	-14.1	1.12 H	198	35.00	4.90

ANTENNA POLARITY & TEST DISTANCE: VERTICAL AT 3 M

NO.	FREQ. (MHz)	EMISSION LEVEL (dBuV/m)	LIMIT (dBuV/m)	MARGIN (dB)	ANTENNA HEIGHT (m)	TABLE ANGLE (Degree)	RAW VALUE (dBuV)	CORRECTION FACTOR (dB/m)
1	2390.00	66.3 PK	74.0	-7.7	1.15 V	309	35.30	31.00
2	2390.00	49.7 AV	54.0	-4.3	1.15 V	309	18.70	31.00
3	*2412.00	110.3 PK			1.15 V	358	79.20	31.10
4	*2412.00	101.3 AV			1.15 V	358	70.20	31.10
5	4824.00	47.9 PK	74.0	-26.1	1.22 V	108	43.00	4.90
6	4824.00	37.9 AV	54.0	-16.1	1.22 V	108	33.00	4.90

REMARKS:

1. Emission Level(dBuV/m) = Raw Value(dBuV) + Correction Factor(dB/m)
2. Correction Factor(dB/m) = Antenna Factor(dB/m) + Cable Factor(dB)
3. The other emission levels were very low against the limit.
4. Margin value = Emission Level – Limit value
5. " * ": Fundamental frequency.



A D T

CHANNEL	TX Channel 6	DETECTOR FUNCTION	Peak (PK)
FREQUENCY RANGE	1GHz ~ 25GHz		Average (AV)

ANTENNA POLARITY & TEST DISTANCE: HORIZONTAL AT 3 M

NO.	FREQ. (MHz)	EMISSION LEVEL (dBuV/m)	LIMIT (dBuV/m)	MARGIN (dB)	ANTENNA HEIGHT (m)	TABLE ANGLE (Degree)	RAW VALUE (dBuV)	CORRECTION FACTOR (dB/m)
1	2390.00	71.3 PK	74.0	-2.7	1.05 H	0	40.30	31.00
2	2390.00	53.0 AV	54.0	-1.0	1.05 H	0	22.00	31.00
3	*2437.00	121.3 PK			1.03 H	5	90.10	31.20
4	*2437.00	111.5 AV			1.03 H	5	80.30	31.20
5	2483.50	69.5 PK	74.0	-4.5	1.03 H	6	38.10	31.40
6	2483.50	52.7 AV	54.0	-1.3	1.03 H	6	21.30	31.40
7	4874.00	54.5 PK	74.0	-19.5	1.18 H	355	49.50	5.00
8	4874.00	43.2 AV	54.0	-10.8	1.18 H	355	38.20	5.00
9	7311.00	61.8 PK	74.0	-12.2	1.18 H	352	50.60	11.20
10	7311.00	47.1 AV	54.0	-6.9	1.18 H	352	35.90	11.20

ANTENNA POLARITY & TEST DISTANCE: VERTICAL AT 3 M

NO.	FREQ. (MHz)	EMISSION LEVEL (dBuV/m)	LIMIT (dBuV/m)	MARGIN (dB)	ANTENNA HEIGHT (m)	TABLE ANGLE (Degree)	RAW VALUE (dBuV)	CORRECTION FACTOR (dB/m)
1	2390.00	59.9 PK	74.0	-14.1	1.15 V	44	28.90	31.00
2	2390.00	49.5 AV	54.0	-4.5	1.15 V	44	18.50	31.00
3	*2437.00	119.3 PK			1.15 V	323	88.10	31.20
4	*2437.00	109.3 AV			1.15 V	323	78.10	31.20
5	2483.50	62.6 PK	74.0	-11.4	1.15 V	330	31.20	31.40
6	2483.50	50.4 AV	54.0	-3.6	1.15 V	330	19.00	31.40
7	4874.00	52.4 PK	74.0	-21.6	1.42 V	325	47.40	5.00
8	4874.00	39.2 AV	54.0	-14.8	1.42 V	325	34.20	5.00
9	7311.00	63.7 PK	74.0	-10.3	1.25 V	349	52.50	11.20
10	7311.00	48.0 AV	54.0	-6.0	1.25 V	349	36.80	11.20

REMARKS:

1. Emission Level(dBuV/m) = Raw Value(dBuV) + Correction Factor(dB/m)
2. Correction Factor(dB/m) = Antenna Factor(dB/m) + Cable Factor(dB)
3. The other emission levels were very low against the limit.
4. Margin value = Emission Level – Limit value
5. " * ": Fundamental frequency.



A D T

CHANNEL	TX Channel 11	DETECTOR FUNCTION	Peak (PK)
FREQUENCY RANGE	1GHz ~ 25GHz		Average (AV)

ANTENNA POLARITY & TEST DISTANCE: HORIZONTAL AT 3 M

NO.	FREQ. (MHz)	EMISSION LEVEL (dBuV/m)	LIMIT (dBuV/m)	MARGIN (dB)	ANTENNA HEIGHT (m)	TABLE ANGLE (Degree)	RAW VALUE (dBuV)	CORRECTION FACTOR (dB/m)
1	*2462.00	115.2 PK			1.02 H	6	83.90	31.30
2	*2462.00	105.6 AV			1.02 H	6	74.30	31.30
3	2483.50	72.9 PK	74.0	-1.1	1.00 H	3	41.50	31.40
4	2483.50	52.4 AV	54.0	-1.6	1.00 H	3	21.00	31.40
5	4924.00	51.3 PK	74.0	-22.7	1.11 H	250	46.10	5.20
6	4924.00	41.6 AV	54.0	-12.4	1.11 H	250	36.40	5.20

ANTENNA POLARITY & TEST DISTANCE: VERTICAL AT 3 M

NO.	FREQ. (MHz)	EMISSION LEVEL (dBuV/m)	LIMIT (dBuV/m)	MARGIN (dB)	ANTENNA HEIGHT (m)	TABLE ANGLE (Degree)	RAW VALUE (dBuV)	CORRECTION FACTOR (dB/m)
1	*2462.00	112.2 PK			1.13 V	334	80.90	31.30
2	*2462.00	103.0 AV			1.13 V	334	71.70	31.30
3	2483.50	67.9 PK	74.0	-6.1	1.13 V	336	36.50	31.40
4	2483.50	51.4 AV	54.0	-2.6	1.13 V	336	20.00	31.40
5	4924.00	48.2 PK	74.0	-25.8	1.23 V	290	43.00	5.20
6	4924.00	37.3 AV	54.0	-16.7	1.23 V	290	32.10	5.20

REMARKS:

1. Emission Level(dBuV/m) = Raw Value(dBuV) + Correction Factor(dB/m)
2. Correction Factor(dB/m) = Antenna Factor(dB/m) + Cable Factor(dB)
3. The other emission levels were very low against the limit.
4. Margin value = Emission Level – Limit value
5. " * ": Fundamental frequency.



A D T

802.11n (20MHz)

CHANNEL	TX Channel 1	DETECTOR FUNCTION	Peak (PK)
FREQUENCY RANGE	1GHz ~ 25GHz		Average (AV)

ANTENNA POLARITY & TEST DISTANCE: HORIZONTAL AT 3 M

NO.	FREQ. (MHz)	EMISSION LEVEL (dBuV/m)	LIMIT (dBuV/m)	MARGIN (dB)	ANTENNA HEIGHT (m)	TABLE ANGLE (Degree)	RAW VALUE (dBuV)	CORRECTION FACTOR (dB/m)
1	2390.00	71.8 PK	74.0	-2.2	2.04 H	1	40.80	31.00
2	2390.00	52.2 AV	54.0	-1.8	2.04 H	1	21.20	31.00
3	*2412.00	111.2 PK			1.05 H	0	80.10	31.10
4	*2412.00	101.5 AV			1.05 H	0	70.40	31.10
5	4824.00	49.0 PK	74.0	-25.0	1.23 H	54	44.10	4.90
6	4824.00	37.9 AV	54.0	-16.1	1.23 H	54	33.00	4.90

ANTENNA POLARITY & TEST DISTANCE: VERTICAL AT 3 M

NO.	FREQ. (MHz)	EMISSION LEVEL (dBuV/m)	LIMIT (dBuV/m)	MARGIN (dB)	ANTENNA HEIGHT (m)	TABLE ANGLE (Degree)	RAW VALUE (dBuV)	CORRECTION FACTOR (dB/m)
1	2390.00	60.3 PK	74.0	-13.7	1.14 V	21	29.30	31.00
2	2390.00	50.2 AV	54.0	-3.8	1.14 V	21	19.20	31.00
3	*2412.00	107.2 PK			1.15 V	18	76.10	31.10
4	*2412.00	97.9 AV			1.15 V	18	66.80	31.10
5	4824.00	47.6 PK	74.0	-26.4	1.20 V	100	42.70	4.90
6	4824.00	35.4 AV	54.0	-18.6	1.20 V	100	30.50	4.90

REMARKS:

1. Emission Level(dBuV/m) = Raw Value(dBuV) + Correction Factor(dB/m)
2. Correction Factor(dB/m) = Antenna Factor(dB/m) + Cable Factor(dB)
3. The other emission levels were very low against the limit.
4. Margin value = Emission Level – Limit value
5. " * ": Fundamental frequency.



A D T

CHANNEL	TX Channel 6	DETECTOR FUNCTION	Peak (PK)
FREQUENCY RANGE	1GHz ~ 25GHz		Average (AV)

ANTENNA POLARITY & TEST DISTANCE: HORIZONTAL AT 3 M

NO.	FREQ. (MHz)	EMISSION LEVEL (dBuV/m)	LIMIT (dBuV/m)	MARGIN (dB)	ANTENNA HEIGHT (m)	TABLE ANGLE (Degree)	RAW VALUE (dBuV)	CORRECTION FACTOR (dB/m)
1	2390.00	71.1 PK	74.0	-2.9	1.09 H	0	40.10	31.00
2	2390.00	52.2 AV	54.0	-1.8	1.09 H	0	21.20	31.00
3	*2437.00	120.5 PK			1.08 H	359	89.30	31.20
4	*2437.00	110.9 AV			1.08 H	359	79.70	31.20
5	2483.50	71.3 PK	74.0	-2.7	1.05 H	345	39.90	31.40
6	2483.50	52.9 AV	54.0	-1.1	1.05 H	345	21.50	31.40
7	4874.00	51.5 PK	74.0	-22.5	1.38 H	241	46.50	5.00
8	4874.00	37.8 AV	54.0	-16.2	1.38 H	241	32.80	5.00
9	7311.00	64.0 PK	74.0	-10.0	1.43 H	349	52.80	11.20
10	7311.00	48.5 AV	54.0	-5.5	1.43 H	349	37.30	11.20

ANTENNA POLARITY & TEST DISTANCE: VERTICAL AT 3 M

NO.	FREQ. (MHz)	EMISSION LEVEL (dBuV/m)	LIMIT (dBuV/m)	MARGIN (dB)	ANTENNA HEIGHT (m)	TABLE ANGLE (Degree)	RAW VALUE (dBuV)	CORRECTION FACTOR (dB/m)
1	2390.00	58.7 PK	74.0	-15.3	1.12 V	358	27.70	31.00
2	2390.00	49.5 AV	54.0	-4.5	1.12 V	358	18.50	31.00
3	*2437.00	119.0 PK			1.10 V	9	87.80	31.20
4	*2437.00	109.7 AV			1.10 V	9	78.50	31.20
5	2483.50	64.8 PK	74.0	-9.2	1.10 V	11	33.40	31.40
6	2483.50	51.5 AV	54.0	-2.5	1.10 V	11	20.10	31.40
7	4874.00	51.6 PK	74.0	-22.4	1.41 V	328	46.60	5.00
8	4874.00	38.3 AV	54.0	-15.7	1.41 V	328	33.30	5.00
9	7311.00	65.4 PK	74.0	-8.6	1.76 V	352	54.20	11.20
10	7311.00	50.7 AV	54.0	-3.3	1.76 V	352	39.50	11.20

REMARKS:

1. Emission Level(dBuV/m) = Raw Value(dBuV) + Correction Factor(dB/m)
2. Correction Factor(dB/m) = Antenna Factor(dB/m) + Cable Factor(dB)
3. The other emission levels were very low against the limit.
4. Margin value = Emission Level – Limit value
5. " * ": Fundamental frequency.



A D T

CHANNEL	TX Channel 11	DETECTOR FUNCTION	Peak (PK)
FREQUENCY RANGE	1GHz ~ 25GHz		Average (AV)

ANTENNA POLARITY & TEST DISTANCE: HORIZONTAL AT 3 M								
NO.	FREQ. (MHz)	EMISSION LEVEL (dBuV/m)	LIMIT (dBuV/m)	MARGIN (dB)	ANTENNA HEIGHT (m)	TABLE ANGLE (Degree)	RAW VALUE (dBuV)	CORRECTION FACTOR (dB/m)
1	*2462.00	114.0 PK			1.05 H	0	82.70	31.30
2	*2462.00	104.8 AV			1.05 H	0	73.50	31.30
3	2483.50	68.7 PK	74.0	-5.3	1.05 H	345	37.30	31.40
4	2483.50	52.4 AV	54.0	-1.6	1.05 H	345	21.00	31.40
5	4924.00	48.4 PK	74.0	-25.6	1.31 H	333	43.20	5.20
6	4924.00	36.9 AV	54.0	-17.1	1.31 H	333	31.70	5.20
ANTENNA POLARITY & TEST DISTANCE: VERTICAL AT 3 M								
NO.	FREQ. (MHz)	EMISSION LEVEL (dBuV/m)	LIMIT (dBuV/m)	MARGIN (dB)	ANTENNA HEIGHT (m)	TABLE ANGLE (Degree)	RAW VALUE (dBuV)	CORRECTION FACTOR (dB/m)
1	*2462.00	110.4 PK			1.14 V	0	79.10	31.30
2	*2462.00	100.8 AV			1.14 V	0	69.50	31.30
3	2483.50	65.7 PK	74.0	-8.3	1.16 V	12	34.30	31.40
4	2483.50	51.4 AV	54.0	-2.6	1.16 V	12	20.00	31.40
5	4924.00	47.6 PK	74.0	-26.4	1.11 V	3	42.40	5.20
6	4924.00	34.9 AV	54.0	-19.1	1.11 V	3	29.70	5.20

REMARKS:

1. Emission Level(dBuV/m) = Raw Value(dBuV) + Correction Factor(dB/m)
2. Correction Factor(dB/m) = Antenna Factor(dB/m) + Cable Factor(dB)
3. The other emission levels were very low against the limit.
4. Margin value = Emission Level – Limit value
5. " * ": Fundamental frequency.



A D T

802.11n (40MHz)

CHANNEL	TX Channel 3	DETECTOR FUNCTION	Peak (PK)
FREQUENCY RANGE	1GHz ~ 25GHz		Average (AV)

ANTENNA POLARITY & TEST DISTANCE: HORIZONTAL AT 3 M

NO.	FREQ. (MHz)	EMISSION LEVEL (dBuV/m)	LIMIT (dBuV/m)	MARGIN (dB)	ANTENNA HEIGHT (m)	TABLE ANGLE (Degree)	RAW VALUE (dBuV)	CORRECTION FACTOR (dB/m)
1	2390.00	69.2 PK	74.0	-4.8	1.06 H	356	38.20	31.00
2	2390.00	53.0 AV	54.0	-1.0	1.06 H	356	22.00	31.00
3	*2422.00	108.0 PK			1.02 H	0	76.80	31.20
4	*2422.00	97.9 AV			1.02 H	0	66.70	31.20
5	4844.00	47.8 PK	74.0	-26.2	1.23 H	140	42.80	5.00
6	4844.00	34.3 AV	54.0	-19.7	1.23 H	140	29.30	5.00

ANTENNA POLARITY & TEST DISTANCE: VERTICAL AT 3 M

NO.	FREQ. (MHz)	EMISSION LEVEL (dBuV/m)	LIMIT (dBuV/m)	MARGIN (dB)	ANTENNA HEIGHT (m)	TABLE ANGLE (Degree)	RAW VALUE (dBuV)	CORRECTION FACTOR (dB/m)
1	2390.00	67.1 PK	74.0	-6.9	1.14 V	39	36.10	31.00
2	2390.00	50.6 AV	54.0	-3.4	1.14 V	39	19.60	31.00
3	*2422.00	104.1 PK			1.12 V	16	72.90	31.20
4	*2422.00	95.8 AV			1.12 V	16	64.60	31.20
5	4844.00	47.0 PK	74.0	-27.0	1.21 V	294	42.00	5.00
6	4844.00	34.0 AV	54.0	-20.0	1.21 V	294	29.00	5.00

REMARKS:

1. Emission Level(dBuV/m) = Raw Value(dBuV) + Correction Factor(dB/m)
2. Correction Factor(dB/m) = Antenna Factor(dB/m) + Cable Factor(dB)
3. The other emission levels were very low against the limit.
4. Margin value = Emission Level – Limit value
5. " * ": Fundamental frequency.



A D T

CHANNEL	TX Channel 6	DETECTOR FUNCTION	Peak (PK)
FREQUENCY RANGE	1GHz ~ 25GHz		Average (AV)

ANTENNA POLARITY & TEST DISTANCE: HORIZONTAL AT 3 M

NO.	FREQ. (MHz)	EMISSION LEVEL (dBuV/m)	LIMIT (dBuV/m)	MARGIN (dB)	ANTENNA HEIGHT (m)	TABLE ANGLE (Degree)	RAW VALUE (dBuV)	CORRECTION FACTOR (dB/m)
1	2390.00	68.9 PK	74.0	-5.1	1.06 H	0	37.90	31.00
2	2390.00	52.3 AV	54.0	-1.7	1.06 H	0	21.30	31.00
3	*2437.00	109.9 PK			1.02 H	4	78.70	31.20
4	*2437.00	100.8 AV			1.02 H	4	69.60	31.20
5	4874.00	48.9 PK	74.0	-25.1	1.24 H	302	43.90	5.00
6	4874.00	37.4 AV	54.0	-16.6	1.24 H	302	32.40	5.00

ANTENNA POLARITY & TEST DISTANCE: VERTICAL AT 3 M

NO.	FREQ. (MHz)	EMISSION LEVEL (dBuV/m)	LIMIT (dBuV/m)	MARGIN (dB)	ANTENNA HEIGHT (m)	TABLE ANGLE (Degree)	RAW VALUE (dBuV)	CORRECTION FACTOR (dB/m)
1	2390.00	59.0 PK	74.0	-15.0	1.15 V	4	28.00	31.00
2	2390.00	48.0 AV	54.0	-6.0	1.15 V	4	17.00	31.00
3	*2437.00	108.3 PK			1.16 V	19	77.10	31.20
4	*2437.00	98.9 AV			1.16 V	19	67.70	31.20
5	4874.00	47.3 PK	74.0	-26.7	1.17 V	118	42.30	5.00
6	4874.00	34.1 AV	54.0	-19.9	1.17 V	118	29.10	5.00

REMARKS:

1. Emission Level(dBuV/m) = Raw Value(dBuV) + Correction Factor(dB/m)
2. Correction Factor(dB/m) = Antenna Factor(dB/m) + Cable Factor(dB)
3. The other emission levels were very low against the limit.
4. Margin value = Emission Level – Limit value
5. " * ": Fundamental frequency.



A D T

CHANNEL	TX Channel 9	DETECTOR FUNCTION	Peak (PK)
FREQUENCY RANGE	1GHz ~ 25GHz		Average (AV)

ANTENNA POLARITY & TEST DISTANCE: HORIZONTAL AT 3 M

NO.	FREQ. (MHz)	EMISSION LEVEL (dBuV/m)	LIMIT (dBuV/m)	MARGIN (dB)	ANTENNA HEIGHT (m)	TABLE ANGLE (Degree)	RAW VALUE (dBuV)	CORRECTION FACTOR (dB/m)
1	*2452.00	108.9 PK			1.03 H	357	77.60	31.30
2	*2452.00	99.7 AV			1.03 H	357	68.40	31.30
3	2483.50	70.0 PK	74.0	-4.0	1.06 H	347	38.60	31.40
4	2483.50	53.0 AV	54.0	-1.0	1.06 H	347	21.60	31.40
5	4904.00	48.0 PK	74.0	-26.0	1.31 H	302	42.90	5.10
6	4904.00	34.6 AV	54.0	-19.4	1.31 H	302	29.50	5.10

ANTENNA POLARITY & TEST DISTANCE: VERTICAL AT 3 M

NO.	FREQ. (MHz)	EMISSION LEVEL (dBuV/m)	LIMIT (dBuV/m)	MARGIN (dB)	ANTENNA HEIGHT (m)	TABLE ANGLE (Degree)	RAW VALUE (dBuV)	CORRECTION FACTOR (dB/m)
1	*2452.00	105.9 PK			1.14 V	16	74.60	31.30
2	*2452.00	96.0 AV			1.14 V	16	64.70	31.30
3	2483.50	67.1 PK	74.0	-6.9	1.16 V	11	35.70	31.40
4	2483.50	52.2 AV	54.0	-1.8	1.16 V	11	20.80	31.40
5	4904.00	47.4 PK	74.0	-26.6	1.21 V	242	42.30	5.10
6	4904.00	34.0 AV	54.0	-20.0	1.21 V	242	28.90	5.10

REMARKS:

1. Emission Level(dBuV/m) = Raw Value(dBuV) + Correction Factor(dB/m)
2. Correction Factor(dB/m) = Antenna Factor(dB/m) + Cable Factor(dB)
3. The other emission levels were very low against the limit.
4. Margin value = Emission Level – Limit value
5. " * ": Fundamental frequency.



A D T

BELOW 1GHz WORST-CASE DATA

802.11g

CHANNEL	TX Channel 6	DETECTOR FUNCTION	Quasi-Peak (QP)
FREQUENCY RANGE	30MHz ~ 1GHz		

ANTENNA POLARITY & TEST DISTANCE: HORIZONTAL AT 3 M

NO.	FREQ. (MHz)	EMISSION LEVEL (dBuV/m)	LIMIT (dBuV/m)	MARGIN (dB)	ANTENNA HEIGHT (m)	TABLE ANGLE (Degree)	RAW VALUE (dBuV)	CORRECTION FACTOR (dB/m)
1	57.12	33.0 QP	40.0	-7.0	1.99 H	16	47.60	-14.60
2	212.66	35.1 QP	43.5	-8.4	1.00 H	177	51.40	-16.30
3	624.85	38.7 QP	46.0	-7.3	1.00 H	189	44.20	-5.50
4	751.23	42.9 QP	46.0	-3.1	1.00 H	340	45.90	-3.00
5	875.67	40.4 QP	46.0	-5.6	1.50 H	135	41.50	-1.10
6	961.21	41.8 QP	54.0	-12.2	1.25 H	215	41.10	0.70

ANTENNA POLARITY & TEST DISTANCE: VERTICAL AT 3 M

NO.	FREQ. (MHz)	EMISSION LEVEL (dBuV/m)	LIMIT (dBuV/m)	MARGIN (dB)	ANTENNA HEIGHT (m)	TABLE ANGLE (Degree)	RAW VALUE (dBuV)	CORRECTION FACTOR (dB/m)
1	51.29	35.0 QP	40.0	-5.0	1.26 V	11	49.50	-14.50
2	70.73	33.4 QP	40.0	-6.6	1.00 V	135	49.60	-16.20
3	125.17	32.6 QP	43.5	-10.9	1.26 V	17	48.40	-15.80
4	751.23	40.6 QP	46.0	-5.4	1.26 V	52	43.60	-3.00
5	875.67	37.7 QP	46.0	-8.3	1.26 V	184	38.80	-1.10
6	961.21	46.5 QP	54.0	-7.5	1.00 V	16	45.80	0.70

REMARKS:

1. Emission Level(dBuV/m) = Raw Value(dBuV) + Correction Factor(dB/m)
2. Correction Factor(dB/m) = Antenna Factor(dB/m) + Cable Factor(dB)
3. The other emission levels were very low against the limit.
4. Margin value = Emission Level – Limit value

4.2 CONDUCTED EMISSION MEASUREMENT

4.2.1 LIMITS OF CONDUCTED EMISSION MEASUREMENT

FREQUENCY OF EMISSION (MHz)	CONDUCTED LIMIT (dB μ V)	
	Quasi-peak	Average
0.15 ~ 0.5	66 to 56	56 to 46
0.5 ~ 5	56	46
5 ~ 30	60	50

- NOTE:**
1. The lower limit shall apply at the transition frequencies.
 2. The limit decreases in line with the logarithm of the frequency in the range of 0.15 to 0.50MHz.
 3. All emanations from a class A/B digital device or system, including any network of conductors and apparatus connected thereto, shall not exceed the level of field strengths specified above.

4.2.2 TEST INSTRUMENTS

DESCRIPTION & MANUFACTURER	MODEL NO.	SERIAL NO.	DATE OF CALIBRATION	DUE DATE OF CALIBRATION
Test Receiver ROHDE & SCHWARZ	ESCS30	100288	Apr. 24, 2014	Apr. 23, 2015
RF signal cable Woken	5D-FB	Cable-HYCO2-01	Dec. 27, 2013	Dec. 26, 2014
LISN ROHDE & SCHWARZ (EUT)	ESH2-Z5	100100	Dec. 23, 2013	Dec. 22, 2014
LISN ROHDE & SCHWARZ (Peripheral)	ESH3-Z5	100312	Jul. 10, 2014	Jul. 09, 2015
Software ADT	BV ADT_Cond_ V7.3.7.3	NA	NA	NA

- Notes:
1. The calibration interval of the above test instruments is 12 months and the calibrations are traceable to NML/ROC and NIST/USA.
 2. The test was performed in HwaYa Shielded Room 2.
 3. The VCCI Site Registration No. is C-2047.

4.2.3 TEST PROCEDURES

- a. The EUT was placed 0.4 meters from the conducting wall of the shielded room with EUT being connected to the power mains through a line impedance stabilization network (LISN). Other support units were connected to the power mains through another LISN. The two LISNs provide 50 ohm/ 50uH of coupling impedance for the measuring instrument.
- b. Both lines of the power mains connected to the EUT were checked for maximum conducted interference.
- c. The frequency range from 150kHz to 30MHz was searched. Emission levels under (Limit - 20dB) was not recorded.

NOTE: All modes of operation were investigated and the worst-case emissions are reported.

4.2.4 DEVIATION FROM TEST STANDARD

No deviation.

4.2.5 TEST SETUP

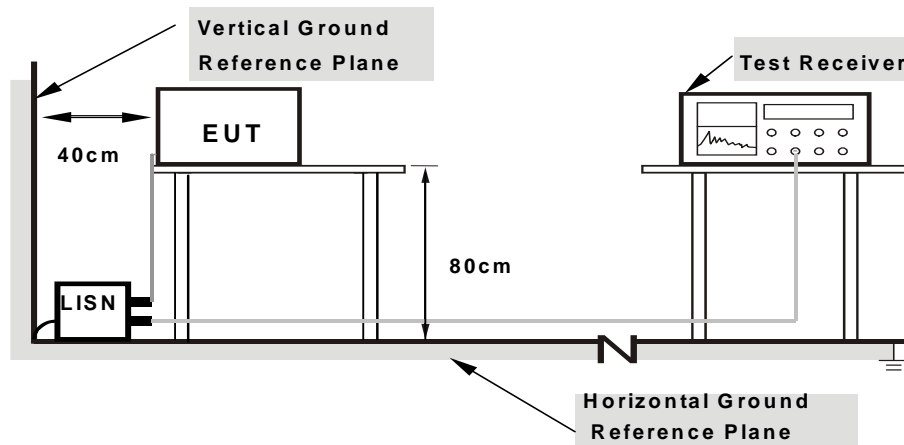

Note: 1.Support units were connected to second LISN.
 2.Both of LISNs (AMN) are 80 cm from EUT and at least 80 from other units and other metal planes

For the actual test configuration, please refer to the attached file (Test Setup Photo).

4.2.6 EUT OPERATING CONDITIONS

Same as 4.1.6.

4.2.7 TEST RESULTS

CONDUCTED WORST-CASE DATA : 802.11g

PHASE	Line 1	6dB BANDWIDTH	9kHz
--------------	--------	----------------------	------

No	Freq. [MHz]	Corr. Factor (dB)	Reading Value		Emission Level		Limit		Margin	
			[dB (uV)]		[dB (uV)]		[dB (uV)]		(dB)	
			Q.P.	AV.	Q.P.	AV.	Q.P.	AV.	Q.P.	AV.
1	0.15000	0.21	53.34	35.26	53.55	35.47	66.00	56.00	-12.45	-20.53
2	0.18925	0.23	47.62	32.55	47.85	32.78	64.07	54.07	-16.21	-21.28
3	0.21250	0.24	44.43	29.15	44.67	29.39	63.11	53.11	-18.44	-23.72
4	0.47813	0.23	39.17	33.02	39.40	33.25	56.37	46.37	-16.97	-13.12
5	4.67969	0.45	36.37	29.19	36.82	29.64	56.00	46.00	-19.18	-16.36
6	10.99219	0.52	44.19	39.10	44.71	39.62	60.00	50.00	-15.29	-10.38

- REMARKS:**
1. Q.P. and AV. are abbreviations of quasi-peak and average individually.
 2. The emission levels of other frequencies were very low against the limit.
 3. Margin value = Emission level - Limit value
 4. Correction factor = Insertion loss + Cable loss
 5. Emission Level = Correction Factor + Reading Value.

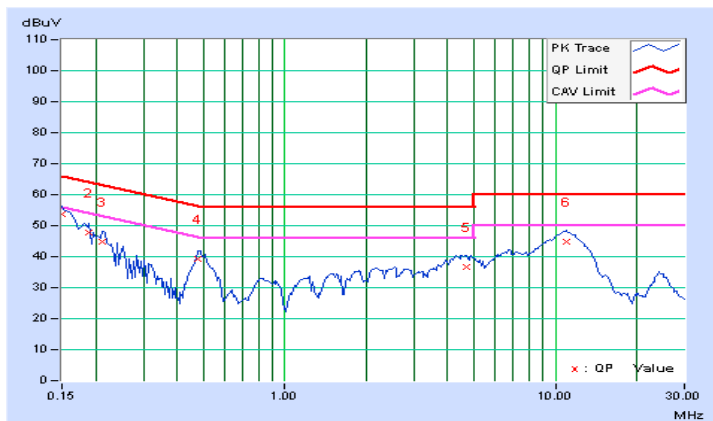

PHASE	Line 2	6dB BANDWIDTH	9kHz
-------	--------	---------------	------

No	Freq. [MHz]	Corr. Factor (dB)	Reading Value		Emission Level		Limit		Margin	
			[dB (uV)]		[dB (uV)]		[dB (uV)]		(dB)	
			Q.P.	AV.	Q.P.	AV.	Q.P.	AV.	Q.P.	AV.
1	0.15000	0.23	53.22	35.56	53.45	35.79	66.00	56.00	-12.55	-20.21
2	0.16172	0.23	51.66	36.57	51.89	36.80	65.38	55.38	-13.49	-18.58
3	0.19687	0.24	46.52	32.22	46.76	32.46	63.74	53.74	-16.98	-21.28
4	0.47422	0.30	40.82	35.06	41.12	35.36	56.44	46.44	-15.32	-11.08
5	1.83594	0.37	32.61	27.01	32.98	27.38	56.00	46.00	-23.02	-18.62
6	11.36328	0.60	39.02	34.13	39.62	34.73	60.00	50.00	-20.38	-15.27

- REMARKS:**
1. Q.P. and AV. are abbreviations of quasi-peak and average individually.
 2. The emission levels of other frequencies were very low against the limit.
 3. Margin value = Emission level - Limit value
 4. Correction factor = Insertion loss + Cable loss
 5. Emission Level = Correction Factor + Reading Value.

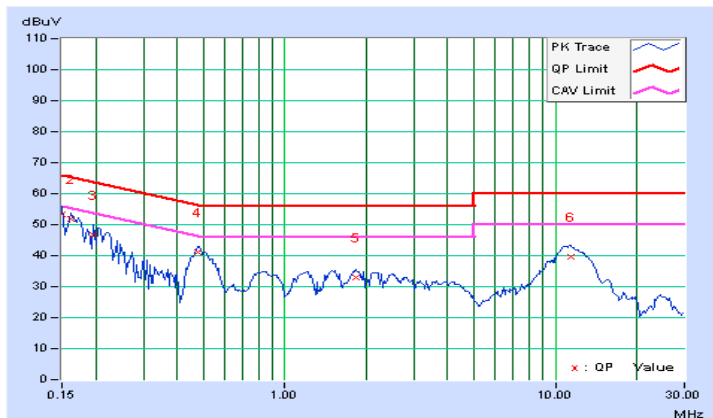

4.3 6dB BANDWIDTH MEASUREMENT

4.3.1 LIMITS OF 6dB BANDWIDTH MEASUREMENT

The minimum of 6dB Bandwidth Measurement is 0.5 MHz.

4.3.2 TEST SETUP

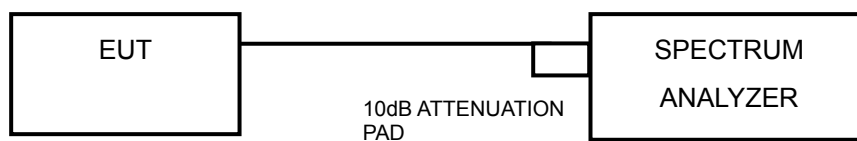

4.3.3 TEST INSTRUMENTS

Refer to section 4.1.2 to get information of above instrument.

4.3.4 TEST PROCEDURE

- a. Set resolution bandwidth (RBW) = 100kHz
- b. Set the video bandwidth (VBW) $\geq 3 \times$ RBW, Detector = Peak.
- c. Trace mode = max hold.
- d. Sweep = auto couple.
- e. Measure the maximum width of the emission that is constrained by the frequencies associated with the two amplitude points (upper and lower) that are attenuated by 6 dB relative to the maximum level measured in the fundamental emission

4.3.5 DEVIATION FROM TEST STANDARD

No deviation.

4.3.6 EUT OPERATING CONDITIONS

The software provided by client to enable the EUT under transmission condition continuously at lowest, middle and highest channel frequencies individually.



4.3.7 TEST RESULTS

802.11b

CHANNEL	CHANNEL FREQUENCY (MHz)	6dB BANDWIDTH (MHz)			MINIMUM LIMIT (MHz)	PASS / FAIL
		CHAIN 0	CHAIN 1	CHAIN 2		
1	2412	7.10	7.07	7.10	0.5	PASS
6	2437	7.11	7.11	7.60	0.5	PASS
11	2462	7.11	7.11	7.08	0.5	PASS

802.11g

CHANNEL	CHANNEL FREQUENCY (MHz)	6dB BANDWIDTH (MHz)			MINIMUM LIMIT (MHz)	PASS / FAIL
		CHAIN 0	CHAIN 1	CHAIN 2		
1	2412	16.42	16.41	16.40	0.5	PASS
6	2437	16.38	16.38	16.40	0.5	PASS
11	2462	16.39	16.12	16.39	0.5	PASS

802.11n (20MHz)

CHANNEL	CHANNEL FREQUENCY (MHz)	6dB BANDWIDTH (MHz)			MINIMUM LIMIT (MHz)	PASS / FAIL
		CHAIN 0	CHAIN 1	CHAIN 2		
1	2412	17.63	17.62	17.63	0.5	PASS
6	2437	17.60	17.55	17.33	0.5	PASS
11	2462	17.60	17.61	17.59	0.5	PASS

802.11n (40MHz)

CHANNEL	CHANNEL FREQUENCY (MHz)	6dB BANDWIDTH (MHz)			MINIMUM LIMIT (MHz)	PASS / FAIL
		CHAIN 0	CHAIN 1	CHAIN 2		
3	2422	36.16	35.90	36.12	0.5	PASS
6	2437	35.84	36.37	36.14	0.5	PASS
9	2452	36.17	36.42	36.06	0.5	PASS



A D T

SPECTRUM PLOT OF WORST VALUE

802.11b

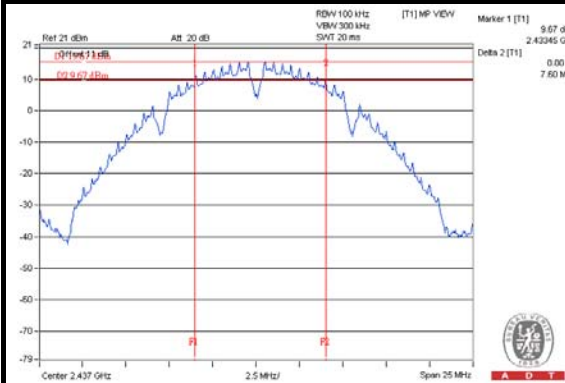

802.11g

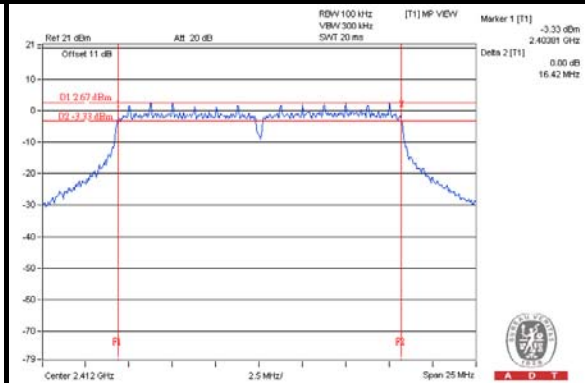

802.11n (20MHz)

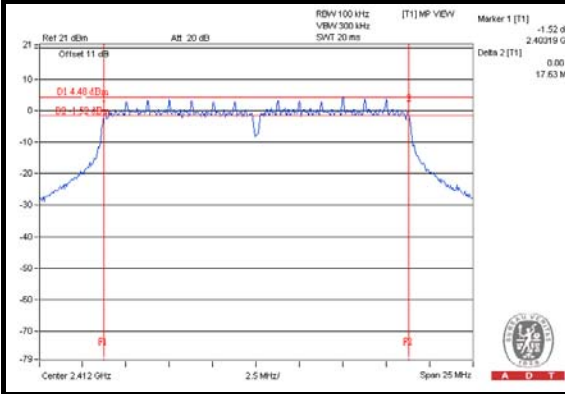

802.11n (40MHz)

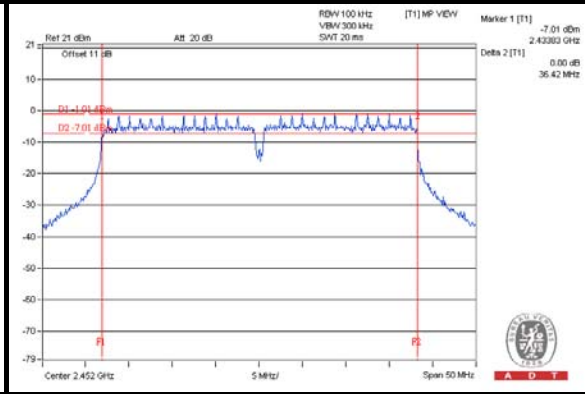

4.4 CONDUCTED OUTPUT POWER

4.4.1 LIMITS OF CONDUCTED OUTPUT POWER MEASUREMENT

For systems using digital modulation in the 2400–2483.5 MHz bands: 1 Watt (30dBm)

Per KDB 662911 D01 Multiple Transmitter Output v02r01 Method of conducted output power measurement on IEEE 802.11 devices,

Array Gain = 0 dB (i.e., no array gain) for $NANT \leq 4$;

Array Gain = 0 dB (i.e., no array gain) for channel widths ≥ 40 MHz for any NANT;

Array Gain = $5 \log(NANT/NSS)$ dB or 3 dB, whichever is less for 20-MHz channel widths with $NANT \geq 5$.

For power measurements on all other devices: Array Gain = $10 \log(NANT/NSS)$ dB.

4.4.2 TEST SETUP

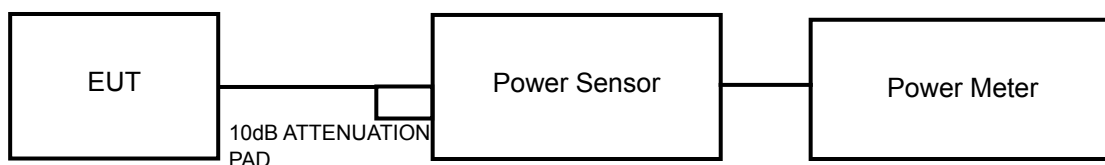

4.4.3 TEST INSTRUMENTS

Refer to section 4.1.2 to get information of above instrument.

4.4.4 TEST PROCEDURES

An average power sensor was used on the output port of the EUT. A power meter was used to read the response of the average power sensor. Record the power level.



A D T

4.4.5 DEVIATION FROM TEST STANDARD

No deviation.

4.4.6 EUT OPERATING CONDITIONS

Same as Item 4.3.6.



4.4.7 TEST RESULTS

802.11b

CHAN.	CHAN. FREQ. (MHz)	AVG. POWER (dBm)			TOTAL POWER (mW)	TOTAL POWER (dBm)	LIMIT (dBm)	PASS / FAIL
		CHAIN 0	CHAIN 1	CHAIN 2				
1	2412	20.88	21.84	21.56	418.438	26.22	30	PASS
6	2437	23.49	24.41	24.20	762.442	28.82	30	PASS
11	2462	23.35	23.12	23.38	639.159	28.06	30	PASS

802.11g

CHAN.	CHAN. FREQ. (MHz)	AVG. POWER (dBm)			TOTAL POWER (mW)	TOTAL POWER (dBm)	LIMIT (dBm)	PASS / FAIL
		CHAIN 0	CHAIN 1	CHAIN 2				
1	2412	14.23	15.16	15.44	94.290	19.74	30	PASS
6	2437	24.81	24.38	24.10	833.888	29.21	30	PASS
11	2462	17.66	17.67	17.45	172.414	22.37	30	PASS

802.11n (20MHz)

CHAN.	CHAN. FREQ. (MHz)	AVG. POWER (dBm)			TOTAL POWER (mW)	TOTAL POWER (dBm)	LIMIT (dBm)	PASS / FAIL
		CHAIN 0	CHAIN 1	CHAIN 2				
1	2412	14.35	14.85	15.14	90.435	19.56	30	PASS
6	2437	23.65	24.23	24.41	772.647	28.88	30	PASS
11	2462	16.19	16.59	16.40	130.847	21.17	30	PASS

802.11n (40MHz)

CHAN.	CHAN. FREQ. (MHz)	AVG. POWER (dBm)			TOTAL POWER (mW)	TOTAL POWER (dBm)	LIMIT (dBm)	PASS / FAIL
		CHAIN 0	CHAIN 1	CHAIN 2				
3	2422	11.06	12.07	11.58	43.258	16.36	30	PASS
6	2437	14.69	15.22	15.15	95.444	19.80	30	PASS
9	2452	13.14	13.56	13.25	64.44	18.09	30	PASS

4.5 POWER SPECTRAL DENSITY MEASUREMENT

4.5.1 LIMITS OF POWER SPECTRAL DENSITY MEASUREMENT

The Maximum of Power Spectral Density Measurement is 8dBm.

4.5.2 TEST SETUP

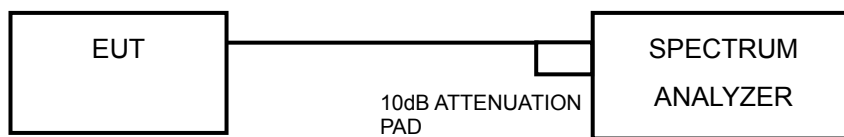

4.5.3 TEST INSTRUMENTS

Refer to section 4.1.2 to get information of above instrument.

4.5.4 TEST PROCEDURE

- a. Set the RBW = 3 kHz, VBW = 10 kHz, Detector = RMS.
- b. Sweep time = auto couple, Trace mode = max hold, allow trace to fully stabilize.
- c. Use the peak marker function to determine the maximum power level in any 100 kHz band segment within the fundamental EBW.

4.5.5 DEVIATION FROM TEST STANDARD

No deviation.

4.5.6 EUT OPERATING CONDITION

Same as Item 4.3.6

4.5.7 TEST RESULTS

802.11b

TX chain	Channel	Freq. (MHz)	PSD (dBm/3kHz)	10 log (N=3) dB	Total PSD (dBm/3kHz)	Limit (dBm/3kHz)	PASS /FAIL
0	1	2412	-6.32	4.77	-1.55	5.23	PASS
	6	2437	-4.04	4.77	0.73	5.23	PASS
	11	2462	-3.77	4.77	1.00	5.23	PASS
1	1	2412	-5.75	4.77	-0.98	5.23	PASS
	6	2437	-4.22	4.77	0.55	5.23	PASS
	11	2462	-4.45	4.77	0.32	5.23	PASS
2	1	2412	-5.25	4.77	-0.48	5.23	PASS
	6	2437	-3.53	4.77	1.24	5.23	PASS
	11	2462	-2.81	4.77	1.96	5.23	PASS

NOTE: Directional gain = $4\text{dBi} + 10\log(3) = 8.77\text{dBi} > 6\text{dBi}$, so the power density limit shall be reduced to $8-(8.77-6) = 5.23\text{dBm}$.

802.11g

TX chain	Channel	Freq. (MHz)	PSD W/O DUTY FACTOR (dBm/3kHz)	10 log (N=3) dB	DUTY FACTOR	TOTAL PSD WITH DUTY FACTOR (dBm/3kHz)	Limit (dBm/3kHz)	PASS /FAIL
0	1	2412	-16.46	4.77	0.15	-11.54	5.23	PASS
	6	2437	-6.50	4.77	0.15	-1.58	5.23	PASS
	11	2462	-12.98	4.77	0.15	-8.06	5.23	PASS
1	1	2412	-13.12	4.77	0.15	-8.20	5.23	PASS
	6	2437	-5.78	4.77	0.15	-0.86	5.23	PASS
	11	2462	-12.34	4.77	0.15	-7.42	5.23	PASS
2	1	2412	-15.18	4.77	0.15	-10.26	5.23	PASS
	6	2437	-6.02	4.77	0.15	-1.10	5.23	PASS
	11	2462	-12.51	4.77	0.15	-7.59	5.23	PASS

NOTE:

- Method 1 of power density measurement of KDB 662911 is using for calculating total power density. Total power density is summing entire spectra across corresponding frequency bins on the various outputs by computer.
- Directional gain = $4\text{dBi} + 10\log(3) = 8.77\text{dBi} > 6\text{dBi}$, so the power density limit shall be reduced to $8-(8.77-6) = 5.23\text{dBm}$.
- Refer to section 3.3 for duty cycle spectrum plot.

**802.11n (20MHz)**

TX chain	Channel	Freq. (MHz)	PSD W/O DUTY FACTOR (dBm/3kHz)	10 log (N=3) dB	DUTY FACTOR	TOTAL PSD WITH DUTY FACTOR (dBm/3kHz)	Limit (dBm/3kHz)	PASS /FAIL
0	1	2412	-16.18	4.77	0.11	-11.30	5.23	PASS
	6	2437	-6.92	4.77	0.11	-2.04	5.23	PASS
	11	2462	-9.54	4.77	0.11	-4.66	5.23	PASS
1	1	2412	-13.14	4.77	0.11	-8.26	5.23	PASS
	6	2437	-6.61	4.77	0.11	-1.73	5.23	PASS
	11	2462	-14.07	4.77	0.11	-9.19	5.23	PASS
2	1	2412	-15.63	4.77	0.11	-10.75	5.23	PASS
	6	2437	-6.69	4.77	0.11	-1.81	5.23	PASS
	11	2462	-14.51	4.77	0.11	-9.63	5.23	PASS

NOTE:

- Method 1 of power density measurement of KDB 662911 is using for calculating total power density. Total power density is summing entire spectra across corresponding frequency bins on the various outputs by computer.
- Directional gain = $4\text{dBi} + 10\log(3) = 8.77\text{dBi} > 6\text{dBi}$, so the power density limit shall be reduced to $8-(8.77-6) = 5.23\text{dBm}$.
- Refer to section 3.3 for duty cycle spectrum plot.

802.11n (40MHz)

TX chain	Channel	Freq. (MHz)	PSD W/O DUTY FACTOR (dBm/3kHz)	10 log (N=3) dB	DUTY FACTOR	TOTAL PSD WITH DUTY FACTOR (dBm/3kHz)	Limit (dBm/3kHz)	PASS /FAIL
0	3	2422	-21.01	4.77	0.21	-16.03	5.23	PASS
	6	2437	-18.24	4.77	0.21	-13.26	5.23	PASS
	9	2452	-19.38	4.77	0.21	-14.40	5.23	PASS
1	3	2422	-19.97	4.77	0.21	-14.99	5.23	PASS
	6	2437	-13.30	4.77	0.21	-8.32	5.23	PASS
	9	2452	-19.04	4.77	0.21	-14.06	5.23	PASS
2	3	2422	-18.13	4.77	0.21	-13.15	5.23	PASS
	6	2437	-16.82	4.77	0.21	-11.84	5.23	PASS
	9	2452	-19.23	4.77	0.21	-14.25	5.23	PASS

NOTE:

- Method 1 of power density measurement of KDB 662911 is using for calculating total power density. Total power density is summing entire spectra across corresponding frequency bins on the various outputs by computer.
- Directional gain = $4\text{dBi} + 10\log(3) = 8.77\text{dBi} > 6\text{dBi}$, so the power density limit shall be reduced to $8-(8.77-6) = 5.23\text{dBm}$.
- Refer to section 3.3 for duty cycle spectrum plot.



A D T

SPECTRUM PLOT OF WORST VALUE

802.11b

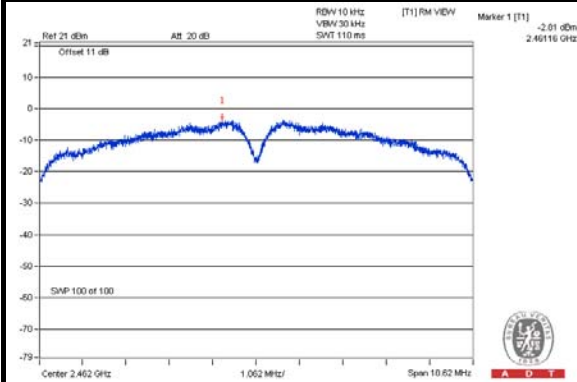

802.11g

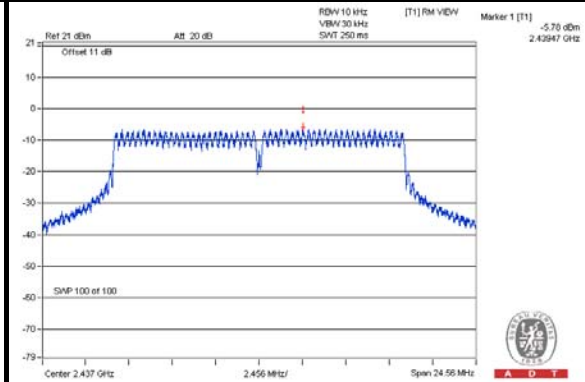

802.11n (20MHz)

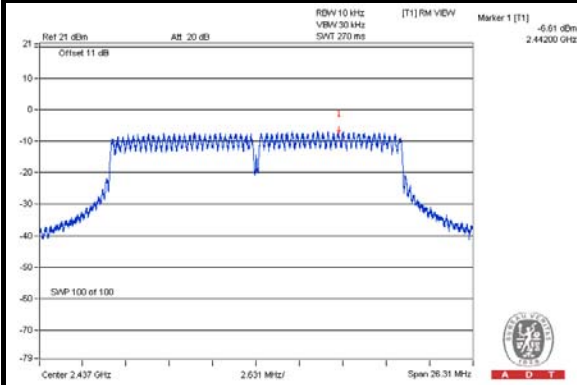

802.11n (40MHz)

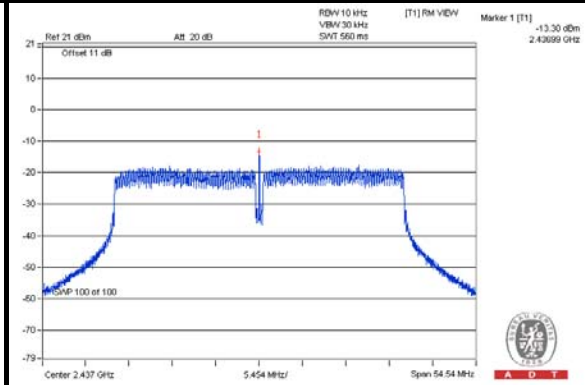

4.6 CONDUCTED OUT OF BAND EMISSION MEASUREMENT

4.6.1 LIMITS OF CONDUCTED OUT OF BAND EMISSION MEASUREMENT

Below -30dB of the highest emission level of operating band (in 100kHz Resolution Bandwidth).

4.6.2 TEST SETUP

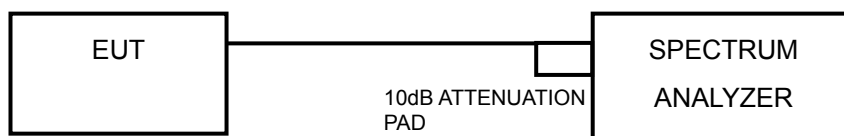

4.6.3 TEST INSTRUMENTS

Refer to section 4.1.2 to get information of above instrument.

4.6.4 TEST PROCEDURE

MEASUREMENT PROCEDURE REF

1. Set the RBW = 100 kHz.
2. Set the VBW \geq 300 kHz.
3. Detector = average.
4. Sweep time = auto couple.
5. Trace mode = max hold.
6. Allow trace to fully stabilize.
7. Use the peak marker function to determine the maximum power level in any 100 kHz band segment within the fundamental EBW.

MEASUREMENT PROCEDURE OOB

1. Set RBW = 100 kHz.
2. Set VBW \geq 300 kHz.
3. Detector = average.
4. Sweep = auto couple.
5. Trace Mode = max hold.
6. Allow trace to fully stabilize.
7. Use the peak marker function to determine the maximum amplitude level.

4.6.5 DEVIATION FROM TEST STANDARD

No deviation.

4.6.6 EUT OPERATING CONDITION

Same as Item 4.3.6

4.6.7 TEST RESULTS

The conducted emission test is performed on each TX port of operating mode without summing or adding $10\log(N)$ since the limit is relative emission limit. Only worst data of each operating mode is presented.

The spectrum plots are attached on the following pages. D1 line indicates the highest level, and D2 line indicates the 30dB offset below D1. It shows compliance with the requirement.



A D T

802.11b: CHAIN 0

CH 1

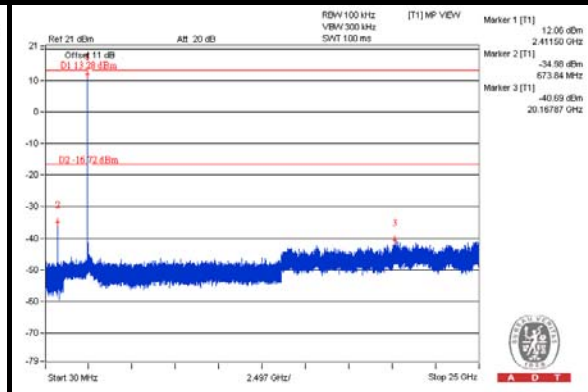
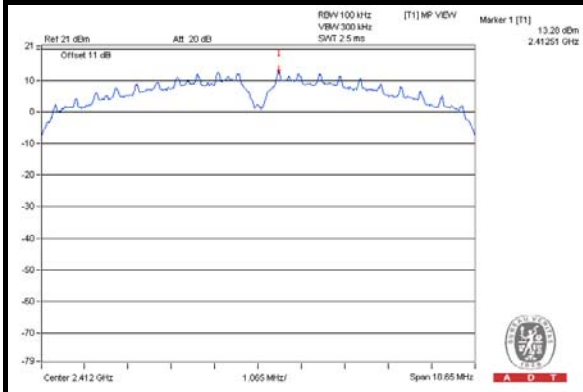

CH 6

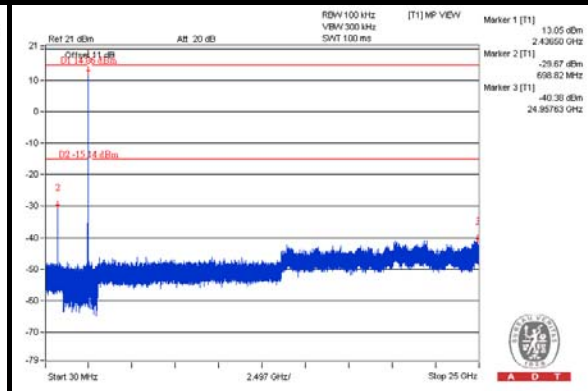
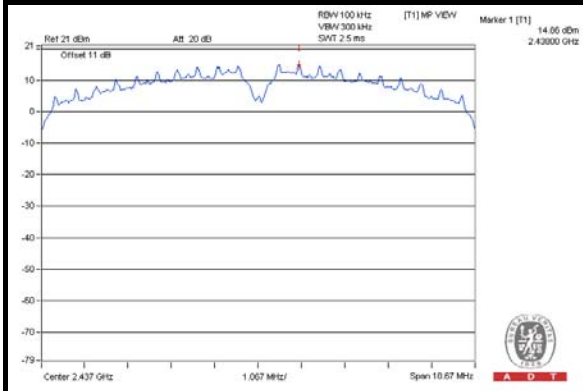

CH 11

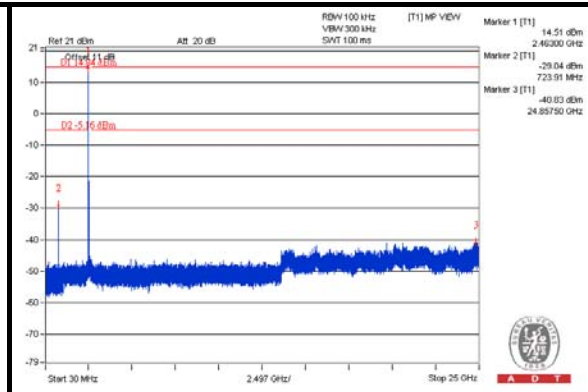
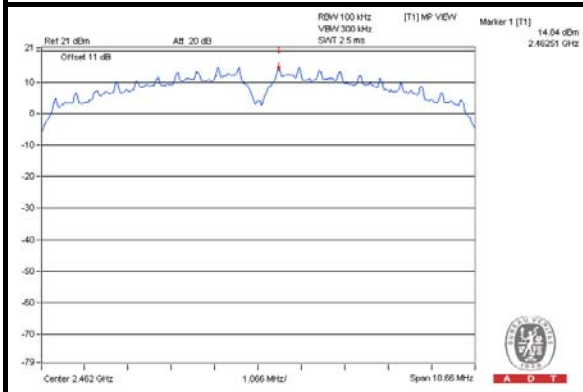

CH 1 Band edge

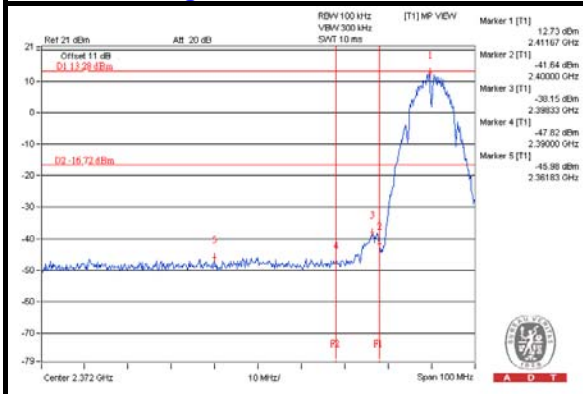

CH 11 Band edge

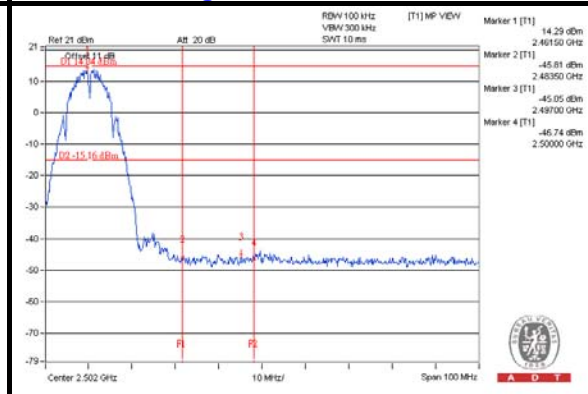



A D T

CHAIN 1

CH 1

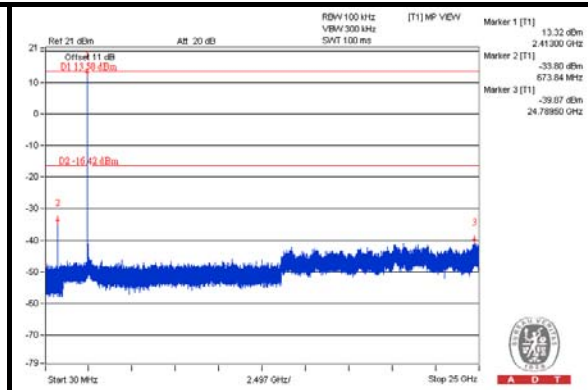
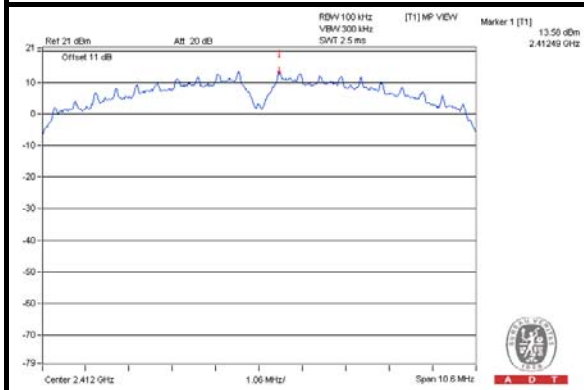

CH 6

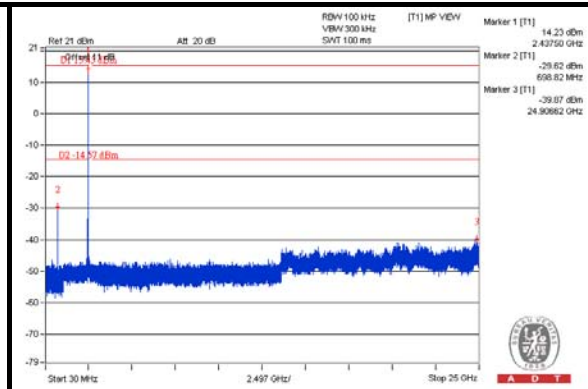
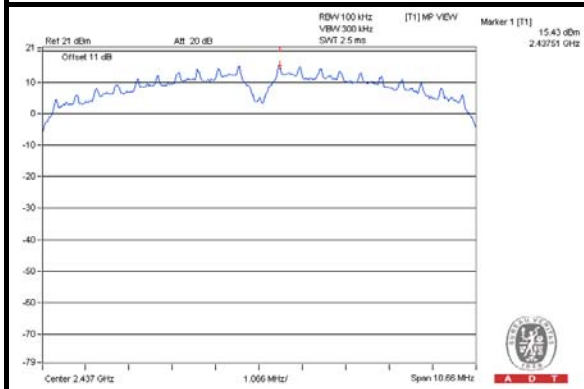

CH 11

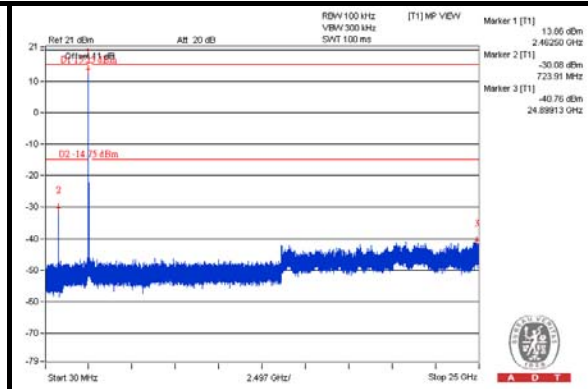
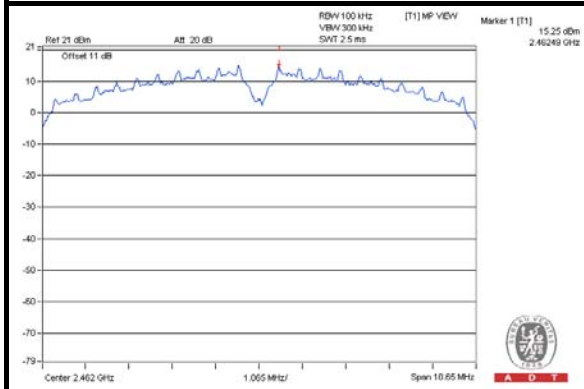

CH 1 Band edge

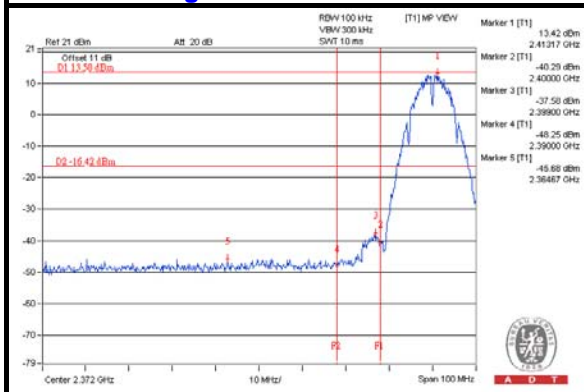

CH 11 Band edge

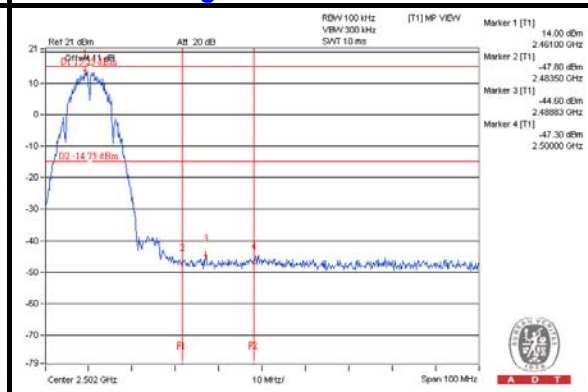



A D T

CHAIN 2

CH 1

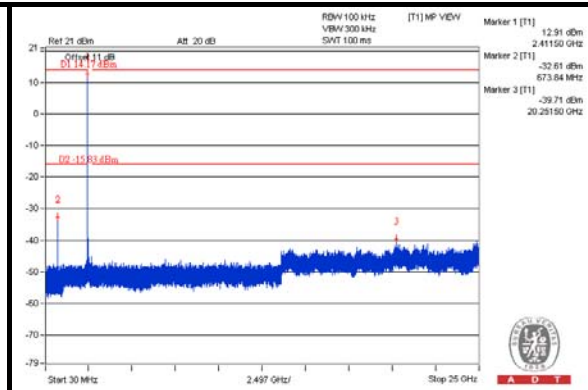
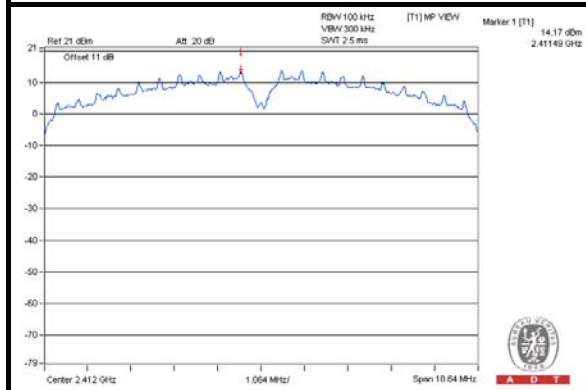

CH 6

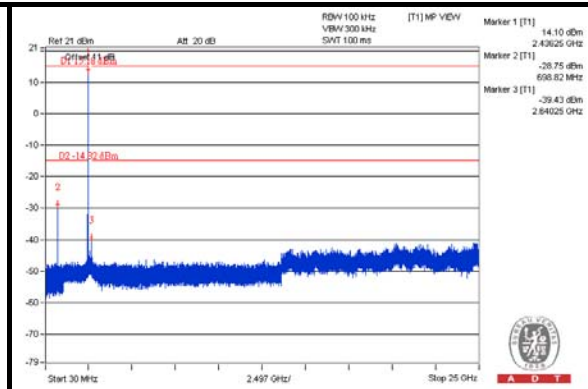
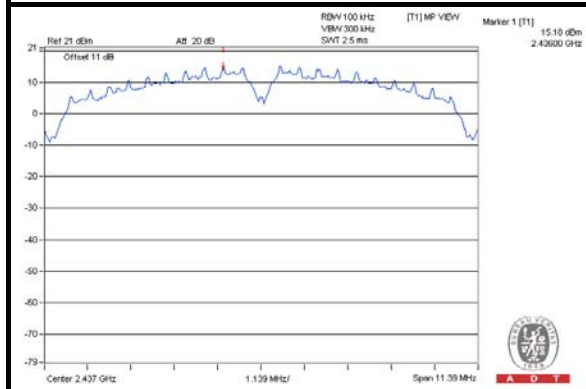

CH 11

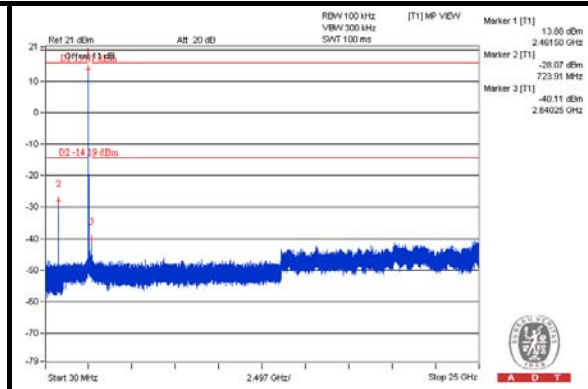
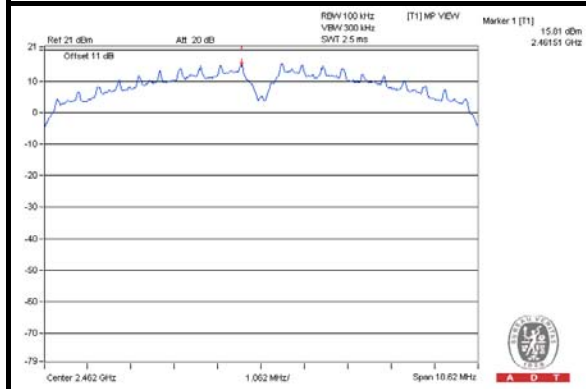

CH 1 Band edge

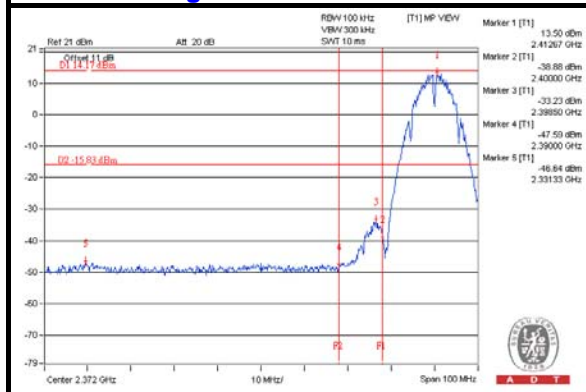

CH 11 Band edge

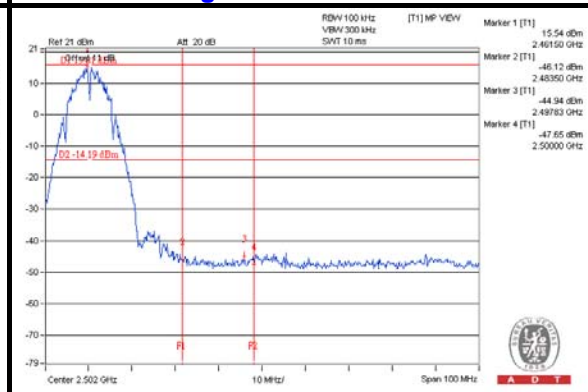



A D T

802.11g: CHAIN 0

CH 1

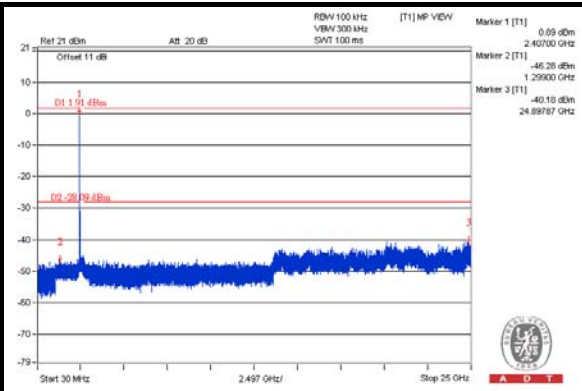
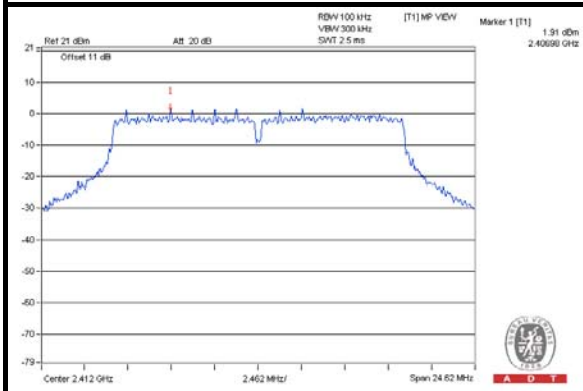

CH 6

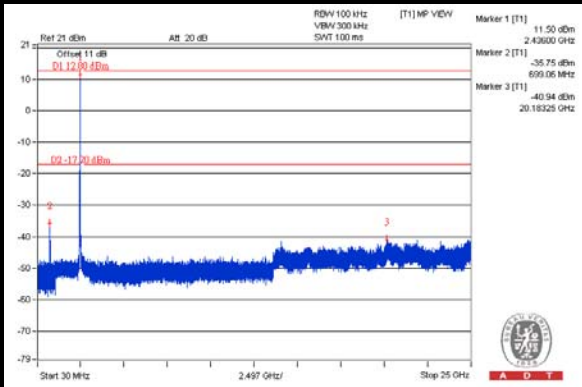
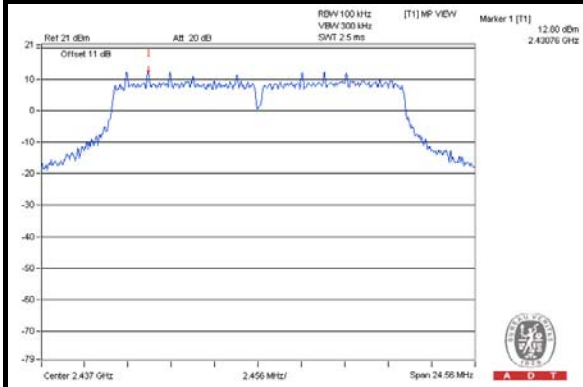

CH 11

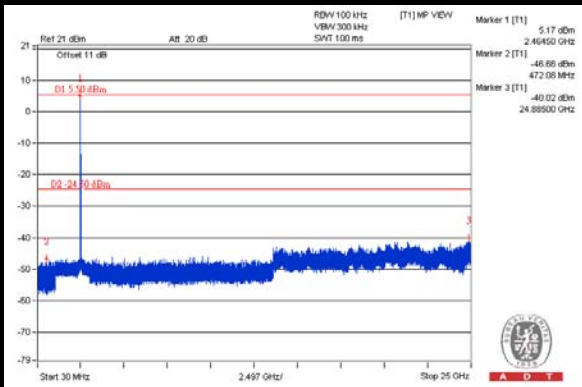
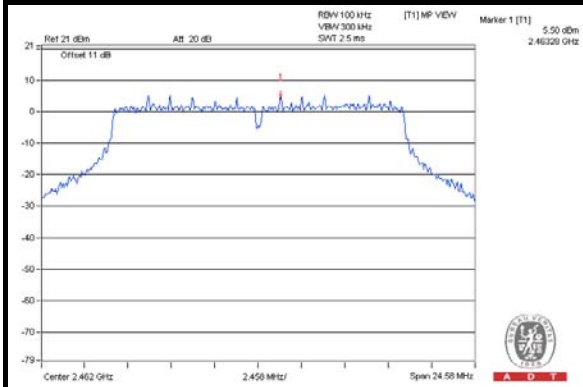

CH 11 Band edge

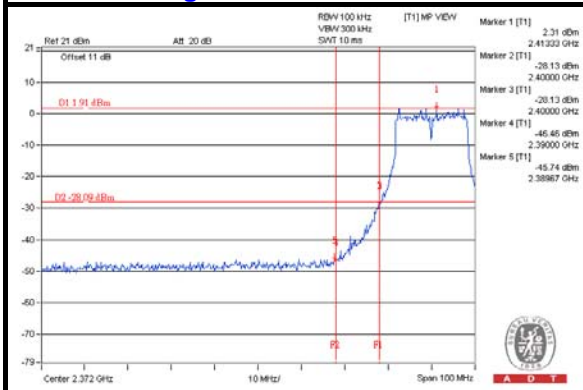

CH 11 Band edge

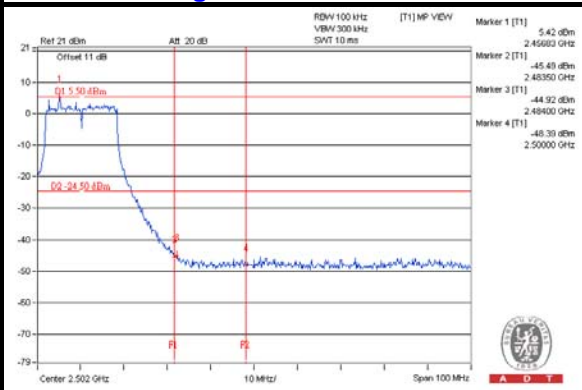



A D T

CHAIN 1

CH 1

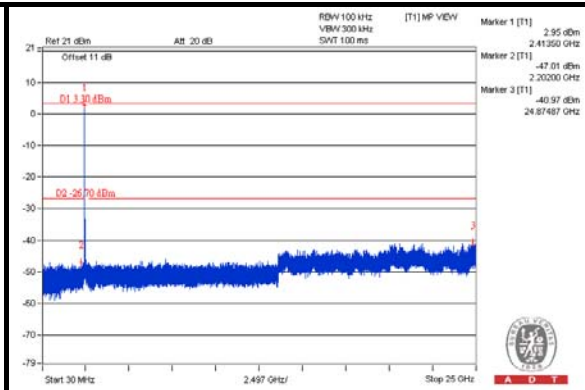
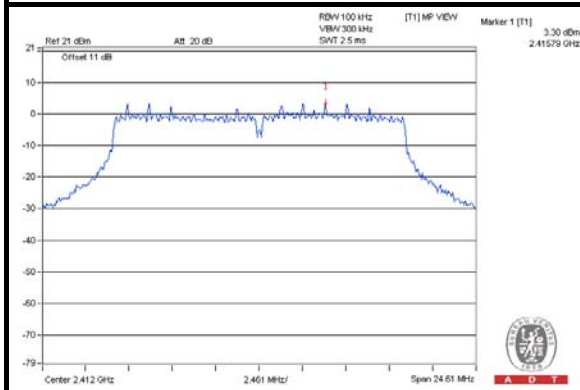

CH 6

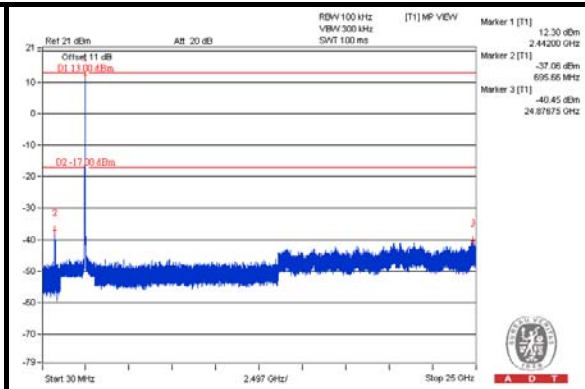
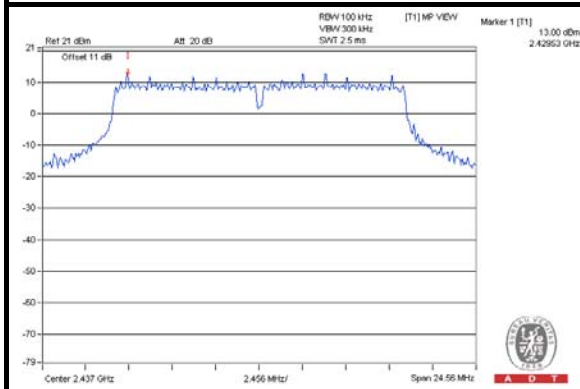

CH 11

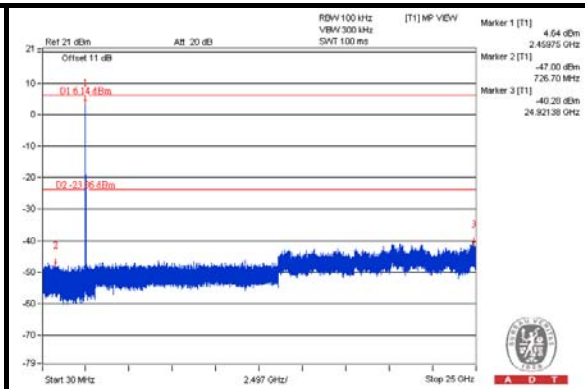
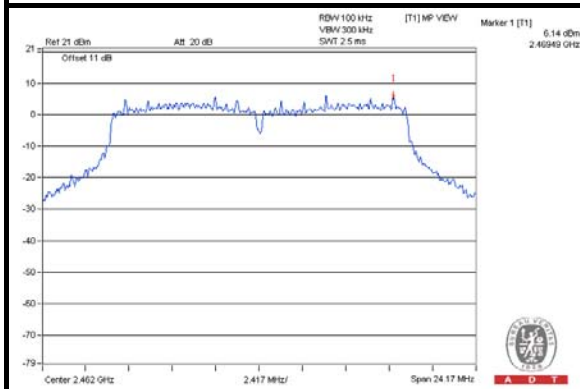

CH 1 Band edge

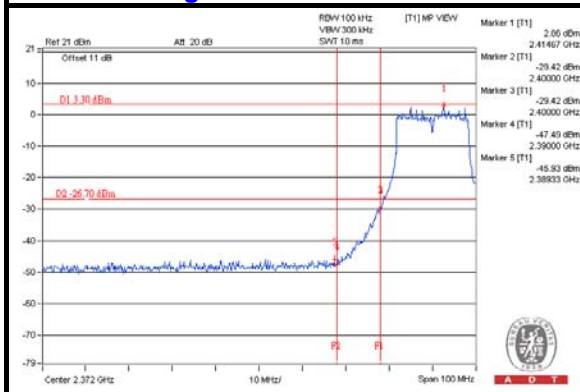

CH 11 Band edge

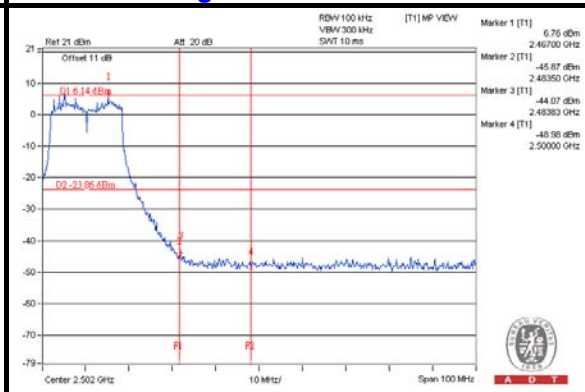

CHAIN 2

CH 1

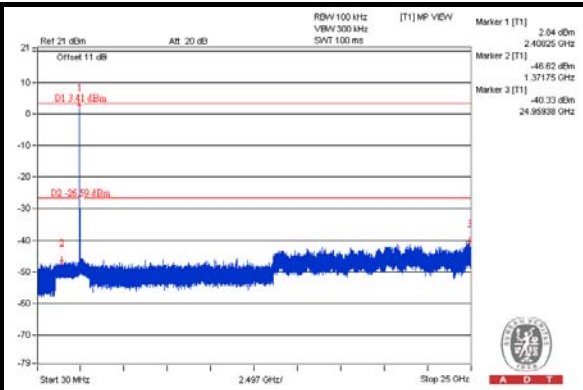
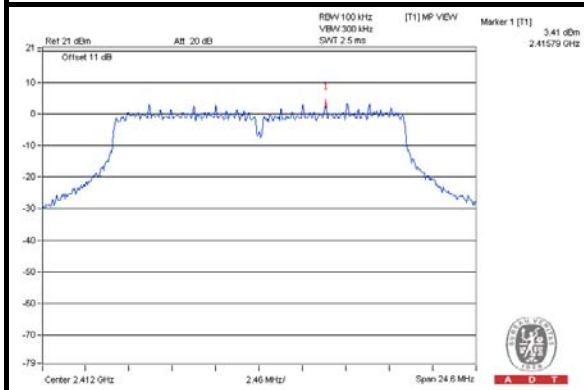

CH 6

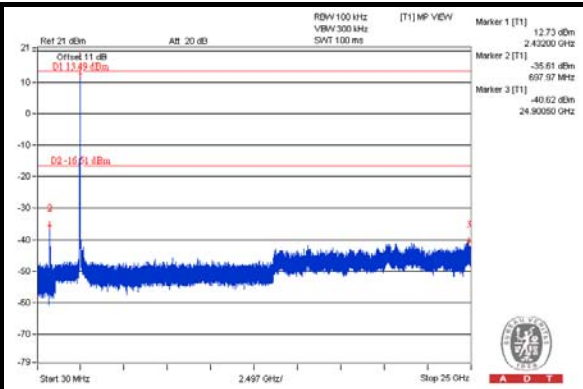
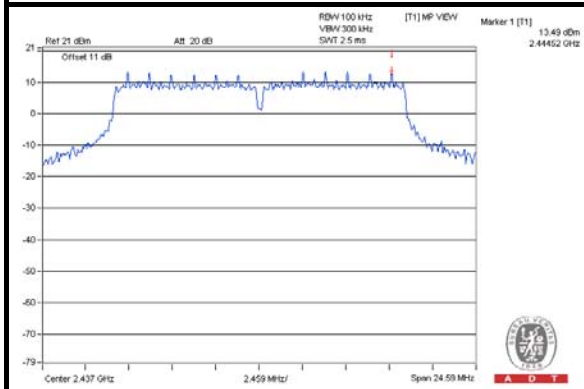

CH 11

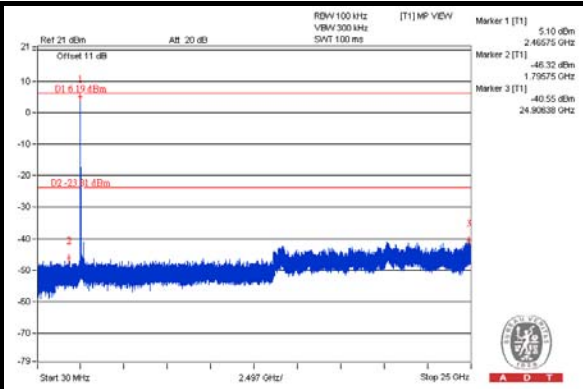
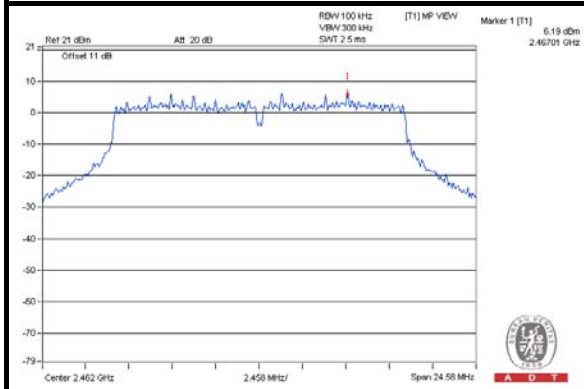

CH 1 Band edge

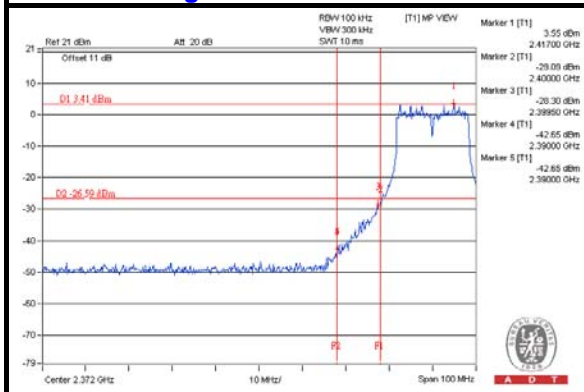

CH 11 Band edge

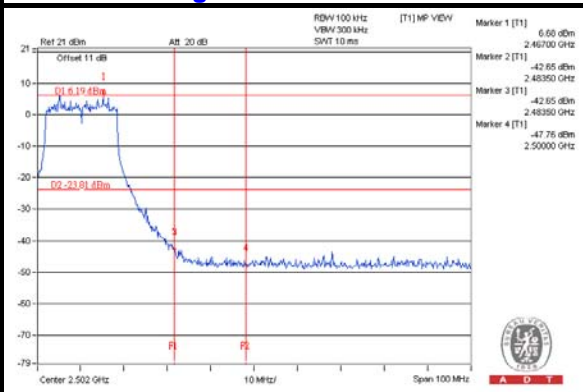



A D T

802.11n (20MHz): CHAIN 0

CH 1

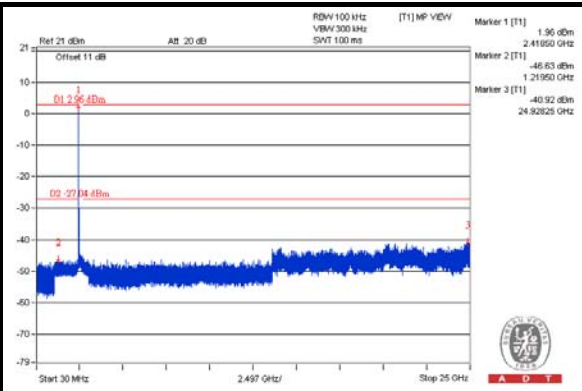
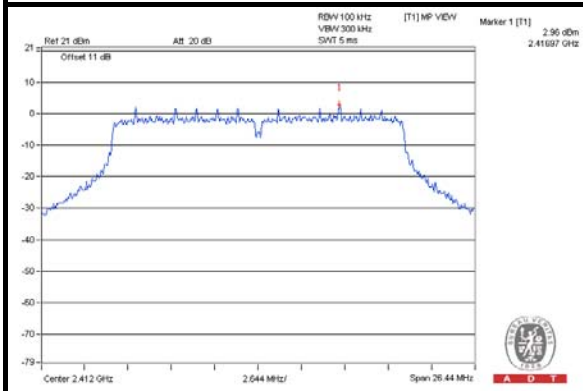

CH 6

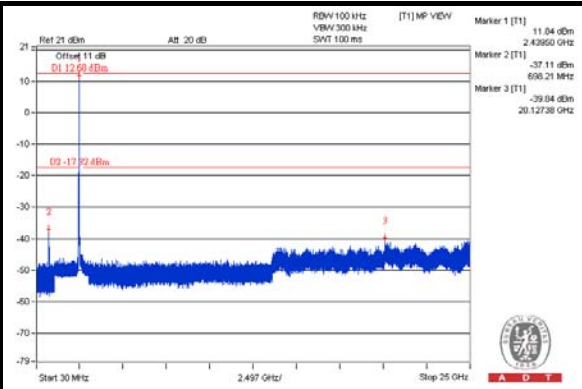
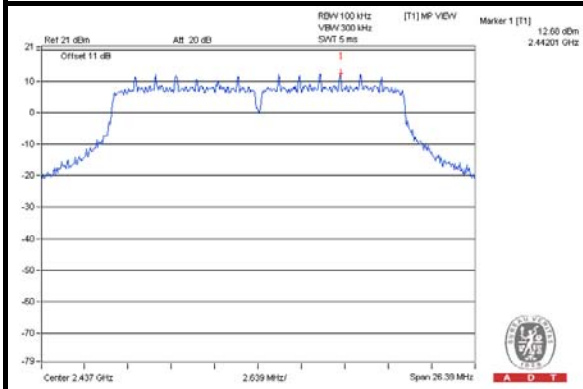

CH 11

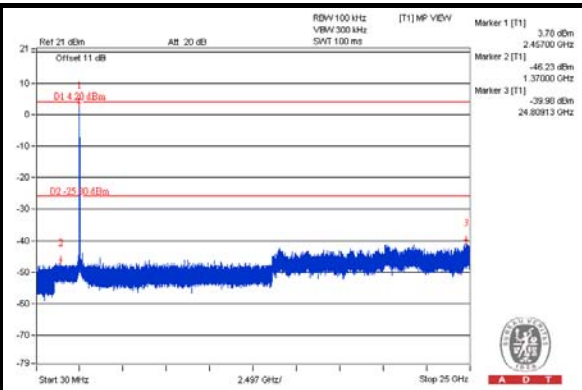
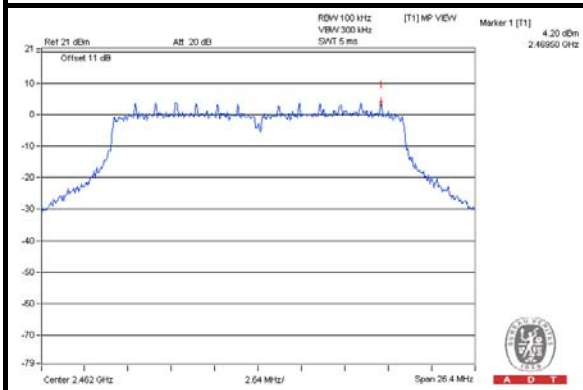

CH 1 Band edge

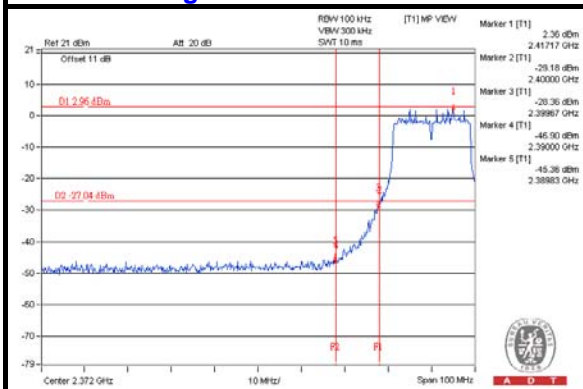

CH 11 Band edge

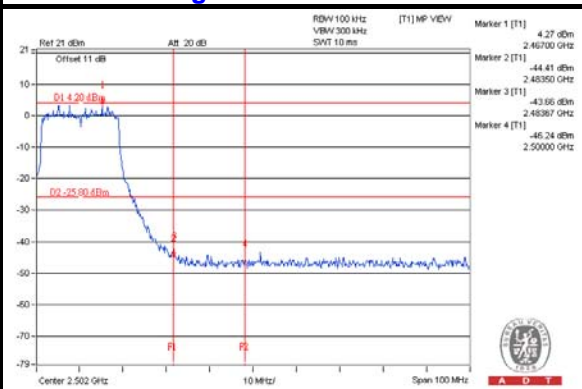

CHAIN 1

CH 1

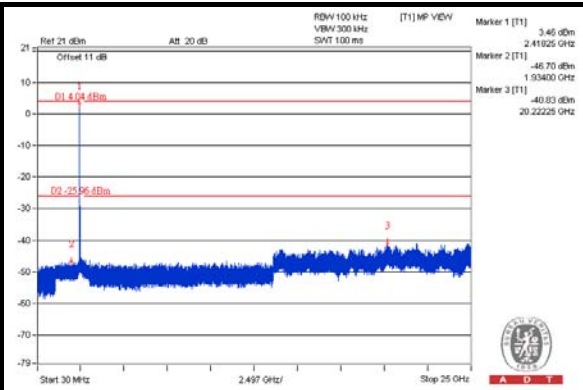
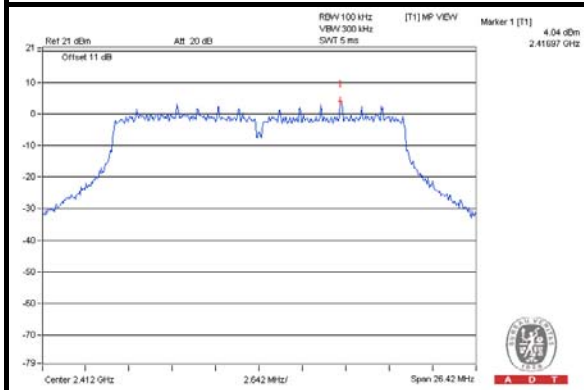

CH 6

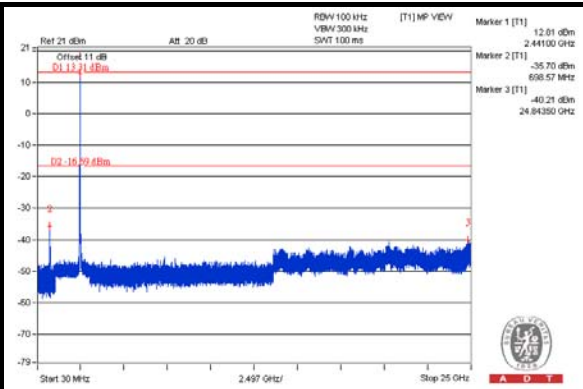
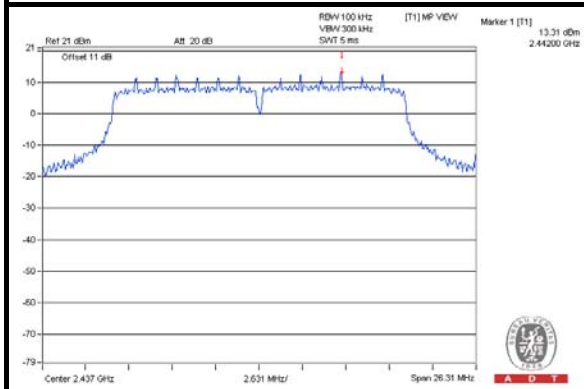

CH 11

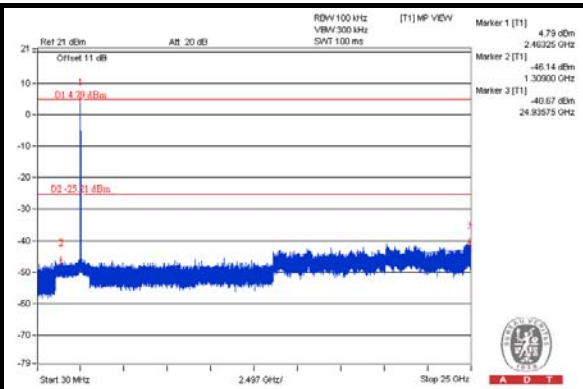
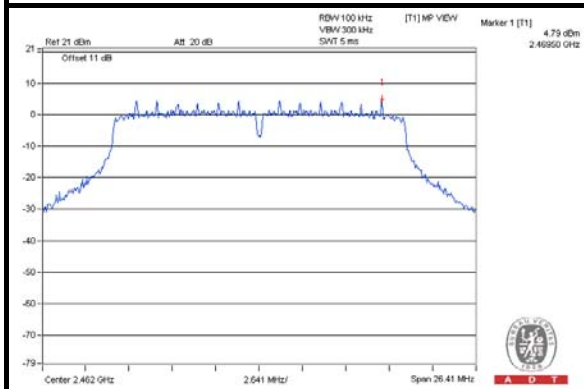

CH 1 Band edge

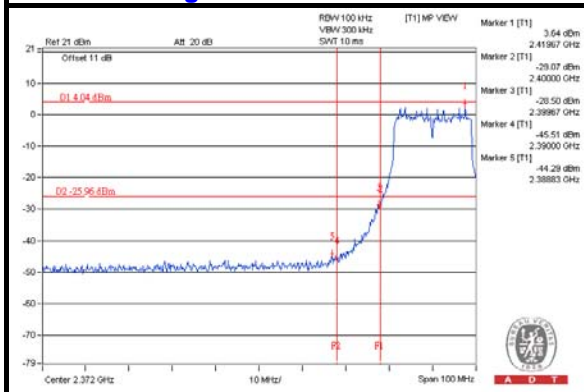

CH 11 Band edge

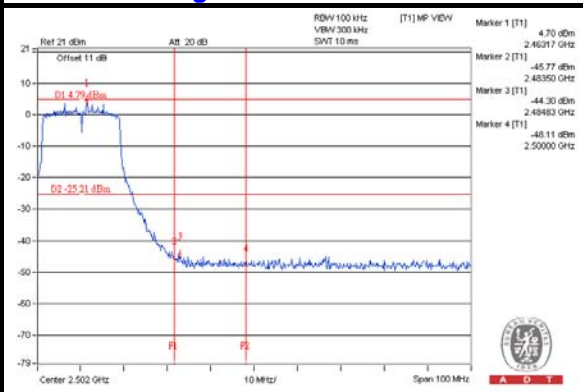

CHAIN 2

CH 1

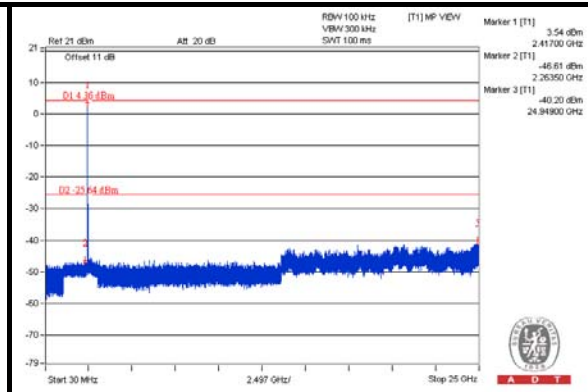
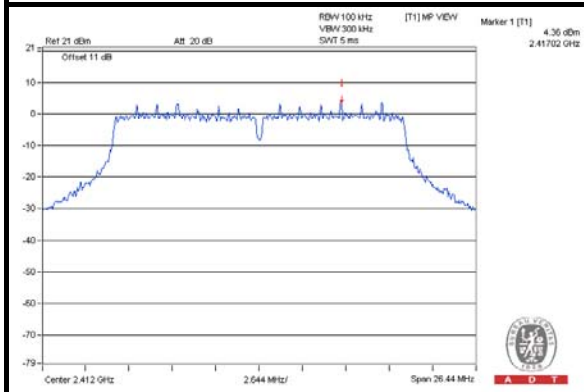

CH 6

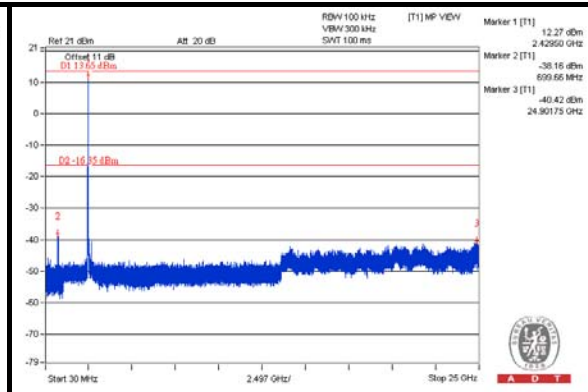
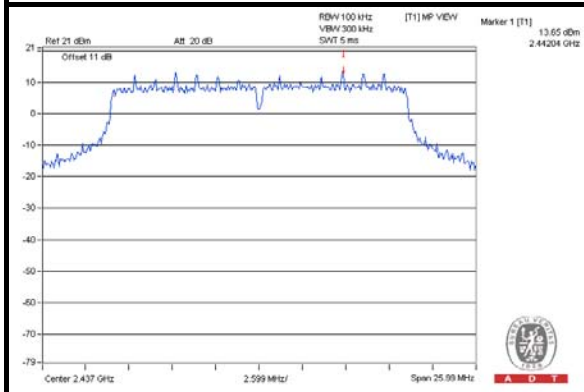

CH 11

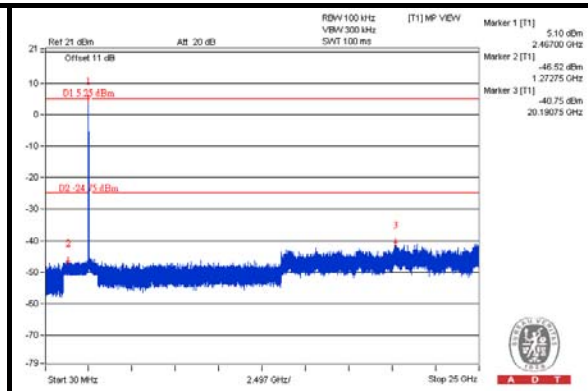
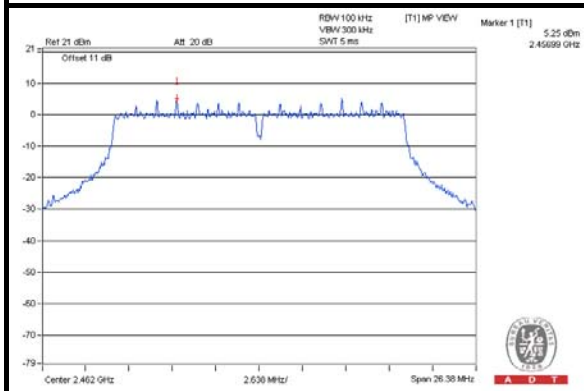

CH 1 Band edge

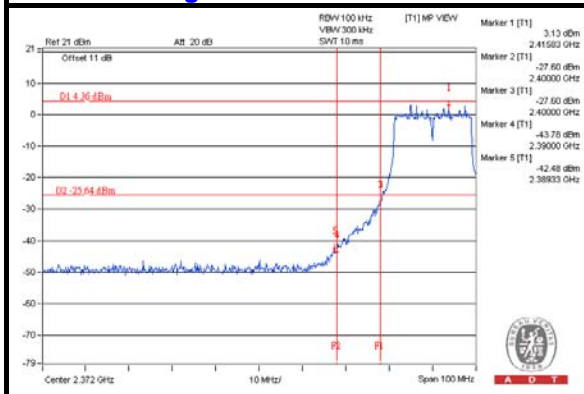

CH 11 Band edge

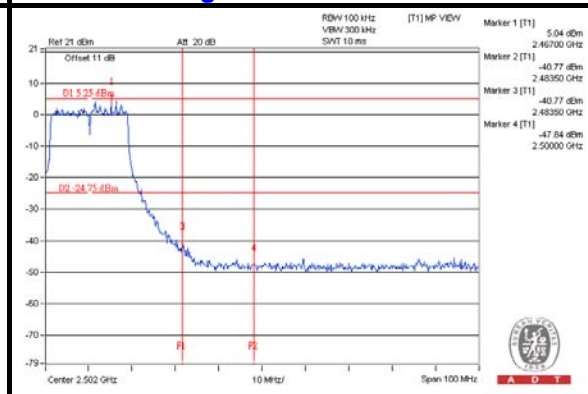



A D T

802.11n (40MHz): CHAIN 0

CH 3

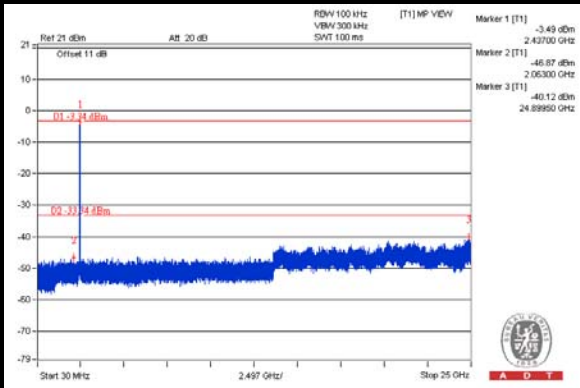
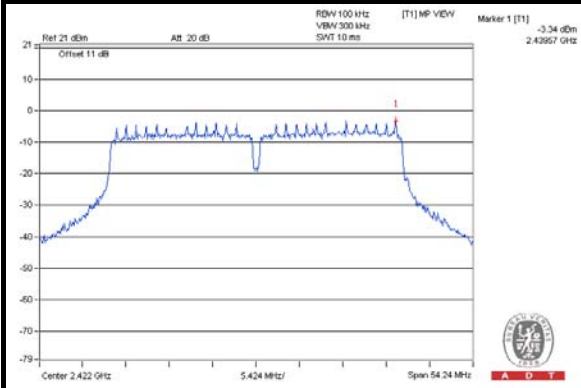

CH 6

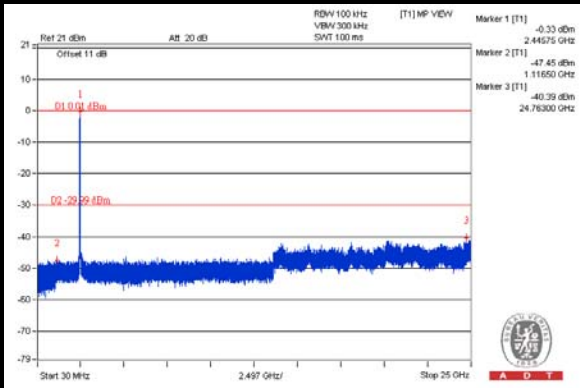
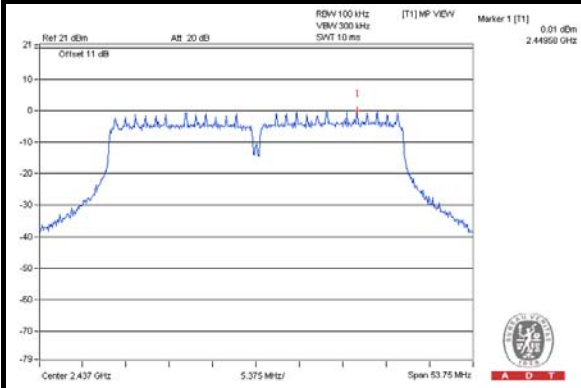

CH 9

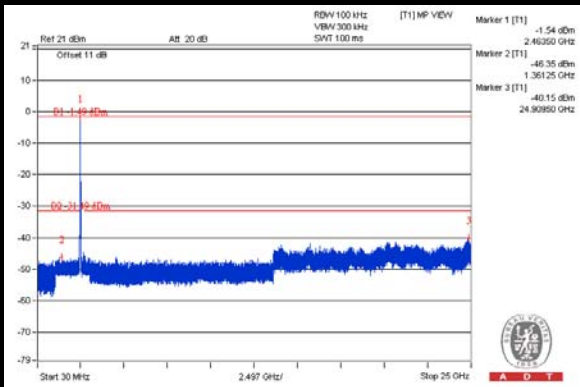
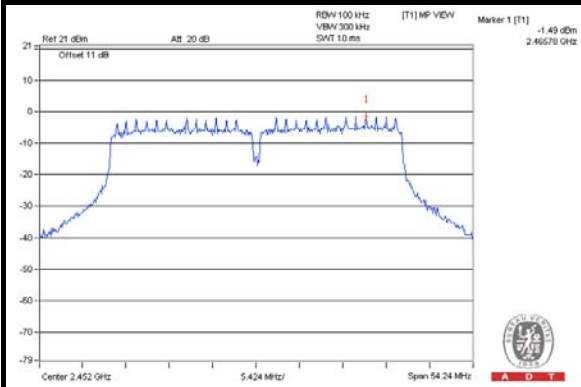

CH 3 Band edge

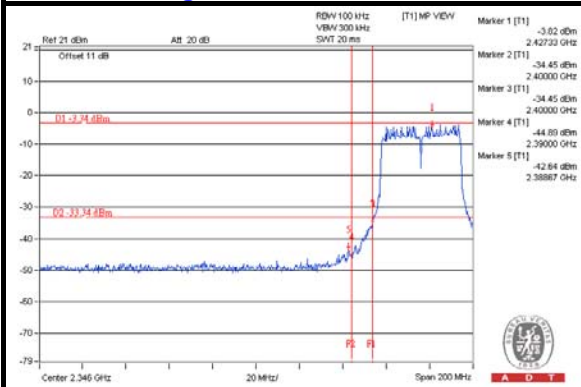

CH 9 Band edge

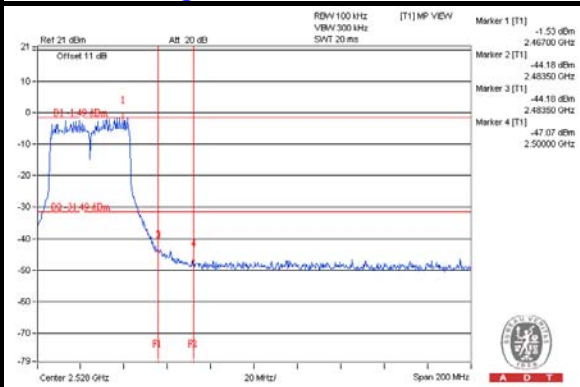

CHAIN 1

CH 3

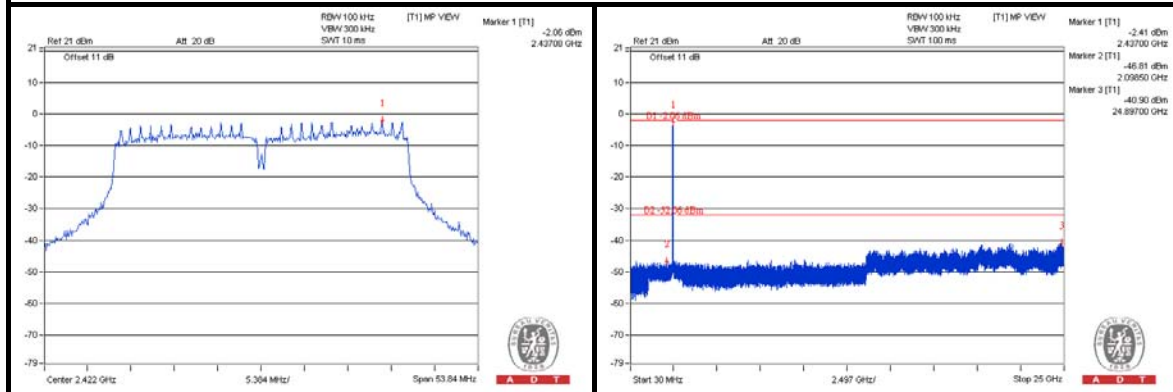

CH 6

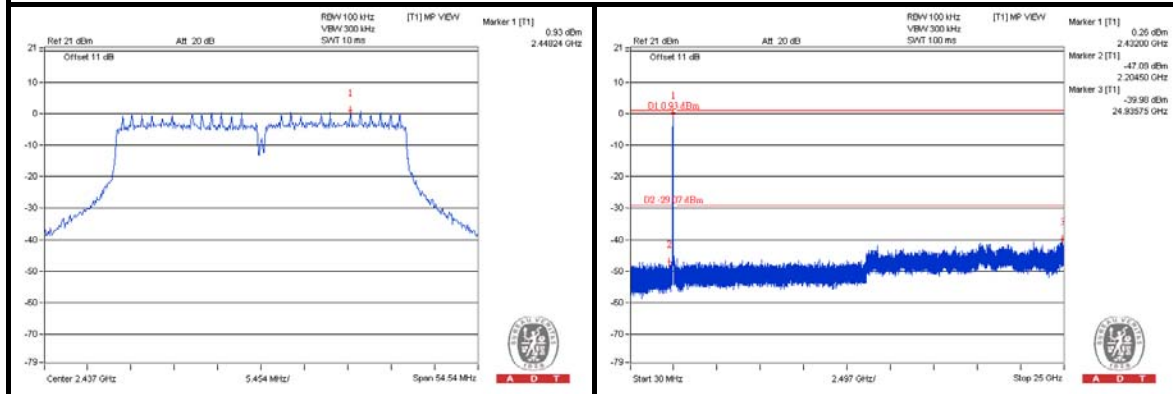

CH 9

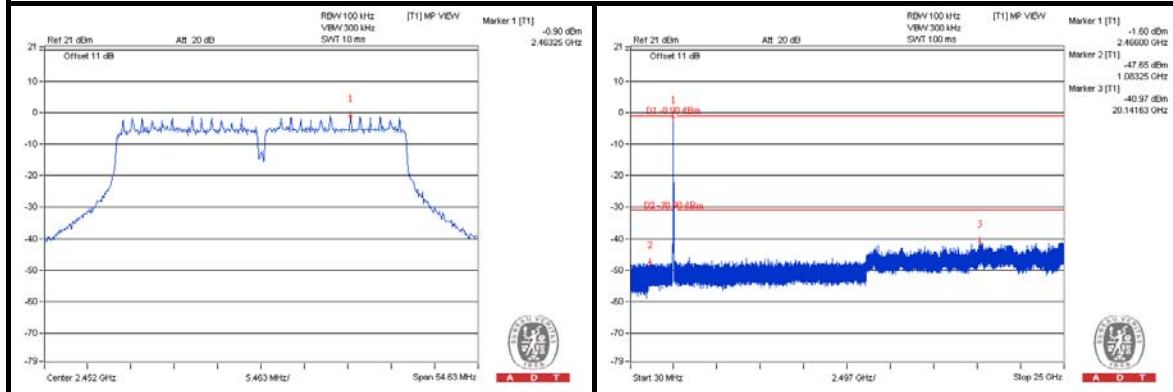

CH 3 Band edge

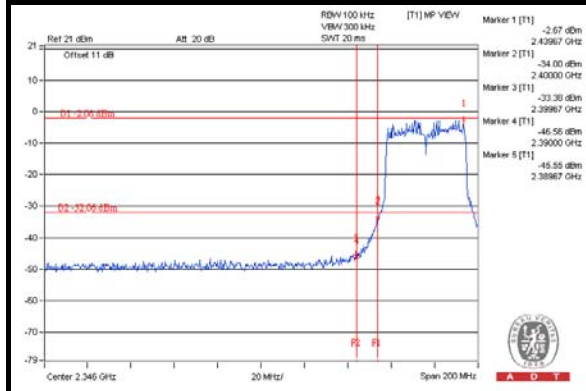

CH 9 Band edge

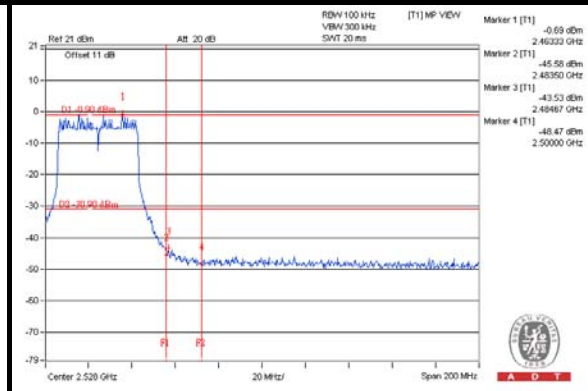



A D T

CHAIN 2

CH 3

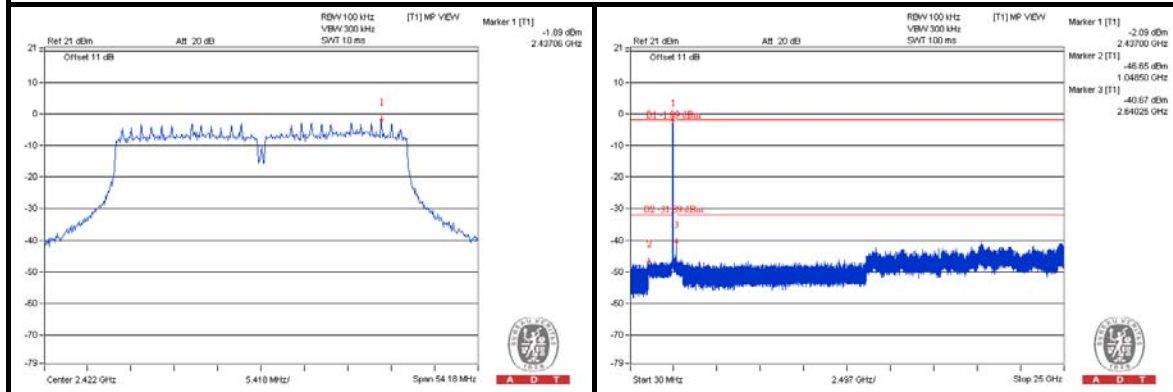

CH 6

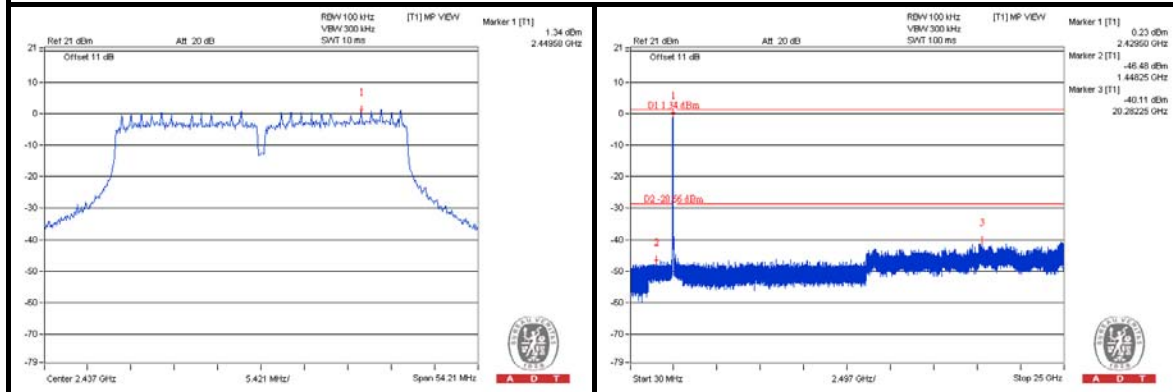

CH 9

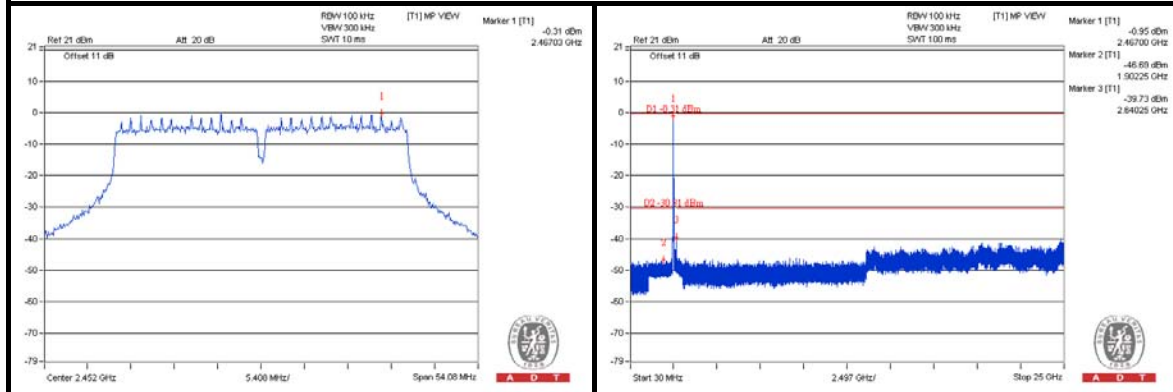

CH 3 Band edge

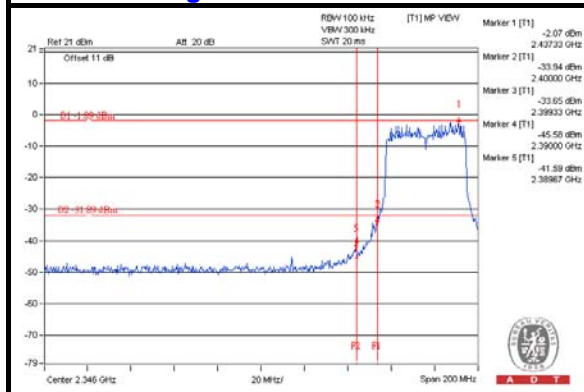

CH 9 Band edge

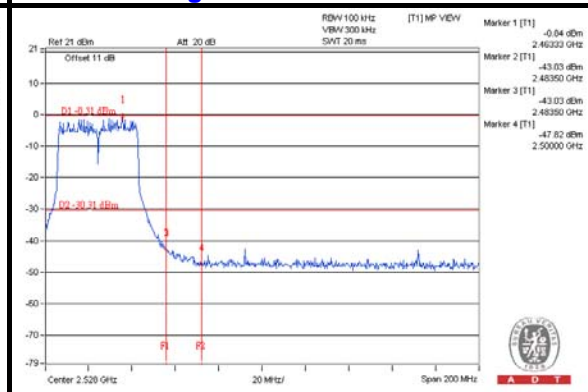



A D T

5. PHOTOGRAPHS OF THE TEST CONFIGURATION

Please refer to the attached file (Test Setup Photo).



6. INFORMATION ON THE TESTING LABORATORIES

We, Bureau Veritas Consumer Products Services (H.K.) Ltd., Taoyuan Branch, were founded in 1988 to provide our best service in EMC, Radio, Telecom and Safety consultation. Our laboratories are accredited and approved according to ISO/IEC 17025.

If you have any comments, please feel free to contact us at the following:

Linko EMC/RF Lab:

Tel: 886-2-26052180

Fax: 886-2-26051924

Hsin Chu EMC/RF Lab:

Tel: 886-3-5935343

Fax: 886-3-5935342

Hwa Ya EMC/RF/Safety Telecom Lab:

Tel: 886-3-3183232

Fax: 886-3-3270892

Email: service.adt@tw.bureauveritas.com

Web Site: www.bureauveritas-adt.com

The address and road map of all our labs can be found in our web site also.



A D T

7. APPENDIX A - MODIFICATIONS RECORDERS FOR ENGINEERING CHANGES TO THE EUT BY THE LAB

No any modifications were made to the EUT by the lab during the test.

---END---