

FCC Test Report

Report No.: RF150313C04

FCC ID: A8JEDS6115

Test Model: EDS6115

Series Model: IPC6115, WLC-3000 v1 001

Received Date: Mar. 09, 2015

Test Date: Mar. 19 ~ Apr. 13, 2015

Issued Date: Apr. 24, 2015

Applicant: EnGenius Technologies

Address: 1580 Scenic Avenue, Costa Mesa, CA92626

Issued By: Bureau Veritas Consumer Products Services (H.K.) Ltd., Taoyuan Branch

Lab Address: No. 47-2, 14th Ling, Chia Pau Vil., Lin Kou Dist., New Taipei City, Taiwan (R.O.C.)

Test Location: No.19, Hwa Ya 2nd Rd., Wen Hwa Vil., Kwei Shan Dist., Taoyuan City 33383, TAIWAN (R.O.C.)



This report is for your exclusive use. Any copying or replication of this report to or for any other person or entity, or use of our name or trademark, is permitted only with our prior written permission. This report sets forth our findings solely with respect to the test samples identified herein. The results set forth in this report are not indicative or representative of the quality or characteristics of the lot from which a test sample was taken or any similar or identical product unless specifically and expressly noted. Our report includes all of the tests requested by you and the results thereof based upon the information that you provided to us. You have 60 days from date of issuance of this report to notify us of any material error or omission caused by our negligence, provided, however, that such notice shall be in writing and shall specifically address the issue you wish to raise. A failure to raise such issue within the prescribed time shall constitute your unqualified acceptance of the completeness of this report, the tests conducted and the correctness of the report contents. Unless specific mention, the uncertainty of measurement has been explicitly taken into account to declare the compliance or non-compliance to the specification. The report must not be used by the client to claim product certification, approval, or endorsement by TAF or any government agencies.



Table of Contents

Release Control Record	4
1 Certificate of Conformity	5
2 Summary of Test Results	6
2.1 Measurement Uncertainty.....	6
2.2 Modification Record.....	6
3 General Information	7
3.1 General Description of EUT.....	7
3.2 Description of Test Modes.....	8
3.2.1 Test Mode Applicability and Tested Channel Detail.....	9
3.3 Duty Cycle of Test Signal.....	11
3.4 Description of Support Units.....	12
3.4.1 Configuration of System under Test.....	12
3.5 General Description of Applied Standards.....	14
4 Test Types and Results	15
4.1 Radiated Emission and Bandedge Measurement.....	15
4.1.1 Limits of Radiated Emission and Bandedge Measurement.....	15
4.1.2 Test Instruments.....	16
4.1.3 Test Procedures.....	17
4.1.4 Deviation from Test Standard.....	17
4.1.5 Test Set Up.....	18
4.1.6 EUT Operating Conditions.....	18
4.1.7 Test Results.....	19
4.2 Conducted Emission Measurement.....	33
4.2.1 Limits of Conducted Emission Measurement.....	33
4.2.2 Test Instruments.....	33
4.2.3 Test Procedures.....	33
4.2.4 Deviation from Test Standard.....	34
4.2.5 Test Setup.....	34
4.2.6 EUT Operating Conditions.....	34
4.2.7 Test Results.....	35
4.3 6dB Bandwidth Measurement.....	39
4.3.1 Limits of 6dB Bandwidth Measurement.....	39
4.3.2 Test Setup.....	39
4.3.3 Test Instruments.....	39
4.3.4 Test Procedure.....	39
4.3.5 Deviation from Test Standard.....	39
4.3.6 EUT Operating Conditions.....	39
4.3.7 Test Result.....	40
4.4 Conducted Output Power Measurement.....	42
4.4.1 Limits of Conducted Output Power Measurement.....	42
4.4.2 Test Setup.....	42
4.4.3 Test Instruments.....	42
4.4.4 Test Procedures.....	42
4.4.5 Deviation from Test Standard.....	42
4.4.6 EUT Operating Conditions.....	42
4.4.7 Test Results.....	43
4.5 Power Spectral Density Measurement.....	44
4.5.1 Limits of Power Spectral Density Measurement.....	44
4.5.2 Test Setup.....	44
4.5.3 Test Instruments.....	44
4.5.4 Test Procedure.....	44
4.5.5 Deviation from Test Standard.....	44
4.5.6 EUT Operating Condition.....	44



4.5.7 Test Results	45
4.6 Conducted Out of Band Emission Measurement.....	47
4.6.1 Limits of Conducted Out of Band Emission Measurement	47
4.6.2 Test Setup.....	47
4.6.3 Test Instruments	47
4.6.4 Test Procedure	47
4.6.5 Deviation from Test Standard	47
4.6.6 EUT Operating Condition	47
4.6.7 Test Results	47
5 Pictures of Test Arrangements.....	52
Appendix – Information on the Testing Laboratories	53



A D T

Release Control Record

Issue No.	Description	Date Issued
RF150313C04	Original release.	Apr. 24, 2015

1 Certificate of Conformity

Product: Megapixel Wi-Fi Dome Camera

Brand: EnGenius, Senao, Sitecom

Test Model: EDS6115

Series Model: IPC6115, WLC-3000 v1 001

Sample Status: Engineering sample

Applicant: EnGenius Technologies

Test Date: Mar. 19 ~ Apr. 13, 2015

Standards: 47 CFR FCC Part 15, Subpart C (Section 15.247)
ANSI C63.10:2009

The above equipment has been tested by **Bureau Veritas Consumer Products Services (H.K.) Ltd., Taoyuan Branch**, and found compliance with the requirement of the above standards. The test record, data evaluation & Equipment Under Test (EUT) configurations represented herein are true and accurate accounts of the measurements of the sample's EMC characteristics under the conditions specified in this report.

Prepared by :

Ivy Lin / Specialist

Date:

Apr. 24, 2015

Approved by :

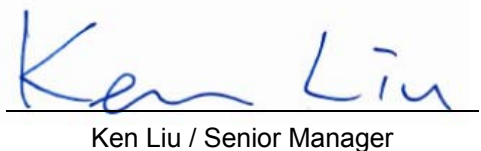
Ken Liu / Senior Manager

Date:

Apr. 24, 2015

2 Summary of Test Results

47 CFR FCC Part 15, Subpart C (SECTION 15.247)			
FCC Clause	Test Item	Result	Remarks
15.207	AC Power Conducted Emission	PASS	Meet the requirement of limit. Minimum passing margin is -3.49dB at 0.52544MHz.
15.205 / 15.209 / 15.247(d)	Radiated Emissions and Band Edge Measurement	PASS	Meet the requirement of limit. Minimum passing margin is -1.0dB at 4924.00MHz, 607.52MHz.
15.247(d)	Antenna Port Emission	PASS	Meet the requirement of limit.
15.247(a)(2)	6dB bandwidth	PASS	Meet the requirement of limit.
15.247(b)	Conducted power	PASS	Meet the requirement of limit.
15.247(e)	Power Spectral Density	PASS	Meet the requirement of limit.
15.203	Antenna Requirement	PASS	Antenna connector is IPEX not a standard connector.

2.1 Measurement Uncertainty

Where relevant, the following measurement uncertainty levels have been estimated for tests performed on the EUT as specified in CISPR 16-4-2:

Measurement	Frequency	Expanded Uncertainty (k=2) (±)
Conducted Emissions at mains ports	150kHz ~ 30MHz	2.44 dB
Radiated Emissions up to 1 GHz	30MHz ~ 200MHz	3.86 dB
	200MHz ~ 1000MHz	3.87 dB
Radiated Emissions above 1 GHz	1GHz ~ 18GHz	2.29 dB
	18GHz ~ 40GHz	2.29 dB

2.2 Modification Record

There were no modifications required for compliance.

3 General Information

3.1 General Description of EUT

Product	Megapixel Wi-Fi Dome Camera
Brand	EnGenius, Senao, Sitecom
Test Model	EDS6115
Series Model	IPC6115, WLC-3000 v1 001
Model Difference	Refer to Note
Status of EUT	Engineering sample
Power Supply Rating	12Vdc (Adapter) 48Vdc (PoE)
Modulation Type	CCK, DQPSK, DBPSK for DSSS; 64QAM, 16QAM, QPSK, BPSK for OFDM
Modulation Technology	DSSS, OFDM
Transfer Rate	802.11b: 11.0/ 5.5/ 2.0/ 1.0Mbps 802.11g: 54.0/ 48.0/ 36.0/ 24.0/ 18.0/ 12.0/ 9.0/ 6.0Mbps 802.11n: up to 150.0Mbps
Operating Frequency	2412 ~ 2462MHz
Number of Channel	11 for 802.11b, 802.11g, 802.11n (HT20) 7 for 802.11n (HT40)
Output Power	176.604mW
Antenna Type	Refer to Note
Antenna Connector	Refer to Note
Accessory Device	Adapter, PoE
Cable Supplied	0.6m non-shielded power cable with one core (attached on EUT)

Note:

1. The EUT provides one completed transmitter and one receiver.

Modulation Mode	TX Function
802.11b	1TX
802.11g	1TX
802.11n (HT20)	1TX
802.11n (HT40)	1TX

2. All models are listed as below.

Brand	Model	Difference
EnGenius	EDS6115	All models are electrically identical, different brands and model names are for marketing purpose.
Senao	IPC6115	
Sitecom	WLC-3000 v1 001	

*Model: EDS6115 is the main test model.

3. The following antennas were provided to the EUT.

Antenna Type	PIFA
Antenna Connector	IPEX
Gain (dBi)	Frequency (MHz)
	2400 - 2500
	-0.4

4. The EUT uses following adapter and PoE.

Adapter	
Brand	DVE
Model	DSA-12G-12 FUS 120120
Input Power	100-240Vac, 50/60Hz, 0.3A
Output Power	+12Vdc, 1A
Power Line	1.5m cable without core attached on adapter

PoE	
Brand	EnGenius
Model	EPE-1212
Power Rating	48Vdc, 0.38A, 18.24W Max

Adapter for PoE	
Brand	Powertron Electronics Corp.
Model	PA1024-480DEB038
Input Power	100-240Vac, 50-60Hz, 0.6A
Output Power	48Vdc, 0.38A, 18.24W Max
Power Line	1.8m non-shielded cable with one core

5. The above EUT information is declared by manufacturer and for more detailed features description, please refer to the manufacturer's specifications or user's manual.

3.2 Description of Test Modes

11 channels are provided for 802.11b, 802.11g and 802.11n (HT20):

Channel	Frequency	Channel	Frequency
1	2412MHz	7	2442MHz
2	2417MHz	8	2447MHz
3	2422MHz	9	2452MHz
4	2427MHz	10	2457MHz
5	2432MHz	11	2462MHz
6	2437MHz		

7 channels are provided for 802.11n (HT40):

Channel	Frequency	Channel	Frequency
3	2422MHz	7	2442MHz
4	2427MHz	8	2447MHz
5	2432MHz	9	2452MHz
6	2437MHz		

3.2.1 Test Mode Applicability and Tested Channel Detail

EUT CONFIGURE MODE	APPLICABLE TO				DESCRIPTION
	RE \geq 1G	RE<1G	PLC	APCM	
A	√	√	√	√	Power from adapter
B	-	√	√	-	Power from PoE

Where RE \geq 1G: Radiated Emission above 1GHz & Bandedge Measurement
 RE<1G: Radiated Emission below 1GHz
 PLC: Power Line Conducted Emission
 APCM: Antenna Port Conducted Measurement

NOTE:

- The EUT had been pre-tested on the positioned of each 3 axis. The worst case was found when positioned on **Y-plane**.
- "-" means no effect.

Radiated Emission Test (Above 1GHz):

- Pre-Scan has been conducted to determine the worst-case mode from all possible combinations between available modulations, data rates and antenna ports (if EUT with antenna diversity architecture).
- Following channel(s) was (were) selected for the final test as listed below.

EUT CONFIGURE MODE	MODE	AVAILABLE CHANNEL	TESTED CHANNEL	MODULATION TECHNOLOGY	MODULATION TYPE	DATA RATE (Mbps)
A	802.11b	1 to 11	1, 6, 11	DSSS	DBPSK	1.0
A	802.11g	1 to 11	1, 6, 11	OFDM	BPSK	6.0
A	802.11n (HT20)	1 to 11	1, 6, 11	OFDM	BPSK	6.5
A	802.11n (HT40)	3 to 9	3, 6, 9	OFDM	BPSK	13.5

Radiated Emission Test (Below 1GHz):

- Pre-Scan has been conducted to determine the worst-case mode from all possible combinations between available modulations, data rates and antenna ports (if EUT with antenna diversity architecture).
- Following channel(s) was (were) selected for the final test as listed below.

EUT CONFIGURE MODE	MODE	AVAILABLE CHANNEL	TESTED CHANNEL	MODULATION TECHNOLOGY	MODULATION TYPE	DATA RATE (Mbps)
A, B	802.11g	1 to 11	6	OFDM	BPSK	6.0

Power Line Conducted Emission Test:

- Pre-Scan has been conducted to determine the worst-case mode from all possible combinations between available modulations, data rates and antenna ports (if EUT with antenna diversity architecture).
- Following channel(s) was (were) selected for the final test as listed below.

EUT CONFIGURE MODE	MODE	AVAILABLE CHANNEL	TESTED CHANNEL	MODULATION TECHNOLOGY	MODULATION TYPE	DATA RATE (Mbps)
A, B	802.11g	1 to 11	6	OFDM	BPSK	6.0

Antenna Port Conducted Measurement:

- This item includes all test value of each mode, but only includes spectrum plot of worst value of each mode.
- Pre-Scan has been conducted to determine the worst-case mode from all possible combinations between available modulations, data rates and antenna ports (if EUT with antenna diversity architecture).
- Following channel(s) was (were) selected for the final test as listed below.

EUT CONFIGURE MODE	MODE	AVAILABLE CHANNEL	TESTED CHANNEL	MODULATION TECHNOLOGY	MODULATION TYPE	DATA RATE (Mbps)
A	802.11b	1 to 11	1, 6, 11	DSSS	DBPSK	1.0
A	802.11g	1 to 11	1, 6, 11	OFDM	BPSK	6.0
A	802.11n (HT20)	1 to 11	1, 6, 11	OFDM	BPSK	6.5
A	802.11n (HT40)	3 to 9	3, 6, 9	OFDM	BPSK	13.5

Test Condition:

APPLICABLE TO	ENVIRONMENTAL CONDITIONS	INPUT POWER	TESTED BY
RE \geq 1G	21deg. C, 63%RH	120Vac, 60Hz	Nick Hsu, Jones Chang
RE $<$ 1G	18deg. C, 70%RH	120Vac, 60Hz	Nick Hsu
PLC	22deg. C, 70%RH	120Vac, 60Hz	Jones Chang
APCM	21deg. C, 60%RH	120Vac, 60Hz	Leo Tsai

3.3 Duty Cycle of Test Signal

If duty cycle of test signal is $\geq 98\%$, duty factor is not required.

802.11b: Duty cycle $\geq 98\%$

If duty cycle of test signal is $< 98\%$, duty factor shall be considered.

802.11g: Duty cycle = $1.438/1.660 = 0.866$, Duty factor = $10 * \log(1/0.866) = 0.62$

802.11n (HT20): Duty cycle = $1.344/1.564 = 0.859$, Duty factor = $10 * \log(1/0.859) = 0.66$

802.11n (HT40): Duty cycle = $0.662/0.867 = 0.764$, Duty factor = $10 * \log(1/0.764) = 1.17$

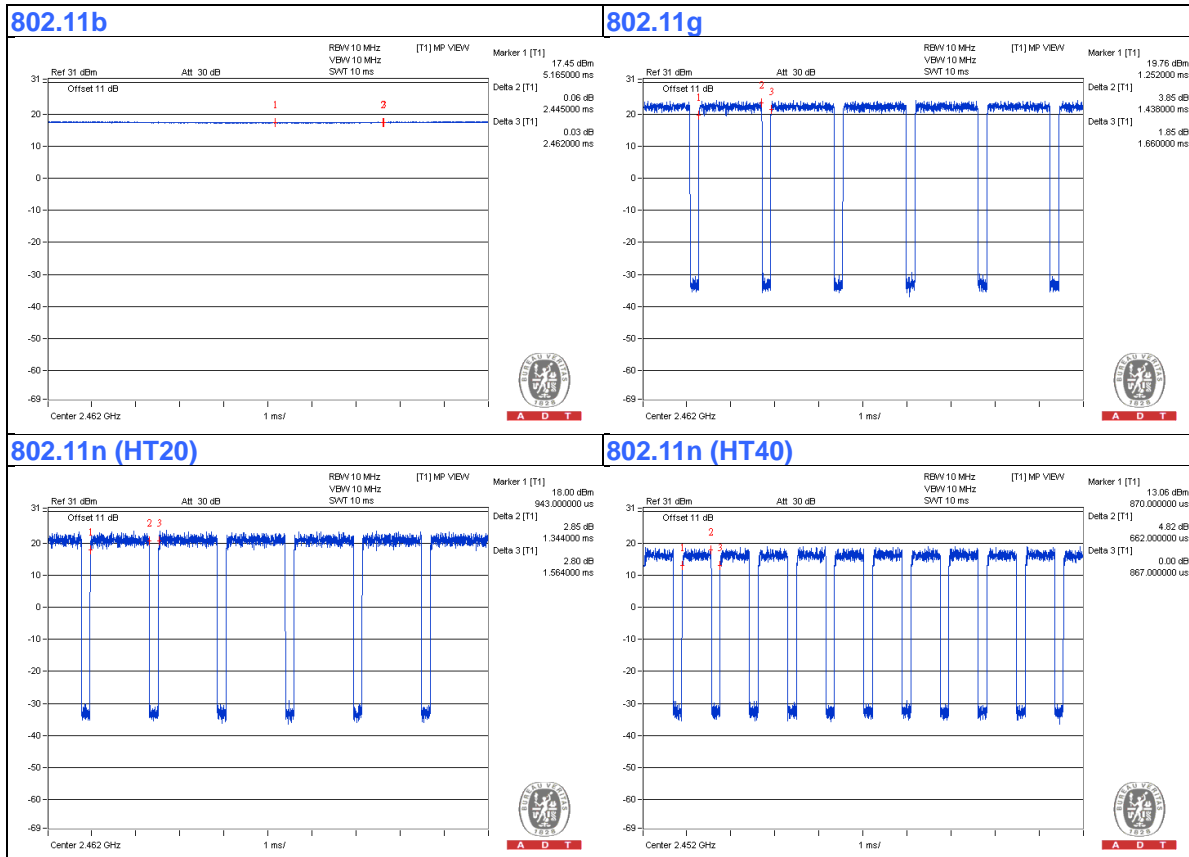

3.4 Description of Support Units

The EUT has been tested as an independent unit together with other necessary accessories or support units. The following support units or accessories were used to form a representative test configuration during the tests.

ID	Product	Brand	Model No.	Serial No.	FCC ID	Remarks
A.	Notebook	DELL	E5410	1HC2XM1	FCC DoC Approved	-

Note:

1. All power cords of the above support units are non-shielded (1.8m).
2. Item A acted as a communication partner to transfer data.

ID	Descriptions	Qty.	Length (m)	Shielding (Yes/No)	Cores (Qty.)	Remarks
1.	RJ45 cable	1	10	N	0	-
2.	RJ45 cable	1	1.8	N	0	-
3.	DC cable	1	1.75	-	0	Accessory
4.	DC cable	1	1.8	-	1	Accessory
5.	Power Line	1	0.6	N	1	Attached on EUT

Note: The core(s) is(are) originally attached to the cable(s).

3.4.1 Configuration of System under Test

Test Mode A

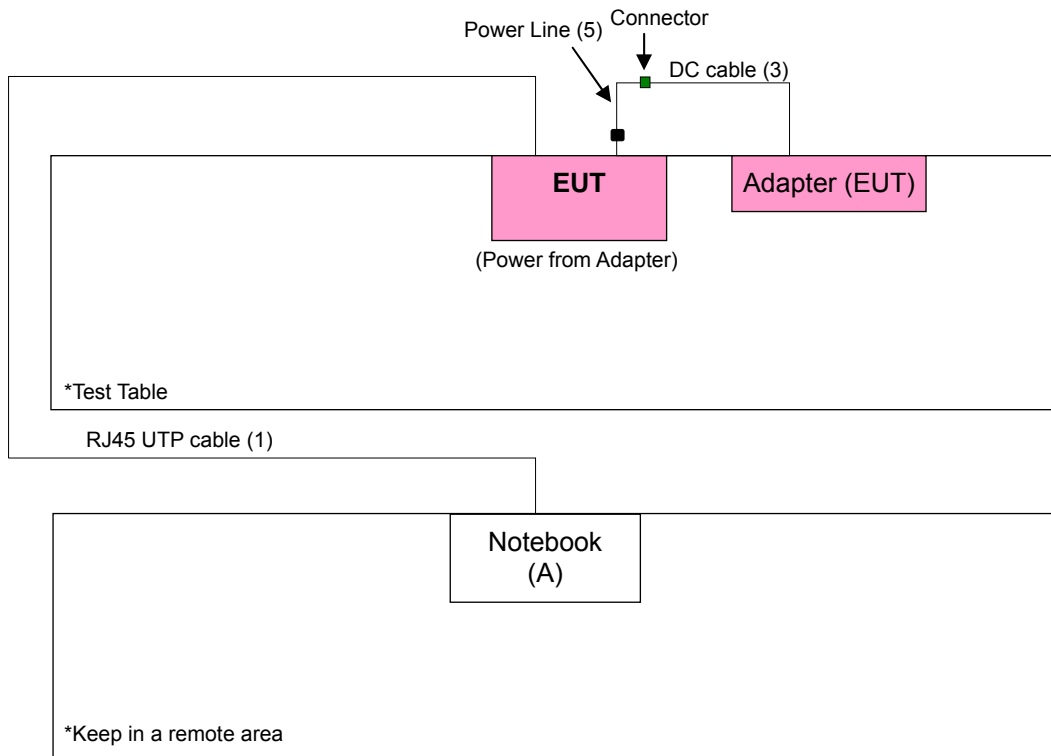

Test Mode B

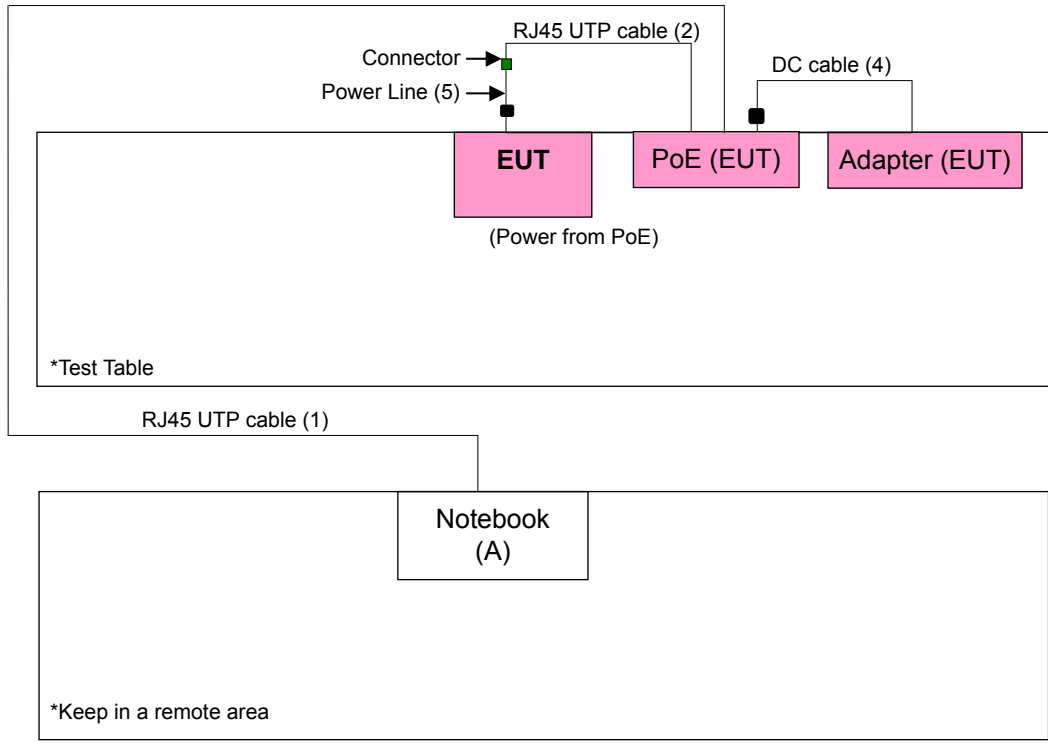

3.5 General Description of Applied Standards

The EUT is a RF Product. According to the specifications of the manufacturer, it must comply with the requirements of the following standards:

FCC Part 15, Subpart C (15.247)

558074 D01 DTS Meas Guidance v03r02

ANSI C63.10-2009

All test items have been performed and recorded as per the above standards.

NOTE: The EUT has been verified to comply with the requirements of FCC Part 15, Subpart B, Class B (DoC). The test report has been issued separately.

4 Test Types and Results

4.1 Radiated Emission and Bandedge Measurement

4.1.1 Limits of Radiated Emission and Bandedge Measurement

Radiated emissions which fall in the restricted bands must comply with the radiated emission limits specified as below table. Other emissions shall be at least 30dB below the highest level of the desired power:

Frequencies (MHz)	Field Strength (microvolts/meter)	Measurement Distance (meters)
0.009 ~ 0.490	2400/F(kHz)	300
0.490 ~ 1.705	24000/F(kHz)	30
1.705 ~ 30.0	30	30
30 ~ 88	100	3
88 ~ 216	150	3
216 ~ 960	200	3
Above 960	500	3

NOTE:

1. The lower limit shall apply at the transition frequencies.
2. Emission level (dBuV/m) = 20 log Emission level (uV/m).
3. For frequencies above 1000MHz, the field strength limits are based on average detector, however, the peak field strength of any emission shall not exceed the maximum permitted average limits, specified above by more than 30dB under any condition of modulation.

4.1.2 Test Instruments

DESCRIPTION & MANUFACTURER	MODEL NO.	SERIAL NO.	DATE OF CALIBRATION	DUE DATE OF CALIBRATION
Test Receiver ROHDE & SCHWARZ	ESCI	100424	Oct. 06, 2014	Oct. 05, 2015
Spectrum Analyzer ROHDE & SCHWARZ	FSP40	100041	Aug. 29, 2014	Aug. 28, 2015
BILOG Antenna SCHWARZBECK	VULB9168	9168-160	Feb. 05, 2015	Feb. 04, 2016
HORN Antenna SCHWARZBECK	9120D	209	Feb. 09, 2015	Feb. 08, 2016
HORN Antenna SCHWARZBECK	BBHA 9170	BBHA9170241	Feb. 09, 2015	Feb. 08, 2016
Preamplifier Agilent	8447D	2944A10738	Oct.18, 2014	Oct. 17, 2015
Preamplifier Agilent	8449B	3008A01964	Aug. 22, 2014	Aug. 21, 2015
RF signal cable HUBER+SUHNNER	SUCOFLEX 104	214378/4	Aug. 22, 2014	Aug. 21, 2015
RF signal cable HUBER+SUHNNER	SUCOFLEX 106	12738/6 +309224/4	Aug. 22, 2014	Aug. 21, 2015
Software BV ADT	ADT_Radiated_ V7.6.15.9.4	NA	NA	NA
Antenna Tower inn-co GmbH	MA 4000	013303	NA	NA
Antenna Tower Controller inn-co GmbH	CO2000	017303	NA	NA
Turn Table BV ADT	TT100	TT93021703	NA	NA
Turn Table Controller BV ADT	SC100	SC93021703	NA	NA
High Speed Peak Power Meter	ML2495A	0824011	Jul. 26, 2014	Jul. 25, 2015
Power Sensor	MA2411B	0738171	Jul. 26, 2014	Jul. 25, 2015

- NOTE:**
1. The calibration interval of the above test instruments is 12 months and the calibrations are traceable to NML/ROC and NIST/USA.
 2. The test was performed in HwaYa Chamber 3.
 3. The horn antenna and HP preamplifier (model: 8449B) are used only for the measurement of emission frequency above 1GHz if tested.
 4. The FCC Site Registration No. is 988962.
 5. The IC Site Registration No. is IC 7450F-3.

4.1.3 Test Procedures

- a. The EUT was placed on the top of a rotating table 0.8 meters above the ground at 3 meter chamber room for test. The table was rotated 360 degrees to determine the position of the highest radiation.
- b. The EUT was set 3 meters away from the interference-receiving antenna, which was mounted on the top of a variable-height antenna tower.
- c. The height of antenna is varied from one meter to four meters above the ground to determine the maximum value of the field strength. Both horizontal and vertical polarizations of the antenna are set to make the measurement.
- d. For each suspected emission, the EUT was arranged to its worst case and then the antenna was tuned to heights from 1 meter to 4 meters and the rotatable table was turned from 0 degrees to 360 degrees to find the maximum reading.
- e. The test-receiver system was set to quasi-peak detect function and specified bandwidth with maximum hold mode when the test frequency is below 1 GHz.
- f. The test-receiver system was set to peak and average detect function and specified bandwidth with maximum hold mode when the test frequency is above 1 GHz. If the peak reading value also meets average limit, measurement with the average detector is unnecessary.

Note:

1. For emission measurements above 1 GHz, the EUT shall be placed at a height of 1.5 m above the ground at 3 meter chamber room for test
2. The resolution bandwidth and video bandwidth of test receiver/spectrum analyzer is 120kHz for Quasi-peak detection (QP) at frequency below 1GHz.
3. The resolution bandwidth of test receiver/spectrum analyzer is 1 MHz and the video bandwidth is 3 MHz for Peak detection (PK) at frequency above 1GHz.
4. The resolution bandwidth of test receiver/spectrum analyzer is 1MHz and the video bandwidth is 3MHz for RMS Average (Duty cycle < 98%) for Average detection (AV) at frequency above 1GHz, then the measurement results was added to a correction factor ($10 \log(1/\text{duty cycle})$).
5. The resolution bandwidth of test receiver/spectrum analyzer is 1MHz and the video bandwidth is 10Hz (Duty cycle $\geq 98\%$) for Average detection (AV) at frequency above 1GHz.
6. All modes of operation were investigated and the worst-case emissions are reported.

4.1.4 Deviation from Test Standard

No deviation.

4.1.5 Test Set Up

<Frequency Range below 1GHz>

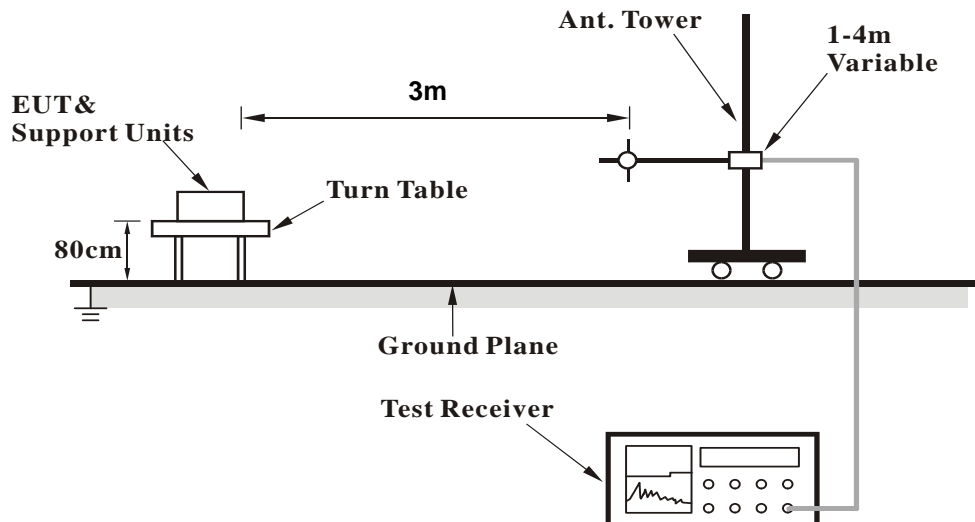

<Frequency Range above 1GHz>

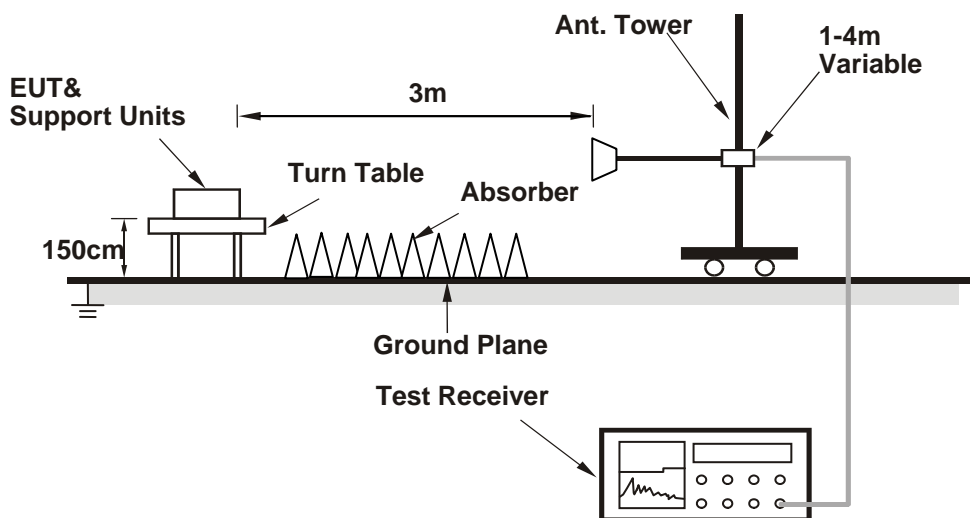

For the actual test configuration, please refer to the attached file (Test Setup Photo).

4.1.6 EUT Operating Conditions

- Placed the EUT on the testing table.
- Prepared notebook to act as a communication partner and placed it outside of testing area.
- The communication partner connected with EUT via a RJ45 cable and ran a test program (provided by manufacturer) to enable EUT under transmission condition continuously at specific channel frequency.
- The communication partner sent data to EUT by command "PING".

4.1.7 Test Results

Above 1GHz Data :

802.11b

CHANNEL	TX Channel 1	DETECTOR FUNCTION	Peak (PK)
FREQUENCY RANGE	1GHz ~ 25GHz		Average (AV)

ANTENNA POLARITY & TEST DISTANCE: HORIZONTAL AT 3 M

NO.	FREQ. (MHz)	EMISSION LEVEL (dBuV/m)	LIMIT (dBuV/m)	MARGIN (dB)	ANTENNA HEIGHT (m)	TABLE ANGLE (Degree)	RAW VALUE (dBuV)	CORRECTION FACTOR (dB/m)
1	2390.00	56.3 PK	74.0	-17.7	1.52 H	302	23.80	32.50
2	2390.00	45.0 AV	54.0	-9.0	1.52 H	302	12.50	32.50
3	*2412.00	101.9 PK			1.71 H	287	69.30	32.60
4	*2412.00	98.2 AV			1.71 H	287	65.60	32.60
5	4824.00	53.0 PK	74.0	-21.0	1.09 H	108	47.10	5.90
6	4824.00	48.4 AV	54.0	-5.6	1.09 H	108	42.50	5.90

ANTENNA POLARITY & TEST DISTANCE: VERTICAL AT 3 M

NO.	FREQ. (MHz)	EMISSION LEVEL (dBuV/m)	LIMIT (dBuV/m)	MARGIN (dB)	ANTENNA HEIGHT (m)	TABLE ANGLE (Degree)	RAW VALUE (dBuV)	CORRECTION FACTOR (dB/m)
1	2390.00	55.9 PK	74.0	-18.1	1.27 V	359	23.40	32.50
2	2390.00	45.0 AV	54.0	-9.0	1.27 V	359	12.50	32.50
3	*2412.00	100.3 PK			1.46 V	7	67.70	32.60
4	*2412.00	96.9 AV			1.46 V	7	64.30	32.60
5	4824.00	55.4 PK	74.0	-18.6	1.66 V	53	49.50	5.90
6	4824.00	52.5 AV	54.0	-1.5	1.66 V	53	46.60	5.90

REMARKS:

1. Emission Level(dBuV/m) = Raw Value(dBuV) + Correction Factor(dB/m)
2. Correction Factor(dB/m) = Antenna Factor(dB/m) + Cable Factor(dB)
3. The other emission levels were very low against the limit.
4. Margin value = Emission Level – Limit value
5. " * ": Fundamental frequency.

CHANNEL	TX Channel 6	DETECTOR FUNCTION	Peak (PK)
FREQUENCY RANGE	1GHz ~ 25GHz		Average (AV)

ANTENNA POLARITY & TEST DISTANCE: HORIZONTAL AT 3 M								
NO.	FREQ. (MHz)	EMISSION LEVEL (dBuV/m)	LIMIT (dBuV/m)	MARGIN (dB)	ANTENNA HEIGHT (m)	TABLE ANGLE (Degree)	RAW VALUE (dBuV)	CORRECTION FACTOR (dB/m)
1	*2437.00	102.5 PK			1.35 H	290	69.80	32.70
2	*2437.00	98.8 AV			1.35 H	290	66.10	32.70
3	4874.00	53.3 PK	74.0	-20.7	1.00 H	105	47.40	5.90
4	4874.00	49.0 AV	54.0	-5.0	1.00 H	105	43.10	5.90
ANTENNA POLARITY & TEST DISTANCE: VERTICAL AT 3 M								
NO.	FREQ. (MHz)	EMISSION LEVEL (dBuV/m)	LIMIT (dBuV/m)	MARGIN (dB)	ANTENNA HEIGHT (m)	TABLE ANGLE (Degree)	RAW VALUE (dBuV)	CORRECTION FACTOR (dB/m)
1	*2437.00	101.9 PK			1.60 V	350	69.20	32.70
2	*2437.00	98.3 AV			1.60 V	350	65.60	32.70
3	4874.00	55.7 PK	74.0	-18.3	1.54 V	55	49.80	5.90
4	4874.00	52.9 AV	54.0	-1.1	1.54 V	55	47.00	5.90

REMARKS:

1. Emission Level(dBuV/m) = Raw Value(dBuV) + Correction Factor(dB/m)
2. Correction Factor(dB/m) = Antenna Factor(dB/m) + Cable Factor(dB)
3. The other emission levels were very low against the limit.
4. Margin value = Emission Level – Limit value
5. " * ": Fundamental frequency.

CHANNEL	TX Channel 11	DETECTOR FUNCTION	Peak (PK)
FREQUENCY RANGE	1GHz ~ 25GHz		Average (AV)

ANTENNA POLARITY & TEST DISTANCE: HORIZONTAL AT 3 M

NO.	FREQ. (MHz)	EMISSION LEVEL (dBuV/m)	LIMIT (dBuV/m)	MARGIN (dB)	ANTENNA HEIGHT (m)	TABLE ANGLE (Degree)	RAW VALUE (dBuV)	CORRECTION FACTOR (dB/m)
1	*2462.00	101.5 PK			1.17 H	285	68.90	32.60
2	*2462.00	98.2 AV			1.17 H	285	65.60	32.60
3	2483.50	56.9 PK	74.0	-17.1	1.10 H	268	24.20	32.70
4	2483.50	45.1 AV	54.0	-8.9	1.10 H	268	12.40	32.70
5	4924.00	52.6 PK	74.0	-21.4	1.00 H	105	46.60	6.00
6	4924.00	47.3 AV	54.0	-6.7	1.00 H	105	41.30	6.00

ANTENNA POLARITY & TEST DISTANCE: VERTICAL AT 3 M

NO.	FREQ. (MHz)	EMISSION LEVEL (dBuV/m)	LIMIT (dBuV/m)	MARGIN (dB)	ANTENNA HEIGHT (m)	TABLE ANGLE (Degree)	RAW VALUE (dBuV)	CORRECTION FACTOR (dB/m)
1	*2462.00	100.8 PK			1.25 V	224	68.20	32.60
2	*2462.00	97.0 AV			1.25 V	224	64.40	32.60
3	2483.50	57.1 PK	74.0	-16.9	1.15 V	203	24.40	32.70
4	2483.50	45.0 AV	54.0	-9.0	1.15 V	203	12.30	32.70
5	4924.00	55.9 PK	74.0	-18.1	1.71 V	59	49.90	6.00
6	4924.00	53.0 AV	54.0	-1.0	1.71 V	59	47.00	6.00

REMARKS:

1. Emission Level(dBuV/m) = Raw Value(dBuV) + Correction Factor(dB/m)
2. Correction Factor(dB/m) = Antenna Factor(dB/m) + Cable Factor(dB)
3. The other emission levels were very low against the limit.
4. Margin value = Emission Level – Limit value
5. " * ": Fundamental frequency.

802.11g

CHANNEL	TX Channel 1	DETECTOR FUNCTION	Peak (PK)
FREQUENCY RANGE	1GHz ~ 25GHz		Average (AV)

ANTENNA POLARITY & TEST DISTANCE: HORIZONTAL AT 3 M								
NO.	FREQ. (MHz)	EMISSION LEVEL (dBuV/m)	LIMIT (dBuV/m)	MARGIN (dB)	ANTENNA HEIGHT (m)	TABLE ANGLE (Degree)	RAW VALUE (dBuV)	CORRECTION FACTOR (dB/m)
1	2390.00	67.4 PK	74.0	-6.6	1.38 H	33	34.90	32.50
2	2390.00	52.9 AV	54.0	-1.1	1.38 H	33	20.40	32.50
3	*2412.00	108.8 PK			1.33 H	36	76.20	32.60
4	*2412.00	99.5 AV			1.33 H	36	66.90	32.60
5	4824.00	54.2 PK	74.0	-19.8	1.01 H	332	48.30	5.90
6	4824.00	41.3 AV	54.0	-12.7	1.01 H	332	35.40	5.90

ANTENNA POLARITY & TEST DISTANCE: VERTICAL AT 3 M								
NO.	FREQ. (MHz)	EMISSION LEVEL (dBuV/m)	LIMIT (dBuV/m)	MARGIN (dB)	ANTENNA HEIGHT (m)	TABLE ANGLE (Degree)	RAW VALUE (dBuV)	CORRECTION FACTOR (dB/m)
1	2390.00	62.9 PK	74.0	-11.1	1.50 V	312	30.40	32.50
2	2390.00	50.4 AV	54.0	-3.6	1.50 V	312	17.90	32.50
3	*2412.00	106.0 PK			1.55 V	322	73.40	32.60
4	*2412.00	96.6 AV			1.55 V	322	64.00	32.60
5	4824.00	56.2 PK	74.0	-17.8	1.64 V	303	50.30	5.90
6	4824.00	43.7 AV	54.0	-10.3	1.64 V	303	37.80	5.90

REMARKS:

1. Emission Level(dBuV/m) = Raw Value(dBuV) + Correction Factor(dB/m)
2. Correction Factor(dB/m) = Antenna Factor(dB/m) + Cable Factor(dB)
3. The other emission levels were very low against the limit.
4. Margin value = Emission Level – Limit value
5. " * ": Fundamental frequency.

CHANNEL	TX Channel 6	DETECTOR FUNCTION	Peak (PK)
FREQUENCY RANGE	1GHz ~ 25GHz		Average (AV)

ANTENNA POLARITY & TEST DISTANCE: HORIZONTAL AT 3 M

NO.	FREQ. (MHz)	EMISSION LEVEL (dBuV/m)	LIMIT (dBuV/m)	MARGIN (dB)	ANTENNA HEIGHT (m)	TABLE ANGLE (Degree)	RAW VALUE (dBuV)	CORRECTION FACTOR (dB/m)
1	2390.00	68.2 PK	74.0	-5.8	1.36 H	34	35.70	32.50
2	2390.00	52.5 AV	54.0	-1.5	1.36 H	34	20.00	32.50
3	*2437.00	114.2 PK			1.03 H	36	81.50	32.70
4	*2437.00	105.0 AV			1.03 H	36	72.30	32.70
5	2483.50	62.7 PK	74.0	-11.3	1.40 H	40	30.00	32.70
6	2483.50	49.3 AV	54.0	-4.7	1.40 H	40	16.60	32.70
7	4874.00	56.8 PK	74.0	-17.2	1.00 H	343	50.90	5.90
8	4874.00	44.4 AV	54.0	-9.6	1.00 H	343	38.50	5.90

ANTENNA POLARITY & TEST DISTANCE: VERTICAL AT 3 M

NO.	FREQ. (MHz)	EMISSION LEVEL (dBuV/m)	LIMIT (dBuV/m)	MARGIN (dB)	ANTENNA HEIGHT (m)	TABLE ANGLE (Degree)	RAW VALUE (dBuV)	CORRECTION FACTOR (dB/m)
1	2390.00	63.2 PK	74.0	-10.8	1.51 V	322	30.70	32.50
2	2390.00	49.1 AV	54.0	-4.9	1.51 V	322	16.60	32.50
3	*2437.00	111.7 PK			1.55 V	327	79.00	32.70
4	*2437.00	102.3 AV			1.55 V	327	69.60	32.70
5	2483.50	63.4 PK	74.0	-10.6	1.55 V	327	30.70	32.70
6	2483.50	48.7 AV	54.0	-5.3	1.55 V	327	16.00	32.70
7	4874.00	59.5 PK	74.0	-14.5	1.20 V	302	53.60	5.90
8	4874.00	47.4 AV	54.0	-6.6	1.20 V	302	41.50	5.90

REMARKS:

1. Emission Level(dBuV/m) = Raw Value(dBuV) + Correction Factor(dB/m)
2. Correction Factor(dB/m) = Antenna Factor(dB/m) + Cable Factor(dB)
3. The other emission levels were very low against the limit.
4. Margin value = Emission Level – Limit value
5. " * ": Fundamental frequency.

CHANNEL	TX Channel 11	DETECTOR FUNCTION	Peak (PK)
FREQUENCY RANGE	1GHz ~ 25GHz		Average (AV)

ANTENNA POLARITY & TEST DISTANCE: HORIZONTAL AT 3 M

NO.	FREQ. (MHz)	EMISSION LEVEL (dBuV/m)	LIMIT (dBuV/m)	MARGIN (dB)	ANTENNA HEIGHT (m)	TABLE ANGLE (Degree)	RAW VALUE (dBuV)	CORRECTION FACTOR (dB/m)
1	*2462.00	109.0 PK			1.31 H	37	76.40	32.60
2	*2462.00	99.7 AV			1.31 H	37	67.10	32.60
3	2483.50	72.7 PK	74.0	-1.3	1.31 H	50	40.00	32.70
4	2483.50	52.8 AV	54.0	-1.2	1.31 H	50	20.10	32.70
5	4924.00	55.5 PK	74.0	-18.5	1.13 H	343	49.50	6.00
6	4924.00	41.6 AV	54.0	-12.4	1.13 H	343	35.60	6.00

ANTENNA POLARITY & TEST DISTANCE: VERTICAL AT 3 M

NO.	FREQ. (MHz)	EMISSION LEVEL (dBuV/m)	LIMIT (dBuV/m)	MARGIN (dB)	ANTENNA HEIGHT (m)	TABLE ANGLE (Degree)	RAW VALUE (dBuV)	CORRECTION FACTOR (dB/m)
1	*2462.00	106.6 PK			1.69 V	336	74.00	32.60
2	*2462.00	97.6 AV			1.69 V	336	65.00	32.60
3	2483.50	69.3 PK	74.0	-4.7	1.66 V	359	36.60	32.70
4	2483.50	52.1 AV	54.0	-1.9	1.66 V	359	19.40	32.70
5	4924.00	59.5 PK	74.0	-14.5	1.44 V	303	53.50	6.00
6	4924.00	46.1 AV	54.0	-7.9	1.44 V	303	40.10	6.00

REMARKS:

1. Emission Level(dBuV/m) = Raw Value(dBuV) + Correction Factor(dB/m)
2. Correction Factor(dB/m) = Antenna Factor(dB/m) + Cable Factor(dB)
3. The other emission levels were very low against the limit.
4. Margin value = Emission Level – Limit value
5. " * ": Fundamental frequency.

802.11n (HT20)

CHANNEL	TX Channel 1	DETECTOR FUNCTION	Peak (PK)
FREQUENCY RANGE	1GHz ~ 25GHz		Average (AV)

ANTENNA POLARITY & TEST DISTANCE: HORIZONTAL AT 3 M								
NO.	FREQ. (MHz)	EMISSION LEVEL (dBuV/m)	LIMIT (dBuV/m)	MARGIN (dB)	ANTENNA HEIGHT (m)	TABLE ANGLE (Degree)	RAW VALUE (dBuV)	CORRECTION FACTOR (dB/m)
1	2390.00	70.8 PK	74.0	-3.2	1.54 H	31	38.30	32.50
2	2390.00	52.7 AV	54.0	-1.3	1.54 H	31	20.20	32.50
3	*2412.00	107.5 PK			1.18 H	27	74.90	32.60
4	*2412.00	97.9 AV			1.18 H	27	65.30	32.60
5	4824.00	52.4 PK	74.0	-21.6	1.00 H	332	46.50	5.90
6	4824.00	39.9 AV	54.0	-14.1	1.00 H	332	34.00	5.90

ANTENNA POLARITY & TEST DISTANCE: VERTICAL AT 3 M								
NO.	FREQ. (MHz)	EMISSION LEVEL (dBuV/m)	LIMIT (dBuV/m)	MARGIN (dB)	ANTENNA HEIGHT (m)	TABLE ANGLE (Degree)	RAW VALUE (dBuV)	CORRECTION FACTOR (dB/m)
1	2390.00	66.1 PK	74.0	-7.9	1.57 V	329	33.60	32.50
2	2390.00	50.0 AV	54.0	-4.0	1.57 V	329	17.50	32.50
3	*2412.00	104.5 PK			1.57 V	329	71.90	32.60
4	*2412.00	95.2 AV			1.57 V	329	62.60	32.60
5	4824.00	56.2 PK	74.0	-17.8	1.45 V	304	50.30	5.90
6	4824.00	42.6 AV	54.0	-11.4	1.45 V	304	36.70	5.90

REMARKS:

1. Emission Level(dBuV/m) = Raw Value(dBuV) + Correction Factor(dB/m)
2. Correction Factor(dB/m) = Antenna Factor(dB/m) + Cable Factor(dB)
3. The other emission levels were very low against the limit.
4. Margin value = Emission Level – Limit value
5. " * ": Fundamental frequency.



CHANNEL	TX Channel 6	DETECTOR FUNCTION	Peak (PK)
FREQUENCY RANGE	1GHz ~ 25GHz		Average (AV)

ANTENNA POLARITY & TEST DISTANCE: HORIZONTAL AT 3 M

NO.	FREQ. (MHz)	EMISSION LEVEL (dBuV/m)	LIMIT (dBuV/m)	MARGIN (dB)	ANTENNA HEIGHT (m)	TABLE ANGLE (Degree)	RAW VALUE (dBuV)	CORRECTION FACTOR (dB/m)
1	2390.00	69.5 PK	74.0	-4.5	1.36 H	34	37.00	32.50
2	2390.00	52.2 AV	54.0	-1.8	1.36 H	34	19.70	32.50
3	*2437.00	113.0 PK			1.33 H	38	80.30	32.70
4	*2437.00	103.5 AV			1.33 H	38	70.80	32.70
5	2483.50	66.6 PK	74.0	-7.4	1.35 H	40	33.90	32.70
6	2483.50	49.5 AV	54.0	-4.5	1.35 H	40	16.80	32.70
7	4874.00	55.6 PK	74.0	-18.4	1.00 H	344	49.70	5.90
8	4874.00	43.4 AV	54.0	-10.6	1.00 H	344	37.50	5.90

ANTENNA POLARITY & TEST DISTANCE: VERTICAL AT 3 M

NO.	FREQ. (MHz)	EMISSION LEVEL (dBuV/m)	LIMIT (dBuV/m)	MARGIN (dB)	ANTENNA HEIGHT (m)	TABLE ANGLE (Degree)	RAW VALUE (dBuV)	CORRECTION FACTOR (dB/m)
1	2390.00	66.0 PK	74.0	-8.0	1.73 V	328	33.50	32.50
2	2390.00	48.7 AV	54.0	-5.3	1.73 V	328	16.20	32.50
3	*2437.00	110.8 PK			1.73 V	328	78.10	32.70
4	*2437.00	101.2 AV			1.73 V	328	68.50	32.70
5	2483.50	59.9 PK	74.0	-14.1	1.75 V	330	27.20	32.70
6	2483.50	48.2 AV	54.0	-5.8	1.75 V	330	15.50	32.70
7	4874.00	58.2 PK	74.0	-15.8	1.21 V	302	52.30	5.90
8	4874.00	46.2 AV	54.0	-7.8	1.21 V	302	40.30	5.90

REMARKS:

1. Emission Level(dBuV/m) = Raw Value(dBuV) + Correction Factor(dB/m)
2. Correction Factor(dB/m) = Antenna Factor(dB/m) + Cable Factor(dB)
3. The other emission levels were very low against the limit.
4. Margin value = Emission Level – Limit value
5. " * ": Fundamental frequency.

CHANNEL	TX Channel 11	DETECTOR FUNCTION	Peak (PK)
FREQUENCY RANGE	1GHz ~ 25GHz		Average (AV)

ANTENNA POLARITY & TEST DISTANCE: HORIZONTAL AT 3 M

NO.	FREQ. (MHz)	EMISSION LEVEL (dBuV/m)	LIMIT (dBuV/m)	MARGIN (dB)	ANTENNA HEIGHT (m)	TABLE ANGLE (Degree)	RAW VALUE (dBuV)	CORRECTION FACTOR (dB/m)
1	*2462.00	107.9 PK			1.32 H	36	75.30	32.60
2	*2462.00	98.2 AV			1.32 H	36	65.60	32.60
3	2483.50	72.2 PK	74.0	-1.8	1.30 H	36	39.50	32.70
4	2483.50	50.6 AV	54.0	-3.4	1.30 H	36	17.90	32.70
5	4874.00	52.8 PK	74.0	-21.2	1.12 H	339	46.90	5.90
6	4874.00	39.5 AV	54.0	-14.5	1.12 H	339	33.60	5.90

ANTENNA POLARITY & TEST DISTANCE: VERTICAL AT 3 M

NO.	FREQ. (MHz)	EMISSION LEVEL (dBuV/m)	LIMIT (dBuV/m)	MARGIN (dB)	ANTENNA HEIGHT (m)	TABLE ANGLE (Degree)	RAW VALUE (dBuV)	CORRECTION FACTOR (dB/m)
1	*2462.00	105.4 PK			1.88 V	331	72.80	32.60
2	*2462.00	96.3 AV			1.88 V	331	63.70	32.60
3	2483.50	70.1 PK	74.0	-3.9	1.72 V	335	37.40	32.70
4	2483.50	48.9 AV	54.0	-5.1	1.72 V	335	16.20	32.70
5	4924.00	58.3 PK	74.0	-15.7	1.43 V	302	52.30	6.00
6	4924.00	44.5 AV	54.0	-9.5	1.43 V	302	38.50	6.00

REMARKS:

1. Emission Level(dBuV/m) = Raw Value(dBuV) + Correction Factor(dB/m)
2. Correction Factor(dB/m) = Antenna Factor(dB/m) + Cable Factor(dB)
3. The other emission levels were very low against the limit.
4. Margin value = Emission Level – Limit value
5. " * ": Fundamental frequency.

802.11n (HT40)

CHANNEL	TX Channel 3	DETECTOR FUNCTION	Peak (PK)
FREQUENCY RANGE	1GHz ~ 25GHz		Average (AV)

ANTENNA POLARITY & TEST DISTANCE: HORIZONTAL AT 3 M

NO.	FREQ. (MHz)	EMISSION LEVEL (dBuV/m)	LIMIT (dBuV/m)	MARGIN (dB)	ANTENNA HEIGHT (m)	TABLE ANGLE (Degree)	RAW VALUE (dBuV)	CORRECTION FACTOR (dB/m)
1	2390.00	68.3 PK	74.0	-5.7	1.20 H	30	35.80	32.50
2	2390.00	52.6 AV	54.0	-1.4	1.20 H	30	20.10	32.50
3	*2422.00	102.4 PK			1.20 H	29	69.80	32.60
4	*2422.00	93.5 AV			1.20 H	29	60.90	32.60
5	4824.00	49.5 PK	74.0	-24.5	1.00 H	330	43.60	5.90
6	4824.00	36.4 AV	54.0	-17.6	1.00 H	330	30.50	5.90

ANTENNA POLARITY & TEST DISTANCE: VERTICAL AT 3 M

NO.	FREQ. (MHz)	EMISSION LEVEL (dBuV/m)	LIMIT (dBuV/m)	MARGIN (dB)	ANTENNA HEIGHT (m)	TABLE ANGLE (Degree)	RAW VALUE (dBuV)	CORRECTION FACTOR (dB/m)
1	2390.00	63.2 PK	74.0	-10.8	1.60 V	323	30.70	32.50
2	2390.00	49.4 AV	54.0	-4.6	1.60 V	323	16.90	32.50
3	*2422.00	99.8 PK			1.54 V	333	67.20	32.60
4	*2422.00	90.3 AV			1.54 V	333	57.70	32.60
5	4844.00	51.2 PK	74.0	-22.8	1.47 V	303	45.30	5.90
6	4844.00	38.9 AV	54.0	-15.1	1.47 V	303	33.00	5.90

REMARKS:

1. Emission Level(dBuV/m) = Raw Value(dBuV) + Correction Factor(dB/m)
2. Correction Factor(dB/m) = Antenna Factor(dB/m) + Cable Factor(dB)
3. The other emission levels were very low against the limit.
4. Margin value = Emission Level – Limit value
5. " * " : Fundamental frequency.

CHANNEL	TX Channel 6	DETECTOR FUNCTION	Peak (PK)
FREQUENCY RANGE	1GHz ~ 25GHz		Average (AV)

ANTENNA POLARITY & TEST DISTANCE: HORIZONTAL AT 3 M

NO.	FREQ. (MHz)	EMISSION LEVEL (dBuV/m)	LIMIT (dBuV/m)	MARGIN (dB)	ANTENNA HEIGHT (m)	TABLE ANGLE (Degree)	RAW VALUE (dBuV)	CORRECTION FACTOR (dB/m)
1	2390.00	67.8 PK	74.0	-6.2	1.35 H	34	35.30	32.50
2	2390.00	52.4 AV	54.0	-1.6	1.35 H	34	19.90	32.50
3	*2437.00	105.9 PK			1.19 H	29	73.20	32.70
4	*2437.00	97.0 AV			1.19 H	29	64.30	32.70
5	4874.00	51.6 PK	74.0	-22.4	1.00 H	346	45.70	5.90
6	4874.00	38.4 AV	54.0	-15.6	1.00 H	346	32.50	5.90

ANTENNA POLARITY & TEST DISTANCE: VERTICAL AT 3 M

NO.	FREQ. (MHz)	EMISSION LEVEL (dBuV/m)	LIMIT (dBuV/m)	MARGIN (dB)	ANTENNA HEIGHT (m)	TABLE ANGLE (Degree)	RAW VALUE (dBuV)	CORRECTION FACTOR (dB/m)
1	2390.00	62.5 PK	74.0	-11.5	1.78 V	328	30.00	32.50
2	2390.00	49.6 AV	54.0	-4.4	1.78 V	328	17.10	32.50
3	*2437.00	103.0 PK			1.90 V	332	70.30	32.70
4	*2437.00	93.5 AV			1.90 V	332	60.80	32.70
5	2483.50	63.4 PK	74.0	-10.6	1.90 V	332	30.70	32.70
6	2483.50	48.4 AV	54.0	-5.6	1.90 V	332	15.70	32.70
7	4874.00	53.7 PK	74.0	-20.3	1.54 V	303	47.80	5.90
8	4874.00	41.4 AV	54.0	-12.6	1.54 V	303	35.50	5.90

REMARKS:

1. Emission Level(dBuV/m) = Raw Value(dBuV) + Correction Factor(dB/m)
2. Correction Factor(dB/m) = Antenna Factor(dB/m) + Cable Factor(dB)
3. The other emission levels were very low against the limit.
4. Margin value = Emission Level – Limit value
5. " * ": Fundamental frequency.

CHANNEL	TX Channel 9	DETECTOR FUNCTION	Peak (PK)
FREQUENCY RANGE	1GHz ~ 25GHz		Average (AV)

ANTENNA POLARITY & TEST DISTANCE: HORIZONTAL AT 3 M

NO.	FREQ. (MHz)	EMISSION LEVEL (dBuV/m)	LIMIT (dBuV/m)	MARGIN (dB)	ANTENNA HEIGHT (m)	TABLE ANGLE (Degree)	RAW VALUE (dBuV)	CORRECTION FACTOR (dB/m)
1	*2452.00	104.8 PK			1.33 H	29	72.10	32.70
2	*2452.00	95.8 AV			1.33 H	29	63.10	32.70
3	2483.50	72.5 PK	74.0	-1.5	1.30 H	46	39.80	32.70
4	2483.50	50.9 AV	54.0	-3.1	1.30 H	46	18.20	32.70
5	4904.00	50.3 PK	74.0	-23.7	1.10 H	341	44.50	5.80
6	4904.00	37.3 AV	54.0	-16.7	1.10 H	341	31.50	5.80

ANTENNA POLARITY & TEST DISTANCE: VERTICAL AT 3 M

NO.	FREQ. (MHz)	EMISSION LEVEL (dBuV/m)	LIMIT (dBuV/m)	MARGIN (dB)	ANTENNA HEIGHT (m)	TABLE ANGLE (Degree)	RAW VALUE (dBuV)	CORRECTION FACTOR (dB/m)
1	*2452.00	103.1 PK			1.53 V	339	70.40	32.70
2	*2452.00	94.2 AV			1.53 V	339	61.50	32.70
3	2483.50	68.7 PK	74.0	-5.3	1.51 V	339	36.00	32.70
4	2483.50	49.7 AV	54.0	-4.3	1.51 V	339	17.00	32.70
5	4904.00	51.8 PK	74.0	-22.2	1.45 V	300	46.00	5.80
6	4904.00	40.8 AV	54.0	-13.2	1.45 V	300	35.00	5.80

REMARKS:

1. Emission Level(dBuV/m) = Raw Value(dBuV) + Correction Factor(dB/m)
2. Correction Factor(dB/m) = Antenna Factor(dB/m) + Cable Factor(dB)
3. The other emission levels were very low against the limit.
4. Margin value = Emission Level – Limit value
5. " * ": Fundamental frequency.

Below 1GHz Data:
802.11g

CHANNEL	TX Channel 6	DETECTOR FUNCTION	Quasi-Peak (QP)
FREQUENCY RANGE	30MHz ~ 1GHz		
TEST MODE	A		

ANTENNA POLARITY & TEST DISTANCE: HORIZONTAL AT 3 M

NO.	FREQ. (MHz)	EMISSION LEVEL (dBuV/m)	LIMIT (dBuV/m)	MARGIN (dB)	ANTENNA HEIGHT (m)	TABLE ANGLE (Degree)	RAW VALUE (dBuV)	CORRECTION FACTOR (dB/m)
1	284.60	41.1 QP	46.0	-4.9	1.00 H	71	54.00	-12.90
2	541.25	42.9 QP	46.0	-3.1	1.50 H	196	50.70	-7.80
3	568.47	42.8 QP	46.0	-3.2	1.50 H	196	50.00	-7.20
4	607.52	45.0 QP	46.0	-1.0	1.24 H	196	50.80	-5.80
5	648.18	41.1 QP	46.0	-4.9	1.50 H	9	46.30	-5.20
6	799.84	43.7 QP	46.0	-2.3	1.00 H	189	45.90	-2.20

ANTENNA POLARITY & TEST DISTANCE: VERTICAL AT 3 M

NO.	FREQ. (MHz)	EMISSION LEVEL (dBuV/m)	LIMIT (dBuV/m)	MARGIN (dB)	ANTENNA HEIGHT (m)	TABLE ANGLE (Degree)	RAW VALUE (dBuV)	CORRECTION FACTOR (dB/m)
1	39.62	36.1 QP	40.0	-3.9	1.00 V	345	51.10	-15.00
2	61.01	32.5 QP	40.0	-7.5	1.49 V	3	47.30	-14.80
3	284.60	36.2 QP	46.0	-9.8	1.49 V	159	49.10	-12.90
4	541.25	39.1 QP	46.0	-6.9	1.00 V	164	46.90	-7.80
5	568.47	41.4 QP	46.0	-4.6	1.49 V	153	48.60	-7.20
6	799.84	42.6 QP	46.0	-3.4	1.00 V	284	44.80	-2.20

REMARKS:

1. Emission Level(dBuV/m) = Raw Value(dBuV) + Correction Factor(dB/m)
2. Correction Factor(dB/m) = Antenna Factor(dB/m) + Cable Factor(dB)
3. The other emission levels were very low against the limit.
4. Margin value = Emission Level – Limit value

CHANNEL	TX Channel 6	DETECTOR FUNCTION	Quasi-Peak (QP)
FREQUENCY RANGE	30MHz ~ 1GHz		
TEST MODE	B		

ANTENNA POLARITY & TEST DISTANCE: HORIZONTAL AT 3 M

NO.	FREQ. (MHz)	EMISSION LEVEL (dBuV/m)	LIMIT (dBuV/m)	MARGIN (dB)	ANTENNA HEIGHT (m)	TABLE ANGLE (Degree)	RAW VALUE (dBuV)	CORRECTION FACTOR (dB/m)
1	57.12	31.7 QP	40.0	-8.3	1.50 H	3	46.30	-14.60
2	202.94	36.0 QP	43.5	-7.5	1.50 H	94	52.90	-16.90
3	541.25	44.4 QP	46.0	-1.6	1.50 H	195	52.20	-7.80
4	568.47	40.8 QP	46.0	-5.2	1.50 H	185	48.00	-7.20
5	648.18	40.1 QP	46.0	-5.9	1.01 H	13	45.30	-5.20
6	799.84	44.2 QP	46.0	-1.8	1.01 H	186	46.40	-2.20

ANTENNA POLARITY & TEST DISTANCE: VERTICAL AT 3 M

NO.	FREQ. (MHz)	EMISSION LEVEL (dBuV/m)	LIMIT (dBuV/m)	MARGIN (dB)	ANTENNA HEIGHT (m)	TABLE ANGLE (Degree)	RAW VALUE (dBuV)	CORRECTION FACTOR (dB/m)
1	39.62	36.9 QP	40.0	-3.1	1.50 V	319	51.90	-15.00
2	80.45	33.8 QP	40.0	-6.2	1.50 V	88	52.20	-18.40
3	202.94	34.6 QP	43.5	-8.9	1.50 V	180	51.50	-16.90
4	541.25	38.7 QP	46.0	-7.3	1.49 V	150	46.50	-7.80
5	566.52	38.9 QP	46.0	-7.1	1.49 V	154	46.10	-7.20
6	799.84	40.7 QP	46.0	-5.3	1.49 V	173	42.90	-2.20

REMARKS:

1. Emission Level(dBuV/m) = Raw Value(dBuV) + Correction Factor(dB/m)
2. Correction Factor(dB/m) = Antenna Factor(dB/m) + Cable Factor(dB)
3. The other emission levels were very low against the limit.
4. Margin value = Emission Level – Limit value

4.2 Conducted Emission Measurement

4.2.1 Limits of Conducted Emission Measurement

Frequency (MHz)	Conducted Limit (dBuV)	
	Quasi-peak	Average
0.15 - 0.5	66 - 56	56 - 46
0.50 - 5.0	56	46
5.0 - 30.0	60	50

Note: 1. The lower limit shall apply at the transition frequencies.

2. The limit decreases in line with the logarithm of the frequency in the range of 0.15 to 0.50MHz.

4.2.2 Test Instruments

Description & Manufacturer	Model No.	Serial No.	Date Of Calibration	Due Date Of Calibration
Test Receiver ROHDE & SCHWARZ	ESCI	100612	Sep. 30, 2014	Sep. 29, 2015
RF signal cable Woken	5D-FB	Cable-HYC01-01	Dec. 26, 2014	Dec. 25, 2015
LISN ROHDE & SCHWARZ (EUT)	ESH3-Z5	847265/023	Oct. 21, 2014	Oct. 20, 2015
LISN ROHDE & SCHWARZ (Peripheral)	ESH3-Z5	100311	Jul. 21, 2014	Jul. 20, 2015
Software ADT	BV ADT_Cond_ V7.3.7.3	NA	NA	NA

NOTE: 1. The calibration interval of the above test instruments is 12 months and the calibrations are traceable to NML/ROC and NIST/USA.

2. The test was performed in HwaYa Shielded Room 1.

3. The VCCI Site Registration No. is C-2040.

4.2.3 Test Procedures

- The EUT was placed 0.4 meters from the conducting wall of the shielded room with EUT being connected to the power mains through a line impedance stabilization network (LISN). Other support units were connected to the power mains through another LISN. The two LISNs provide 50 ohm/ 50uH of coupling impedance for the measuring instrument.
- Both lines of the power mains connected to the EUT were checked for maximum conducted interference.
- The frequency range from 150kHz to 30MHz was searched. Emission levels under (Limit - 20dB) was not recorded.

NOTE: The resolution bandwidth and video bandwidth of test receiver is 9kHz for quasi-peak detection (QP) and average detection (AV) at frequency 0.15MHz-30MHz.

4.2.4 Deviation from Test Standard

No deviation.

4.2.5 Test Setup

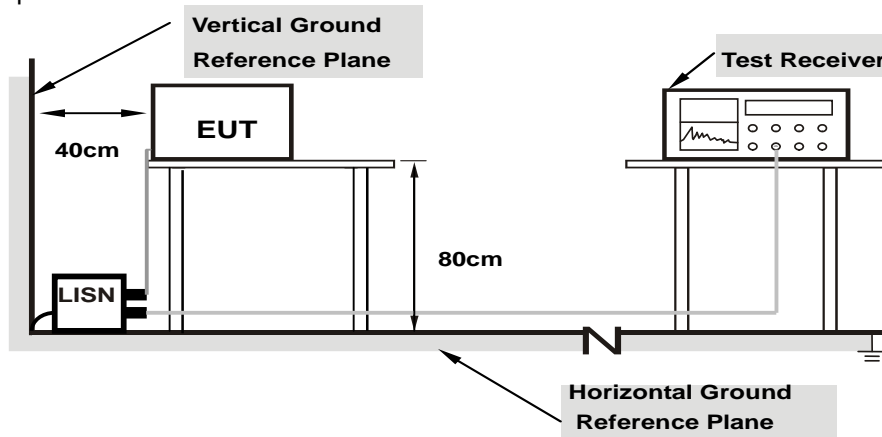

Note: 1.Support units were connected to second LISN.

For the actual test configuration, please refer to the attached file (Test Setup Photo).

4.2.6 EUT Operating Conditions

Same as 4.1.6.

4.2.7 Test Results

Phase	Line (L)	Detector Function	Quasi-Peak (QP) / Average (AV)
Test Mode	A		

No	Freq. [MHz]	Corr. Factor (dB)	Reading Value		Emission Level		Limit		Margin	
			[dB (uV)]		[dB (uV)]		[dB (uV)]		(dB)	
			Q.P.	AV.	Q.P.	AV.	Q.P.	AV.	Q.P.	AV.
1	0.15391	0.08	50.63	37.69	50.71	37.77	65.79	55.79	-15.08	-18.02
2	0.18128	0.12	47.38	33.46	47.50	33.58	64.43	54.43	-16.93	-20.85
3	0.25166	0.13	44.68	29.66	44.81	29.79	61.70	51.70	-16.89	-21.91
4	4.68560	0.28	39.92	31.52	40.20	31.80	56.00	46.00	-15.80	-14.20
5	5.10006	0.29	39.85	31.38	40.14	31.67	60.00	50.00	-19.86	-18.33
6	21.66282	1.01	34.39	27.65	35.40	28.66	60.00	50.00	-24.60	-21.34

REMARKS:

1. Q.P. and AV. are abbreviations of quasi-peak and average individually.
2. The emission levels of other frequencies were very low against the limit.
3. Margin value = Emission level - Limit value
4. Correction factor = Insertion loss + Cable loss
5. Emission Level = Correction Factor + Reading Value.

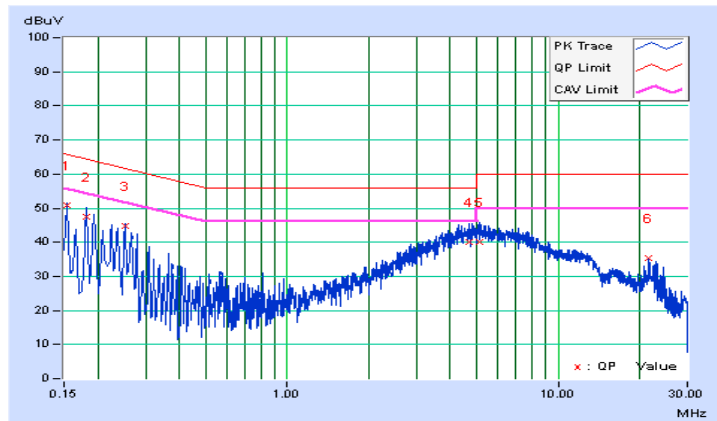

Phase	Neutral (N)	Detector Function	Quasi-Peak (QP) / Average (AV)
Test Mode	A		

No	Freq. [MHz]	Corr. Factor (dB)	Reading Value [dB (uV)]		Emission Level [dB (uV)]		Limit [dB (uV)]		Margin (dB)	
			Q.P.	AV.	Q.P.	AV.	Q.P.	AV.	Q.P.	AV.
			1	0.15782	0.14	48.60	36.98	48.74	37.12	65.58
2	0.18122	0.20	45.59	33.38	45.79	33.58	64.43	54.43	-18.64	-20.85
3	0.24407	0.23	42.72	33.96	42.95	34.19	61.96	51.96	-19.00	-17.76
4	4.13038	0.39	34.97	28.01	35.36	28.40	56.00	46.00	-20.64	-17.60
5	5.07269	0.42	35.39	27.67	35.81	28.09	60.00	50.00	-24.19	-21.91
6	23.12907	0.90	32.99	26.82	33.89	27.72	60.00	50.00	-26.11	-22.28

REMARKS:

1. Q.P. and AV. are abbreviations of quasi-peak and average individually.
2. The emission levels of other frequencies were very low against the limit.
3. Margin value = Emission level - Limit value
4. Correction factor = Insertion loss + Cable loss
5. Emission Level = Correction Factor + Reading Value.

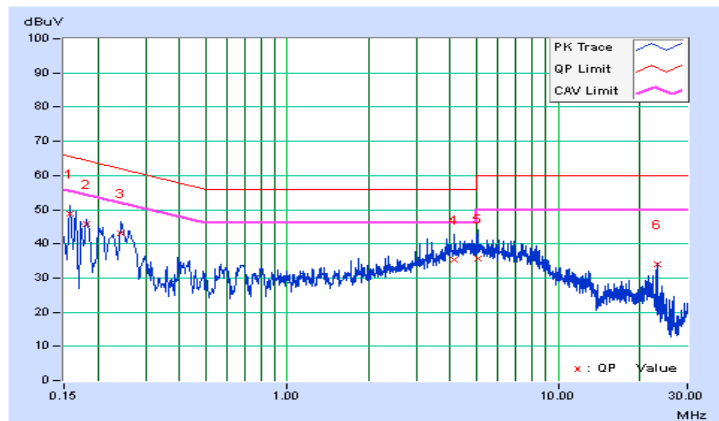

Phase	Line (L)	Detector Function	Quasi-Peak (QP) / Average (AV)
Test Mode	B		

No	Freq. [MHz]	Corr. Factor (dB)	Reading Value [dB (uV)]		Emission Level [dB (uV)]		Limit [dB (uV)]		Margin (dB)	
			Q.P.	AV.	Q.P.	AV.	Q.P.	AV.	Q.P.	AV.
			1	0.16955	0.10	53.05	41.57	53.15	41.67	64.98
2	0.20458	0.15	49.04	39.08	49.19	39.23	63.42	53.42	-14.23	-14.19
3	0.52544	0.10	49.22	42.41	49.32	42.51	56.00	46.00	-6.68	-3.49
4	2.17538	0.22	40.51	35.62	40.73	35.84	56.00	46.00	-15.27	-10.16
5	10.33555	0.50	44.22	39.06	44.72	39.56	60.00	50.00	-15.28	-10.44
6	21.47123	1.00	42.09	36.76	43.09	37.76	60.00	50.00	-16.91	-12.24

REMARKS:

1. Q.P. and AV. are abbreviations of quasi-peak and average individually.
2. The emission levels of other frequencies were very low against the limit.
3. Margin value = Emission level - Limit value
4. Correction factor = Insertion loss + Cable loss
5. Emission Level = Correction Factor + Reading Value.

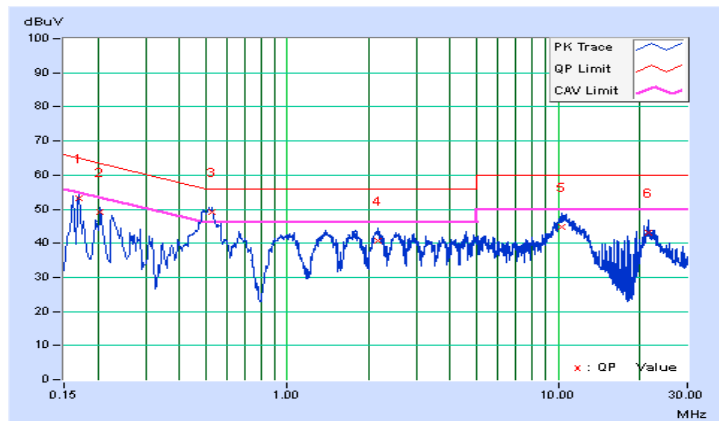

Phase	Neutral (N)	Detector Function	Quasi-Peak (QP) / Average (AV)
Test Mode	B		

No	Freq. [MHz]	Corr. Factor (dB)	Reading Value [dB (uV)]		Emission Level [dB (uV)]		Limit [dB (uV)]		Margin (dB)	
			Q.P.	AV.	Q.P.	AV.	Q.P.	AV.	Q.P.	AV.
			1	0.16569	0.16	54.15	43.00	54.31	43.16	65.17
2	0.20243	0.25	49.63	40.74	49.88	40.99	63.51	53.51	-13.63	-12.52
3	0.53318	0.17	47.33	39.52	47.50	39.69	56.00	46.00	-8.50	-6.31
4	4.86155	0.41	41.63	35.95	42.04	36.36	56.00	46.00	-13.96	-9.64
5	10.53105	0.55	48.93	43.96	49.48	44.51	60.00	50.00	-10.52	-5.49
6	10.53105	0.55	48.93	44.02	49.48	44.57	60.00	50.00	-10.52	-5.43
7	20.82217	0.87	41.47	36.25	42.34	37.12	60.00	50.00	-17.66	-12.88

REMARKS:

1. Q.P. and AV. are abbreviations of quasi-peak and average individually.
2. The emission levels of other frequencies were very low against the limit.
3. Margin value = Emission level - Limit value
4. Correction factor = Insertion loss + Cable loss
5. Emission Level = Correction Factor + Reading Value.

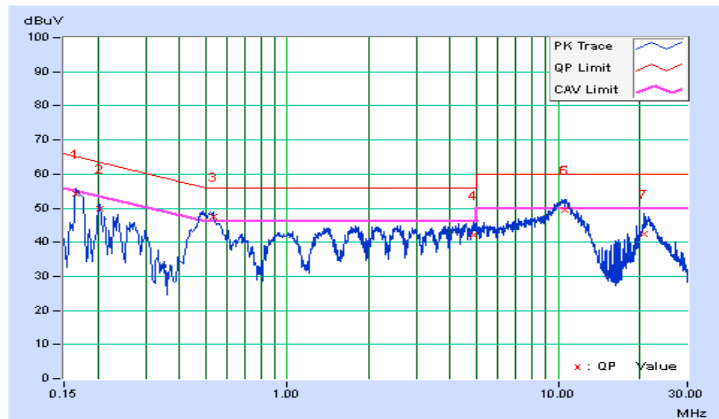

4.3 6dB Bandwidth Measurement

4.3.1 Limits of 6dB Bandwidth Measurement

The minimum of 6dB Bandwidth Measurement is 0.5 MHz.

4.3.2 Test Setup

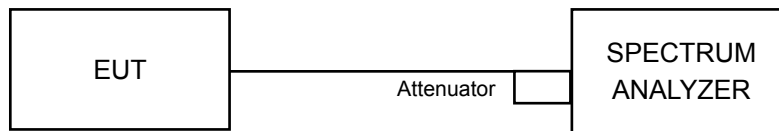

4.3.3 Test Instruments

Refer to section 4.1.2 to get information of above instrument.

4.3.4 Test Procedure

- a. Set resolution bandwidth (RBW) = 100kHz
- b. Set the video bandwidth (VBW) $\geq 3 \times$ RBW, Detector = Peak.
- c. Trace mode = max hold.
- d. Sweep = auto couple.
- e. Measure the maximum width of the emission that is constrained by the frequencies associated with the two amplitude points (upper and lower) that are attenuated by 6 dB relative to the maximum level measured in the fundamental emission

4.3.5 Deviation from Test Standard

No deviation.

4.3.6 EUT Operating Conditions

The software provided by client to enable the EUT under transmission condition continuously at lowest, middle and highest channel frequencies individually.

4.3.7 Test Result

802.11b

Channel	Frequency (MHz)	6dB Bandwidth (MHz)	Minimum Limit (MHz)	Pass / Fail
1	2412	10.14	0.5	PASS
6	2437	10.10	0.5	PASS
11	2462	10.11	0.5	PASS

802.11g

Channel	Frequency (MHz)	6dB Bandwidth (MHz)	Minimum Limit (MHz)	Pass / Fail
1	2412	16.42	0.5	PASS
6	2437	16.41	0.5	PASS
11	2462	16.39	0.5	PASS

802.11n (HT20)

Channel	Frequency (MHz)	6dB Bandwidth (MHz)	Minimum Limit (MHz)	Pass / Fail
1	2412	17.14	0.5	Pass
6	2437	17.11	0.5	Pass
11	2462	17.12	0.5	Pass

802.11n (HT40)

Channel	Frequency (MHz)	6dB Bandwidth (MHz)	Minimum Limit (MHz)	Pass / Fail
3	2422	35.36	0.5	Pass
6	2437	35.27	0.5	Pass
9	2452	35.29	0.5	Pass

Spectrum Plot of Worst Value

802.11b

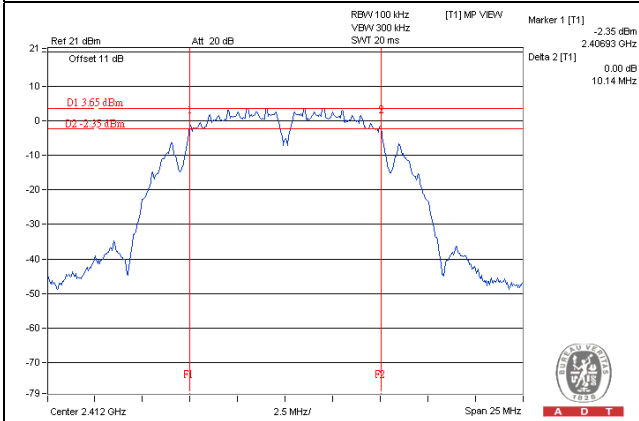

802.11g

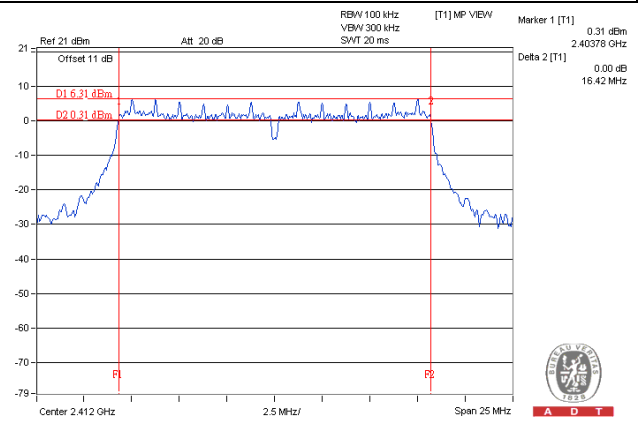

802.11n (HT20)

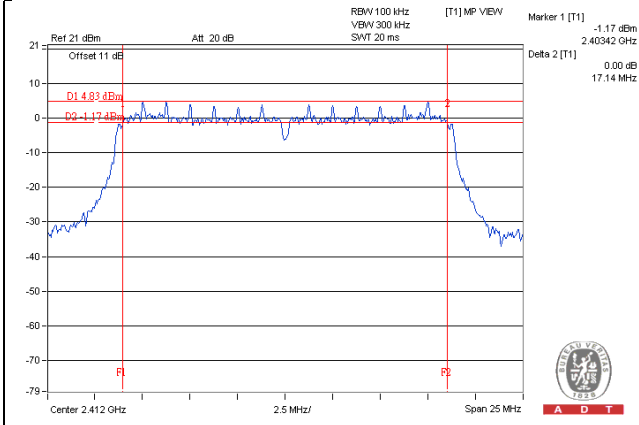

802.11n (HT40)

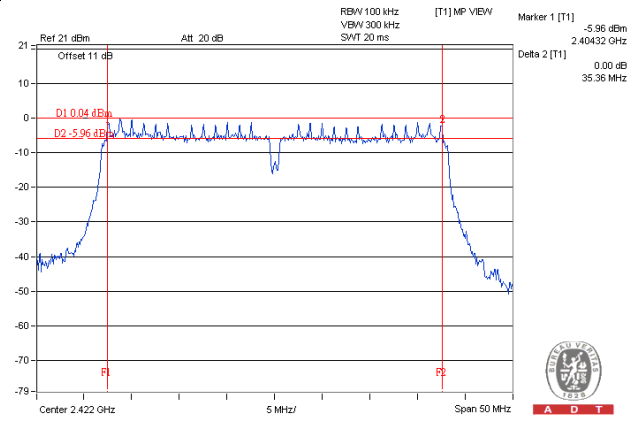

4.4 Conducted Output Power Measurement

4.4.1 Limits of Conducted Output Power Measurement

For systems using digital modulation in the 2400–2483.5 MHz bands: 1 Watt (30dBm)

4.4.2 Test Setup

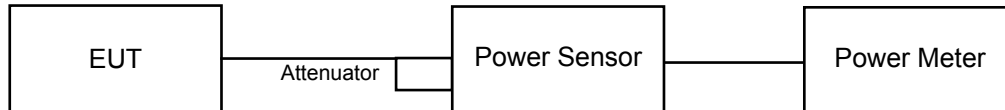

4.4.3 Test Instruments

Refer to section 4.1.2 to get information of above instrument.

4.4.4 Test Procedures

An average power sensor was used on the output port of the EUT. A power meter was used to read the response of the average power sensor. Record the power level.

4.4.5 Deviation from Test Standard

No deviation.

4.4.6 EUT Operating Conditions

Same as Item 4.3.6.

4.4.7 Test Results

802.11b

Channel	Frequency (MHz)	Average Power (mW)	Average Power (dBm)	Limit (dBm)	Pass/Fail
1	2412	25.235	14.02	30	Pass
6	2437	29.174	14.65	30	Pass
11	2462	28.184	14.50	30	Pass

802.11g

Channel	Frequency (MHz)	Average Power (mW)	Average Power (dBm)	Limit (dBm)	Pass/Fail
1	2412	48.641	16.87	30	Pass
6	2437	176.604	22.47	30	Pass
11	2462	58.614	17.68	30	Pass

802.11n (HT20)

Channel	Frequency (MHz)	Average Power (mW)	Average Power (dBm)	Limit (dBm)	Pass/Fail
1	2412	38.194	15.82	30	Pass
6	2437	158.855	22.01	30	Pass
11	2462	43.351	16.37	30	Pass

802.11n (HT40)

Channel	Frequency (MHz)	Average Power (mW)	Average Power (dBm)	Limit (dBm)	Pass/Fail
3	2422	21.528	13.33	30	Pass
6	2437	48.417	16.85	30	Pass
9	2452	45.814	16.61	30	Pass

4.5 Power Spectral Density Measurement

4.5.1 Limits of Power Spectral Density Measurement

The Maximum of Power Spectral Density Measurement is 8dBm.

4.5.2 Test Setup

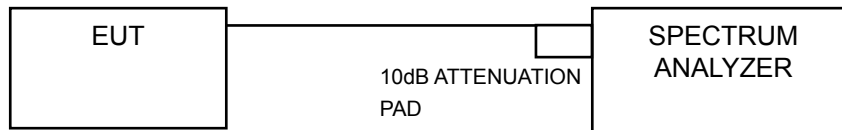

4.5.3 Test Instruments

Refer to section 4.1.2 to get information of above instrument.

4.5.4 Test Procedure

For AVG. power (duty cycle $\geq 98\%$)

- Set instrument center frequency to DTS channel center frequency.
- Set span to at least 1.5 times the OBW.
- Set RBW to: $3 \text{ kHz} \leq \text{RBW} \leq 100 \text{ kHz}$.
- Set VBW $\geq 3 \times \text{RBW}$.
- Detector = power averaging (RMS) or sample detector (when RMS not available).
- Ensure that the number of measurement points in the sweep $\geq 2 \times \text{span}/\text{RBW}$.
- Sweep time = auto couple.
- Employ trace averaging (RMS) mode over a minimum of 100 traces.
- Use the peak marker function to determine the maximum amplitude level.

For AVG. power (duty cycle $< 98\%$)

- Measure the duty cycle (x).
- Set instrument center frequency to DTS channel center frequency.
- Set span to at least 1.5 times the OBW.
- Set RBW to: $3 \text{ kHz} \leq \text{RBW} \leq 100 \text{ kHz}$.
- Set VBW $\geq 3 \times \text{RBW}$.
- Detector = power averaging (RMS) or sample detector (when RMS not available).
- Ensure that the number of measurement points in the sweep $\geq 2 \times \text{span}/\text{RBW}$.
- Sweep time = auto couple.
- Do not use sweep triggering. Allow sweep to "free run".
- Employ trace averaging (RMS) mode over a minimum of 100 traces.
- Use the peak marker function to determine the maximum amplitude level.
- Add $10 \log (1/x)$, where x is the duty cycle measured in step (a), to the measured PSD to compute the average PSD during the actual transmission time.

4.5.5 Deviation from Test Standard

No deviation.

4.5.6 EUT Operating Condition

Same as Item 4.3.6

4.5.7 Test Results

802.11b

Channel	Freq. (MHz)	PSD (dBm)	Limit (dBm)	Pass /Fail
1	2412	-13.83	8	Pass
6	2437	-12.93	8	Pass
11	2462	-13.41	8	Pass

802.11g

Channel	Freq. (MHz)	PSD without Duty Factor (dBm)	Duty Factor	Total PSD with Duty Factor (dBm)	Limit (dBm)	Pass /Fail
1	2412	-15.41	0.62	-14.79	8	Pass
6	2437	-8.80	0.62	-8.18	8	Pass
11	2462	-13.00	0.62	-12.38	8	Pass

NOTE:

1. Method 1 of power density measurement is using for calculating total power density. Total power density is summing entire spectra across corresponding frequency bins on the various outputs by computer.
2. Refer to section 3.3 for duty cycle spectrum plot.

802.11n (HT20)

Channel	Freq. (MHz)	PSD without Duty Factor (dBm)	Duty Factor	Total PSD with Duty Factor (dBm)	Limit (dBm)	Pass /Fail
1	2412	-16.06	0.66	-15.40	8	Pass
6	2437	-10.53	0.66	-9.87	8	Pass
11	2462	-14.11	0.66	-13.45	8	Pass

NOTE:

1. Method 1 of power density measurement is using for calculating total power density. Total power density is summing entire spectra across corresponding frequency bins on the various outputs by computer.
2. Refer to section 3.3 for duty cycle spectrum plot.

802.11n (HT40)

Channel	Freq. (MHz)	PSD without Duty Factor (dBm)	Duty Factor	Total PSD with Duty Factor (dBm)	Limit (dBm)	Pass /Fail
3	2422	-22.56	1.17	-21.39	8	Pass
6	2437	-18.96	1.17	-17.79	8	Pass
9	2452	-20.59	1.17	-19.42	8	Pass

NOTE:

1. Method 1 of power density measurement is using for calculating total power density. Total power density is summing entire spectra across corresponding frequency bins on the various outputs by computer.
2. Refer to section 3.3 for duty cycle spectrum plot.

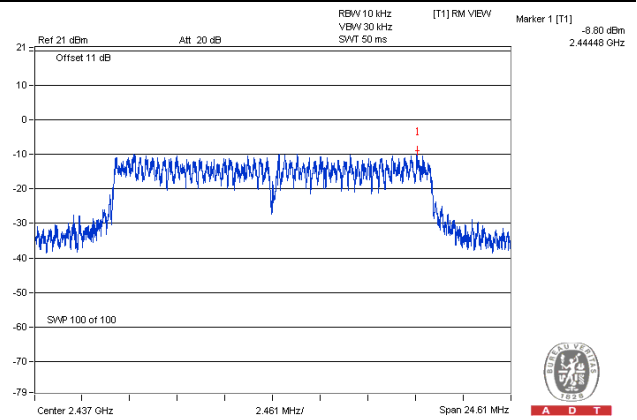
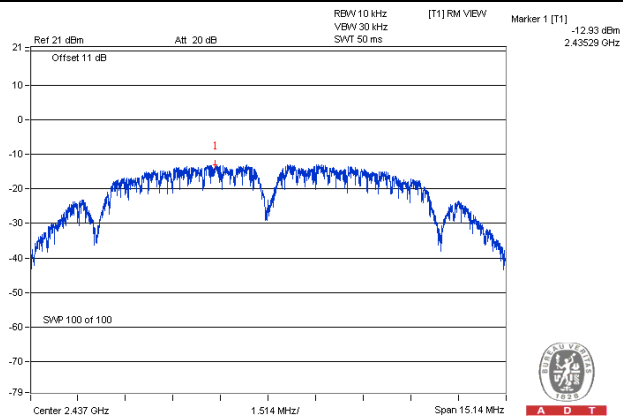
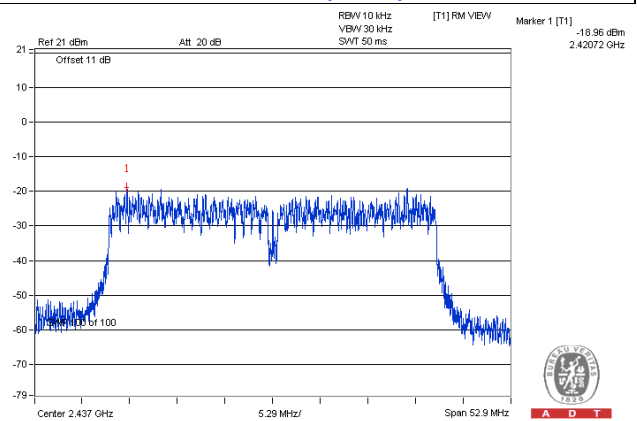
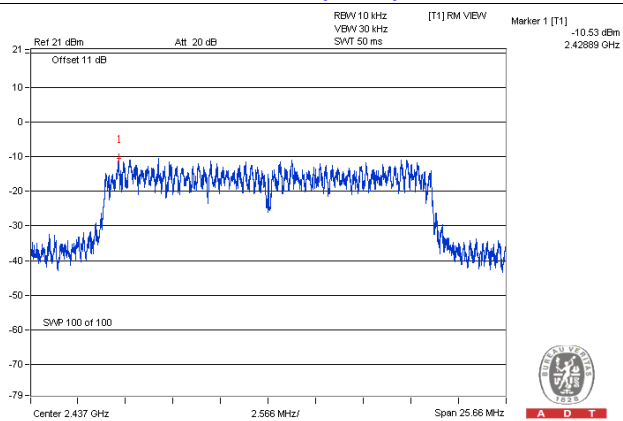
Spectrum Plot of Worst Value**802.11b****802.11g****802.11n (HT20)****802.11n (HT40)**

4.6 Conducted Out of Band Emission Measurement

4.6.1 Limits of Conducted Out of Band Emission Measurement

Below 30dB of the highest emission level of operating band (in 100kHz Resolution Bandwidth).

4.6.2 Test Setup

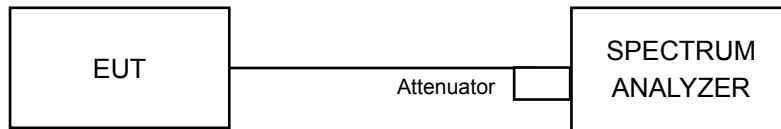

4.6.3 Test Instruments

Refer to section 4.1.2 to get information of above instrument.

4.6.4 Test Procedure

MEASUREMENT PROCEDURE REF

1. Set the RBW = 100 kHz.
2. Set the VBW \geq 300 kHz.
3. Detector = peak.
4. Sweep time = auto couple.
5. Trace mode = max hold.
6. Allow trace to fully stabilize.
7. Use the peak marker function to determine the maximum power level in any 100 kHz band segment within the fundamental EBW.

MEASUREMENT PROCEDURE OOBE

1. Set RBW = 100 kHz.
2. Set VBW \geq 300 kHz.
3. Detector = peak.
4. Sweep = auto couple.
5. Trace Mode = max hold.
6. Allow trace to fully stabilize.
7. Use the peak marker function to determine the maximum amplitude level.

4.6.5 Deviation from Test Standard

No deviation.

4.6.6 EUT Operating Condition

Same as Item 4.3.6

4.6.7 Test Results

The spectrum plots are attached on the following pages. D1 line indicates the highest level, and D2 line indicates the 30dB offset below D1. It shows compliance with the requirement.

802.11b

CH 1

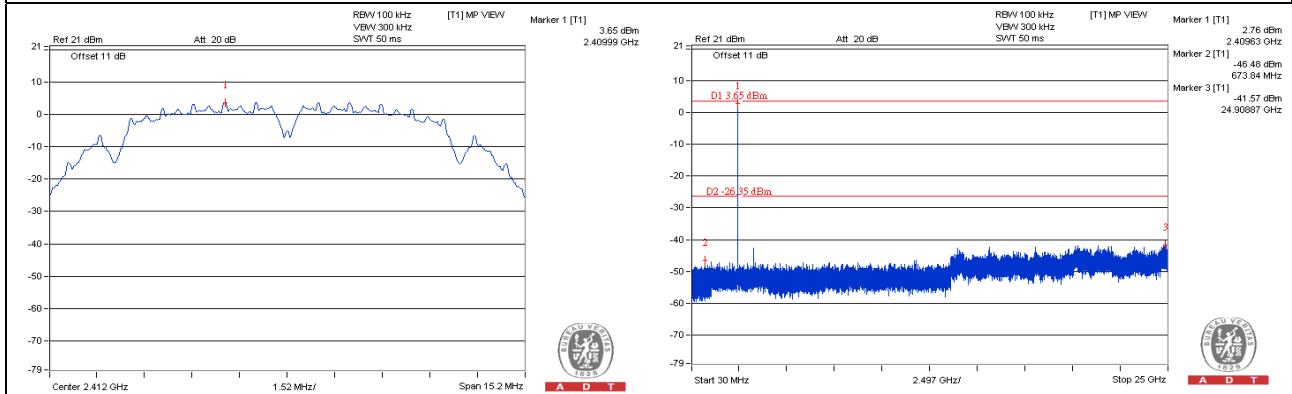

CH 6

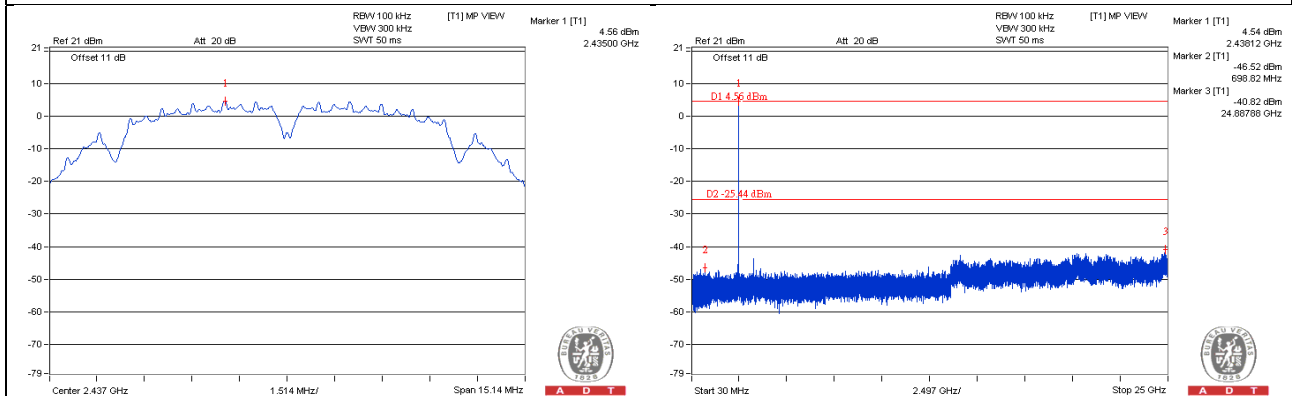

CH 11

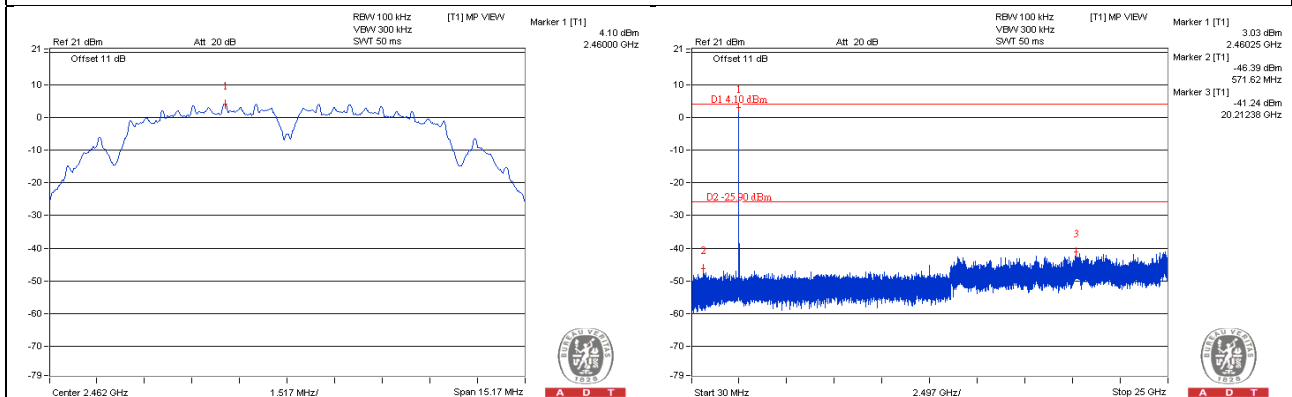

CH 1 Band edge

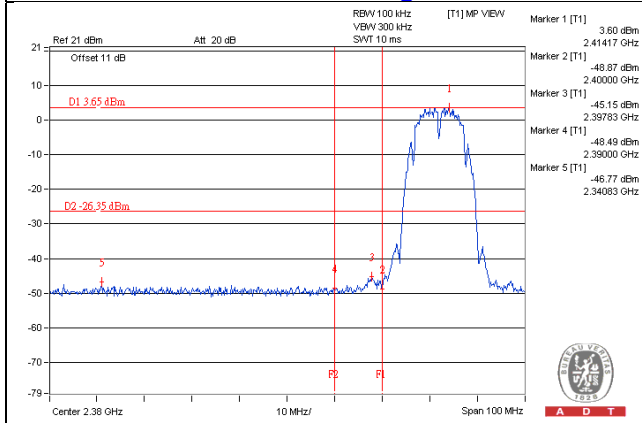

CH 11 Band edge

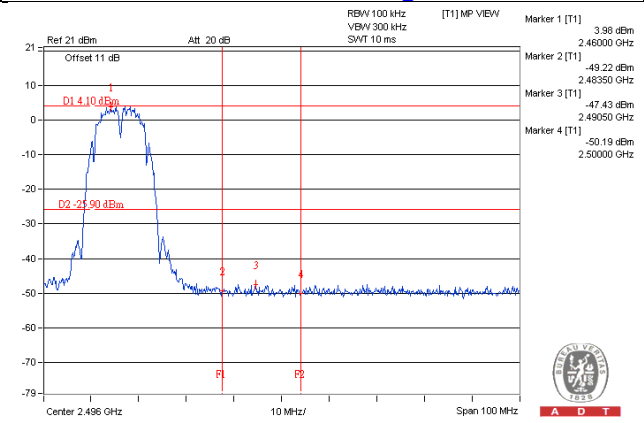

802.11g

CH 1

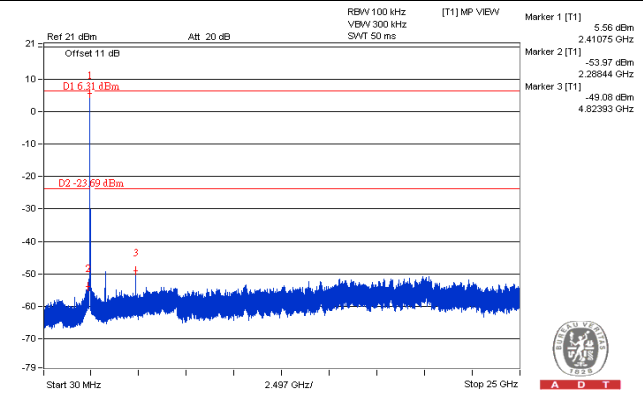
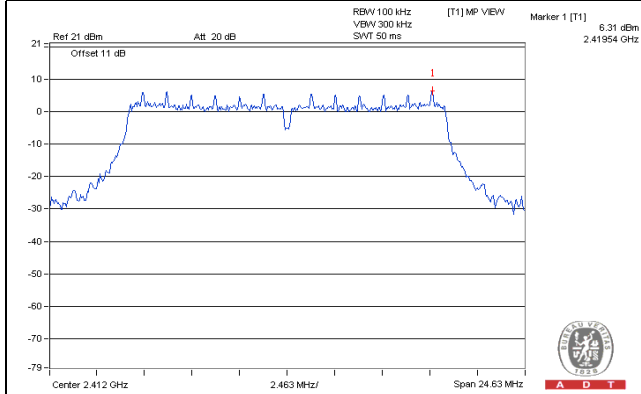

CH 6

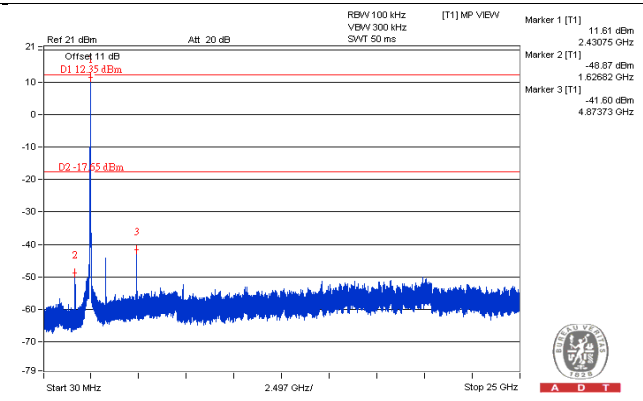
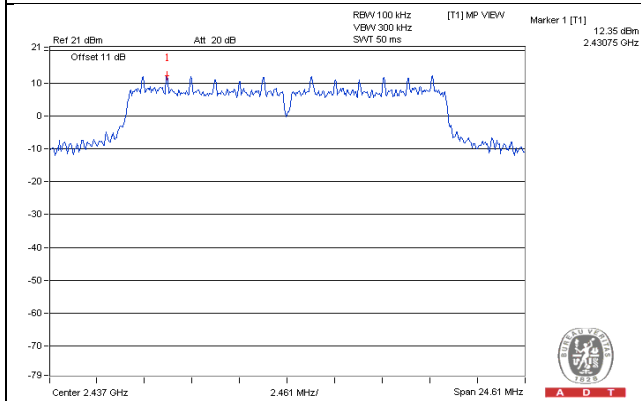

CH 11

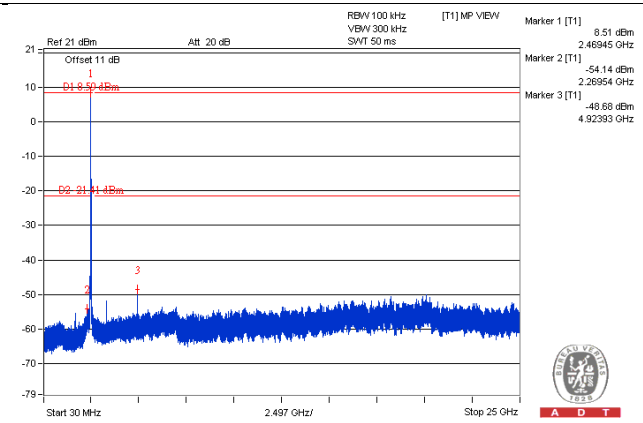
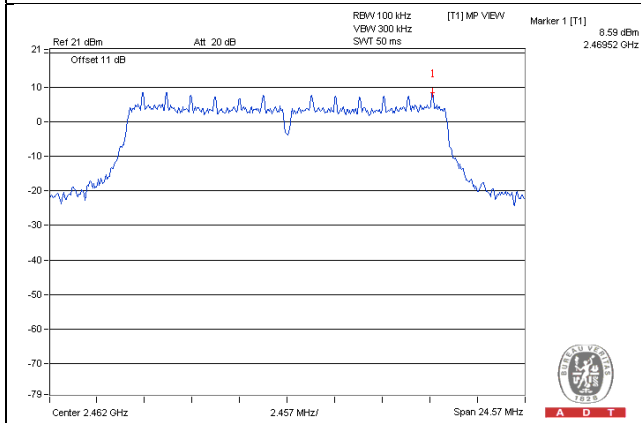

CH 1 Band edge

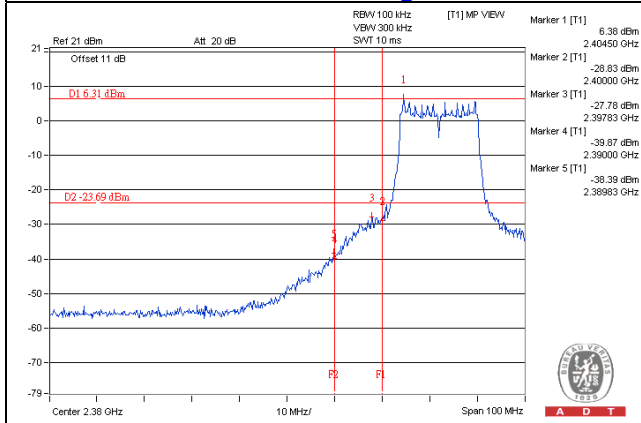

CH 11 Band edge

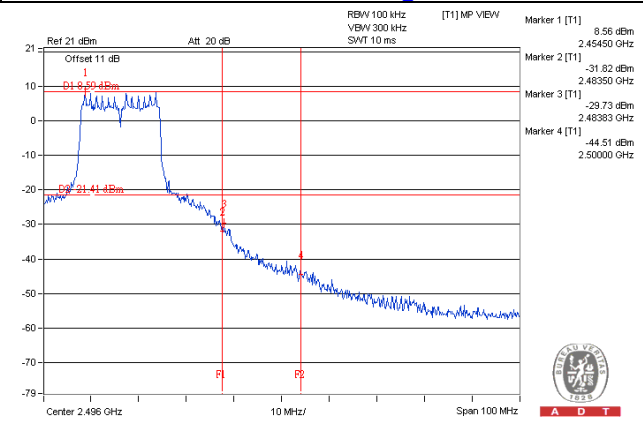

802.11n (HT20)

CH 1

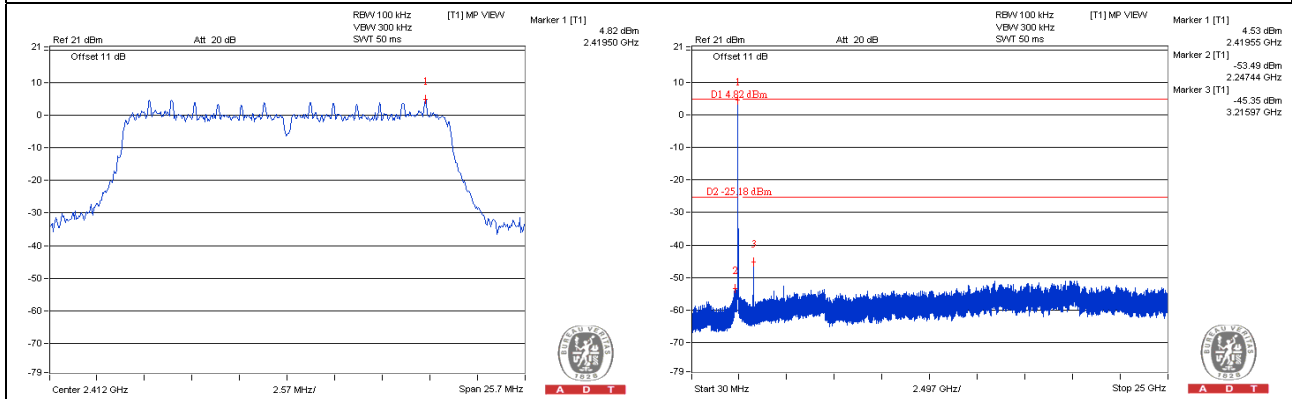

CH 6

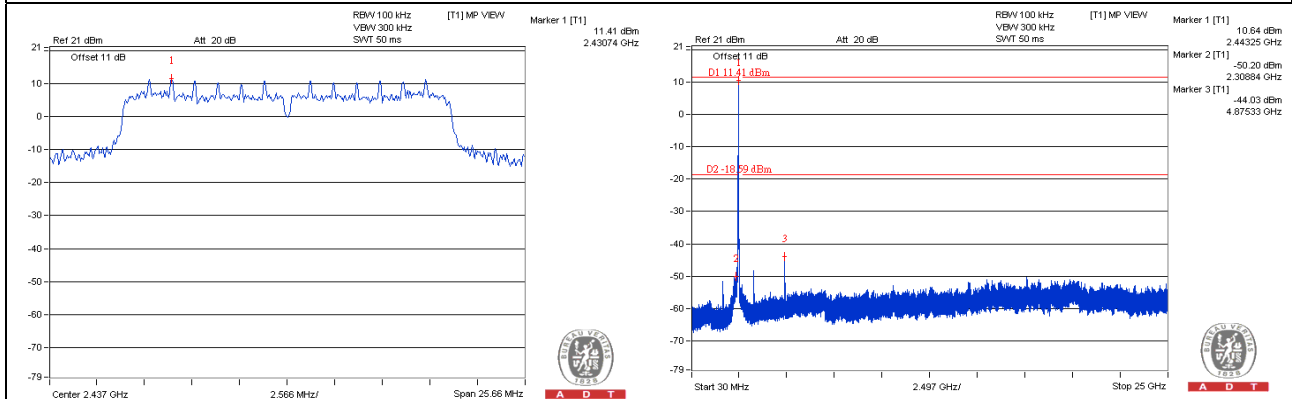

CH 11

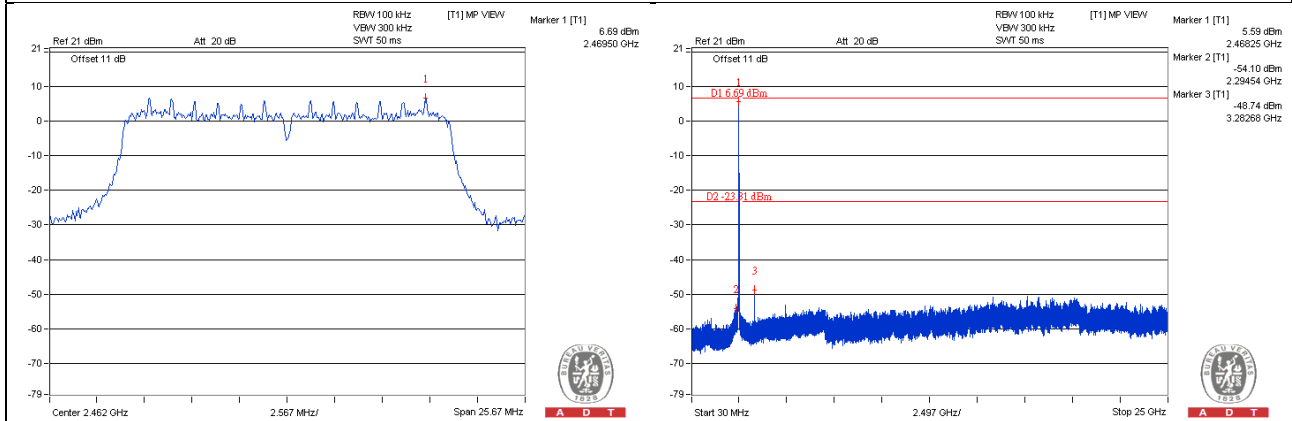

CH 1 Band edge

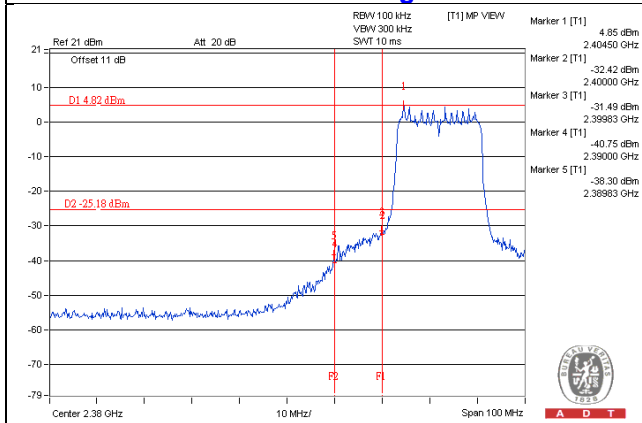

CH 11 Band edge

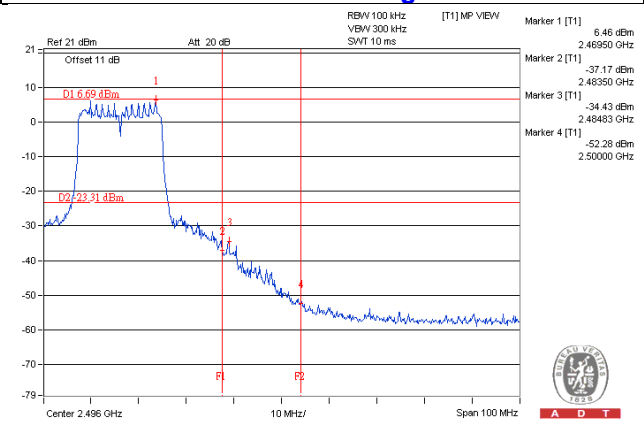

802.11n (HT40)

CH 3

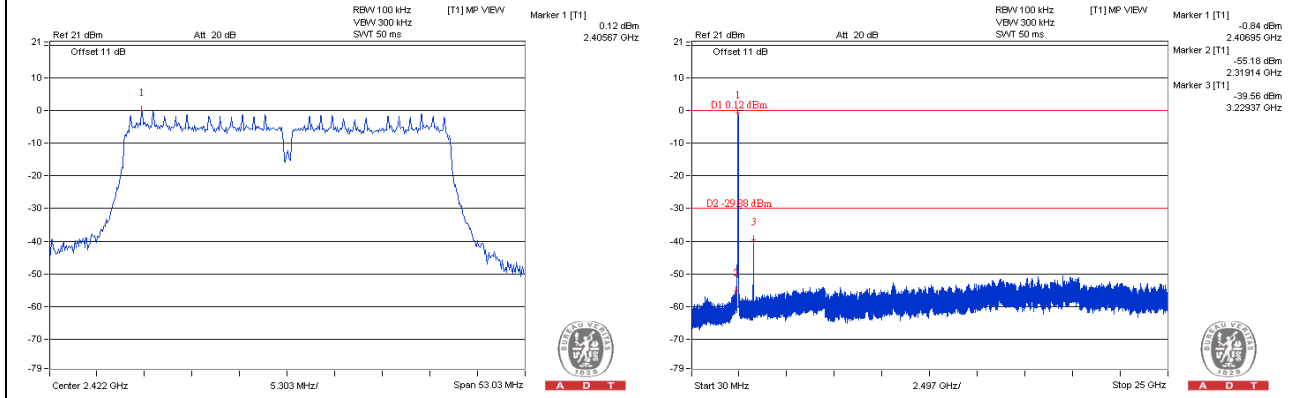

CH 6

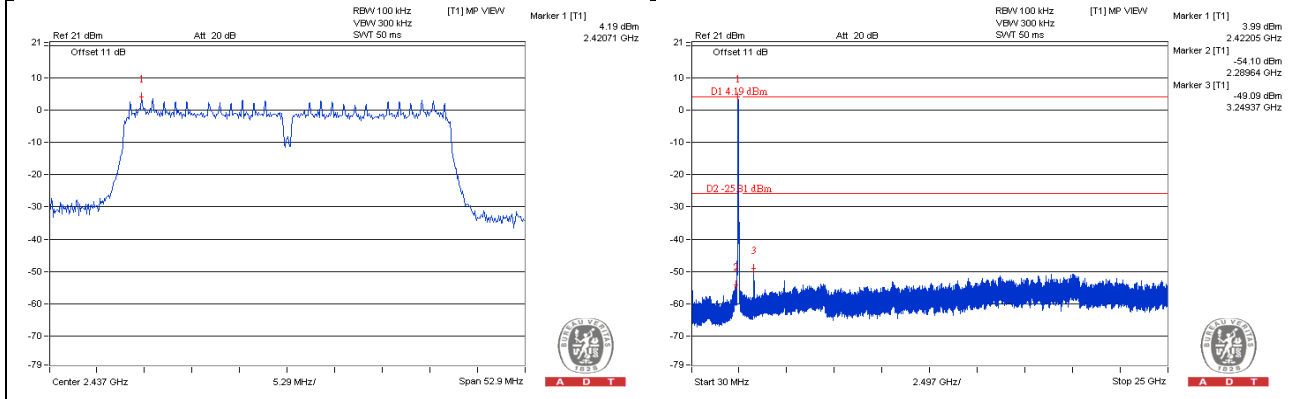

CH 9

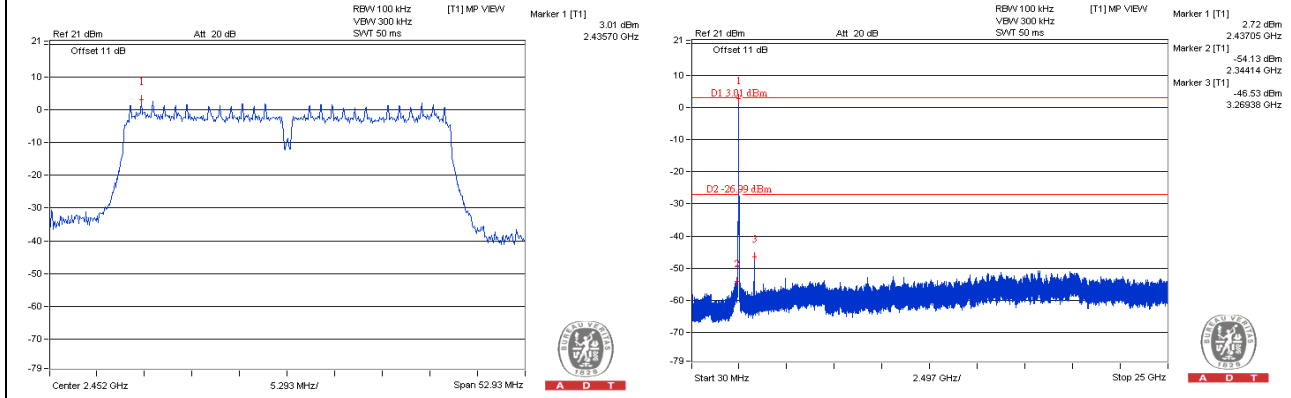

CH 3 Band edge

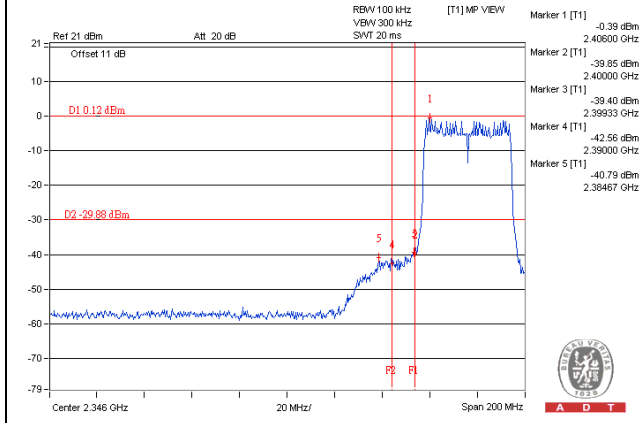

CH 9 Band edge

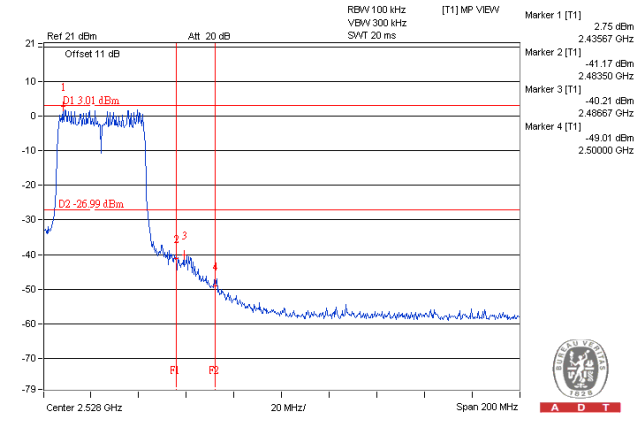

5 Pictures of Test Arrangements

Please refer to the attached file (Test Setup Photo).

Appendix – Information on the Testing Laboratories

We, Bureau Veritas Consumer Products Services (H.K.) Ltd., Taoyuan Branch, were founded in 1988 to provide our best service in EMC, Radio, Telecom and Safety consultation. Our laboratories are accredited and approved according to ISO/IEC 17025.

If you have any comments, please feel free to contact us at the following:

Linko EMC/RF Lab

Tel: 886-2-26052180

Fax: 886-2-26051924

Hsin Chu EMC/RF/Telecom Lab

Tel: 886-3-5935343

Fax: 886-3-5935342

Hwa Ya EMC/RF/Safety Lab

Tel: 886-3-3183232

Fax: 886-3-3270892

Email: service.adt@tw.bureauveritas.com

Web Site: www.bureauveritas-adt.com

The address and road map of all our labs can be found in our web site also.

--- END ---