



# FCC TEST REPORT

**REPORT NO.:** RF150105C16  
**MODEL NO.:** SP-935 (refer to item 3.1 for more details)  
**FCC ID:** A8J-SP935  
**RECEIVED:** Jan. 05, 2015  
**TESTED:** Jan. 07 ~ Jan. 08, 2015  
**ISSUED:** Jan. 19, 2015

**APPLICANT:** EnGenius Technologies

**ADDRESS:** 1580 Scenic Avenue, Costa Mesa, CA92626

**ISSUED BY:** Bureau Veritas Consumer Products Services  
(H.K.) Ltd., Taoyuan Branch

**LAB ADDRESS:** No. 47-2, 14th Ling, Chia Pau Vil., Lin Kou Dist.,  
New Taipei City, Taiwan, R.O.C.

**TEST LOCATION:** No. 19, Hwa Ya 2nd Rd, Wen Hwa Tsuen, Kwei  
Shan Hsiang, Taoyuan Hsien 333, Taiwan, R.O.C.

This report should not be used by the client to claim product certification, approval, or endorsement by TAF or any government agencies.



This report is for your exclusive use. Any copying or replication of this report to or for any other person or entity, or use of our name or trademark, is permitted only with our prior written permission. This report sets forth our findings solely with respect to the test samples identified herein. The results set forth in this report are not indicative or representative of the quality or characteristics of the lot from which a test sample was taken or any similar or identical product unless specifically and expressly noted. Our report includes all of the tests requested by you and the results thereof based upon the information that you provided to us. You have 60 days from date of issuance of this report to notify us of any material error or omission caused by our negligence, provided, however, that such notice shall be in writing and shall specifically address the issue you wish to raise. A failure to raise such issue within the prescribed time shall constitute your unqualified acceptance of the completeness of this report, the tests conducted and the correctness of the report contents. Unless specific mention, the uncertainty of measurement has been explicitly taken into account to declare the compliance or non-compliance to the specification.



# TABLE OF CONTENTS

RELEASE CONTROL RECORD .....	4
1. CERTIFICATION.....	5
2. SUMMARY OF TEST RESULTS .....	6
2.1 MEASUREMENT UNCERTAINTY .....	6
3. GENERAL INFORMATION.....	7
3.1 GENERAL DESCRIPTION OF EUT.....	7
3.2 DESCRIPTION OF TEST MODES.....	8
3.2.1 TEST MODE APPLICABILITY AND TESTED CHANNEL DETAIL.....	9
3.3 DESCRIPTION OF SUPPORT UNITS .....	11
3.3.1 CONFIGURATION OF SYSTEM UNDER TEST .....	11
3.4 GENERAL DESCRIPTION OF APPLIED STANDARDS .....	11
4. TEST TYPES AND RESULTS .....	12
4.1 RADIATED EMISSION AND BANDEDGE MEASUREMENT .....	12
4.1.1 LIMITS OF RADIATED EMISSION AND BANDEDGE MEASUREMENT.....	12
4.1.2 TEST INSTRUMENTS.....	13
4.1.3 TEST PROCEDURES .....	14
4.1.4 DEVIATION FROM TEST STANDARD .....	14
4.1.5 TEST SETUP .....	15
4.1.6 EUT OPERATING CONDITIONS .....	15
4.1.7 TEST RESULTS .....	16
4.2 CONDUCTED EMISSION MEASUREMENT .....	25
4.2.1 LIMITS OF CONDUCTED EMISSION MEASUREMENT .....	25
4.2.2 TEST INSTRUMENTS.....	25
4.2.3 TEST PROCEDURES .....	26
4.2.4 DEVIATION FROM TEST STANDARD .....	26
4.2.5 TEST SETUP .....	26
4.2.6 EUT OPERATING CONDITIONS .....	26
4.2.7 TEST RESULTS .....	27
4.3 NUMBER OF HOPPING FREQUENCY USED.....	33
4.3.1 LIMIT OF HOPPING FREQUENCY USED .....	33
4.3.2 TEST SETUP.....	33
4.3.3 TEST INSTRUMENTS.....	33
4.3.4 TEST PROCEDURES .....	33
4.3.5 DEVIATION FROM TEST STANDARD .....	33
4.3.6 TEST RESULTS .....	33
4.4 DWELL TIME ON EACH CHANNEL .....	35
4.4.1 LIMIT OF DWELL TIME USED.....	35
4.4.2 TEST SETUP .....	35
4.4.3 TEST INSTRUMENTS.....	35
4.4.4 TEST PROCEDURES .....	35
4.4.5 DEVIATION FROM TEST STANDARD .....	35
4.4.6 TEST RESULTS .....	36



4.5	CHANNEL BANDWIDTH.....	37
4.5.1	LIMITS OF CHANNEL BANDWIDTH .....	37
4.5.2	TEST SETUP.....	37
4.5.3	TEST INSTRUMENTS.....	37
4.5.4	TEST PROCEDURE.....	37
4.5.5	DEVIATION FROM TEST STANDARD .....	37
4.5.6	EUT OPERATING CONDITION .....	37
4.5.7	TEST RESULTS .....	38
4.6	HOPPING CHANNEL SEPARATION .....	39
4.6.1	LIMIT OF HOPPING CHANNEL SEPARATION .....	39
4.6.2	TEST SETUP.....	39
4.6.3	TEST INSTRUMENTS.....	39
4.6.4	TEST PROCEDURES .....	39
4.6.5	DEVIATION FROM TEST STANDARD .....	39
4.6.6	TEST RESULTS .....	40
4.7	MAXIMUM OUTPUT POWER.....	41
4.7.1	LIMITS OF MAXIMUM OUTPUT POWER MEASUREMENT .....	41
4.7.2	TEST SETUP.....	41
4.7.3	TEST INSTRUMENTS.....	41
4.7.4	TEST PROCEDURES .....	41
4.7.5	DEVIATION FROM TEST STANDARD .....	41
4.7.6	EUT OPERATING CONDITION .....	41
4.7.7	TEST RESULTS .....	42
4.8	CONDUCTED OUT OF BAND EMISSION MEASUREMENT .....	43
4.8.1	LIMITS OF CONDUCTED OUT OF BAND EMISSION MEASUREMENT.....	43
4.8.2	TEST INSTRUMENTS.....	43
4.8.3	TEST PROCEDURE.....	43
4.8.4	DEVIATION FROM TEST STANDARD .....	43
4.8.5	EUT OPERATING CONDITION .....	43
4.8.6	TEST RESULTS .....	43
5.	PHOTOGRAPHS OF THE TEST CONFIGURATION .....	45
6.	INFORMATION ON THE TESTING LABORATORIES.....	46
7.	APPENDIX A - MODIFICATIONS RECORDERS FOR ENGINEERING CHANGES TO THE EUT BY THE LAB .....	47



## RELEASE CONTROL RECORD

ISSUE NO.	REASON FOR CHANGE	DATE ISSUED
RF150105C16	Original release	Jan. 19, 2015



## 1. CERTIFICATION

**PRODUCT:** Long Range Cordless SIP Phone System  
**MODEL NO.:** SP-935 (refer to item 3.1 for more details)  
**BRAND:** EnGenius  
**APPLICANT:** EnGenius Technologies  
**TESTED:** Jan. 07 ~ Jan. 08, 2015  
**TEST SAMPLE:** ENGINEERING SAMPLE  
**STANDARDS:** **FCC Part 15, Subpart C (Section 15.247)**  
ANSI C63.10-2009

The above equipment (model: SP-935) has been tested by **Bureau Veritas Consumer Products Services (H.K.) Ltd., Taoyuan Branch**, and found compliance with the requirement of the above standards. The test record, data evaluation & Equipment Under Test (EUT) configurations represented herein are true and accurate accounts of the measurements of the sample's EMC characteristics under the conditions specified in this report.

**PREPARED BY** : Polly Chien , **DATE** : Jan. 19, 2015  
Polly Chien / Specialist

**APPROVED BY** : Ken Liu , **DATE** : Jan. 19, 2015  
Ken Liu / Senior Manager

## 2. SUMMARY OF TEST RESULTS

The EUT has been tested according to the following specifications:

APPLIED STANDARD: FCC PART 15, SUBPART C (SECTION 15.247)			
STANDARD SECTION	TEST TYPE AND LIMIT	RESULT	REMARK
15.207	AC Power Conducted Emission	PASS	Meet the requirement of limit. Minimum passing margin is -14.31dB at 15.70703MHz.
15.247(a)(1)(i)	Number of Hopping Frequency Used Spec.: At least 50 channels	PASS	Meet the requirement of limit.
15.247(a)(1)(i)	Dwell Time on Each Channel Spec.: Max. 0.4 second within 20 second	PASS	Meet the requirement of limit.
15.247(a)(1)(i)	1. Hopping Channel Separation Spec.: Min. 25 kHz or 20 dB bandwidth, whichever is greater 2. Spectrum Bandwidth of a Frequency Hopping Sequence Spread Spectrum System	PASS	Meet the requirement of limit.
15.247(b)(2)	Maximum Peak Output Power Spec.: max. 30dBm	PASS	Meet the requirement of limit.
15.247(d)	Transmitter Radiated Emissions Spec.: Table 15.209	PASS	Meet the requirement of limit. Minimum passing margin is -2.5dB at 5414.28MHz.
15.247(d)	Band Edge Measurement	PASS	Meet the requirement of limit.
15.203	Antenna Requirement	PASS	Antenna connector is Reversed TNC not a standard connector.

### 2.1 MEASUREMENT UNCERTAINTY

Where relevant, the following measurement uncertainty levels have been estimated for tests performed on the EUT as specified in CISPR 16-4-2:

MEASUREMENT	FREQUENCY	UNCERTAINTY
Conducted emissions	150kHz~30MHz	2.44 dB
Radiated emissions	30MHz ~ 200MHz	3.86 dB
	200MHz ~1000MHz	3.87 dB
	1GHz ~ 18GHz	2.29 dB
	18GHz ~ 40GHz	2.29 dB

This uncertainty represents an expanded uncertainty expressed at approximately the 95% confidence level using a coverage factor of  $k = 2$ .

### 3. GENERAL INFORMATION

#### 3.1 GENERAL DESCRIPTION OF EUT

<b>EUT</b>	Long Range Cordless SIP Phone System
<b>MODEL NO.</b>	SP-935 (refer to note for more details)
<b>POWER SUPPLY</b>	12Vdc (Adapter)
<b>MODULATION TYPE</b>	MSK
<b>TRANSFER RATE</b>	170.66kbps
<b>CHANNEL SPACING</b>	202.272kHz
<b>OPERATING FREQUENCY</b>	902.3840 ~ 927.4656MHz
<b>NUMBER OF CHANNEL</b>	50
<b>OUTPUT POWER</b>	859.014mW
<b>ANTENNA TYPE</b>	Dipole antenna with 2dBi gain
<b>ANTENNA CONNECTOR</b>	Reversed TNC
<b>DATA CABLE</b>	1.8m non-shielded RJ11 cable W/O core 1.8m non-shielded audio cable W/O core 1m non-shielded RJ45 cable W/O core 1m non-shielded ground cable W/O core
<b>I/O PORTS</b>	Refer to user's manual
<b>ACCESSORY DEVICES</b>	Adapter

**NOTE:**

- The following models are electrically identical, different model names are for marketing purpose.

BRAND	MODEL
EnGenius	SP-935
	DuraFon-SIP

\* The model of the SP-935 was chosen for final test.

- The EUT uses following adapter.

ADAPTER	
<b>BRAND</b>	DVE
<b>MODEL</b>	DSA-12G-12 FUS 120120
<b>INPUT POWER</b>	100-240Vac~50/60Hz 0.3A
<b>OUTPUT POWER</b>	12Vdc, 1A
<b>POEWR LINE</b>	1.45m power cable w/o core attached on adapter

- The above EUT information was declared by the manufacturer and for more detailed feature description, please refer to the manufacturer's specifications or User's Manual.

### 3.2 DESCRIPTION OF TEST MODES

50 channels are provided to this EUT:

CH.	FREQ. (MHz)	CH.	FREQ. (MHz)	CH.	FREQ. (MHz)	CH.	FREQ. (MHz)	CH.	FREQ. (MHz)
1	902.3840	11	907.6430	21	912.4975	31	918.1611	41	923.0157
2	902.7885	12	908.0476	22	912.9021	32	918.9702	42	923.8247
3	903.1930	13	908.4521	23	913.3066	33	919.3748	43	924.2293
4	903.5976	14	909.2612	24	914.1157	34	919.7793	44	924.6338
5	904.4067	15	909.6657	25	914.9248	35	920.1839	45	925.0384
6	904.8112	16	910.0703	26	915.3293	36	920.5884	46	925.4429
7	905.2158	17	910.4748	27	915.7339	37	921.3975	47	926.2520
8	905.6203	18	910.8797	28	916.5430	38	921.8020	48	926.6566
9	906.0248	19	911.6885	29	917.3521	39	922.2066	49	927.0611
10	906.8339	20	912.0930	30	917.7566	40	922.6111	50	927.4656



### 3.2.1 TEST MODE APPLICABILITY AND TESTED CHANNEL DETAIL

EUT CONFIGURE MODE	APPLICABLE TO				DESCRIPTION
	RE $\geq$ 1G	RE $<$ 1G	PLC	APCM	
-	√	√	√	√	-

Where **RE $\geq$ 1G**: Radiated Emission above 1GHz      **RE $<$ 1G**: Radiated Emission below 1GHz  
**PLC**: Power Line Conducted Emission      **APCM**: Antenna Port Conducted Measurement

**NOTE:** The EUT had been pre-tested on the positioned of each 3 axis. The worst case was found when positioned on X-plane.

#### **RADIATED EMISSION TEST (ABOVE 1GHz):**

- Pre-Scan has been conducted to determine the worst-case mode from all possible combinations between available modulations, data rates and antenna ports (if EUT with antenna diversity architecture).
- Following channel(s) was (were) selected for the final test as listed below.

EUT CONFIGURE MODE	AVAILABLE CHANNEL	TESTED CHANNEL	MODULATION TYPE
-	1 to 50	1, 25, 50	MSK

#### **RADIATED EMISSION TEST (BELOW 1GHz):**

- Pre-Scan has been conducted to determine the worst-case mode from all possible combinations between available modulations, data rates and antenna ports (if EUT with antenna diversity architecture).
- Following channel(s) was (were) selected for the final test as listed below.

EUT CONFIGURE MODE	AVAILABLE CHANNEL	TESTED CHANNEL	MODULATION TYPE
-	1 to 50	1, 25, 50	MSK

#### **POWER LINE CONDUCTED EMISSION TEST:**

- Pre-Scan has been conducted to determine the worst-case mode from all possible combinations between available modulations, data rates and antenna ports (if EUT with antenna diversity architecture).
- Following channel(s) was (were) selected for the final test as listed below.

EUT CONFIGURE MODE	AVAILABLE CHANNEL	TESTED CHANNEL	MODULATION TYPE
-	1 to 50	1, 25, 50	MSK

**BANDEDGE MEASUREMENT:**

- Pre-Scan has been conducted to determine the worst-case mode from all possible combinations between available modulations, data rates and antenna ports (if EUT with antenna diversity architecture).
- Following channel(s) was (were) selected for the final test as listed below.

EUT CONFIGURE MODE	AVAILABLE CHANNEL	TESTED CHANNEL	MODULATION TYPE
-	1 to 50	1, 50	MSK

**ANTENNA PORT CONDUCTED MEASUREMENT:**

- This item includes all test value of each mode, but only includes spectrum plot of worst value of each mode.
- Pre-Scan has been conducted to determine the worst-case mode from all possible combinations between available modulations, data rates and antenna ports (if EUT with antenna diversity architecture).
- Following channel(s) was (were) selected for the final test as listed below.

EUT CONFIGURE MODE	AVAILABLE CHANNEL	TESTED CHANNEL	MODULATION TYPE
-	1 to 50	1, 25, 50	MSK

**TEST CONDITION:**

APPLICABLE TO	ENVIRONMENTAL CONDITIONS	INPUT POWER	TESTED BY
RE≥1G	18deg. C, 72%RH	120Vac, 60Hz	Nick Hsu
RE<1G	18deg. C, 72%RH	120Vac, 60Hz	Nick Hsu
PLC	19deg. C, 70%RH	120Vac, 60Hz	Nick Hsu
APCM	25deg. C, 60%RH	120Vac, 60Hz	Jun Wu

### 3.3 DESCRIPTION OF SUPPORT UNITS

The EUT has been tested as an independent unit.

#### 3.3.1 CONFIGURATION OF SYSTEM UNDER TEST

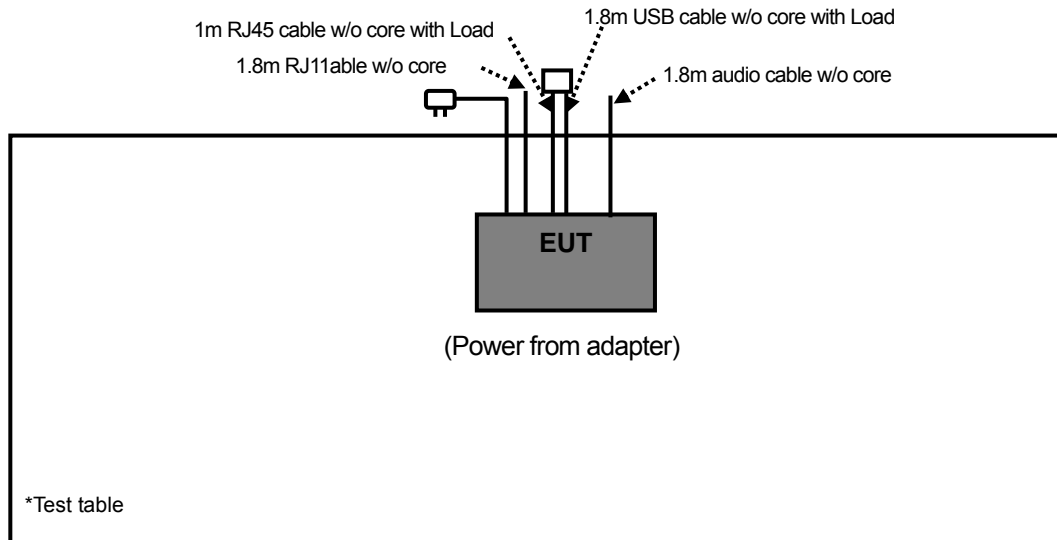

### 3.4 GENERAL DESCRIPTION OF APPLIED STANDARDS

The EUT is a RF Product. According to the specifications of the manufacturer, it must comply with the requirements of the following standards:

**FCC Part 15, Subpart C (15.247)**

ANSI C63.10-2009

All test items have been performed and recorded as per the above standards.

## 4. TEST TYPES AND RESULTS

### 4.1 RADIATED EMISSION AND BANDEDGE MEASUREMENT

#### 4.1.1 LIMITS OF RADIATED EMISSION AND BANDEDGE MEASUREMENT

Emissions radiated outside of the specified bands, shall be according to the general radiated limits in 15.209 as following:

FREQUENCIES (MHz)	FIELD STRENGTH (microvolts/meter)	MEASUREMENT DISTANCE (meters)
0.009 ~ 0.490	2400/F(kHz)	300
0.490 ~ 1.705	24000/F(kHz)	30
1.705 ~ 30.0	30	30
30 ~ 88	100	3
88 ~ 216	150	3
216 ~ 960	200	3
Above 960	500	3

**NOTE:**

1. The lower limit shall apply at the transition frequencies.
2. Emission level (dBuV/m) = 20 log Emission level (uV/m).
3. For frequencies above 1000MHz, the field strength limits are based on average detector, however, the peak field strength of any emission shall not exceed the maximum permitted average limits, specified above by more than 20dB under any condition of modulation.



#### 4.1.2 TEST INSTRUMENTS

DESCRIPTION & MANUFACTURER	MODEL NO.	SERIAL NO.	DATE OF CALIBRATION	DUE DATE OF CALIBRATION
Test Receiver ROHDE & SCHWARZ	ESCI	100424	Oct. 06, 2014	Oct. 05, 2015
Spectrum Analyzer ROHDE & SCHWARZ	FSP40	100039	Mar. 03, 2014	Mar. 02, 2015
BILOG Antenna SCHWARZBECK	VULB9168	9168-160	Feb. 26, 2014	Feb. 25, 2015
HORN Antenna SCHWARZBECK	9120D	209	Aug. 25, 2014	Aug. 24, 2015
HORN Antenna SCHWARZBECK	BBHA 9170	BBHA9170241	Feb. 17, 2014	Feb. 16, 2015
Loop Antenna	HFH2-Z2	100070	Mar. 06, 2014	Mar. 05, 2016
Preamplifier Agilent	8447D	2944A10738	Oct. 18, 2014	Oct. 17, 2015
Preamplifier Agilent	8449B	3008A01964	Aug. 22, 2014	Aug. 21, 2015
RF signal cable HUBER+SUHNNER	SUCOFLEX 104	214378/4	Aug. 22, 2014	Aug. 21, 2015
RF signal cable HUBER+SUHNNER	SUCOFLEX 106	12738/6 +309224/4	Aug. 22, 2014	Aug. 21, 2015
Software BV ADT	ADT_Radiated_ V7.6.15.9.4	NA	NA	NA
Antenna Tower inn-co GmbH	MA 4000	013303	NA	NA
Antenna Tower Controller inn-co GmbH	CO2000	017303	NA	NA
Turn Table BV ADT	TT100	TT93021703	NA	NA
Turn Table Controller BV ADT	SC100	SC93021703	NA	NA

- NOTE:**
1. The calibration interval of the above test instruments is 12 months and the calibrations are traceable to NML/ROC and NIST/USA.
  2. The calibration interval of the loop antenna is 24 months and the calibrations are traceable to NML/ROC and NIST/USA.
  3. The test was performed in HwaYa Chamber 3.
  4. The horn antenna and HP preamplifier (model: 8449B) are used only for the measurement of emission frequency above 1GHz if tested.
  5. The FCC Site Registration No. is 988962.
  6. The IC Site Registration No. is IC 7450F-3.

#### 4.1.3 TEST PROCEDURES

- a. The EUT was placed on the top of a rotating table 0.8 meters above the ground at a 3 meters semi-anechoic chamber. The table was rotated 360 degrees to determine the position of the highest radiation.
- b. The EUT was set 3 meters away from the interference-receiving antenna, which was mounted on the top of a variable-height antenna tower.
- c. Height of receiving antenna is varied from one meter to four meters above the ground to determine the maximum value of the field strength. Both horizontal and vertical polarizations of the antenna are set to make the measurement.
- d. For each suspected emission, the EUT was arranged to its worst case and then the antenna was tuned to heights from 1 meter to 4 meters and the rotatable table was turned from 0 degrees to 360 degrees to find the maximum reading.
- e. The test-receiver system was set to Peak Detect Function and Specified Bandwidth with Maximum Hold Mode.
- f. If the emission level of the EUT in peak mode was lower than the limit specified, then testing could be stopped and the peak values of the EUT would be reported. Otherwise the emissions would be re-tested one by one using peak, quasi-peak or average method as specified and then reported in a data sheet.

**NOTE:**

1. The resolution bandwidth and video bandwidth of test receiver/spectrum analyzer is 120kHz for Quasi-peak detection at frequency below 1GHz.
2. The resolution bandwidth of test receiver/spectrum analyzer is 1MHz and video bandwidth is 3MHz for Peak detection at frequency above 1GHz.
3. The resolution bandwidth of test receiver/spectrum analyzer is 1MHz and the video bandwidth is  $\geq 1/T$  (Duty cycle  $< 98\%$ ) or 10Hz (Duty cycle  $> 98\%$ ) for Average detection (AV) at frequency above 1GHz.
4. All modes of operation were investigated and the worst-case emissions are reported.

#### 4.1.4 DEVIATION FROM TEST STANDARD

No deviation.

#### 4.1.5 TEST SETUP

##### Frequency range 30MHz~1GHz

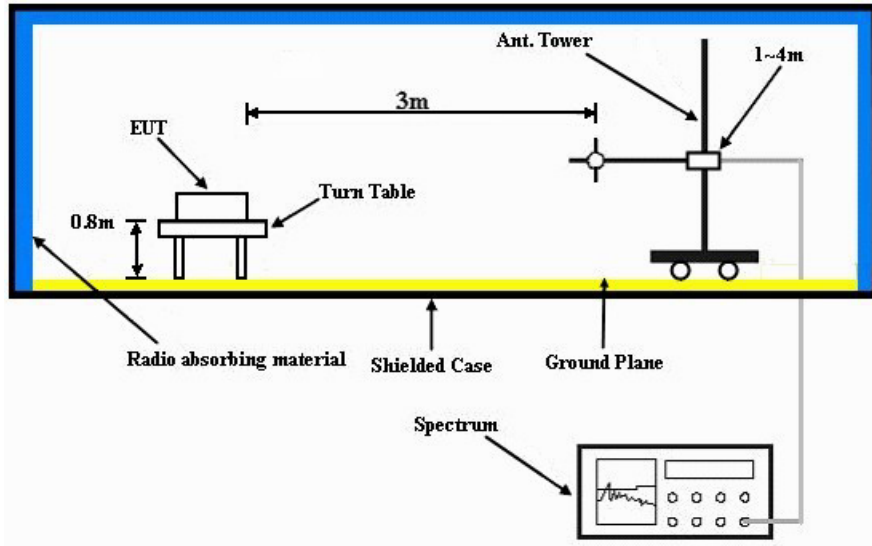

##### Frequency range above 1GHz

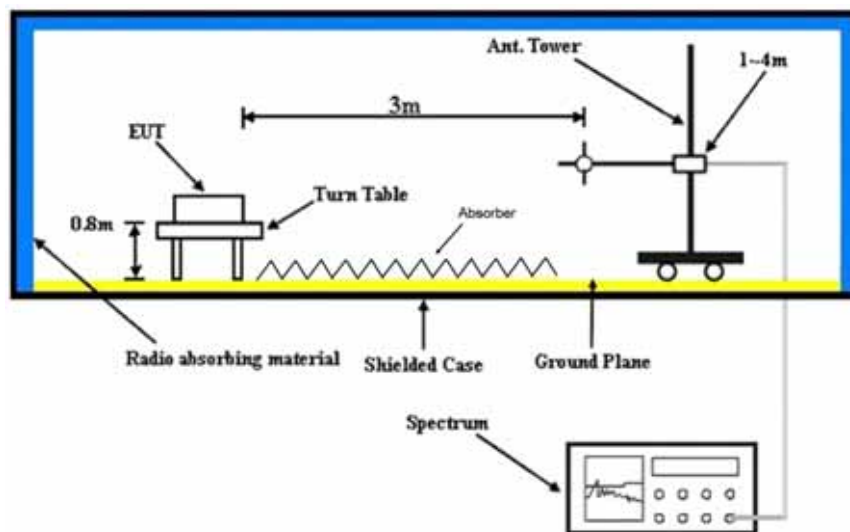

For the actual test configuration, please refer to the attached file (Test Setup Photo).

#### 4.1.6 EUT OPERATING CONDITIONS

- Placed the EUT on a testing table.
- Set the EUT under transmission condition continuously at specific channel frequency.
- The necessary accessories enable the system in full functions.

#### 4.1.7 TEST RESULTS

EUT TEST CONDITION		MEASUREMENT DETAIL	
CHANNEL	Channel 1	FREQUENCY RANGE	Below 1000MHz
INPUT POWER	120Vac, 60Hz	DETECTOR FUNCTION	Peak (PK) Average (AV)
ENVIRONMENTAL CONDITIONS	18deg. C, 72%RH	TESTED BY	Nick Hsu

ANTENNA POLARITY & TEST DISTANCE: HORIZONTAL AT 3 M								
NO.	FREQ. (MHz)	EMISSION LEVEL (dBuV/m)	LIMIT (dBuV/m)	MARGIN (dB)	ANTENNA HEIGHT (m)	TABLE ANGLE (Degree)	RAW VALUE (dBuV)	CORRECTION FACTOR (dB/m)
1	#902.00	76.8 PK	96.9	-20.1	1.54 H	359	49.10	27.70
2	#902.00	67.4 AV	94.9	-27.5	1.54 H	359	39.70	27.70
3	*902.38	116.9 PK			1.54 H	359	89.20	27.70
4	*902.38	114.9 AV			1.54 H	359	87.20	27.70
ANTENNA POLARITY & TEST DISTANCE: VERTICAL AT 3 M								
NO.	FREQ. (MHz)	EMISSION LEVEL (dBuV/m)	LIMIT (dBuV/m)	MARGIN (dB)	ANTENNA HEIGHT (m)	TABLE ANGLE (Degree)	RAW VALUE (dBuV)	CORRECTION FACTOR (dB/m)
1	#902.00	82.9 PK	107.7	-24.8	1.00 V	60	55.20	27.70
2	#902.00	75.4 AV	105.7	-30.3	1.00 V	60	47.70	27.70
3	*902.38	127.7 PK			1.00 V	60	100.00	27.70
4	*902.38	125.7 AV			1.00 V	60	98.00	27.70

#### REMARKS:

1. Emission level (dBuV/m) = Raw Value (dBuV) + Correction Factor (dB/m).
2. Correction Factor(dB/m) = Antenna Factor(dB/m) + Cable Factor(dB)  
– Pre-Amplifier Factor (dB)
3. The other emission levels were very low against the limit.
4. Margin value = Emission level – Limit value.
5. “ \* “: Fundamental frequency.
6. “#”:The radiated frequency is out the restricted band.





EUT TEST CONDITION		MEASUREMENT DETAIL	
CHANNEL	Channel 25	FREQUENCY RANGE	Below 1000MHz
INPUT POWER	120Vac, 60Hz	DETECTOR FUNCTION	Peak (PK) Average (AV)
ENVIRONMENTAL CONDITIONS	18deg. C, 72%RH	TESTED BY	Nick Hsu

ANTENNA POLARITY & TEST DISTANCE: HORIZONTAL AT 3 M								
NO.	FREQ. (MHz)	EMISSION LEVEL (dBuV/m)	LIMIT (dBuV/m)	MARGIN (dB)	ANTENNA HEIGHT (m)	TABLE ANGLE (Degree)	RAW VALUE (dBuV)	CORRECTION FACTOR (dB/m)
1	*914.92	119.4 PK			1.54 H	333	91.40	28.00
2	*914.92	117.2 AV			1.54 H	333	89.20	28.00
ANTENNA POLARITY & TEST DISTANCE: VERTICAL AT 3 M								
NO.	FREQ. (MHz)	EMISSION LEVEL (dBuV/m)	LIMIT (dBuV/m)	MARGIN (dB)	ANTENNA HEIGHT (m)	TABLE ANGLE (Degree)	RAW VALUE (dBuV)	CORRECTION FACTOR (dB/m)
1	*914.92	129.1 PK			1.00 V	65	101.10	28.00
2	*914.92	127.0 AV			1.00 V	65	99.00	28.00

**REMARKS:**

1. Emission level (dBuV/m) = Raw Value (dBuV) + Correction Factor (dB/m).
2. Correction Factor(dB/m) = Antenna Factor(dB/m) + Cable Factor(dB)  
– Pre-Amplifier Factor (dB)
3. The other emission levels were very low against the limit.
4. Margin value = Emission level – Limit value.
5. “ \* “: Fundamental frequency.
6. “#”:The radiated frequency is out the restricted band.

EUT TEST CONDITION		MEASUREMENT DETAIL	
CHANNEL	Channel 50	FREQUENCY RANGE	Below 1000MHz
INPUT POWER	120Vac, 60Hz	DETECTOR FUNCTION	Peak (PK) Average (AV)
ENVIRONMENTAL CONDITIONS	18deg. C, 72%RH	TESTED BY	Nick Hsu

ANTENNA POLARITY & TEST DISTANCE: HORIZONTAL AT 3 M								
NO.	FREQ. (MHz)	EMISSION LEVEL (dBuV/m)	LIMIT (dBuV/m)	MARGIN (dB)	ANTENNA HEIGHT (m)	TABLE ANGLE (Degree)	RAW VALUE (dBuV)	CORRECTION FACTOR (dB/m)
1	*927.46	119.1 PK			1.47 H	287	90.90	28.20
2	*927.46	116.9 AV			1.47 H	287	88.70	28.20
3	#928.00	73.8 PK	99.1	-25.3	1.47 H	287	45.60	28.20
4	#928.00	65.6 AV	96.9	-31.3	1.47 H	287	37.40	28.20

ANTENNA POLARITY & TEST DISTANCE: VERTICAL AT 3 M								
NO.	FREQ. (MHz)	EMISSION LEVEL (dBuV/m)	LIMIT (dBuV/m)	MARGIN (dB)	ANTENNA HEIGHT (m)	TABLE ANGLE (Degree)	RAW VALUE (dBuV)	CORRECTION FACTOR (dB/m)
1	*927.46	129.3 PK			1.00 V	270	101.10	28.20
2	*927.46	127.1 AV			1.00 V	270	98.90	28.20
3	#928.00	74.3 PK	109.3	-35.0	1.00 V	270	46.10	28.20
4	#928.00	67.5 AV	107.1	-39.6	1.00 V	270	39.30	28.20

**REMARKS:**

1. Emission level (dBuV/m) = Raw Value (dBuV) + Correction Factor (dB/m).
2. Correction Factor(dB/m) = Antenna Factor(dB/m) + Cable Factor(dB) – Pre-Amplifier Factor (dB)
3. The other emission levels were very low against the limit.
4. Margin value = Emission level – Limit value.
5. “ \* “: Fundamental frequency.
6. “#”:The radiated frequency is out the restricted band.

**ABOVE 1GHz DATA**

EUT TEST CONDITION		MEASUREMENT DETAIL	
CHANNEL	Channel 1	FREQUENCY RANGE	1 ~ 25GHz
INPUT POWER	120Vac, 60 Hz	DETECTOR FUNCTION	Peak (PK) Average (AV)
ENVIRONMENTAL CONDITIONS	18deg. C, 72%RH	TESTED BY	Nick Hsu

ANTENNA POLARITY & TEST DISTANCE: HORIZONTAL AT 3 M								
NO.	FREQ. (MHz)	EMISSION LEVEL (dBuV/m)	LIMIT (dBuV/m)	MARGIN (dB)	ANTENNA HEIGHT (m)	TABLE ANGLE (Degree)	RAW VALUE (dBuV)	CORRECTION FACTOR (dB/m)
1	1804.76	43.4 PK	74.0	-30.6	1.06 H	57	46.90	-3.50
2	1804.76	34.3 AV	54.0	-19.7	1.06 H	57	37.80	-3.50
3	2707.14	43.0 PK	74.0	-31.0	1.16 H	190	43.20	-0.20
4	2707.14	35.6 AV	54.0	-18.4	1.16 H	190	35.80	-0.20
5	5414.28	51.6 PK	74.0	-22.4	1.11 H	184	45.00	6.60
6	5414.28	42.8 AV	54.0	-11.2	1.11 H	184	36.20	6.60
ANTENNA POLARITY & TEST DISTANCE: VERTICAL AT 3 M								
NO.	FREQ. (MHz)	EMISSION LEVEL (dBuV/m)	LIMIT (dBuV/m)	MARGIN (dB)	ANTENNA HEIGHT (m)	TABLE ANGLE (Degree)	RAW VALUE (dBuV)	CORRECTION FACTOR (dB/m)
1	1804.76	40.8 PK	74.0	-33.2	1.00 V	256	44.30	-3.50
2	1804.76	34.9 AV	54.0	-19.1	1.00 V	256	38.40	-3.50
3	2707.14	43.9 PK	74.0	-30.1	1.00 V	257	44.10	-0.20
4	2707.14	38.0 AV	54.0	-16.0	1.00 V	257	38.20	-0.20
5	5414.28	56.7 PK	74.0	-17.3	1.02 V	145	50.10	6.60
6	5414.28	51.5 AV	54.0	-2.5	1.02 V	145	44.90	6.60

**REMARKS:**

1. Emission Level(dBuV/m) = Raw Value(dBuV) + Correction Factor(dB/m)
2. Correction Factor(dB/m) = Antenna Factor(dB/m) + Cable Factor(dB)  
– Pre-Amplifier Factor (dB)
3. The other emission levels were very low against the limit.
4. Margin value = Emission Level – Limit value



A D T

EUT TEST CONDITION		MEASUREMENT DETAIL	
CHANNEL	Channel 25	FREQUENCY RANGE	1 ~ 25GHz
INPUT POWER	120Vac, 60 Hz	DETECTOR FUNCTION	Peak (PK) Average (AV)
ENVIRONMENTAL CONDITIONS	18deg. C, 72%RH	TESTED BY	Nick Hsu

ANTENNA POLARITY & TEST DISTANCE: HORIZONTAL AT 3 M								
NO.	FREQ. (MHz)	EMISSION LEVEL (dBuV/m)	LIMIT (dBuV/m)	MARGIN (dB)	ANTENNA HEIGHT (m)	TABLE ANGLE (Degree)	RAW VALUE (dBuV)	CORRECTION FACTOR (dB/m)
1	1829.84	43.8 PK	74.0	-30.2	1.52 H	53	47.30	-3.50
2	1829.84	38.7 AV	54.0	-15.3	1.52 H	53	42.20	-3.50
3	2744.76	43.5 PK	74.0	-30.5	1.61 H	192	43.50	0.00
4	2744.76	36.1 AV	54.0	-17.9	1.61 H	192	36.10	0.00

ANTENNA POLARITY & TEST DISTANCE: VERTICAL AT 3 M								
NO.	FREQ. (MHz)	EMISSION LEVEL (dBuV/m)	LIMIT (dBuV/m)	MARGIN (dB)	ANTENNA HEIGHT (m)	TABLE ANGLE (Degree)	RAW VALUE (dBuV)	CORRECTION FACTOR (dB/m)
1	1829.84	43.8 PK	74.0	-30.2	1.00 V	258	47.30	-3.50
2	1829.84	38.8 AV	54.0	-15.2	1.00 V	258	42.30	-3.50
3	2744.76	45.1 PK	74.0	-28.9	1.00 V	136	45.10	0.00
4	2744.76	39.4 AV	54.0	-14.6	1.00 V	136	39.40	0.00

**REMARKS:**

1. Emission Level(dBuV/m) = Raw Value(dBuV) + Correction Factor(dB/m)
2. Correction Factor(dB/m) = Antenna Factor(dB/m) + Cable Factor(dB)  
– Pre-Amplifier Factor (dB)
3. The other emission levels were very low against the limit.
4. Margin value = Emission Level – Limit value

EUT TEST CONDITION		MEASUREMENT DETAIL	
CHANNEL	Channel 50	FREQUENCY RANGE	1 ~ 25GHz
INPUT POWER	120Vac, 60 Hz	DETECTOR FUNCTION	Peak (PK) Average (AV)
ENVIRONMENTAL CONDITIONS	18deg. C, 72%RH	TESTED BY	Nick Hsu

ANTENNA POLARITY & TEST DISTANCE: HORIZONTAL AT 3 M								
NO.	FREQ. (MHz)	EMISSION LEVEL (dBuV/m)	LIMIT (dBuV/m)	MARGIN (dB)	ANTENNA HEIGHT (m)	TABLE ANGLE (Degree)	RAW VALUE (dBuV)	CORRECTION FACTOR (dB/m)
1	1854.92	43.6 PK	74.0	-30.4	1.01 H	59	47.00	-3.40
2	1854.92	40.0 AV	54.0	-14.0	1.01 H	59	43.40	-3.40
3	2782.38	41.9 PK	74.0	-32.1	1.00 H	126	41.70	0.20
4	2782.38	32.6 AV	54.0	-21.4	1.00 H	126	32.40	0.20
ANTENNA POLARITY & TEST DISTANCE: VERTICAL AT 3 M								
NO.	FREQ. (MHz)	EMISSION LEVEL (dBuV/m)	LIMIT (dBuV/m)	MARGIN (dB)	ANTENNA HEIGHT (m)	TABLE ANGLE (Degree)	RAW VALUE (dBuV)	CORRECTION FACTOR (dB/m)
1	1854.92	43.0 PK	74.0	-31.0	1.69 V	259	46.40	-3.40
2	1854.92	38.6 AV	54.0	-15.4	1.69 V	259	42.00	-3.40
3	2782.38	45.4 PK	74.0	-28.6	1.00 V	255	45.20	0.20
4	2782.38	39.7 AV	54.0	-14.3	1.00 V	255	39.50	0.20

**REMARKS:**

1. Emission Level(dBuV/m) = Raw Value(dBuV) + Correction Factor(dB/m)
2. Correction Factor(dB/m) = Antenna Factor(dB/m) + Cable Factor(dB)  
– Pre-Amplifier Factor (dB)
3. The other emission levels were very low against the limit.
4. Margin value = Emission Level – Limit value

**BELOW 1GHz WORST-CASE DATA**

EUT TEST CONDITION		MEASUREMENT DETAIL	
CHANNEL	Channel 1	FREQUENCY RANGE	Below 1000MHz
INPUT POWER	120Vac, 60Hz	DETECTOR FUNCTION	Quasi-Peak
ENVIRONMENTAL CONDITIONS	18deg. C, 72%RH	TESTED BY	Nick Hsu

ANTENNA POLARITY & TEST DISTANCE: HORIZONTAL AT 3 M								
NO.	FREQ. (MHz)	EMISSION LEVEL (dBuV/m)	LIMIT (dBuV/m)	MARGIN (dB)	ANTENNA HEIGHT (m)	TABLE ANGLE (Degree)	RAW VALUE (dBuV)	CORRECTION FACTOR (dB/m)
1	53.23	30.2 QP	40.0	-9.8	1.01 H	9	44.70	-14.50
2	146.56	31.9 QP	43.5	-11.6	1.50 H	148	46.00	-14.10
3	496.53	30.9 QP	46.0	-15.1	1.01 H	17	39.50	-8.60
4	654.02	32.5 QP	46.0	-13.5	1.50 H	15	37.70	-5.20
5	877.61	42.5 QP	46.0	-3.5	1.01 H	65	43.70	-1.20
6	968.99	36.5 QP	54.0	-17.5	1.01 H	170	35.80	0.70
ANTENNA POLARITY & TEST DISTANCE: VERTICAL AT 3 M								
NO.	FREQ. (MHz)	EMISSION LEVEL (dBuV/m)	LIMIT (dBuV/m)	MARGIN (dB)	ANTENNA HEIGHT (m)	TABLE ANGLE (Degree)	RAW VALUE (dBuV)	CORRECTION FACTOR (dB/m)
1	61.01	29.9 QP	40.0	-10.1	1.00 V	215	45.00	-15.10
2	131.00	32.4 QP	43.5	-11.1	1.00 V	279	47.70	-15.30
3	496.53	30.8 QP	46.0	-15.2	1.00 V	296	39.40	-8.60
4	589.86	31.3 QP	46.0	-14.7	1.50 V	204	37.80	-6.50
5	877.61	41.7 QP	46.0	-4.3	1.00 V	223	42.90	-1.20
6	961.21	36.6 QP	54.0	-17.4	1.00 V	192	36.10	0.50

**REMARKS:**

1. Emission Level(dBuV/m) = Raw Value(dBuV) + Correction Factor(dB/m)
2. Correction Factor(dB/m) = Antenna Factor(dB/m) + Cable Factor(dB) – Pre-Amplifier Factor (dB)
3. The other emission levels were very low against the limit.
4. Margin value = Emission Level – Limit value

EUT TEST CONDITION		MEASUREMENT DETAIL	
CHANNEL	Channel 25	FREQUENCY RANGE	Below 1000MHz
INPUT POWER	120Vac, 60Hz	DETECTOR FUNCTION	Quasi-Peak
ENVIRONMENTAL CONDITIONS	18deg. C, 72%RH	TESTED BY	Nick Hsu

ANTENNA POLARITY & TEST DISTANCE: HORIZONTAL AT 3 M								
NO.	FREQ. (MHz)	EMISSION LEVEL (dBuV/m)	LIMIT (dBuV/m)	MARGIN (dB)	ANTENNA HEIGHT (m)	TABLE ANGLE (Degree)	RAW VALUE (dBuV)	CORRECTION FACTOR (dB/m)
1	156.28	36.5 QP	43.5	-7.0	2.00 H	57	50.40	-13.90
2	533.47	31.0 QP	46.0	-15.0	1.50 H	50	38.90	-7.90
3	589.86	31.5 QP	46.0	-14.5	1.50 H	109	38.00	-6.50
4	817.34	37.1 QP	46.0	-8.9	1.00 H	340	39.10	-2.00
5	883.44	39.3 QP	46.0	-6.7	1.50 H	327	40.40	-1.10
6	972.88	42.6 QP	54.0	-11.4	2.00 H	151	41.80	0.80
ANTENNA POLARITY & TEST DISTANCE: VERTICAL AT 3 M								
NO.	FREQ. (MHz)	EMISSION LEVEL (dBuV/m)	LIMIT (dBuV/m)	MARGIN (dB)	ANTENNA HEIGHT (m)	TABLE ANGLE (Degree)	RAW VALUE (dBuV)	CORRECTION FACTOR (dB/m)
1	61.01	30.6 QP	40.0	-9.4	1.51 V	16	45.70	-15.10
2	146.56	31.4 QP	43.5	-12.1	1.01 V	4	45.50	-14.10
3	667.63	32.2 QP	46.0	-13.8	1.51 V	16	37.20	-5.00
4	817.34	33.8 QP	46.0	-12.2	1.01 V	173	35.80	-2.00
5	885.39	38.0 QP	46.0	-8.0	1.01 V	277	39.00	-1.00
6	965.10	39.5 QP	54.0	-14.5	1.01 V	199	38.80	0.70

**REMARKS:**

1. Emission Level(dBuV/m) = Raw Value(dBuV) + Correction Factor(dB/m)
2. Correction Factor(dB/m) = Antenna Factor(dB/m) + Cable Factor(dB)  
– Pre-Amplifier Factor (dB)
3. The other emission levels were very low against the limit.
4. Margin value = Emission Level – Limit value

EUT TEST CONDITION		MEASUREMENT DETAIL	
CHANNEL	Channel 50	FREQUENCY RANGE	Below 1000MHz
INPUT POWER	120Vac, 60Hz	DETECTOR FUNCTION	Quasi-Peak
ENVIRONMENTAL CONDITIONS	18deg. C, 72%RH	TESTED BY	Nick Hsu

ANTENNA POLARITY & TEST DISTANCE: HORIZONTAL AT 3 M								
NO.	FREQ. (MHz)	EMISSION LEVEL (dBuV/m)	LIMIT (dBuV/m)	MARGIN (dB)	ANTENNA HEIGHT (m)	TABLE ANGLE (Degree)	RAW VALUE (dBuV)	CORRECTION FACTOR (dB/m)
1	156.28	36.6 QP	43.5	-6.9	2.00 H	58	50.50	-13.90
2	607.35	28.1 QP	46.0	-17.9	1.50 H	66	34.00	-5.90
3	869.83	39.5 QP	46.0	-6.5	1.50 H	334	40.70	-1.20
4	895.11	41.6 QP	46.0	-4.4	1.50 H	308	42.30	-0.70
5	968.99	41.4 QP	54.0	-12.6	2.00 H	158	40.70	0.70
6	984.55	44.9 QP	54.0	-9.1	2.00 H	152	44.10	0.80
ANTENNA POLARITY & TEST DISTANCE: VERTICAL AT 3 M								
NO.	FREQ. (MHz)	EMISSION LEVEL (dBuV/m)	LIMIT (dBuV/m)	MARGIN (dB)	ANTENNA HEIGHT (m)	TABLE ANGLE (Degree)	RAW VALUE (dBuV)	CORRECTION FACTOR (dB/m)
1	61.01	30.6 QP	40.0	-9.4	1.49 V	349	45.70	-15.10
2	131.00	32.5 QP	43.5	-11.0	1.00 V	265	47.80	-15.30
3	589.86	31.8 QP	46.0	-14.2	1.49 V	205	38.30	-6.50
4	829.00	34.2 QP	46.0	-11.8	1.00 V	282	36.10	-1.90
5	897.05	41.8 QP	46.0	-4.2	1.00 V	50	42.40	-0.60
6	976.77	41.8 QP	54.0	-12.2	1.00 V	178	41.00	0.80

**REMARKS:**

1. Emission Level(dBuV/m) = Raw Value(dBuV) + Correction Factor(dB/m)
2. Correction Factor(dB/m) = Antenna Factor(dB/m) + Cable Factor(dB)  
– Pre-Amplifier Factor (dB)
3. The other emission levels were very low against the limit.
4. Margin value = Emission Level – Limit value



## 4.2 CONDUCTED EMISSION MEASUREMENT

### 4.2.1 LIMITS OF CONDUCTED EMISSION MEASUREMENT

FREQUENCY OF EMISSION (MHz)	CONDUCTED LIMIT (dB $\mu$ V)	
	Quasi-peak	Average
0.15 ~ 0.5	66 to 56	56 to 46
0.5 ~ 5	56	46
5 ~ 30	60	50

- NOTE:**
1. The lower limit shall apply at the transition frequencies.
  2. The limit decreases in line with the logarithm of the frequency in the range of 0.15 to 0.50MHz.
  3. All emanations from a class A/B digital device or system, including any network of conductors and apparatus connected thereto, shall not exceed the level of field strengths specified above.

### 4.2.2 TEST INSTRUMENTS

DESCRIPTION & MANUFACTURER	MODEL NO.	SERIAL NO.	DATE OF CALIBRATION	DUE DATE OF CALIBRATION
Test Receiver ROHDE & SCHWARZ	ESCS30	100288	Apr. 24, 2014	Apr. 23, 2015
RF signal cable Woken	5D-FB	Cable-HYCO2-01	Dec. 26, 2014	Dec. 25, 2015
LISN ROHDE & SCHWARZ (EUT)	ESH2-Z5	100100	Dec. 30, 2014	Dec. 29, 2015
LISN ROHDE & SCHWARZ (Peripheral)	ESH3-Z5	100312	Jul. 10, 2014	Jul. 09, 2015
Software ADT	BV ADT_Cond_ V7.3.7.3	NA	NA	NA

- NOTE:**
1. The calibration interval of the above test instruments is 12 months and the calibrations are traceable to NML/ROC and NIST/USA.
  2. The test was performed in HwaYa Shielded Room 2.
  3. The VCCI Site Registration No. is C-2047.

#### 4.2.3 TEST PROCEDURES

- The EUT was placed 0.4 meters from the conducting wall of the shielded room with EUT being connected to the power mains through a line impedance stabilization network (LISN). Other support units were connected to the power mains through another LISN. The two LISNs provide 50 ohm/ 50uH of coupling impedance for the measuring instrument.
- Both lines of the power mains connected to the EUT were checked for maximum conducted interference.
- The frequency range from 150kHz to 30MHz was searched. Emission levels under (Limit - 20dB) was not recorded.

**NOTE:** All modes of operation were investigated and the worst-case emissions are reported.

#### 4.2.4 DEVIATION FROM TEST STANDARD

No deviation.

#### 4.2.5 TEST SETUP

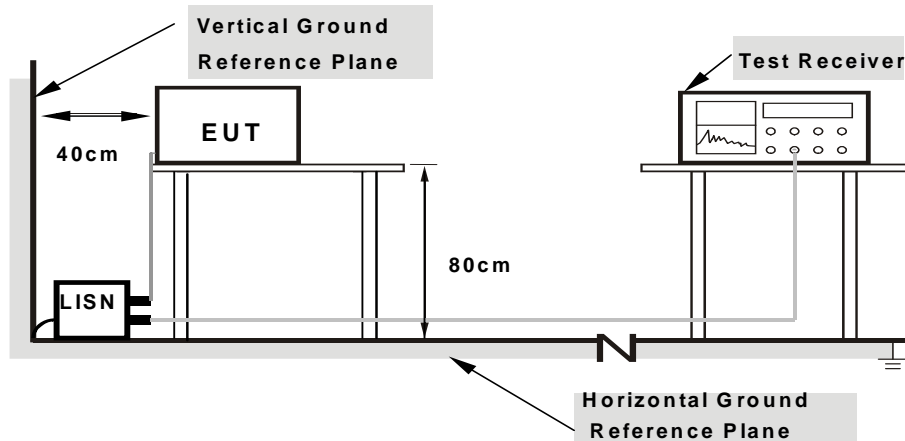

- Note:**
- Support units were connected to second LISN.
  - Both of LISNs (AMN) are 80 cm from EUT and at least 80 cm from other units and other metal planes

For the actual test configuration, please refer to the attached file (Test Setup Photo).

#### 4.2.6 EUT OPERATING CONDITIONS

Same as 4.1.6.

## 4.2.7 TEST RESULTS

### CONDUCTED WORST-CASE DATA :

PHASE	Line 1	6dB BANDWIDTH	9kHz
CHANNEL	1		

No	Freq. [MHz]	Corr. Factor (dB)	Reading Value		Emission Level		Limit		Margin	
			[dB (uV)]		[dB (uV)]		[dB (uV)]		(dB)	
			Q.P.	AV.	Q.P.	AV.	Q.P.	AV.	Q.P.	AV.
1	0.15000	0.19	40.16	26.50	40.35	26.69	66.00	56.00	-25.65	-29.31
2	0.25547	0.20	33.36	19.86	33.56	20.06	61.58	51.58	-28.02	-31.52
3	0.50938	0.22	29.67	15.41	29.89	15.63	56.00	46.00	-26.11	-30.37
4	4.67188	0.44	37.04	29.58	37.48	30.02	56.00	46.00	-18.52	-15.98
5	7.26953	0.47	35.45	28.49	35.92	28.96	60.00	50.00	-24.08	-21.04
6	15.70703	0.60	40.66	33.22	41.26	33.82	60.00	50.00	-18.74	-16.18

### REMARKS:

1. Q.P. and AV. are abbreviations of quasi-peak and average individually.
2. The emission levels of other frequencies were very low against the limit.
3. Margin value = Emission level - Limit value
4. Correction factor = Insertion loss + Cable loss
5. Emission Level = Correction Factor + Reading Value

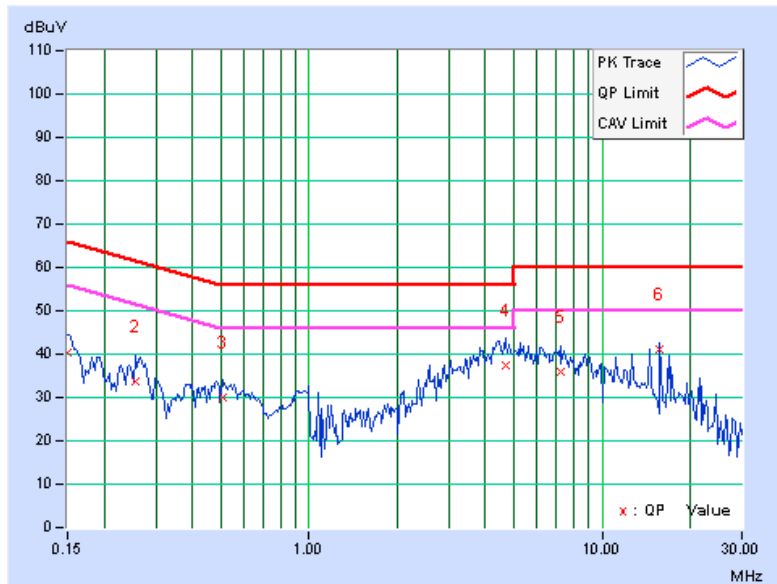

PHASE	Line 2	6dB BANDWIDTH	9kHz
CHANNEL	1		

No	Freq. [MHz]	Corr. Factor (dB)	Reading Value		Emission Level		Limit		Margin	
			[dB (uV)]		[dB (uV)]		[dB (uV)]		(dB)	
			Q.P.	AV.	Q.P.	AV.	Q.P.	AV.	Q.P.	AV.
1	0.15391	0.21	40.31	24.77	40.52	24.98	65.79	55.79	-25.27	-30.81
2	0.24766	0.23	37.48	27.38	37.71	27.61	61.84	51.84	-24.13	-24.23
3	0.65391	0.28	29.86	18.51	30.14	18.79	56.00	46.00	-25.86	-27.21
4	1.54297	0.36	27.96	19.89	28.32	20.25	56.00	46.00	-27.68	-25.75
5	3.84375	0.46	34.13	27.69	34.59	28.15	56.00	46.00	-21.41	-17.85
6	13.79297	0.67	38.97	33.12	39.64	33.79	60.00	50.00	-20.36	-16.21

**REMARKS:**

1. Q.P. and AV. are abbreviations of quasi-peak and average individually.
2. The emission levels of other frequencies were very low against the limit.
3. Margin value = Emission level - Limit value
4. Correction factor = Insertion loss + Cable loss
5. Emission Level = Correction Factor + Reading Value

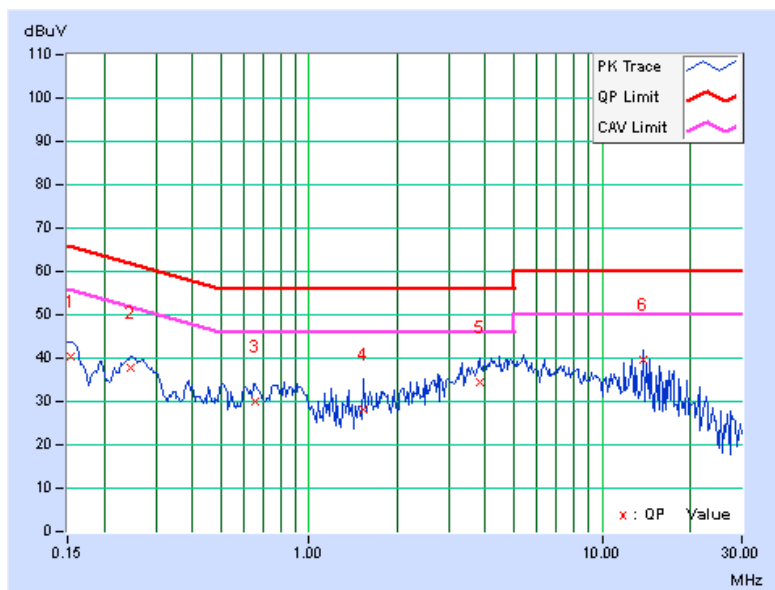

PHASE	Line 1	6dB BANDWIDTH	9kHz
CHANNEL	25		

No	Freq. [MHz]	Corr. Factor (dB)	Reading Value		Emission Level		Limit		Margin	
			[dB (uV)]		[dB (uV)]		[dB (uV)]		(dB)	
			Q.P.	AV.	Q.P.	AV.	Q.P.	AV.	Q.P.	AV.
1	0.15391	0.20	37.62	20.26	37.82	20.46	65.79	55.79	-27.97	-35.33
2	0.24766	0.20	36.20	24.85	36.40	25.05	61.84	51.84	-25.44	-26.79
3	0.52109	0.22	31.56	15.41	31.78	15.63	56.00	46.00	-24.22	-30.37
4	4.29297	0.43	34.97	27.18	35.40	27.61	56.00	46.00	-20.60	-18.39
5	5.92969	0.45	34.39	26.72	34.84	27.17	60.00	50.00	-25.16	-22.83
6	15.70703	0.60	42.59	35.09	43.19	35.69	60.00	50.00	-16.81	-14.31

**REMARKS:**

1. Q.P. and AV. are abbreviations of quasi-peak and average individually.
2. The emission levels of other frequencies were very low against the limit.
3. Margin value = Emission level - Limit value
4. Correction factor = Insertion loss + Cable loss
5. Emission Level = Correction Factor + Reading Value

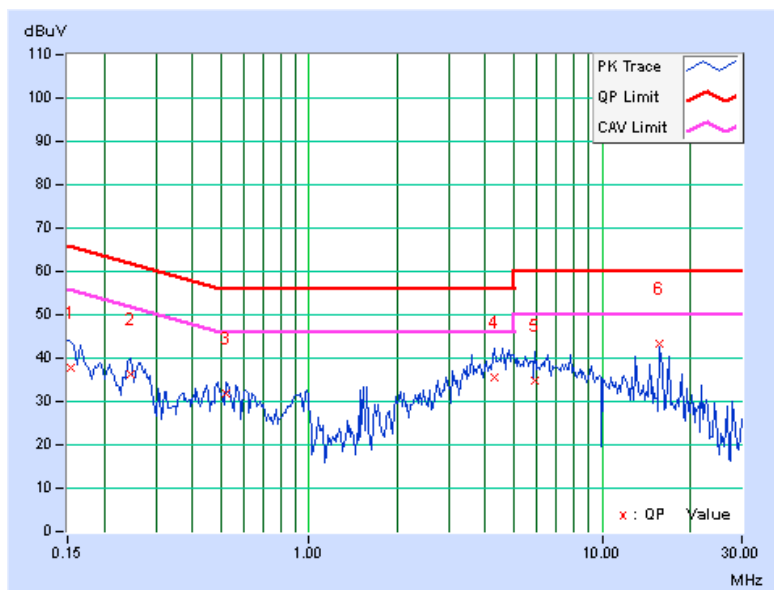

PHASE	Line 2	6dB BANDWIDTH	9kHz
CHANNEL	25		

No	Freq. [MHz]	Corr. Factor (dB)	Reading Value		Emission Level		Limit		Margin	
			[dB (uV)]		[dB (uV)]		[dB (uV)]		(dB)	
			Q.P.	AV.	Q.P.	AV.	Q.P.	AV.	Q.P.	AV.
1	0.15391	0.21	36.51	17.79	36.72	18.00	65.79	55.79	-29.07	-37.79
2	0.20469	0.22	38.31	30.19	38.53	30.41	63.42	53.42	-24.89	-23.01
3	0.25547	0.23	37.12	26.78	37.35	27.01	61.58	51.58	-24.23	-24.57
4	0.66172	0.28	27.30	14.02	27.58	14.30	56.00	46.00	-28.42	-31.70
5	4.40625	0.47	33.14	26.38	33.61	26.85	56.00	46.00	-22.39	-19.15
6	15.70703	0.73	40.14	33.62	40.87	34.35	60.00	50.00	-19.13	-15.65

**REMARKS:**

1. Q.P. and AV. are abbreviations of quasi-peak and average individually.
2. The emission levels of other frequencies were very low against the limit.
3. Margin value = Emission level - Limit value
4. Correction factor = Insertion loss + Cable loss
5. Emission Level = Correction Factor + Reading Value

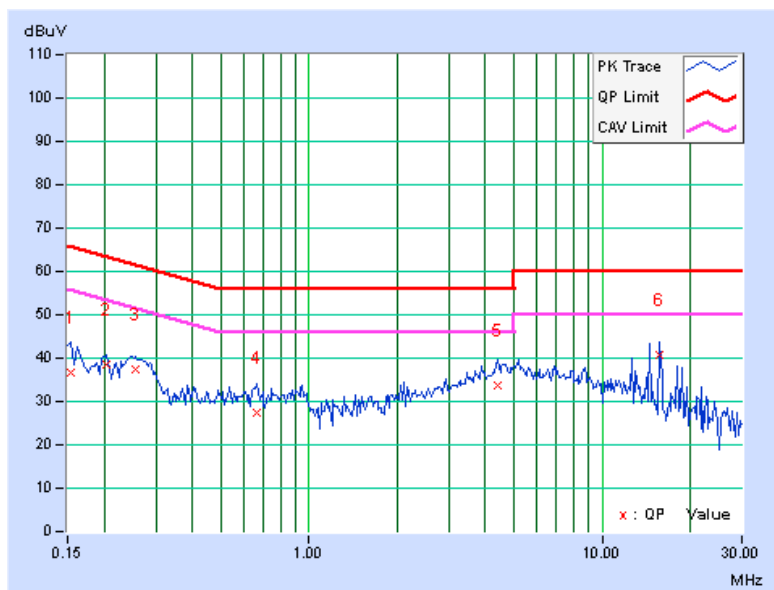

PHASE	Line 1	6dB BANDWIDTH	9kHz
CHANNEL	50		

No	Freq. [MHz]	Corr. Factor (dB)	Reading Value		Emission Level		Limit		Margin	
			[dB (uV)]		[dB (uV)]		[dB (uV)]		(dB)	
			Q.P.	AV.	Q.P.	AV.	Q.P.	AV.	Q.P.	AV.
1	0.16172	0.20	38.86	26.49	39.06	26.69	65.38	55.38	-26.32	-28.69
2	0.26719	0.20	36.31	23.89	36.51	24.09	61.20	51.20	-24.69	-27.11
3	0.51328	0.22	29.14	14.77	29.36	14.99	56.00	46.00	-26.64	-31.01
4	4.73438	0.44	36.80	29.40	37.24	29.84	56.00	46.00	-18.76	-16.16
5	13.40625	0.56	41.42	34.32	41.98	34.88	60.00	50.00	-18.02	-15.12
6	16.47266	0.62	39.05	32.23	39.67	32.85	60.00	50.00	-20.33	-17.15

**REMARKS:**

1. Q.P. and AV. are abbreviations of quasi-peak and average individually.
2. The emission levels of other frequencies were very low against the limit.
3. Margin value = Emission level - Limit value
4. Correction factor = Insertion loss + Cable loss
5. Emission Level = Correction Factor + Reading Value

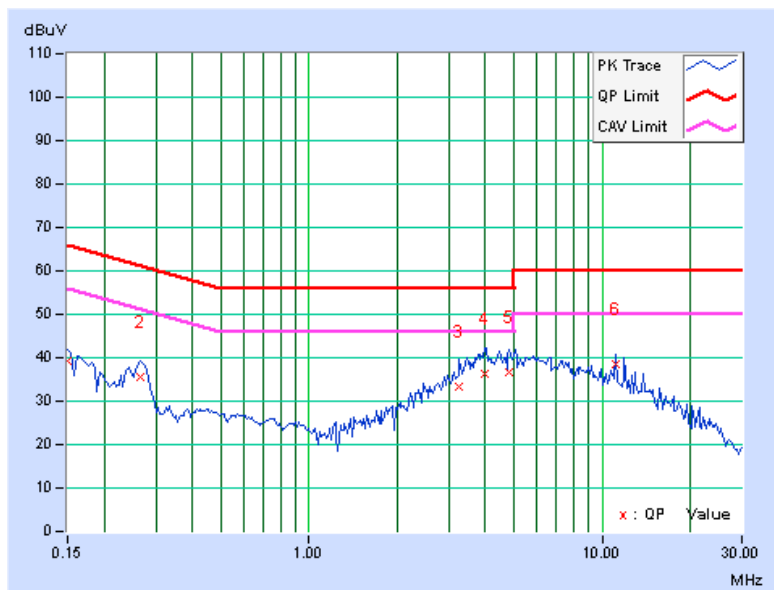

PHASE	Line 2	6dB BANDWIDTH	9kHz
CHANNEL	50		

No	Freq. [MHz]	Corr. Factor (dB)	Reading Value		Emission Level		Limit		Margin	
			[dB (uV)]		[dB (uV)]		[dB (uV)]		(dB)	
			Q.P.	AV.	Q.P.	AV.	Q.P.	AV.	Q.P.	AV.
1	0.15781	0.21	37.70	23.51	37.91	23.72	65.58	55.58	-27.67	-31.86
2	0.25156	0.23	37.42	29.04	37.65	29.27	61.71	51.71	-24.06	-22.44
3	0.40000	0.25	28.73	18.43	28.98	18.68	57.85	47.85	-28.87	-29.17
4	0.81406	0.29	27.05	17.32	27.34	17.61	56.00	46.00	-28.66	-28.39
5	4.58594	0.47	33.05	26.61	33.52	27.08	56.00	46.00	-22.48	-18.92
6	13.40625	0.66	37.97	30.71	38.63	31.37	60.00	50.00	-21.37	-18.63

**REMARKS:**

1. Q.P. and AV. are abbreviations of quasi-peak and average individually.
2. The emission levels of other frequencies were very low against the limit.
3. Margin value = Emission level - Limit value
4. Correction factor = Insertion loss + Cable loss
5. Emission Level = Correction Factor + Reading Value

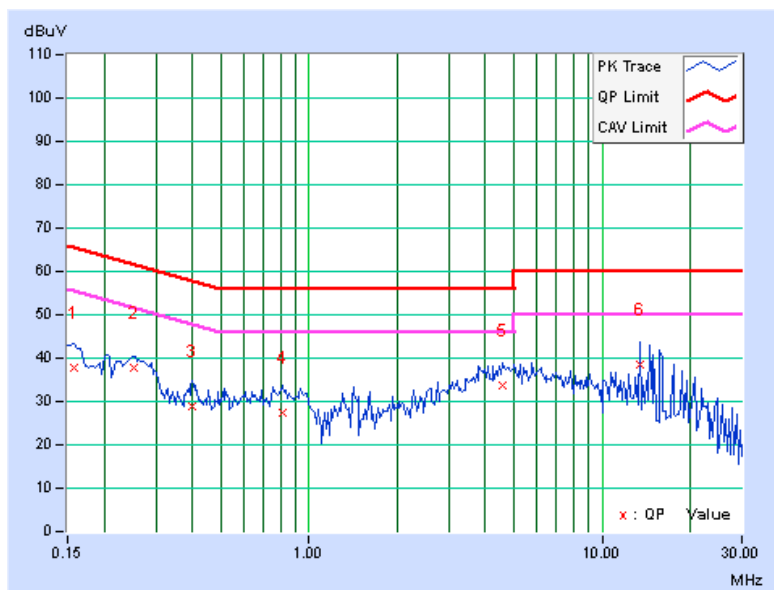



### 4.3 NUMBER OF HOPPING FREQUENCY USED

#### 4.3.1 LIMIT OF HOPPING FREQUENCY USED

At least 50 channels frequencies, and should be equally spaced.

#### 4.3.2 TEST SETUP

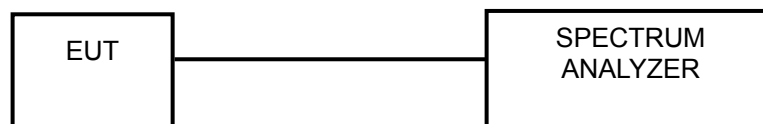

#### 4.3.3 TEST INSTRUMENTS

Refer to section 4.1.2 to get information of above instrument.

#### 4.3.4 TEST PROCEDURES

- a. Check the calibration of the measuring instrument (SA) using either an internal calibrator or a known signal from an external generator.
- b. Turn on the EUT and connect its antenna terminal to measurement via a low loss cable. Then set it to any one measured frequency within its operating range and make sure the instrument is operated in its linear range.
- c. Set the SA on MaxHold Mode, and then keep the EUT in hopping mode. Record all the signals from each channel until each one has been recorded.
- d. Set the SA on View mode and then plot the result on SA screen.
- e. Repeat above procedures until all frequencies measured were complete.

#### 4.3.5 DEVIATION FROM TEST STANDARD

No deviation.

#### 4.3.6 TEST RESULTS

There are 50 hopping frequencies in the hopping mode. Please refer to next page for the test result. On the plots, it shows that the hopping frequencies are equally spaced.



A D T

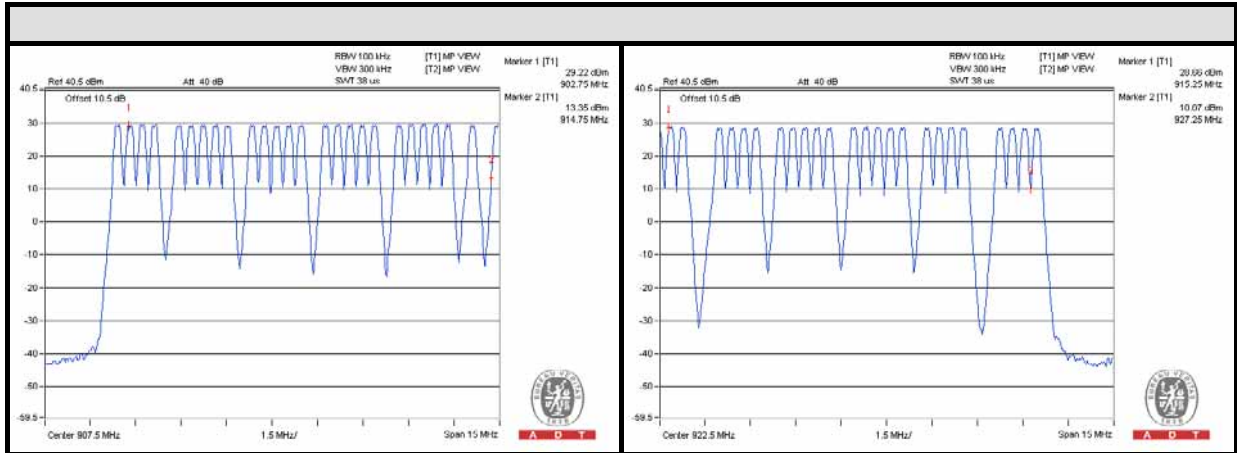

## 4.4 DWELL TIME ON EACH CHANNEL

### 4.4.1 LIMIT OF DWELL TIME USED

The average time of occupancy on any frequency shall not be greater than 0.4 seconds within a 20 second period.

### 4.4.2 TEST SETUP

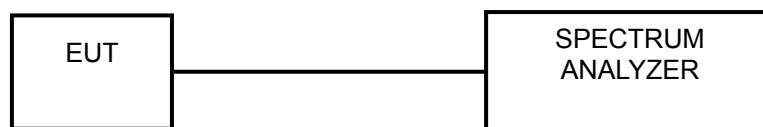

### 4.4.3 TEST INSTRUMENTS

Refer to section 4.1.2 to get information of above instrument.

### 4.4.4 TEST PROCEDURES

- a. Check the calibration of the measuring instrument (SA) using either an internal calibrator or a known signal from an external generator.
- b. Turn on the EUT and connect its antenna terminal to measurement via a low loss cable. Then set it to any one measured frequency within its operating range and make sure the instrument is operated in its linear range.
- c. Adjust the center frequency of SA on any frequency be measured and set SA to zero span mode. And then, set RBW and VBW of spectrum analyzer to proper value.
- d. Measure the time duration of one transmission on the measured frequency. And then plot the result with time difference of this time duration.
- e. Repeat above procedures until all different time-slot modes have been completed.

### 4.4.5 DEVIATION FROM TEST STANDARD

No deviation.

#### 4.4.6 TEST RESULTS

Length of transmission time (ms)	TX Burst of 20s period	Result	Limit
5.8	40	232ms / 20s	400ms / 20s

**NOTE:** Test plots of the transmitting time slot are shown on following.

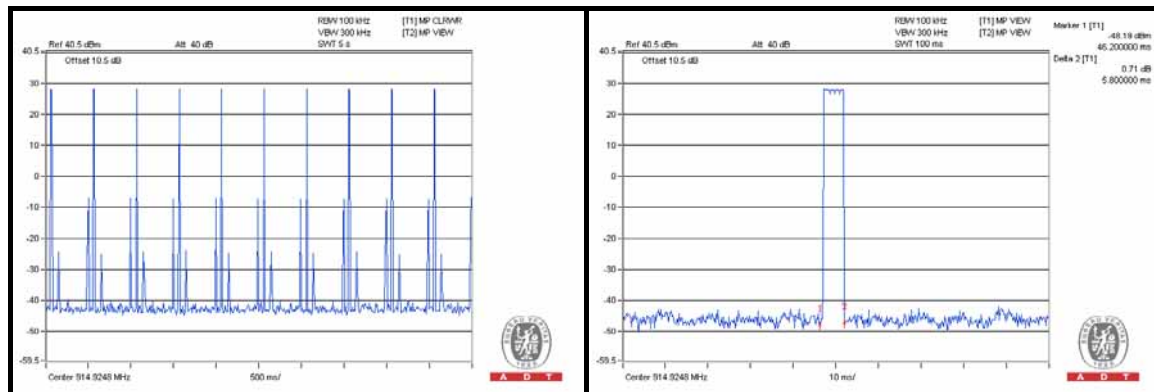

## 4.5 CHANNEL BANDWIDTH

### 4.5.1 LIMITS OF CHANNEL BANDWIDTH

The 20 dB bandwidth of the hopping channel shall be less than 250 kHz.

### 4.5.2 TEST SETUP

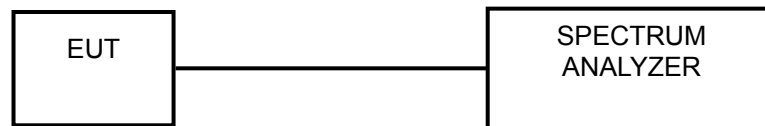

### 4.5.3 TEST INSTRUMENTS

Refer to section 4.1.2 to get information of above instrument.

### 4.5.4 TEST PROCEDURE

- a. Check the calibration of the measuring instrument using either an internal calibrator or a known signal from an external generator.
- b. Turn on the EUT and connect it to measurement instrument. Then set it to any one convenient frequency within its operating range. Set a reference level on the measuring instrument equal to the highest peak value.
- c. Measure the frequency difference of two frequencies that were attenuated 20dB from the reference level. Record the frequency difference as the emission bandwidth.
- d. Repeat above procedures until all frequencies measured were complete.

### 4.5.5 DEVIATION FROM TEST STANDARD

No deviation.

### 4.5.6 EUT OPERATING CONDITION

The software provided by client enabled the EUT to transmit and receive data at lowest, middle and highest channel frequencies individually.

### 4.5.7 TEST RESULTS

CHANNEL	CHANNEL FREQUENCY (MHz)	20dB BANDWIDTH (kHz)	LIMIT (kHz)
1	902.3840	222.89	250
25	914.9248	222.41	250
50	927.4656	222.30	250

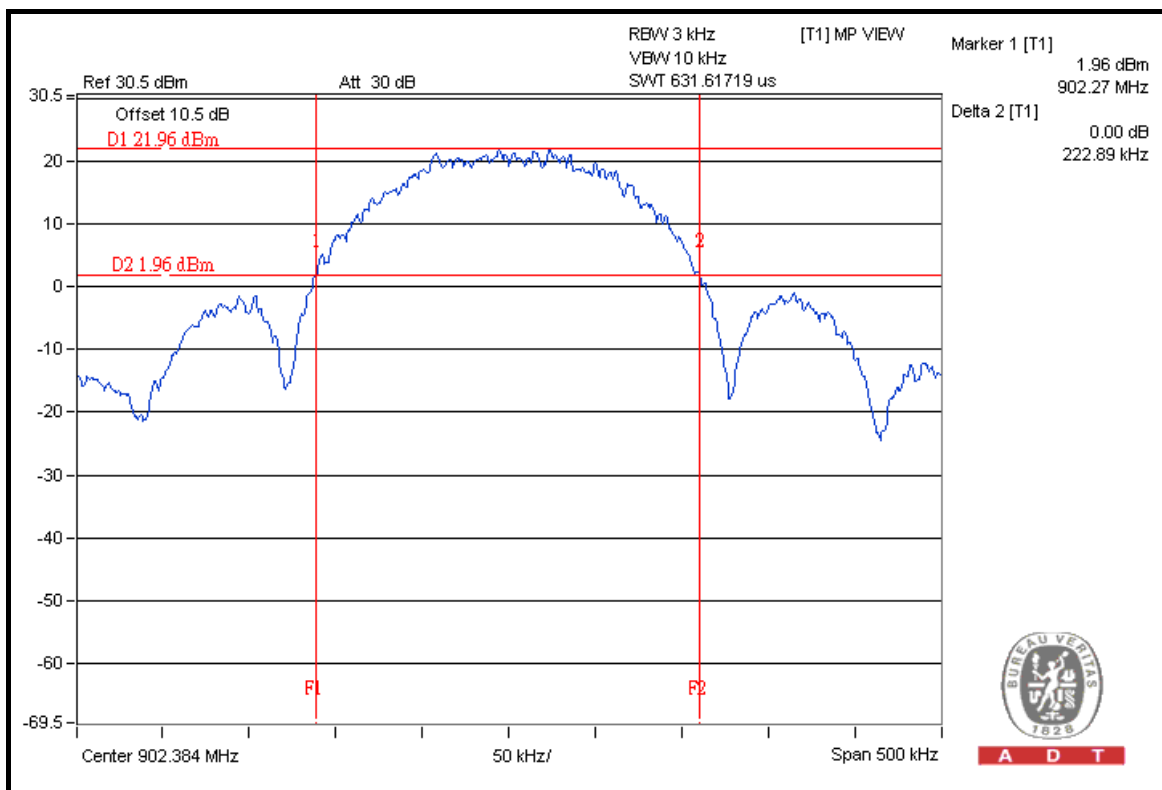

## 4.6 HOPPING CHANNEL SEPARATION

### 4.6.1 LIMIT OF HOPPING CHANNEL SEPARATION

At least 25kHz or 20dB hopping channel bandwidth (whichever is greater).

### 4.6.2 TEST SETUP

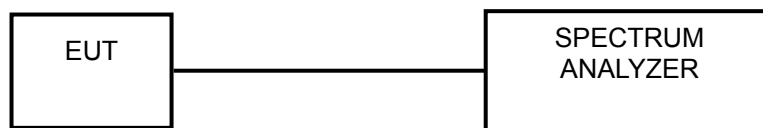

### 4.6.3 TEST INSTRUMENTS

Refer to section 4.1.2 to get information of above instrument.

### 4.6.4 TEST PROCEDURES

1. Check the calibration of the measuring instrument using either an internal calibrator or a known signal from an external generator.
2. Turn on the EUT and connect it to measurement instrument. Then set it to any one convenient frequency within its operating range.
3. By using the MaxHold function record the separation of two adjacent channels.
4. Measure the frequency difference of these two adjacent channels by SA MARK function. And then plot the result on SA screen.
5. Repeat above procedures until all frequencies measured were complete.

### 4.6.5 DEVIATION FROM TEST STANDARD

No deviation.

### 4.6.6 TEST RESULTS

CHANNEL	FREQUENCY (MHz)	ADJACENT CHANNEL SEPARATION (kHz)	MINIMUM LIMIT (kHz)	PASS / FAIL
1	902.3840	407.00	222.89	PASS
25	914.9248	407.00	222.89	PASS
50	927.4656	409.00	222.89	PASS

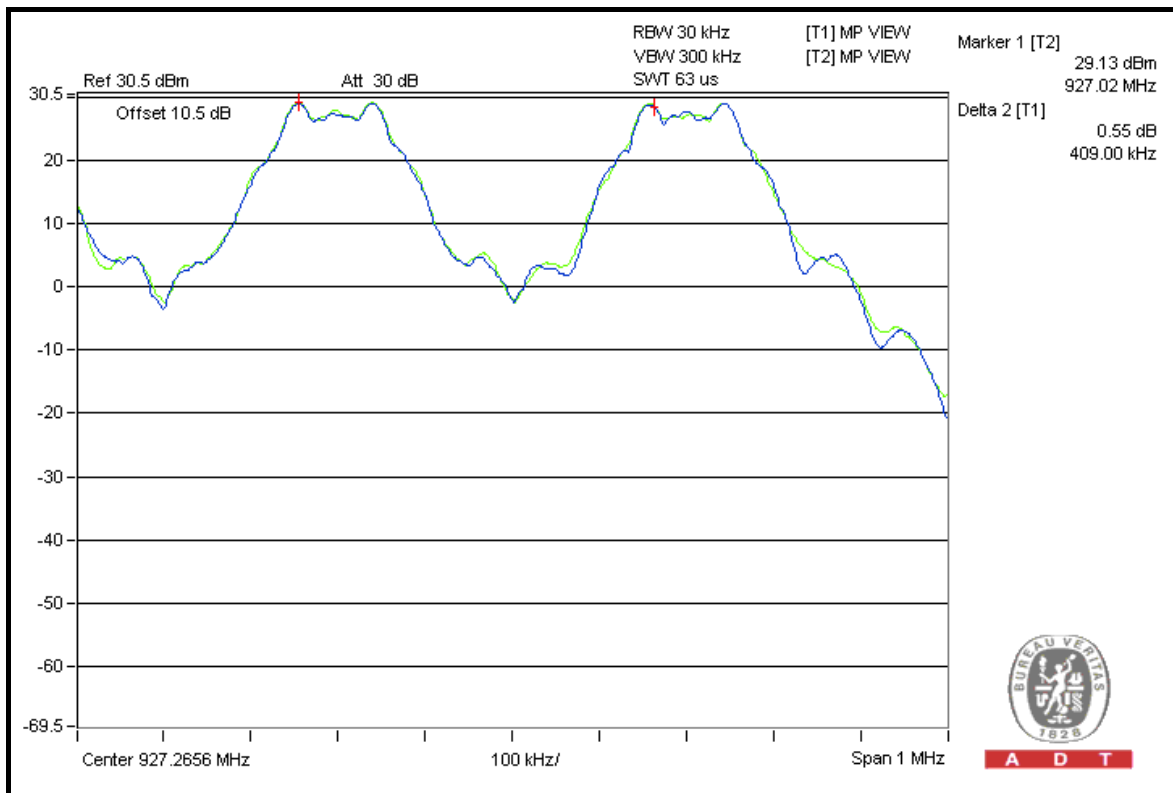



## 4.7 MAXIMUM OUTPUT POWER

### 4.7.1 LIMITS OF MAXIMUM OUTPUT POWER MEASUREMENT

The Maximum Output Power Measurement is 30dBm.

### 4.7.2 TEST SETUP

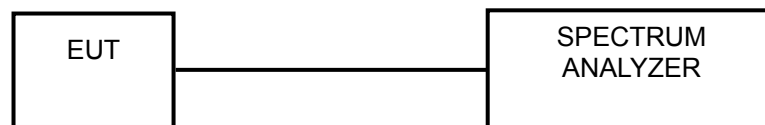

### 4.7.3 TEST INSTRUMENTS

Refer to section 4.1.2 to get information of above instrument.

### 4.7.4 TEST PROCEDURES

- a. Check the calibration of the measuring instrument using either an internal calibrator or a known signal from an external generator.
- b. Turn on the EUT and connect it to measurement instrument. Then set it to any one convenient frequency within its operating range. Set a reference level on the measuring instrument equal to the highest peak value.
- c. The center frequency of the spectrum analyzer is set to the fundamental frequency and using 3MHz RBW and 10 MHz VBW.
- d. Measure the captured power within the band and recording the plot.
- e. Repeat above procedures until all frequencies required were complete.

### 4.7.5 DEVIATION FROM TEST STANDARD

No deviation

### 4.7.6 EUT OPERATING CONDITION

The software provided by client enabled the EUT to transmit and receive data at lowest, middle and highest channel frequencies individually.

### 4.7.7 TEST RESULTS

CHANNEL	CHANNEL FREQUENCY (MHz)	POWER OUTPUT (mW)	POWER OUTPUT (dBm)	POWER LIMIT (dBm)	PASS/FAIL
1	902.3840	<b>859.014</b>	29.34	30	PASS
25	914.9248	831.764	29.20	30	PASS
50	927.4656	794.328	29.00	30	PASS

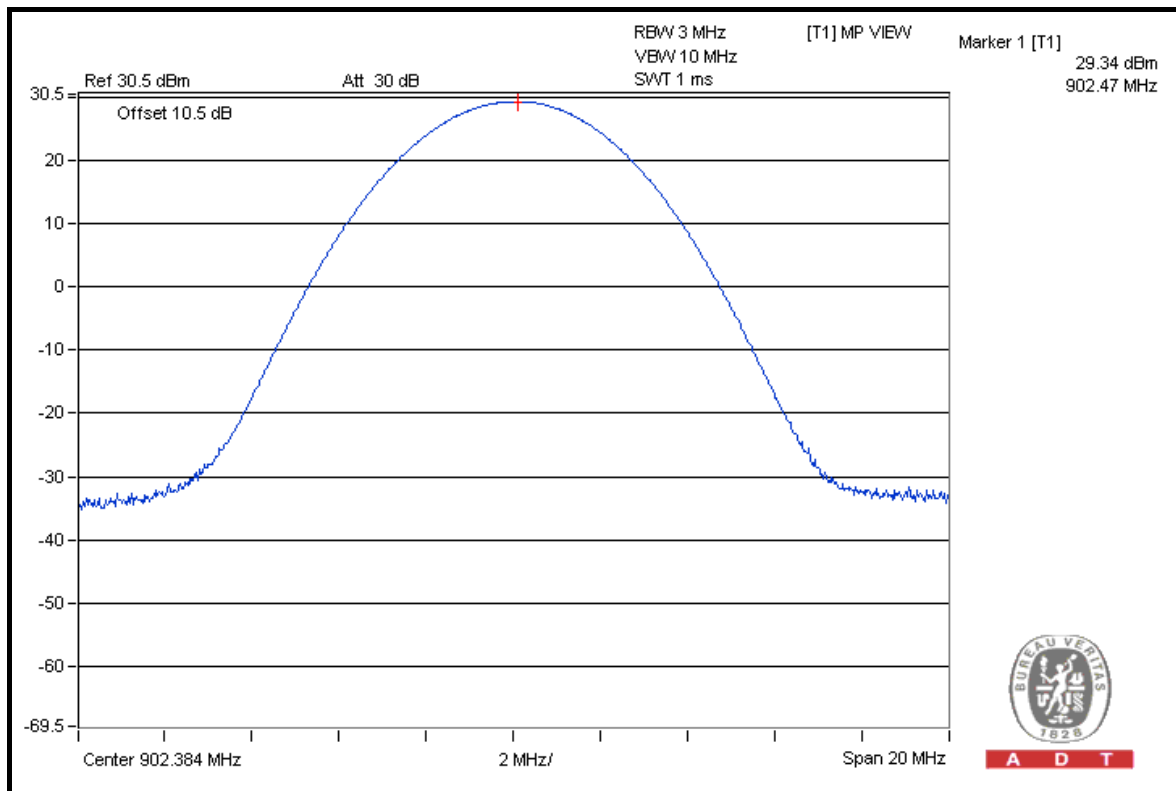

## **4.8 CONDUCTED OUT OF BAND EMISSION MEASUREMENT**

### **4.8.1 LIMITS OF CONDUCTED OUT OF BAND EMISSION MEASUREMENT**

Below  $-20\text{dB}$  of the highest emission level of operating band (in  $100\text{kHz}$  RBW).

### **4.8.2 TEST INSTRUMENTS**

Refer to section 4.1.2 to get information of above instrument.

### **4.8.3 TEST PROCEDURE**

The transmitter output was connected to the spectrum analyzer via a low lose cable. Set both RBW and VBW of spectrum analyzer to  $100 / 300$  kHz with suitable frequency span including  $100$  MHz bandwidth from band edge. The band edges was measured and recorded.

### **4.8.4 DEVIATION FROM TEST STANDARD**

No deviation.

### **4.8.5 EUT OPERATING CONDITION**

The software provided by client enabled the EUT to transmit and receive data at lowest and highest channel frequencies individually.

### **4.8.6 TEST RESULTS**

The spectrum plots are attached on the following images. D1 line indicates the highest level, D2 line indicates the  $20\text{dB}$  offset below D1. It shows compliance with the requirement.



A D T

### Hopping disabled\_Low Channel

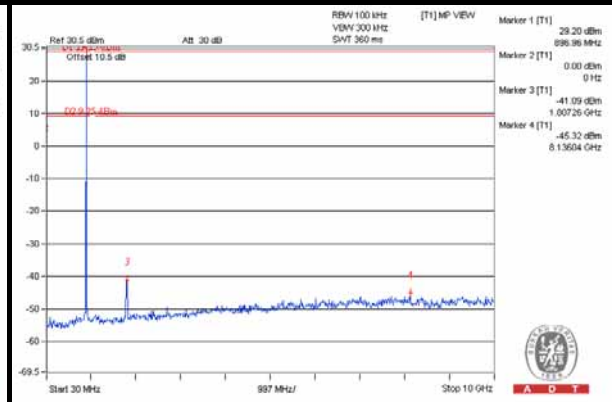
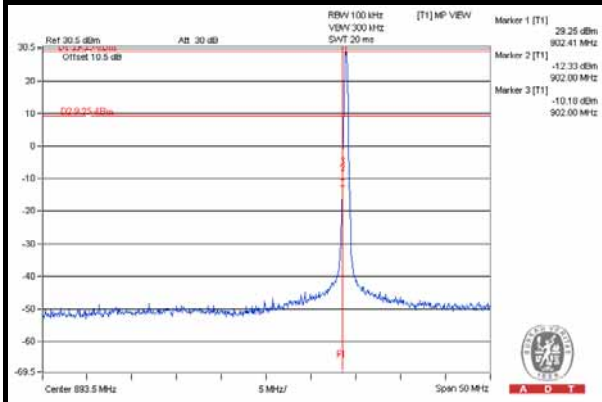

### Hopping disabled\_High Channel

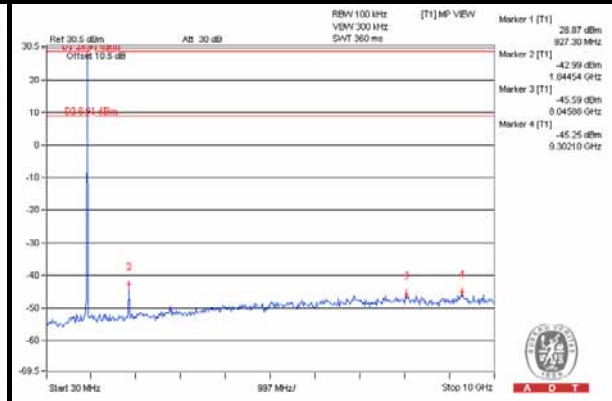
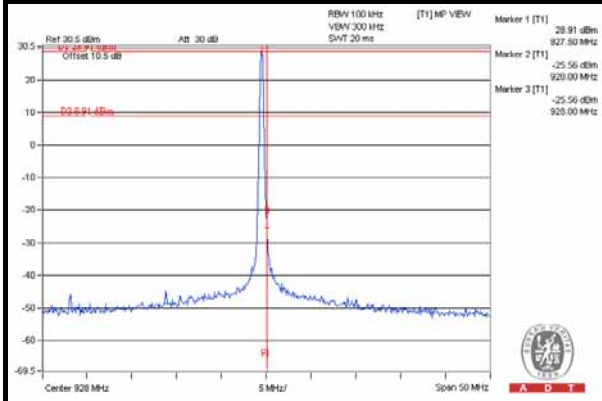

### Hopping enabled

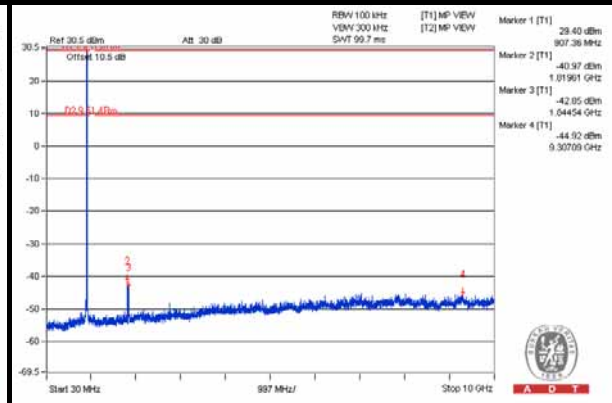
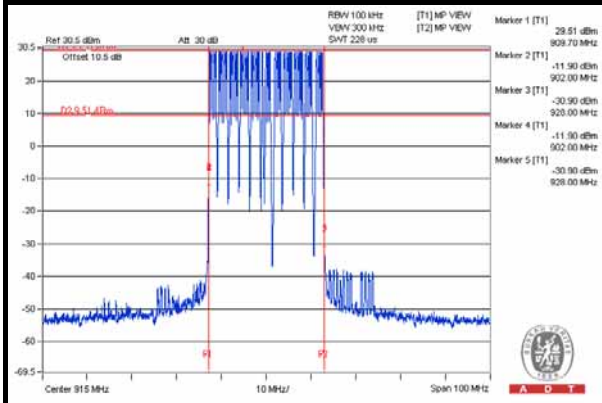



## 5. PHOTOGRAPHS OF THE TEST CONFIGURATION

Please refer to the attached file (Test Setup Photo).



## 6. INFORMATION ON THE TESTING LABORATORIES

We, Bureau Veritas Consumer Products Services (H.K.) Ltd., Taoyuan Branch, were founded in 1988 to provide our best service in EMC, Radio, Telecom and Safety consultation. Our laboratories are accredited and approved according to ISO/IEC 17025.

If you have any comments, please feel free to contact us at the following:

**Linko EMC/RF Lab:**

Tel: 886-2-26052180

Fax: 886-2-26051924

**Hsin Chu EMC/RF/Telecom Lab:**

Tel: 886-3-5935343

Fax: 886-3-5935342

**Hwa Ya EMC/RF/Safety Lab:**

Tel: 886-3-3183232

Fax: 886-3-3270892

**Email:** [service.adt@tw.bureauveritas.com](mailto:service.adt@tw.bureauveritas.com)

**Web Site:** [www.bureauveritas-adt.com](http://www.bureauveritas-adt.com)

The address and road map of all our labs can be found in our web site also.



## **7. APPENDIX A - MODIFICATIONS RECORDERS FOR ENGINEERING CHANGES TO THE EUT BY THE LAB**

No any modifications are made to the EUT by the lab during the test.

**---END---**