

# Antenna Report

FCC ID: A4RGZC4K

4/9/2024

Google LLC

# 1. Test Method

The antenna gains are obtained through measurements in a fully anechoic OTA chamber with a 3D positioner.

Measurements are taken in discrete steps in theta and phi direction. Data is being recorded using a network analyzer (passive) for both theta and phi polarizations at each position resulting in a 3D gain pattern. Step size is <30deg along both axes.

Gain is derived directly through spatial averaging of VNA S21 measurements (passive measurement).

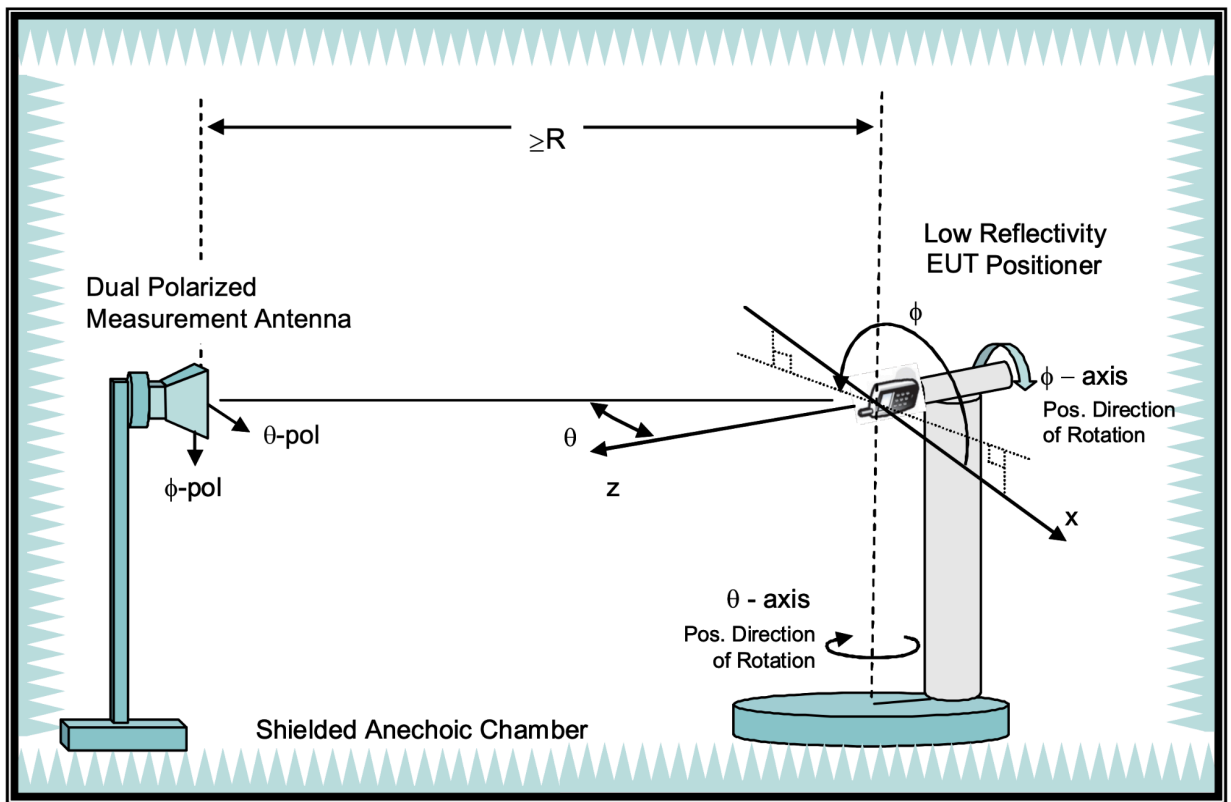

R=4.9m

## 2. Test Equipment and Calibration

The antenna gain measurement equipment and system are all within their calibration periods.

Site Description	Chamber Manufacturer	Type
AMS-8500 Anechoic Chamber	ETS-Lindgren	Fully Anechoic
Site location:	No. 23, Xinghua Rd., Taoyuan Dist., Taoyuan City 330467, Taiwan	

Description	Manufacturer	Model
Network Analyzer	Keysight	E5071C

Equipment calibration status	- Calibration date: May.29, 2023 - Due of next calibration: May.29, 2025
Test dates	- Jan. 26, 2024
Names of test personnel	- Terry Chiang / Jofan Chang

## 3. Site Path Loss

To provide accurate antenna gain values, the chamber is calibrated with the measured path loss. The block diagram below represents the setup of the site path loss. Path loss is provided for both polarities for all WLAN frequency ranges.

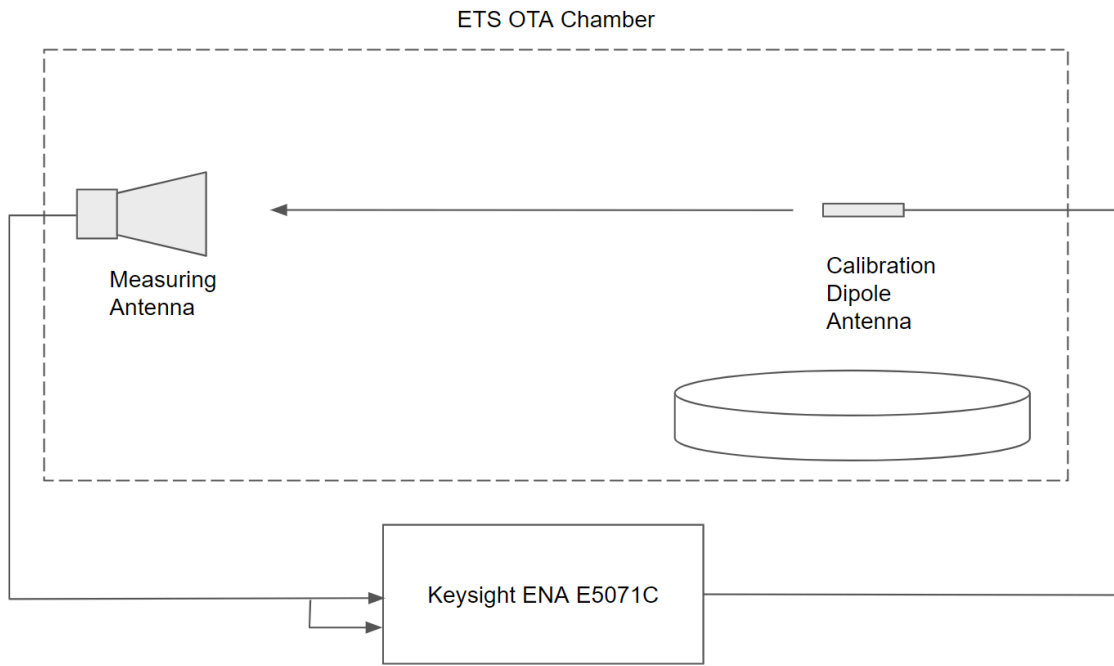

Figure: Chamber Block Diagram of Path Loss

Frequency (MHz)	H-Pol Path Loss	V-Pol Path Loss
2402	-75.3	-74.8
2412	-75.6	-75.1
2437	-76.2	-75.9
2462	-76.6	-76.3
2480	-76.9	-76.5
5180	-83.3	-82.6
5280	-83.9	-83.2
5500	-84.1	-83.5
5820	-84.3	-83.9
5887	-85.0	-84.9
6175	-89.4	-90.4
6475	-91.3	-89.1
6700	-87.4	-85.9
7000	-85.9	-84.8

#### 4. Test Setup

See separate appendix document for pictures of the test setup in this filing.

#### 5. Antenna Type

See description of antenna type below.

Antenna Name	Antenna Type
Ant3	IFA
Ant4	ILA

## 6. WLAN/BT Antennas

Ant	Band	Frequency Band	Peak Gain(dBi)
<b>Ant4</b>	2.4 GHz WiFi/BT/Thread	2400 - 2483.5 MHz	-0.5
	UNII-1	5180 MHz	-3.4
	UNII-2A	5280 MHz	-4.0
	UNII-2C	5500 MHz	-3.9
	UNII-3	5820 MHz	-4.1
	UNII-4	5887 MHz	-3.2
	UNII-5	6175 MHz	-2.1
	UNII-6	6475 MHz	-7.3
	UNII-7	6700 MHz	-4.7
	UNII-8	7000 MHz	-4.5
<b>Ant3</b>	2.4 GHz WiFi/BT/Thread	2400 - 2483.5 MHz	-3.3
	UNII-1	5180 MHz	-1.4
	UNII-2A	5280 MHz	-2.4
	UNII-2C	5500 MHz	-3.9
	UNII-3	5820 MHz	-1.6
	UNII-4	5887 MHz	-1.9
	UNII-5	6175 MHz	-5.4
	UNII-6	6475 MHz	-4.3
	UNII-7	6700 MHz	-3.2
	UNII-8	7000 MHz	-2.8

# 7. Radiation Plots

## Ant4:

Ant4 Freq. 2.4 GHz:

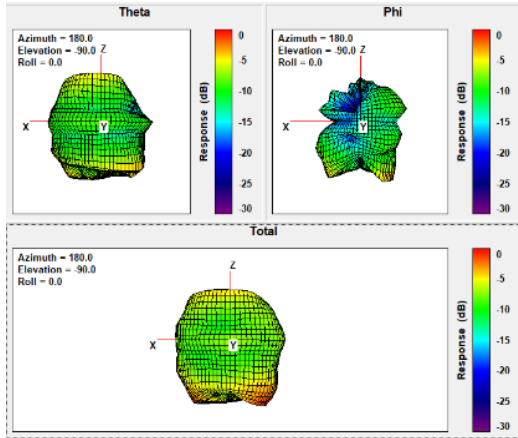

Ant4 Freq. 5500 MHz:

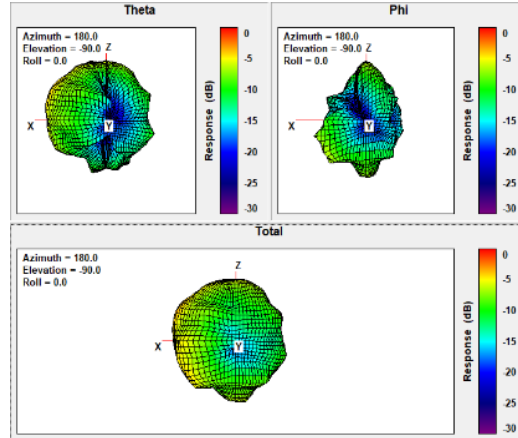

Ant4 Freq. 5180 MHz:

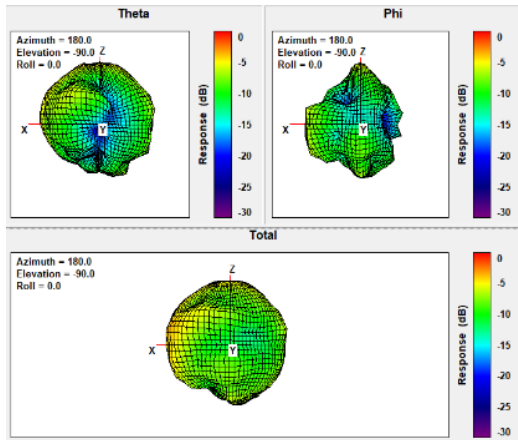

Ant4 Freq. 5820 MHz:

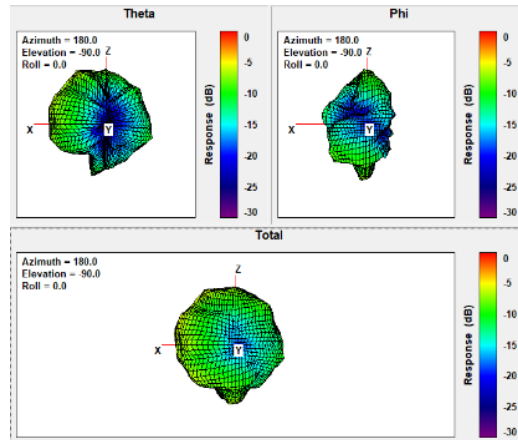

Ant4 Freq. 5280 MHz:

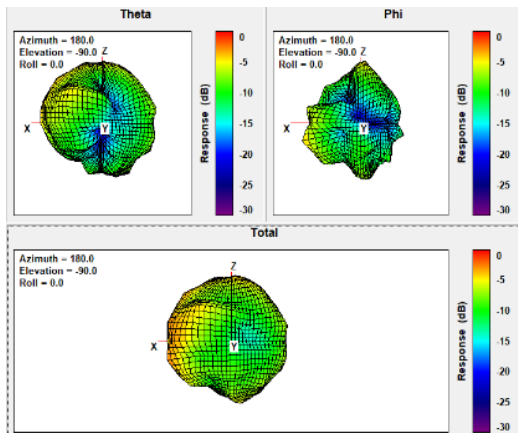

Ant4 Freq. 5887 MHz:

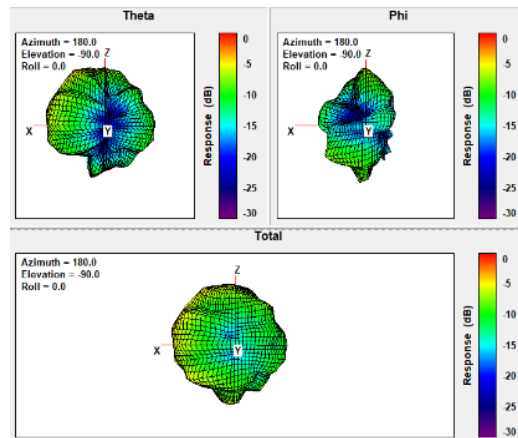

Ant4 Freq. 6175 MHz:

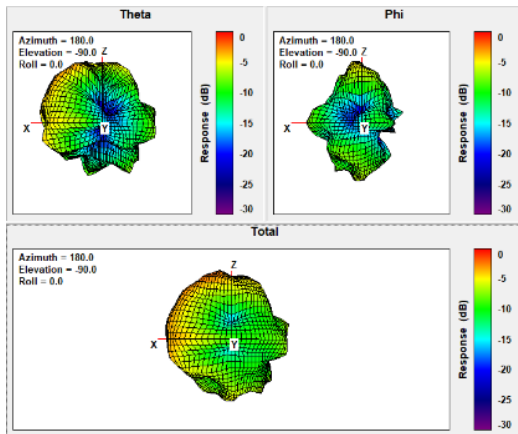

Ant4 Freq. 6700 MHz:

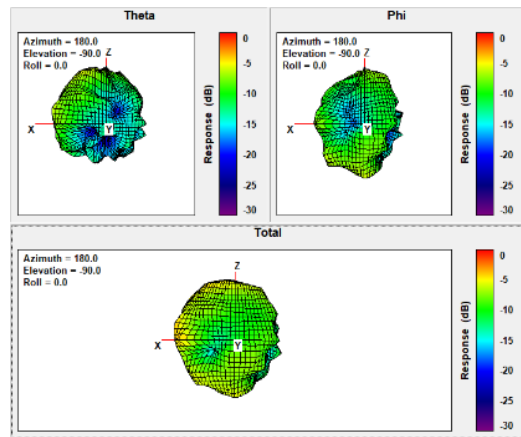

Ant4 Freq. 6475 MHz:

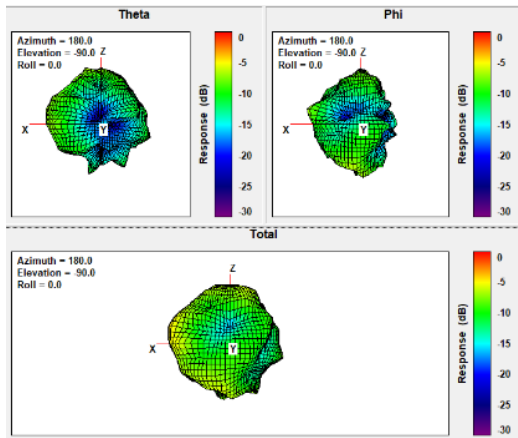

Ant4 Freq. 7000 MHz:

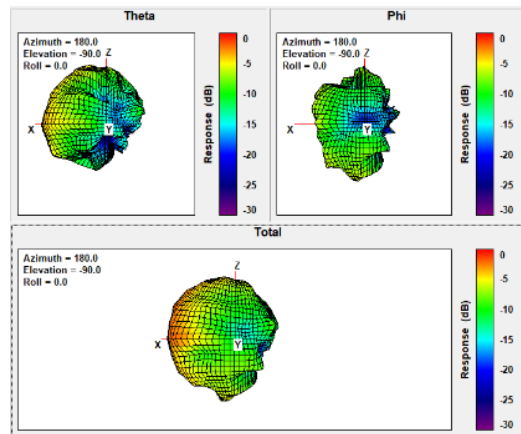



### Ant3:

Ant3 Freq. 2.4 GHz:

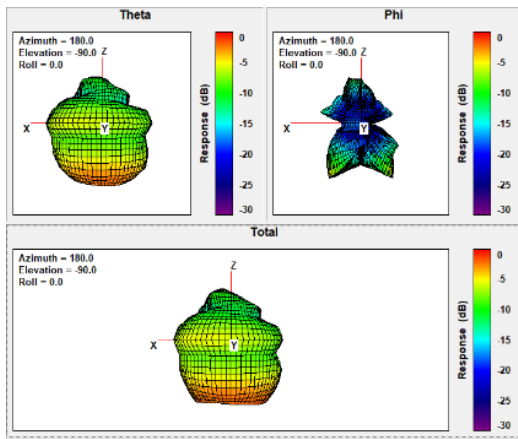

Ant3 Freq. 5500 MHz:

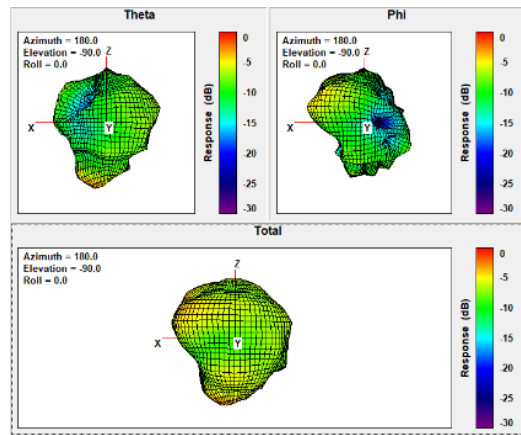

Ant3 Freq. 5180 MHz:

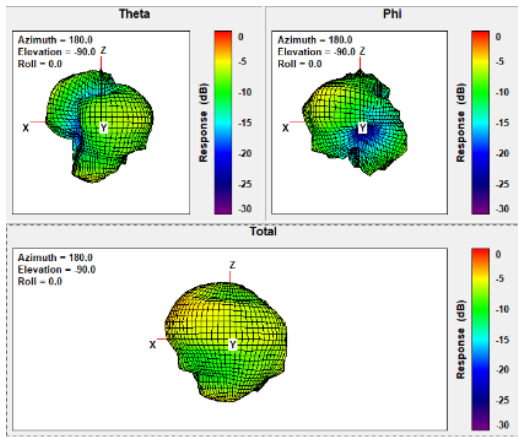

Ant3 Freq. 5820 MHz:

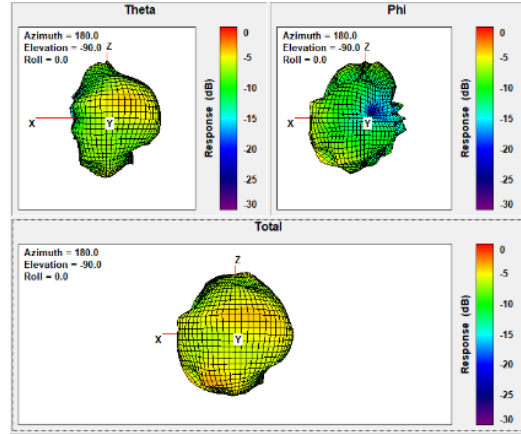

Ant3 Freq. 5280 MHz:

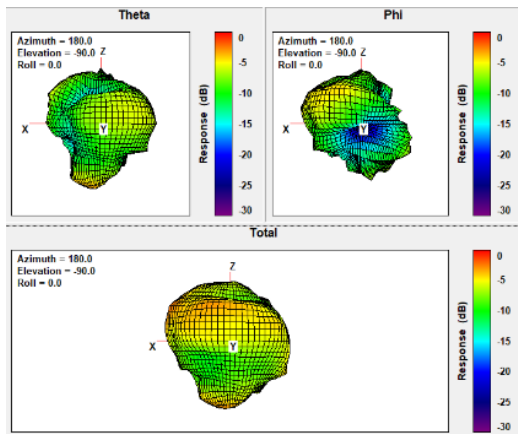

Ant3 Freq. 5887 MHz:

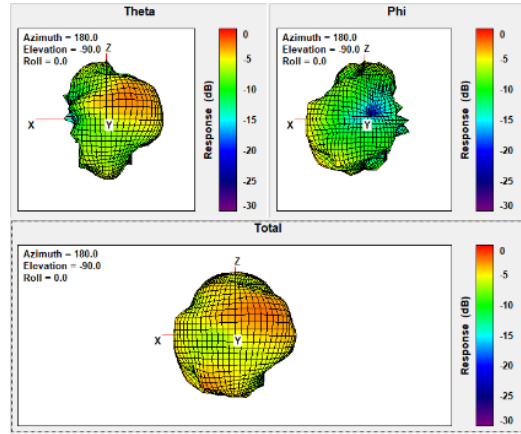

Ant3 Freq. 6175 MHz:

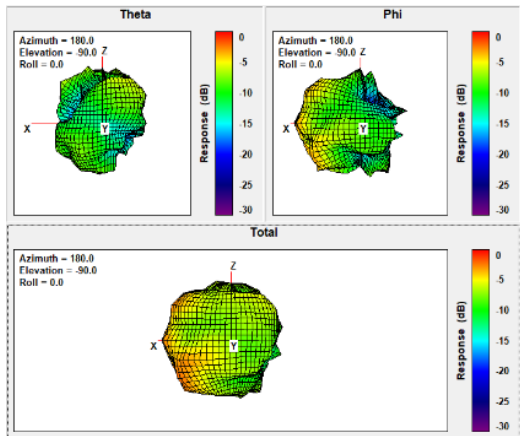

Ant3 Freq. 7000 MHz:

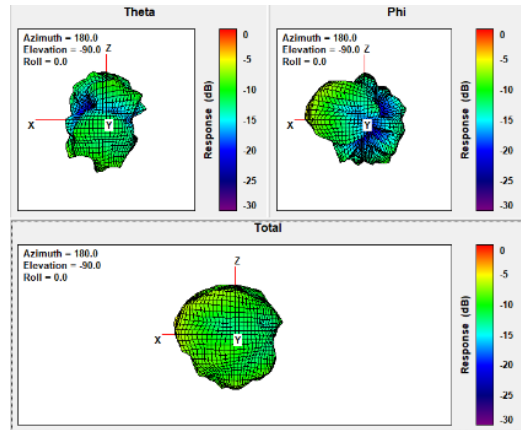

Ant3 Freq. 6475 MHz:

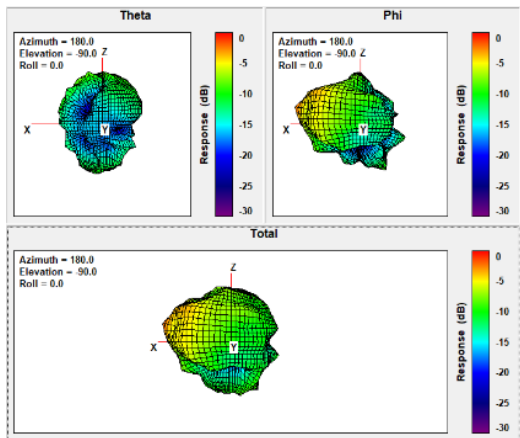

Ant3 Freq. 6700 MHz:

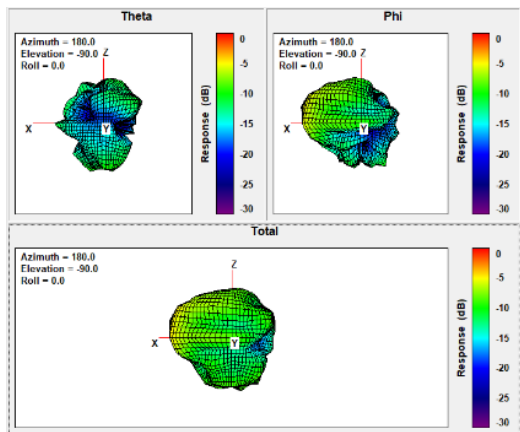

## 8. Report Signatory



---

Sheng Shen  
RF Compliance Technical Program Manager  
Google LLC  
1600 Amphitheatre Parkway  
Mountain View, CA 94043