

## FCC Test Report

**Report No.:** FD181001C19

**FCC ID:** A4RG020G

**Test Model:** G020G

**Received Date:** Oct. 01, 2018

**Test Date:** Nov. 21, 2018 ~ Jan. 21, 2019

**Issued Date:** Jan. 23, 2019

**Applicant:** Google LLC

**Address:** 1600 Amphitheatre Parkway Mountain View, CA 94043, USA

**Issued By:** Bureau Veritas Consumer Products Services (H.K.) Ltd., Taoyuan Branch

**Lab Address:** No.19, Hwa Ya 2nd Rd., Wen Hwa Vil., Kwei Shan Dist., Taoyuan City  
33383, TAIWAN (R.O.C.)

**FCC Registration /  
Designation Number:** 328930 / TW1050



This report is for your exclusive use. Any copying or replication of this report to or for any other person or entity, or use of our name or trademark, is permitted only with our prior written permission. This report sets forth our findings solely with respect to the test samples identified herein. The results set forth in this report are not indicative or representative of the quality or characteristics of the lot from which a test sample was taken or any similar or identical product unless specifically and expressly noted. Our report includes all of the tests requested by you and the results thereof based upon the information that you provided to us. You have 60 days from date of issuance of this report to notify us of any material error or omission caused by our negligence, provided, however, that such notice shall be in writing and shall specifically address the issue you wish to raise. A failure to raise such issue within the prescribed time shall constitute your unqualified acceptance of the completeness of this report, the tests conducted and the correctness of the report contents. Unless specific mention, the uncertainty of measurement has been explicitly taken into account to declare the compliance or non-compliance to the specification. The report must not be used by the client to claim product certification, approval, or endorsement by A2LA, or any agency of the U.S. government. The report must not be used by the client to claim product certification, approval, or endorsement by TAF or any government agencies.

## Table of Contents

<b>Release Control Record .....</b>	<b>3</b>
<b>1 Certificate of Conformity .....</b>	<b>4</b>
<b>2 Summary of Test Results.....</b>	<b>5</b>
2.1 Measurement Uncertainty .....	5
2.2 Modification Record .....	5
<b>3 General Information .....</b>	<b>6</b>
3.1 Features of EUT .....	6
3.2 General Description of EUT .....	6
3.3 Operating Modes of EUT and Determination of Worst Case Operating Mode .....	7
3.4 Test Program Used and Operation Descriptions.....	9
3.5 Primary Clock Frequencies of Internal Source .....	9
<b>4 Configuration and Connections with EUT .....</b>	<b>10</b>
4.1 Connection Diagram of EUT and Peripheral Devices .....	10
4.2 Configuration of Peripheral Devices and Cable Connections .....	11
<b>5 Conducted Emissions at Mains Ports.....</b>	<b>12</b>
5.1 Limits .....	12
5.2 Test Instruments .....	12
5.3 Test Arrangement .....	13
5.4 Test Results.....	14
<b>6 Radiated Emissions up to 1 GHz .....</b>	<b>20</b>
6.1 Limits .....	20
6.2 Test Instruments .....	21
6.3 Test Arrangement .....	22
6.4 Test Results.....	23
<b>7 Radiated Emissions above 1 GHz.....</b>	<b>29</b>
7.1 Limits .....	29
7.2 Test Instruments .....	30
7.3 Test Arrangement .....	31
7.4 Test Results.....	32
<b>Appendix – Information on the Testing Laboratories .....</b>	<b>44</b>

### Release Control Record

Issue No.	Description	Date Issued
FD181001C19	Original Release	Jan. 23, 2019

## 1 Certificate of Conformity

**Product:** Smartphone  
**Test Model:** G020G  
**Sample Status:** Identical Prototype  
**Applicant:** Google LLC  
**Test Date:** Nov. 21, 2018 ~ Jan. 21, 2019  
**Standards:** 47 CFR FCC Part 15, Subpart B, Class B  
ICES-003:2016 Issue 6, Class B  
ANSI C63.4:2014

The above equipment has been tested by **Bureau Veritas Consumer Products Services (H.K.) Ltd., Taoyuan Branch**, and found compliance with the requirement of the above standards. The test record, data evaluation & Equipment Under Test (EUT) configurations represented herein are true and accurate accounts of the measurements of the sample's EMC characteristics under the conditions specified in this report.

**Prepared by :** Gina Liu , **Date:** Jan. 23, 2019  
Gina Liu / Specialist

**Approved by :** Carl Chen , **Date:** Jan. 23, 2019  
Carl Chen / Project Engineer

## 2 Summary of Test Results

47 CFR FCC Part 15, Subpart B / ICES-003:2016 Issue 6, Class B  
ANSI C63.4:2014

FCC Clause	ICES-003 Clause	Test Item	Result/Remarks	Verdict
15.107	6.1	AC Power Line Conducted Emissions	Minimum passing Class B margin is -11.99 dB at 0.19006 MHz	Pass
15.109	6.2.1	Radiated Emissions up to 1 GHz	Minimum passing Class B margin is -4.25 dB at 40.72 MHz	Pass
	6.2.2	Radiated Emissions above 1 GHz	Minimum passing Class B margin is -19.42 dB at 3620.22 MHz	Pass

Note: There is no deviation to the applied test methods and requirements covered by the scope of this report.

### 2.1 Measurement Uncertainty

Where relevant, the following measurement uncertainty levels have been estimated for tests performed on the EUT:

The listed uncertainties are the worst case uncertainty for the entire range of measurement. Please note that the uncertainty values are provided for informational purposes only and are not used in determining the PASS/FAIL results.

Measurement	Frequency	Expanded Uncertainty (k=2) (±)
Conducted Emissions at mains ports	150 kHz ~ 30 MHz	2.44 dB
Radiated Emissions up to 1 GHz	30 MHz ~ 1 GHz	4.70 dB
Radiated Emissions above 1 GHz	Above 1 GHz	2.26 dB

### 2.2 Modification Record

There were no modifications required for compliance.

### 3 General Information

#### 3.1 Features of EUT

The tests reported herein were performed according to the method specified by Google LLC, for detailed feature description, please refer to the manufacturer's specifications or user's manual.

#### 3.2 General Description of EUT

Product	Smartphone
Test Model	G020G
Status of EUT	Identical Prototype
Operating Software	Android 9
Power Supply Rating	3.85 Vdc (Battery) 5 Vdc or 9 Vdc (Adapter) 5 Vdc (host equipment)
Accessory Device	Refer to Note as below
Data Cable Supplied	Refer to Note as below

Note:

1. The EUT accessories list refers to EUT Photo.pdf.
2. There're 2 configurations for the EUT listed as below.  
 Main Sample (A): EUT + Battery 1  
 2<sup>nd</sup> Sample (B): EUT + Battery 2

### 3.3 Operating Modes of EUT and Determination of Worst Case Operating Mode

Test modes are presented in the report as below.

Mode	Sample	Test Condition
		Conducted Emission
1	A	GSM850 Link + BT Link + WLAN (2.4G) Link + GPS & GLONASS Rx + USB Cable 1 + Earphone + NFC On + Adapter 1
2	A	WCDMA1900 Link + BT Link + WLAN (5G) Link + Rear Camera + USB Cable 2 + Earphone + NFC On + Adapter 2
3	A	CDMA BC0 Link + BT Link + WLAN (2.4G) Link + Front Camera + USB Cable 1 + Earphone + NFC On + Adapter 1
4	A	LTE Band 7 Link + BT Link + WLAN (2.4G) Link + MPEG4 + USB Cable 1 + Earphone + NFC On + USB Link
5	A	GSM850 Link + BT Link + WLAN (2.4G) Link + GPS & GLONASS Rx + USB Cable 1 + Earphone + NFC On + Adapter 1 + eSIM
6	B	GSM850 Link + BT Link + WLAN (2.4G) Link + GPS & GLONASS Rx + USB Cable 1 + Earphone + NFC On + Adapter 1
7	A	CDMA BC10 Link (High Channel) + BT Link + WLAN (2.4G) Link + GPS & GLONASS Rx + USB Cable 1 + Earphone + NFC On + Adapter 1
8	A	CDMA BC10 Link (Middle Channel) + BT Link + WLAN (2.4G) Link + GPS & GLONASS Rx + USB Cable 1 + Earphone + NFC On + Adapter 1
9	A	CDMA BC10 Link (Low Channel) + BT Link + WLAN (2.4G) Link + GPS & GLONASS Rx + USB Cable 1 + Earphone + NFC On + Adapter 1
10	A	LTE Band 12 Link (High Channel) + BT Link + WLAN (2.4G) Link + GPS & GLONASS Rx + USB Cable 1 + Earphone + NFC On + Adapter 1
11	A	LTE Band 12 Link (Middle Channel) + BT Link + WLAN (2.4G) Link + GPS & GLONASS Rx + USB Cable 1 + Earphone + NFC On + Adapter 1
12	A	LTE Band 12 Link (Low Channel) + BT Link + WLAN (2.4G) Link + GPS & GLONASS Rx + USB Cable 1 + Earphone + NFC On + Adapter 1
13	A	LTE Band 13 Link (High Channel) + BT Link + WLAN (2.4G) Link + GPS & GLONASS Rx + USB Cable 1 + Earphone + NFC On + Adapter 1
14	A	LTE Band 13 Link (Middle Channel) + BT Link + WLAN (2.4G) Link + GPS & GLONASS Rx + USB Cable 1 + Earphone + NFC On + Adapter 1
15	A	LTE Band 13 Link (Low Channel) + BT Link + WLAN (2.4G) Link + GPS & GLONASS Rx + USB Cable 1 + Earphone + NFC On + Adapter 1
16	A	LTE Band 29 Rx (High Channel) + BT Link + WLAN (2.4G) Link + GPS & GLONASS Rx + USB Cable 1 + Earphone + NFC On + Adapter 1
17	A	LTE Band 29 Rx (Middle Channel) + BT Link + WLAN (2.4G) Link + GPS & GLONASS Rx + USB Cable 1 + Earphone + NFC On + Adapter 1
18	A	LTE Band 29 Rx (Low Channel) + BT Link + WLAN (2.4G) Link + GPS & GLONASS Rx + USB Cable 1 + Earphone + NFC On + Adapter 1
19	A	LTE Band 71 Link (High Channel) + BT Link + WLAN (2.4G) Link + GPS & GLONASS Rx + USB Cable 1 + Earphone + NFC On + Adapter 1
20	A	LTE Band 71 Link (Middle Channel) + BT Link + WLAN (2.4G) Link + GPS & GLONASS Rx + USB Cable 1 + Earphone + NFC On + Adapter 1
21	A	LTE Band 71 Link (Low Channel) + BT Link + WLAN (2.4G) Link + GPS & GLONASS Rx + USB Cable 1 + Earphone + NFC On + Adapter 1

Mode	Sample	Test Condition
		Radiated Emission
1	A	GSM850 Link + BT Link + WLAN (2.4G) Link + GPS & GLONASS Rx + USB Cable 1 + Earphone + NFC On + Adapter 1
2	A	WCDMA1900 Link + BT Link + WLAN (5G) Link + Rear Camera + USB Cable 2 + Earphone + NFC On + Adapter 2
3	A	CDMA BC0 Link + BT Link + WLAN (2.4G) Link + Front Camera + USB Cable 1 + Earphone + NFC On + USB Link
4	A	LTE Band 7 Link + BT Link + WLAN (2.4G) Link + MPEG4 (Flash Play) + Earphone + NFC On + OTG Dongle + Flash
5	A	GSM850 Link + BT Link + WLAN (2.4G) Link + GPS & GLONASS Rx + USB Cable 1 + Earphone + NFC On + Adapter 1 + eSIM
6	B	GSM850 Link + BT Link + WLAN (2.4G) Link + GPS & GLONASS Rx + USB Cable 1 + Earphone + NFC On + Adapter 1
7	A	CDMA BC10 Link (High Channel) + BT Link + WLAN (2.4G) Link + GPS & GLONASS Rx + USB Cable 1 + Earphone + NFC On + Adapter 1
8	A	CDMA BC10 Link (Middle Channel) + BT Link + WLAN (2.4G) Link + GPS & GLONASS Rx + USB Cable 1 + Earphone + NFC On + Adapter 1
9	A	CDMA BC10 Link (Low Channel) + BT Link + WLAN (2.4G) Link + GPS & GLONASS Rx + USB Cable 1 + Earphone + NFC On + Adapter 1
10	A	LTE Band 12 Link (High Channel) + BT Link + WLAN (2.4G) Link + GPS & GLONASS Rx + USB Cable 1 + Earphone + NFC On + Adapter 1
11	A	LTE Band 12 Link (Middle Channel) + BT Link + WLAN (2.4G) Link + GPS & GLONASS Rx + USB Cable 1 + Earphone + NFC On + Adapter 1
12	A	LTE Band 12 Link (Low Channel) + BT Link + WLAN (2.4G) Link + GPS & GLONASS Rx + USB Cable 1 + Earphone + NFC On + Adapter 1
13	A	LTE Band 13 Link (High Channel) + BT Link + WLAN (2.4G) Link + GPS & GLONASS Rx + USB Cable 1 + Earphone + NFC On + Adapter 1
14	A	LTE Band 13 Link (Middle Channel) + BT Link + WLAN (2.4G) Link + GPS & GLONASS Rx + USB Cable 1 + Earphone + NFC On + Adapter 1
15	A	LTE Band 13 Link (Low Channel) + BT Link + WLAN (2.4G) Link + GPS & GLONASS Rx + USB Cable 1 + Earphone + NFC On + Adapter 1
16	A	LTE Band 29 Rx (High Channel) + BT Link + WLAN (2.4G) Link + GPS & GLONASS Rx + USB Cable 1 + Earphone + NFC On + Adapter 1
17	A	LTE Band 29 Rx (Middle Channel) + BT Link + WLAN (2.4G) Link + GPS & GLONASS Rx + USB Cable 1 + Earphone + NFC On + Adapter 1
18	A	LTE Band 29 Rx (Low Channel) + BT Link + WLAN (2.4G) Link + GPS & GLONASS Rx + USB Cable 1 + Earphone + NFC On + Adapter 1
19	A	LTE Band 71 Link (High Channel) + BT Link + WLAN (2.4G) Link + GPS & GLONASS Rx + USB Cable 1 + Earphone + NFC On + Adapter 1
20	A	LTE Band 71 Link (Middle Channel) + BT Link + WLAN (2.4G) Link + GPS & GLONASS Rx + USB Cable 1 + Earphone + NFC On + Adapter 1
21	A	LTE Band 71 Link (Low Channel) + BT Link + WLAN (2.4G) Link + GPS & GLONASS Rx + USB Cable 1 + Earphone + NFC On + Adapter 1



Remark:

1. For cellular band between 30 M ~960 MHz (Including GSM850/WCDMA V/CDMA BC10/LTE Band 5/LTE Band 12/LTE Band 13/LTE Band 17/LTE Band26/LTE Band 29/LTE Band 71), we chose CDMA BC10, LTE Band 12 and LTE Band 13 and LTE Band 29 and LTE Band 71 to test in Low / Middle / High channels to cover all these bands in this report.
2. The EUT had been pre-tested on the positioned of each 3 axis. The worst case was found when positioned on Z-plane.
3. The worst case for conducted emission test and radiated emission test are listed as below. Only these modes were presented in the report.

	Conducted Emission	Radiated Emission
Adapter Mode	Mode 1	Mode 1
USB Link Mode	Mode 4	Mode 3
Receiver Mode	Mode 10	Mode 10

### 3.4 Test Program Used and Operation Descriptions

#### <Adapter Mode & Receiver Mode>

- a. The EUT linked with Bluetooth earphone.
- b. The NFC function was turned on.
- c. The EUT played camera and sent audio signal to the earphone.
- d. The EUT communicated data with the Radio Communication Analyze, GPS simulator and Wireless AP, which acted as communication partners.

#### <USB Link Mode>

- a. The EUT linked with Bluetooth earphone.
- b. The EUT linked with notebook via USB cable.
- c. The NFC function was turned on.
- d. The EUT played MPEG or camera when the mode was tested.
- e. The EUT sent audio signal to the earphone.
- f. The EUT communicated data with the Radio Communication Analyzer and Wireless AP, which acted as communication partners.

### 3.5 Primary Clock Frequencies of Internal Source

The highest frequency generated or used within the EUT or on which the EUT operates or tunes is 5 GHz, provided by Google LLC, for detailed internal source, please refer to the manufacturer's specifications.

#### 4 Configuration and Connections with EUT

##### 4.1 Connection Diagram of EUT and Peripheral Devices

###### <Adapter Mode & Receiver Mode>

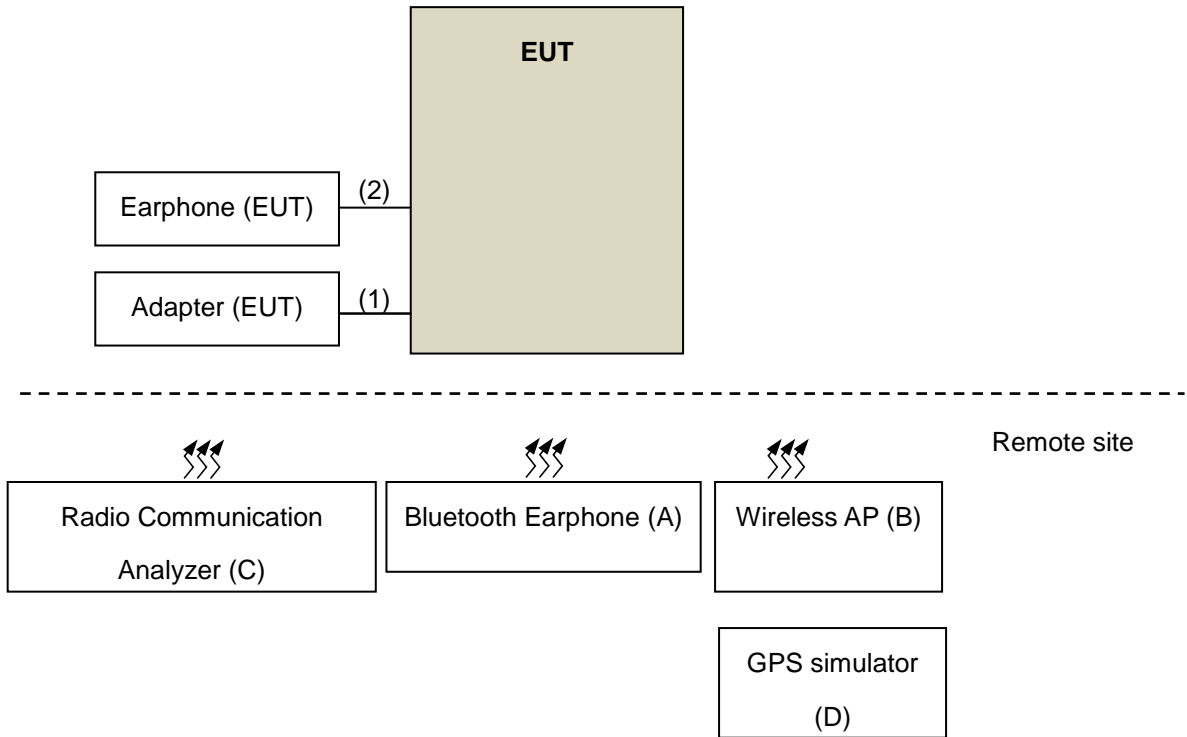

###### <USB Link Mode>

##### Conducted Emission Mode 4

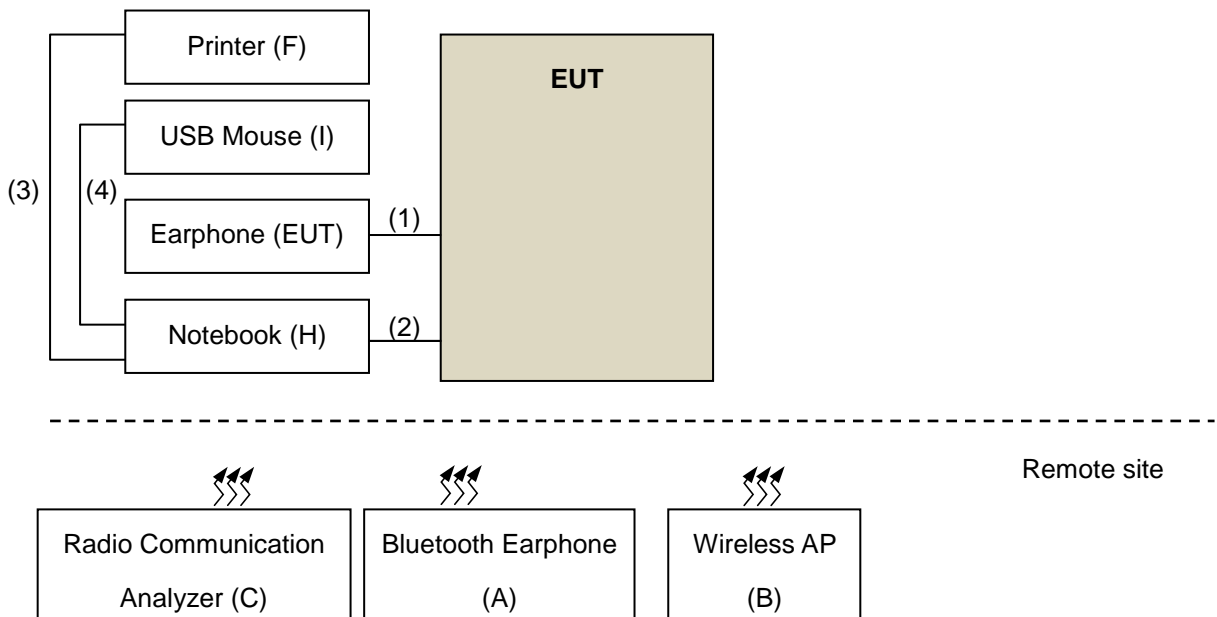

### Radiated Emission Mode 3

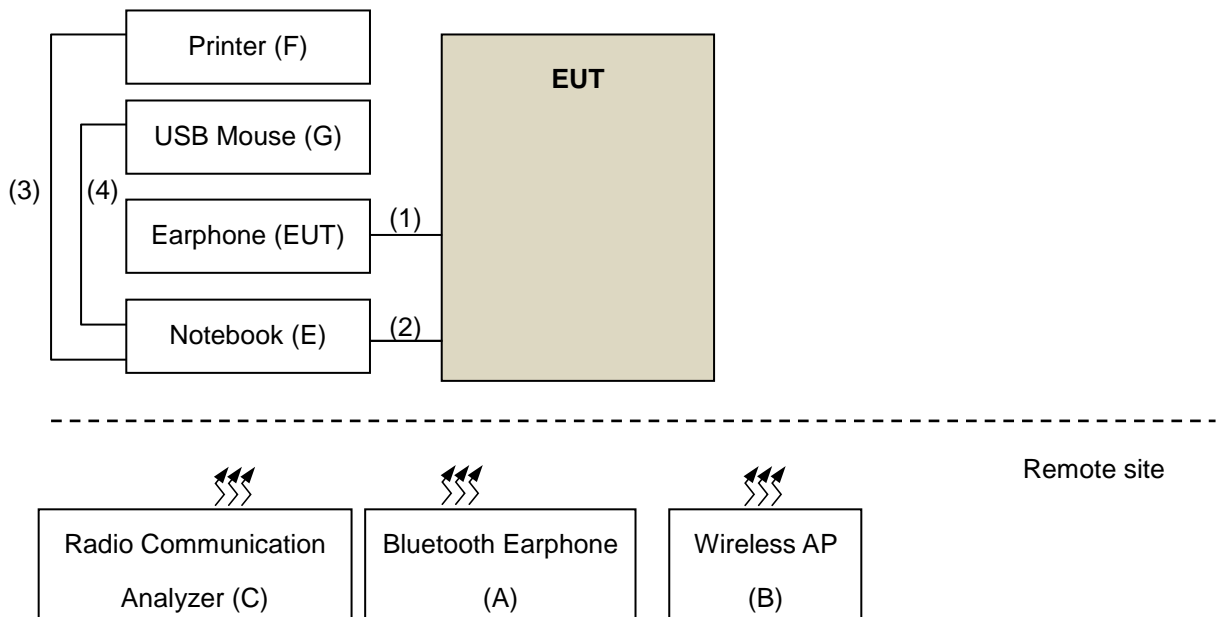

#### 4.2 Configuration of Peripheral Devices and Cable Connections

ID	Product	Brand	Model No.	Serial No.	FCC ID	Remarks
A.	BLUETOOTH EARPHONE	ELECOM	LBT-MPHS400	N/A	N/A	--
B.	Wireless N Dual band Router	D-LINK	DIR-815	PVK21B5000399	KA21R815A1	--
C.	Radio Communication Analyzer	Anritsu	MT8820C	6201010284	N/A	--
D.	GPS simulator	T&E Communication LTD.	GS-50	610493	N/A	--
E.	Notebook	DELL	XPS 13-9350	0V5D5A01	N/A	--
F.	USB PRINTER	EPSON	T22	MEEZ070388	N/A	--
G.	USB Mouse	DELL	MOCZUL	CN-049TWY-PRC 00-79E-02FU	N/A	--
H.	Notebook	DELL	E6440	FMLNM32	N/A	--
I.	USB Mouse	DELL	MS111-P	CN-011D3V-7158 1-1CJ-019E	FCC DoC Approved	--

Note:

1. All power cords of the above support units are non-shielded (1.8m).
2. Items A~D acted as communication partners to transfer data.

ID	Descriptions	Qty.	Length (m)	Shielding (Yes/No)	Cores (Qty.)	Remarks
1.	USB Type C Cable	1	0.95	Y	0	Accessory of the EUT
2.	Audio Cable	1	1.12	N	0	Accessory of the EUT
3.	USB Cable	1	1.8	Y	0	
4.	USB Cable	1	1.8	Y	0	

Note: The core(s) is(are) originally attached to the cable(s).

## 5 Conducted Emissions at Mains Ports

### 5.1 Limits

Frequency (MHz)	Class A (dBUV)		Class B (dBUV)	
	Quasi-peak	Average	Quasi-peak	Average
0.15 - 0.5	79	66	66 - 56	56 - 46
0.50 - 5.0	73	60	56	46
5.0 - 30.0	73	60	60	50

Notes: 1. The lower limit shall apply at the transition frequencies.  
 2. The limit decreases linearly with the logarithm of the frequency in the range of 0.15 to 0.50 MHz.

### 5.2 Test Instruments

Description & Manufacturer	Model No.	Serial No.	Cal. Date	Cal. Due
Test Receiver ROHDE & SCHWARZ	ESR3	102412	Feb. 08, 2018	Feb. 07, 2019
RF signal cable (with 10dB PAD) Woken	5D-FB	Cable-cond2-01	Sep. 05, 2018	Sep. 04, 2019
LISN/AMN ROHDE & SCHWARZ (EUT)	ESH2-Z5	100100	Feb. 05, 2018	Feb. 04, 2019
LISN/AMN ROHDE & SCHWARZ (Peripheral)	ESH3-Z5	100312	Aug. 13, 2018	Aug. 12, 2019
Software ADT	BV ADT_Cond_ V7.3.7.4	NA	NA	NA

Note: 1. The calibration interval of the above test instruments is 12 months and the calibrations are traceable to NML/ROC and NIST/USA.  
 2. The test was performed in HwaYa Shielded Room 2.  
 3. The VCCI Site Registration No. is C-2047.

### 5.3 Test Arrangement

- The EUT was placed 0.4 meters from the conducting wall of the shielded room with EUT being connected to the power mains through a line impedance stabilization network (LISN). Other support units were connected to the power mains through another LISN. The two LISNs provide 50 Ohm/ 50 uH of coupling impedance for the measuring instrument.
- Both lines of the power mains connected to the EUT were checked for maximum conducted interference.
- The test results of conducted emissions at mains ports are recorded of six worst margins for quasi-peak (mandatory) [and average (if necessary)] values against the limits at frequencies of interest unless the margin is 20 dB or greater.

Note: The resolution bandwidth and video bandwidth of test receiver is 9 kHz for quasi-peak detection (QP) and average detection (AV) at frequency 0.15 MHz – 30 MHz.

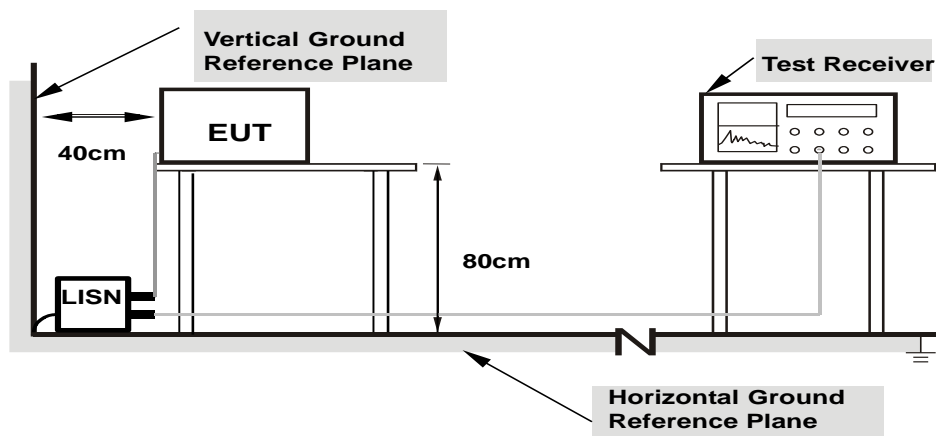

- Note:**
- Support units were connected to second LISN.
  - Both of LISNs (AMN) are 80 cm from EUT and at least 80 cm from other units and other metal planes

## 5.4 Test Results

Frequency Range	150kHz ~ 30MHz	Detector Function & Resolution Bandwidth	Quasi-Peak (QP) / Average (AV), 9kHz
Input Power	120Vac, 60Hz	Environmental Conditions	25°C, 65%RH
Tested by	James Chang	Test Date	2018/12/4
Test Mode	Mode 1		

Phase Of Power : Line (L)										
No	Frequency (MHz)	Correction Factor (dB)	Reading Value (dBuV)		Emission Level (dBuV)		Limit (dBuV)		Margin (dB)	
			Q.P.	AV.	Q.P.	AV.	Q.P.	AV.	Q.P.	AV.
1	0.17925	10.11	41.93	29.60	52.04	39.71	64.52	54.52	-12.48	-14.81
2	0.22151	10.12	38.25	26.81	48.37	36.93	62.76	52.76	-14.39	-15.83
3	0.26788	10.12	35.41	22.41	45.53	32.53	61.18	51.18	-15.65	-18.65
4	0.31222	10.13	33.06	19.53	43.19	29.66	59.91	49.91	-16.72	-20.25
5	0.35534	10.13	30.14	16.91	40.27	27.04	58.84	48.84	-18.57	-21.80
6	0.61702	10.14	31.09	21.19	41.23	31.33	56.00	46.00	-14.77	-14.67

### Remarks:

1. Q.P. and AV. are abbreviations of quasi-peak and average individually.
2. The emission levels of other frequencies were very low against the limit.
3. Margin value = Emission level – Limit value
4. Correction factor = Insertion loss + Cable loss
5. Emission Level = Correction Factor + Reading Value

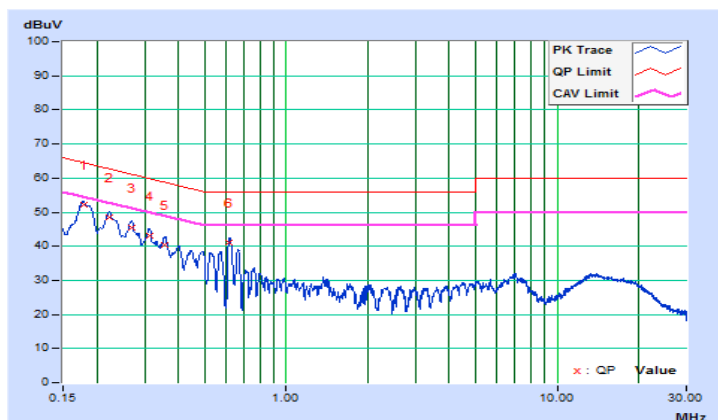

Frequency Range	150kHz ~ 30MHz	Detector Function & Resolution Bandwidth	Quasi-Peak (QP) / Average (AV), 9kHz
Input Power	120Vac, 60Hz	Environmental Conditions	25°C, 65%RH
Tested by	James Chang	Test Date	2018/12/4
Test Mode	Mode 1		

Phase Of Power : Neutral (N)										
No	Frequency (MHz)	Correction Factor (dB)	Reading Value (dBuV)		Emission Level (dBuV)		Limit (dBuV)		Margin (dB)	
			Q.P.	AV.	Q.P.	AV.	Q.P.	AV.	Q.P.	AV.
1	0.15000	10.15	38.64	22.87	48.79	33.02	66.00	56.00	-17.21	-22.98
<b>2</b>	<b>0.19006</b>	<b>10.12</b>	<b>41.92</b>	<b>28.20</b>	<b>52.04</b>	<b>38.32</b>	<b>64.03</b>	<b>54.03</b>	<b>-11.99</b>	<b>-15.71</b>
3	0.24225	10.11	36.41	21.67	46.52	31.78	62.02	52.02	-15.50	-20.24
4	0.28920	10.11	31.39	16.28	41.50	26.39	60.55	50.55	-19.05	-24.16
5	0.57761	10.12	30.28	21.09	40.40	31.21	56.00	46.00	-15.60	-14.79
6	0.67142	10.13	29.59	21.05	39.72	31.18	56.00	46.00	-16.28	-14.82

Remarks:

1. Q.P. and AV. are abbreviations of quasi-peak and average individually.
2. The emission levels of other frequencies were very low against the limit.
3. Margin value = Emission level – Limit value
4. Correction factor = Insertion loss + Cable loss
5. Emission Level = Correction Factor + Reading Value

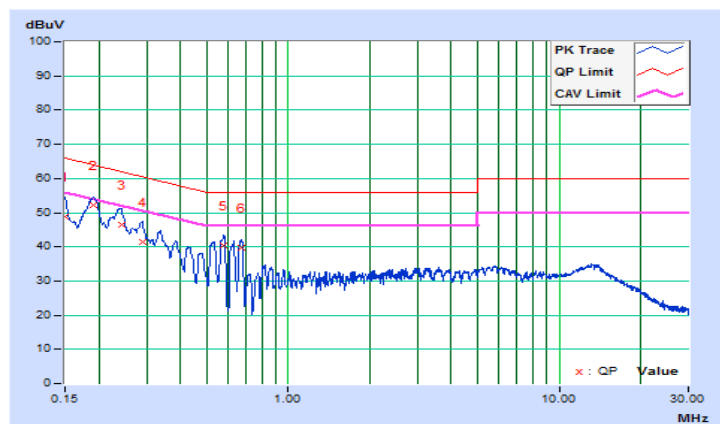

Frequency Range	150kHz ~ 30MHz	Detector Function & Resolution Bandwidth	Quasi-Peak (QP) / Average (AV), 9kHz
Input Power	120Vac, 60Hz	Environmental Conditions	23°C, 66%RH
Tested by	Mick Chou	Test Date	2019/1/21
Test Mode	Mode 4		

Phase Of Power : Line (L)										
No	Frequency (MHz)	Correction Factor (dB)	Reading Value (dBuV)		Emission Level (dBuV)		Limit (dBuV)		Margin (dB)	
			Q.P.	AV.	Q.P.	AV.	Q.P.	AV.	Q.P.	AV.
1	0.16093	10.05	36.78	23.02	46.83	33.07	65.42	55.42	-18.59	-22.35
2	0.22386	10.06	27.28	15.33	37.34	25.39	62.67	52.67	-25.33	-27.28
3	0.28275	10.06	23.68	15.09	33.74	25.15	60.73	50.73	-26.99	-25.58
4	0.49953	10.06	28.62	23.01	38.68	33.07	56.01	46.01	-17.33	-12.94
5	3.57143	10.13	22.70	12.01	32.83	22.14	56.00	46.00	-23.17	-23.86
6	10.09500	10.29	20.96	15.72	31.25	26.01	60.00	50.00	-28.75	-23.99

Remarks:

1. Q.P. and AV. are abbreviations of quasi-peak and average individually.
2. The emission levels of other frequencies were very low against the limit.
3. Margin value = Emission level – Limit value
4. Correction factor = Insertion loss + Cable loss
5. Emission Level = Correction Factor + Reading Value

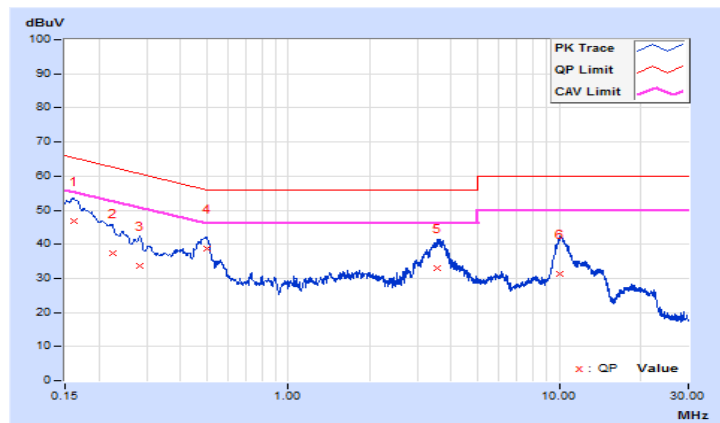



Frequency Range	150kHz ~ 30MHz	Detector Function & Resolution Bandwidth	Quasi-Peak (QP) / Average (AV), 9kHz
Input Power	120Vac, 60Hz	Environmental Conditions	23°C, 66%RH
Tested by	Mick Chou	Test Date	2019/1/21
Test Mode	Mode 4		

Phase Of Power : Neutral (N)										
No	Frequency (MHz)	Correction Factor (dB)	Reading Value (dBuV)		Emission Level (dBuV)		Limit (dBuV)		Margin (dB)	
			Q.P.	AV.	Q.P.	AV.	Q.P.	AV.	Q.P.	AV.
1	0.15924	10.06	37.07	23.20	47.13	33.26	65.50	55.50	-18.37	-22.24
2	0.22650	10.07	27.36	15.73	37.43	25.80	62.58	52.58	-25.15	-26.78
3	0.34517	10.07	19.32	11.06	29.39	21.13	59.08	49.08	-29.69	-27.95
4	0.49298	10.07	29.54	23.85	39.61	33.92	56.12	46.12	-16.51	-12.20
5	3.50250	10.15	22.31	12.42	32.46	22.57	56.00	46.00	-23.54	-23.43
6	10.39200	10.37	17.79	12.32	28.16	22.69	60.00	50.00	-31.84	-27.31

Remarks:

1. Q.P. and AV. are abbreviations of quasi-peak and average individually.
2. The emission levels of other frequencies were very low against the limit.
3. Margin value = Emission level – Limit value
4. Correction factor = Insertion loss + Cable loss
5. Emission Level = Correction Factor + Reading Value

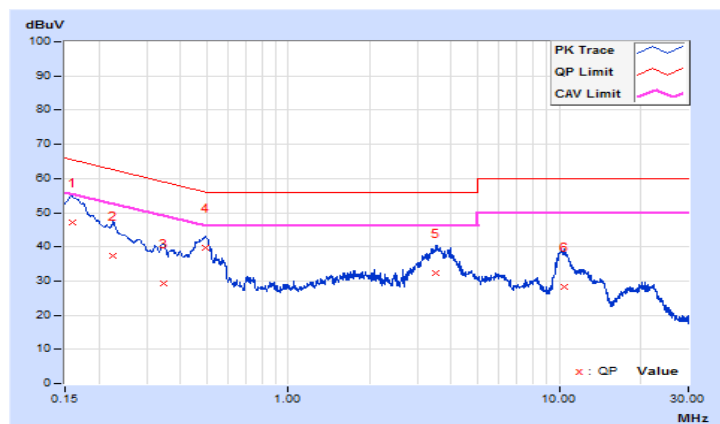

Frequency Range	150kHz ~ 30MHz	Detector Function & Resolution Bandwidth	Quasi-Peak (QP) / Average (AV), 9kHz
Input Power	120Vac, 60Hz	Environmental Conditions	23°C, 62%RH
Tested by	Mick Chou	Test Date	2019/1/19
Test Mode	Mode 10		

Phase Of Power : Line (L)										
No	Frequency (MHz)	Correction Factor (dB)	Reading Value (dBuV)		Emission Level (dBuV)		Limit (dBuV)		Margin (dB)	
			Q.P.	AV.	Q.P.	AV.	Q.P.	AV.	Q.P.	AV.
1	0.15000	10.09	35.99	21.27	46.08	31.36	66.00	56.00	-19.92	-24.64
2	0.21011	10.12	37.88	24.89	48.00	35.01	63.20	53.20	-15.20	-18.19
3	0.28275	10.12	27.85	13.91	37.97	24.03	60.73	50.73	-22.76	-26.70
4	0.35816	10.13	24.12	9.72	34.25	19.85	58.77	48.77	-24.52	-28.92
5	0.56256	10.14	28.84	17.34	38.98	27.48	56.00	46.00	-17.02	-18.52
6	0.63520	10.14	31.31	21.42	41.45	31.56	56.00	46.00	-14.55	-14.44

Remarks:

1. Q.P. and AV. are abbreviations of quasi-peak and average individually.
2. The emission levels of other frequencies were very low against the limit.
3. Margin value = Emission level – Limit value
4. Correction factor = Insertion loss + Cable loss
5. Emission Level = Correction Factor + Reading Value

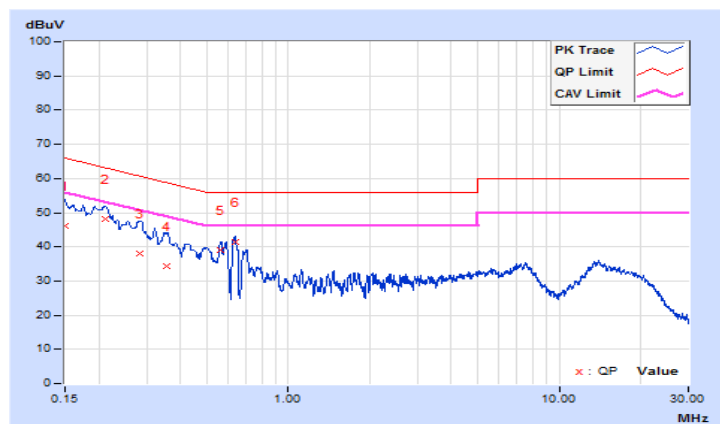

Frequency Range	150kHz ~ 30MHz	Detector Function & Resolution Bandwidth	Quasi-Peak (QP) / Average (AV), 9kHz
Input Power	120Vac, 60Hz	Environmental Conditions	23°C, 62%RH
Tested by	Mick Chou	Test Date	2019/1/19
Test Mode	Mode 10		

Phase Of Power : Neutral (N)										
No	Frequency (MHz)	Correction Factor (dB)	Reading Value (dBuV)		Emission Level (dBuV)		Limit (dBuV)		Margin (dB)	
			Q.P.	AV.	Q.P.	AV.	Q.P.	AV.	Q.P.	AV.
1	0.19258	10.12	39.17	24.52	49.29	34.64	63.92	53.92	-14.63	-19.28
2	0.25748	10.11	36.44	22.15	46.55	32.26	61.51	51.51	-14.96	-19.25
3	0.32397	10.10	31.47	16.34	41.57	26.44	59.60	49.60	-18.03	-23.16
4	0.58066	10.12	31.20	18.07	41.32	28.19	56.00	46.00	-14.68	-17.81
5	0.63857	10.12	27.36	21.44	37.48	31.56	56.00	46.00	-18.52	-14.44
6	0.70783	10.13	26.07	18.27	36.20	28.40	56.00	46.00	-19.80	-17.60

Remarks:

1. Q.P. and AV. are abbreviations of quasi-peak and average individually.
2. The emission levels of other frequencies were very low against the limit.
3. Margin value = Emission level – Limit value
4. Correction factor = Insertion loss + Cable loss
5. Emission Level = Correction Factor + Reading Value

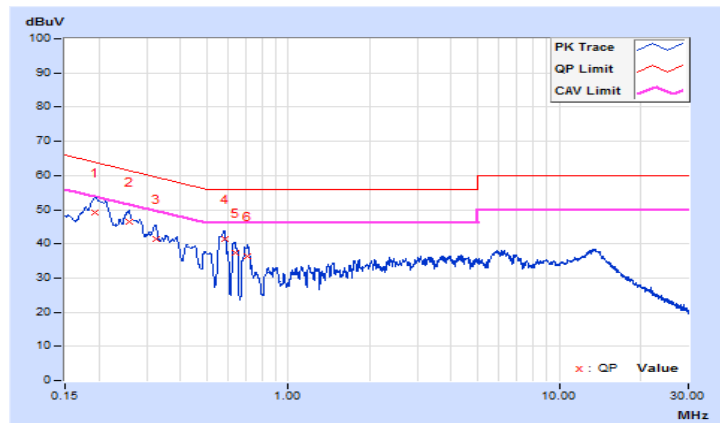

## 6 Radiated Emissions up to 1 GHz

### 6.1 Limits

Emissions radiated outside of the specified bands, shall be according to the general radiated limits as following:

Radiated Emissions Limits at 10 meters (dB $\mu$ V/m)				
Frequencies (MHz)	FCC 15B / ICES-003, Class A	FCC 15B / ICES-003, Class B	CISPR 22, Class A	CISPR 22, Class B
30-88	39	29.5	40	30
88-216	43.5	33.1		
216-230	46.4	35.6		
230-960			47	37
960-1000	49.5	43.5		

Radiated Emissions Limits at 3 meters (dB $\mu$ V/m)				
Frequencies (MHz)	FCC 15B / ICES-003, Class A	FCC 15B / ICES-003, Class B	CISPR 22, Class A	CISPR 22, Class B
30-88	49.5	40	50.5	40.5
88-216	54	43.5		
216-230	56.9	46		
230-960			57.5	47.5
960-1000	60	54		

**Notes:**

1. The lower limit shall apply at the transition frequencies.
2. Emission level (dB $\mu$ V/m) = 20 log Emission level ( $\mu$ V/m).
3. QP detector shall be applied if not specified.

## 6.2 Test Instruments

Description & Manufacturer	Model No.	Serial No.	Cal. Date	Cal. Due
Test Receiver ROHDE & SCHWARZ (V)	ESR	101240	Oct. 30, 2018	Oct. 29, 2019
Test Receiver ROHDE & SCHWARZ (H)	ESR7	101471	Mar. 01, 2018	Feb. 28, 2019
BILOG Antenna SCHWARZBECK (V)	VULB9168	9168-148	Nov. 20, 2018	Nov. 19, 2019
BILOG Antenna SCHWARZBECK (H)	VULB9168	9168-156	Nov. 20, 2018	Nov. 19, 2019
Preamplifier Sonoma (V)	310N	352924	Jul. 12, 2018	Jul. 11, 2019
Preamplifier Sonoma (H)	310N	352923	Jul. 12, 2018	Jul. 11, 2019
RF signal cable (with 5dB PAD) Times (V)	LMR-600 (18M) +LMR-400 (7M)	CABLE-CH1 (VER) -01	Oct. 03, 2018	Oct. 02, 2019
RF signal cable (with 5dB PAD) Times (H)	LMR-600 (11.8M) +LMR-400 (7M)	CABLE-CH1 (HOR) -01	Oct. 03, 2018	Oct. 02, 2019
Software BV ADT	BV ADT_Radiated_ V8.7.08	NA	NA	NA
Antenna Tower (V)	MFA-440	9707	NA	NA
Antenna Tower (H)	MFA-440	970705	NA	NA
Turn Table	DS430	50303	NA	NA
Controller (V)	MF7802	074	NA	NA
Controller (H)	MF7802	08093	NA	NA

NOTE: 1. The calibration interval of the above test instruments is 12 months and the calibrations are traceable to NML/ROC and NIST/USA.

2. The test was performed in HwaYa Chamber 1.
3. The IC Site Registration No. is IC 7450F-1.
4. The VCCI Site Registration No. is R-1893.

### 6.3 Test Arrangement

- The EUT was placed on the top of a rotating table 0.8 meters above the ground at an accredited test facility. The table was rotated 360 degrees to determine the position of the highest radiation.
- The EUT was set 10 meters away from the interference-receiving antenna, which was mounted on the top of a variable-height antenna tower.
- The antenna is a broadband antenna, and its height is varied from one meter to four meters above the ground to determine the maximum value of the field strength. Both horizontal and vertical polarizations of the antenna are set to make the measurement.
- For each suspected emission, the EUT was arranged to its worst case and then the antenna was tuned to heights from 1 meter to 4 meters and the rotatable table was turned from 0 degrees to 360 degrees to find the maximum reading.
- The test-receiver system was set to quasi-peak detect function and specified bandwidth with maximum hold mode when the test frequency is below 1 GHz.

Note: The resolution bandwidth and video bandwidth of test receiver/spectrum analyzer is 120 kHz for quasi-peak detection (QP) at frequency below 1 GHz.

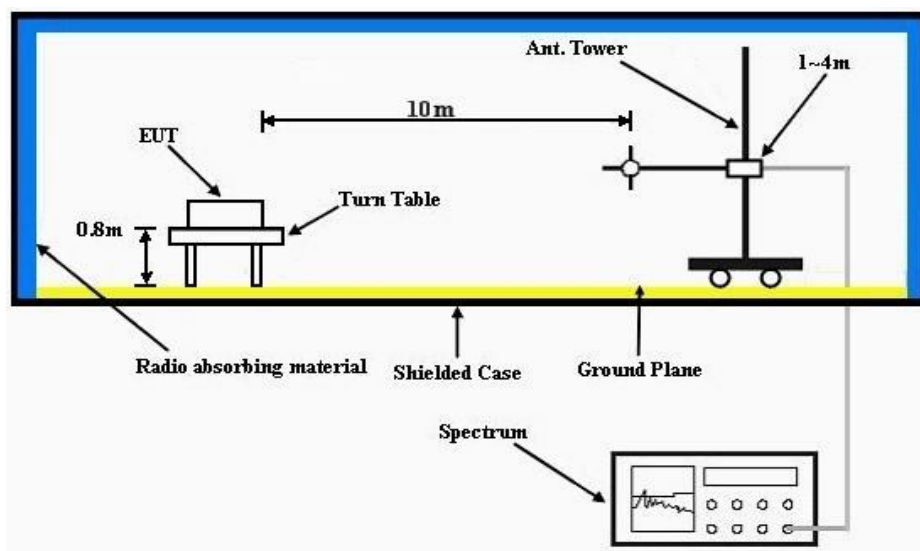

## 6.4 Test Results

Frequency Range	30MHz ~ 1GHz	Detector Function & Resolution Bandwidth	Quasi-Peak (QP), 120kHz
Test Mode	Mode 1	Environmental Conditions	27°C, 68%RH
Tested by	Scott Yang	Test Date	2018/11/21

Antenna Polarity & Test Distance : Horizontal at 10 m								
No	Frequency (MHz)	Emission Level (dBuV/m)	Limit (dBuV/m)	Margin (dB)	Antenna Height (m)	Table Angle (Degree)	Raw Value (dBuV)	Correction Factor (dB/m)
1	30.58	20.41 QP	30.00	-9.59	4.00 H	22	35.23	-14.82
2	40.67	18.39 QP	30.00	-11.61	4.00 H	237	32.29	-13.90
3	59.39	16.50 QP	30.00	-13.50	1.00 H	48	30.30	-13.80
4	155.82	25.39 QP	30.00	-4.61	4.00 H	139	38.13	-12.74
5	198.98	21.23 QP	30.00	-8.77	4.00 H	112	37.18	-15.95
6	269.31	20.36 QP	37.00	-16.64	4.00 H	345	33.04	-12.68

Remarks:

1. Emission Level(dBuV/m) = Raw Value(dBuV) + Correction Factor(dB/m)
2. Correction Factor(dB/m) = Antenna Factor (dB/m) + Cable Factor (dB) – Pre-Amplifier Factor (dB)
3. The other emission levels were very low against the limit.
4. Margin value = Emission level – Limit value

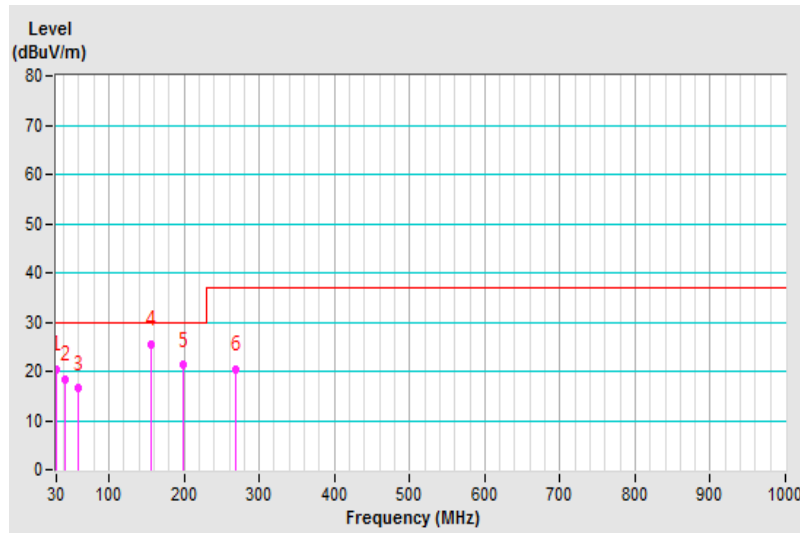

Frequency Range	30MHz ~ 1GHz	Detector Function & Resolution Bandwidth	Quasi-Peak (QP), 120kHz
Test Mode	Mode 1	Environmental Conditions	27°C, 68%RH
Tested by	Scott Yang	Test Date	2018/11/21

Antenna Polarity & Test Distance : Vertical at 10 m								
No	Frequency (MHz)	Emission Level (dBuV/m)	Limit (dBuV/m)	Margin (dB)	Antenna Height (m)	Table Angle (Degree)	Raw Value (dBuV)	Correction Factor (dB/m)
1	40.72	25.75 QP	30.00	-4.25	4.00 V	204	39.89	-14.14
2	67.78	19.64 QP	30.00	-10.36	3.00 V	62	34.39	-14.75
3	155.62	18.42 QP	30.00	-11.58	3.50 V	31	31.66	-13.24
4	169.69	18.49 QP	30.00	-11.51	3.50 V	351	31.91	-13.42
5	198.98	18.90 QP	30.00	-11.10	1.00 V	342	35.46	-16.56
6	457.26	22.41 QP	37.00	-14.59	1.50 V	18	32.00	-9.59

Remarks:

1. Emission Level(dBuV/m) = Raw Value(dBuV) + Correction Factor(dB/m)
2. Correction Factor(dB/m) = Antenna Factor (dB/m) + Cable Factor (dB) – Pre-Amplifier Factor (dB)
3. The other emission levels were very low against the limit.
4. Margin value = Emission level – Limit value

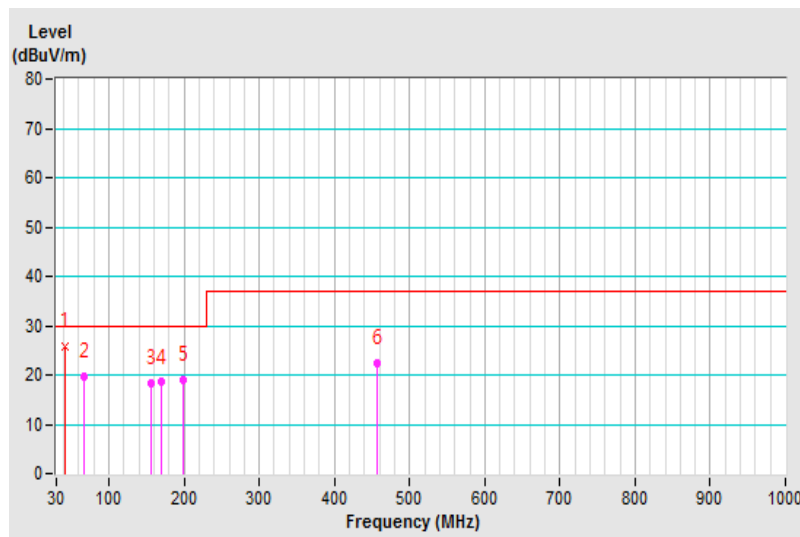



Frequency Range	30MHz ~ 1GHz	Detector Function & Resolution Bandwidth	Quasi-Peak (QP), 120kHz
Test Mode	Mode 3	Environmental Conditions	23°C, 64%RH
Tested by	Ben Huang	Test Date	2019/1/21

Antenna Polarity & Test Distance : Horizontal at 10 m								
No	Frequency (MHz)	Emission Level (dBuV/m)	Limit (dBuV/m)	Margin (dB)	Antenna Height (m)	Table Angle (Degree)	Raw Value (dBuV)	Correction Factor (dB/m)
1	206.31	24.01 QP	30.00	-5.99	3.00 H	353	39.14	-15.13
2	260.05	26.66 QP	37.00	-10.34	3.00 H	142	39.37	-12.71
3	398.70	29.43 QP	37.00	-7.57	3.00 H	360	38.42	-8.99
4	517.40	29.05 QP	37.00	-7.95	2.00 H	103	36.53	-7.48
5	796.48	29.58 QP	37.00	-7.42	1.00 H	94	30.32	-0.74
6	998.45	31.59 QP	37.00	-5.41	1.00 H	135	29.47	2.12

Remarks:

1. Emission Level(dBuV/m) = Raw Value(dBuV) + Correction Factor(dB/m)
2. Correction Factor(dB/m) = Antenna Factor (dB/m) + Cable Factor (dB) – Pre-Amplifier Factor (dB)
3. The other emission levels were very low against the limit.
4. Margin value = Emission level – Limit value

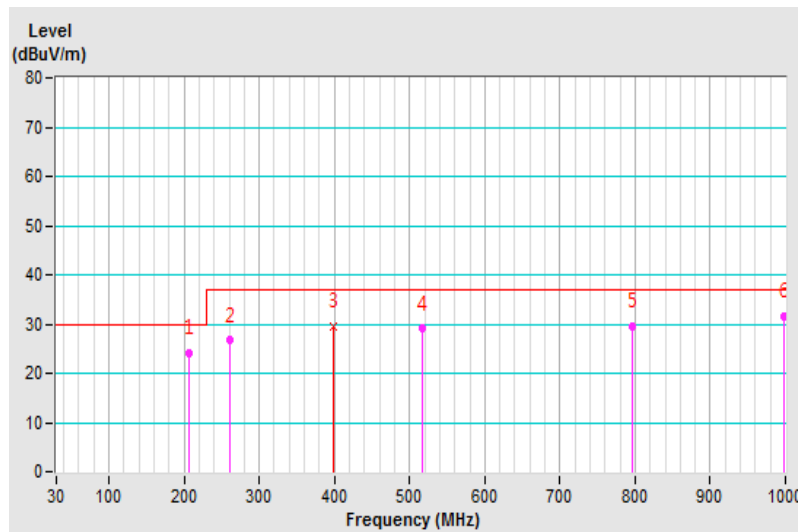

Frequency Range	30MHz ~ 1GHz	Detector Function & Resolution Bandwidth	Quasi-Peak (QP), 120kHz
Test Mode	Mode 3	Environmental Conditions	23°C, 64%RH
Tested by	Ben Huang	Test Date	2019/1/21

Antenna Polarity & Test Distance : Vertical at 10 m								
No	Frequency (MHz)	Emission Level (dBuV/m)	Limit (dBuV/m)	Margin (dB)	Antenna Height (m)	Table Angle (Degree)	Raw Value (dBuV)	Correction Factor (dB/m)
1	37.91	16.55 QP	30.00	-13.45	4.00 V	148	31.53	-14.98
2	173.62	19.32 QP	30.00	-10.68	2.50 V	2	33.12	-13.80
3	207.08	19.96 QP	30.00	-10.04	1.50 V	346	35.78	-15.82
4	398.67	30.62 QP	37.00	-6.38	3.50 V	100	39.88	-9.26
5	521.72	27.82 QP	37.00	-9.18	4.00 V	343	35.98	-8.16
6	796.77	29.98 QP	37.00	-7.02	2.50 V	1	31.42	-1.44

Remarks:

1. Emission Level(dBuV/m) = Raw Value(dBuV) + Correction Factor(dB/m)
2. Correction Factor(dB/m) = Antenna Factor (dB/m) + Cable Factor (dB) – Pre-Amplifier Factor (dB)
3. The other emission levels were very low against the limit.
4. Margin value = Emission level – Limit value

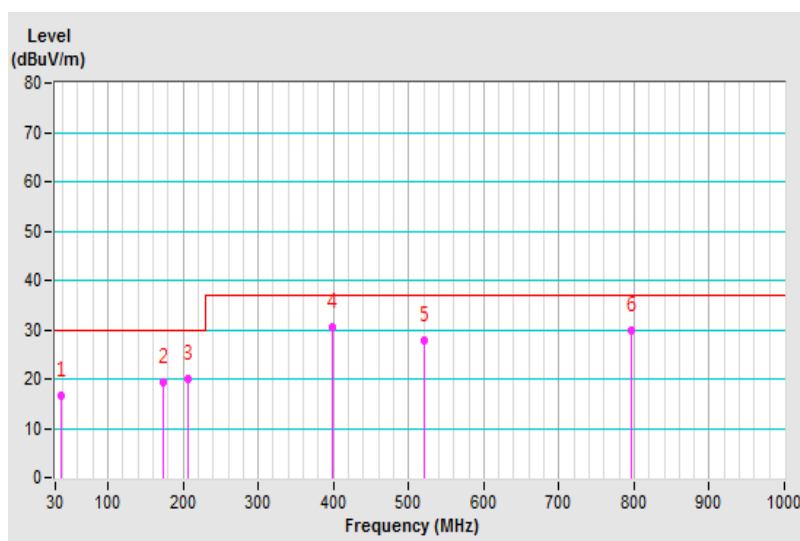

Frequency Range	30MHz ~ 1GHz	Detector Function & Resolution Bandwidth	Quasi-Peak (QP), 120kHz
Test Mode	Mode 10	Environmental Conditions	23°C, 64%RH
Tested by	Daniel Lin	Test Date	2019/1/18

Antenna Polarity & Test Distance : Horizontal at 10 m								
No	Frequency (MHz)	Emission Level (dBuV/m)	Limit (dBuV/m)	Margin (dB)	Antenna Height (m)	Table Angle (Degree)	Raw Value (dBuV)	Correction Factor (dB/m)
1	33.20	16.20 QP	30.00	-13.80	1.00 H	215	30.49	-14.29
2	61.30	15.30 QP	30.00	-14.70	2.63 H	215	29.29	-13.99
3	156.00	16.90 QP	30.00	-13.10	2.00 H	280	29.62	-12.72
4	277.00	18.70 QP	37.00	-18.30	1.00 H	345	31.41	-12.71
5	496.20	21.60 QP	37.00	-15.40	1.00 H	345	28.18	-6.58
6	755.00	25.30 QP	37.00	-11.70	1.50 H	65	28.86	-3.56

Remarks:

1. Emission Level(dBuV/m) = Raw Value(dBuV) + Correction Factor(dB/m)
2. Correction Factor(dB/m) = Antenna Factor (dB/m) + Cable Factor (dB) – Pre-Amplifier Factor (dB)
3. The other emission levels were very low against the limit.
4. Margin value = Emission level – Limit value

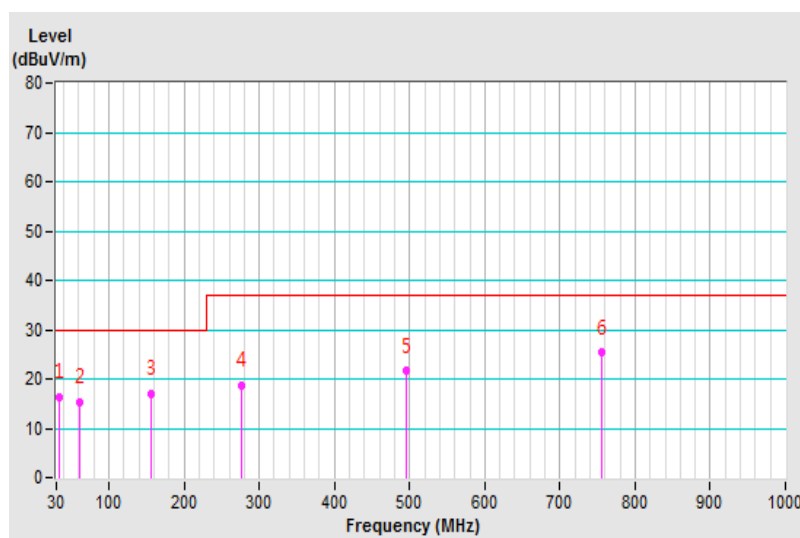

Frequency Range	30MHz ~ 1GHz	Detector Function & Resolution Bandwidth	Quasi-Peak (QP), 120kHz
Test Mode	Mode 10	Environmental Conditions	23°C, 64%RH
Tested by	Daniel Lin	Test Date	2019/1/18

Antenna Polarity & Test Distance : Vertical at 10 m								
No	Frequency (MHz)	Emission Level (dBuV/m)	Limit (dBuV/m)	Margin (dB)	Antenna Height (m)	Table Angle (Degree)	Raw Value (dBuV)	Correction Factor (dB/m)
1	31.20	23.20 QP	30.00	-6.80	1.00 V	237	38.19	-14.99
2	39.50	25.70 QP	30.00	-4.30	1.00 V	208	39.95	-14.25
3	66.30	19.80 QP	30.00	-10.20	1.00 V	248	34.69	-14.89
4	150.00	16.90 QP	30.00	-13.10	1.00 V	222	30.14	-13.24
5	279.50	17.50 QP	37.00	-19.50	4.00 V	150	30.71	-13.21
6	428.98	21.30 QP	37.00	-15.70	3.00 V	146	30.15	-8.85

Remarks:

1. Emission Level(dBuV/m) = Raw Value(dBuV) + Correction Factor(dB/m)
2. Correction Factor(dB/m) = Antenna Factor (dB/m) + Cable Factor (dB) – Pre-Amplifier Factor (dB)
3. The other emission levels were very low against the limit.
4. Margin value = Emission level – Limit value

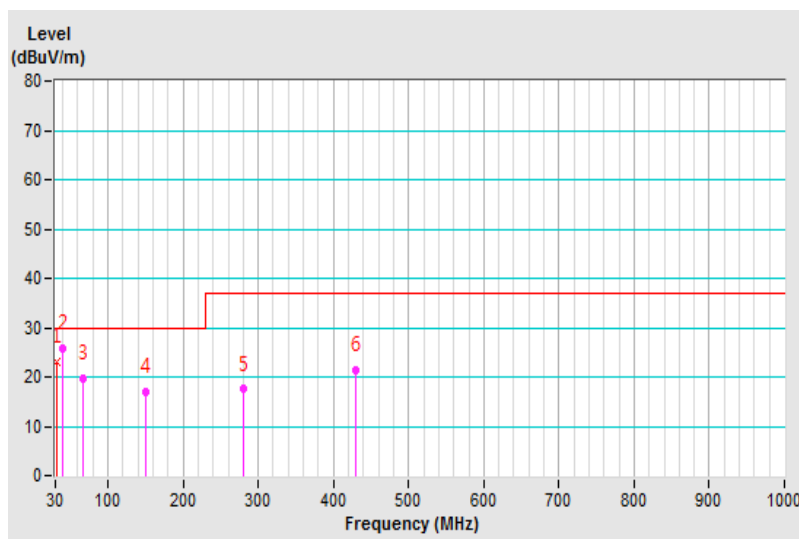

## 7 Radiated Emissions above 1 GHz

### 7.1 Limits

Emissions radiated outside of the specified bands, shall be according to the general radiated limits as following:

Radiated Emissions Limits at 10 meters (dB $\mu$ V/m)				
Frequencies (MHz)	FCC 15B / ICES-003, Class A	FCC 15B / ICES-003, Class B	CISPR 22, Class A	CISPR 22, Class B
1000-3000	Avg: 49.5	Avg: 43.5	Not defined	Not defined
Above 3000	Peak: 69.5	Peak: 63.5	Not defined	Not defined

Radiated Emissions Limits at 3 meters (dB $\mu$ V/m)				
Frequencies (MHz)	FCC 15B / ICES-003, Class A	FCC 15B / ICES-003, Class B	CISPR 22, Class A	CISPR 22, Class B
1000-3000	Avg: 60	Avg: 54	Avg: 56 Peak: 76	Avg: 50 Peak: 70
Above 3000	Peak: 80	Peak: 74	Avg: 60 Peak: 80	Avg: 54 Peak: 74

Notes:

1. The lower limit shall apply at the transition frequencies.
2. Emission level (dB $\mu$ V/m) = 20 log Emission level (uV/m).
3. As shown in 15.35(b), for frequencies above 1000 MHz, the field strength limits are based on average detector, however, the peak field strength of any emission shall not exceed the maximum permitted average limits, specified above by more than 20 dB under any condition of modulation.

Radiated Emissions Limits at 1.5 meters (dB $\mu$ V/m)		
Frequencies (MHz)	FCC 15B / ICES-003, Class A	FCC 15B / ICES-003, Class B
Above 18000	Avg: 66 Peak: 86	Avg: 60 Peak: 80

Note: Limit@1.5m = Limit@3m + 20log(3/1.5)

Frequency Range (For unintentional radiators)

Highest frequency generated or used in the device or on which the device operates or tunes (MHz)	Upper frequency of measurement range (MHz)
Below 1.705	30
1.705-108	1000
108-500	2000
500-1000	5000
Above 1000	5 <sup>th</sup> harmonic of the highest frequency or 40 GHz, whichever is lower

## 7.2 Test Instruments

Description & Manufacturer	Model No.	Serial No.	Cal. Date	Cal. Due
Test Receiver ROHDE & SCHWARZ (Above 1GHz)	ESR7	101471	Mar. 01, 2018	Feb. 28, 2019
Spectrum Analyzer Agilent	E4446A	MY51100039	Sep. 10, 2018	Sep. 09, 2019
RF signal cable (with 5dB PAD) Times	LMR-400 (18M)	CABLE-CH2-01	Apr. 27, 2018	Apr. 26, 2019
HORN Antenna (with 4dB PAD) SCHWARZBECK	BBHA 9120 D	9120D-405	Dec. 01, 2017 Nov. 25, 2018	Nov. 30, 2018 Nov. 24, 2019
Pre-Amplifier Agilent (Above 1GHz)	8449B	3008A01961	Oct. 15, 2018	Oct. 14, 2019
RF Coaxial Cable JUNFLON+EMC	JUNFLON+EMC10 4-SM-SM-6000	Cable-CH2-02(MWX3221308 G003+130710)	Jun. 11, 2018	Jun. 10, 2019
Software BV ADT	BV ADT_Radiated_ V8.7.08	NA	NA	NA
Antenna Tower BV ADT	AT100	AT93021702	NA	NA
Turn Table BV ADT	TT100	TT93021702	NA	NA
Controller BV ADT	SC100	SC93021702	NA	NA
RF Coaxial Cable EMCI	EMC102-KM-KM-1 000	170820	Aug. 28, 2018	Aug. 27, 2019
RF Coaxial Cable EMCI	EMC102-KM-KM-3 000	150929	Aug. 28, 2018	Aug. 27, 2019
Fix tool for Boresight antenna	BAF-01	2	NA	NA
Pre-amplifier (18GHz-40GHz) EMC	EMC184045B	980175	Nov. 14, 2018	Nov. 13, 2019
HORN Antenna (with 3dB PAD) SCHWARZBECK	BBHA 9170	148	Dec. 13, 2017 Nov. 25, 2018	Dec. 12, 2018 Nov. 24, 2019

- Note:
1. The calibration interval of the above test instruments is 12 months and the calibrations are traceable to NML/ROC and NIST/USA.
  2. The test was performed in HwaYa Chamber 2.
  3. The horn antenna and preamplifier (model: 8449B) are used only for the measurement of emission frequency above 1GHz if tested.
  4. The IC Site Registration No. is IC 7450F-2.
  5. The VCCI Site Registration No. is G-10018.

### 7.3 Test Arrangement

- a. The EUT was placed on the top of a rotating table 0.8 meters above the ground at an accredited chamber room. The table was rotated 360 degrees to determine the position of the highest radiation.
- b. The EUT was set 3 meters away from the interference-receiving antenna, which was mounted on the top of a variable-height antenna tower.
- c. For frequency range 1 GHz ~ 18 GHz, the EUT was set 3 meters away from the interference-receiving antenna, which was mounted on the top of a variable-height antenna tower.
- d. For frequency range 18 GHz ~ 40 GHz, the EUT was set 1.5 meters away from the interference-receiving antenna, which was mounted on the top of a variable-height antenna tower.
- e. The height of antenna can be varied from one meter to four meters, the height of adjustment depends on the EUT height and the antenna 3 dB beamwidth both, to detect the maximum value of the field strength. Both horizontal and vertical polarizations of the antenna are set to make the measurement.
- f. For each suspected emission, the EUT was arranged to its worst case and then the antenna was tuned to heights and the rotatable table was turned from 0 degrees to 360 degrees to find the maximum reading.
- g. The spectrum analyzer system was set to peak and average detect function and specified bandwidth with maximum hold mode when the test frequency is above 1 GHz.

Note: The resolution bandwidth of test receiver/spectrum analyzer is 1 MHz and video bandwidth is 3 MHz for Peak detection (PK) at frequency above 1 GHz. The resolution bandwidth of test receiver/spectrum analyzer is 1 MHz for Average detection (AV) at frequency above 1 GHz.

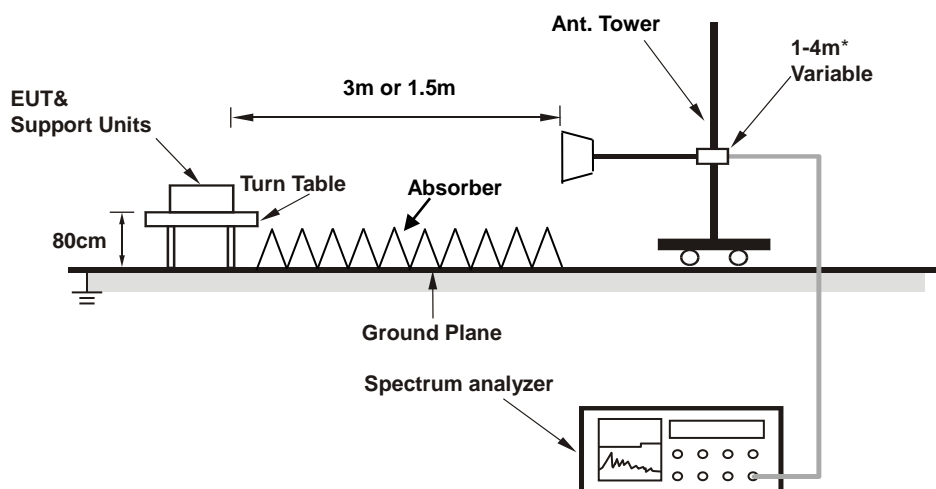

### 7.4 Test Results

Frequency Range	1GHz ~ 18GHz	Detector Function & Resolution Bandwidth	Peak (PK) / Average (AV), 1MHz
Test Mode	Mode 1	Environmental Conditions	24°C, 65%RH
Tested by	Rolan Zheng	Test Date	2018/11/21

Antenna Polarity & Test Distance : Horizontal at 3 m								
No	Frequency (MHz)	Emission Level (dBuV/m)	Limit (dBuV/m)	Margin (dB)	Antenna Height (m)	Table Angle (Degree)	Raw Value (dBuV)	Correction Factor (dB/m)
1	1528.16	43.55 PK	74.00	-30.45	1.00 H	360	44.51	-0.96
2	1528.16	30.62 AV	54.00	-23.38	1.00 H	360	31.58	-0.96
3	3173.99	45.58 PK	74.00	-28.42	1.08 H	183	40.65	4.93
4	3173.99	28.73 AV	54.00	-25.27	1.08 H	183	23.80	4.93
5	3599.46	46.10 PK	74.00	-27.90	1.52 H	136	40.63	5.47
6	3599.46	33.28 AV	54.00	-20.72	1.52 H	136	27.81	5.47

Remarks:

1. Emission Level(dBuV/m) = Raw Value(dBuV) + Correction Factor(dB/m)
2. Correction Factor(dB/m) = Antenna Factor (dB/m) + Cable Factor (dB) – Pre-Amplifier Factor (dB)
3. The other emission levels were very low against the limit.
4. Margin value = Emission level – Limit value

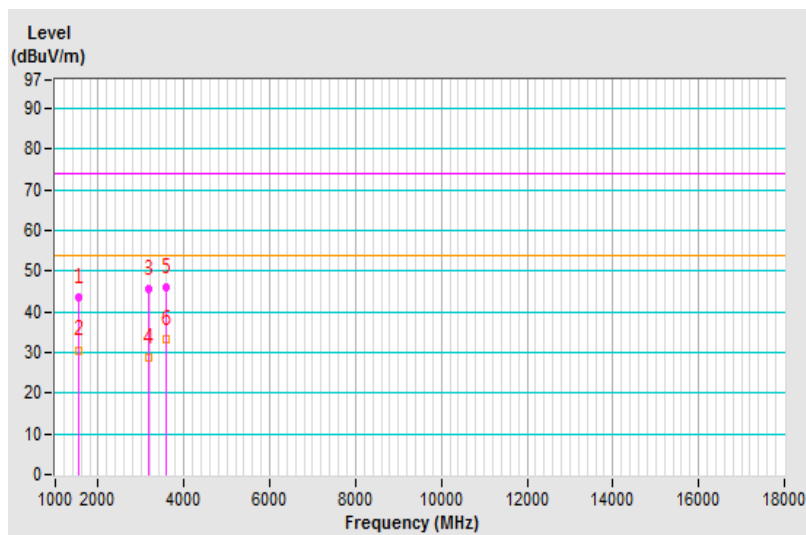



Frequency Range	1GHz ~ 18GHz	Detector Function & Resolution Bandwidth	Peak (PK) / Average (AV), 1MHz
Test Mode	Mode 1	Environmental Conditions	24°C, 65%RH
Tested by	Rolan Zheng	Test Date	2018/11/21

Antenna Polarity & Test Distance : Vertical at 3 m

No	Frequency (MHz)	Emission Level (dBuV/m)	Limit (dBuV/m)	Margin (dB)	Antenna Height (m)	Table Angle (Degree)	Raw Value (dBuV)	Correction Factor (dB/m)
1	1389.11	41.60 PK	74.00	-32.40	1.46 V	111	42.42	-0.82
2	1389.11	26.97 AV	54.00	-27.03	1.46 V	111	27.79	-0.82
3	2013.83	43.99 PK	74.00	-30.01	1.00 V	233	42.82	1.17
4	2013.83	28.51 AV	54.00	-25.49	1.00 V	233	27.34	1.17
5	3169.84	45.65 PK	74.00	-28.35	1.54 V	146	40.73	4.92
6	3169.84	32.26 AV	54.00	-21.74	1.54 V	146	27.34	4.92

Remarks:

1. Emission Level(dBuV/m) = Raw Value(dBuV) + Correction Factor(dB/m)
2. Correction Factor(dB/m) = Antenna Factor (dB/m) + Cable Factor (dB) – Pre-Amplifier Factor (dB)
3. The other emission levels were very low against the limit.
4. Margin value = Emission level – Limit value

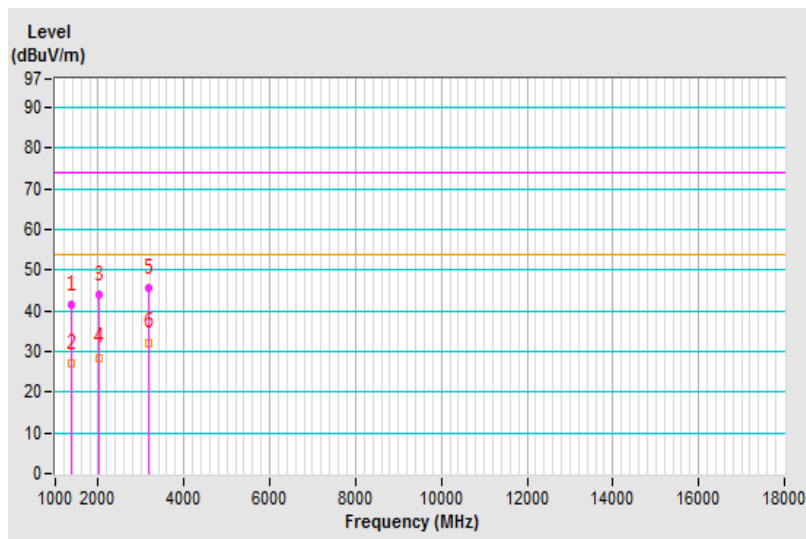

Frequency Range	18GHz ~ 40GHz	Detector Function & Resolution Bandwidth	Peak (PK) / Average (AV), 1MHz
Test Mode	Mode 1	Environmental Conditions	24°C, 65%RH
Tested by	Rolan Zheng	Test Date	2018/11/21

Antenna Polarity & Test Distance : Horizontal at 1.5 m

No	Frequency (MHz)	Emission Level (dBuV/m)	Limit (dBuV/m)	Margin (dB)	Antenna Height (m)	Table Angle (Degree)	Raw Value (dBuV)	Correction Factor (dB/m)
1	19532.25	48.21 PK	80.00	-31.79	1.72 H	225	50.72	-2.51
2	19532.25	33.63 AV	60.00	-26.37	1.72 H	225	36.14	-2.51

Remarks:

1. Emission Level(dBuV/m) = Raw Value(dBuV) + Correction Factor(dB/m)
2. Correction Factor(dB/m) = Antenna Factor (dB/m) + Cable Factor (dB) – Pre-Amplifier Factor (dB)
3. The other emission levels were very low against the limit.
4. Margin value = Emission level – Limit value

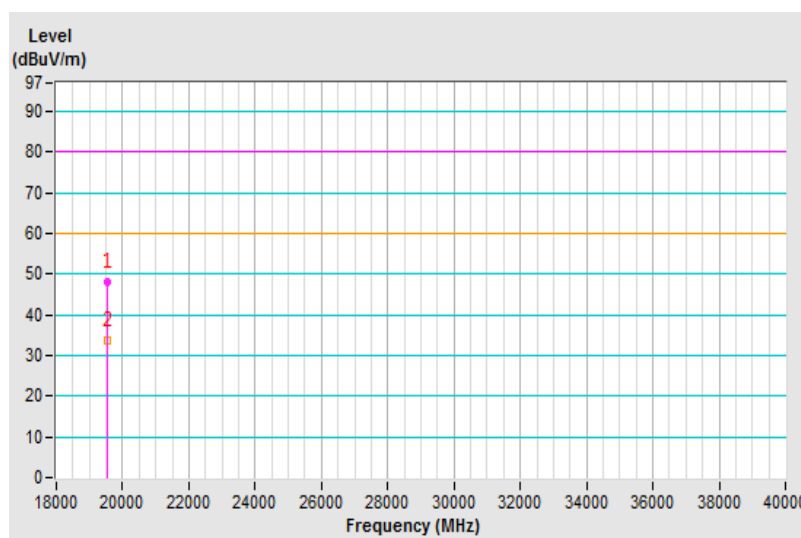

Frequency Range	18GHz ~ 40GHz	Detector Function & Resolution Bandwidth	Peak (PK) / Average (AV), 1MHz
Test Mode	Mode 1	Environmental Conditions	24°C, 65%RH
Tested by	Rolan Zheng	Test Date	2018/11/21

**Antenna Polarity & Test Distance : Vertical at 1.5 m**

No	Frequency (MHz)	Emission Level (dBuV/m)	Limit (dBuV/m)	Margin (dB)	Antenna Height (m)	Table Angle (Degree)	Raw Value (dBuV)	Correction Factor (dB/m)
1	21335.21	50.26 PK	80.00	-29.74	1.36 V	144	50.56	-0.30
2	21335.21	34.79 AV	60.00	-25.21	1.36 V	144	35.09	-0.30

Remarks:

1. Emission Level(dBuV/m) = Raw Value(dBuV) + Correction Factor(dB/m)
2. Correction Factor(dB/m) = Antenna Factor (dB/m) + Cable Factor (dB) – Pre-Amplifier Factor (dB)
3. The other emission levels were very low against the limit.
4. Margin value = Emission level – Limit value

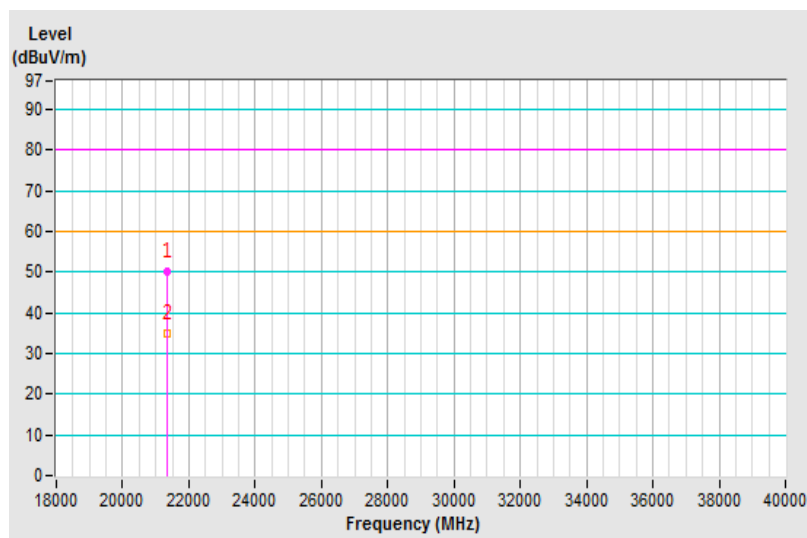

Frequency Range	1GHz ~ 18GHz	Detector Function & Resolution Bandwidth	Peak (PK) / Average (AV), 1MHz
Test Mode	Mode 3	Environmental Conditions	22°C, 63%RH
Tested by	Rolan Zheng	Test Date	2019/1/22

Antenna Polarity & Test Distance : Horizontal at 3 m								
No	Frequency (MHz)	Emission Level (dBuV/m)	Limit (dBuV/m)	Margin (dB)	Antenna Height (m)	Table Angle (Degree)	Raw Value (dBuV)	Correction Factor (dB/m)
1	1862.31	42.78 PK	74.00	-31.22	1.76 H	352	43.14	-0.36
2	1862.31	27.88 AV	54.00	-26.12	1.76 H	352	28.24	-0.36
3	2368.72	45.14 PK	74.00	-28.86	1.00 H	264	42.45	2.69
4	2368.72	31.87 AV	54.00	-22.13	1.00 H	264	29.18	2.69
5	3333.80	45.41 PK	74.00	-28.59	1.15 H	19	41.39	4.02
6	3333.80	33.56 AV	54.00	-20.44	1.15 H	19	29.54	4.02

Remarks:

1. Emission Level(dBuV/m) = Raw Value(dBuV) + Correction Factor(dB/m)
2. Correction Factor(dB/m) = Antenna Factor (dB/m) + Cable Factor (dB) – Pre-Amplifier Factor (dB)
3. The other emission levels were very low against the limit.
4. Margin value = Emission level – Limit value

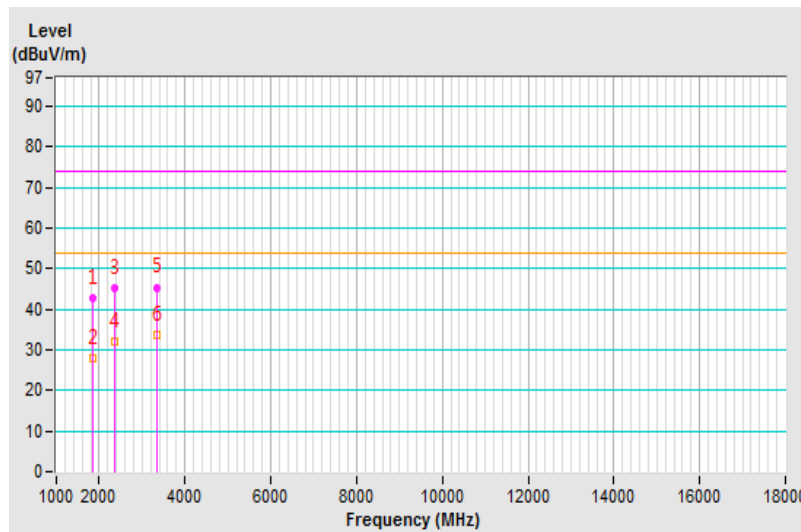

Frequency Range	1GHz ~ 18GHz	Detector Function & Resolution Bandwidth	Peak (PK) / Average (AV), 1MHz
Test Mode	Mode 3	Environmental Conditions	22°C, 63%RH
Tested by	Rolan Zheng	Test Date	2019/1/22

Antenna Polarity & Test Distance : Vertical at 3 m

No	Frequency (MHz)	Emission Level (dBuV/m)	Limit (dBuV/m)	Margin (dB)	Antenna Height (m)	Table Angle (Degree)	Raw Value (dBuV)	Correction Factor (dB/m)
1	1225.15	41.35 PK	74.00	-32.65	1.85 V	2	43.96	-2.61
2	1225.15	27.79 AV	54.00	-26.21	1.85 V	2	30.40	-2.61
3	1900.87	43.73 PK	74.00	-30.27	1.00 V	76	43.82	-0.09
4	1900.87	30.56 AV	54.00	-23.44	1.00 V	76	30.65	-0.09
5	3620.22	45.54 PK	74.00	-28.46	1.32 V	144	40.35	5.19
<b>6</b>	<b>3620.22</b>	<b>34.58 AV</b>	<b>54.00</b>	<b>-19.42</b>	<b>1.32 V</b>	<b>144</b>	<b>29.39</b>	<b>5.19</b>

Remarks:

1. Emission Level(dBuV/m) = Raw Value(dBuV) + Correction Factor(dB/m)
2. Correction Factor(dB/m) = Antenna Factor (dB/m) + Cable Factor (dB) – Pre-Amplifier Factor (dB)
3. The other emission levels were very low against the limit.
4. Margin value = Emission level – Limit value

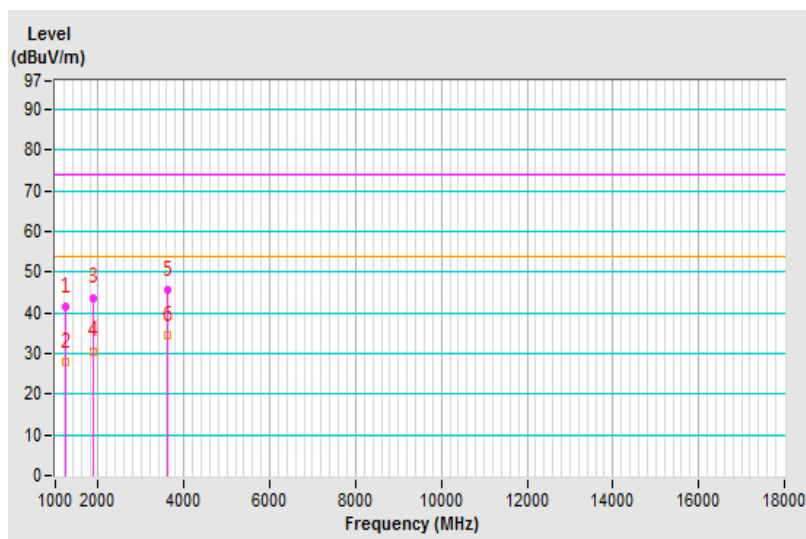

Frequency Range	18GHz ~ 40GHz	Detector Function & Resolution Bandwidth	Peak (PK) / Average (AV), 1MHz
Test Mode	Mode 3	Environmental Conditions	22°C, 63%RH
Tested by	Rolan Zheng	Test Date	2019/1/22

Antenna Polarity & Test Distance : Horizontal at 1.5 m								
No	Frequency (MHz)	Emission Level (dBuV/m)	Limit (dBuV/m)	Margin (dB)	Antenna Height (m)	Table Angle (Degree)	Raw Value (dBuV)	Correction Factor (dB/m)
1	18963.74	52.56 PK	80.00	-27.44	1.22 H	312	54.66	-2.10
2	18963.74	31.85 AV	60.00	-28.15	1.22 H	312	33.95	-2.10

Remarks:

1. Emission Level(dBuV/m) = Raw Value(dBuV) + Correction Factor(dB/m)
2. Correction Factor(dB/m) = Antenna Factor (dB/m) + Cable Factor (dB) – Pre-Amplifier Factor (dB)
3. The other emission levels were very low against the limit.
4. Margin value = Emission level – Limit value

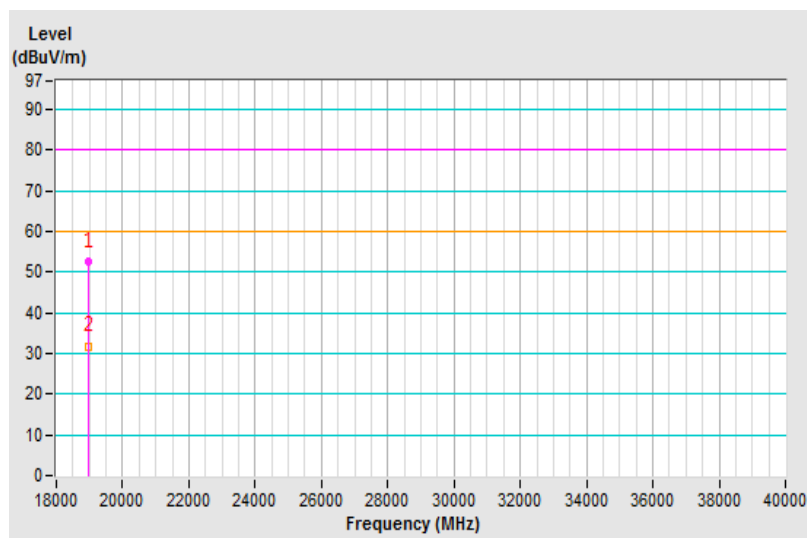

Frequency Range	18GHz ~ 40GHz	Detector Function & Resolution Bandwidth	Peak (PK) / Average (AV), 1MHz
Test Mode	Mode 3	Environmental Conditions	22°C, 63%RH
Tested by	Rolan Zheng	Test Date	2019/1/22

Antenna Polarity & Test Distance : Vertical at 1.5 m								
No	Frequency (MHz)	Emission Level (dBuV/m)	Limit (dBuV/m)	Margin (dB)	Antenna Height (m)	Table Angle (Degree)	Raw Value (dBuV)	Correction Factor (dB/m)
1	19023.52	53.24 PK	80.00	-26.76	1.00 V	271	55.44	-2.20
2	19023.52	32.88 AV	60.00	-27.12	1.00 V	271	35.08	-2.20

Remarks:

1. Emission Level(dBuV/m) = Raw Value(dBuV) + Correction Factor(dB/m)
2. Correction Factor(dB/m) = Antenna Factor (dB/m) + Cable Factor (dB) – Pre-Amplifier Factor (dB)
3. The other emission levels were very low against the limit.
4. Margin value = Emission level – Limit value

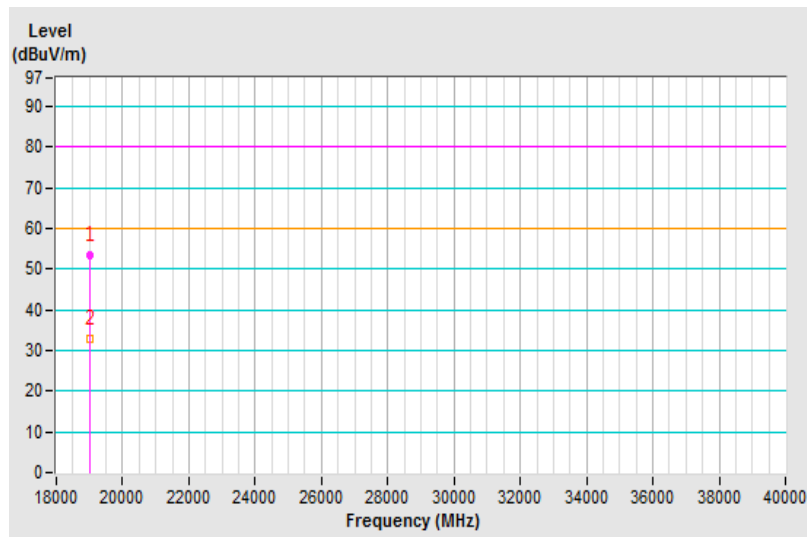

Frequency Range	1GHz ~ 18GHz	Detector Function & Resolution Bandwidth	Peak (PK) / Average (AV), 1MHz
Test Mode	Mode 10	Environmental Conditions	22°C, 62%RH
Tested by	Kai Chu	Test Date	2019/1/19

Antenna Polarity & Test Distance : Horizontal at 3 m								
No	Frequency (MHz)	Emission Level (dBuV/m)	Limit (dBuV/m)	Margin (dB)	Antenna Height (m)	Table Angle (Degree)	Raw Value (dBuV)	Correction Factor (dB/m)
1	1530.36	43.93 PK	74.00	-30.07	1.01 H	355	45.57	-1.64
2	1530.36	30.83 AV	54.00	-23.17	1.01 H	355	32.47	-1.64
3	3173.16	45.54 PK	74.00	-28.46	1.10 H	173	41.22	4.32
4	3173.16	28.64 AV	54.00	-25.36	1.10 H	173	24.32	4.32
5	3598.37	46.13 PK	74.00	-27.87	1.49 H	157	41.01	5.12
6	3598.37	33.43 AV	54.00	-20.57	1.49 H	157	28.31	5.12

Remarks:

1. Emission Level(dBuV/m) = Raw Value(dBuV) + Correction Factor(dB/m)
2. Correction Factor(dB/m) = Antenna Factor (dB/m) + Cable Factor (dB) – Pre-Amplifier Factor (dB)
3. The other emission levels were very low against the limit.
4. Margin value = Emission level – Limit value

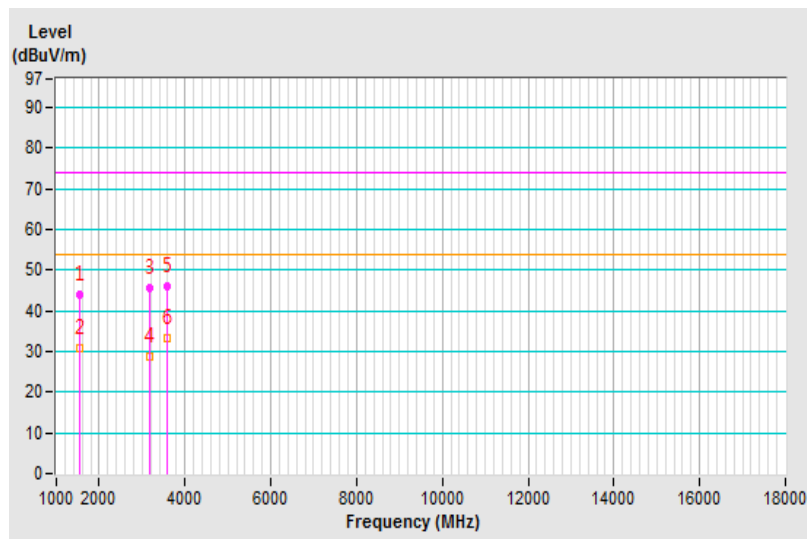



Frequency Range	1GHz ~ 18GHz	Detector Function & Resolution Bandwidth	Peak (PK) / Average (AV), 1MHz
Test Mode	Mode 10	Environmental Conditions	22°C, 62%RH
Tested by	Kai Chu	Test Date	2019/1/19

Antenna Polarity & Test Distance : Vertical at 3 m

No	Frequency (MHz)	Emission Level (dBuV/m)	Limit (dBuV/m)	Margin (dB)	Antenna Height (m)	Table Angle (Degree)	Raw Value (dBuV)	Correction Factor (dB/m)
1	1391.52	41.92 PK	74.00	-32.08	1.44 V	131	43.28	-1.36
2	1391.52	27.23 AV	54.00	-26.77	1.44 V	131	28.59	-1.36
3	2013.19	43.88 PK	74.00	-30.12	1.02 V	253	43.27	0.61
4	2013.19	28.45 AV	54.00	-25.55	1.02 V	253	27.84	0.61
5	3168.73	45.59 PK	74.00	-28.41	1.54 V	181	41.25	4.34
6	3168.73	32.20 AV	54.00	-21.80	1.54 V	181	27.86	4.34

Remarks:

1. Emission Level(dBuV/m) = Raw Value(dBuV) + Correction Factor(dB/m)
2. Correction Factor(dB/m) = Antenna Factor (dB/m) + Cable Factor (dB) – Pre-Amplifier Factor (dB)
3. The other emission levels were very low against the limit.
4. Margin value = Emission level – Limit value

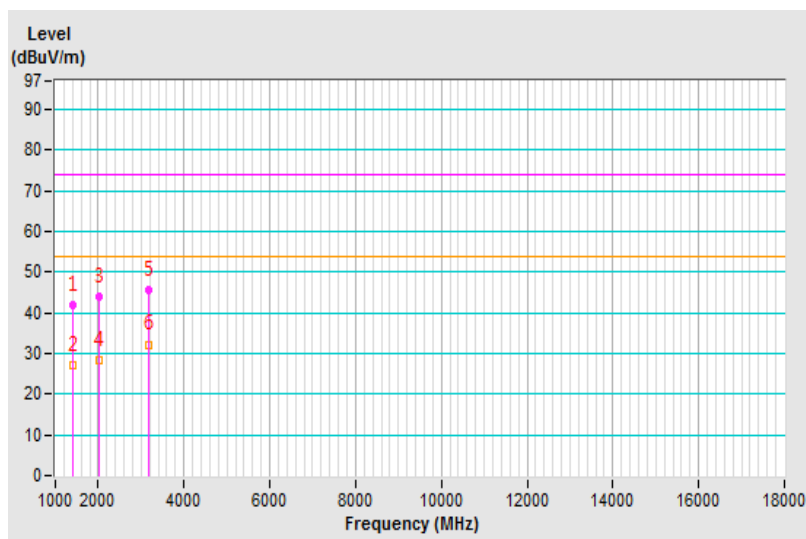

Frequency Range	18GHz ~ 40GHz	Detector Function & Resolution Bandwidth	Peak (PK) / Average (AV), 1MHz
Test Mode	Mode 10	Environmental Conditions	22°C, 62%RH
Tested by	Kai Chu	Test Date	2019/1/19

Antenna Polarity & Test Distance : Horizontal at 1.5 m								
No	Frequency (MHz)	Emission Level (dBuV/m)	Limit (dBuV/m)	Margin (dB)	Antenna Height (m)	Table Angle (Degree)	Raw Value (dBuV)	Correction Factor (dB/m)
1	19534.35	48.35 PK	80.00	-31.65	1.74 H	213	50.41	-2.06
2	19534.35	33.79 AV	60.00	-26.21	1.74 H	213	35.85	-2.06

Remarks:

1. Emission Level(dBuV/m) = Raw Value(dBuV) + Correction Factor(dB/m)
2. Correction Factor(dB/m) = Antenna Factor (dB/m) + Cable Factor (dB) – Pre-Amplifier Factor (dB)
3. The other emission levels were very low against the limit.
4. Margin value = Emission level – Limit value

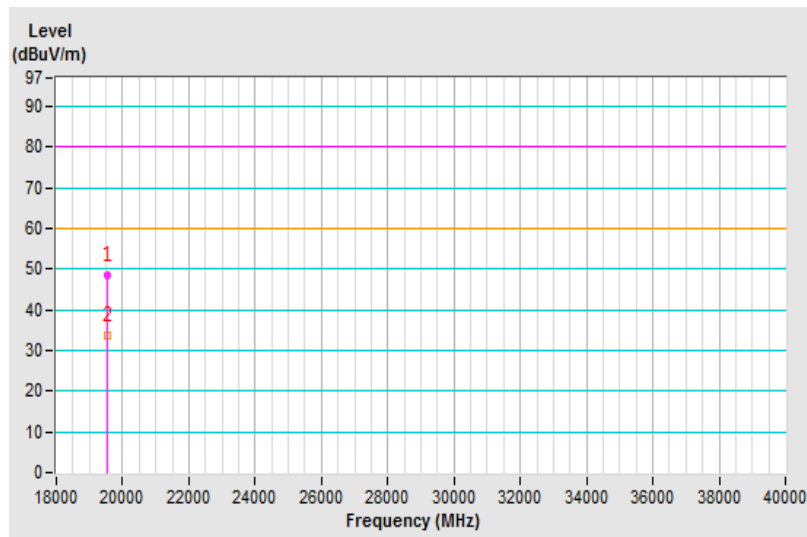

Frequency Range	18GHz ~ 40GHz	Detector Function & Resolution Bandwidth	Peak (PK) / Average (AV), 1MHz
Test Mode	Mode 10	Environmental Conditions	22°C, 62%RH
Tested by	Kai Chu	Test Date	2019/1/19

Antenna Polarity & Test Distance : Vertical at 1.5 m								
No	Frequency (MHz)	Emission Level (dBuV/m)	Limit (dBuV/m)	Margin (dB)	Antenna Height (m)	Table Angle (Degree)	Raw Value (dBuV)	Correction Factor (dB/m)
1	21337.26	50.39 PK	80.00	-29.61	1.21 V	152	50.38	0.01
2	21337.26	34.70 AV	60.00	-25.30	1.21 V	152	34.69	0.01

Remarks:

1. Emission Level(dBuV/m) = Raw Value(dBuV) + Correction Factor(dB/m)
2. Correction Factor(dB/m) = Antenna Factor (dB/m) + Cable Factor (dB) – Pre-Amplifier Factor (dB)
3. The other emission levels were very low against the limit.
4. Margin value = Emission level – Limit value

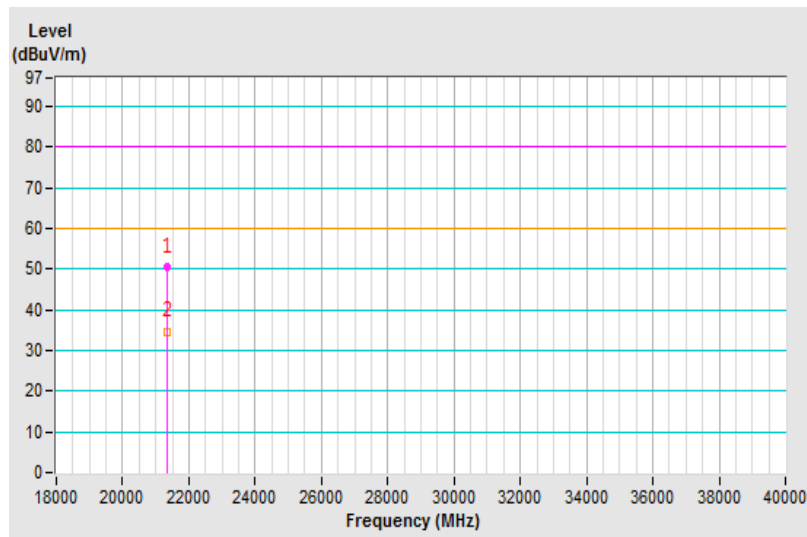

## Appendix – Information on the Testing Laboratories

We, Bureau Veritas Consumer Products Services (H.K.) Ltd., Taoyuan Branch, were founded in 1988 to provide our best service in EMC, Radio, Telecom and Safety consultation. Our laboratories are FCC recognized accredited test firms and accredited according to ISO/IEC 17025.

If you have any comments, please feel free to contact us at the following:

**Linko EMC/RF Lab**

Tel: 886-2-26052180

Fax: 886-2-26051924

**Hsin Chu EMC/RF/Telecom Lab**

Tel: 886-3-6668565

Fax: 886-3-6668323

**Hwa Ya EMC/RF/Safety Lab**

Tel: 886-3-3183232

Fax: 886-3-3270892

**Email:** [service.adt@tw.bureauveritas.com](mailto:service.adt@tw.bureauveritas.com)

**Web Site:** [www.bureauveritas-adt.com](http://www.bureauveritas-adt.com)

The address and road map of all our labs can be found in our web site also.

--- END ---