





PHILIPS

<p>Philips Electronics Industries (Taiwan) Ltd - EMC Lab. 5, Tze Chiang 1 Road, Chungli Industrial Park, Chungli, Taoyuan, Taiwan Tel.: +886-3-454-9862 Fax.: +886-3-454-9887 E-mail: ronnie.yang@philips.com</p>	<h2>FCC Test Report</h2>	<p>Report No.: TYR87-2043</p> <p>Date : 14 March, 2003</p> <p>Page : Page 1 of 32</p>
<p>Customer : Philips Electronics Industries</p> <p>Name : Mr. S.T. Huang – EE LCD Address : 5, Tze Chiang 1 Road, Zip/City : Chungli Industrial Park, Country : Chungli, Taiwan, R.O.C.</p>		
<p>Equipment Under Test (including peripherals) :</p> <p>FCC ID. : A3KM117 Model Name : B15-1 Serial Number : TY03020104 Description : 15" XGA LCD color monitor, Max. resolution 1024x768/75Hz</p>		
<p>EMC Standards : FCC Part 15 of October 01,1999 Class B ANSI C63.4-1992</p> <p>Result : PASSED the limits/test-levels in the standards.</p> <p>Note : The results in this report apply only to the sample(s) and mode(s) tested. It is the manufacturer's responsibility to assume the continued EMC compliance of production models.</p>		
<p>Date of receipt of EUT : 07 Mar. 2003</p> <p>Date of performance of test : 08 Mar., 2003 to 12 Mar., 2003</p>		
<p> C.C. Wu - EMC Test Engineer</p>		<p> Ronnie Yang - EMC Manager NVLAP Signatory</p>

Philips Electronics Industries (Taiwan) Ltd

This report shall not be reproduce except in full, without written approval of the testing laboratory

Table of contents

1. Summary of test results.....	3
2. General information of EUT.....	4
3. Test equipment.....	5
4. Test configuration of EUT and peripherals.....	6
5. Test procedure.....	7
6. Measurement uncertainty.....	9
7. Conducted emissions test.....	10
8. Radiated emissions test.....	19
9. Photographs of test set-up.....	28
10. References.....	32

1. Summary of test results

Test	Standard	Result	Note
Emission, ANSI C63.4-1992			
Conducted emission	FCC Part 15	Passed	
Radiated emission	FCC Part 15	Passed	

Remark:

The test sample fully complies with the requirements set forth in : FCC Part 15 Class B.

2. General Information of EUT

The EUT, 15" color monitor :

Model No. : B15-1
 FCC ID : A3KM117
 Brand : Fujitsu Siemens

The color monitor automatically scans horizontal frequencies between 31KHz and 61KHz , and vertical frequencies between 56Hz and 76Hz. This color monitor displays sharp and brilliant images of text and graphics with a maximum resolution up to 1024x768 pixels.

The monitor has 7 factory-preset modes as indicated in the following table:

Mode	Resolution	H. freq. / V. freq	Standard
1.	720 x 400	31.469Khz/70.087Hz	VGA
2.	640 x 480	31.469Khz/59.940Hz	VGA
3.	640 x 480	37.500Khz/75.000Hz	VESA
4.	800 x 600	37.879Khz/60.317Hz	VESA
5.	800 x 600	46.875Khz/75.000Hz	VESA
6.	1024 x 768	48.363Khz/60.004Hz	VESA
7.	1024 x 768	60.023Khz/75.029Hz	VESA

3. Test Equipment

Test equipment used for line Conducted and Radiated emissions as following.

All equipment were calibrated according to ANSI C63.4-1992 and ISO-9000 requirement unless otherwise specified.

Traceability to R.O.C. and international standards is assured by using calibrated all equipment.

- For Conducted Emissions Test:

Test Equipment	Model No.	Serial No.	Last Calibrate	Next Calibrate
Spectrum	HP8568B	2928A04640	06/27/2002	06/27/2003
EMI Receiver	R & S ESVS30	841977/006	06/13/2002	06/13/2003
LISN	EMCO 3825/2	9311-2153	06/13/2002	06/13/2003
LISN	EMCO 3825/2	9311-2154	06/13/2002	06/13/2003
RF Cable	8-meter	N/A	05/29-2002	05/29/2003

- For Radiated Emissions Test:

Test Equipment	Model No.	Serial No.	Last Calibrate	Next Calibrate
Spectrum	HP8568B	2928A04640	06/27/2002	06/27/2003
RF Preselector	HP85685A	2620A00338	06/27/2002	06/27/2003
QP Adapter	HP85650A	2811A01324	06/27/2002	06/27/2003
EMI Receiver	R & S ESVS30	841977/006	06/13/2002	06/13/2003
Biconical Antenna	EMCO 3110B	3222	06/04/2002	06/04/2003
Biconical Antenna	EMCO 3110B	3224	06/04/2002	06/04/2003
Log-Periodic Antenna	EMCO 3146A	1424	06/04/2002	06/04/2003
Log-Periodic Antenna	EMCO 3146A	1425	06/04/2002	06/04/2003
Turn Table	EMCO 1060	1068	05/27/2002	05/27/2003
Antenna Tower	EMCO 1050	1113	05/27/2002	05/27/2003
RF Cable	M17/75-RG214-NE	N/A	05/27/2002	05/27/2003

4. Test Configuration of EUT and Peripherals

The system was configured for testing in a typical fashion (as a customer would normally use it) according to ANSI C63.4-1992, please see the photographs for detail. For system measurement, the EUT "B15-1" were connected to:

	Description	Brand/ Model No.	Serial No.	FCC ID	Remark
A	Monitor	Fujitsu Siemens B15-1	TY03020104	A3KM117	EUT
B	PC	Fujitsu Siemens MT8-D137	YBSX459065	FCC logo	
C	Keyboard	Fujitsu Siemens S26381-K240-V110	YBKBO21111264507	HSS011A5TK240	
D	Mouse	Fujitsu Siemens M-S69	HCA23608284	JNZ211443	
E	Modem	Hayes 231AA	A22231081770	BFJ9D9308US	
F	Printer	HP 2225C	2934S55406	DSI6XU2225	

Connected Cables

No.	Description	Manufacturer	Length	Shielded	Remark
1	Power Cord	Long Shine	1.8 meters	No	for EUT
2	Power Cord	Acer	1.8 meters	No	for PC
3	Power Cord	Aceex	2.0 meters	No	for Modem
4	Power Cord	HP	1.8 meters	No	for Printer
5	Video Cable	Long Shine	1.5 meters	Yes	
6	Printer Cable	HP	1.8 meters	Yes	
7	Modem Cable	Aceex	1.5 meters	Yes	

System Block Diagram of Test Configuration

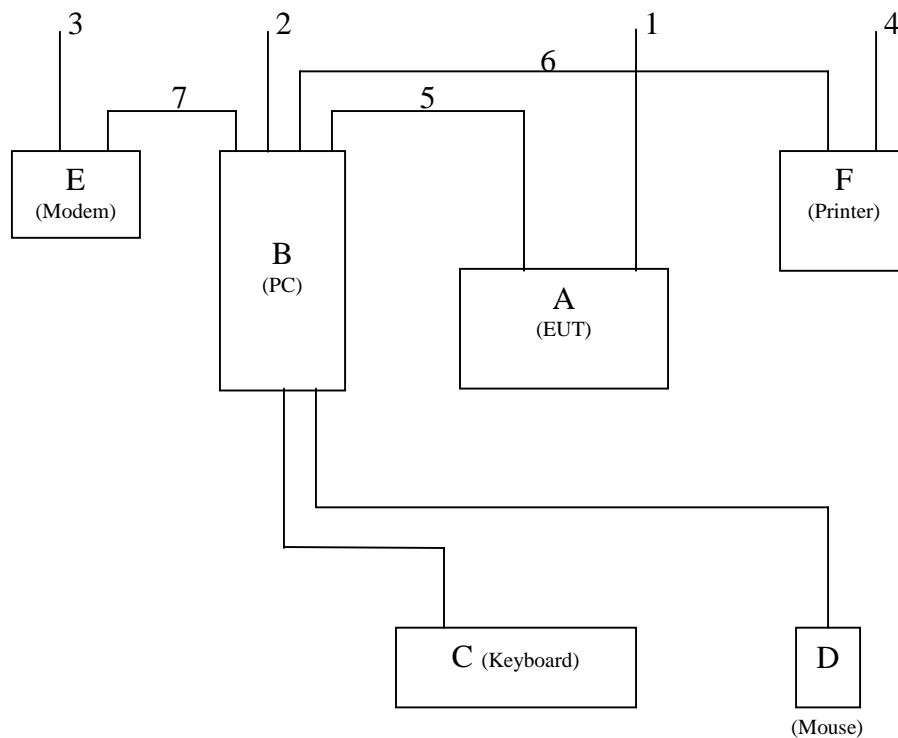

5. Test Procedure

Test was performed by:

PHILIPS ELECTRONICS INDUSTRIES (TAIWAN) LTD.
CONSUMER ELECTRONICS DIVISION
- EMC LAB

5, Tze Chiang 1 Road, Chungli Industrial Park
P.O. Box 123, Chungli, Taoyuan, Taiwan
Tel : 886-3-4549862 Fax : 886-3-4549887
Internet: ronnie.yang@philips.com

The test was performed in accordance with ANSI C63.4-1992, "AMERICAN NATIONAL STANDARD FOR MEASUREMENT OF RADIO-NOISE EMISSION FROM LOW-VOLTAGE ELECTRICAL AND ELECTRONIC EQUIPMENT IN THE RANGE OF 9KHz TO 40GHz"

Both conducted and radiated testing were performed according to the procedure in ANSI C63.4-1992. Conducted testing was performed in screen room and radiated testing was performed in open site at an antenna to EUT distance of 3-meter on horizontal and vertical polarization.

First, pre-scan all modes in screen room then select **2 higher modes** (worst case) were tested and reported.

The line conductive interference was tested with 110VAC and 220VAC receptively.

Unshielded power cord was used during test.
D-sub I/F cable with two ferrite cores was used.
Audio cable with one ferrite cores was used.

Tested and reported modes as following:

Test Item	File No.	Resolution	Frequencies	I/F Cable
Conducted	EMI03-012-C	1024x768	60KHz/75Hz	D-sub
		800x600	46.9KHz/75Hz	D-sub
Radiated	EMI03-012-R	1024x768	60KHz/75Hz	D-sub
		800x600	46.9KHz/75Hz	D-sub

Set up the EUT and all peripherals as chapter 6 of ANSI C63.4-1992 for AC power line conducted emissions testing and radiated emissions testing.

Turn on the power of EUT and all peripherals, select an appropriate displaying mode using the "setup" software. Then run an EMI test program "HTEST.EMI" as a basic software to execute the EUT operating under test. A pattern of scrolling H's should be displayed on the monitor.

- Step 1 : Run the "HTEST.EMI" on personal computer then sends "H" character to monitor continuously until full screen.
- Step 2 : Personal computer sends a complete line of continuously repeating "H" to HP 2225C printer.
- Step 3 : Personal computer sends a file of "H" pattern to floppy disk then read a file of "H" pattern from floppy disk.
- Step 4 : Personal computer sends a file of "H" pattern to hard disk then read a file of "H" pattern from hard disk.
- Step 5 : Personal computer sends a file of "H" patter to USRobotics 268 modem.
- Step 6 : Return to step 1

All data in this report are "PEAK" value within 15dB margin unless otherwise noted.

6. Measurement Uncertainty

The system uncertainty listed below are based on the instrument absolute specifications, and do not include uncertainties of the equipment under test.

Uncertainty for Radiated Emissions Test at 3 meters Test Site.

Source of Measurement Uncertainty	Uncertainty/dB
Antenna factor calibration	+/-2.0
Cable loss calibration	+/-0.5
Receiver specification	+/-1.0
Antenna position ver.	+/-2.0
Measurement distance ver.	+/-0.5
Site imperfections	+/-2.0
Mismatch	+/-1.1
System repeatability	+/-0.5

Uncertainty for Conducted Emissions Test at 3 meters Test Site.

Source of Measurement Uncertainty	Uncertainty/dB
LISN specification	+/-2.0
Cable loss calibration	+/-0.5
Receiver specification	+/-1.0
Pulse limiter Spec.	+/-0.3
Measurement distance ver.	+/-0.5
Site imperfections	+/-2.0
System repeatability	+/-0.5

7. Conducted Emissions Test

Conducted Emissions		
FCC Part 15		
Operating conditions EUT:		
EUT powered on with scrolling "H" pattern.		
Limits:		
Frequency range (MHz)	Class A (dBuv) QP	Class B (dBuv) QP
0.45 – 1.705	60.0	48.0
1.705 – 30.0	69.5	48.0
Test Result :		
Passed FCC Class B Limits		
Option:		
The following option may be employed if the conducted emissions exceed the limits, as appropriate, when measured using instrumentation employing a quasi-peak detector function: If the level of the emission measured using the quasi-peak instrumentation is 6dB, or, more higher than the level of the same emission measured with instrumentation having an average detector and a 9KHz minimum bandwidth, that emission is considered broadband and the level obtained with the quasi-peak detector may be reduced by 13dB for comparison to the limits.		
Remark:		
Date of Test	: 08 Mar., 2003 to 12 Mar., 2003	
Test Engineer	: C.C.Wu	
For detail measurement results see next pages.		



PHILIPS

Philips Electronics Industries (Taiwan) ., Ltd.
 No.5, Tze Chiang 1 Road, Chungli Industrial Park,
 Chungli, Taiwan, R.O.C.
 Tel:+886-3-4549862 Fax:+886-3-4549887

Data#: 1

File#: C:\Program Files\em3\EMI03-012-C(FSC B15-1).emi

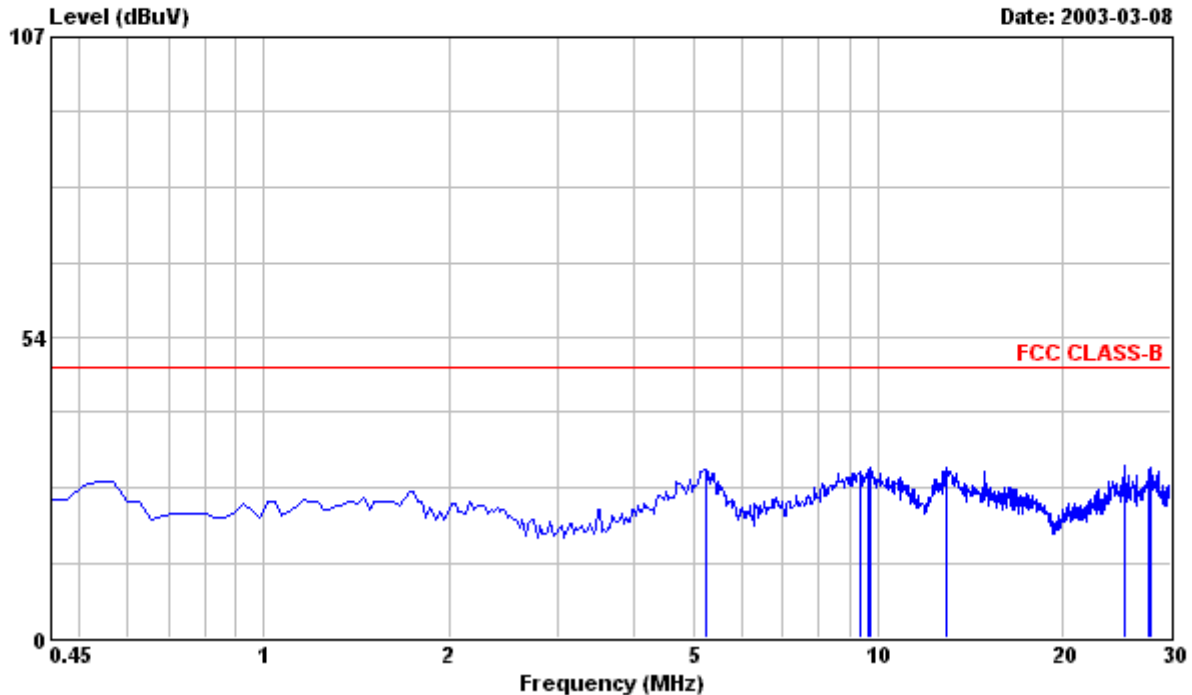

Site : PHILIPS EMI Shielding Room
 Condition : FCC CLASS-B FCC_LCI_L1 LINE
 EUT : FSC B15-1 Serial No:TY03020104
 Power : 120VAC
 Memo : 1. EMI EVALUATION FOR FCC SAMPLE.
 : 2. 2ND MODEL CPT PANEL,RUN FSC "H"
 : PATTERN.
 : 3. 1024x768/75Hz 60KHz MODE WITH FSC
 : MT8-D137 PC,VIDEO CARD ONBOARD,
 : AUDIO WITH HEADPHONE WAS TESTED.

Frequency	Peak Reading	QP Reading	Limit	Factor	Emission Level	Over Limit	Remark
					LINE		
5.237	29.79	---	48.00	0.33	30.12	-17.88	Peak
9.374	29.20	---	48.00	0.54	29.74	-18.26	Peak
9.670	29.50	---	48.00	0.57	30.07	-17.93	Peak
9.729	29.90	---	48.00	0.58	30.48	-17.52	Peak
12.979	29.60	---	48.00	0.66	30.26	-17.74	Peak
25.154	29.60	---	48.00	0.90	30.50	-17.50	Peak
27.547	29.10	---	48.00	0.85	29.95	-18.05	Peak
27.902	29.40	---	48.00	0.84	30.24	-17.76	Peak

Remarks: 1. All Readings are Peak & Quasi-Peak Values.
 2. Emission Level (dBuV) = Factor (dB) + Meter Reading (dBuV)
 3. Factor (dB/m) = LISN Loss (dB) + Cable Loss (dB)

Tested by : C.C.Wu



PHILIPS

Philips Electronics Industries (Taiwan)., Ltd.
 No.5, Tze Chiang 1 Road, Chungli Industrial Park,
 Chungli, Taiwan, R.O.C.
 Tel:+886-3-4549862 Fax:+886-3-4549887

Data#: 2

File#: C:\Program Files\em3\EMI03-012-C(FSC B15-1).emi

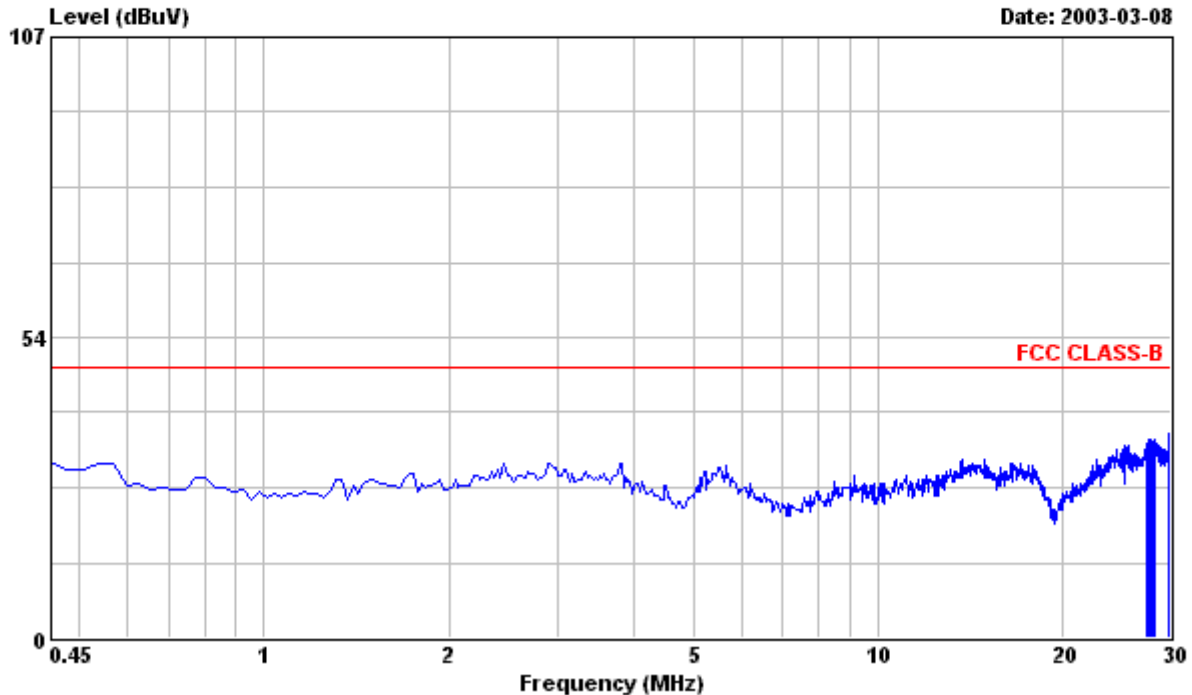

Site : PHILIPS EMI Shielding Room
 Condition : FCC CLASS-B FCC_LCI_L2 NEUTRAL
 EUT : FSC B15-1 Serial No:TY03020104
 Power : 120VAC
 Memo : 1. EMI EVALUATION FOR FCC SAMPLE.
 : 2. 2ND MODEL CPT PANEL,RUN FSC "H"
 : PATTERN.
 : 3. 1024x768/75Hz 60KHz MODE WITH FSC
 : MT8-D137 PC,VIDEO CARD ONBOARD,
 : AUDIO WITH HEADPHONE WAS TESTED.

Frequency	Peak Reading	QP Reading	Limit	Factor	Emission Level	Over Limit	Remark
NEUTRAL							
27.400	33.60	---	48.00	0.95	34.55	-13.45	Peak
27.518	34.20	---	48.00	0.95	35.15	-12.85	Peak
27.695	33.70	---	48.00	0.94	34.64	-13.36	Peak
27.813	34.20	---	48.00	0.94	35.14	-12.86	Peak
28.020	34.10	---	48.00	0.94	35.04	-12.96	Peak
28.109	33.70	---	48.00	0.94	34.64	-13.36	Peak
28.227	34.30	---	48.00	0.93	35.23	-12.77	Peak
29.764	35.30	---	48.00	0.90	36.20	-11.80	Peak

Remarks: 1. All Readings are Peak & Quasi-Peak Values.
 2. Emission Level (dBuV) = Factor (dB) + Meter Reading (dBuV)
 3. Factor (dB/m) = LISN Loss (dB) + Cable Loss (dB)

Tested by : C.C.Wu



PHILIPS

Philips Electronics Industries (Taiwan) ., Ltd.
 No.5, Tze Chiang 1 Road, Chungli Industrial Park,
 Chungli, Taiwan, R.O.C.
 Tel:+886-3-4549862 Fax:+886-3-4549887

Data#: 3

File#: C:\Program Files\e3\EMI03-012-C(FSC B15-1).emi

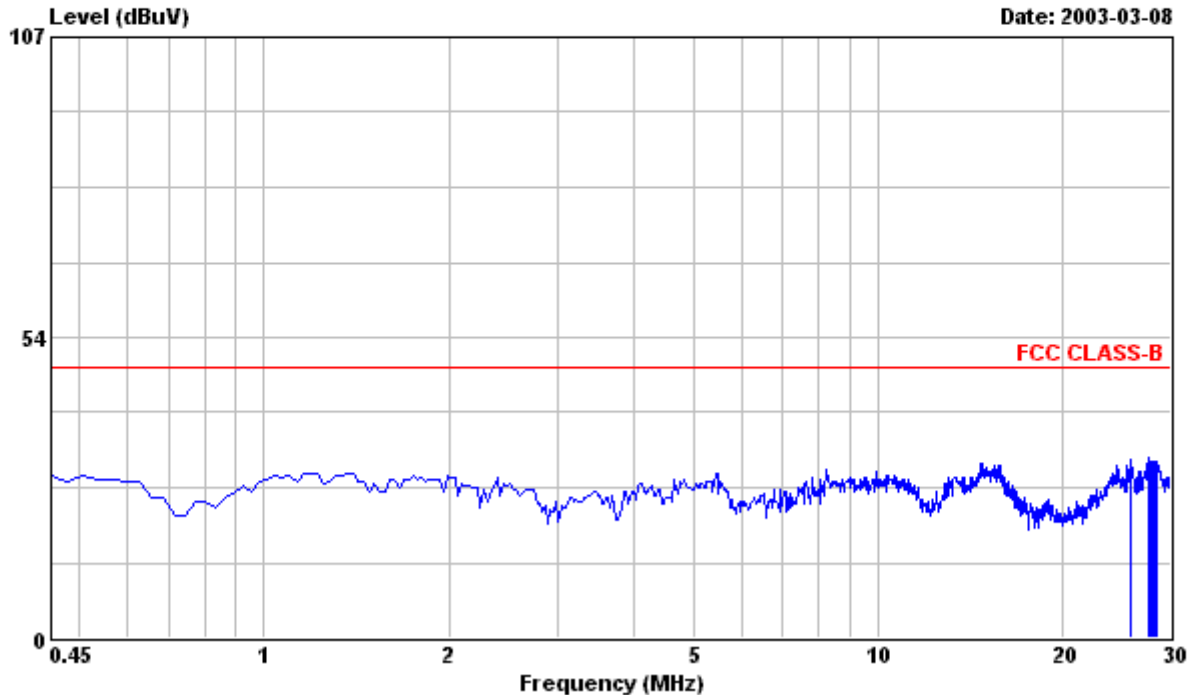

Site : PHILIPS EMI Shielding Room
 Condition : FCC CLASS-B FCC_LCI_L1 LINE
 EUT : FSC B15-1 Serial No:TY03020104
 Power : 220VAC
 Memo : 1. EMI EVALUATION FOR FCC SAMPLE.
 : 2. 2ND MODEL CPT PANEL,RUN FSC "H"
 : PATTERN.
 : 3. 1024x768/75Hz 60KHz MODE WITH FSC
 : MT8-D137 PC,VIDEO CARD ONBOARD,
 : AUDIO WITH HEADPHONE WAS TESTED.

Frequency	Peak Reading	QP Reading	Limit	Factor	Emission Level	Over Limit	Remark
					LINE		
25.833	31.00	---	48.00	0.88	31.88	-16.12	Peak
27.636	30.79	---	48.00	0.85	31.64	-16.36	Peak
27.695	31.30	---	48.00	0.84	32.14	-15.86	Peak
27.932	30.50	---	48.00	0.84	31.34	-16.66	Peak
27.991	30.40	---	48.00	0.84	31.24	-16.76	Peak
28.227	30.40	---	48.00	0.83	31.23	-16.77	Peak
28.286	30.50	---	48.00	0.83	31.33	-16.67	Peak
28.463	30.50	---	48.00	0.83	31.33	-16.67	Peak

Remarks: 1. All Readings are Peak & Quasi-Peak Values.
 2. Emission Level (dBuV) = Factor (dB) + Meter Reading (dBuV)
 3. Factor (dB/m) = LISN Loss (dB) + Cable Loss (dB)

Tested by : C.C.Wu



PHILIPS

Philips Electronics Industries (Taiwan)., Ltd.
 No.5, Tze Chiang 1 Road, Chungli Industrial Park,
 Chungli, Taiwan, R.O.C.
 Tel:+886-3-4549862 Fax:+886-3-4549887

Data#: 4

File#: C:\Program Files\em3\EMI03-012-C(FSC B15-1).emi

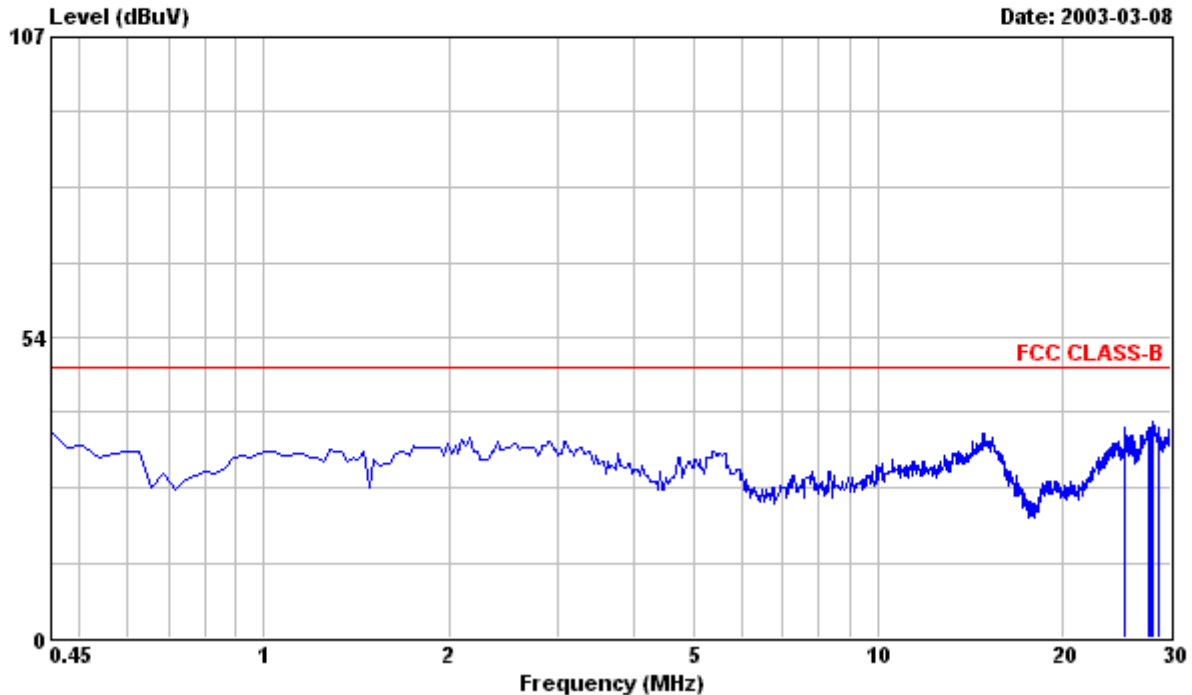

Site : PHILIPS EMI Shielding Room
 Condition : FCC CLASS-B FCC_LCI_L2 NEUTRAL
 EUT : FSC B15-1 Serial No:TY03020104
 Power : 220VAC
 Memo : 1. EMI EVALUATION FOR FCC SAMPLE.
 : 2. 2ND MODEL CPT PANEL,RUN FSC "H"
 : PATTERN.
 : 3. 1024x768/75Hz 60KHz MODE WITH FSC
 : MT8-D137 PC,VIDEO CARD ONBOARD,
 : AUDIO WITH HEADPHONE WAS TESTED.

Frequency	Peak Reading	QP Reading	Limit	Factor	Emission Level	Over Limit	Remark
NEUTRAL							
25.272	36.59	---	48.00	1.00	37.59	-10.41	Peak
27.606	36.50	---	48.00	0.95	37.45	-10.55	Peak
27.695	36.40	---	48.00	0.94	37.34	-10.66	Peak
27.754	36.40	---	48.00	0.94	37.34	-10.66	Peak
28.020	37.50	---	48.00	0.94	38.44	-9.56	Peak
28.138	36.80	---	48.00	0.93	37.73	-10.27	Peak
28.582	36.50	---	48.00	0.93	37.43	-10.57	Peak
28.729	36.10	---	48.00	0.92	37.02	-10.98	Peak

Remarks: 1. All Readings are Peak & Quasi-Peak Values.
 2. Emission Level (dBuV) = Factor (dB) + Meter Reading (dBuV)
 3. Factor (dB/m) = LISN Loss (dB) + Cable Loss (dB)

Tested by : C.C.Wu



PHILIPS

Philips Electronics Industries (Taiwan) ., Ltd.
 No.5, Tze Chiang 1 Road, Chungli Industrial Park,
 Chungli, Taiwan, R.O.C.
 Tel:+886-3-4549862 Fax:+886-3-4549887

Data#: 5

File#: C:\Program Files\em3\EMI03-012-C(FSC B15-1).emi

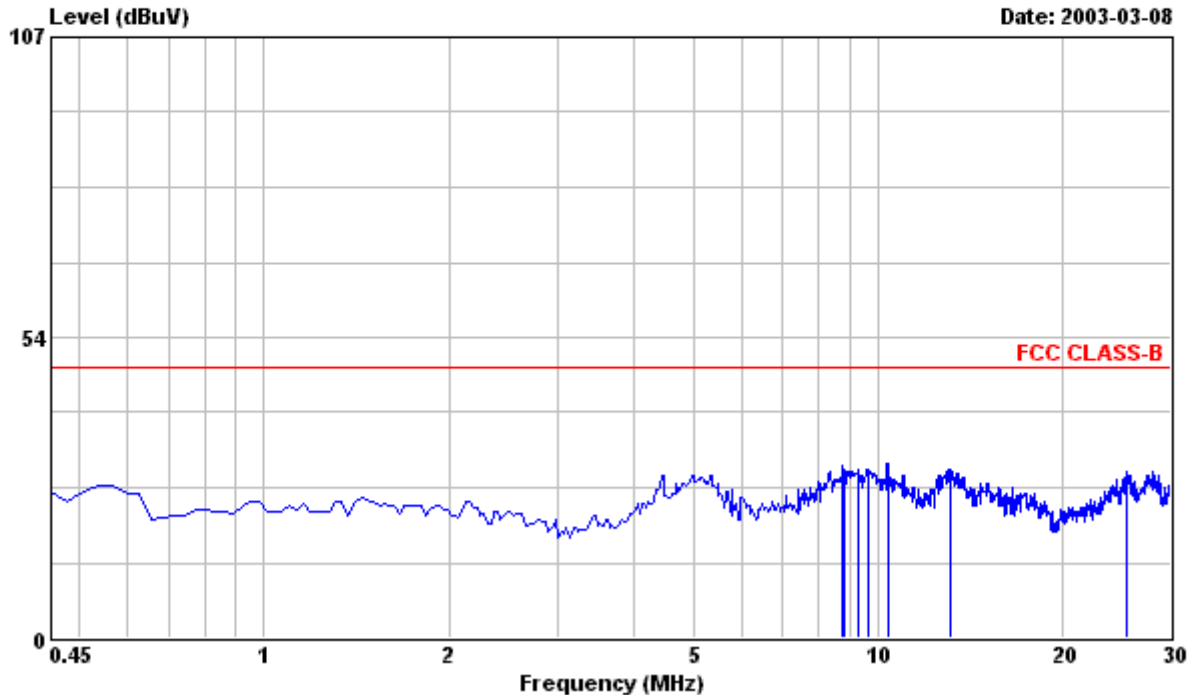

Site : PHILIPS EMI Shielding Room
 Condition : FCC CLASS-B FCC_LCI_L1 LINE
 EUT : FSC B15-1 Serial No:TY03020104
 Power : 120VAC
 Memo : 1. EMI EVALUATION FOR FCC SAMPLE.
 : 2. 2ND MODEL CPT PANEL,RUN FSC "H"
 : PATTERN.
 : 3. 800x600/75Hz 46.9KHz MODE WITH FSC
 : MT8-D137 PC,VIDEO CARD ONBOARD,
 : AUDIO WITH HEADPHONE WAS TESTED.

Frequency	Peak Reading	QP Reading	Limit	Factor	Emission Level	Over Limit	Remark
					LINE		
8.783	30.30	---	48.00	0.48	30.78	-17.22	Peak
8.842	29.50	---	48.00	0.49	29.99	-18.01	Peak
9.315	29.50	---	48.00	0.54	30.04	-17.96	Peak
9.670	29.40	---	48.00	0.57	29.97	-18.03	Peak
10.379	30.40	---	48.00	0.61	31.01	-16.99	Peak
10.438	29.30	---	48.00	0.61	29.91	-18.09	Peak
13.097	29.40	---	48.00	0.67	30.07	-17.93	Peak
25.449	28.80	---	48.00	0.89	29.69	-18.31	Peak

Remarks: 1. All Readings are Peak & Quasi-Peak Values.
 2. Emission Level (dBuV) = Factor (dB) + Meter Reading (dBuV)
 3. Factor (dB/m) = LISN Loss (dB) + Cable Loss (dB)

Tested by : C.C.Wu



PHILIPS

Philips Electronics Industries (Taiwan)., Ltd.
 No.5, Tze Chiang 1 Road, Chungli Industrial Park,
 Chungli, Taiwan, R.O.C.
 Tel:+886-3-4549862 Fax:+886-3-4549887

Data#: 6

File#: C:\Program Files\em3\EMI03-012-C(FSC B15-1).emi

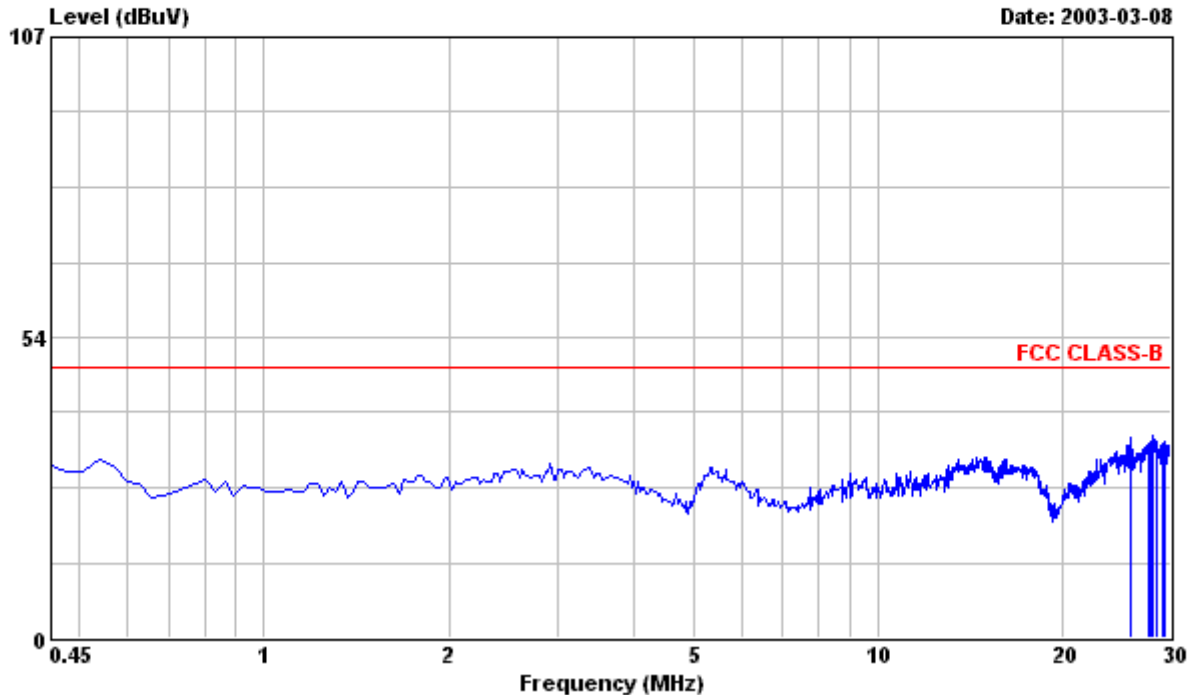

Site : PHILIPS EMI Shielding Room
 Condition : FCC CLASS-B FCC_LCI_L2 NEUTRAL
 EUT : FSC B15-1 Serial No:TY03020104
 Power : 120VAC
 Memo : 1. EMI EVALUATION FOR FCC SAMPLE.
 : 2. 2ND MODEL CPT PANEL,RUN FSC "H"
 : PATTERN.
 : 3. 800x600/75Hz 46.9KHz MODE WITH FSC
 : MT8-D137 PC,VIDEO CARD ONBOARD,
 : AUDIO WITH HEADPHONE WAS TESTED.

Frequency	Peak Reading	QP Reading	Limit	Factor	Emission Level	Over Limit	Remark
NEUTRAL							
25.745	34.80	---	48.00	0.98	35.78	-12.22	Peak
27.606	33.60	---	48.00	0.95	34.55	-13.45	Peak
27.754	34.10	---	48.00	0.94	35.04	-12.96	Peak
27.872	33.60	---	48.00	0.94	34.54	-13.46	Peak
28.079	35.10	---	48.00	0.94	36.04	-11.96	Peak
28.404	34.10	---	48.00	0.93	35.03	-12.97	Peak
29.084	33.80	---	48.00	0.92	34.72	-13.28	Peak
29.409	34.00	---	48.00	0.91	34.91	-13.09	Peak

Remarks: 1. All Readings are Peak & Quasi-Peak Values.
 2. Emission Level (dBuV) = Factor (dB) + Meter Reading (dBuV)
 3. Factor (dB/m) = LISN Loss (dB) + Cable Loss (dB)

Tested by : C.C.Wu



PHILIPS

Philips Electronics Industries (Taiwan)., Ltd.
 No.5, Tze Chiang 1 Road, Chungli Industrial Park,
 Chungli, Taiwan, R.O.C.
 Tel:+886-3-4549862 Fax:+886-3-4549887

Data#: 7

File#: C:\Program Files\em3\EMI03-012-C(FSC B15-1).emi

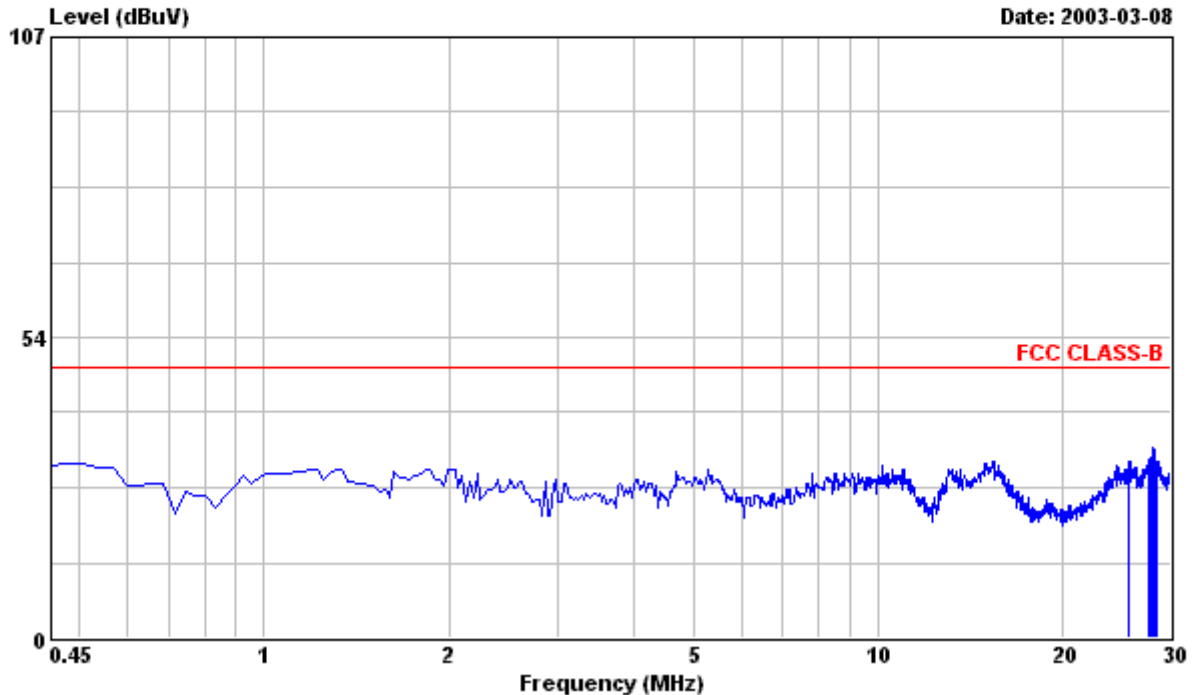

Site : PHILIPS EMI Shielding Room
 Condition : FCC CLASS-B FCC_LCI_L1 LINE
 EUT : FSC B15-1 Serial No:TY03020104
 Power : 220VAC
 Memo : 1. EMI EVALUATION FOR FCC SAMPLE.
 : 2. 2ND MODEL CPT PANEL,RUN FSC "H"
 : PATTERN.
 : 3. 800x600/75Hz 46.9KHz MODE WITH FSC
 : MT8-D137 PC,VIDEO CARD ONBOARD,
 : AUDIO WITH HEADPHONE WAS TESTED.

Frequency	Peak Reading	QP Reading	Limit	Factor	Emission Level	Over Limit	Remark
25.715	30.49	---	48.00	0.89	31.38	-16.62	Peak
27.577	31.00	---	48.00	0.85	31.85	-16.15	Peak
27.754	31.00	---	48.00	0.84	31.84	-16.16	Peak
27.813	31.30	---	48.00	0.84	32.14	-15.86	Peak
27.961	32.90	---	48.00	0.84	33.74	-14.26	Peak
28.050	31.20	---	48.00	0.84	32.04	-15.96	Peak
28.168	32.70	---	48.00	0.83	33.53	-14.47	Peak
28.375	30.50	---	48.00	0.83	31.33	-16.67	Peak

Remarks: 1. All Readings are Peak & Quasi-Peak Values.
 2. Emission Level (dBuV) = Factor (dB) + Meter Reading (dBuV)
 3. Factor (dB/m) = LISN Loss (dB) + Cable Loss (dB)

Tested by : C.C.Wu



PHILIPS

Philips Electronics Industries (Taiwan)., Ltd.
 No.5, Tze Chiang 1 Road, Chungli Industrial Park,
 Chungli, Taiwan, R.O.C.
 Tel:+886-3-4549862 Fax:+886-3-4549887

Data#: 8

File#: C:\Program Files\em3\EMI03-012-C(FSC B15-1).emi

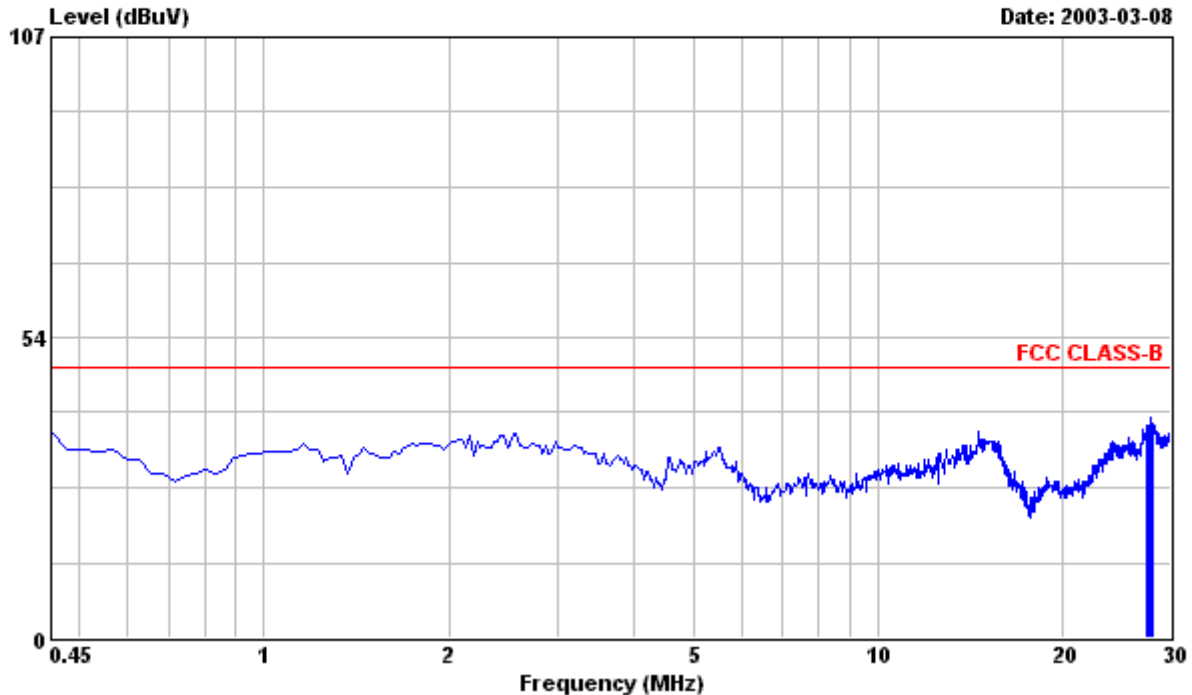

Site : PHILIPS EMI Shielding Room
 Condition : FCC CLASS-B FCC_LCI_L2 NEUTRAL
 EUT : FSC B15-1 Serial No:TY03020104
 Power : 220VAC
 Memo : 1. EMI EVALUATION FOR FCC SAMPLE.
 : 2. 2ND MODEL CPT PANEL,RUN FSC "H"
 : PATTERN.
 : 3. 800x600/75Hz 46.9KHz MODE WITH FSC
 : MT8-D137 PC,VIDEO CARD ONBOARD,
 : AUDIO WITH HEADPHONE WAS TESTED.

Frequency	Peak Reading	QP Reading	Limit	Factor	Emission Level	Over Limit	Remark
NEUTRAL							
27.429	36.90	---	48.00	0.95	37.85	-10.15	Peak
27.636	36.89	---	48.00	0.95	37.84	-10.16	Peak
27.784	36.90	---	48.00	0.94	37.84	-10.16	Peak
27.843	37.00	---	48.00	0.94	37.94	-10.06	Peak
27.932	38.30	---	48.00	0.94	39.24	-8.76	Peak
27.991	36.50	---	48.00	0.94	37.44	-10.56	Peak
28.050	36.50	---	48.00	0.94	37.44	-10.56	Peak
28.138	37.00	---	48.00	0.93	37.93	-10.07	Peak

Remarks: 1. All Readings are Peak & Quasi-Peak Values.
 2. Emission Level (dBuV) = Factor (dB) + Meter Reading (dBuV)
 3. Factor (dB/m) = LISN Loss (dB) + Cable Loss (dB)

Tested by : C.C.Wu

8. Radiated Emission Test

Radiated Emissions		
FCC Part 15		
Operating conditions EUT:		
EUT powered on with scrolling "H" pattern.		
Limits:		
Frequency range (MHz)	Class A at 10m (dBuv) QP	Class B at 3m (dBuv) QP
30.0 – 88.0	39.0	40.0
88.0 – 216.0	43.5	43.5
216.0 – 960.0	46.5	46.0
960.0 – 1000.0	49.5	54.0
Above 1000.0	49.5	54.0 Average
Test Result :		
Passed FCC Class B Limits		
Remark:		
Date of Test	: 08 Mar., 2003 to 12 Mar., 2003	
Test Engineer	: C.C.Wu	
For detail measurement results see next pages.		



PHILIPS

Philips Electronics Industries (Taiwan)., Ltd.
 No.5, Tze Chiang 1 Road, Chungli Industrial Park,
 Chungli, Taiwan, R.O.C.
 Tel:+886-3-4549862 Fax:+886-3-4549887

Data#: 1 File#: C:\Program Files\em3\EMI03-012-R.emi

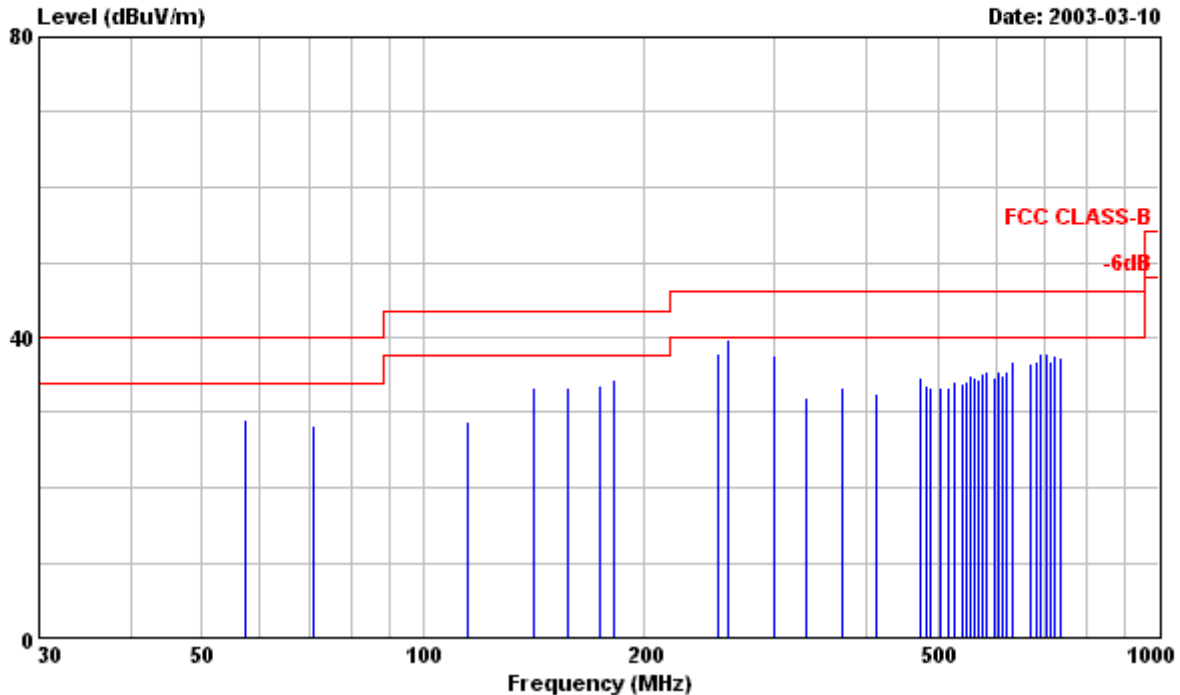

Site : PHILIPS EMI 3M open site
 Condition : FCC CLASS-B 3m FCC-3M-FACTOR HORIZONTAL
 EUT : FSC B15-1 Serial No:TY03020104
 Power : 120-240VAC
 Memo : 1. EMI EVALUATION FOR FCC SAMPLE.
 : 2. 2ND MODEL CPT PANEL,RUN FSC "H"
 : PATTERN.
 : 3. 1024x768/75Hz 60KHz MODE WITH FSC
 : MT8-D137 PC,VIDEO CARD ONBOARD,
 : AUDIO WITH HEADPHONE WAS TESTED.

Frequency	Peak	Reading	QP reading	Limit	Factor	Emission Level	Over Limit	Remark
MHz	dBuV	dBuV	dBuV/m	dB/m		dBuV/m	dBuV/m	
57.290	19.00	---	40.00	10.14		29.14	-10.86	Peak
71.000	18.20	---	40.00	10.04		28.24	-11.76	Peak
114.580	16.70	---	43.50	12.14		28.84	-14.66	Peak
141.620	20.30	---	43.50	13.13		33.43	-10.07	Peak
157.540	19.80	---	43.50	13.63		33.43	-10.07	Peak
173.290	19.50	---	43.50	14.05		33.55	-9.95	Peak
181.170	19.90	---	43.50	14.53		34.43	-9.07	Peak
252.050	17.30	---	46.00	20.60		37.90	-8.10	Peak
259.930	18.70	---	46.00	21.07		39.77	-6.23	Peak
300.730	14.40	---	46.00	23.20		37.60	-8.40	Peak
330.810	14.80	---	46.00	17.13		31.93	-14.07	Peak
370.200	15.40	---	46.00	17.88		33.28	-12.72	Peak

Remarks: 1. All Readings are Peak & Quasi-peak values.
 2. Emission Level (dBuV/m) = Factor (dB/m) + Meter Reading (dBuV/m)
 3. Factor (dB/m) = Antenna Factor (dB/m) + Cable Loss (dB)



PHILIPS

Philips Electronics Industries (Taiwan)., Ltd.
 No.5, Tze Chiang 1 Road, Chungli Industrial Park,
 Chungli, Taiwan, R.O.C.
 Tel:+886-3-4549862 Fax:+886-3-4549887

Frequency	Peak Reading	QP reading	Limit	Factor	Emission Level	Over Limit	Remark
MHz	dBuV	dBuV	dBuV/m	dB/m	HORIZONTAL		
					dBuV/m	dBuV/m	
411.740	13.90	---	46.00	18.57	32.47	-13.53	Peak
472.600	15.20	---	46.00	19.37	34.57	-11.43	Peak
483.340	14.10	---	46.00	19.51	33.61	-12.39	Peak
490.500	13.70	---	46.00	19.60	33.30	-12.70	Peak
504.830	13.50	---	46.00	19.79	33.29	-12.71	Peak
519.160	13.20	---	46.00	20.02	33.22	-12.78	Peak
526.310	14.10	---	46.00	20.13	34.23	-11.77	Peak
540.640	13.40	---	46.00	20.36	33.76	-12.24	Peak
547.800	13.70	---	46.00	20.45	34.15	-11.85	Peak
554.960	14.30	---	46.00	20.57	34.87	-11.13	Peak
562.120	14.10	---	46.00	20.68	34.78	-11.22	Peak
569.290	13.50	---	46.00	20.77	34.27	-11.73	Peak
576.440	14.30	---	46.00	20.88	35.18	-10.82	Peak
583.600	14.60	---	46.00	20.97	35.57	-10.43	Peak
597.920	13.60	---	46.00	21.17	34.77	-11.23	Peak
605.080	14.00	---	46.00	21.36	35.36	-10.64	Peak
612.240	13.30	---	46.00	21.51	34.81	-11.19	Peak
619.400	13.90	---	46.00	21.67	35.57	-10.43	Peak
633.720	14.70	---	46.00	22.04	36.74	-9.26	Peak
669.520	13.60	---	46.00	22.87	36.47	-9.53	Peak
683.840	13.50	---	46.00	23.19	36.69	-9.31	Peak
691.000	14.40	---	46.00	23.34	37.74	-8.26	Peak
705.320	14.20	---	46.00	23.57	37.77	-8.23	Peak
712.490	13.20	---	46.00	23.67	36.87	-9.13	Peak
719.650	13.70	---	46.00	23.77	37.47	-8.53	Peak
733.970	13.30	---	46.00	23.98	37.28	-8.72	Peak

- Remarks: 1. All Readings are Peak & Quasi-peak values.
 2. Emission Level (dBuV/m) = Factor (dB/m) + Meter Reading (dBuV/m)
 3. Factor (dB/m) = Antenna Factor (dB/m) + Cable Loss (dB)

Tested by : C C.Wu



PHILIPS

Philips Electronics Industries (Taiwan)., Ltd.
 No.5, Tze Chiang 1 Road, Chungli Industrial Park,
 Chungli, Taiwan, R.O.C.
 Tel:+886-3-4549862 Fax:+886-3-4549887

Data#: 2

File#: C:\Program Files\em3\EMI03-012-R.emi

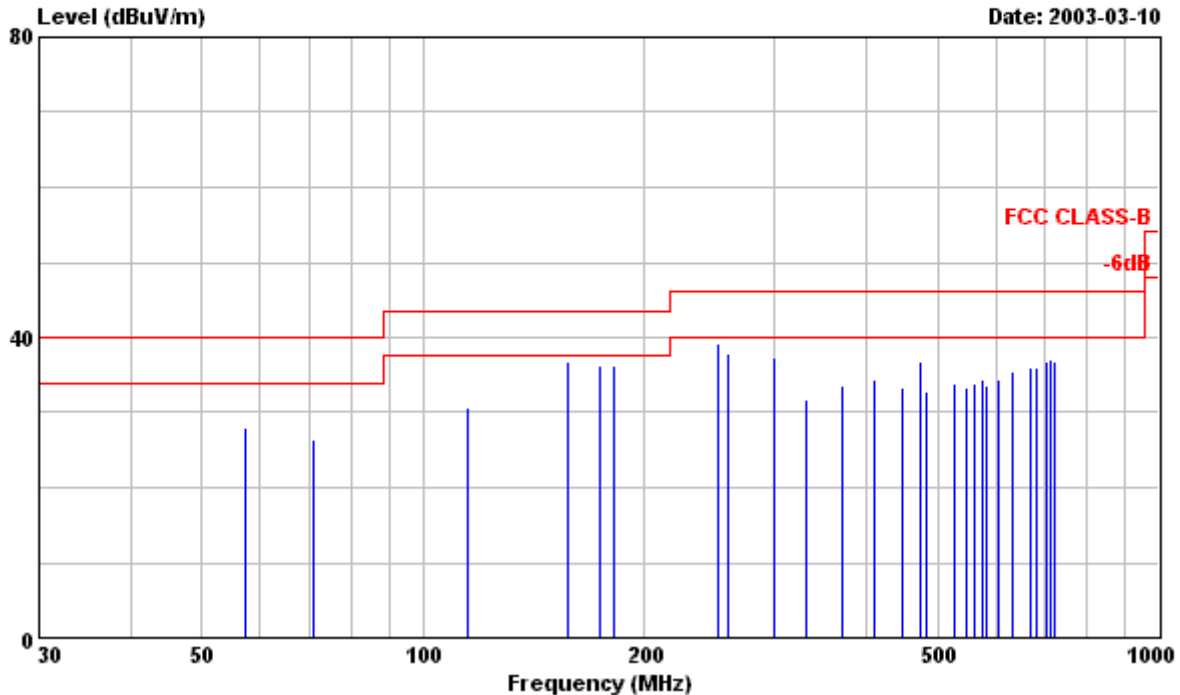

Site : PHILIPS EMI 3M open site
 Condition : FCC CLASS-B 3m FCC-3M-FACTOR VERTICAL
 EUT : FSC B15-1 Serial No:TY03020104
 Power : 120-240VAC
 Memo : 1. EMI EVALUATION FOR FCC SAMPLE.
 : 2. 2ND MODEL CPT PANEL,RUN FSC "H"
 : PATTERN.
 : 3. 1024x768/75Hz 60KHz MODE WITH FSC
 : MT8-D137 PC,VIDEO CARD ONBOARD,
 : AUDIO WITH HEADPHONE WAS TESTED.

Frequency	Peak	Reading	QP reading	Limit	Factor	Emission Level	Over Limit	Remark
MHz	dBuV	dBuV	dBuV/m	dB/m		VERTICAL dBuV/m	dBuV/m	
57.290	17.80	---	40.00	10.14		27.94	-12.06	Peak
71.000	16.30	---	40.00	10.04		26.34	-13.66	Peak
114.580	18.50	---	43.50	12.14		30.64	-12.86	Peak
157.540	23.30	---	43.50	13.63		36.93	-6.57	Peak
173.290	22.10	---	43.50	14.05		36.15	-7.35	Peak
181.170	21.80	---	43.50	14.53		36.33	-7.17	Peak
252.050	18.50	---	46.00	20.60		39.10	-6.90	Peak
259.930	16.90	---	46.00	21.07		37.97	-8.03	Peak
300.730	14.20	---	46.00	23.20		37.40	-8.60	Peak
330.810	14.50	---	46.00	17.13		31.63	-14.37	Peak
370.200	15.70	---	46.00	17.88		33.58	-12.42	Peak
409.570	15.90	---	46.00	18.52		34.42	-11.58	Peak

Remarks: 1. All Readings are Peak & Quasi-peak values.
 2. Emission Level (dBuV/m) = Factor (dB/m) + Meter Reading (dBuV/m)
 3. Factor (dB/m) = Antenna Factor (dB/m) + Cable Loss (dB)



PHILIPS

Philips Electronics Industries (Taiwan) ., Ltd.
 No.5, Tze Chiang 1 Road, Chungli Industrial Park,
 Chungli, Taiwan, R.O.C.
 Tel:+886-3-4549862 Fax:+886-3-4549887

Frequency MHz	Peak Reading dBuV	QP reading dBuV	Limit dBuV/m	Factor dB/m	Emission Level		Over Limit dBuV/m	Remark
					VERTICAL dBuV/m			
448.960	14.20	---	46.00	19.08	33.28		-12.72	Peak
472.600	17.30	---	46.00	19.37	36.67		-9.33	Peak
483.340	13.40	---	46.00	19.51	32.91		-13.09	Peak
526.310	13.70	---	46.00	20.13	33.83		-12.17	Peak
547.800	12.90	---	46.00	20.45	33.35		-12.65	Peak
562.120	13.20	---	46.00	20.68	33.88		-12.12	Peak
576.450	13.50	---	46.00	20.88	34.38		-11.62	Peak
583.600	12.70	---	46.00	20.97	33.67		-12.33	Peak
605.080	13.10	---	46.00	21.36	34.46		-11.54	Peak
633.720	13.30	---	46.00	22.04	35.34		-10.66	Peak
669.520	13.10	---	46.00	22.87	35.97		-10.03	Peak
683.840	12.80	---	46.00	23.19	35.99		-10.01	Peak
705.320	13.20	---	46.00	23.57	36.77		-9.23	Peak
712.490	13.40	---	46.00	23.67	37.07		-8.93	Peak
719.650	12.90	---	46.00	23.77	36.67		-9.33	Peak

- Remarks: 1. All Readings are Peak & Quasi-peak values.
 2. Emission Level (dBuV/m) = Factor (dB/m) + Meter Reading (dBuV/m)
 3. Factor (dB/m) = Antenna Factor (dB/m) + Cable Loss (dB)

Tested by : C C.Wu



PHILIPS

Philips Electronics Industries (Taiwan)., Ltd.
 No.5, Tze Chiang 1 Road, Chungli Industrial Park,
 Chungli, Taiwan, R.O.C.
 Tel:+886-3-4549862 Fax:+886-3-4549887

Data#: 3

File#: C:\Program Files\e3\EMI03-012-R.emi

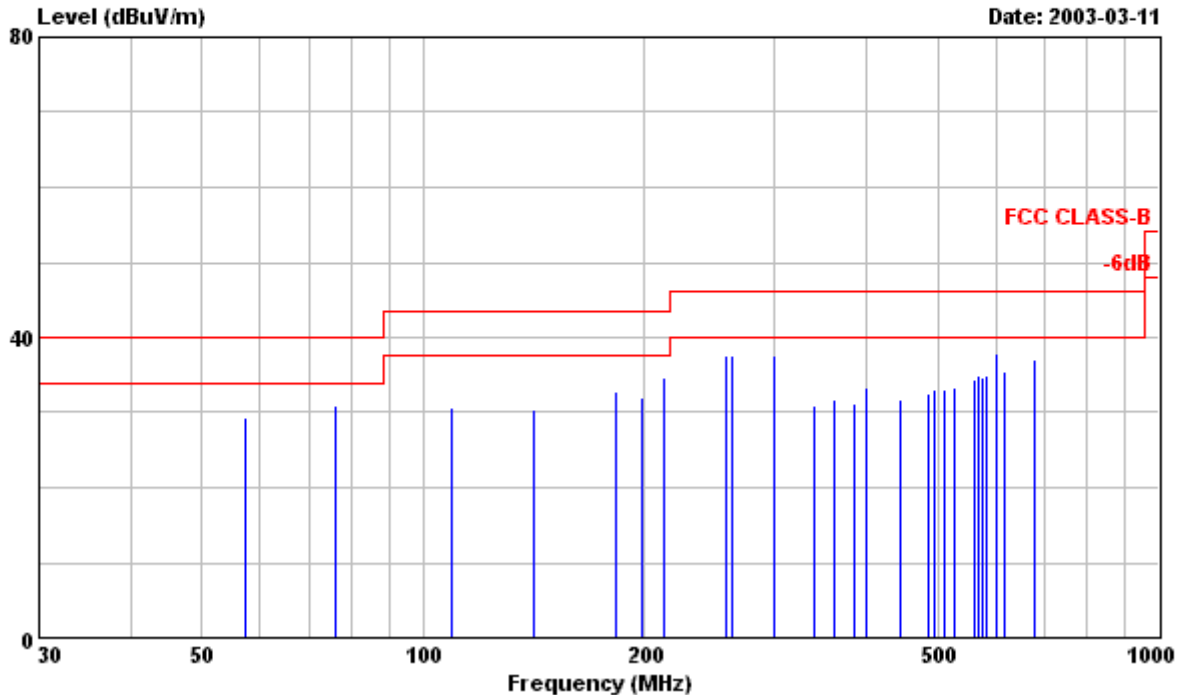

Site : PHILIPS EMI 3M open site
 Condition : FCC CLASS-B 3m FCC-3M-FACTOR HORIZONTAL
 EUT : FSC B15-1 Serial No:TY03020104
 Power : 120-240VAC
 Memo : 1. EMI EVALUATION FOR FCC SAMPLE.
 : 2. 2ND MODEL CPT PANEL,RUN FSC "H"
 : PATTERN.
 : 3. 800x600/75Hz 46.9KHz MODE WITH FSC
 : MT8-D137 PC,VIDEO CARD ONBOARD,
 : AUDIO WITH HEADPHONE WAS TESTED.

Frequency	Peak Reading	QP reading	Limit	Factor	Emission Level	Over Limit	Remark
MHz	dBuV	dBuV	dBuV/m	dB/m	dBuV/m	dBuV/m	
57.290	19.20	---	40.00	10.14	29.34	-10.66	Peak
75.950	20.70	---	40.00	10.24	30.94	-9.06	Peak
108.940	18.80	---	43.50	11.87	30.67	-12.83	Peak
141.520	17.40	---	43.50	13.11	30.51	-12.99	Peak
183.190	18.20	---	43.50	14.72	32.92	-10.58	Peak
198.040	16.00	---	43.50	16.11	32.11	-11.39	Peak
212.670	17.20	---	43.50	17.48	34.68	-8.82	Peak
257.460	16.80	---	46.00	20.92	37.72	-8.28	Peak
262.410	16.50	---	46.00	21.17	37.67	-8.33	Peak
300.730	14.40	---	46.00	23.20	37.60	-8.40	Peak
340.150	13.70	---	46.00	17.30	31.00	-15.00	Peak
361.430	14.00	---	46.00	17.72	31.72	-14.28	Peak

Remarks: 1. All Readings are Peak & Quasi-peak values.
 2. Emission Level (dBuV/m) = Factor (dB/m) + Meter Reading (dBuV/m)
 3. Factor (dB/m) = Antenna Factor (dB/m) + Cable Loss (dB)



PHILIPS

Philips Electronics Industries (Taiwan) ., Ltd.
 No.5, Tze Chiang 1 Road, Chungli Industrial Park,
 Chungli, Taiwan, R.O.C.
 Tel:+886-3-4549862 Fax:+886-3-4549887

Frequency MHz	Peak Reading dBuV	QP reading dBuV	Limit dBuV/m	Factor dB/m	Emission Level Over Limit		Remark
					HORIZONTAL dBuV/m	dBuV/m	
386.180	13.10	---	46.00	18.17	31.27	-14.73	Peak
401.000	14.80	---	46.00	18.40	33.20	-12.80	Peak
445.590	12.60	---	46.00	19.02	31.62	-14.38	Peak
485.190	13.00	---	46.00	19.53	32.53	-13.47	Peak
495.100	13.30	---	46.00	19.66	32.96	-13.04	Peak
509.940	13.20	---	46.00	19.87	33.07	-12.93	Peak
526.320	13.20	---	46.00	20.13	33.33	-12.67	Peak
562.120	13.70	---	46.00	20.68	34.38	-11.62	Peak
569.280	14.10	---	46.00	20.77	34.87	-11.13	Peak
576.440	13.70	---	46.00	20.88	34.58	-11.42	Peak
583.600	14.00	---	46.00	20.97	34.97	-11.03	Peak
601.510	16.50	---	46.00	21.25	37.75	-8.25	Peak
615.820	13.80	---	46.00	21.62	35.42	-10.58	Peak
676.690	14.00	---	46.00	23.03	37.03	-8.97	Peak

- Remarks:
1. All Readings are Peak & Quasi-peak values.
 2. Emission Level (dBuV/m) = Factor (dB/m) + Meter Reading (dBuV/m)
 3. Factor (dB/m) = Antenna Factor (dB/m) + Cable Loss (dB)

Tested by : C C.Wu



PHILIPS

Philips Electronics Industries (Taiwan)., Ltd.
 No.5, Tze Chiang 1 Road, Chungli Industrial Park,
 Chungli, Taiwan, R.O.C.
 Tel:+886-3-4549862 Fax:+886-3-4549887

Data#: 4

File#: C:\Program Files\e3\EMI03-012-R.emi

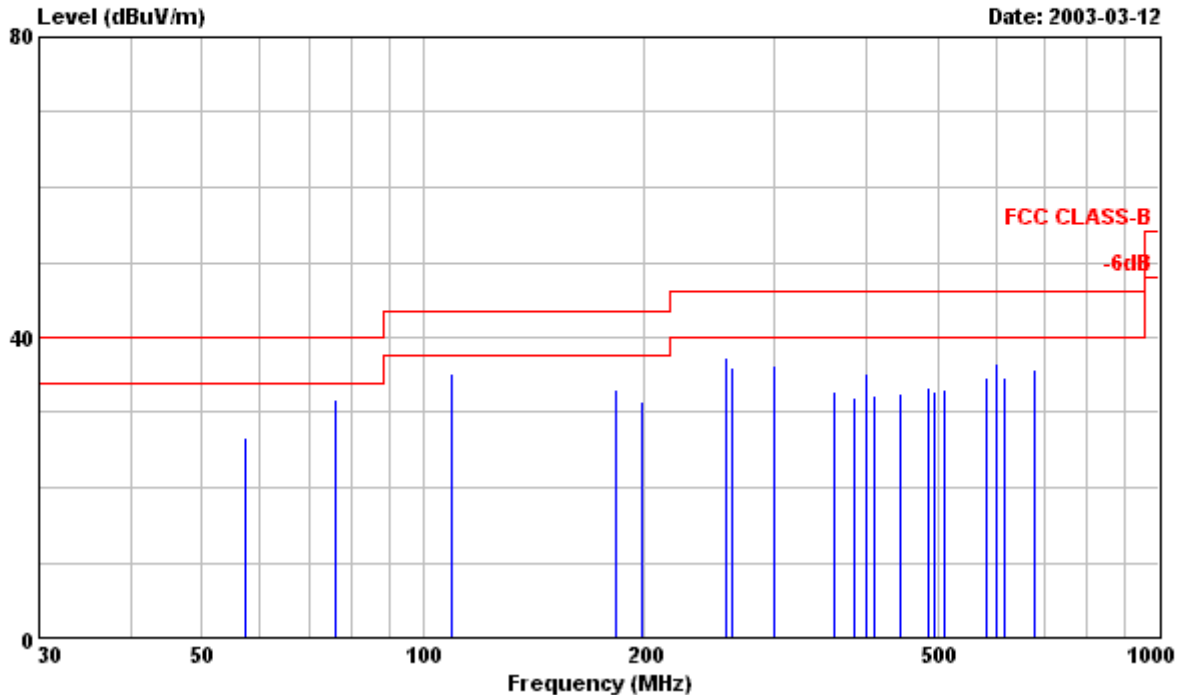

Site : PHILIPS EMI 3M open site
 Condition : FCC CLASS-B 3m FCC-3M-FACTOR VERTICAL
 EUT : FSC B15-1 Serial No:TY03020104
 Power : 120-240VAC
 Memo : 1. EMI EVALUATION FOR FCC SAMPLE.
 : 2. 2ND MODEL CPT PANEL,RUN FSC "H"
 : PATTERN.
 : 3. 800x600/75Hz 46.9KHz MODE WITH FSC
 : MT8-D137 PC,VIDEO CARD ONBOARD,
 : AUDIO WITH HEADPHONE WAS TESTED.

Frequency	Peak	Reading	QP reading	Limit	Factor	Emission Level	Over Limit	Remark
MHz	dBuV	dBuV	dBuV/m	dB/m		VERTICAL dBuV/m	dBuV/m	
57.290	16.60	---	40.00	10.14		26.74	-13.26	Peak
75.950	21.40	---	40.00	10.24		31.64	-8.36	Peak
108.940	23.20	---	43.50	11.87		35.07	-8.43	Peak
183.190	18.40	---	43.50	14.72		33.12	-10.38	Peak
198.040	15.40	---	43.50	16.11		31.51	-11.99	Peak
257.460	16.30	---	46.00	20.92		37.22	-8.78	Peak
262.410	14.91	---	46.00	21.17		36.08	-9.92	Peak
300.730	13.10	---	46.00	23.20		36.30	-9.70	Peak
361.430	15.20	---	46.00	17.72		32.92	-13.08	Peak
386.180	13.90	---	46.00	18.17		32.07	-13.93	Peak
401.000	16.80	---	46.00	18.40		35.20	-10.80	Peak
410.940	13.80	---	46.00	18.54		32.34	-13.66	Peak

Remarks: 1. All Readings are Peak & Quasi-peak values.
 2. Emission Level (dBuV/m) = Factor (dB/m) + Meter Reading (dBuV/m)
 3. Factor (dB/m) = Antenna Factor (dB/m) + Cable Loss (dB)



PHILIPS

Philips Electronics Industries (Taiwan) ., Ltd.
 No.5, Tze Chiang 1 Road, Chungli Industrial Park,
 Chungli, Taiwan, R.O.C.
 Tel:+886-3-4549862 Fax:+886-3-4549887

Frequency MHz	Peak Reading dBuV	QP reading dBuV	Limit dBuV/m	Factor dB/m	Emission Level		Over Limit dBuV/m	Remark
					VERTICAL dBuV/m			
445.590	13.50	---	46.00	19.02	32.52		-13.48	Peak
485.190	13.90	---	46.00	19.53	33.43		-12.57	Peak
495.100	13.10	---	46.00	19.66	32.76		-13.24	Peak
509.940	13.20	---	46.00	19.87	33.07		-12.93	Peak
584.210	13.80	---	46.00	21.00	34.80		-11.20	Peak
601.510	15.30	---	46.00	21.25	36.55		-9.45	Peak
615.820	13.10	---	46.00	21.62	34.72		-11.28	Peak
676.690	12.80	---	46.00	23.03	35.83		-10.17	Peak

- Remarks: 1. All Readings are Peak & Quasi-peak values.
 2. Emission Level (dBuV/m) = Factor (dB/m) + Meter Reading (dBuV/m)
 3. Factor (dB/m) = Antenna Factor (dB/m) + Cable Loss (dB)

Tested by : C C.Wu